



TEST REPORT

Product Name : Wireless 11g MiniPCI Card
Model Number : MS-6855A
Brand Name : MSI
Marketing Name : MP54G3
FCC ID : I4L-MS6855A

Applicant : MICRO-STAR INT' LCO., LTD.
Address : No. 69, Li-De St, Jung-He City,
Taipei Hsien 235, Taiwan

Received Date : September 08, 2004
Tested Date : June 08 ~ 14 ; September 08 ~ 20, 2004

Notes :

1. This report will be invalid if duplicated or photocopied in part.
2. This report refers only to the specimen(s) submitted to testing, and be invalid as seperately used.
3. This report is invalid without examination stamp and signature of this institute.
4. The tested specimen(s) will be preserved for thirty days from the data issued.
5. The report must not be used to claim product certification, approval, or endorsement by NVLAP, NIST, or any agency of the federal government.
6. **This report is modified from ER04-06-025.**





Ecom Sertech Corp.

Rm. 258, Bldg. 17, NO.195, Sec. 4 Chung Hsing Rd., ChuTung Chen, Hsinchu, Taiwan 310, R.O.C
TEL:886-3-5918012 FAX: 886-3-5825720

FCC ID : I4L-MS6855A

Report No. : ER04-09-021FRF

Page 2 of 56

Test Report Certification

Product Name : Wireless 11g MiniPCI Card
Model Number : MS-6855A
Brand Name : MSI
Marketing Name : MP54G3
FCC ID : I4L-MS6855A
Applicant : MICRO-STAR INT' LCO., LTD.

Measurement Standard :

FCC 47 C.F.R. Part 15, Subpart B and Subpart C (2003)
 ANSI C63.4 (2001)

Tested By : Stan Peng, Date: September 29, 2004
 (Stan Peng)

Approved By : Chieh-De Tsai, Date: September 29, 2004
 (Chieh-De Tsai, Manager)



WE HEREBY CERTIFY THAT: The measurements shown in the attachment were made in accordance with the procedures indicated, and the energy emitted by the equipment was found to be within the limits applicable. We assume full responsibility for the accuracy and completeness of these measurements and vouch for the qualifications of all persons taking them.



TABLE OF CONTENTS

TITLE	PAGE NO.
1. GENERAL INFORMATION	5
1.1 General Statement	5
1.2 General Description of EUT & Power	5
1.3 Description of Peripherals.....	6
1.4 EUT & Peripherals Setup Diagram.....	6
1.5 EUT Operating Procedure.....	7
1.6 Description of Laboratory	7
1.7 Summary of Test Results	8
2. CONDUCTED POWERLINE TEST.....	9
2.1 Test Equipments.....	9
2.2 Test Setup.....	9
2.3 Conducted Power Line Emission Limit.....	10
2.4 Test Procedure.....	10
2.5 Uncertainty of Conducted Emission	10
2.6 Conducted RF Voltage Measurement	11-12
2.7 Photos of Conduction Test.....	13
3. RADIATED EMISSION TEST	14
3.1 Test Equipments.....	14
3.2 Test Setup.....	14
3.3 Radiation Limit	15
3.4 Test Procedures	16
3.5 Uncertainty of Radiated Emission	16
3.6 Radiated RF Noise Measurement.....	17-35
3.7 Photos of Open Site.....	36-37
4. 6dB BANDWIDTH MEASUREMENT	38
4.1 Test Equipments.....	38
4.2 Test Setup.....	38
4.3 Limits of 6dB Bandwidth Measurement	38
4.4 Test Procedure.....	38
4.5 Uncertainty of Conducted Emission	38
4.6 Test Results	39
4.7 Photo of 6db Bandwidth Measurement.....	40-41



TABLE OF CONTENTS

TITLE	PAGE NO.
5. MAXIMUM PEAK OUTPUT POWER	42
5.1 Test Equipments.....	42
5.2 Test Setup.....	42
5.3 Limits of Maximum Peak Output Power	42
5.4 Test Procedure.....	43
5.5 Uncertainty of Conducted Emission	43
5.6 Test Results	43
6. POWER SPECTRAL DENSITY MEASUREMENT	44
6.1 Test Equipments.....	44
6.2 Test Setup.....	44
6.3 Limits of Power Spectral Density Measurement.....	44
6.4 Test Procedure.....	45
6.5 Uncertainty of Conducted Emission	45
6.6 Test Results	45
6.7 Photo of Power Spectral Density Measurement.....	46-47
7. BAND EDGE MEASUREMENT	48
7.1 Test Equipments.....	48
7.2 Test Setup.....	48
7.3 Limits of Band Edge Emissions Measurement	48
7.4 Test Procedure.....	48
7.5 Uncertainty of Conducted Emission	48
7.6 Test Results	49
7.7 Photo of Band edge Measurement	50-53
8. ANTENNA REQUIREMENT	54
8.1 Standard Applicable.....	54
8.2 Antenna Connected Construction	54
9. RF EXPOSURE EVALUATION	55
9.1 Friis Formula.....	55
9.2 EUT Operating Condition.....	55
9.3 Test Result of RF Exposure Evaluation.....	56
9.3.1 Antenna Gain	56
9.3.2 Output Power into Antenna & RF Exposure Evaluation Distance	56



Ecom Sertech Corp.

Rm. 258, Bldg. 17, NO.195, Sec. 4 Chung Hsing Rd., ChuTung Chen, Hsinchu, Taiwan 310, R.O.C
TEL:886-3-5918012 FAX: 886-3-5825720

FCC ID : I4L-MS6855A

Report No. : ER04-09-021FRF

Page 5 of 56

1. GENERAL INFORMATION

1.1 General Statement

MEASUREMENT DEVIATION : Comply with standard in full

TRACEABILITY : This test result is traceable to National or International std.

1.2 General Description of EUT & Power

Product Name	Wireless 11g MiniPCI Card
Model Number	MS-6855A
Frequency Range	2400MHz to 2483.5MHz
Frequency Channel	2412MHz + 5×n (MHz), n=0, 1, 2,.....10
Channel Number	11
Channel Spacing	5MHz
Air Data Rate	54Mbps (802.11g Mode), 11Mbps(802.11b Mode)
Type of Modulation	802.11b : DSSS(CCK, DQPSK, DBPSK) 802.11g : OFDM(64QAM, 16AQM, QPSK, BPSK)
Frequency Selection	by software / firmware
Transmitter Classification	mobile device
EUT Description	2.4GHz (Direct Sequence Spread Spectrum and Orthogonal Frequency Division Multiplex) Data Transceiver for WLAN application
Antenna Type	Dipole Antenna Antenna (1) : Draytek 3dBi, the internal connector is Hirose and the external connector is reverse SMA. Antenna (2) : Fiberlogic 5dBi, the internal connector is Hirose and the external connector is reverse SMA.
Power Source	3.3VDC (From Notebook)

1.3 Description of Peripherals

(1) Notebook PC

MANUFACTURER : COMPAQ CORP.
MODEL NUMBER : N800V
SERIAL NUMBER : 5Y33KSQZMOYL
FCC ID : DOC
POWER CORD : Unshielded, Detachable, 1.8m

Adapter

MANUFACTURER : COMPAQ CORP.
MODEL NUMBER : PPP009L
INPUT POWER : 100-240V, 50/60Hz, 1.7A
OUTPUT POWER : 18.5VDC, 65W, 3.5A

(2) Printer

MANUFACTURER : HP CORP.
MODEL NUMBER : C8952D
SERIAL NUMBER : CN29B181H7
INPUT POWER : 100-240VAC, 50/60Hz, 0.7A
SIGNAL CABLE : Shielded, Undetachable, 1.8m

1.4 EUT & Peripherals Setup Diagram

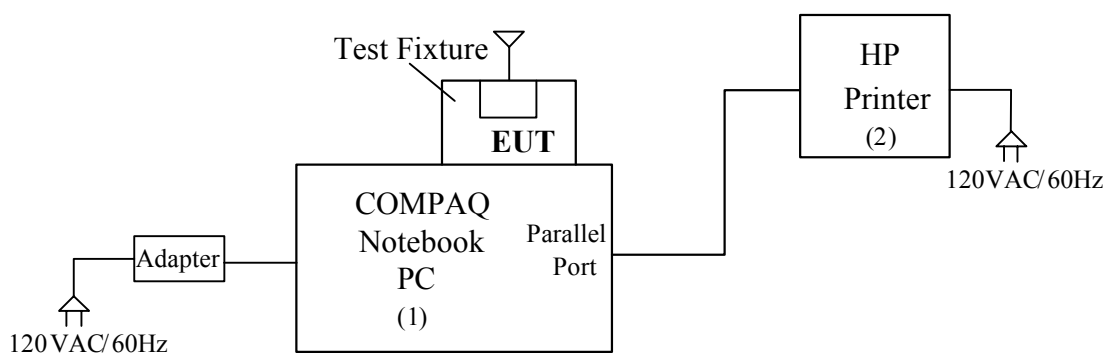

The indicated numbers (1)(2)(3), please refer to item 1.3



Ecom Sertech Corp.

Rm. 258, Bldg. 17, NO.195, Sec. 4 Chung Hsing Rd., ChuTung Chen, Hsinchu, Taiwan 310, R.O.C
TEL:886-3-5918012 FAX: 886-3-5825720

FCC ID : I4L-MS6855A
Report No. : ER04-09-021FRF
Page 7 of 56

1.5 EUT Operating Procedure

(1) Run InProcomm RF test utility 2.2.

(2) Select Channel 1, 6, 11, Default.

Tx filter : North Amertca.

Rx Antenna : A

Tx Rate :

6M for 802.11g.

11M for 802.11b.

(3) Start test :

Tx mode : Select Tx Output Power.

Rx mode : Select Continuous Packet Rx.

1.6 Description of Laboratory

SITE DESCRIPTION

FCC Certificate NO. : 90585
BSMI Certificate NO. : SL2-IN-E-0002
NVLAP Lab Code : 200118-0
CNLA Certificate NO. : CNLA-ZL97018
VCCI Certificate NO. : R-1189, C-1250
TÜV Rheinland Certificate NO. : 10008375

NAME OF SITE : Ecom Sertech Corp. Hsin-Chu Lab.
(Spin-off from ITRI / ERSO on Apr. 01, 2003)

SITE LOCATION : Rm.258, Bldg.17, NO.195 , Sec. 4, Chung Hsing Rd.,
Chu-Tung Chen. Hsin-Chu, Taiwan 310 R.O.C.



Ecom Sertech Corp.

Rm. 258, Bldg. 17, NO.195, Sec. 4 Chung Hsing Rd., ChuTung Chen, Hsinchu, Taiwan 310, R.O.C
TEL:886-3-5918012 FAX: 886-3-5825720

FCC ID : I4L-MS6855A

Report No. : ER04-09-021FRF

Page 8 of 56

1.7 Summary of Test Results

The EUT has been tested according to the following specifications :

APPLIED STANDARD : FCC 47 C.F.R. Part 15, Subpart B and Subpart C

Standard Section	Test Item and Limit	Result	REMARK
15.107 15.207	AC Power Conducted Emission Limit : 15.107	PASS	Meet the requirement of limit
15.247(a)(2)	Spectrum Bandwidth of a Orthogonal Frequency Division Multiplex System Limit : 6dB bandwidth > 500KHz	PASS	Meet the requirement of limit
15.247(b)	Maximum Peak Output Power Limit : max. 30dBm	PASS	Meet the requirement of limit
15.109 15.205 15.209	Transmitter Radiated Emissions Limit : Table 15.209	PASS	Meet the requirement of limit
15.247(d)	Power Spectral Density Limit : max. 8dBm	PASS	Meet the requirement of limit
15.247(c)	Out of Band Emission and Restricted Band Radiation Limit:20dB less than peak value of fundamental frequency Restricted band Limit:Table 15.209	PASS	Meet the requirement of limit



2. CONDUCTED POWERLINE TEST

2.1 Test Equipments

The following test equipments are used during the conducted powerline tests :

Manufacturer or Type	Model No.	Serial No.	Date of Calibration	Calibration Period	Remark
HP SPECTRUM ANALYZER & DISPLAY	8568A	2235A02320	November 14, 2003	1 Year	PRETEST
HP QUASI-PEAK ADAPTER	85650 A	2341A00672	November 14, 2003	1 Year	PRETEST
SOLAR ISOLATION TRANSFORMER	7032-1	N/A	N/A	N/A	FINAL
EMCO L.I.S.N.	3850/2	9311-1025 9401-1028	January 08, 2004 For Characteristic impedance	1 Year	FINAL
			May 18, 2004 For Insertion loss		
R & S TEST RECEIVER	ESHS 30	838550/003	February 11, 2004	1 Year	FINAL
KEENE SHIELDED ROOM	5983	No.1	N/A	N/A	FINAL
R & S PULSE LIMIT	EHS3Z2	357.8810.52	July 10, 2003	1 Year	FINAL
N TYPE COAXIAL CABLE	-----	-----	July 10, 2003	1 Year	FINAL
50Ω TERMINATOR	-----	-----	July 10, 2003	1 Year	FINAL

2.2 Test Setup

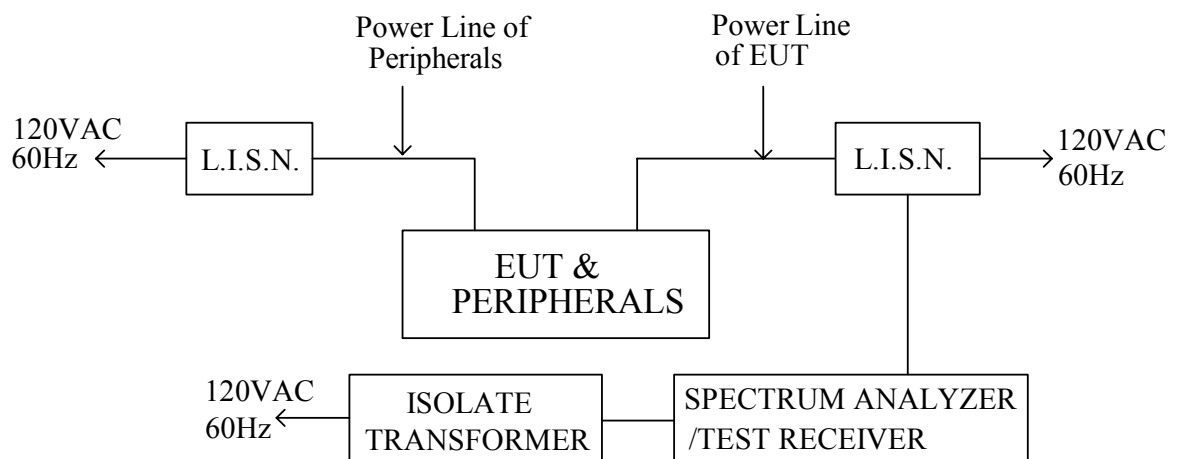



2.3 Conducted Power Line Emission Limit

For unintentional device, according to § 15.107(a) Line Conducted Emission Limits is as following :

Frequency (MHz)	Maximum RF Line Voltage (dB μ v)			
	CLASS A		CLASS B	
	Q.P.	Ave.	Q.P.	Ave.
0.15 - 0.50	79	66	66-56	56-46
0.50 - 5.00	73	60	56	46
5.00 - 30.0	73	60	60	50

For intentional device, according to § 15.207(a) Line Conducted Emission Limit is same as above table.

2.4 Test Procedure

The test procedure is performed in a 12ft×12ft×8ft(L×W×H) shielded room.

The EUT along with its peripherals were placed on a 1.0m(W)× 1.5m(L) and 0.8m in height wooden table and the EUT was adjusted to maintain a 0.4 meter space from a vertical reference plane. The EUT was connected to power mains through a line impedance stabilization network (LISN) which provides 50 ohm coupling impedance for measuring instrument and the chasis ground was bounded to the horizontal ground plane of shielded room. All peripherals were connected to the second LISN and the chasis ground also bounded to the horizontal ground plane of shielded room. The excess power cable between the EUT and the LISN was bundled. The power cables of peripherals were unbundled. All connecting cables of EUT and peripherals were moved to find the maximum emission.

2.5 Uncertainty of Conducted Emission

The uncertainty of conducted emission is ± 1.36 dB.



2.6 Conducted RF Voltage Measurement

The frequency spectrum from 0.15 MHz to 30 MHz was investigated. All emissions not reported are much lower than the prescribed limits.

Company	MICRO-STAR INT' LCO., LTD.	Test Date	2004/06/9
Product Name	Wireless 11g MiniPCI Card	Test By	Stan Peng
Model Name	MS-6855A	TEMP & Humidity	25°C, 60%

LINE

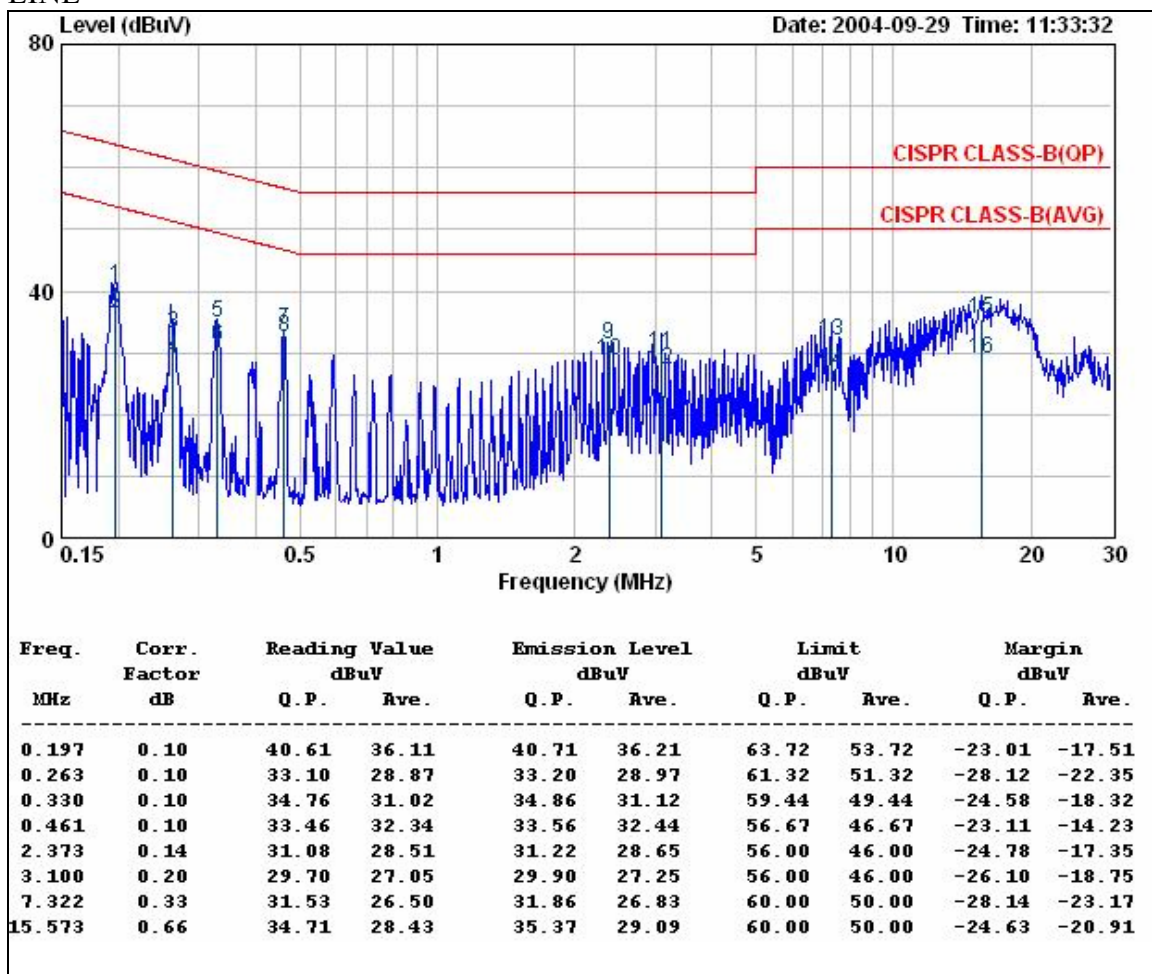

REMARKS :

1. Correction Factor = Insertion loss + cable loss
2. Margin value = Emission level – Limit value
3. The EUT can be operated in transmitting, stand-by and receiving mode. After preliminary scan, EUT in transmitting mode has highest emission. The EUT was set in transmitting mode at final test to get the worst case test results.
4. The RF-Chip combined with 802.11b&g mode. It will auto-detect the situation then switch the mode. The 802.11g mode is the worse case than the 802.11b mode. So only the 802.11g mode data are recorded in final test report.
5. For Antenna (2).
6. After an exploratory test, the emission of antenna (2) is higher than the emission of antenna (1). So only the antenna (2) data are recorded in final test report.



Ecom Sertech Corp.

Rm. 258, Bldg. 17, NO.195, Sec. 4 Chung Hsing Rd., ChuTung Chen, Hsinchu, Taiwan 310, R.O.C
 TEL:886-3-5918012 FAX : 886-3-5825720

FCC ID : I4L-MS6855A

Report No. : ER04-09-021FRF

Page 12 of 56

The frequency spectrum from 0.15 MHz to 30 MHz was investigated. All emissions not reported are much lower than the prescribed limits.

Company	MICRO-STAR INT'L CO., LTD.	Test Date	2004/06/9
Product Name	Wireless 11g MiniPCI Card	Test By	Stan Peng
Model Name	MS-6855A	TEMP & Humidity	25°C, 60%

NEUTRAL

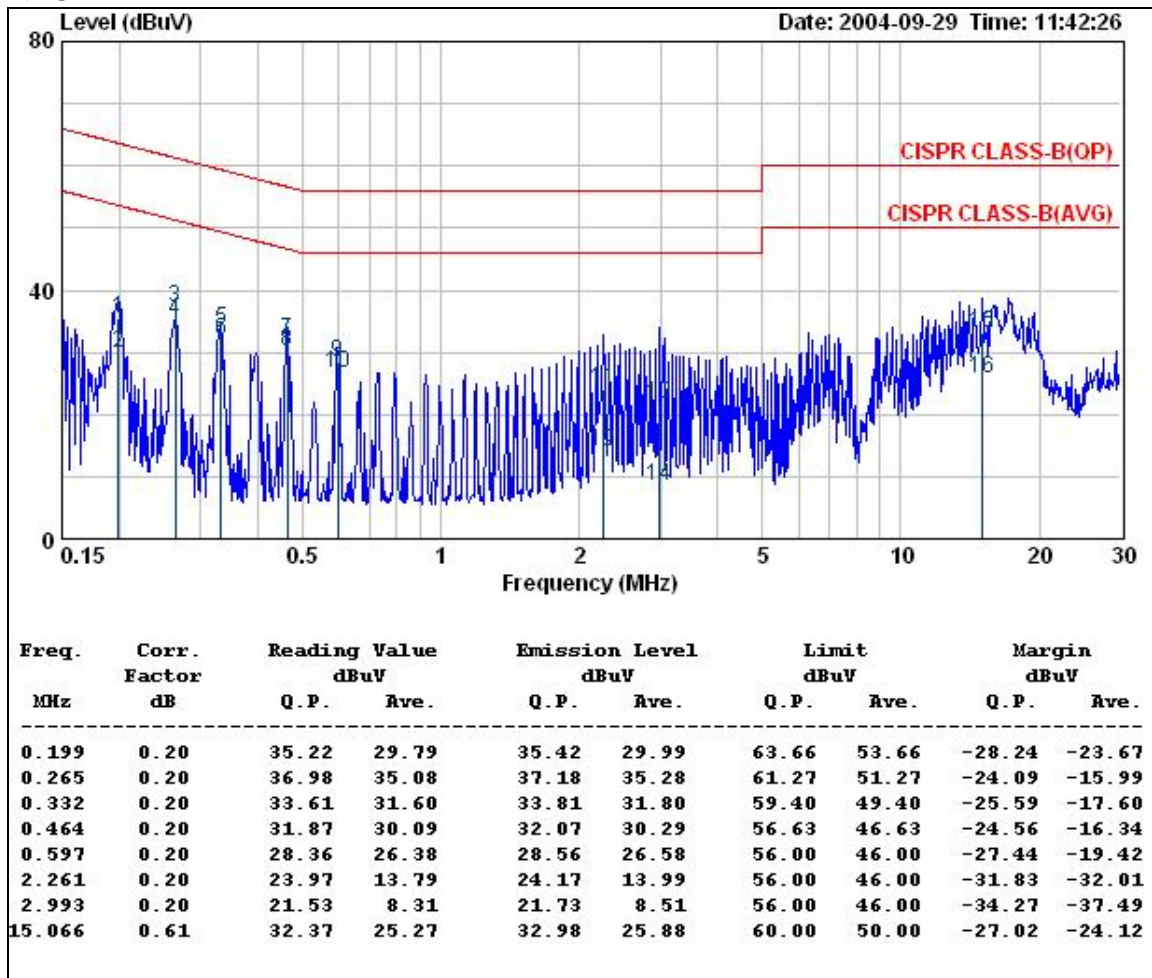

REMARKS :

1. Correction Factor = Insertion loss + cable loss
2. Margin value = Emission level – Limit value
3. The EUT can be operated in transmitting, stand-by and receiving mode. After preliminary scan, EUT in transmitting mode has highest emission. The EUT was set in transmitting mode at final test to get the worst case test results.
4. The RF-Chip combined with 802.11b&g mode. It will auto-detect the situation then switch the mode. The 802.11g mode is the worse case than the 802.11b mode. So only the 802.11g mode data are recorded in final test report.
5. For Antenna (2).
6. After an exploratory test, the emission of antenna (2) is higher than the emission of antenna (1). So only the antenna (2) data are recorded in final test report.

2.7 Photos of Conduction Test



3. RADIATED EMISSION TEST

3.1 Test Equipments

The following test equipments are utilized in making the measurements contained in this report.

Manufacturer or Type	Model No	Serial No	Date of Calibration	Calibration Period	Remark
CHASE BI-LOG ANTENNA	CBL6112B	2421	May 07, 2004	1 Year	FINAL
R/S SPECTRUM ANALYZER	FSEK30	835253/002	June 17, 2004	1 Year	FINAL
OPEN SITE	-----	No.2	May 07, 2004	1 Year	FINAL
N TYPE COAXIAL CABLE	CHA9525	4	July 13, 2004	1 Year	FINAL
Horn Antenna	AH-118	10089	February 25, 2004	1 Year	FINAL
HP Pre-amplifier	8449B	3008A01471	October 11, 2003	1 Year	FINAL
HP High pass filter	84300/80038	011	CAL. ON USE	1 Year	FINAL
Horn Antenna	AH-840	03077	February 25, 2004	1 Year	FINAL

3.2 Test Setup

The diagram below shows the test setup that is utilized to make the measurements for emission from 30 to 1GHz.

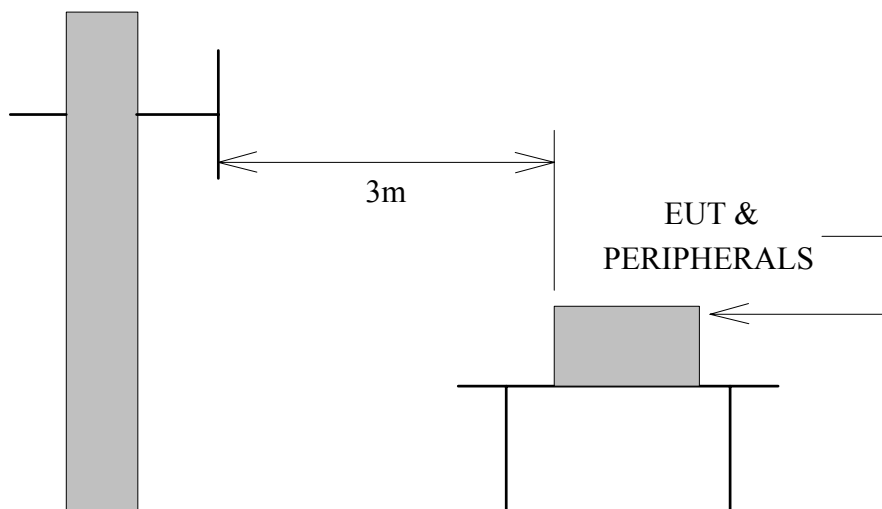

Antenna Elevation Variable

The diagram below shows the test setup that is utilized to make the measurements for emission above 1GHz.

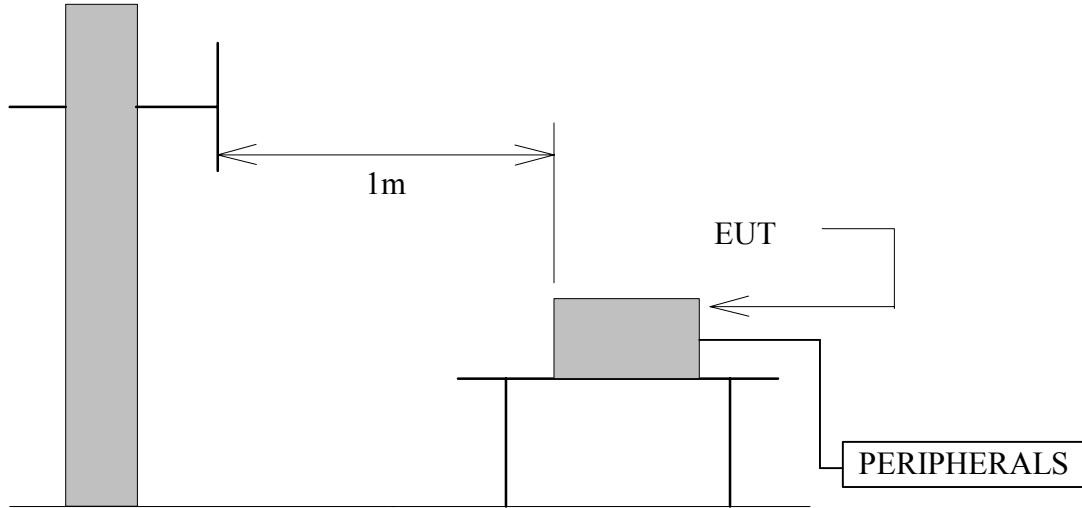

Antenna Elevation Variable

3.3 Radiation Limit

For unintentional device, according to § 15.109(a), except for Class A digital devices, the field strength of radiated emissions from unintentional radiators at a distance of 3 meters shall not exceed the following values :

Frequency (MHz)	Distance (Meters)	Radiated (dB μ V/M)	Radiated (μ V/M)
30-88	3	40.0	100
88-216	3	43.5	150
216-960	3	46.0	200
Above 960	3	54.0	500

For intentional device, according to § 15.209(a), the general requirement of field strength of radiated emissions from intentional radiators at a distance of 3 meters shall not exceed the above table. According to § 15.247(c), in any 100kHz bandwidth outside the frequency band in which the EUT is operating, the radiofrequency power that is produced by the intentional radiator shall be at least 20dB below that in the 100kHz bandwidth within the band that contains the highest level of desired power.



3.4 Test Procedures

- a. The EUT was placed on the top of a rotating table 0.8 meters above the ground at a 10 meter open area test site. The table was rotated 360 degrees to determine the position of the highest radiation.
- b. During performing radiated emission below 1GHz, the EUT was set 3 meters away from the interference-receiving antenna, which was mounted on the top of a variable-height antenna tower. During performing radiated emission above 1GHz, the EUT was set 1 meters away from the interference-receiving antenna
- c. The antenna is a broadband antenna, and its height is varied from one meter to four meters above the ground to determine the maximum value of the field strength. Both horizontal and vertical polarization of the antenna are set to make the measurement.
- d. For each suspected emission, the EUT was arranged to its worst case and then the antenna was tuned to heights from 1 meter to 4 meters and the table was turned from 0 degrees to 360 degrees to find the maximum reading.
- e. The test-receiver system was set to Peak Detect Function and Specified Bandwidth with Maximum Hold Mode.
- f. If the emission level of the EUT in peak mode was 10 dB lower than the limit specified, then testing could be stopped and the peak values of the EUT would be reported. Otherwise the emissions that did not have 10 dB margin would be re-tested one by one using peak, quasi-peak or average method as specified and then reported in a data sheet.

NOTE :

1. The resolution bandwidth and video bandwidth of test receiver/spectrum analyzer is 120 KHz for Peak detection (PK) and Quasi-peak detection (QP) at frequency below 1GHz.
2. The resolution bandwidth and video bandwidth of test receiver/spectrum analyzer is 1 MHz for Peak detection and frequency above 1GHz.
3. The resolution bandwidth of test receiver/spectrum analyzer is 1 MHz and the video bandwidth is 10 Hz for Average detection (AV) at frequency above 1GHz.

3.5 Uncertainty of Radiated Emission

The uncertainty of radiated emission is ± 2.72 dB.



3.6 Radiated RF Noise Measurement

The frequency spectrum from 30 MHz to 1000 MHz was investigated. All emissions not reported are much lower than the prescribed limits.
 All readings are quasi-peak values.

Company	MICRO-STAR INT'L CO., LTD.	Test Date	2004/05/14
Product Name	Wireless 11g Residential Gateway	Test By	Stan Peng
Model Name	MS-6848	TEMP & Humidity	25°C, 60%

Frequency (MHz)	Antenna Factor (dB/m)	Cable Loss (dB)	Meter Reading at 3m(dBμV)		Limits (dBμV/m)	Emission Level at 3m(dBμV/m)	
			Horizontal	Vertical		Horizontal	Vertical
30.00	17.01	0.97	*	*	40.00	*	*
120.00	13.33	2.16	9.60	16.70	43.50	25.09	32.19
159.99	11.73	2.64	12.00	8.60	43.50	26.37	22.97
200.00	9.80	3.14	22.90	10.00	43.50	35.84	22.94
239.99	12.14	3.84	11.00	8.50	46.00	26.97	24.47
319.99	14.49	4.41	9.80	10.00	46.00	28.70	28.90
359.99	16.45	4.63	6.00	4.50	46.00	27.08	25.58
399.99	18.41	4.85	6.50	6.00	46.00	29.76	29.26
439.99	18.18	4.99	6.00	4.80	46.00	29.16	27.96
479.99	17.95	5.12	5.70	2.20	46.00	28.77	25.27
719.98	19.75	6.38	1.80	3.50	46.00	27.92	29.62
1000.00	27.43	7.66	*	*	54.00	*	*

REMARKS :

- * Undetectable
- Emission level (dBμV/m) = Antenna Factor (dB/m) + Cable loss (dB) + Meter Reading (dBμV).
- According to technical experiences, all spurious emission at channel 1,6,11 are almost the same below 1GHz,so that the channel 1 was chosen as representative in finial test.
- The RF-Chip combined with 802.11b&g mode. It will auto-detect the situation then switch the mode. The 802.11g mode is the worse case than the 802.11b mode. So only the 802.11g mode data are recorded in finial test report.
- For Antenna (2).
- After an exploratory test, the emission of antenna (2) is higher than the emission of antenna (1). So only the antenna (2) data are recorded in finial test report.



Ecom Sertech Corp.

Rm. 258, Bldg. 17, NO.195, Sec. 4 Chung Hsing Rd.,ChuTung Chen, Hsinchu, Taiwan 310, R.O.C
TEL:886-3-5918012 FAX : 886-3-5825720

FCC ID : I4L-MS6855A

Report No. : ER04-09-021FRF

Page 18 of 56

The frequency spectrum above 1 GHz was investigated. All emissions not reported are much lower than the prescribed limits. Readings are both peak and average values.

Company	MICRO-STAR INT'L CO., LTD.	Test Date	2004/9/16
Product Name	Wireless 11g MiniPCI Card	Test By	Stan Peng
Model Name	MS-6855A	TEMP & Humidity	25.6°C , 83%

CH1 RX				Measurement Distance at 1m Horizontal polarity							
Freq. (MHz)	Reading (dBµV)	AF (dBµV)	Cable (dB)	Pre-amp (dB)	Dist (dB)	Filter (dB)	Level (dBµV/m)	Limit (dBµV/m)	Margin (dB)	Mark (P/Q/A)	Height (Meter)
4823.86	43.25	34.44	5.08	35.16	9.50	0.00	38.11	74	-35.89	P	1.0
4823.86	32.68	34.44	5.08	35.16	9.50	0.00	27.54	54	-26.46	A	1.0
7236.05	44.65	39.81	6.74	35.65	9.50	0.00	46.04	74	-27.96	P	1.0
7236.05	34.26	39.81	6.74	35.65	9.50	0.00	35.65	54	-18.35	A	1.0
9648.04	45.02	38.54	8.29	36.44	9.50	0.00	45.91	74	-28.09	P	1.0
9648.04	44.59	38.54	8.29	36.44	9.50	0.00	45.48	54	-8.52	A	1.0

1. AF: Antenna Factor, Cable: Cable Loss, Pre-Amp: Preamplifier gain.
2. Spectrum analyzer setting P(Peak): RBW=1MHz, VBW=1MHz, A(Average): RBW=1MHz,VBW=10Hz
3. Dist : correction to extra plate reading to 3m specification distance 1m measurement distance = -9.5dB
4. The result basic equation calculation as follow :
Level = Reading + AF + Cable - Preamp + Filter - Dist, Margin = Level - Limit
5. The test limit is 3M limit.
6. The frequency was searched to 18GHz.
7. The other emission levels were very low against the limit.
8. For Antenna (2).
9. After an exploratory test, the emission of antenna (2) is higher than the emission of antenna (1). So only the antenna (2) data are recorded in final test report.

**Ecom Sertech Corp.**

Rm. 258, Bldg. 17, NO.195, Sec. 4 Chung Hsing Rd., ChuTung Chen, Hsinchu, Taiwan 310, R.O.C
 TEL:886-3-5918012 FAX : 886-3-5825720

FCC ID : I4L-MS6855A

Report No. : ER04-09-021FRF

Page 19 of 56

The frequency spectrum above 1 GHz was investigated. All emissions not reported are much lower than the prescribed limits. Readings are both peak and average values.

Company	MICRO-STAR INT'L CO., LTD.	Test Date	2004/9/16
Product Name	Wireless 11g MiniPCI Card	Test By	Stan Peng
Model Name	MS-6855A	TEMP & Humidity	25.6°C , 83%

CH1 RX				Measurement Distance at 1m Vertical polarity							
Freq. (MHz)	Reading (dBμV)	AF (dBμV)	Cable (dB)	Pre-amp (dB)	Dist (dB)	Filter (dB)	Level (dBμV/m)	Limit (dBμV/m)	Margin (dB)	Mark (P/Q/A)	Height (Meter)
4823.94	42.98	34.44	5.08	35.16	9.50	0.00	37.84	74	-36.16	P	1.0
4823.94	32.74	34.44	5.08	35.16	9.50	0.00	27.60	54	-26.40	A	1.0
7236.15	44.16	39.81	6.74	35.65	9.50	0.00	45.55	74	-28.45	P	1.0
7236.15	33.85	39.81	6.74	35.65	9.50	0.00	35.24	54	-18.76	A	1.0
9647.85	45.06	38.54	8.29	36.44	9.50	0.00	45.95	74	-28.05	P	1.0
9647.85	34.25	38.54	8.29	36.44	9.50	0.00	35.14	54	-18.86	A	1.0

1. AF: Antenna Factor, Cable: Cable Loss, Pre-Amp: Preamplifier gain.
2. Spectrum analyzer setting P(Peak): RBW=1MHz, VBW=1MHz, A(Average): RBW=1MHz, VBW=10Hz
3. Dist : correction to extra plate reading to 3m specification distance 1m measurement distance = -9.5dB
4. The result basic equation calculation as follow :

$$\text{Level} = \text{Reading} + \text{AF} + \text{Cable} - \text{Preamp} + \text{Filter} - \text{Dist}, \text{Margin} = \text{Level} - \text{Limit}$$
5. The test limit is 3M limit.
6. The frequency was searched to 18GHz.
7. The other emission levels were very low against the limit.
8. For Antenna (2).
9. After an exploratory test, the emission of antenna (2) is higher than the emission of antenna (1). So only the antenna (2) data are recorded in final test report.



Ecom Sertech Corp.

Rm. 258, Bldg. 17, NO.195, Sec. 4 Chung Hsing Rd., ChuTung Chen, Hsinchu, Taiwan 310, R.O.C
TEL:886-3-5918012 FAX : 886-3-5825720

FCC ID : I4L-MS6855A

Report No. : ER04-09-021FRF

Page 20 of 56

The frequency spectrum above 1 GHz was investigated. All emissions not reported are much lower than the prescribed limits. Readings are both peak and average values.

Company	MICRO-STAR INT'L CO., LTD.	Test Date	2004/9/16
Product Name	Wireless 11g MiniPCI Card	Test By	Stan Peng
Model Name	MS-6855A	TEMP & Humidity	25.6°C , 83%

CH6 RX				Measurement Distance at 1m Horizontal polarity							
Freq. (MHz)	Reading (dBμV)	AF (dBμV)	Cable (dB)	Pre-amp (dB)	Dist (dB)	Filter (dB)	Level (dBμV/m)	Limit (dBμV/m)	Margin (dB)	Mark (P/Q/A)	Height (Meter)
4873.91	43.56	34.77	5.10	35.20	9.50	0.00	38.73	74	-35.27	P	1.0
4873.91	32.74	34.77	5.10	35.20	9.50	0.00	27.91	54	-26.09	A	1.0
7311.05	44.36	39.78	6.79	35.64	9.50	0.00	45.79	74	-28.21	P	1.0
7311.05	35.36	39.78	6.79	35.64	9.50	0.00	36.79	54	-17.21	A	1.0
9747.94	45.74	38.53	8.33	36.60	9.50	0.00	46.50	74	-27.50	P	1.0
9747.94	35.31	38.53	8.33	36.60	9.50	0.00	36.07	54	-17.93	A	1.0

1. AF: Antenna Factor, Cable: Cable Loss, Pre-Amp: Preamplifier gain.
2. Spectrum analyzer setting P(Peak): RBW=1MHz, VBW=1MHz, A(Average): RBW=1MHz, VBW=10Hz
3. Dist : correction to extra plate reading to 3m specification distance 1m measurement distance = -9.5dB
4. The result basic equation calculation as follow :
Level = Reading + AF + Cable - Preamp + Filter - Dist, Margin = Level - Limit
5. The test limit is 3M limit.
6. The frequency was searched to 18GHz.
7. The other emission levels were very low against the limit.
8. For Antenna (2).
9. After an exploratory test, the emission of antenna (2) is higher than the emission of antenna (1). So only the antenna (2) data are recorded in final test report.



Ecom Sertech Corp.

Rm. 258, Bldg. 17, NO.195, Sec. 4 Chung Hsing Rd., ChuTung Chen, Hsinchu, Taiwan 310, R.O.C
TEL:886-3-5918012 FAX : 886-3-5825720

FCC ID : I4L-MS6855A

Report No. : ER04-09-021FRF

Page 21 of 56

The frequency spectrum above 1 GHz was investigated. All emissions not reported are much lower than the prescribed limits. Readings are both peak and average values.

Company	MICRO-STAR INT'L CO., LTD.	Test Date	2004/9/16
Product Name	Wireless 11g MiniPCI Card	Test By	Stan Peng
Model Name	MS-6855A	TEMP & Humidity	25.6°C , 83%

CH6 RX				Measurement Distance at 1m Vertical polarity							
Freq. (MHz)	Reading (dBμV)	AF (dBμV)	Cable (dB)	Pre-amp (dB)	Dist (dB)	Filter (dB)	Level (dBμV/m)	Limit (dBμV/m)	Margin (dB)	Mark (P/Q/A)	Height (Meter)
4873.96	44.10	34.77	5.10	35.20	9.50	0.00	39.27	74	-34.73	P	1.0
4873.96	33.52	34.77	5.10	35.20	9.50	0.00	28.69	54	-25.31	A	1.0
7311.04	44.77	39.78	6.79	35.64	9.50	0.00	46.20	74	-27.80	P	1.0
7311.04	34.85	39.78	6.79	35.64	9.50	0.00	36.28	54	-17.72	A	1.0
9747.91	45.22	38.53	8.33	36.60	9.50	0.00	45.98	74	-28.02	P	1.0
9747.91	34.97	38.53	8.33	36.60	9.50	0.00	35.73	54	-18.27	A	1.0

1. AF: Antenna Factor, Cable: Cable Loss, Pre-Amp: Preamplifier gain.
2. Spectrum analyzer setting P(Peak): RBW=1MHz, VBW=1MHz, A(Average): RBW=1MHz, VBW=10Hz
3. Dist : correction to extra plate reading to 3m specification distance 1m measurement distance = -9.5dB
4. The result basic equation calculation as follow :
Level = Reading + AF + Cable - Preamp + Filter - Dist, Margin = Level - Limit
5. The test limit is 3M limit.
6. The frequency was searched to 18GHz.
7. The other emission levels were very low against the limit.
8. For Antenna (2).
9. After an exploratory test, the emission of antenna (2) is higher than the emission of antenna (1). So only the antenna (2) data are recorded in final test report.



Ecom Sertech Corp.

Rm. 258, Bldg. 17, NO.195, Sec. 4 Chung Hsing Rd.,ChuTung Chen, Hsinchu, Taiwan 310, R.O.C
TEL:886-3-5918012 FAX : 886-3-5825720

FCC ID : I4L-MS6855A

Report No. : ER04-09-021FRF

Page 22 of 56

The frequency spectrum above 1 GHz was investigated. All emissions not reported are much lower than the prescribed limits. Readings are both peak and average values.

Company	MICRO-STAR INT'L CO., LTD.	Test Date	2004/9/16
Product Name	Wireless 11g MiniPCI Card	Test By	Stan Peng
Model Name	MS-6855A	TEMP & Humidity	25.6°C , 83%

CH11 RX				Measurement Distance at 1m Horizontal polarity							
Freq. (MHz)	Reading (dBμV)	AF (dBμV)	Cable (dB)	Pre-amp (dB)	Dist (dB)	Filter (dB)	Level (dBμV/m)	Limit (dBμV/m)	Margin (dB)	Mark (P/Q/A)	Height (Meter)
4923.75	42.15	35.10	5.12	35.24	9.50	0.00	37.62	74	-36.38	P	1.0
4923.75	32.85	35.10	5.12	35.24	9.50	0.00	28.32	54	-25.68	A	1.0
7385.99	43.17	39.75	6.84	35.62	9.50	0.00	44.64	74	-29.36	P	1.0
7385.99	34.56	39.75	6.84	35.62	9.50	0.00	36.03	54	-17.97	A	1.0
9847.81	44.78	38.52	8.37	36.76	9.50	0.00	45.40	74	-28.60	P	1.0
9847.81	35.41	38.52	8.37	36.76	9.50	0.00	36.03	54	-17.97	A	1.0

1. AF: Antenna Factor, Cable: Cable Loss, Pre-Amp: Preamplifier gain.
2. Spectrum analyzer setting P(Peak): RBW=1MHz, VBW=1MHz, A(Average): RBW=1MHz,VBW=10Hz
3. Dist : correction to extra plate reading to 3m specification distance 1m measurement distance = -9.5dB
4. The result basic equation calculation as follow :
Level = Reading + AF + Cable - Preamp + Filter - Dist, Margin = Level - Limit
5. The test limit is 3M limit.
6. The frequency was searched to 18GHz.
7. The other emission levels were very low against the limit.
8. For Antenna (2).
9. After an exploratory test, the emission of antenna (2) is higher than the emission of antenna (1). So only the antenna (2) data are recorded in final test report.



Ecom Sertech Corp.

Rm. 258, Bldg. 17, NO.195, Sec. 4 Chung Hsing Rd., ChuTung Chen, Hsinchu, Taiwan 310, R.O.C
 TEL:886-3-5918012 FAX : 886-3-5825720

FCC ID : I4L-MS6855A

Report No. : ER04-09-021FRF

Page 23 of 56

The frequency spectrum above 1 GHz was investigated. All emissions not reported are much lower than the prescribed limits. Readings are both peak and average values.

Company	MICRO-STAR INT'L CO., LTD.	Test Date	2004/9/16
Product Name	Wireless 11g MiniPCI Card	Test By	Stan Peng
Model Name	MS-6855A	TEMP & Humidity	25.6°C , 83%

CH11 RX				Measurement Distance at 1m Vertical polarity							
Freq. (MHz)	Reading (dBμV)	AF (dBμV)	Cable (dB)	Pre-amp (dB)	Dist (dB)	Filter (dB)	Level (dBμV/m)	Limit (dBμV/m)	Margin (dB)	Mark (P/Q/A)	Height (Meter)
4923.91	43.01	35.10	5.12	35.24	9.50	0.00	38.48	74	-35.52	P	1.0
4923.91	32.58	35.10	5.12	35.24	9.50	0.00	28.05	54	-25.95	A	1.0
7386.02	43.75	39.75	6.84	35.62	9.50	0.00	45.22	74	-28.78	P	1.0
7386.02	33.68	39.75	6.84	35.62	9.50	0.00	35.15	54	-18.85	A	1.0
9848.01	45.11	38.52	8.37	36.76	9.50	0.00	45.73	74	-28.27	P	1.0
9848.01	35.63	38.52	8.37	36.76	9.50	0.00	36.25	54	-17.75	A	1.0

1. AF: Antenna Factor, Cable: Cable Loss, Pre-Amp: Preamplifier gain.
2. Spectrum analyzer setting P(Peak): RBW=1MHz, VBW=1MHz, A(Average): RBW=1MHz, VBW=10Hz
3. Dist : correction to extra plate reading to 3m specification distance 1m measurement distance = -9.5dB
4. The result basic equation calculation as follow :

$$\text{Level} = \text{Reading} + \text{AF} + \text{Cable} - \text{Preamp} + \text{Filter} - \text{Dist}, \text{Margin} = \text{Level} - \text{Limit}$$
5. The test limit is 3M limit.
6. The frequency was searched to 18GHz.
7. The other emission levels were very low against the limit.
8. For Antenna (2).
9. After an exploratory test, the emission of antenna (2) is higher than the emission of antenna (1). So only the antenna (2) data are recorded in final test report.



Ecom Sertech Corp.

Rm. 258, Bldg. 17, NO.195, Sec. 4 Chung Hsing Rd., ChuTung Chen, Hsinchu, Taiwan 310, R.O.C
 TEL:886-3-5918012 FAX: 886-3-5825720

FCC ID : I4L-MS6855A

Report No. : ER04-09-021FRF

Page 24 of 56

The frequency spectrum above 1 GHz was investigated. All emissions not reported are much lower than the prescribed limits. Readings are both peak and average values.

Company	MICRO-STAR INT'L CO., LTD.	Test Date	2004/09/16
Product Name	Wireless 11g MiniPCI Card	Test By	Stan Peng
Model Name	MS-6855A	TEMP & Humidity	25.6°C , 83%

CH1 TX				Measurement Distance at 1m Horizontal polarity							
Freq. (MHz)	Reading (dBμV)	AF (dBμV)	Cable (dB)	Pre-amp (dB)	Dist (dB)	Filter (dB)	Level (dBμV/m)	Limit (dBμV/m)	Margin (dB)	Mark (P/Q/A)	Height (Meter)
2037.99	50.43	32.16	3.42	35.30	9.50	0.00	41.21	83.54	-42.33	P	1.00
2037.99	45.65	32.16	3.42	35.30	9.50	0.00	36.43	77.04	-40.61	A	1.00
* 2389.90	28.20	31.81	3.57	0.00	9.50	0.00	54.08	74.00	-19.92	P	1.00
* 2389.90	15.30	31.81	3.57	0.00	9.50	0.00	41.18	54.00	-12.82	A	1.00
2412.50	77.67	31.79	3.58	0.00	9.50	0.00	103.54	Fundamental Frequency		P	1.00
2412.50	71.17	31.79	3.58	0.00	9.50	0.00	97.04			A	1.00
* 4823.98	43.86	34.44	5.08	35.16	9.50	2.00	40.73	74.00	-33.27	P	1.00
* 4823.98	32.82	34.44	5.08	35.16	9.50	2.00	29.69	54.00	-24.31	A	1.00
7236.00	45.58	39.81	6.74	35.65	9.50	2.00	48.97	83.54	-34.57	P	1.00
7236.00	34.24	39.81	6.74	35.65	9.50	2.00	37.63	77.04	-39.41	A	1.00
9647.60	47.36	38.54	8.29	36.44	9.50	0.61	48.86	83.54	-34.68	P	1.00
9647.60	36.55	38.54	8.29	36.44	9.50	0.61	38.05	77.04	-38.99	A	1.00
* 12062.50	-----	-----	-----	-----	9.50	0.80	-----	-----	-----	-----	1.00
* 14475.00	-----	-----	-----	-----	9.50	0.67	-----	-----	-----	-----	1.00
16887.50	-----	-----	-----	-----	9.50	0.43	-----	-----	-----	-----	1.00
* 19300.00	-----	-----	-----	-----	9.50	1.96	-----	-----	-----	-----	1.00
21712.50	-----	-----	-----	-----	9.50	0.82	-----	-----	-----	-----	1.00
24125.00	-----	-----	-----	-----	9.50	2.90	-----	-----	-----	-----	1.00

Note :

- The measurement was searched to 10th harmonic, Remark “---” means that the emissions level is too low to be measured.
- AF: Antenna Factor, Cable: Cable Loss, Pre-Amp: Preamplifier gain, Filter: High Pass Filter Insertion Loss (3.5GHz)
- Spectrum analyzer setting P(Peak): RBW=1MHz, VBW=1MHz, A(Average): RBW=1MHz, VBW=10Hz
- Remark “*” means the Restricted band.
- Dist : correction to extra plate reading to 3m specification distance 1m measurement distance = -9.5dB
- The result basic equation calculation is as follow:
 $Level = Reading + AF + Cable - Preamp + Filter - Dist, Margin = Level - Limit$
- The other emission levels were very low against the limit
- The test limit distance is 3M limit.
- For 802.11b mode at 11Mbps. (Antenna 2)
- After an exploratory test, the emission of antenna (2) is higher than the emission of antenna (1). So only the antenna (2) data are recorded in final test report.



Ecom Sertech Corp.

Rm. 258, Bldg. 17, NO.195, Sec. 4 Chung Hsing Rd., ChuTung Chen, Hsinchu, Taiwan 310, R.O.C
 TEL:886-3-5918012 FAX: 886-3-5825720

FCC ID : I4L-MS6855A

Report No. : ER04-09-021FRF

Page 25 of 56

The frequency spectrum above 1 GHz was investigated. All emissions not reported are much lower than the prescribed limits. Readings are both peak and average values.

Company	MICRO-STAR INT'L CO., LTD.	Test Date	2004/09/16
Product Name	Wireless 11g MiniPCI Card	Test By	Stan Peng
Model Name	MS-6855A	TEMP & Humidity	25.6°C , 83%

CH1 TX				Measurement Distance at 1m Vertical polarity							
Freq. (MHz)	Reading (dBμV)	AF (dBμV)	Cable (dB)	Pre-amp (dB)	Dist (dB)	Filter (dB)	Level (dBμV/m)	Limit (dBμV/m)	Margin (dB)	Mark (P/Q/A)	Height (Meter)
2037.99	55.46	32.16	3.42	35.30	9.50	0.00	46.24	92.54	-46.30	P	1.00
2037.99	52.99	32.16	3.42	35.30	9.50	0.00	43.77	86.01	-42.24	A	1.00
* 2389.90	35.90	31.81	3.57	0.00	9.50	0.00	61.78	74.00	-12.22	P	1.00
* 2389.90	22.90	31.81	3.57	0.00	9.50	0.00	48.78	54.00	-5.22	A	1.00
2411.84	86.67	31.79	3.58	0.00	9.50	0.00	112.54	Fundamental Frequency		P	1.00
2411.84	80.14	31.79	3.58	0.00	9.50	0.00	106.01			A	1.00
* 4823.92	50.10	34.44	5.08	35.16	9.50	2.00	46.97	74.00	-27.03	P	1.00
* 4823.92	38.45	34.44	5.08	35.16	9.50	2.00	35.32	54.00	-18.68	A	1.00
7236.02	46.28	39.81	6.74	35.65	9.50	2.00	49.67	92.54	-42.87	P	1.00
7236.02	34.22	39.81	6.74	35.65	9.50	2.00	37.61	86.01	-48.40	A	1.00
9648.00	47.06	38.54	8.29	36.44	9.50	0.61	48.56	92.54	-43.98	P	1.00
9648.00	36.85	38.54	8.29	36.44	9.50	0.61	38.35	86.01	-47.66	A	1.00
* 12059.20	-----	-----	-----	-----	9.50	0.80	-----	-----	-----	-----	1.00
* 14471.04	-----	-----	-----	-----	9.50	0.67	-----	-----	-----	-----	1.00
16882.88	-----	-----	-----	-----	9.50	0.43	-----	-----	-----	-----	1.00
* 19294.72	-----	-----	-----	-----	9.50	1.95	-----	-----	-----	-----	1.00
21706.56	-----	-----	-----	-----	9.50	0.82	-----	-----	-----	-----	1.00
24118.40	-----	-----	-----	-----	9.50	2.91	-----	-----	-----	-----	1.00

- Note :
- The measurement was searched to 10th harmonic, Remark "----" means that the emissions level is too low to be measured.
 - AF: Antenna Factor, Cable: Cable Loss, Pre-Amp: Preamplifier gain, Filter: High Pass Filter Insertion Loss (3.5GHz)
 - Spectrum analyzer setting P(Peak): RBW=1MHz, VBW=1MHz, A(Average): RBW=1MHz, VBW=10Hz
 - Remark "*" means the Restricted band.
 - Dist : correction to extra plate reading to 3m specification distance 1m measurement distance = -9.5dB
 - The result basic equation calculation is as follow:

$$\text{Level} = \text{Reading} + \text{AF} + \text{Cable} - \text{Preamp} + \text{Filter} - \text{Dist}, \text{Margin} = \text{Level} - \text{Limit}$$
 - The other emission levels were very low against the limit
 - The test limit distance is 3M limit.
 - For 802.11b mode at 11Mbps. (Antenna 2)
 - After an exploratory test, the emission of antenna (2) is higher than the emission of antenna (1). So only the antenna (2) data are recorded in final test report.



Ecom Sertech Corp.

Rm. 258, Bldg. 17, NO.195, Sec. 4 Chung Hsing Rd., ChuTung Chen, Hsinchu, Taiwan 310, R.O.C
 TEL:886-3-5918012 FAX : 886-3-5825720

FCC ID : I4L-MS6855A

Report No. : ER04-09-021FRF

Page 26 of 56

The frequency spectrum above 1 GHz was investigated. All emissions not reported are much lower than the prescribed limits. Readings are both peak and average values.

Company	MICRO-STAR INT'L CO., LTD.	Test Date	2004/09/16
Product Name	Wireless 11g MiniPCI Card	Test By	Stan Peng
Model Name	MS-6855A	TEMP & Humidity	25.6°C , 83%

CH6 TX				Measurement Distance at 1m Horizontal polarity							
Freq. (MHz)	Reading (dBμV)	AF (dBμV)	Cable (dB)	Pre-amp (dB)	Dist (dB)	Filter (dB)	Level (dBμV/m)	Limit (dBμV/m)	Margin (dB)	Mark (P/Q/A)	Height (Meter)
2063.00	51.94	32.14	3.43	35.30	9.50	0.00	42.70	83.68	-40.98	P	1.00
2063.00	47.70	32.14	3.43	35.30	9.50	0.00	38.46	77.16	-38.70	A	1.00
2438.40	77.83	31.76	3.59	0.00	9.50	0.00	103.68	Fundamental Frequency		P	1.00
2438.40	71.31	31.76	3.59	0.00	9.50	0.00	97.16			A	1.00
* 4874.22	45.81	34.77	5.10	35.20	9.50	1.80	42.78	74.00	-31.22	P	1.00
* 4874.22	33.73	34.77	5.10	35.20	9.50	1.80	30.70	54.00	-23.30	A	1.00
* 7311.05	44.85	39.78	6.79	35.64	9.50	2.00	48.28	74.00	-25.72	P	1.00
* 7311.05	34.02	39.78	6.79	35.64	9.50	2.00	37.45	54.00	-16.55	A	1.00
9752.78	45.37	38.52	8.33	36.60	9.50	0.55	46.67	83.68	-37.01	P	1.00
9752.78	33.90	38.52	8.33	36.60	9.50	0.55	35.20	77.16	-41.96	A	1.00
* 12192.00	-----	-----	-----	-----	9.50	0.80	-----	-----	-----	-----	1.00
14630.40	-----	-----	-----	-----	9.50	0.60	-----	-----	-----	-----	1.00
17068.80	-----	-----	-----	-----	9.50	0.53	-----	-----	-----	-----	1.00
* 19507.20	-----	-----	-----	-----	9.50	2.21	-----	-----	-----	-----	1.00
21945.60	-----	-----	-----	-----	9.50	0.72	-----	-----	-----	-----	1.00
24384.00	-----	-----	-----	-----	9.50	2.49	-----	-----	-----	-----	1.00

Note :

- The measurement was searched to 10th harmonic, Remark “---” means that the emissions level is too low to be measured.
- AF: Antenna Factor, Cable: Cable Loss, Pre-Amp: Preamplifier gain, Filter: High Pass Filter Insertion Loss (3.5GHz)
- Spectrum analyzer setting P(Peak): RBW=1MHz, VBW=1MHz, A(Average): RBW=1MHz, VBW=10Hz
- Remark “*” means the Restricted band.
- Dist : correction to extra plate reading to 3m specification distance 1m measurement distance = -9.5dB
- The result basic equation calculation is as follow:
 $Level = Reading + AF + Cable - Preamp + Filter - Dist$, $Margin = Level - Limit$
- The other emission levels were very low against the limit
- The test limit distance is 3M limit.
- For 802.11b mode at 11Mbps. (Antenna 2)
- After an exploratory test, the emission of antenna (2) is higher than the emission of antenna (1). So only the antenna (2) data are recorded in final test report.



Ecom Sertech Corp.

Rm. 258, Bldg. 17, NO.195, Sec. 4 Chung Hsing Rd., ChuTung Chen, Hsinchu, Taiwan 310, R.O.C
 TEL:886-3-5918012 FAX : 886-3-5825720

FCC ID : I4L-MS6855A

Report No. : ER04-09-021FRF

Page 27 of 56

The frequency spectrum above 1 GHz was investigated. All emissions not reported are much lower than the prescribed limits. Readings are both peak and average values.

Company	MICRO-STAR INT'L CO., LTD.	Test Date	2004/09/16
Product Name	Wireless 11g MiniPCI Card	Test By	Stan Peng
Model Name	MS-6855A	TEMP & Humidity	25.6°C , 83%

CH6 TX				Measurement Distance at 1m Vertical polarity							
Freq. (MHz)	Reading (dBμV)	AF (dBμV)	Cable (dB)	Pre-amp (dB)	Dist (dB)	Filter (dB)	Level (dBμV/m)	Limit (dBμV/m)	Margin (dB)	Mark (P/Q/A)	Height (Meter)
2062.94	56.75	32.14	3.43	35.30	9.50	0.00	47.51	92.83	-45.31	P	1.00
2062.94	54.29	32.14	3.43	35.30	9.50	0.00	45.05	86.09	-41.03	A	1.00
2435.88	86.97	31.76	3.59	0.00	9.50	0.00	112.83	Fundamental Frequency		P	1.00
2435.88	80.23	31.76	3.59	0.00	9.50	0.00	106.09			A	1.00
* 4874.10	54.25	34.77	5.10	35.20	9.50	1.80	51.22	74.00	-22.78	P	1.00
* 4874.10	42.67	34.77	5.10	35.20	9.50	1.80	39.64	54.00	-14.36	A	1.00
* 7312.03	44.57	39.78	6.79	35.64	9.50	2.00	48.00	74.00	-26.00	P	1.00
* 7312.03	32.98	39.78	6.79	35.64	9.50	2.00	36.41	54.00	-17.59	A	1.00
9747.78	45.77	38.53	8.33	36.60	9.50	0.55	47.08	92.83	-45.75	P	1.00
9747.78	36.70	38.53	8.33	36.60	9.50	0.55	38.01	86.09	-48.08	A	1.00
* 12179.40	-----	-----	-----	-----	9.50	0.80	-----	-----	-----	-----	1.00
14615.28	-----	-----	-----	-----	9.50	0.61	-----	-----	-----	-----	1.00
17051.16	-----	-----	-----	-----	9.50	0.52	-----	-----	-----	-----	1.00
* 19487.04	-----	-----	-----	-----	9.50	2.18	-----	-----	-----	-----	1.00
21922.92	-----	-----	-----	-----	9.50	0.73	-----	-----	-----	-----	1.00
24358.80	-----	-----	-----	-----	9.50	2.53	-----	-----	-----	-----	1.00

Note :

- The measurement was searched to 10th harmonic, Remark “---” means that the emissions level is too low to be measured.
- AF: Antenna Factor, Cable: Cable Loss, Pre-Amp: Preamplifier gain, Filter: High Pass Filter Insertion Loss (3.5GHz)
- Spectrum analyzer setting P(Peak): RBW=1MHz, VBW=1MHz, A(Average): RBW=1MHz, VBW=10Hz
- Remark “*” means the Restricted band.
- Dist : correction to extra plate reading to 3m specification distance 1m measurement distance = -9.5dB
- The result basic equation calculation is as follow:
 $Level = Reading + AF + Cable - Preamp + Filter - Dist$, $Margin = Level - Limit$
- The other emission levels were very low against the limit
- The test limit distance is 3M limit.
- For 802.11b mode at 11Mbps. (Antenna 2)
- After an exploratory test, the emission of antenna (2) is higher than the emission of antenna (1). So only the antenna (2) data are recorded in final test report.



Ecom Sertech Corp.

Rm. 258, Bldg. 17, NO.195, Sec. 4 Chung Hsing Rd., ChuTung Chen, Hsinchu, Taiwan 310, R.O.C
 TEL:886-3-5918012 FAX: 886-3-5825720

FCC ID : I4L-MS6855A

Report No. : ER04-09-021FRF

Page 28 of 56

The frequency spectrum above 1 GHz was investigated. All emissions not reported are much lower than the prescribed limits. Readings are both peak and average values.

Company	MICRO-STAR INT'L CO., LTD.	Test Date	2004/09/16
Product Name	Wireless 11g MiniPCI Card	Test By	Stan Peng
Model Name	MS-6855A	TEMP & Humidity	25.6°C , 83%

CH11 TX				Measurement Distance at 1m Horizontal polarity							
Freq. (MHz)	Reading (dBμV)	AF (dBμV)	Cable (dB)	Pre-amp (dB)	Dist (dB)	Filter (dB)	Level (dBμV/m)	Limit (dBμV/m)	Margin (dB)	Mark (P/Q/A)	Height (Meter)
2088.01	55.12	32.11	3.44	35.30	9.50	0.00	45.87	80.89	-35.02	P	1.00
2088.01	52.38	32.11	3.44	35.30	9.50	0.00	43.13	74.19	-31.06	A	1.00
2462.27	75.05	31.74	3.60	0.00	9.50	0.00	100.89	Fundamental Frequency		P	1.00
2462.27	68.35	31.74	3.60	0.00	9.50	0.00	94.19			A	1.00
* 2484.80	27.00	31.72	3.61	0.00	9.50	0.00	52.83	74.00	-21.17	P	1.00
* 2484.80	14.70	31.72	3.61	0.00	9.50	0.00	40.53	54.00	-13.47	A	1.00
* 4923.88	44.50	35.10	5.12	35.24	9.50	1.60	41.58	74.00	-32.42	P	1.00
* 4923.88	33.17	35.10	5.12	35.24	9.50	1.60	30.25	54.00	-23.75	A	1.00
* 7385.98	44.20	39.75	6.84	35.62	9.50	2.00	47.67	74.00	-26.33	P	1.00
* 7385.98	33.56	39.75	6.84	35.62	9.50	2.00	37.03	54.00	-16.97	A	1.00
9847.97	45.10	38.52	8.37	36.76	9.50	0.49	46.21	80.89	-34.68	P	1.00
9847.97	34.74	38.52	8.37	36.76	9.50	0.49	35.85	74.19	-38.34	A	1.00
* 12311.35	-----	-----	-----	-----	9.50	0.80	-----	-----	-----	-----	1.00
14773.62	-----	-----	-----	-----	9.50	0.48	-----	-----	-----	-----	1.00
17235.89	-----	-----	-----	-----	9.50	0.59	-----	-----	-----	-----	1.00
* 19698.16	-----	-----	-----	-----	9.50	2.40	-----	-----	-----	-----	1.00
* 22160.43	-----	-----	-----	-----	9.50	0.70	-----	-----	-----	-----	1.00
24622.70	-----	-----	-----	-----	9.50	2.13	-----	-----	-----	-----	1.00

Note :

- The measurement was searched to 10th harmonic, Remark “---” means that the emissions level is too low to be measured.
- AF: Antenna Factor, Cable: Cable Loss, Pre-Amp: Preamplifier gain, Filter: High Pass Filter Insertion Loss (3.5GHz)
- Spectrum analyzer setting P(Peak): RBW=1MHz, VBW=1MHz, A(Average): RBW=1MHz, VBW=10Hz
- Remark “*” means the Restricted band.
- Dist : correction to extra plate reading to 3m specification distance 1m measurement distance = -9.5dB
- The result basic equation calculation is as follow:
 $Level = Reading + AF + Cable - Preamp + Filter - Dist$, $Margin = Level - Limit$
- The other emission levels were very low against the limit
- The test limit distance is 3M limit.
- For 802.11b mode at 11Mbps. (Antenna 2)
- After an exploratory test, the emission of antenna (2) is higher than the emission of antenna (1). So only the antenna (2) data are recorded in final test report.



Ecom Sertech Corp.

Rm. 258, Bldg. 17, NO.195, Sec. 4 Chung Hsing Rd., ChuTung Chen, Hsinchu, Taiwan 310, R.O.C
 TEL:886-3-5918012 FAX : 886-3-5825720

FCC ID : I4L-MS6855A

Report No. : ER04-09-021FRF

Page 29 of 56

The frequency spectrum above 1 GHz was investigated. All emissions not reported are much lower than the prescribed limits. Readings are both peak and average values.

Company	MICRO-STAR INT'L CO., LTD.	Test Date	2004/09/16
Product Name	Wireless 11g MiniPCI Card	Test By	Stan Peng
Model Name	MS-6855A	TEMP & Humidity	25.6°C , 83%

CH11 TX				Measurement Distance at 1m Vertical polarity							
Freq. (MHz)	Reading (dBμV)	AF (dBμV)	Cable (dB)	Pre-amp (dB)	Dist (dB)	Filter (dB)	Level (dBμV/m)	Limit (dBμV/m)	Margin (dB)	Mark (P/Q/A)	Height (Meter)
2088.00	60.84	32.11	3.44	35.30	9.50	0.00	51.59	91.24	-39.65	P	1.00
2088.00	59.19	32.11	3.44	35.30	9.50	0.00	49.94	84.63	-34.69	A	1.00
2460.84	85.40	31.74	3.60	0.00	9.50	0.00	111.24	Fundamental Frequency		P	1.00
2460.84	78.79	31.74	3.60	0.00	9.50	0.00	104.63			A	1.00
* 2484.80	34.80	31.72	3.61	0.00	9.50	0.00	60.63	74.00	-13.37	P	1.00
* 2484.80	22.10	31.72	3.61	0.00	9.50	0.00	47.93	54.00	-6.07	A	1.00
* 4923.92	55.92	35.10	5.12	35.24	9.50	1.60	53.00	74.00	-21.00	P	1.00
* 4923.92	44.48	35.10	5.12	35.24	9.50	1.60	41.56	54.00	-12.44	A	1.00
* 7386.05	45.12	39.75	6.84	35.62	9.50	2.00	48.59	74.00	-25.41	P	1.00
* 7386.05	34.22	39.75	6.84	35.62	9.50	2.00	37.69	54.00	-16.31	A	1.00
9847.85	47.34	38.52	8.37	36.76	9.50	0.49	48.46	91.24	-42.79	P	1.00
9847.85	34.88	38.52	8.37	36.76	9.50	0.49	36.00	84.63	-48.64	A	1.00
* 12304.20	-----	-----	-----	-----	9.50	0.80	-----	-----	-----	-----	1.00
14765.04	-----	-----	-----	-----	9.50	0.49	-----	-----	-----	-----	1.00
17225.88	-----	-----	-----	-----	9.50	0.59	-----	-----	-----	-----	1.00
* 19686.72	-----	-----	-----	-----	9.50	2.39	-----	-----	-----	-----	1.00
* 22147.56	-----	-----	-----	-----	9.50	0.70	-----	-----	-----	-----	1.00
24608.40	-----	-----	-----	-----	9.50	2.15	-----	-----	-----	-----	1.00

Note :

- The measurement was searched to 10th harmonic, Remark “---” means that the emissions level is too low to be measured.
- AF: Antenna Factor, Cable: Cable Loss, Pre-Amp: Preamplifier gain, Filter: High Pass Filter Insertion Loss (3.5GHz)
- Spectrum analyzer setting P(Peak): RBW=1MHz, VBW=1MHz, A(Average): RBW=1MHz, VBW=10Hz
- Remark “*” means the Restricted band.
- Dist : correction to extra plate reading to 3m specification distance 1m measurement distance = -9.5dB
- The result basic equation calculation is as follow:
 Level = Reading + AF + Cable - Preamp + Filter - Dist, Margin = Level - Limit
- The other emission levels were very low against the limit
- The test limit distance is 3M limit.
- For 802.11b mode at 11Mbps. (Antenna 2)
- After an exploratory test, the emission of antenna (2) is higher than the emission of antenna (1). So only the antenna (2) data are recorded in final test report.



Ecom Sertech Corp.

Rm. 258, Bldg. 17, NO.195, Sec. 4 Chung Hsing Rd., ChuTung Chen, Hsinchu, Taiwan 310, R.O.C
 TEL:886-3-5918012 FAX : 886-3-5825720

FCC ID : I4L-MS6855A

Report No. : ER04-09-021FRF

Page 30 of 56

The frequency spectrum above 1 GHz was investigated. All emissions not reported are much lower than the prescribed limits. Readings are both peak and average values.

Company	MICRO-STAR INT'L CO., LTD.	Test Date	2004/09/16
Product Name	Wireless 11g MiniPCI Card	Test By	Stan Peng
Model Name	MS-6855A	TEMP & Humidity	25.6°C , 83%

CH1 TX				Measurement Distance at 1m Horizontal polarity							
Freq. (MHz)	Reading (dBμV)	AF (dBμV)	Cable (dB)	Pre-amp (dB)	Dist (dB)	Filter (dB)	Level (dBμV/m)	Limit (dBμV/m)	Margin (dB)	Mark (P/Q/A)	Height (Meter)
2037.94	50.33	32.16	3.42	35.30	9.50	0.00	41.11	83.08	-41.97	P	1.00
2037.94	46.11	32.16	3.42	35.30	9.50	0.00	36.89	74.65	-37.76	A	1.00
* 2389.90	34.60	31.81	3.57	0.00	9.50	0.00	60.48	74.00	-13.52	P	1.00
* 2389.90	16.10	31.81	3.57	0.00	9.50	0.00	41.98	54.00	-12.02	A	1.00
2417.79	77.21	31.78	3.58	0.00	9.50	0.00	103.08	Fundamental Frequency		P	1.00
2417.79	68.78	31.78	3.58	0.00	9.50	0.00	94.65			A	1.00
* 4823.87	43.31	34.44	5.08	35.16	9.50	2.00	40.18	74.00	-33.82	P	1.00
* 4823.87	32.25	34.44	5.08	35.16	9.50	2.00	29.12	54.00	-24.88	A	1.00
7236.00	43.80	39.81	6.74	35.65	9.50	2.00	47.19	83.08	-35.88	P	1.00
7236.00	32.98	39.81	6.74	35.65	9.50	2.00	36.37	74.65	-38.27	A	1.00
9648.00	45.95	38.54	8.29	36.44	9.50	0.61	47.45	83.08	-35.62	P	1.00
9648.00	34.20	38.54	8.29	36.44	9.50	0.61	35.70	74.65	-38.94	A	1.00
* 12088.95	-----	-----	-----	-----	9.50	0.80	-----	-----	-----	-----	1.00
14506.74	-----	-----	-----	-----	9.50	0.69	-----	-----	-----	-----	1.00
16924.53	-----	-----	-----	-----	9.50	0.45	-----	-----	-----	-----	1.00
* 19342.32	-----	-----	-----	-----	9.50	2.01	-----	-----	-----	-----	1.00
21760.11	-----	-----	-----	-----	9.50	0.80	-----	-----	-----	-----	1.00
24177.90	-----	-----	-----	-----	9.50	2.82	-----	-----	-----	-----	1.00

- Note :
- The measurement was searched to 10th harmonic, Remark “---” means that the emissions level is too low to be measured.
 - AF: Antenna Factor, Cable: Cable Loss, Pre-Amp: Preamplifier gain, Filter: High Pass Filter Insertion Loss (3.5GHz)
 - Spectrum analyzer setting P(Peak): RBW=1MHz, VBW=1MHz, A(Average): RBW=1MHz, VBW=10Hz
 - Remark “*” means the Restricted band.
 - Dist : correction to extra plate reading to 3m specification distance 1m measurement distance = -9.5dB
 - The result basic equation calculation is as follow:
 $Level = Reading + AF + Cable - Preamp + Filter - Dist, Margin = Level - Limit$
 - The other emission levels were very low against the limit
 - The test limit distance is 3M limit.
 - For 802.11g mode at 6Mbps. (Antenna 2)
 - After an exploratory test, the emission of antenna (2) is higher than the emission of antenna (1). So only the antenna (2) data are recorded in final test report.



Ecom Sertech Corp.

Rm. 258, Bldg. 17, NO.195, Sec. 4 Chung Hsing Rd., ChuTung Chen, Hsinchu, Taiwan 310, R.O.C
 TEL:886-3-5918012 FAX : 886-3-5825720

FCC ID : I4L-MS6855A

Report No. : ER04-09-021FRF

Page 31 of 56

The frequency spectrum above 1 GHz was investigated. All emissions not reported are much lower than the prescribed limits. Readings are both peak and average values.

Company	MICRO-STAR INT'L CO., LTD.	Test Date	2004/09/16
Product Name	Wireless 11g MiniPCI Card	Test By	Stan Peng
Model Name	MS-6855A	TEMP & Humidity	25.6°C , 83%

CH1 TX				Measurement Distance at 1m Vertical polarity							
Freq. (MHz)	Reading (dBμV)	AF (dBμV)	Cable (dB)	Pre-amp (dB)	Dist (dB)	Filter (dB)	Level (dBμV/m)	Limit (dBμV/m)	Margin (dB)	Mark (P/Q/A)	Height (Meter)
2037.89	56.64	32.16	3.42	35.30	9.50	0.00	47.42	92.61	-45.19	P	1.00
2037.89	53.28	32.16	3.42	35.30	9.50	0.00	44.06	84.33	-40.27	A	1.00
* 2389.90	45.20	31.81	3.57	0.00	9.50	0.00	71.08	74.00	-2.92	P	1.00
* 2389.90	25.40	31.81	3.57	0.00	9.50	0.00	51.28	54.00	-2.72	A	1.00
2417.61	86.74	31.78	3.58	0.00	9.50	0.00	112.61	Fundamental Frequency		P	1.00
2417.61	78.46	31.78	3.58	0.00	9.50	0.00	104.33			A	1.00
* 4830.02	47.75	34.48	5.09	35.16	9.50	1.98	44.63	74.00	-29.37	P	1.00
* 4830.02	37.10	34.48	5.09	35.16	9.50	1.98	33.98	54.00	-20.02	A	1.00
7235.72	44.47	39.81	6.74	35.65	9.50	2.00	47.86	92.61	-44.74	P	1.00
7235.72	33.16	39.81	6.74	35.65	9.50	2.00	36.55	84.33	-47.77	A	1.00
9647.85	45.58	38.54	8.29	36.44	9.50	0.61	47.08	92.61	-45.52	P	1.00
9647.85	34.06	38.54	8.29	36.44	9.50	0.61	35.56	84.33	-48.76	A	1.00
* 12088.05	-----	-----	-----	-----	9.50	0.80	-----	-----	-----	-----	1.00
14505.66	-----	-----	-----	-----	9.50	0.70	-----	-----	-----	-----	1.00
16923.27	-----	-----	-----	-----	9.50	0.45	-----	-----	-----	-----	1.00
* 19340.88	-----	-----	-----	-----	9.50	2.01	-----	-----	-----	-----	1.00
21758.49	-----	-----	-----	-----	9.50	0.80	-----	-----	-----	-----	1.00
24176.10	-----	-----	-----	-----	9.50	2.82	-----	-----	-----	-----	1.00

Note :

- The measurement was searched to 10th harmonic, Remark “---” means that the emissions level is too low to be measured.
- AF: Antenna Factor, Cable: Cable Loss, Pre-Amp: Preamplifier gain, Filter: High Pass Filter Insertion Loss (3.5GHz)
- Spectrum analyzer setting P(Peak): RBW=1MHz, VBW=1MHz, A(Average): RBW=1MHz, VBW=10Hz
- Remark “*” means the Restricted band.
- Dist : correction to extra plate reading to 3m specification distance 1m measurement distance = -9.5dB
- The result basic equation calculation is as follow:
 $Level = Reading + AF + Cable - Preamp + Filter - Dist, Margin = Level - Limit$
- The other emission levels were very low against the limit
- The test limit distance is 3M limit.
- For 802.11g mode at 6Mbps. (Antenna 2)
- After an exploratory test, the emission of antenna (2) is higher than the emission of antenna (1). So only the antenna (2) data are recorded in final test report.



Ecom Sertech Corp.

Rm. 258, Bldg. 17, NO.195, Sec. 4 Chung Hsing Rd., ChuTung Chen, Hsinchu, Taiwan 310, R.O.C
 TEL:886-3-5918012 FAX : 886-3-5825720

FCC ID : I4L-MS6855A

Report No. : ER04-09-021FRF

Page 32 of 56

The frequency spectrum above 1 GHz was investigated. All emissions not reported are much lower than the prescribed limits. Readings are both peak and average values.

Company	MICRO-STAR INT'L CO., LTD.	Test Date	2004/09/16
Product Name	Wireless 11g MiniPCI Card	Test By	Stan Peng
Model Name	MS-6855A	TEMP & Humidity	25.6°C , 83%

CH6 TX				Measurement Distance at 1m Horizontal polarity							
Freq. (MHz)	Reading (dBμV)	AF (dBμV)	Cable (dB)	Pre-amp (dB)	Dist (dB)	Filter (dB)	Level (dBμV/m)	Limit (dBμV/m)	Margin (dB)	Mark (P/Q/A)	Height (Meter)
2063.05	52.94	32.14	3.43	35.30	9.50	0.00	43.70	90.04	-46.33	P	1.00
2063.05	49.73	32.14	3.43	35.30	9.50	0.00	40.49	81.88	-41.38	A	1.00
2121.78	45.87	32.08	3.45	35.30	9.50	0.00	36.60	90.04	-53.43	P	1.00
2121.78	33.58	32.08	3.45	35.30	9.50	0.00	24.31	81.88	-57.56	A	1.00
2442.75	76.09	31.76	3.59	0.00	9.50	0.00	101.94	Fundamental Frequency		P	1.00
2442.75	67.32	31.76	3.59	0.00	9.50	0.00	93.17			A	1.00
* 4862.32	43.28	34.69	5.10	35.19	9.50	1.85	40.23	74.00	-33.77	P	1.00
* 4862.32	32.68	34.69	5.10	35.19	9.50	1.85	29.63	54.00	-24.37	A	1.00
9767.13	46.21	38.52	8.34	36.63	9.50	0.54	47.48	81.94	-34.46	P	1.00
9767.13	33.86	38.52	8.34	36.63	9.50	0.54	35.13	73.17	-38.04	A	1.00
* 12213.75	-----	-----	-----	-----	9.50	0.80	-----	-----	-----	-----	1.00
14656.50	-----	-----	-----	-----	9.50	0.57	-----	-----	-----	-----	1.00
17099.25	-----	-----	-----	-----	9.50	0.54	-----	-----	-----	-----	1.00
* 19542.00	-----	-----	-----	-----	9.50	2.24	-----	-----	-----	-----	1.00
21984.75	-----	-----	-----	-----	9.50	0.71	-----	-----	-----	-----	1.00
24427.50	-----	-----	-----	-----	9.50	2.42	-----	-----	-----	-----	1.00

Note :

- The measurement was searched to 10th harmonic, Remark “---” means that the emissions level is too low to be measured.
- AF: Antenna Factor, Cable: Cable Loss, Pre-Amp: Preamplifier gain, Filter: High Pass Filter Insertion Loss (3.5GHz)
- Spectrum analyzer setting P(Peak): RBW=1MHz, VBW=1MHz, A(Average): RBW=1MHz, VBW=10Hz
- Remark “*” means the Restricted band.
- Dist : correction to extra plate reading to 3m specification distance 1m measurement distance = -9.5dB
- The result basic equation calculation is as follow:
 $Level = Reading + AF + Cable - Preamp + Filter - Dist$, $Margin = Level - Limit$
- The other emission levels were very low against the limit
- The test limit distance is 3M limit.
- For 802.11g mode at 6Mbps. (Antenna 2)
- After an exploratory test, the emission of antenna (2) is higher than the emission of antenna (1). So only the antenna (2) data are recorded in final test report.



Ecom Sertech Corp.

Rm. 258, Bldg. 17, NO.195, Sec. 4 Chung Hsing Rd., ChuTung Chen, Hsinchu, Taiwan 310, R.O.C
 TEL:886-3-5918012 FAX : 886-3-5825720

FCC ID : I4L-MS6855A

Report No. : ER04-09-021FRF

Page 33 of 56

The frequency spectrum above 1 GHz was investigated. All emissions not reported are much lower than the prescribed limits. Readings are both peak and average values.

Company	MICRO-STAR INT' L CO., LTD.	Test Date	2004/09/16
Product Name	Wireless 11g MiniPCI Card	Test By	Stan Peng
Model Name	MS-6855A	TEMP & Humidity	25.6°C , 83%

CH6 TX				Measurement Distance at 1m Vertical polarity							
Freq. (MHz)	Reading (dBμV)	AF (dBμV)	Cable (dB)	Pre-amp (dB)	Dist (dB)	Filter (dB)	Level (dBμV/m)	Limit (dBμV/m)	Margin (dB)	Mark (P/Q/A)	Height (Meter)
2062.94	58.16	32.14	3.43	35.30	9.50	0.00	48.92	90.04	-41.11	P	1.00
2062.94	55.60	32.14	3.43	35.30	9.50	0.00	46.36	81.88	-35.51	A	1.00
2121.18	61.86	32.08	3.45	35.30	9.50	0.00	52.59	90.04	-37.44	P	1.00
2121.18	47.59	32.08	3.45	35.30	9.50	0.00	38.32	81.88	-43.55	A	1.00
2435.88	84.18	31.76	3.59	0.00	9.50	0.00	110.04	Fundamental Frequency		P	1.00
2435.88	76.02	31.76	3.59	0.00	9.50	0.00	101.88			A	1.00
* 4874.10	51.15	34.77	5.10	35.20	9.50	1.80	48.12	74.00	-25.88	P	1.00
* 4874.10	39.37	34.77	5.10	35.20	9.50	1.80	36.34	54.00	-17.66	A	1.00
9747.78	44.40	38.53	8.33	36.60	9.50	0.55	45.71	90.04	-44.33	P	1.00
9747.78	33.65	38.53	8.33	36.60	9.50	0.55	34.96	81.88	-46.92	A	1.00
* 12179.40	-----	-----	-----	-----	9.50	0.80	-----	-----	-----	-----	1.00
14615.28	-----	-----	-----	-----	9.50	0.61	-----	-----	-----	-----	1.00
17051.16	-----	-----	-----	-----	9.50	0.52	-----	-----	-----	-----	1.00
* 19487.04	-----	-----	-----	-----	9.50	2.18	-----	-----	-----	-----	1.00
21922.92	-----	-----	-----	-----	9.50	0.73	-----	-----	-----	-----	1.00
24358.80	-----	-----	-----	-----	9.50	2.53	-----	-----	-----	-----	1.00

Note :

- The measurement was searched to 10th harmonic, Remark “---” means that the emissions level is too low to be measured.
- AF: Antenna Factor, Cable: Cable Loss, Pre-Amp: Preamplifier gain, Filter: High Pass Filter Insertion Loss (3.5GHz)
- Spectrum analyzer setting P(Peak): RBW=1MHz, VBW=1MHz, A(Average): RBW=1MHz, VBW=10Hz
- Remark “*” means the Restricted band.
- Dist : correction to extra plate reading to 3m specification distance 1m measurement distance = -9.5dB
- The result basic equation calculation is as follow:
 $Level = Reading + AF + Cable - Preamp + Filter - Dist$, $Margin = Level - Limit$
- The other emission levels were very low against the limit
- The test limit distance is 3M limit.
- For 802.11g mode at 6Mbps. (Antenna 2)
- After an exploratory test, the emission of antenna (2) is higher than the emission of antenna (1). So only the antenna (2) data are recorded in final test report.



Ecom Sertech Corp.

Rm. 258, Bldg. 17, NO.195, Sec. 4 Chung Hsing Rd., ChuTung Chen, Hsinchu, Taiwan 310, R.O.C
 TEL:886-3-5918012 FAX : 886-3-5825720

FCC ID : I4L-MS6855A

Report No. : ER04-09-021FRF

Page 34 of 56

The frequency spectrum above 1 GHz was investigated. All emissions not reported are much lower than the prescribed limits. Readings are both peak and average values.

Company	MICRO-STAR INT' L CO., LTD.	Test Date	2004/09/16
Product Name	Wireless 11g MiniPCI Card	Test By	Stan Peng
Model Name	MS-6855A	TEMP & Humidity	25.6°C , 83%

CH11 TX				Measurement Distance at 1m Horizontal polarity							
Freq. (MHz)	Reading (dBμV)	AF (dBμV)	Cable (dB)	Pre-amp (dB)	Dist (dB)	Filter (dB)	Level (dBμV/m)	Limit (dBμV/m)	Margin (dB)	Mark (P/Q/A)	Height (Meter)
2087.94	55.41	32.11	3.44	35.30	9.50	0.00	46.16	80.09	-33.93	P	1.00
2087.94	52.54	32.11	3.44	35.30	9.50	0.00	43.29	72.19	-28.90	A	1.00
2466.95	74.25	31.73	3.61	0.00	9.50	0.00	100.09	Fundamental Frequency		P	1.00
2466.95	66.35	31.73	3.61	0.00	9.50	0.00	92.19			A	1.00
* 2483.60	36.10	31.72	3.61	0.00	9.50	0.00	61.93	74.00	-12.07	P	1.00
* 2483.60	15.90	31.72	3.61	0.00	9.50	0.00	41.73	54.00	-12.27	A	1.00
* 4924.00	44.13	35.10	5.12	35.24	9.50	1.60	41.21	74.00	-32.79	P	1.00
* 4924.00	33.14	35.10	5.12	35.24	9.50	1.60	30.22	54.00	-23.78	A	1.00
* 7386.02	45.90	39.75	6.84	35.62	9.50	2.00	49.37	74.00	-24.63	P	1.00
* 7386.02	34.56	39.75	6.84	35.62	9.50	2.00	38.03	54.00	-15.97	A	1.00
9848.01	45.52	38.52	8.37	36.76	9.50	0.49	46.63	80.09	-33.45	P	1.00
9848.01	34.20	38.52	8.37	36.76	9.50	0.49	35.31	72.19	-36.87	A	1.00
* 12334.75	-----	-----	-----	-----	9.50	0.80	-----	-----	-----	-----	1.00
14801.70	-----	-----	-----	-----	9.50	0.46	-----	-----	-----	-----	1.00
17268.65	-----	-----	-----	-----	9.50	0.61	-----	-----	-----	-----	1.00
* 19735.60	-----	-----	-----	-----	9.50	2.44	-----	-----	-----	-----	1.00
* 22202.55	-----	-----	-----	-----	9.50	0.70	-----	-----	-----	-----	1.00
24669.50	-----	-----	-----	-----	9.50	2.06	-----	-----	-----	-----	1.00

Note :

- The measurement was searched to 10th harmonic, Remark “---” means that the emissions level is too low to be measured.
- AF: Antenna Factor, Cable: Cable Loss, Pre-Amp: Preamplifier gain, Filter: High Pass Filter Insertion Loss (3.5GHz)
- Spectrum analyzer setting P(Peak): RBW=1MHz, VBW=1MHz, A(Average): RBW=1MHz, VBW=10Hz
- Remark “*” means the Restricted band.
- Dist : correction to extra plate reading to 3m specification distance 1m measurement distance = -9.5dB
- The result basic equation calculation is as follow:
 Level = Reading + AF + Cable - Preamp + Filter - Dist, Margin = Level - Limit
- The other emission levels were very low against the limit
- The test limit distance is 3M limit.
- For 802.11g mode at 6Mbps. (Antenna 2)
- After an exploratory test, the emission of antenna (2) is higher than the emission of antenna (1). So only the antenna (2) data are recorded in final test report.



Ecom Sertech Corp.

Rm. 258, Bldg. 17, NO.195, Sec. 4 Chung Hsing Rd., ChuTung Chen, Hsinchu, Taiwan 310, R.O.C
 TEL:886-3-5918012 FAX : 886-3-5825720

FCC ID : I4L-MS6855A

Report No. : ER04-09-021FRF

Page 35 of 56

The frequency spectrum above 1 GHz was investigated. All emissions not reported are much lower than the prescribed limits. Readings are both peak and average values.

Company	MICRO-STAR INT'L CO., LTD.	Test Date	2004/09/16
Product Name	Wireless 11g MiniPCI Card	Test By	Stan Peng
Model Name	MS-6855A	TEMP & Humidity	25.6°C , 83%

CH11 TX				Measurement Distance at 1m Vertical polarity							
Freq. (MHz)	Reading (dBμV)	AF (dBμV)	Cable (dB)	Pre-amp (dB)	Dist (dB)	Filter (dB)	Level (dBμV/m)	Limit (dBμV/m)	Margin (dB)	Mark (P/Q/A)	Height (Meter)
2087.99	61.58	32.11	3.44	35.30	9.50	0.00	52.33	88.66	-36.33	P	1.00
2087.99	59.76	32.11	3.44	35.30	9.50	0.00	50.51	81.03	-30.52	A	1.00
2466.87	82.82	31.73	3.61	0.00	9.50	0.00	108.66	Fundamental Frequency		P	1.00
2466.87	75.19	31.73	3.61	0.00	9.50	0.00	101.03			A	1.00
* 2483.60	42.40	31.72	3.61	0.00	9.50	0.00	68.23	74.00	-5.77	P	1.00
* 2483.60	23.00	31.72	3.61	0.00	9.50	0.00	48.83	54.00	-5.17	A	1.00
* 4924.78	53.38	35.10	5.12	35.24	9.50	1.60	50.46	74.00	-23.54	P	1.00
* 4924.78	41.90	35.10	5.12	35.24	9.50	1.60	38.98	54.00	-15.02	A	1.00
* 7386.11	45.12	39.75	6.84	35.62	9.50	2.00	48.59	74.00	-25.41	P	1.00
* 7386.11	34.46	39.75	6.84	35.62	9.50	2.00	37.93	54.00	-16.07	A	1.00
9848.98	45.85	38.52	8.37	36.76	9.50	0.49	46.96	88.66	-41.70	P	1.00
9848.98	34.91	38.52	8.37	36.76	9.50	0.49	36.02	81.03	-45.01	A	1.00
* 12334.35	-----	-----	-----	-----	9.50	0.80	-----	-----	-----	-----	1.00
14801.22	-----	-----	-----	-----	9.50	0.46	-----	-----	-----	-----	1.00
17268.09	-----	-----	-----	-----	9.50	0.61	-----	-----	-----	-----	1.00
* 19734.96	-----	-----	-----	-----	9.50	2.43	-----	-----	-----	-----	1.00
* 22201.83	-----	-----	-----	-----	9.50	0.70	-----	-----	-----	-----	1.00
24668.70	-----	-----	-----	-----	9.50	2.06	-----	-----	-----	-----	1.00

Note :

- The measurement was searched to 10th harmonic, Remark “---” means that the emissions level is too low to be measured.
- AF: Antenna Factor, Cable: Cable Loss, Pre-Amp: Preamplifier gain, Filter: High Pass Filter Insertion Loss (3.5GHz)
- Spectrum analyzer setting P(Peak): RBW=1MHz, VBW=1MHz, A(Average): RBW=1MHz, VBW=10Hz
- Remark “*” means the Restricted band.
- Dist : correction to extra plate reading to 3m specification distance 1m measurement distance = -9.5dB
- The result basic equation calculation is as follow:
 Level = Reading + AF + Cable - Preamp + Filter - Dist, Margin = Level - Limit
- The other emission levels were very low against the limit
- The test limit distance is 3M limit.
- For 802.11g mode at 6Mbps. (Antenna 2)
- After an exploratory test, the emission of antenna (2) is higher than the emission of antenna (1). So only the antenna (2) data are recorded in final test report.

3.7 Photos of Open Site





Ecom Sertech Corp.

Rm. 258, Bldg. 17, NO.195, Sec. 4 Chung Hsing Rd., ChuTung Chen, Hsinchu, Taiwan 310, R.O.C
TEL:886-3-5918012 FAX : 886-3-5825720

FCC ID : I4L-MS6855A

Report No. : ER04-09-021FRF

Page 37 of 56

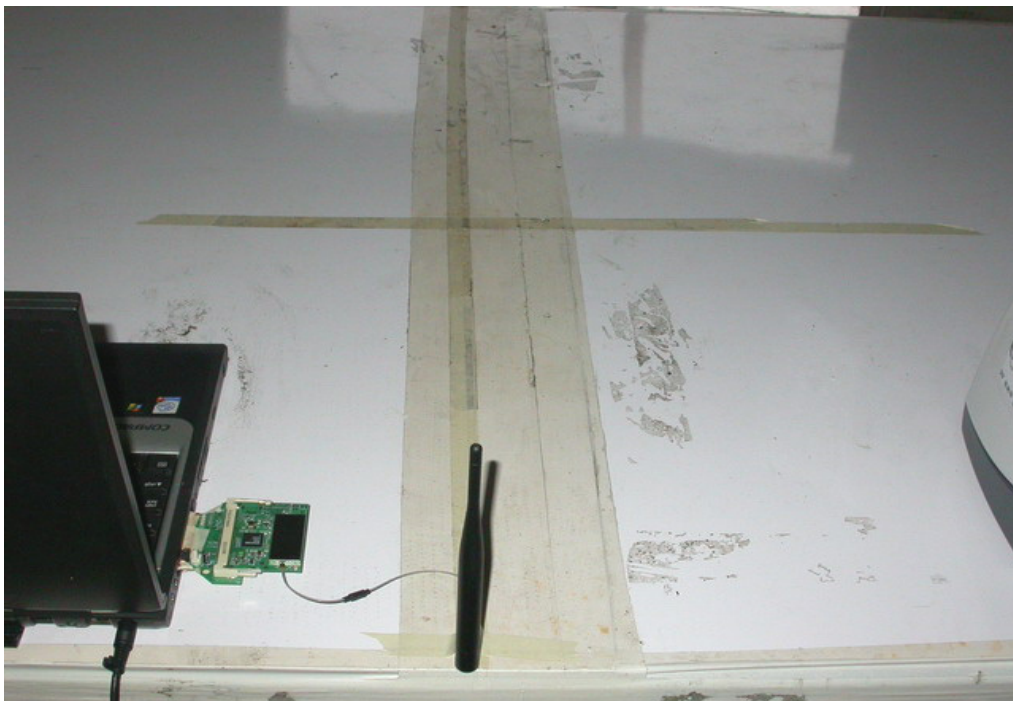



4. 6dB BANDWIDTH MEASUREMENT

4.1 Test Equipments

Description & Manufacturer	Model No.	Serial No.	Date Of Calibration
ROHDE & SCHWARZ SPECTRUM ANALYZER	FSEK30	835253/002	June 17, 2003

Note :

1. The measurement uncertainty is less than +/- 2.6dB, which is calculated as per the NAMAS document NIS81.
2. The calibration interval of the above test instruments is 12 months and the calibrations are traceable to NML/ROC and NIST/USA.

4.2 Test Setup

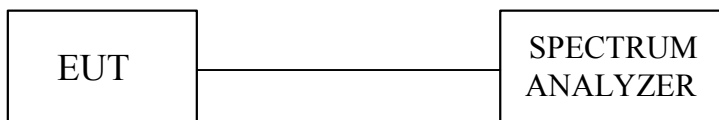

4.3 Limits of 6dB Bandwidth Measurement

The minimum of 6dB Bandwidth Measurement is >500KHz

4.4 Test Procedure

The transmitter output was connected to the spectrum analyzer through an attenuator. The bandwidth of the fundamental frequency was measured by spectrum analyzer with 100 KHz RBW and 10MHz VBW. The 6dB bandwidth is defined as the total spectrum the power of which is higher than peak power minus 6dB.

4.5 Uncertainty of Conducted Emission

The uncertainty of conducted emission is ± 200KHz.



4.6 Test Results

Input Power (System)	3.3VDC (From Notebook)	Environmental Conditions	24.5°C, 65%RH
Tested By	Stan Peng		

Channel	Channel Frequency (MHz)	6dB Bandwidth (MHz)	Minimum Limit (MHz)	Pass / Fail
1	2412	10.35	0.5	PASS
6	2437	11.05	0.5	PASS
11	2462	10.30	0.5	PASS

Note : 1. For 802.11b Mode (11Mbps)

Channel	Channel Frequency (MHz)	6dB Bandwidth (MHz)	Minimum Limit (MHz)	Pass / Fail
1	2412	16.50	0.5	PASS
6	2437	16.50	0.5	PASS
11	2462	16.50	0.5	PASS

Note : 1. For 802.11g Mode (6Mbps)



4.7 Photo of 6db Bandwidth Measurement

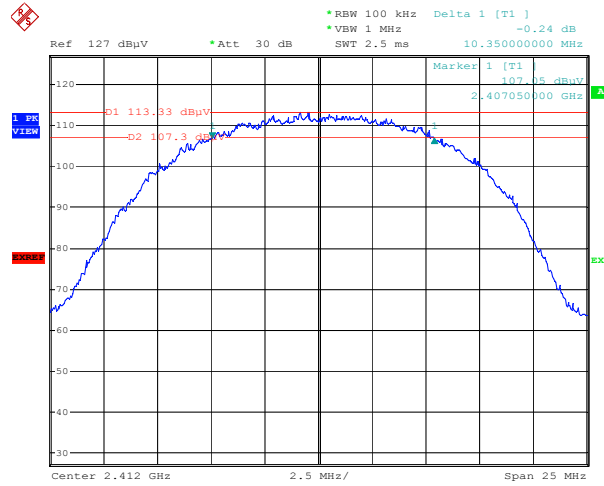

Date: 9.JUN.2004 13:54:58

Channel 1

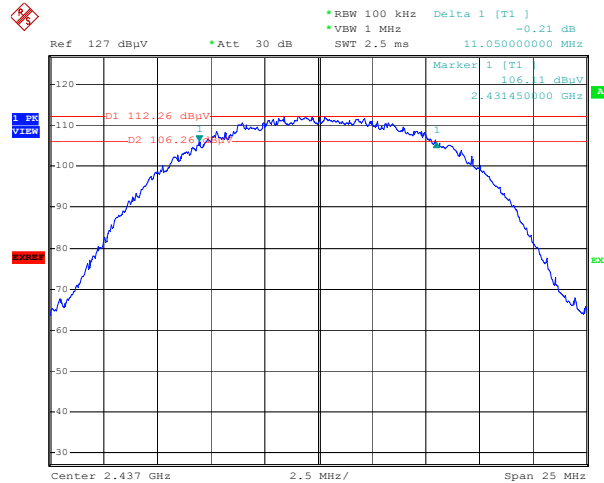

Date: 9.JUN.2004 13:57:38

Channel 6

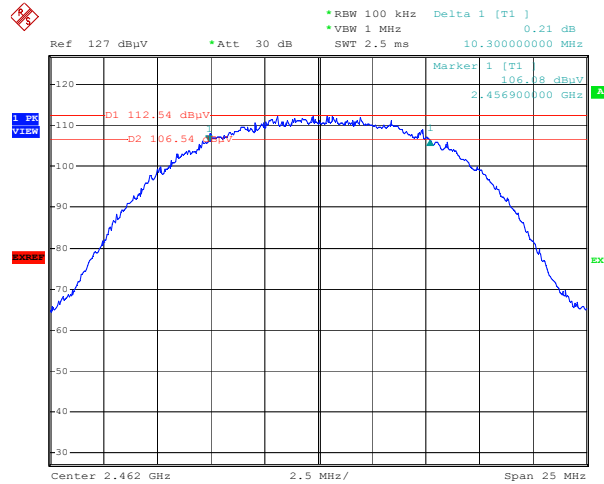

Date: 9.JUN.2004 13:59:48

Channel 11

Note: For 802.11b Mode



Ecom Sertech Corp.

Rm. 258, Bldg. 17, NO.195, Sec. 4 Chung Hsing Rd., ChuTung Chen, Hsinchu, Taiwan 310, R.O.C
TEL:886-3-5918012 FAX : 886-3-5825720

FCC ID : I4L-MS6855A

Report No. : ER04-09-021FRF

Page 41 of 56

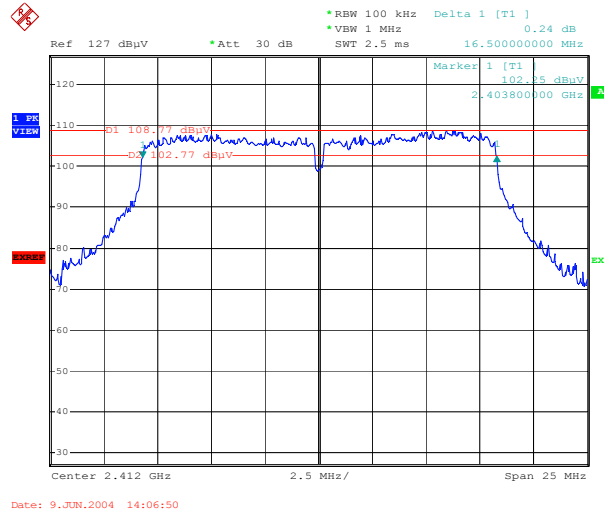

Channel 1

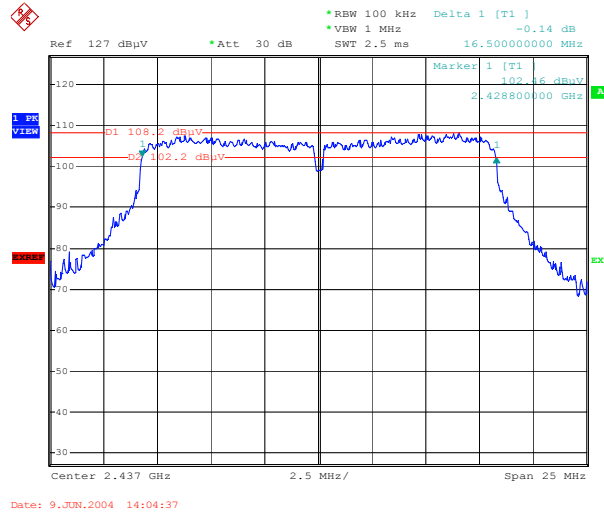

Channel 6

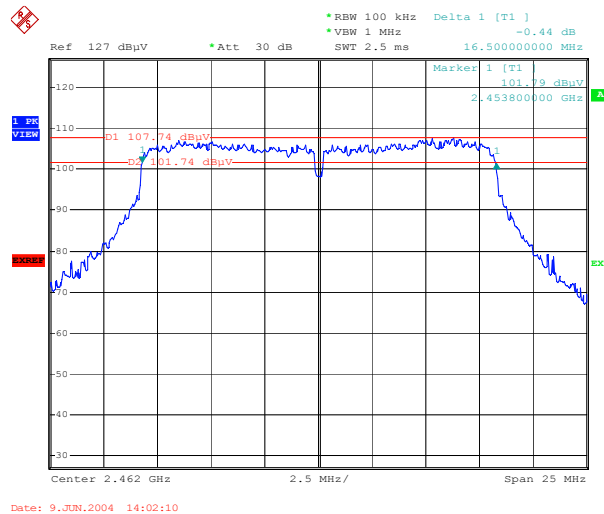

Channel 11

Note: For 802.11g Mode

5. MAXIMUM PEAK OUTPUT POWER

5.1 Test Equipments

Description & Manufacturer	Model No.	Serial No.	Date Of Calibration
ROHDE & SCHWARZ SPECTRUM ANALYZER	FSEK30	835253/002	June 17, 2004
Agilent ATTENUATOR	8491B	57321	CAL. ON USE
ANRITSU Peak Power Meter	ML2487A MAL2491A	6K00001783 030982	February 10, 2004

Note :

1. The measurement uncertainty is less than +/- 2.6dB, which is calculated as per the NAMAS document NIS81.
2. The calibration interval of the above test instruments is 12 months and the calibrations are traceable to NML/ROC and NIST/USA.

5.2 Test Setup

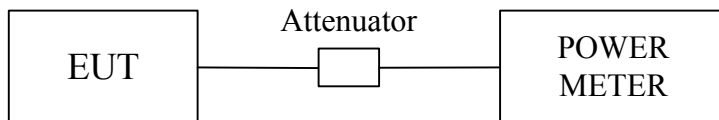

5.3 Limits of Maximum Peak Output Power

The Maximum Peak Output Power Measurement is 30dBm.



5.4 Test Procedure

The RF power output was measured with a Power meter connected to the RF Antenna connector (conducted measurement) while EUT was operating in transmit mode at the appropriate center frequency.

5.5 Uncertainty of Conducted Emission

The uncertainty of conducted emission is $\pm 1.82\text{dB}$.

5.6 Test Results

Input Power (System)	3.3VDC (From Notebook)	Environmental Conditions	24.5°C, 65%RH
Tested By	Stan Peng		

Channel	Channel Frequency (MHz)	Average Power Output (dBm)	Peak Power Output (dBm)	Peak Power Limit (dBm)	Pass / Fail
1	2412	15.88	17.91	30	PASS
6	2437	14.75	17.35	30	PASS
11	2462	14.36	16.97	30	PASS

- Note : 1. For 802.11b mode.
 2. At final test to get the worst-case emission at 11Mbps.
 3. Cable loss = 0.5dB, Attenuator = 10dB.
 4. The results are calculated as the following equation :
 Average Power Output = Average Power Reading + Cable loss + Attenuator
 Peak Power Output = Peak Power Reading + Cable loss + Attenuator

Channel	Channel Frequency (MHz)	Average Power Output (dBm)	Peak Power Output (dBm)	Peak Power Limit (dBm)	Pass / Fail
1	2412	14.66	16.61	30	PASS
6	2437	13.74	15.82	30	PASS
11	2462	13.51	15.61	30	PASS

- Note : 1. For 802.11g mode.
 2. At final test to get the worst-case emission at 6Mbps.
 3. Cable loss = 0.5dB, Attenuator = 10dB.
 4. The results are calculated as the following equation :
 Average Power Output = Average Power Reading + Cable loss + Attenuator
 Peak Power Output = Peak Power Reading + Cable loss + Attenuator



6. POWER SPECTRAL DENSITY MEASUREMENT

6.1 Test Equipments

Description & Manufacturer	Model No.	Serial No.	Date Of Calibration
ROHDE & SCHWARZ SPECTRUM ANALYZER	FSEK30	835253/002	June 17, 2003

Note :

1. The measurement uncertainty is less than +/- 2.6dB, which is calculated as per the NAMAS document NIS81.
2. The calibration interval of the above test instruments is 12 months and the calibrations are traceable to NML/ROC and NIST/USA.

6.2 Test Setup

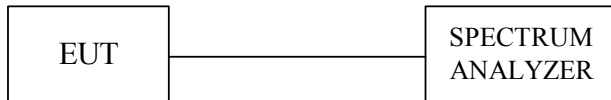

6.3 Limits of Power Spectral Density Measurement

The Maximum Power Spectral Density Measurement is 8dBm/3KHz.



6.4 Test Procedure

The transmitter output was connected to the spectrum analyzer through an attenuator, the bandwidth of the fundamental frequency was measured with the spectrum analyzer using 3KHz RBW and 30KHz VBW, set sweep time=span / 3KHz.

The power spectral density was measured and recorded.

The sweep time is allowed to be longer than span / 3KHz for a full response of the mixer in the spectrum analyzer.

6.5 Uncertainty of Conducted Emission

The uncertainty of conducted emission is ± 1.82 dB.

6.6 Test Results

Input Power (System)	3.3VDC (From Notebook)	Environmental Conditions	16°C, 84%RH
Tested By	Stan Peng		

Channel	Channel Frequency (MHz)	Final RF Power Level in 3KHz BW (dBm)	Maxmum Limit (dBm)	Pass / Fail
1	2412	-7.99	8	PASS
6	2437	-9.09	8	PASS
11	2462	-9.39	8	PASS

Note: For 11Mbps (802.11b mode) at finial test to get the worst-case emission at 11Mbps.

Channel	Channel Frequency (MHz)	Final RF Power Level in 3KHz BW (dBm)	Maxmum Limit (dBm)	Pass / Fail
1	2412	-9.28	8	PASS
6	2437	-9.02	8	PASS
11	2462	-12.34	8	PASS

Note: For 54Mbps (802.11g mode) at finial test to get the worst-case emission at 6Mbps.



Ecom Sertech Corp.

Rm. 258, Bldg. 17, NO.195, Sec. 4 Chung Hsing Rd., Chu Tung Chen, Hsinchu, Taiwan 310, R.O.C
TEL: 886-3-5918012 FAX: 886-3-5825720

FCC ID : I4L-MS6855A

Report No. : ER04-09-021FRF

Page 46 of 56

6.7 Photo of Power Spectral Density Measurement

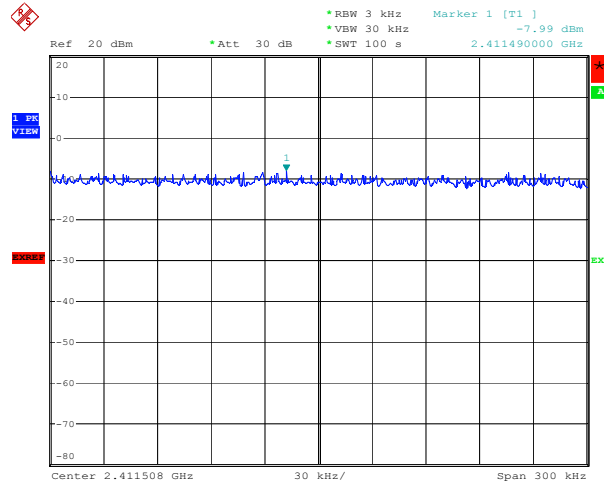

Channel 1

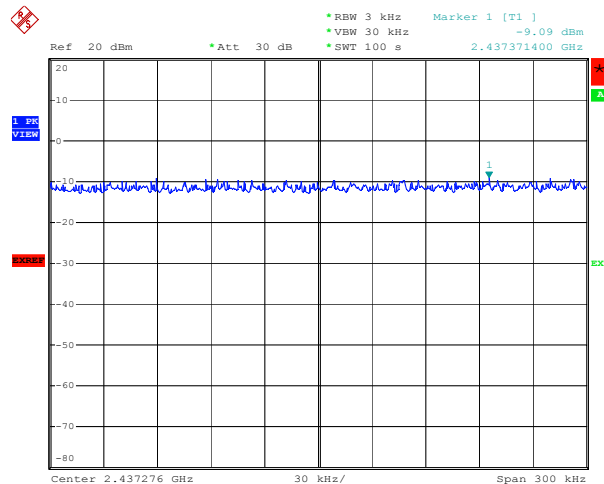

Channel 6

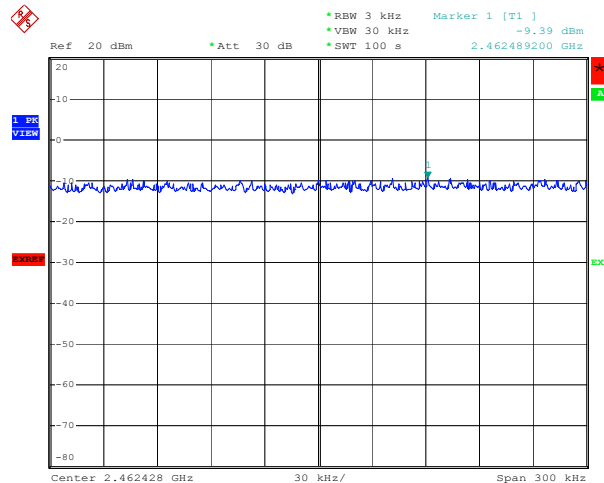

Channel 11

Note: For 802.11b Mode



Ecom Sertech Corp.

Rm. 258, Bldg. 17, NO.195, Sec. 4 Chung Hsing Rd., ChuTung Chen, Hsinchu, Taiwan 310, R.O.C
TEL:886-3-5918012 FAX: 886-3-5825720

FCC ID : I4L-MS6855A

Report No. : ER04-09-021FRF

Page 47 of 56

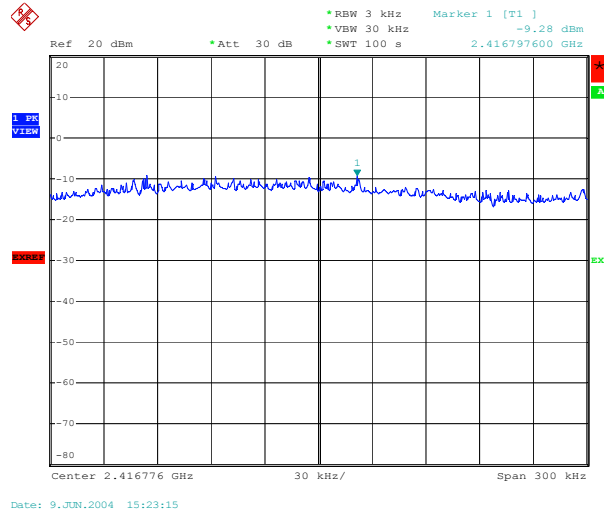

Channel 1

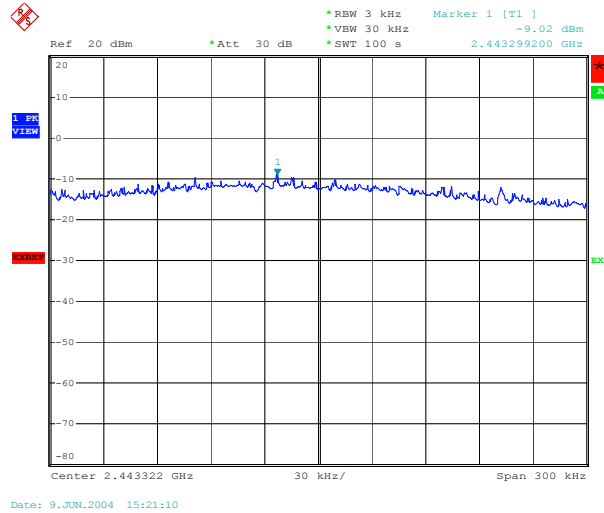

Channel 6

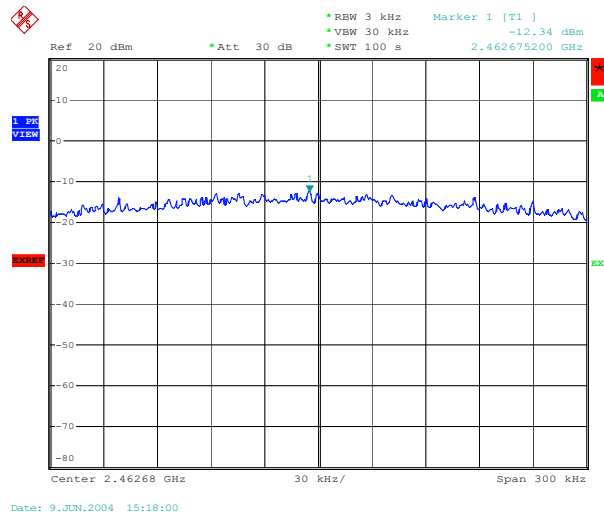

Channel 11

Note: For 802.11g Mode

7. BAND EDGE MEASUREMENT

7.1 Test Equipments

Description & Manufacturer	Model No.	Serial No.	Date Of Calibration
ROHDE & SCHWARZ SPECTRUM ANALYZER	FSEK30	835253/002	June 17, 2004

Note :

1. The measurement uncertainty is less than +/- 2.6dB, which is calculated as per the NAMAS document NIS81.
2. The calibration interval of the above test instruments is 12 months and the calibrations are traceable to NML/ROC and NIST/USA.

7.2 Test Setup

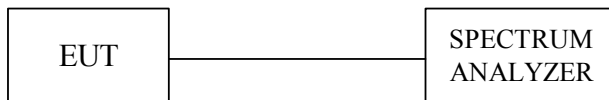

7.3 Limits of Band Edge Emissions Measurement

1. Below -20dB of the highest emission level in operating band.
2. Fall in the restricted bands listed in section 15.205. The maximum permitted average field strength is listed in section 15.209.

7.4 Test Procedure

The transmitter output was connected to the spectrum analyzer via a low lose cable. Set both RBW and VBW of spectrum analyzer with suitable frequency span including 100KHz bandwidth from band edge. The band edges was measured and recorded.

7.5 Uncertainty of Conducted Emission

The uncertainty of conducted emission is ± 1.82 dB.



7.6 Test Results

A. Conducted

Refer to 7.7 photo of out band Emission measurement

B. Radiated

Input Power (System)	3.3VDC (From Notebook)	Environmental Conditions	24.5°C, 65%RH
Tested By	Stan Peng		

For 802.11b mode

Refer to the section 3.6, the measured radiated band edge emissions are listed below :

Band edge Frequency (MHz)		Measured radiated band edge field strength (dBuV/m)		Radiated band edge field strength limit (dBuV/m)		Test result
		Horizontal	Vertical	Horizontal	Vertical	
2399.90	PK	58.08	67.58	83.54	92.54	PASS
	AV	47.88	56.88	77.04	86.01	
2483.50	PK	53.73	61.93	74.00	74.00	PASS
	AV	40.93	48.43	54.00	54.00	

For 802.11g mode

Refer to the section 3.6, the measured radiated band edge emissions are listed below :

Band edge Frequency (MHz)		Measured radiated band edge field strength (dBuV/m)		Radiated band edge field strength limit (dBuV/m)		Test result
		Horizontal	Vertical	Horizontal	Vertical	
2399.90	PK	74.28	82.38	83.08	92.61	PASS
	AV	51.58	61.68	74.65	84.33	
2483.50	PK	62.33	67.43	74.00	74.00	PASS
	AV	41.83	48.83	54.00	54.00	

Note :

1. Radiated band edge field strength is measured with measurement procedure ANSI C63.4-2001.
2. For Antenna (2).



7.7 Photo of Band edge Measurement

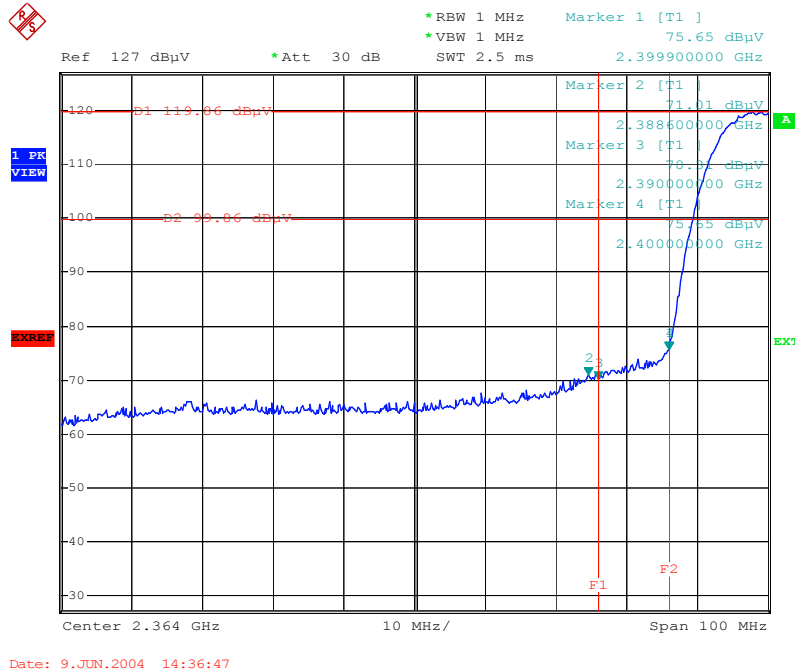

Lower Band edge (Peak)

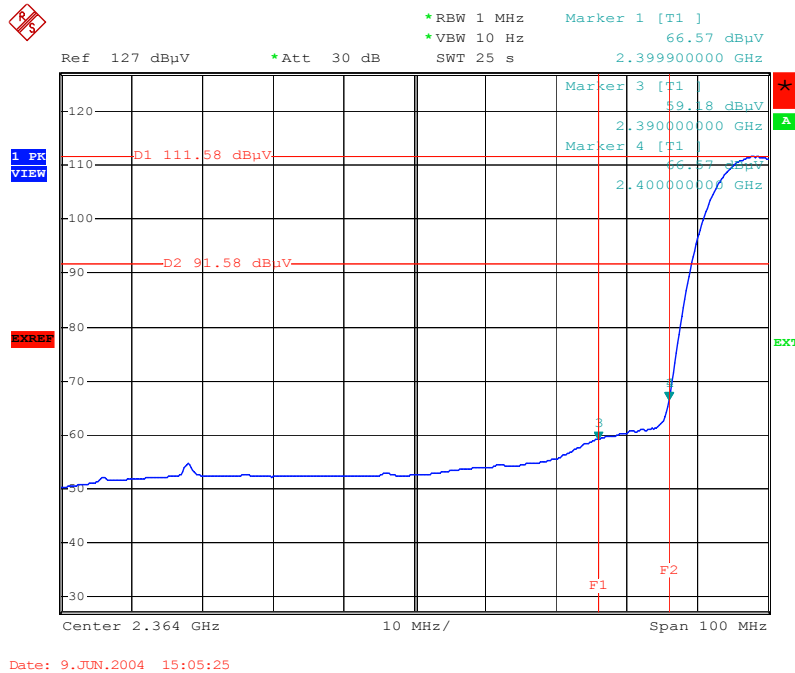

Lower Band edge (Average)

Note: For 802.11b Mode



Ecom Sertech Corp.

Rm. 258, Bldg. 17, NO.195, Sec. 4 Chung Hsing Rd., ChuTung Chen, Hsinchu, Taiwan 310, R.O.C
TEL:886-3-5918012 FAX : 886-3-5825720

FCC ID : I4L-MS6855A

Report No. : ER04-09-021FRF

Page 51 of 56

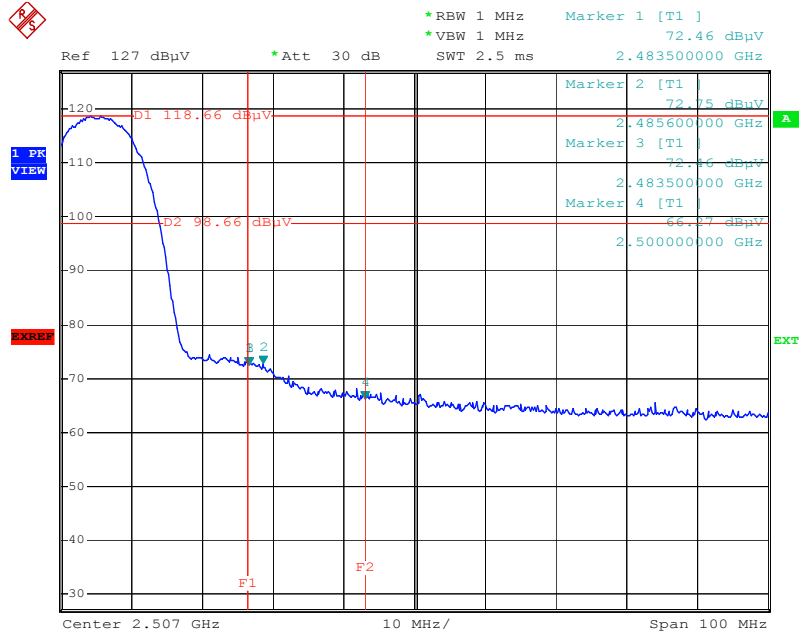

Higher Band edge (Peak)

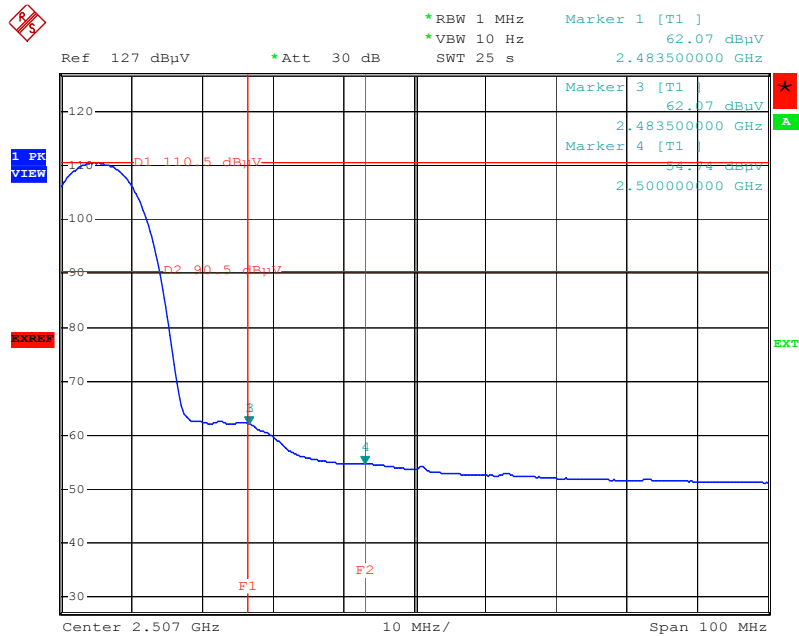

Higher Band edge (Average)

Note: For 802.11b Mode



Ecom Sertech Corp.

Rm. 258, Bldg. 17, NO.195, Sec. 4 Chung Hsing Rd., ChuTung Chen, Hsinchu, Taiwan 310, R.O.C
TEL:886-3-5918012 FAX : 886-3-5825720

FCC ID : I4L-MS6855A

Report No. : ER04-09-021FRF

Page 52 of 56

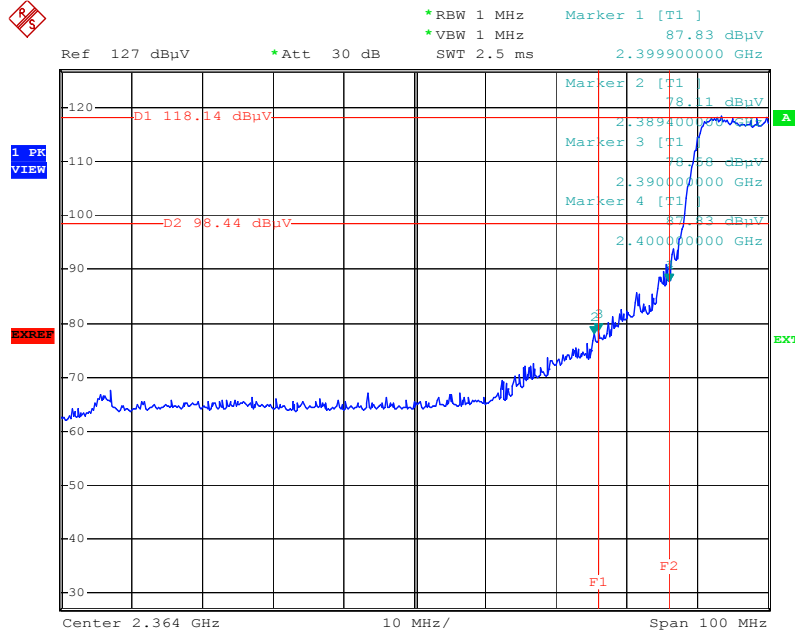

Date: 9.JUN.2004 14:18:10

Lower Band edge (Peak)

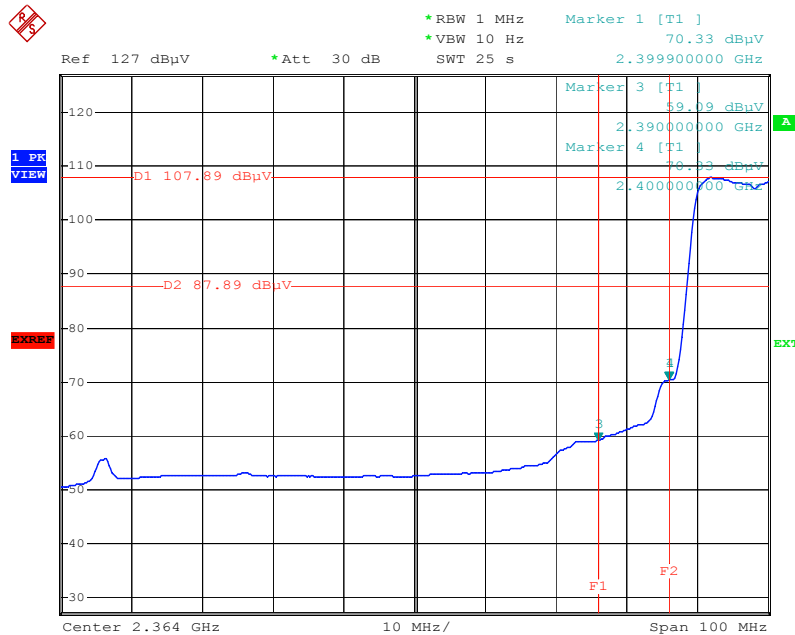

Date: 9.JUN.2004 15:03:01

Lower Band edge (Average)

Note: For 802.11g Mode



Ecom Sertech Corp.

Rm. 258, Bldg. 17, NO.195, Sec. 4 Chung Hsing Rd., ChuTung Chen, Hsinchu, Taiwan 310, R.O.C
TEL:886-3-5918012 FAX : 886-3-5825720

FCC ID : I4L-MS6855A

Report No. : ER04-09-021FRF

Page 53 of 56

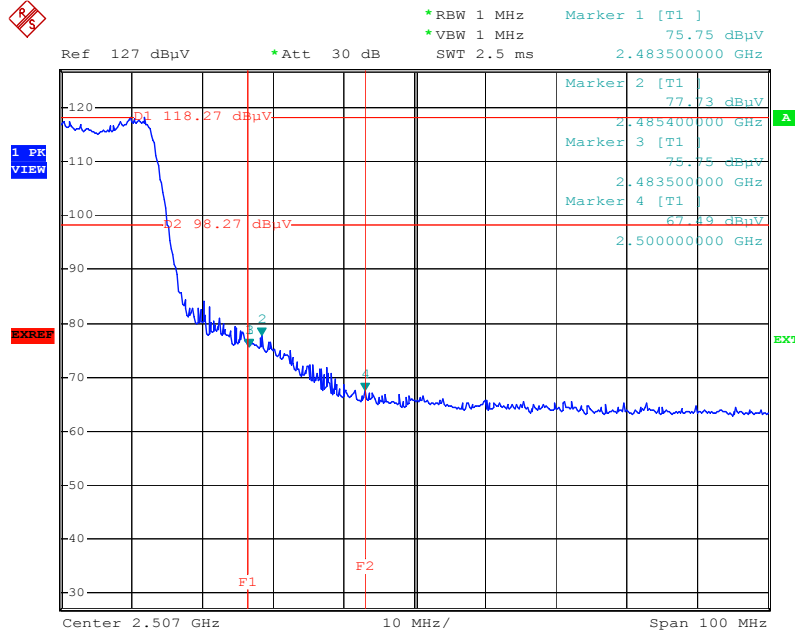

Date: 9.JUN.2004 15:12:54

Higher Band edge (Peak)

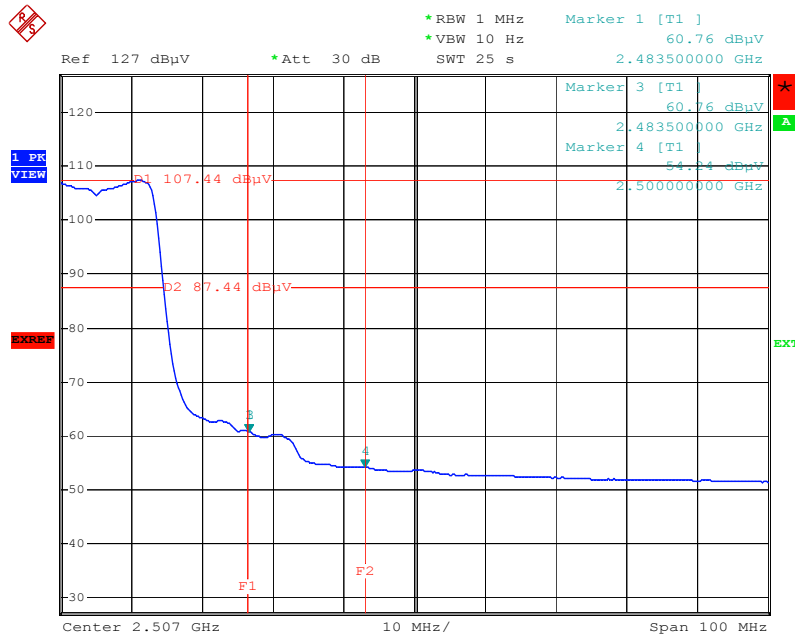

Date: 9.JUN.2004 14:58:13

Higher Band edge (Average)

Note: For 802.11g Mode



8. ANTENNA REQUIREMENT

8.1 Standard Applicable

For intentional device, according to FCC 47 CFR Section 15.203, an intentional radiator shall be designed to ensure that no antenna other than that furnished by the responsible party shall be used with the device.

And according to FCC 47 CFR Section 15.247 (b), if transmitting antennas of directional gain greater than 6dBi are used, the power shall be reduced by the amount in dB that the directional gain of the antenna exceeds 6dBi.

8.2 Antenna Connected Construction

The antenna used in this product is Dipole antenna.

Antenna (1) : Draytek 3dBi. The internal connector is Hirose and the external connector is reverse SMA.

Antenna (2) : Fiberlogic 5dBi. The internal connector is Hirose and the external connector is reverse SMA.



9. RF EXPOSURE EVALUATION

According to FCC 1.1310 : The criteria listed in the following table shall be used to evaluate the environment impact of human exposure to radio frequency (RF) radiation as specified in 1.1307(b)
LIMITS FOR MAXIMUM PERMISSIBLE EXPOSURE (MPE)

Frequency Range (MHz)	Electric Field Strength (V/m)	Magnetic Field Strength (A/m)	Power Density (mW/cm ²)	Average Time
(A) Limits for Occupational / Control Exposures				
300-1,500	--	--	F/300	6
1,500-100,000	--	--	5	6
(B) Limits for General Population / Uncontrol Exposures				
300-1,500	--	--	F/1500	6
1,500-100,000	--	--	1	30

9.1 Friis Formula

Friis transmission formula : $Pd = (Pout * G) / (4 * \pi * r^2)$

Where

Pd = power density in mW/cm²

Pout = output power to antenna in mW

G = gain of antenna in linear scale

Pi = 3.1416

R = distance between observation point and center of the radiator in cm

Pd is the limit of MPE, 1 mW/cm². If we know the maximum gain of the antenna and the total power input to the antenna, through the calculation, we will know the distance where the MPE limit is reached.

9.2 EUT Operating Condition

A software provided by client enabled the EUT to transmit and receive data at lowest, middle and highest channel individually.



9.3 Test Result of RF Exposure Evaluation

Test Item : RF Exposure Evaluation Data

Test Mode : Normal Operation

9.3.1 Antenna Gain

The antennas used in this product is Dipole antenna. The maximum Gain of this antenna is 5dBi.

9.3.2 Output Power into Antenna & RF Exposure Evaluation Distance

For Antenna gain : 5dBi, Dipole Antenna

Channel	Channel Frequency (MHz)	Output Antenna Power to Antenna (dBm) e.i.r.p.	Power Density at 20cm (mW/cm ²)	LIMITS (mW/cm ²)
CH1	2412.00	20.38	0.021714	1
CH6	2437.00	19.25	0.016739	1
CH11	2462.00	19.36	0.017168	1

Note :

1. For 802.11b mode (11Mbps).
2. The power density Pd (4th column) at a distance of 20cm calculated from the Friis transmission formula is far below the limit of 1 mW/cm² . The EUT is classified as mobile product. So, RF exposure limit warning or SAR test are not required.

Channel	Channel Frequency (MHz)	Output Antenna Power to Antenna (dBm) e.i.r.p.	Power Density at 20cm (mW/cm ²)	LIMITS (mW/cm ²)
CH1	2412.00	19.16	0.016396	1
CH6	2437.00	18.24	0.013266	1
CH11	2462.00	18.01	0.012581	1

Note :

1. For 802.11g mode (6Mbps).
2. The power density Pd (4th column) at a distance of 20cm calculated from the Friis transmission formula is far below the limit of 1 mW/cm² . The EUT is classified as mobile product. So, RF exposure limit warning or SAR test are not required.