



Spectrum Research & Testing Lab., Inc.
No. 101-10, Ling 8,
Shan-Tong Li, Chung-Li
City, Taoyuan, Taiwan

TEST REPORT

Reference No.:A03121108
Report No.:FCCA03121108
FCC ID:I4L-MS6850
Page:1 of 45
Date: Dec. 31, 2003

Product Name: Bluetooth Mouse
Model Number: MS-6850
Marketing Name: BTMS
Applicant: MICRO-STAR INT'L CO., LTD.
No 69, Li-De St, Jung-He City, Taipei Hsien, Taiwan
Date of Receipt: Dec. 11, 2003
Finished date of Test: Dec. 30, 2003
Applicable Standards: 47 CFR Part 15, Subpart C
ANSI C63.4:1992

We, **Spectrum Research & Testing Laboratory Inc.**, hereby certify that one sample of the above was tested in our laboratory with positive results according to the above-mentioned standards. The records in the report are an accurate account of the results. Details of the results are given in the subsequent pages of this report.

Checked By : *Sunyou Chen* , Date: *12/31/2003*
(Sunyou Chen)

Approved By : *J Johnson* , Date: *12/31/2003*
(Johnson Ho, Director)

NVLAQ[®]

Lab Code: 200099-0



TABLE OF CONTENTS

1. DOCUMENT POLICY AND TEST STATEMENT.....	4
1.1 DOCUMENT POLICY	4
1.2 TEST STATEMENT	4
2. DESCRIPTION OF EUT AND TEST MODE	5
2.1 GENERAL DESCRIPTION OF EUT	5
2.2 DESCRIPTION OF SUPPORT UNIT.....	6
2.3 DESCRIPTION OF TEST MODE	6
3. DESCRIPTION OF APPLIED STANDARDS.....	7
4.1 CONDUCTED EMISSION TEST	8
4.1.1 LIMIT	8
4.1.2 TEST EQUIPMENT	8
4.1.3 TEST SETUP	9
4.1.4 TEST PROCEDURE	9
4.1.5 EUT OPERATING CONDITION	9
4.1.6 TEST RESULT	10
4.2 CHANNEL SEPARATION TEST	11
4.2.1 LIMIT	11
4.2.2 TEST EQUIPMENT	11
4.2.3 TEST SET-UP.....	11
4.2.4 TEST PROCEDURE.....	11
4.2.5 EUT OPERATING CONDITION.....	11
4.2.6 TEST RESULT.....	12
4.3 20DB BANDWIDTH.....	14
4.3.1 LIMIT	14
4.3.2 TEST EQUIPMENT	14
4.3.3 TEST SET-UP.....	14
4.3.4 TEST PROCEDURE.....	14
4.3.5 EUT OPERATING CONDITION.....	14
4.3.6 TEST RESULT.....	15
4.4 QUANTITY OF HOPPING CHANNEL TEST	17
4.4.1 LIMIT	17
4.4.2 TEST EQUIPMENT	17
4.4.3 TEST SET-UP.....	17
4.4.4 TEST PROCEDURE.....	17
4.4.5 EUT OPERATING CONDITION.....	17
4.4.6 TEST RESULT.....	18
4.5 TIME OF OCCUPANCY (DWELL TIME).....	19
4.5.1 LIMIT	19
4.5.2 TEST EQUIPMENT	19
4.5.3 TEST SET-UP.....	19
4.5.4 TEST PROCEDURE.....	19



TEST REPORT

4.5.5	EUT OPERATING CONDITION	19
4.5.6	TEST RESULT	20
4.6	PEAK POWER TEST	24
4.6.1	LIMIT	24
4.6.2	TEST EQUIPMENT	24
4.6.3	TEST SET-UP	25
4.6.4	TEST PROCEDURE	25
4.6.5	EUT OPERATING CONDITION	25
4.6.6	TEST RESULT	25
4.7	BAND EDGE TEST	28
4.7.1	LIMIT	28
4.7.2	TEST EQUIPMENT	29
4.7.3	TEST SET-UP	30
4.7.4	TEST PROCEDURE	31
4.7.5	EUT OPERATING CONDITION	31
4.7.6	TEST RESULT	31
4.8	SPURIOUS RADIATED EMISSION TEST	33
4.8.1	LIMIT	33
4.8.2	TEST EQUIPMENT	34
4.8.3	TEST SET-UP	35
4.8.4	TEST PROCEDURE	36
4.8.5	EUT OPERATING CONDITION	36
4.8.6	TEST RESULT	37
5.	ANTENNA APPLICATION	41
5.1	ANTENNA REQUIREMENT	41
5.2	RESULT	41
6.	PHOTOS OF TESTING	42
7.	TERMS OF ABRIVATION	45



**Spectrum Research &
Testing Lab., Inc.**
No. 101-10, Ling 8,
Shan-Tong Li, Chung-Li
City, Taoyuan, Taiwan

TEST REPORT

Reference No.:A03121108
Report No.:FCCA03121108
FCC ID:I4L-MS6850
Page:4 of 45
Date:Dec. 31, 2003

1. DOCUMENT POLICY AND TEST STATEMENT

1.1 DOCUMENT POLICY

- The report shall not be reproduced except in full, without the written approval of SRT Lab, Inc.

1.2 TEST STATEMENT

- The test results in the report apply only to the unit tested by SRT Lab.
- There was no deviation from the requirements of test standards during the test.
- AC power source, 120 VAC/60 Hz, was used during the test.



Spectrum Research & Testing Lab., Inc.
No. 101-10, Ling 8,
Shan-Tong Li, Chung-Li
City, Taoyuan, Taiwan

TEST REPORT

Reference No.:A03121108
Report No.:FCCA03121108
FCC ID:I4L-MS6850
Page:5 of 45
Date:Dec. 31, 2003

2. DESCRIPTION OF EUT AND TEST MODE

2.1 GENERAL DESCRIPTION OF EUT

PRODUCT	Bluetooth Mouse
MODEL NO.	MS-6850
POWER SUPPLY	2.7~3.3
CABLE	N/A
I/O PORT	I2C、 SPI and USB
FREQUENCY BAND	2400~2483.5MHz
CARRIER FREQUENCY	CH0: 2402MHz~CH78: 2480MHz
NUMBER OF CHANNEL	79
RATED RF OUTPUT POWER	2mW (0~4dBm)
ANTENNA TYPE	External

NOTE :

For more detailed information, please refer to the EUT's specification or user's manual provided by manufacturer.



2.2 DESCRIPTION OF SUPPORT UNIT

The transmitter part of EUT was tested with a PC system and configured by the requirement of ANSI C63.4. All interface ports were connected to the appropriate support units via specific cables. The support units and cables are listed below.

NO	DEVICE	BRAND	MODEL #	FCC ID / DOC	CABLE
1.	Notebook	DELL	PP01L	DOC	1.5m unshielded power cord
2	PRINTER	EPSON	STYLUS C20SX	DOC	1.5m unshielded power cord 1.2m shielded data cable
3	MODEM	ACEEX	DM-1414	DOC	1.5m unshielded power cord 1.2m shielded data cable
4	DONGLE	MSI	N/A	N/A	1.2m unshielded power cord 1.2m unshielded data cable
5	MONITOR	SAMSUNG	PG171S	DOC	1.5m unshielded power cord 1.2m shielded data cable

NOTE : For the actual test configuration, please refer to the photos of testing.

2.3 DESCRIPTION OF TEST MODE

This EUT is a FHSS system , we use BlueTest to control the EUT withRS232, Let EUT hopping on and transmit at every channel with highest power, Only output power use conducted method, others are using radiated method. After Sirfdemo330R1 send the command to EUT, it can be removed, and the EUT keep hopping.79 channels are provided by EUT. The 3 channels of lower, medium and higher were chosen for test.

Channel	Frequency(MHz)
0	2402
39	2441
78	2480

NOTE :

1. Below 1 GHz, the channel 0, 39, and 78 were pre-tested in chamber. The channel 78, worst case one, was chosen for conducted and radiated emission test.
2. Above 1 GHz, the channel 0, 39 and 78 were tested individually



**Spectrum Research &
Testing Lab., Inc.**
No. 101-10, Ling 8,
Shan-Tong Li, Chung-Li
City, Taoyuan, Taiwan

TEST REPORT

Reference No.:A03121108
Report No.:FCCA03121108
FCC ID:I4L-MS6850
Page:7 of 45
Date:Dec. 31, 2003

3. DESCRIPTION OF APPLIED STANDARDS

The EUT is a kind of wireless product and to be connected with a PC system for normal use. According to the specifications provided by the applicant, it must comply with the requirements of the following standards:

47 CFR Part 15, Subpart C

ANSI C63.4:1992

Public DA00-705 (March 2000)

All tests have been performed and recorded as the above standards.



4 TECHNICAL CHARACTERISTICS TEST

4.1 CONDUCTED EMISSION TEST

4.1.1 LIMIT

Frequency (MHz)	Class A (dB μ V)		Class B (dB μ V)	
	Quasi-peak	Average	Quasi-peak	Average
0.15 - 0.5	79	66	66 - 56	56 - 46
0.50 - 5.0	73	60	56	46
5.0 - 30.0	73	60	60	50

NOTE :

1. The lower limit shall apply at the transition frequencies.
2. The limit decreases in line with the logarithm of the frequency in the range of 0.15 to 0.50 MHz.

4.1.2 TEST EQUIPMENT

The following test equipment was used for the test:

EQUIPMENT/ FACILITIES	SPECIFICATIONS	MANUFACTURER	MODEL#/ SERIAL#	DUE DATE OF CAL. & CAL. CENTER
EMI TEST RECEIVER	9 kHz TO 30 MHz	ROHDE & SCHWARZ	ESHS30/ 826003/008	AUG. 2004 R&S
LISN (for EUT)	50 μ H, 50 ohm	SOLAR ELECTRONICS	8012-50-R-24-BNC / 924839	JUN. 2004 ETC
LISN (for Peripheral)	50 μ H, 50 ohm	SOLAR ELECTRONICS	9252-50-R-24-BNC / 951318	JUN. 2004 ETC
50 ohm TERMINATOR	50 ohm	HP	11593A/ 2	MAY 2004 ETC
COAXIAL CABLE	3m	SUNCITY	J400/ 3M	AUG. 2004 SRT
ISOLATION TRANSFORMER	N/A	APC	AFC-11015/ F102040016	N/A
FILTER	2 LINE, 30A	FIL.COIL	FC-943/ 771	N/A
GROUND PLANE	2.3M (H) x 2.4M (W)	SRT	N/A	APR. 2004 SRT
GROUND PLANE	2.4M (H) x 2.4M (W)	SRT	N/A	APR. 2004 SRT

NOTE : The calibration interval of the above test equipment is one year and the calibrations are traceable to NML/ROC and NIST/USA.



4.1.3 TEST SETUP

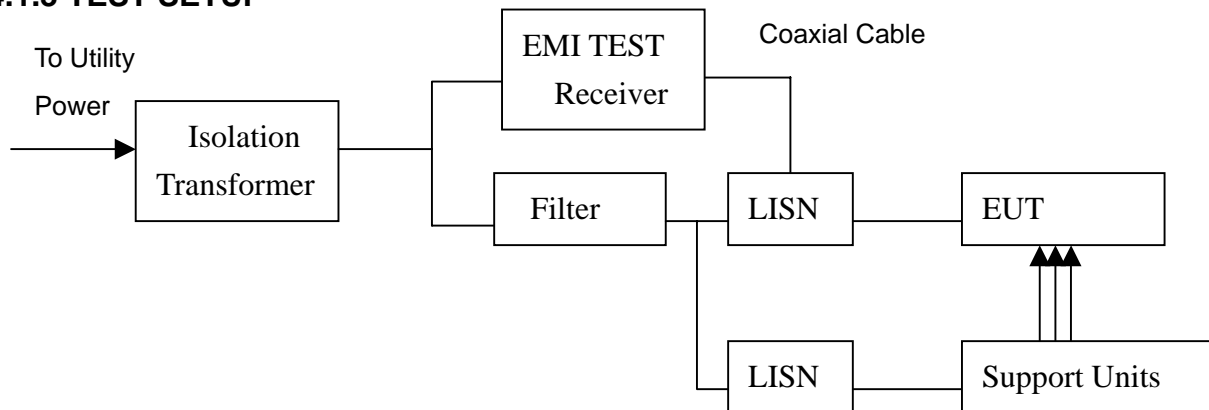

NOTE :

1. The EUT was put on a wooden table with 0.8m height above ground plane, and 0.4m away from reference ground plane (> 2mx2m).
2. For the actual test configuration, please refer to the photos of testing.

4.1.4 TEST PROCEDURE

The EUT was tested according to the requirement of ANSI C63.4 and CISPR 22. The frequency spectrum from 0.15 MHz to 30 MHz was investigated. The LISN used was 50 ohm/50µH as specified. All readings were quasi-peak and average values with 10 kHz resolution bandwidth of the test receiver. The EUT system was operated in all typical methods by users. Both lines of the power mains of EUT were measured and the cables connected to EUT and support units were moved to find the maximum emission levels for each frequency.

4.1.5 EUT OPERATING CONDITION

Set the EUT under transmission condition continuously at a specific channel frequency. Under Windows XP ran "EMI TEST" and "BLUETOOTH SOLEIL" programs, PC sent "H" pattern or accessed the following peripherals :

- RS232 (modem)
- Printer
- FDD
- HDD



4.1.6 TEST RESULT

Temperature:	25 °C	Humidity:	56 %RH
Ferquency Range:	0.15 – 30 MHz	Test Mode:	N/A
Receiver Detector:	Q.P. and AV.	Tested By:	Jackson Lai
Tested Date:	Dec. 17, 2003		

Power Line Measured : Line

Freq. (MHz)	Correct. Factor (dB)	Reading Value (dBμV)		Emission Level (dBμV)		Limit (dBμV)		Margin (dB)	
		Q.P.	AV.	Q.P.	AV.	Q.P.	AV.	Q.P.	AV.
0.170	0.20	45.1	41.1	45.3	41.3	65.0	55.0	-19.7	-13.7
0.298	0.20	37.8	37.2	38.0	37.4	60.3	50.3	-22.3	-12.9
0.884	0.20	41.8	40.1	42.0	40.3	56.0	46.0	-14.0	-5.7
5.357	0.32	21.3	19.4	21.6	19.7	60.0	50.0	-38.4	-30.3
15.447	0.51	21.6	20.2	22.1	20.7	60.0	50.0	-37.9	-29.3
18.349	0.57	25.1	22.1	25.7	22.7	60.0	50.0	-34.3	-27.3

Power Line Measured : Neutral

Freq. (MHz)	Correct. Factor (dB)	Reading Value (dBμV)		Emission Level (dBμV)		Limit (dBμV)		Margin (dB)	
		Q.P.	AV.	Q.P.	AV.	Q.P.	AV.	Q.P.	AV.
0.173	0.20	44.9	41.1	45.1	41.3	64.8	54.8	-19.7	-13.5
0.345	0.20	33.0	25.1	33.2	25.3	59.1	49.1	-25.9	-23.8
0.884	0.20	32.2	29.5	32.4	29.7	56.0	46.0	-23.6	-16.3
1.173	0.20	32.2	30.6	32.4	30.8	56.0	46.0	-23.6	-15.2
4.068	0.30	27.5	18.0	27.8	18.3	56.0	46.0	-28.2	-27.7
7.791	0.36	25.4	21.6	25.8	22.0	60.0	50.0	-34.2	-28.0

NOTE :

1. Measurement uncertainty is less than 2dB
2. Emission level = Reading valus + Correction factor
3. Correction Factor = Cable loss + Insertion loss of LISN
4. "**": Measurement does not apply for this frequency.
5. Margin value = Emission level - Limit
6. The emission of other frequencies were very low against the limit.
7. "-": The Quasi-peak reading value also meets average limit and measurement with the average detector is unnecessary.



4.2 CHANNEL SEPARATION TEST

4.2.1 LIMIT

FCC Part15, Subpart C Section 15.247(a)(1) . Frequency hopping systems shall have hopping channel carrier frequencies separated by a minimum of 25 kHz or the 20 dB bandwidth of the hopping channel, whichever is greater.

FREQUENCY RANGE (MHz)	Limit(kHz)
902-928	>25kHz
2400-2483.5	>25kHz
5725-5850	>25kHz

4.2.2 TEST EQUIPMENT

The following test equipment was used during the radiated emission test :

EQUIPMENT/ FACILITIES	SPECIFICATIONS	MANUFACTURER	MODEL#/ SERIAL#	DUE DATE OF CAL. & CAL. CENTER
SPECTRUM	9kHz-7GHz	ROHDE & SCHWARZ	FSP7/ 839511/010	MAR.2004 R & S

NOTE: The calibration interval of the above test equipment is one year and the calibrations are traceable to NML/ROC and NIST/USA.

4.2.3 TEST SET-UP

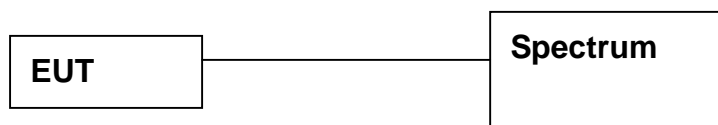

The EUT was connected to a spectrum through a 50 Ohm RF cable.

4.2.4 TEST PROCEDURE

The EUT was operating in hopping mode or could be controlled its channel. Printed out the test result from the spectrum by hard copy function.

4.2.5 EUT OPERATING CONDITION

Same as section 4.1.5 of this report.



Spectrum Research & Testing Lab., Inc.
 No. 101-10, Ling 8,
 Shan-Tong Li, Chung-Li
 City, Taoyuan, Taiwan

TEST REPORT

Reference No.:A03121108
 Report No.:FCCA03121108
 FCC ID:I4L-MS6850
 Page:12 of 45
 Date:Dec. 31, 2003

4.2.6 TEST RESULT

Temperature:	<u>26°C</u>	Humidity:	<u>55%RH</u>
Spectrum Detector:	<u>PK</u>	Tested by	<u>Jackson Lai</u>
Test Result	<u>PASS</u>	Tested Date:	<u>Dec. 01, 2003</u>

CHANNEL NUMBER	CHANNEL FREQUENCY (MHz)	SEPARATION READ VALUE (kHz)	SEPARATION LIMIT (kHz)
0	2402	1000.000	>25kHz
39	2441	1000.000	>25kHz
78	2480	1000.000	>25kHz

CH0:

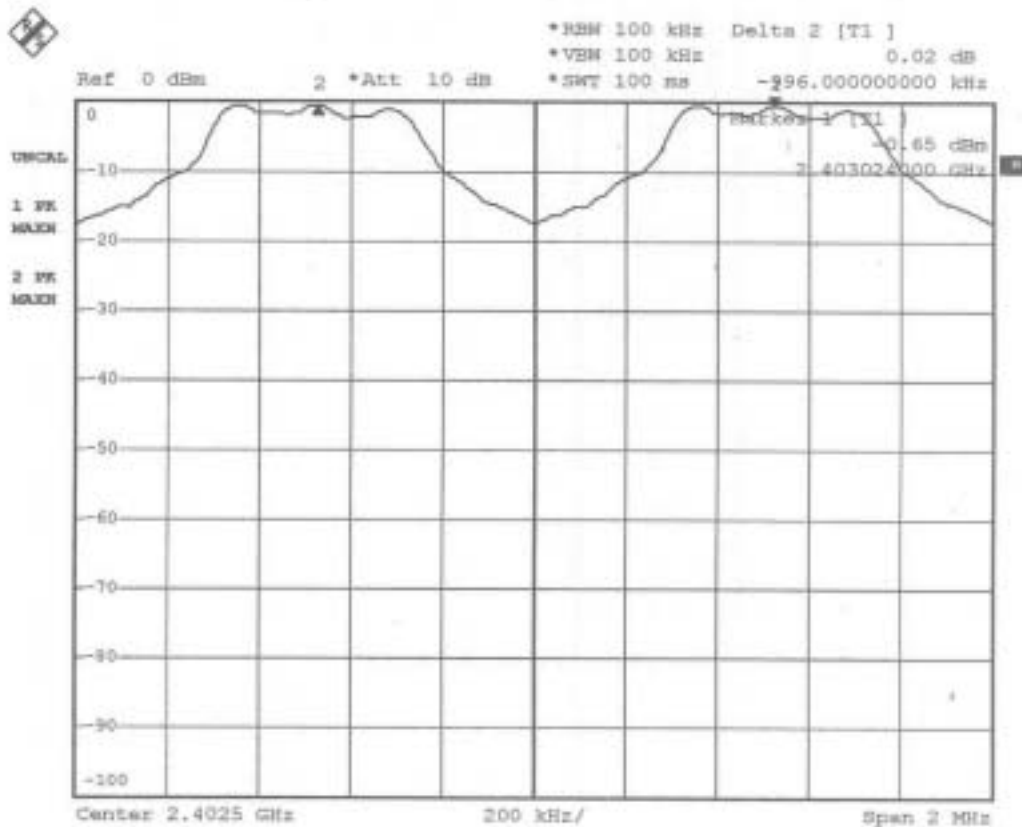

Date: 17.DEC.2003 15:33:16



CH39:

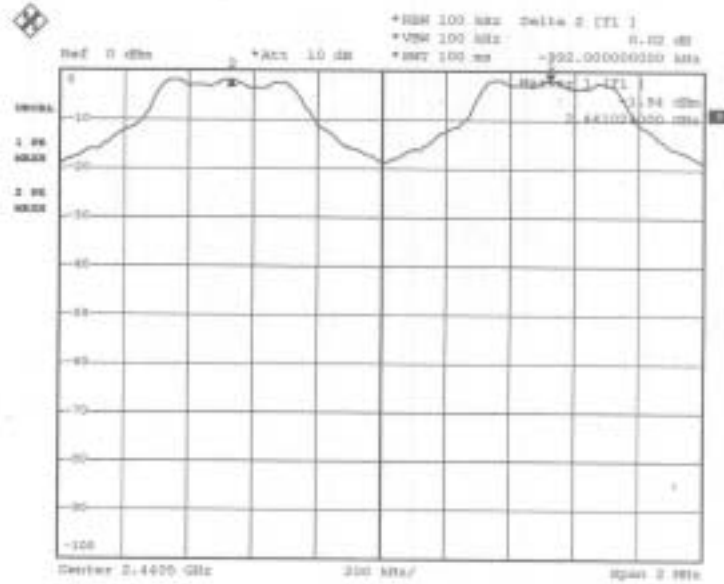

Date: 17.DEC.2003 15:28:08

CH78:

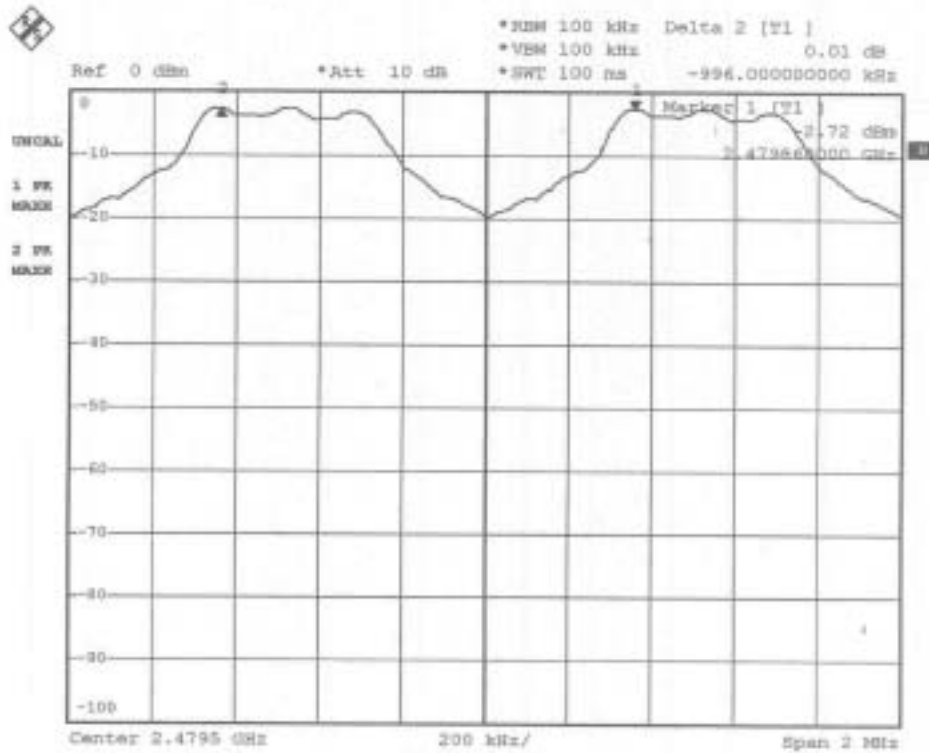

Date: 17.DEC.2003 15:25:04



Spectrum Research & Testing Lab., Inc.
 No. 101-10, Ling 8,
 Shan-Tong Li, Chung-Li
 City, Taoyuan, Taiwan

TEST REPORT

Reference No.:A03121108
 Report No.:FCCA03121108
 FCC ID:I4L-MS6850
 Page:14 of 45
 Date:Dec. 31, 2003

4.3 20dB Bandwidth

4.3.1 LIMIT

FREQUENCY Range (MHz)	Quantity of Hopping Channel	Limit(kHz)			
		50	25	15	75
902-928		<250	>250	NA	NA
2400-2483.5		NA	NA	>1000	<1000

4.3.2 TEST EQUIPMENT

The following test equipment was used during the test:

EQUIPMENT/ FACILITIES	SPECIFICATIONS	MANUFACTURER	MODEL#/ SERIAL#	DUE DATE OF CAL. & CAL. CENTER
SPECTRUM	9kHz-7GHz	ROHDE & SCHWARZ	FSP7/ 839511/010	MAR.2004 R & S

NOTE: The calibration interval of the above test equipment is one year and the calibrations are traceable to NML/ROC and NIST/USA.

4.3.3 TEST SET-UP

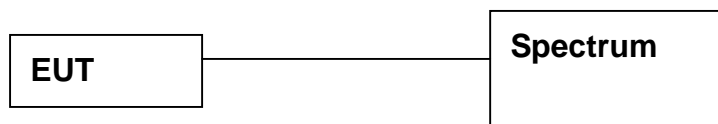

The EUT was connected to a spectrum through a 50 RF cable.

4.3.4 TEST PROCEDURE

The EUT was operating in hopping mode or could be controlled its channel. Printed out the test result from the spectrum by hard copy function.

4.3.5 EUT OPERATING CONDITION

Same as section 4.1.5 of this report.



Spectrum Research & Testing Lab., Inc.
 No. 101-10, Ling 8,
 Shan-Tong Li, Chung-Li
 City, Taoyuan, Taiwan

TEST REPORT

Reference No.:A03121108
 Report No.:FCCA03121108
 FCC ID:I4L-MS6850
 Page:15 of 45
 Date:Dec. 31, 2003

4.3.6 TEST RESULT

Temperature:	<u>26°C</u>	Humidity:	<u>55%RH</u>
Spectrum Detector:	<u>PK</u>	Tested by	<u>Jackson Lai</u>
Test Result	<u>PASS</u>	Tested Date:	<u>Dec. 17, 2003</u>

CHANNEL NUMBER	CHANNEL FREQUENCY (MHz)	20dB DOWN BW (KHz)	MINIMUM LIMIT (MHz)
0	2402	888	1
39	2441	840	1
78	2480	840	1

CH0:

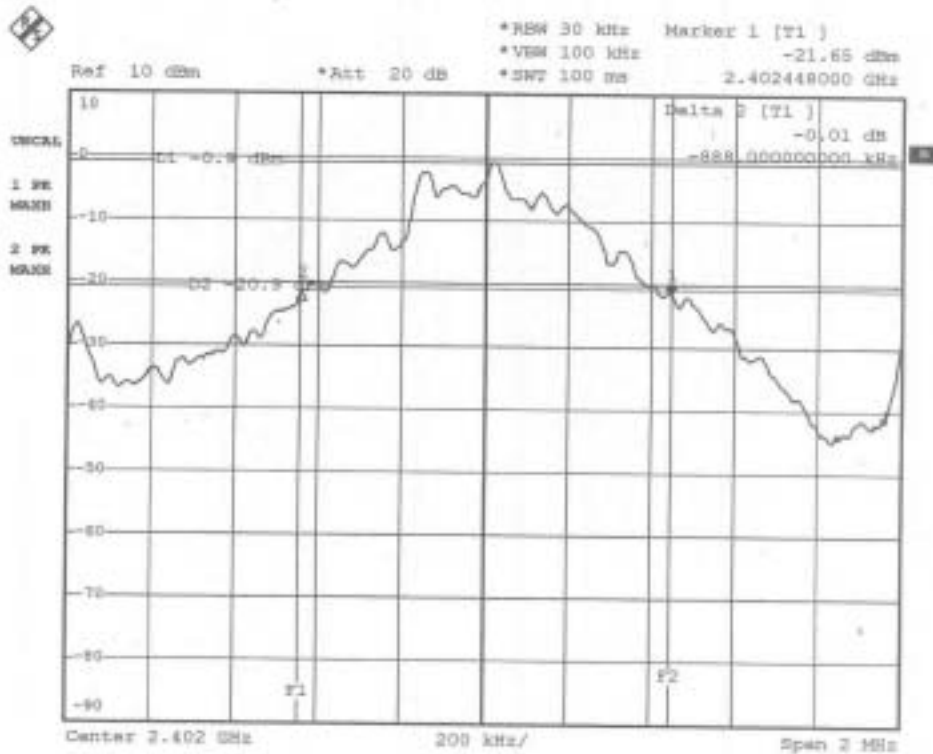

Date: 17.DEC.2003 15:39:55



Ch39:

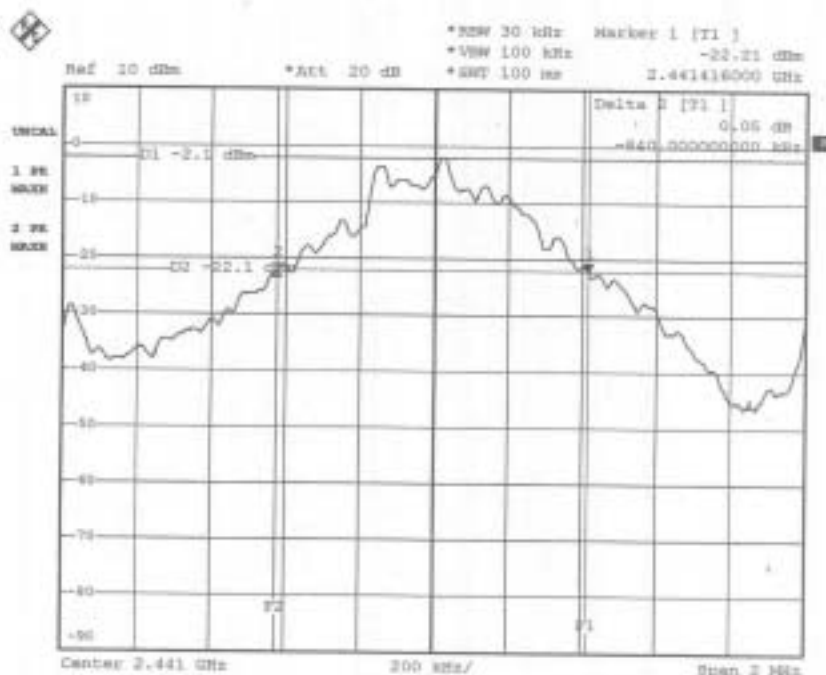

Date: 17.DEC.2003 15:44:02

CH78:

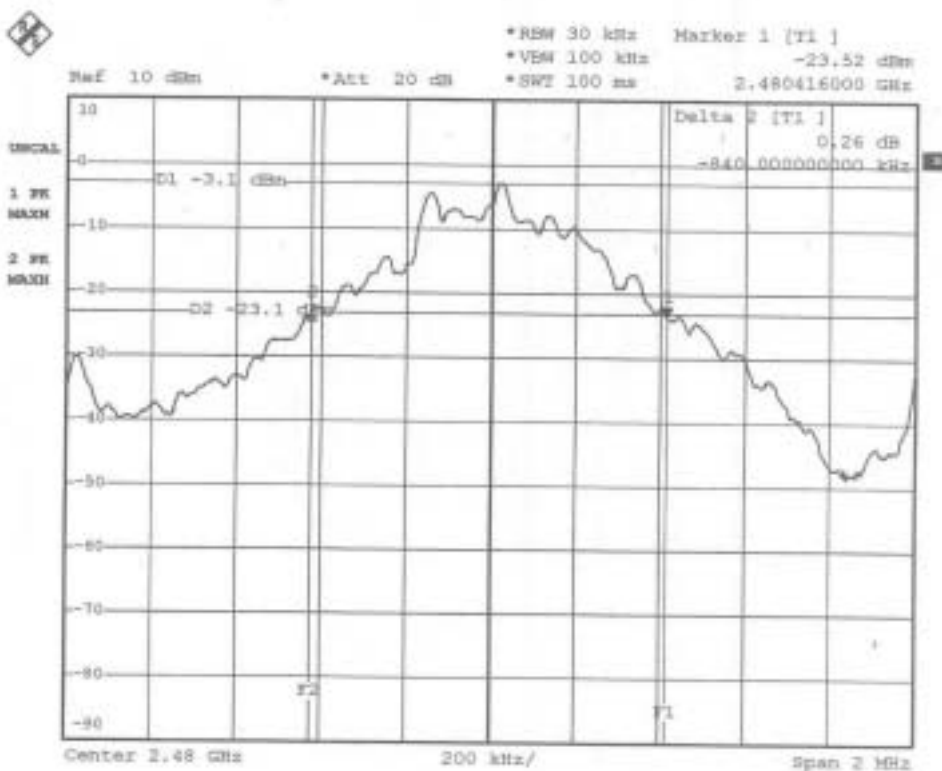

Date: 17.DEC.2003 15:51:30



4.4 QUANTITY OF HOPPING CHANNEL TEST

4.4.1 LIMIT

FCC Part15, Subpart C Section 15.247.

FREQUENCY RANGE (MHz)	Limit (Quantity of Hopping Channel)			
	20dB bandwidth <250kHz	20dB bandwidth >250kHz	20dB bandwidth <1MHz	20dB bandwidth >1MHz
902-928	50	25	N/A	N/A
2400-2483.5	N/A	N/A	75	15
5725-5850	N/A	N/A	75	N/A

4.4.2 TEST EQUIPMENT

The following test equipment was used during the test:

EQUIPMENT/FACILITIES	SPECIFICATIONS	MANUFACTURER	MODEL#/SERIAL#	DUE DATE OF CAL. & CAL. CENTER
SPECTRUM	9kHz-7GHz	ROHDE & SCHWARZ	FSP7/ 839511/010	MAR.2004 R & S

NOTE: The calibration interval of the above test equipment is one year and the calibrations are traceable to NML/ROC and NIST/USA.

4.4.3 TEST SET-UP

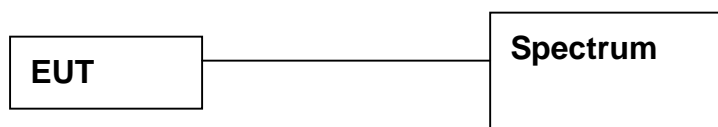

The EUT was connected to a spectrum through a 50 Ohm RF cable.

4.4.4 TEST PROCEDURE

The EUT was operating in hopping mode or could be controlled its channel. Printed out the test result from the spectrum by hard copy function.

4.4.5 EUT OPERATING CONDITION

Same as section 4.1.5 of this report.



Spectrum Research & Testing Lab., Inc.
 No. 101-10, Ling 8,
 Shan-Tong Li, Chung-Li
 City, Taoyuan, Taiwan

TEST REPORT

Reference No.:A03121108
 Report No.:FCCA03121108
 FCC ID:I4L-MS6850
 Page:18 of 45
 Date:Dec. 31, 2003

4.4.6 TEST RESULT

Temperature:	<u>26°C</u>	Humidity:	<u>55%RH</u>
Spectrum Detector:	<u>PK</u>	Tested by	<u>Jackson Lai</u>
Test Result	<u>PASS</u>	Tested Date:	<u>Dec. 17, 2003</u>

HOPPING CHANNEL FREQUENCY RANGE	QUANTITY OF HOPPING CHANNEL READ VALUE	QUANTITY OF HOPPING CHANNEL LIMIT
2402~2480	79	75

CH0-CH78

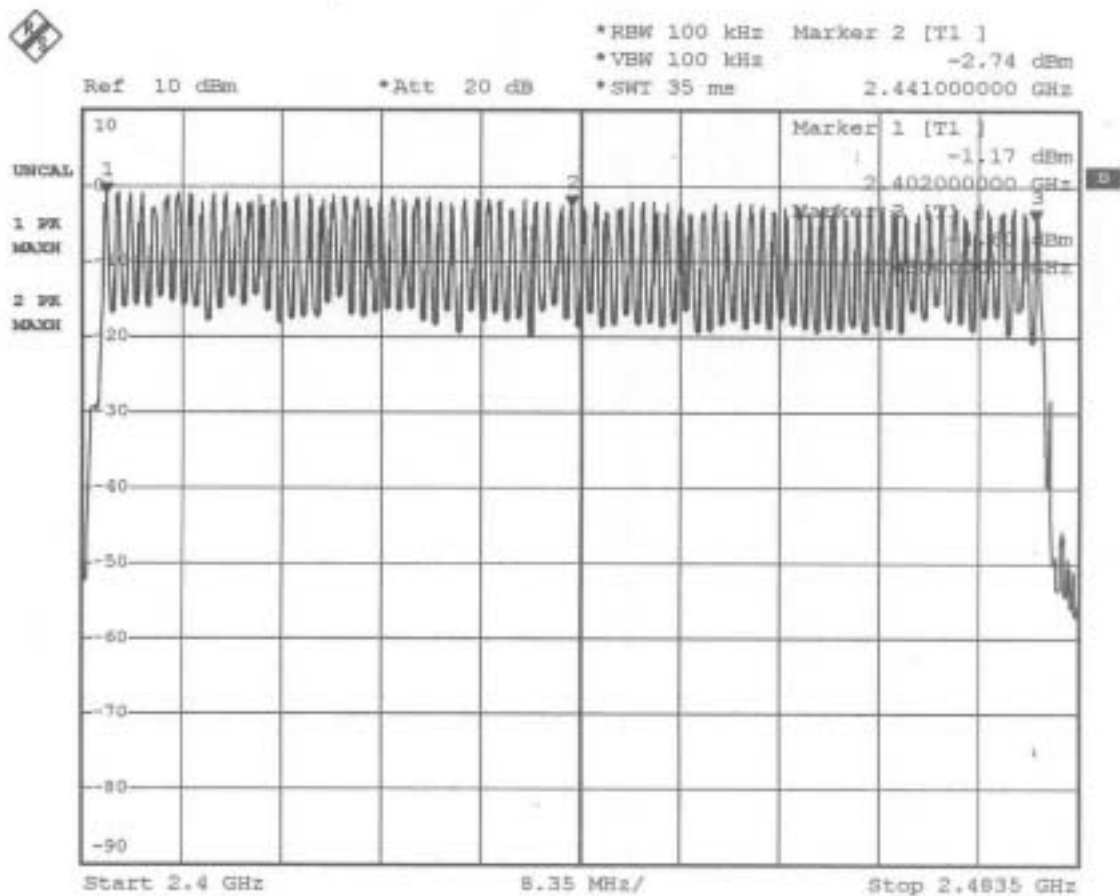

Date: 17.DEC.2003 16:26:54



4.5 Time of occupancy (Dwell Time)

4.5.1 LIMIT

FCC Part15, Subpart C Section 15.247.

FREQUENCY RANGE (MHz)	LIMIT (ms)		
	20dB bandwidth <250kHz(50Channel)	20dB bandwidth >250kHz(25Channel)	20dB bandwidth <1MHz(75Channel)
902-928	400(20s)	400(10s)	NA
2400-2483.5	NA	NA	400(30s)
5725-5850	NA	NA	400(30s)

NOTE: The “()” is all channel’s average time of occupancy.

4.5.2 TEST EQUIPMENT

The following test equipment was used during the test:

EQUIPMENT/ FACILITIES	SPECIFICATIONS	MANUFACTURER	MODEL#/ SERIAL#	DUE DATE OF CAL. & CAL. CENTER
SPECTRUM	9kHz-7GHz	ROHDE & SCHWARZ	FSP7/ 839511/010	MAR.2004 R & S

NOTE: The calibration interval of the above test equipment is one year and the calibrations are traceable to NML/ROC and NIST/USA.

4.5.3 TEST SET-UP

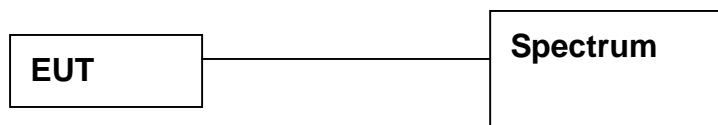

The EUT was connected to a spectrum through a 50 Ohm RF cable.

4.5.4 TEST PROCEDURE

The EUT was operating in hopping mode or could be controlled its channel. Printed out the test result from the spectrum by hard copy function.

4.5.5 EUT OPERATING CONDITION

Same as section 4.1.5 of this report.



Spectrum Research & Testing Lab., Inc.
No. 101-10, Ling 8,
Shan-Tong Li, Chung-Li
City, Taoyuan, Taiwan

TEST REPORT

Reference No.:A03121108
Report No.:FCCA03121108
FCC ID:I4L-MS6850
Page:20 of 45
Date:Dec. 31, 2003

4.5.6 TEST RESULT

Temperature: 26°C Humidity: 55%RH
Spectrum Detector: PK Tested by JacksonLai
Test Result PASS Tested Date: Dec. 17, 2003

CHANNEL NUMBER	CHANNEL FREQUENCY (MHz)	Pulse Time (µs)	Burts (in 1 sec.)	Time of occupancy (Dwell Time) (ms)	Average time of occupancy LIMIT (ms)
0	2402.00	530	10	164.3	400
39	2441.00	530	10	164.3	400
78	2480.00	530	10	164.3	400

Note:
Dwell Time:

$$\text{Pulse Time} * \text{Burts} * 0.4 * 79$$



CH0:

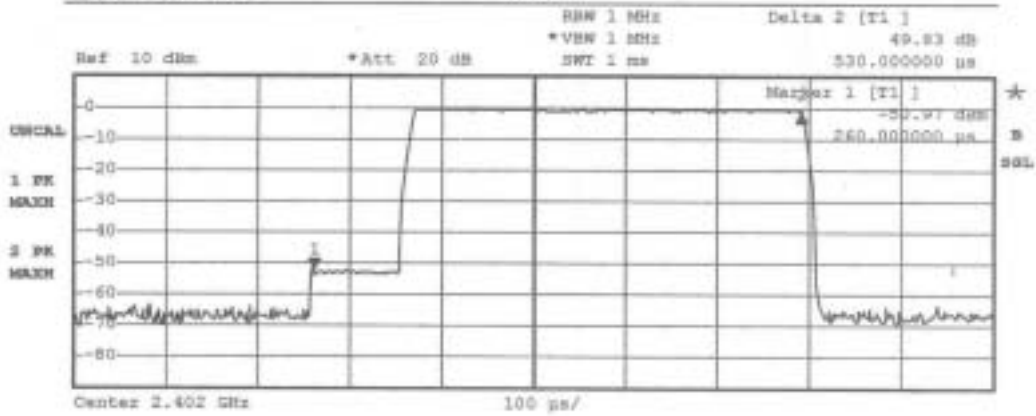
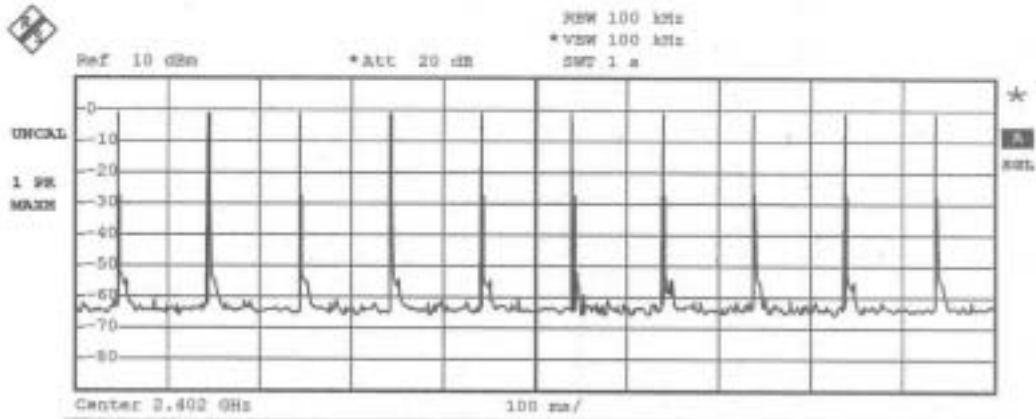

Date: 17.DEC.2003 16:18:26



Ch39:

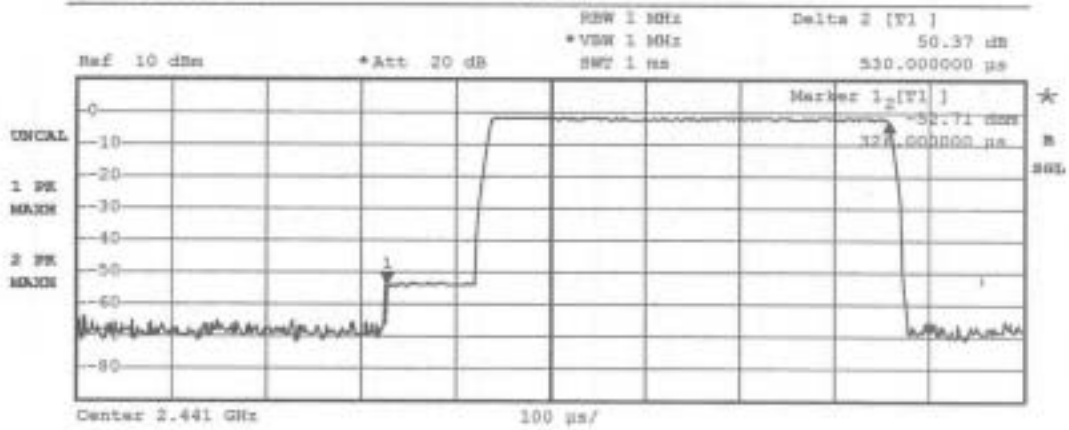
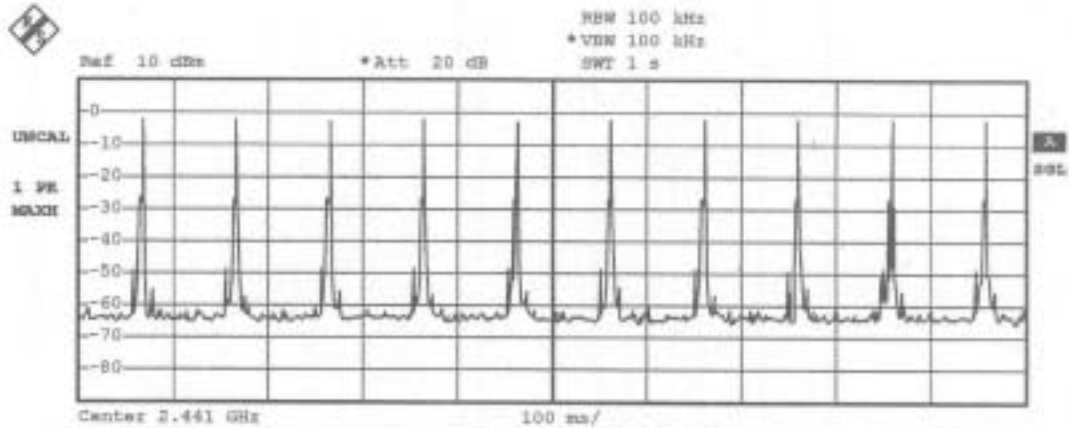

Date: 17.DEC.2003 16:20:58



CH78:

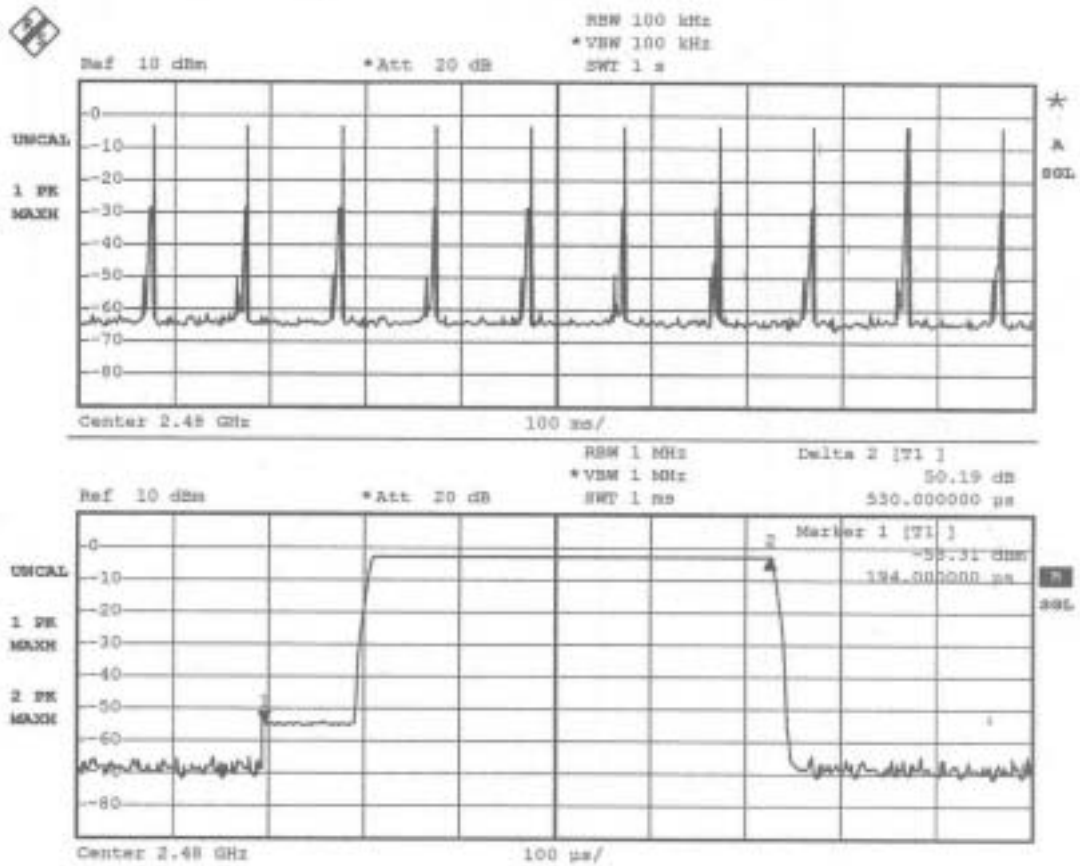

Date: 17.DEC.2003 16:23:41



Spectrum Research & Testing Lab., Inc.
 No. 101-10, Ling 8,
 Shan-Tong Li, Chung-Li
 City, Taoyuan, Taiwan

TEST REPORT

Reference No.:A03121108
 Report No.:FCCA03121108
 FCC ID:I4L-MS6850
 Page:24 of 45
 Date:Dec. 31, 2003

4.6 PEAK POWER TEST

4.6.1 LIMIT

FCC Part15, Subpart C Section 15.247.

FREQUENCY RANGE (MHz)	LIMIT (W)				
	Quantity of Hopping Channel	50	25	15	75
902-928	1(30dBm)	0.125(21dBm)	NA	NA	NA
2400-2483.5	NA	NA	0.125(21dBm)	1(30dBm)	NA
5725-5850	NA	NA	NA	NA	1(30dBm)

4.6.2 TEST EQUIPMENT

The following test equipment was used during the test :

EQUIPMENT/ FACILITIES	SPECIFICATIONS	MANUFACTURER	MODEL#/ SERIAL#	DUE DATE OF CAL. & CAL. CENTER
SPECTRUM	9kHz-7GHz	ROHDE & SCHWARZ	FSP7/ 839511/010	MAR. 2004 R & S
POWER METER	N/A	BOONTON	4232A/ 29001	MAY 2004 ETC
POWER SENSOR	DC-18GHz 0.3 μ W-100mW 50	BOONTON	51011-EMC/ 31184	JUN. 2004 ETC

NOTE: The calibration interval of the above test equipment is one year and the calibrations are traceable to NML/ROC and NIST/USA.



4.6.3 TEST SET-UP

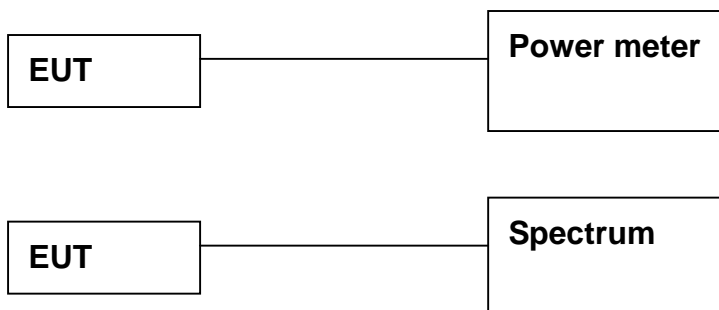

The EUT was connected to a spectrum through a 50 RF cable.

4.6.4 TEST PROCEDURE

The EUT was operating in hopping mode or could control its channel.
 Printed out the test result from the spectrum by hard copy function.
 Recorded the read value of the power meter.

4.6.5 EUT OPERATING CONDITION

Same as section 4.1.5 of this report.

4.6.6 TEST RESULT

Temperature:	<u>26°C</u>	Humidity:	<u>55%RH</u>
Spectrum Detector:	<u>PK</u>	Tested by	<u>Jackson Lai</u>
Test Result	<u>PASS</u>	Tested Date:	<u>Dec. 17, 2003</u>

CHANNEL NUMBER	CHANNEL FREQUENCY (MHz)	PEAK POWER OUTPUT (dBm)	PEAK POWER LIMIT (dBm)
0	2402.0000	-1.60	30
39	2441.0000	-2.87	30
78	2480.0000	-3.80	30



CH0:

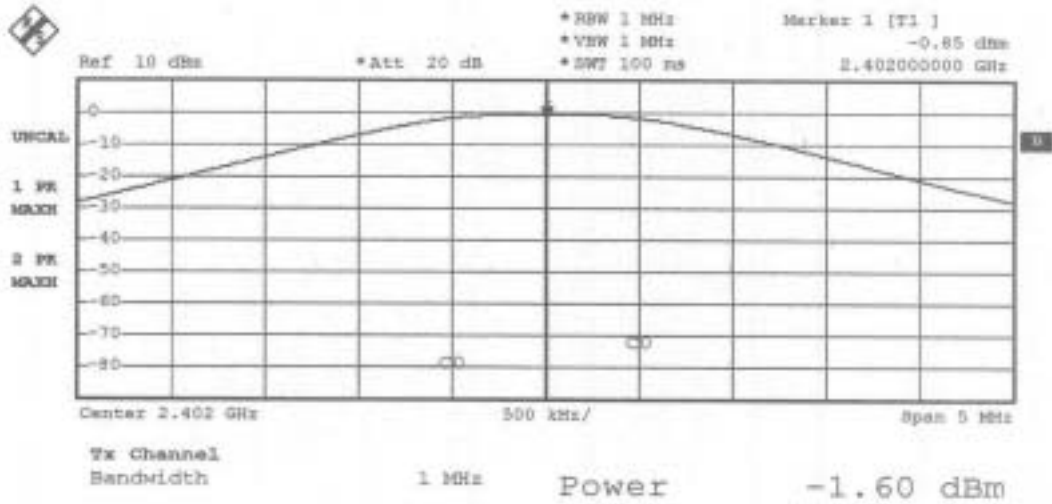

CH39:

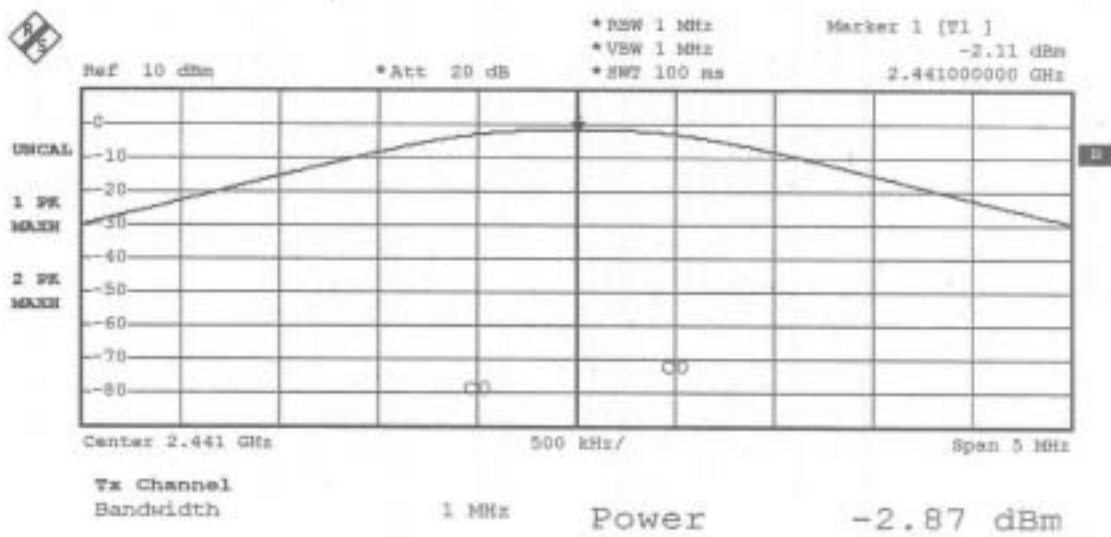



Spectrum Research & Testing Lab., Inc.
No. 101-10, Ling 8,
Shan-Tong Li, Chung-Li
City, Taoyuan, Taiwan

TEST REPORT

Reference No.:A03121108
Report No.:FCCA03121108
FCC ID:I4L-MS6850
Page:27 of 45
Date:Dec. 31, 2003

CH78:

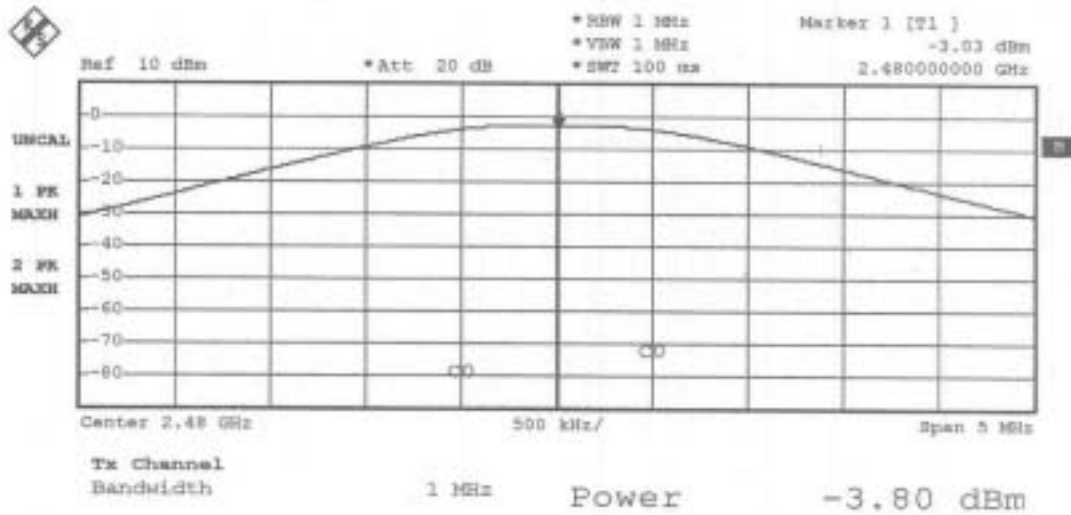



4.7 BAND EDGE TEST

4.7.1 LIMIT

FCC Part15, Subpart C Section 15.247. In any 100 kHz bandwidth outside the frequency band in which the spread spectrum intentional radiator is operating, the radio frequency power that is produced by the intentional radiator shall be at least 20 dB below that in the 100 kHz bandwidth within the band that contains the highest level of the desired power, based on either an RF conducted or a radiated measurement. Attenuation below the general limits specified in Section 15.209(a) is not required. In addition, radiated emissions which fall in the restricted bands, as defined in Section 15.205(a), must also comply with the radiated emission limits specified in Section 15.209(a) (see Section 15.205(c)).

OPERATING FREQUENCY RANGE (MHz)	SPURIOUS EMISSION FREQUENCY (MHz)	LIMIT	
		Peak power ration to emission(dBc)	Emission level(dBuV/m)
902-928	<902	>20	NA
	>928	>20	NA
	960-1240	NA	54
2400-2483.5	<2400	>20	NA
	>2483.5-2500	NA	54
5725-5850	<5350-5460	NA	54
	<5725	>20	NA
	>5850	>20	NA



Spectrum Research & Testing Lab., Inc.
No. 101-10, Ling 8,
Shan-Tong Li, Chung-Li
City, Taoyuan, Taiwan

TEST REPORT

Reference No.:A03121108
Report No.:FCCA03121108
FCC ID:I4L-MS6850
Page:29 of 45
Date:Dec. 31, 2003

4.7.2 TEST EQUIPMENT

The following test equipment was used during the test :

EQUIPMENT/ FACILITIES	SPECIFICATIONS	MANUFACTURER	MODEL#/ SERIAL#	DUE DATE OF CAL. & CAL. CENTER
SPECTRUM	9kHz-7GHz	ROHDE & SCHWARZ	FSP7/ 839511/010	MAR.2004 R & S
EMI TEST RECEIVER	9 kHz TO 2750 MHz	ROHDE & SCHWARZ	ESCS30/ 830245/012	AUG. 2004 R&S
SPECTRUM	9KHz-26.5GHz	HP	8953E/ 3710A03220	MAY. 2004 ETC
PRE-AMPLIFIER	1GHz-26.5GHz Gain:30dB	HP	8449B/ 3008A01019	DEC. 2003 ETC
BI-LOG ANTENNA	25 MHz TO 2 GHz	EMCO	3142/9701-1124	APR. 2004 SRT
HORN ANTENNA	1GHz to 18GHz	EMCO	3115/ 9602-4681	DEC. 2003 ETC
OATS	3 - 10 M measurement	SRT	SRT-1	APR. 2004 SRT
SPECTRUM	9kHz-7GHz	ROHDE & SCHWARZ	FSP7/ 839511/010	MAR.2004 R & S

NOTE: The calibration interval of the above test equipment is one year and the calibrations are traceable to NML/ROC and NIST/USA.



4.7.3 TEST SET-UP

FOR RF CONDUCTED TEST (dBc)

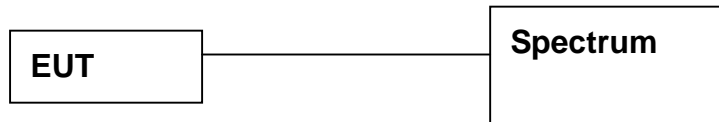

The EUT was connected to the spectrum through a 50 Ω RF cable.

FOR RADIATED EMISSION TEST

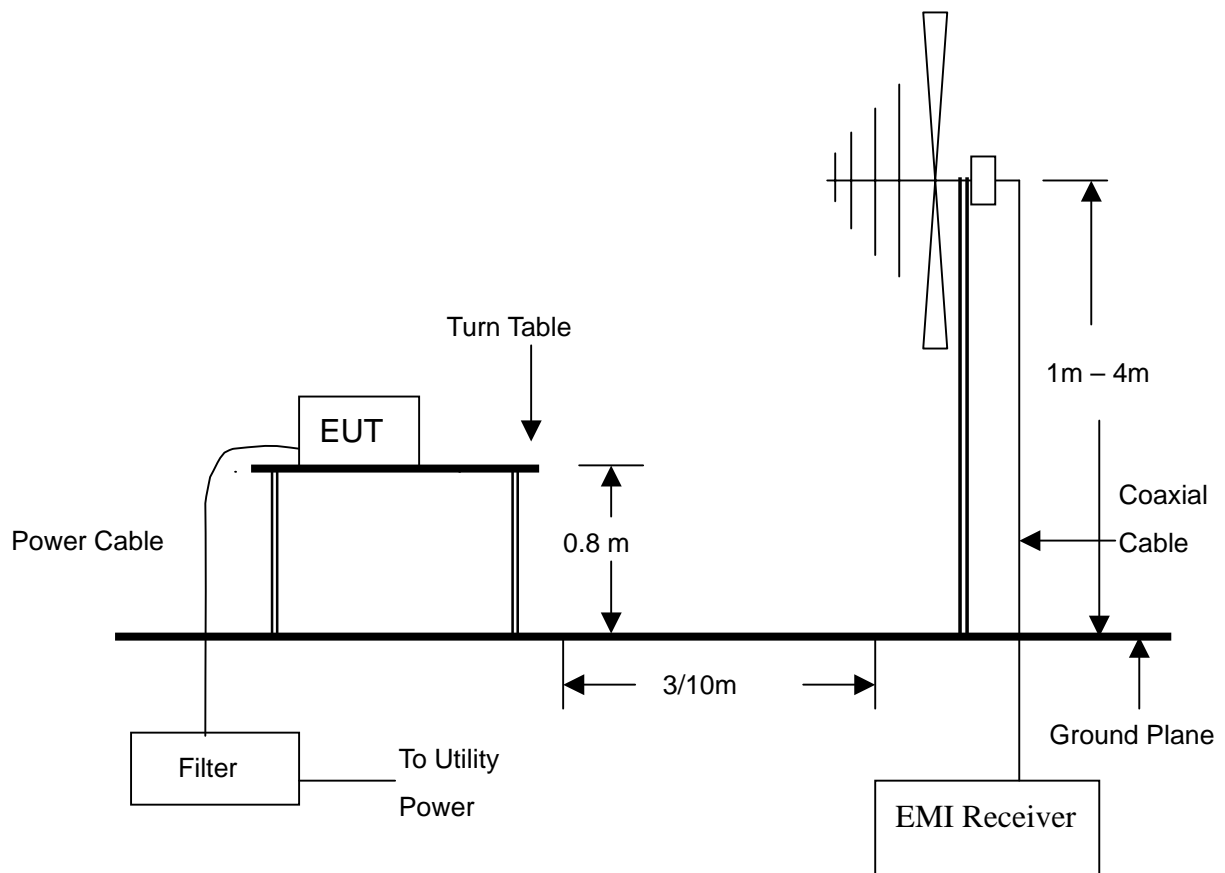

NOTE :

1. The EUT system was put on a wooden table with 0.8m heights above a ground plane.
2. For the actual test configuration, please refer to the photos of testing.



4.7.4 TEST PROCEDURE

1. The EUT was operating in hopping mode or could be controlled its channel.
 Printed out the test result from the spectrum by hard copy function.
2. The EUT was tested according to the requirement of ANSI C63.4 and CISPR 22.
 The measurements were made at an open area test site with 10 meter measurement distance under 1 GHz and with 3m distance above 1GHz. The frequency spectrum measured started from 30 MHz. Under 1 GHz. All readings were quasi-peak values with 120 kHz resolution bandwidth of the test receiver. Above 1 GHz, the measurements were made at an open area test site with 3 meter measurement distance and all readings were peak and average values with 1 MHz resolution bandwidth of the test receiver. The EUT system was operated in all typical methods by users. The cables connected to EUT and support units were moved to find the maximum emission levels for each frequency.

4.7.5 EUT OPERATING CONDITION

Same as section 4.1.5 of this report.

4.7.6 TEST RESULT

Temperature:	<u>26°C</u>	Humidity:	<u>55%RH</u>
Spectrum Detector:	<u>PK & AV</u>	Tested by	<u>Jackson Lai</u>
Test Result	<u>PASS</u>	Tested Date:	<u>Dec. 23, 2003</u>

1. Conducted test

Frequency (MHz)	PEAK POWER OUTPUT (dBm)	Emission read Value(dBm)	Result of Band edge (dBc)	Band edge LIMIT (dBc)
<2400	-1.55	-43.33	41.78	>20dBc
>2483.5	-0.92	-45.56	44.64	>20dBc

2. Radiated emission test

Frequency (MHz)	Antenna polarization (H/V)	PEAK POWER OUTPUT (dBuV/m)	Emission read Value(dBuV/m)	Band edge LIMIT (dBuV/m)
<2400	V	47.8	43.7	54
>2483.5	V	49.9	45.8	54



Spectrum Research & Testing Lab., Inc.
No. 101-10, Ling 8,
Shan-Tong Li, Chung-Li
City, Taoyuan, Taiwan

TEST REPORT

Reference No.:A03121108
Report No.:FCCA03121108
FCC ID:I4L-MS6850
Page:32 of 45
Date:Dec. 31, 2003

<2400MHz:

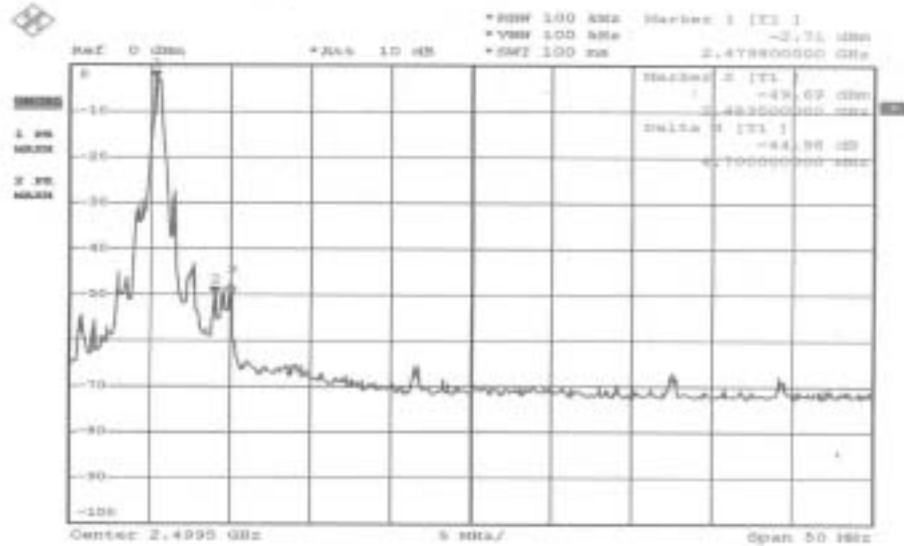

>2483.5MHz

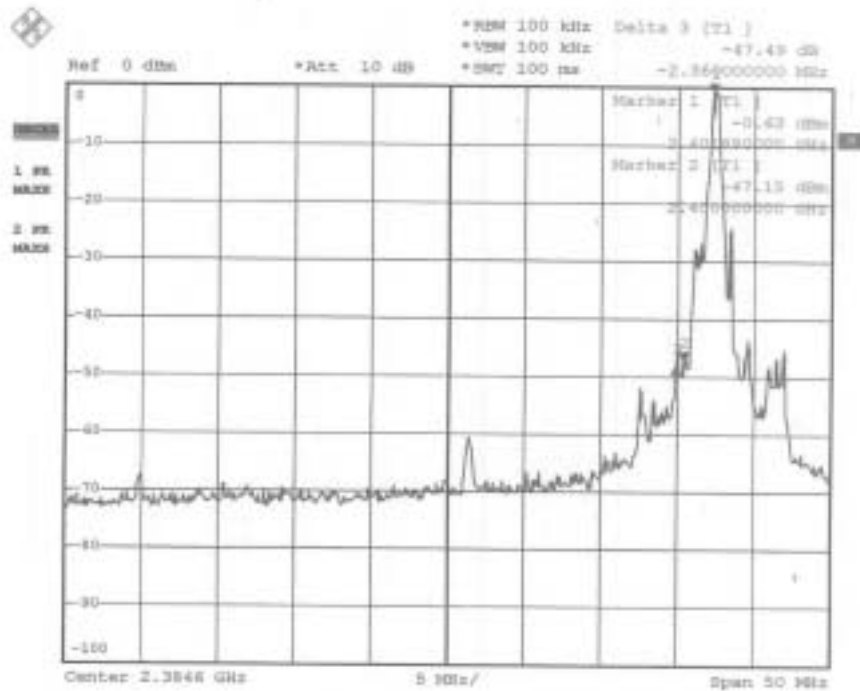



4.8 SPURIOUS RADIATED EMISSION TEST

4.8.1 LIMIT

FCC Part15, Subpart C Section 15.209 limit of radiated emission for frequency below1000MHz. The emissions from an intentional radiator shall not exceed the field strength levels specified in the following table:

FREQUENCY (MHz)	DISTANCE (m)	FIELD STRENGTH (dB μ V/m)
30 - 88	3	40.0
88 - 216	3	43.5
216 - 960	3	46.0
ABOVE 960	3	54.0

- NOTE** :
1. In the emission tables above , the tighter limit applies at the band edges.
 2. Distance refers to the distance between measuring instrument , antenna , and the closest point of any part of the device or system.

FCC Part 15, Section15.35(b) limit of radiated emission for frequency above 1000 MHz

FREQUENCY (MHz)	Class A (dBuV/m) (at 3m)		Class B (dBuV/m) (at 3m)	
	PEAK	AVERAGE	PEAK	AVERAGE
Above 1000	80.0	60.0	74.0	54.0

FCC Part 15, Subpart C Section 15.249. The field strength of emissions from intentional radiators operated within these frequency bands shall comply with the following:

FUNDAMENTAL FREQUENCY (MHz)	FIELD STRENGTH OF FUNDAMENTAL (dBuV/m) (at 3m)		FIELD STRENGTH OF HARMONICS (dBuV/m) (at 3m)	
	PEAK	AVERAGE	PEAK	AVERAGE
902-928	114	94	74.0	54.0
2400-2483.5	114	94	74.0	54.0
5725-5875	114	94	74.0	54.0
24000-24250	128	108	88	68



Spectrum Research & Testing Lab., Inc.
No. 101-10, Ling 8,
Shan-Tong Li, Chung-Li
City, Taoyuan, Taiwan

TEST REPORT

Reference No.:A03121108
Report No.:FCCA03121108
FCC ID:I4L-MS6850
Page:34 of 45
Date:Dec. 31, 2003

4.8.2 TEST EQUIPMENT

The following test equipment was used during the radiated emission test :

EQUIPMENT/ FACILITIES	SPECIFICATIONS	MANUFACTURER	MODEL#/ SERIAL#	DUE DATE OF CAL. & CAL. CENTER
EMI TEST RECEIVER	9 kHz TO 2750 MHz	ROHDE & SCHWARZ	ESCS30/ 830245/012	AUG. 2004 R&S
BI-LOG ANTENNA	25 MHz TO 2 GHz	EMCO	3142/ 9701-1124	APR. 2004 SRT
OATS	3 – 10 M MEASUREMENT	SRT	SRT-1	APR. 2004 SRT
COAXIAL CABLE	25M	SUNCITY	J400/ 25M	AUG. 2004 SRT
FILTER	2 LINE, 30A	FIL.COIL	FC-943/ 869	N/A
FREQUENCY CONVERTER	N/A	APC	AFC-1KW/ 860612	AUG. 2004 SRT

NOTE:

1. The calibration interval of the above test equipment is one year and the calibrations are traceable to NML/ROC and NIST/USA.
2. The Open Area Test Site (SRT-1) is registered by FCC with No. 90957 and VCCI with No. R-1081.
3. The Open Area Test Site (SRT-2) is registered by FCC with No. 98458 and VCCI with No. R-1168.



4.8.3 TEST SET-UP

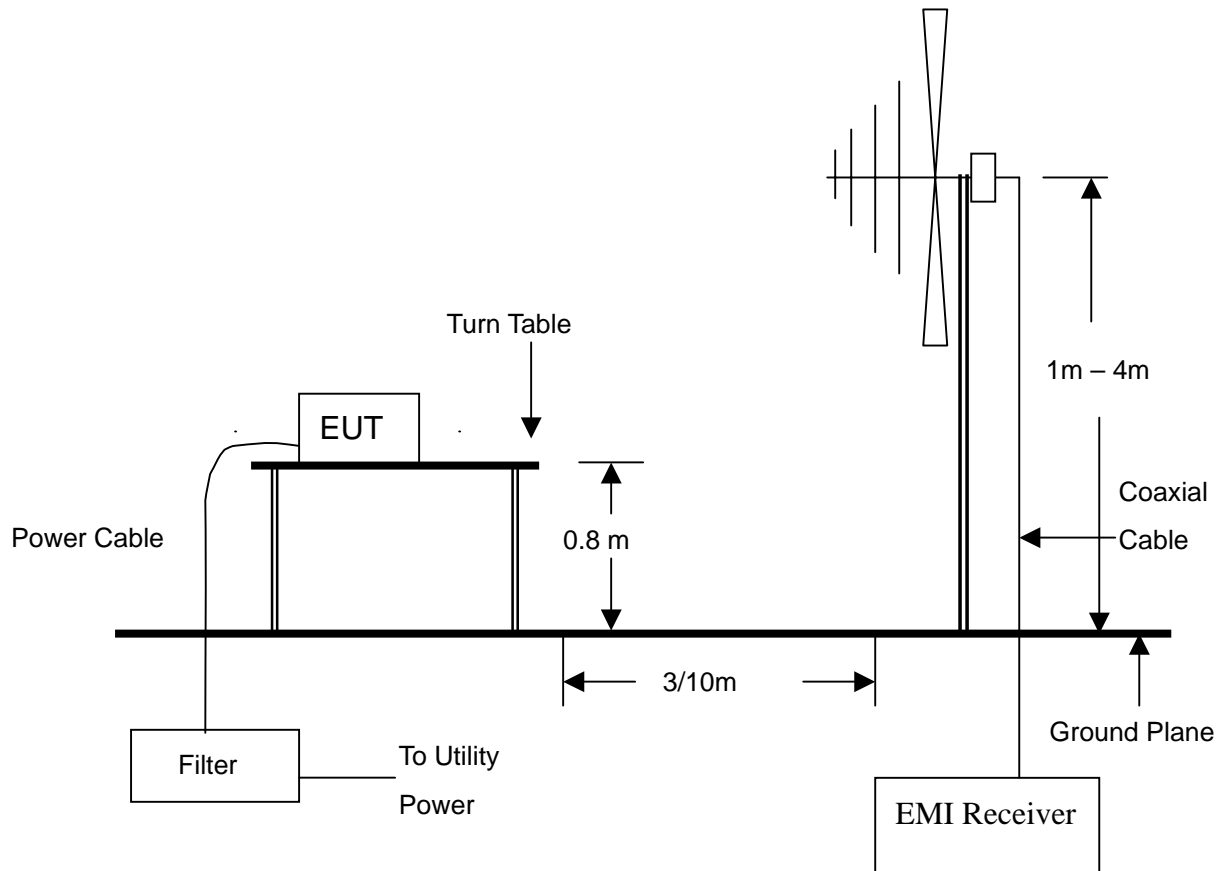

NOTE :

3. The EUT system was put on a wooden table with 0.8m heights above a ground plane.
4. For the actual test configuration, please refer to the photos of testing.



**Spectrum Research &
Testing Lab., Inc.**
No. 101-10, Ling 8,
Shan-Tong Li, Chung-Li
City, Taoyuan, Taiwan

TEST REPORT

Reference No.:A03121108
Report No.:FCCA03121108
FCC ID:I4L-MS6850
Page:36 of 45
Date:Dec. 31, 2003

4.8.4 TEST PROCEDURE

The EUT was tested according to the requirement of ANSI C63.4 and CISPR 22. The measurements were made at an open area test site with 10 meter measurement distance under 1 GHz and with 3m distance above 1GHz. The frequency spectrum measured started from 30 MHz. Under 1 GHz. All readings were quasi-peak values with 120 kHz resolution bandwidth of the test receiver. Above 1 GHz, the measurements were made at an open area test site with 3 meter measurement distance and all readings were peak and average values with 1 MHz resolution bandwidth of the test receiver. The EUT system was operated in all typical methods by users. The cables connected to EUT and support units were moved to find the maximum emission levels for each frequency.

4.8.5 EUT OPERATING CONDITION

Same as section 4.1.5 of this report.



4.8.6 TEST RESULT

Temperature:	25°C	Humidity:	56%RH
Frequency Range:	30 – 1000 MHz	Test mode:	RX
Receiver Detector:	Q.P. or AV.	Measured Distance:	3m
Tested by:	Jackson Lai		

Antenna Polarization : Horizontal

Frequency (MHz)	Cable Loss (dB)	Antenna Factor (dB/m)	Reading Data (dBμV)	Emission Level (dBμV/m)	Limit (dBμV/m)	Margin (dB)	EL(m)	AZ(°)
107.6000	1.22	8.53	21.2	31.0	43.5	-12.5	11.4	1.10
132.5500	1.38	8.24	27.7	37.3	43.5	-6.2	2.4	1.21
210.4400	1.67	10.90	17.4	30.0	43.5	-13.5	355.4	1.54
397.6000	2.61	16.26	23.3	42.2	46.0	-3.8	198.1	1.71
454.8600	2.67	17.15	20.3	40.1	46.0	-5.9	122.1	1.20
661.4500	2.60	20.93	18.1	41.6	46.0	-4.4	179.0	1.12

Antenna Polarization : Vertical

Frequency (MHz)	Cable Loss (dB)	Antenna Factor (dB/m)	Reading Data (dBμV)	Emission Level (dBμV/m)	Limit (dBμV/m)	Margin (dB)	EL(m)	AZ(°)
132.8200	1.38	8.24	27.2	36.8	43.5	-6.7	351.2	1.00
232.7300	1.89	11.90	19.5	33.3	46.0	-12.7	277.8	1.37
531.4200	3.16	18.78	17.2	39.1	46.0	-6.9	1.0	1.41
663.3200	2.58	20.98	18.4	42.0	46.0	-4.0	9.3	1.62
992.4500	3.10	23.94	17.1	44.1	54.0	-9.9	152.3	1.53
967.9900	3.18	23.64	16.4	43.2	54.0	-10.8	199.1	1.18

- NOTE :**
1. Measurement uncertainty is less than +/-4dB
 2. "": Measurement does not apply for this frequency.
 3. Emission Level = Reading Value + Ant. Factor + Cable Loss
 4. The field strength of other emission frequencies were very low against the limit.



Temperature: 26°C Humidity: 55%RH
 Frequency Range: 1 – 25 GHz Test mode: Ch0
 Receiver Detector: PK. or AV. Measured Distance: 3m
 Tested by: Jackson Lai

Antenna Polarization : Horizontal

Freq./MHz	Cable Loss (dB)	Ant. Fact. (dB)	Reading (dBuV)		Emission (dBuV/m)		Limit Line (dBuV/m)		Margin (dBuV/m)		AZ (o)	EL (m)
			PK	AV	PK	AV	PK	AV	PK	AV		
2402.00(F)	-32.16	28.00	83.9	53.1	79.7	49.0	N/A	N/A	N/A	N/A	279	1.00
2400.00	-32.16	28.00	66.4	40.9	62.2	36.7	74.0	54.0	-11.8	-17.3	24.3	1.02
2397.56	-32.17	27.99	47.4	*	43.2	*	74.0	54.0	-30.8	*	19.1	1.00
2406.31	-32.17	28.01	47.7	*	43.5	*	74.0	54.0	-30.5	*	11.2	1.12
4804.00	-30.47	33.64	44.0	*	47.2	*	74.0	54.0	-26.8	*	298.6	1.06
7206.00	-28.90	36.26	42.8	*	50.2	*	74.0	54.0	-23.8	*	132.1	1.32

Antenna Polarization : Vertical

Freq/MHz	Cable Loss (dB)	Ant. Fact. (dB)	Reading (dBuV)		Emission (dBuV/m)		Limit Line (dBuV/m)		Margin (dBuV/m)		AZ (o)	EL (m)
			PK	AV	PK	AV	PK	AV	PK	AV		
2402.00(F)	-32.16	28.54	88.6	54.1	85.0	50.5	N/A	N/A	N/A	N/A	279	1.01
2397.25	-32.17	27.99	47.8	*	43.7	*	74.0	54.0	-30.3	*	10.2	1.03
2406.75	-32.17	28.01	50.4	37.4	46.3	33.2	74.0	54.0	-27.7	-20.8	9.1	1.12
2400.00	-32.16	28.00	62.3	43.1	58.1	38.9	74.0	54.0	-15.9	-15.1	334.5	1.11
4804.00	-30.47	33.64	44.7	*	47.9	*	74.0	54.0	-26.1	*	277.3	1.00
7206.00	-28.90	36.26	47.3	*	54.7	*	74.0	54.0	-19.3	*	351.8	1.03

- NOTE :**
1. Measurement uncertainty is less than +/-4dB
 2. "*": Measurement does not apply for this frequency.
 3. Emission Level = Reading Value + Ant. Factor + Cable Loss
 4. The field strength of other emission frequencies were very low against the limit.
 - 5.(F):The field strength of fundamental frequency.



Spectrum Research & Testing Lab., Inc.
No. 101-10, Ling 8,
Shan-Tong Li, Chung-Li
City, Taoyuan, Taiwan

TEST REPORT

Reference No.:A03121108
Report No.:FCCA03121108
FCC ID:I4L-MS6850
Page:39 of 45
Date:Dec. 31, 2003

Temperature:	<u>26°C</u>	Humidity:	<u>55%RH</u>
Ferquency Range:	<u>1 – 25 GHz</u>	Test mode:	<u>Ch39</u>
Receiver Detector:	<u>PK. or AV.</u>	Measured Distance:	<u>3m</u>
Tested by:	<u>Jackson Lai</u>		

Antenna Polarization : Horizontal

Freq./MHz	Cable Loss (dB)	Ant. Fact. (dB)	Reading (dBuV)		Emission (dBuV/m)		Limit Line (dBuV/m)		Margin (dBuV/m)		AZ (o)	EL (m)
			PK	AV	PK	AV	PK	AV	PK	AV		
2441.00(F)	-32.23	28.08	81.3	51.5	77.2	47.4	N/A	N/A	N/A	N/A	278.5	1.00
2445.60	-32.23	28.09	47.3	*	43.1	*	74.0	54.0	-30.9	*	187.3	1.11
2452.75	-32.24	28.10	48.2	*	44.0	*	74.0	54.0	-30.0	*	153.4	1.07
2429.00	-32.21	28.06	48.0	*	43.8	*	74.0	54.0	-30.2	*	176.3	1.43
4882.00	-30.26	33.71	43.1	*	46.6	*	74.0	54.0	-27.4	*	276.3	1.32
7323.00	-29.04	36.36	42.6	*	49.9	*	74.0	54.0	-24.1	*	300.4	1.00

Antenna Polarization : Vertical

Freq./MHz	Cable Loss (dB)	Ant. Fact. (dB)	Reading (dBuV)		Emission (dBuV/m)		Limit Line (dBuV/m)		Margin (dBuV/m)		AZ (o)	EL (m)
			PK	AV	PK	AV	PK	AV	PK	AV		
2441.00(F)	-32.23	28.62	85.7	53.8	82.1	50.2	N/A	N/A	N/A	N/A	277.1	1.00
2445.88	-32.23	28.09	48.3	*	44.1	*	74.0	54.0	-29.9	*	178.2	1.03
2435.38	-32.22	28.07	45.3	*	41.2	*	74.0	54.0	-32.8	*	235.3	1.12
2462.00	-32.22	28.12	47.8	35.8	43.7	31.7	74.0	54.0	-30.3	-22.3	1.2	1.09
4882.00	-30.26	33.71	44.9	*	48.3	*	74.0	54.0	-25.7	*	266.3	1.33
7323.00	-29.04	36.36	47.7	*	55.0	*	74.0	54.0	-19.0	*	187.5	1.10

- NOTE :**
1. Measurement uncertainty is less than +/-4dB
 2. "*": Measurement does not apply for this frequency.
 3. Emission Level = Reading Value + Ant. Factor + Cable Loss
 4. The field strength of other emission frequencies were very low against the limit.
 - 5.(F):The field strength of fundamental frequency.



Temperature:	<u>26°C</u>	Humidity:	<u>55%RH</u>
Ferquency Range:	<u>1 – 25GHz</u>	Test mode:	<u>Ch78</u>
Receiver Detector:	<u>PK. or AV.</u>	Measured Distance:	<u>3m</u>
Tested by:	<u>Jackson Lai</u>		

Antenna Polarization : Horizontal

Freq./MHz	Cable Loss (dB)	Ant. Fact. (dB)	Reading (dBuV)		Emission (dBuV/m)		Limit Line (dBuV/m)		Margin (dBuV/m)		AZ (o)	EL (m)
			PK	AV	PK	AV	PK	AV	PK	AV		
2480.00(F)	-32.19	28.16	81.5	53.3	77.4	49.3	N/A	N/A	N/A	N/A	287.9	1.00
2483.50	-32.19	28.17	48.6	36.9	44.6	32.9	74.0	54.0	-29.4	-21.1	128.2	1.22
2484.40	-32.19	28.17	47.4	*	43.4	*	74.0	54.0	-30.6	*	198.3	1.17
2475.40	-32.20	28.15	47.4	*	43.3	*	74.0	54.0	-30.7	*	177.2	1.09
4960.00	-30.26	33.77	44.1	*	47.6	*	74.0	54.0	-26.4	*	12.8	1.32
7440.00	-28.95	36.45	42.8	*	50.3	*	74.0	54.0	-23.7	*	21.2	1.03

Antenna Polarization : Vertical

Freq./MHz	Cable Loss (dB)	Ant. Fact. (dB)	Reading (dBuV)		Emission (dBuV/m)		Limit Line (dBuV/m)		Margin (dBuV/m)		AZ (o)	EL (m)
			PK	AV	PK	AV	PK	AV	PK	AV		
2480.00(F)	-32.19	28.73	85.3	57.1	81.9	53.7	N/A	N/A	N/A	N/A	276.2	1.00
2483.50	-32.19	28.17	50.2	38.9	46.2	34.9	74.0	54.0	-27.8	-19.1	224.7	1.30
2484.80	-32.19	28.17	49.9	*	45.8	*	74.0	54.0	-28.2	*	254.7	1.12
2468.50	-32.21	28.14	47.7	*	43.6	*	74.0	54.0	-30.4	*	139.6	1.18
4960.00	-30.26	33.77	46.6	*	50.1	*	74.0	54.0	-23.9	*	182.4	1.02
7440.00	-28.95	36.45	47.8	*	55.3	*	74.0	54.0	-18.7	*	199.7	1.41

- NOTE :**
1. Measurement uncertainty is less than +/- 4dB
 2. "**": Measurement does not apply for this frequency.
 3. Emission Level = Reading Value + Ant. Factor + Cable Loss
 4. The field strength of other emission frequencies were very low against the limit.
 - 5.(F):The field strength of fundamental frquency.



**Spectrum Research &
Testing Lab., Inc.**
No. 101-10, Ling 8,
Shan-Tong Li, Chung-Li
City, Taoyuan, Taiwan

TEST REPORT

Reference No.:A03121108
Report No.:FCCA03121108
FCC ID:I4L-MS6850
Page:41 of 45
Date:Dec. 31, 2003

5. Antenna application

5.1 Antenna requirement

The EUT's antenna is met the requirement of FCC part15C section15.203 and 15.204.

FCC part15C section15.247 requirement:

Systems operating in the 2400-2483.5 MHz band that are used exclusively for fixed, point-to-point operations may employ transmitting antennas with directional gain greater than 6 dBi provided the maximum peak output power of the intentional radiator is reduced by 1 dB for every 3 dB that the directional gain of the antenna exceeds 6 dBi.

5.2 Result

The EUT's antenna used a dipole antenna and integrated on PCB. The antenna's gain is -3dBi and meets the requirement.



6. PHOTOS OF TESTING

- Couducted test

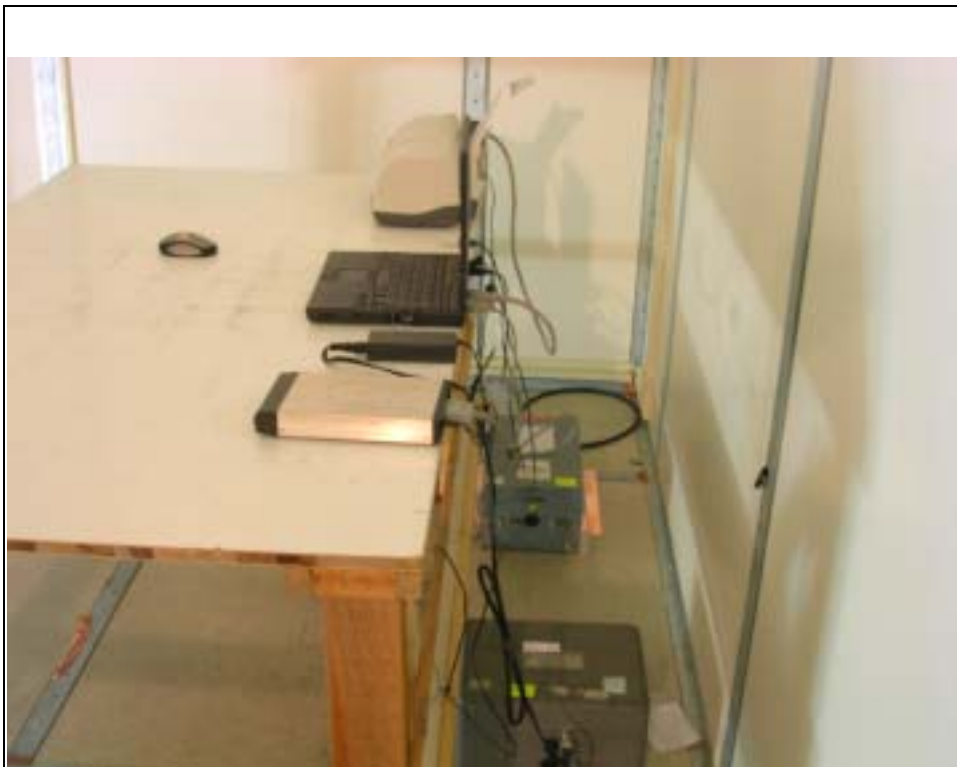



- Radiated test(RX)





Spectrum Research & Testing Lab., Inc.
No. 101-10, Ling 8,
Shan-Tong Li, Chung-Li
City, Taoyuan, Taiwan

TEST REPORT

Reference No.:A03121108
Report No.:FCCA03121108
FCC ID:I4L-MS6850
Page:44 of 45
Date:Dec. 31, 2003

- Radiated test(TX)





Spectrum Research & Testing Lab., Inc.
No. 101-10, Ling 8,
Shan-Tong Li, Chung-Li
City, Taoyuan, Taiwan

TEST REPORT

Reference No.:A03121108
Report No.:FCCA03121108
FCC ID:I4L-MS6850
Page:45 of 45
Date:Dec. 31, 2003

7. TERMS OF ABRIVATION

AV.	Average detection
AZ(°)	Turn table azimuth
Correct.	Correction
EL(m)	Antenna height (meter)
EUT	Equipment Under Test
Horiz.	Horizontal direction
LISN	Line Impedance Stabilization Network
NSA	Normalized Site Attenuation
Q.P.	Quasi-peak detection
SRT Lab	Spectrum Research & Testing Laboratory, Inc.
Vert.	Vertical direction