

零組件承認/申請報告書

編號 : E10358 2005/09/15

Alpha P/N : 505900046810G		申請者 : 屈豔青	主管 : 王燕龍
零組件品名 : ANT. 2.4G THW0468A1 BLACK(WS)			
零組件品名2 :			
原製造廠商 : (505780) 萬旭電業股份有限公司		原廠編號 : THW0468A1	
在台代理商 : 萬旭電業股份有限公司			
聯絡人 : 洪世澤		電話 : 02-22988066	
應用機種 :			
COMMENTS :			
測試結果 : OK			
		承辦人 : 屈豔青	日期 : 2005/08/29
結果	<input checked="" type="radio"/> 合格 <input type="radio"/> 否決 <input type="radio"/> 其他	審核	王椅楠 2005/08/30

承 認 書
SPECIFICATION FOR APPROVAL

客 戶
CUSTOMER

明泰科技股份有限公司

日 期
DATE

93 年 03 月 08 日

品 名
DESCRIPTION

Swivel Type , 1/4λ Dipole Antenna
(Black)
Reverse SMA Connector

客 戶 料 號
CUSTOMER P/N

成 品 編 號
Part No.

THW0468A1



萬旭電業股份有限公司

WANSHIH ELECTRONIC CO., LTD.

台北縣五股鄉五工六路 72 號 3 樓

3F 72 WU KONG 6TH RD., WU KU INDUSTRIAL DISTRICT

TAIPEI HSIEN, TAIWAN, R.O.C.

TEL : (02) 22988066 (5 LINE) FAX : (02)22981102

Table of Contents

Table of Contents	1
Specification	2
Antenna Drawing	3
Connector Drawing	4
Electrical Properties		
Return Loss	5
V.S.W.R	6
Radiation Pattern	7-8
Material Data Sheet		
Coaxial Cable	9-11
Housing	12
Hinge	13

SPECIFICATION

- | | |
|-------------------------------|--|
| 1. Description | : The antenna is a Swivel Type ,
Dipole Antenna |
| 2. Customer | : 明泰科技股份有限公司 |
| 3. Model No. | : WSS002 |
| 4. Part No. | : THW0468A1 |
| 5. Standard | : IEEE 802.11b/g Wireless LAN |
| 6. Antenna Profile | : 108 mm length (see Drawing) |
| 7. Color | : Black |
| 8. Electrical Characteristics | |
| Operating Frequency | : 2.4~2.5Ghz |
| Antenna Type | : $1/4\lambda$ Dipole Sleeve |
| Polarization Type | : Linear |
| Type of Radiation | : Toroidal |
| Peak Gain | : 2.0 dBi Typical |
| Impedance | : 50 Ohm nominal |
| V.S.W.R. | : 2.0:1 Max. |
| 9. Mechanical Characteristics | |
| Action | : Swivel Type |
| Connector | : SMA Reverse Connector |
| Core | : N/A |
| 10. Raw Material | |
| Coaxial Cable | : MIL-C-17 RG-178 B/U |
| Housing | : TPU |
| Hinge | : Polycarbonate |

TOLERANCES: X ± 0.5 X.X ± 0.2 X.XX ± 0.1 ANGULAR ± 5.0°	1	2	3	4	5
	版次	修訂日期	ECR NO.	作成	設計變更內容簡述

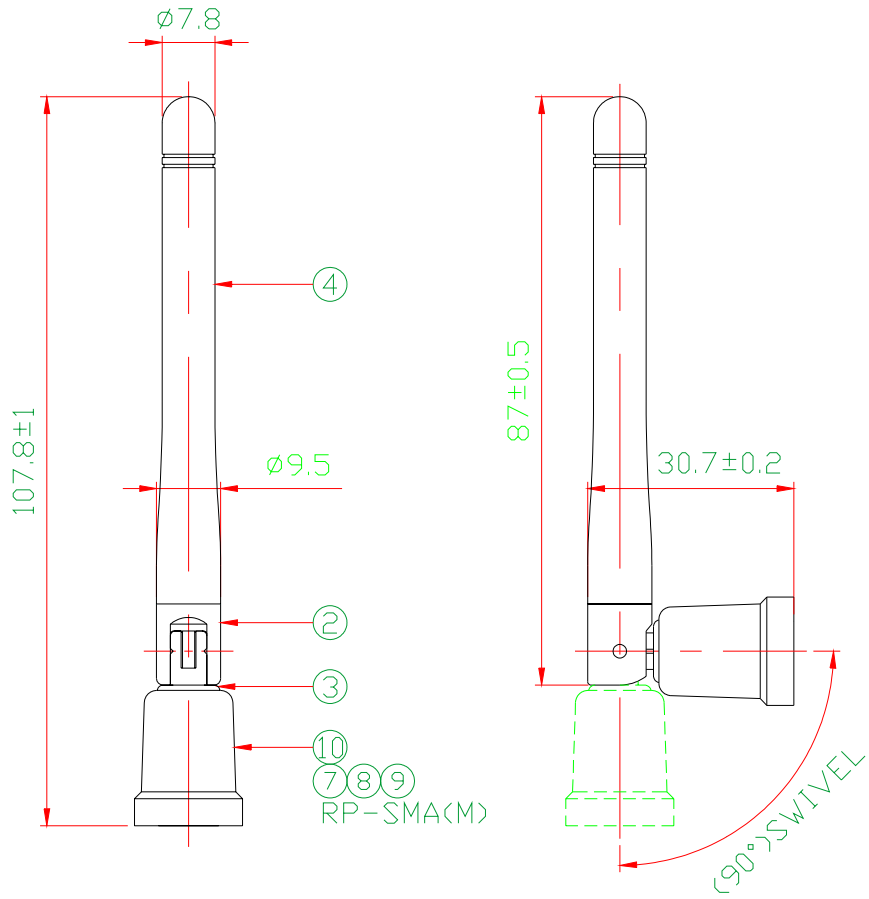

作業說明：
1. 天線本體，WSW0001A 2dBi 天線作業標準指導書規定製作。
依據 AQ-0001A QC管理工程圖，執行品質管制。

10	絕緣套	B620LFR93D0WA	20L絕緣套For 9.3D下座	黑		1	或同級品	
9	Reverse SMA 10 本體	25002BA1000VD	0202B-A Body Reverse SMA 10 Connector			1	或同級品	
8	Reverse SMA 10 PIN絕緣	250062BB2000VD	0062B-B PIN+TEFLON Reverse Reverse SMA 10			1	或同級品	
7	Reverse SMA 10 連接軸	250202BC1000VD	0202B-C1 銀連接軸 Reverse SMA 10 Connector	銀		1	或同級品	
6	銅管 L26	B0520260L00TWQ	@5.2 *26.0L*0.25T 銅管	銀		1	或同級品	
5	固定鉚釘	69231510000SM	23-15-1固定鉚釘鍍黑 1.90 ,3.8L	黑		2	或同級品	
4	外套黑	69950075L000WA	IY072BK000 9.5 *75L 外套黑	黑		1	或同級品	
3	下座 <黑>	699300000000WA	IY113BK000 9.3 下座<黑>	黑		1	或同級品	
2	上座 <黑>	699500000000WA	IY114BK000 9.5 上座<黑>	黑		1	或同級品	
1	RG-178 Coaxial Cable	19RG17800030AE	RG-178 CABLE 105SV(萬泰)	橙	94	1	或同級品	
NO	材料名稱	環材	電腦編號	零件規格	顏色	切斷尺寸	用量	備註

修訂日期：		制訂日期：93/03/04		承認圖號	
頁數：1/1	核准	審查	作成	品名	
第三角法	詹進和	Arthur	郭雅珍	SWIVEL TYPE, 1/4 DIPOLE ANTENNA RP-SMA (M) CONNECTOR (Black)	
單位：mm				成品編號	
比例：FREE				THW0468	
				REV	VERSION
				A	1

萬旭電業股份有限公司 文件編號：FMT-0513-C7

主件品名材質一覽表			
項次	品名	材質	處理
1	本體-1	銅	鍍黑鉻
2	本體-2	銅	鍍黑鋅
3	連接軸	銅	鍍銀
4	PIN	磷青銅	鍍金
5	絕緣	鐵氟龍	白色

圖號 0202B

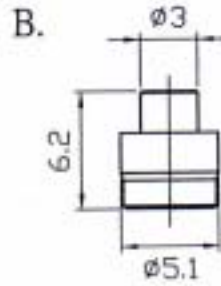
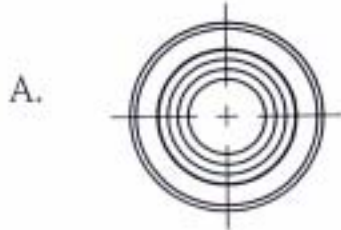

C. PIN與絕緣先行組合
PIN針需縮口處理

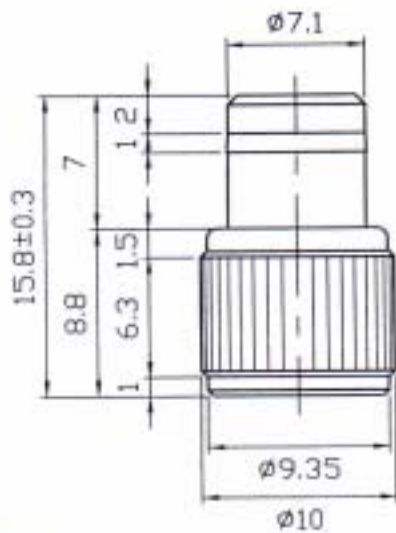
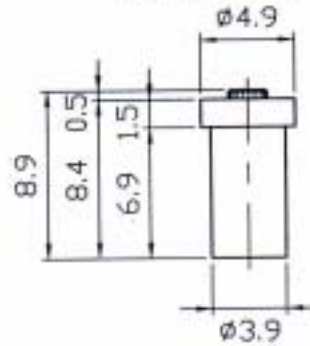

REV DESCRIPTION	UNIT: MM	MATERIAL:	NAME: RP-SMA(M) ϕ 10.0mm
\triangle x	SCALE: 3/1	FINISH:	PART NO: 0202B-承認書用
\triangle x	TOLERANCES:	DRAWN:	DATE: 05.25.2003 REV: 00
\triangle x	X ± 0.15	DESIGN:	萬旭電業股份有限公司
\triangle x	X.X ± 0.1	APPROVE:	
\triangle x	X.XX ± 0.05		
\triangle x	ANGULAR $\pm 1.0^\circ$		

Electrical Properties

Return Loss

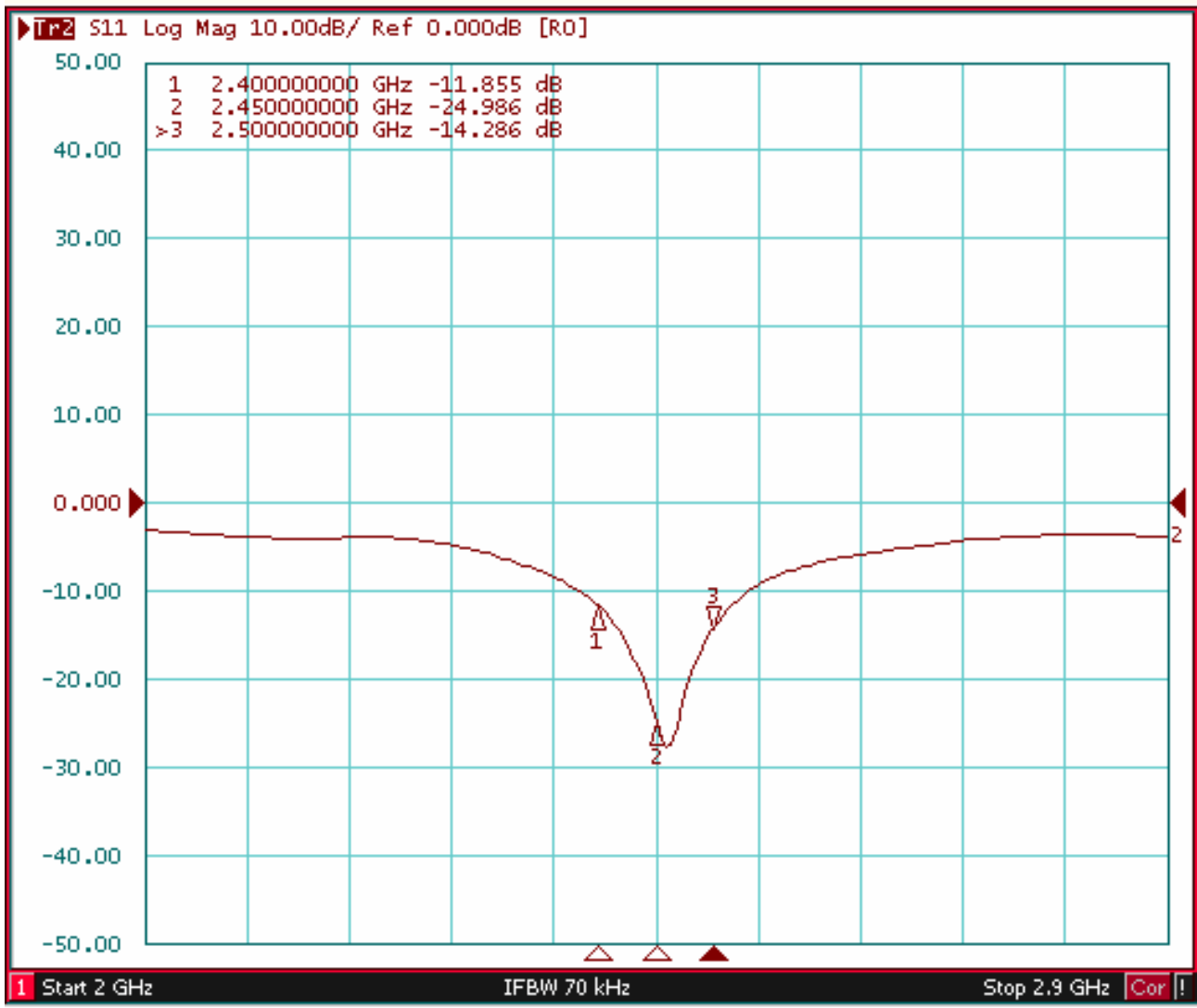

Electrical Properties

V.S.W.R

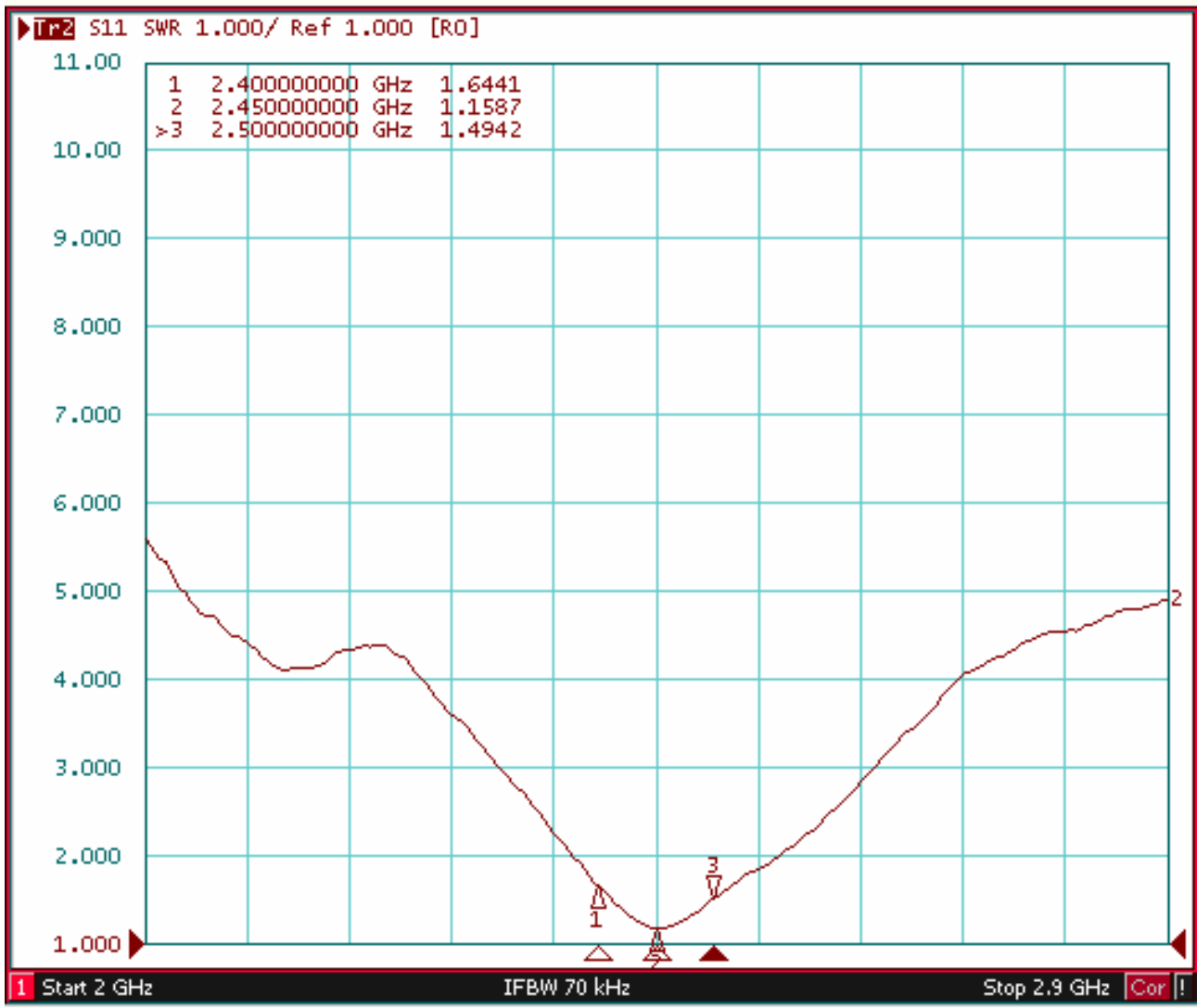

Electrical Properties

Radiation Pattern – H Plane



萬旭電業股份有限公司

Model No:

Antenna Position: Vertical

Test Mode: H-PLANE

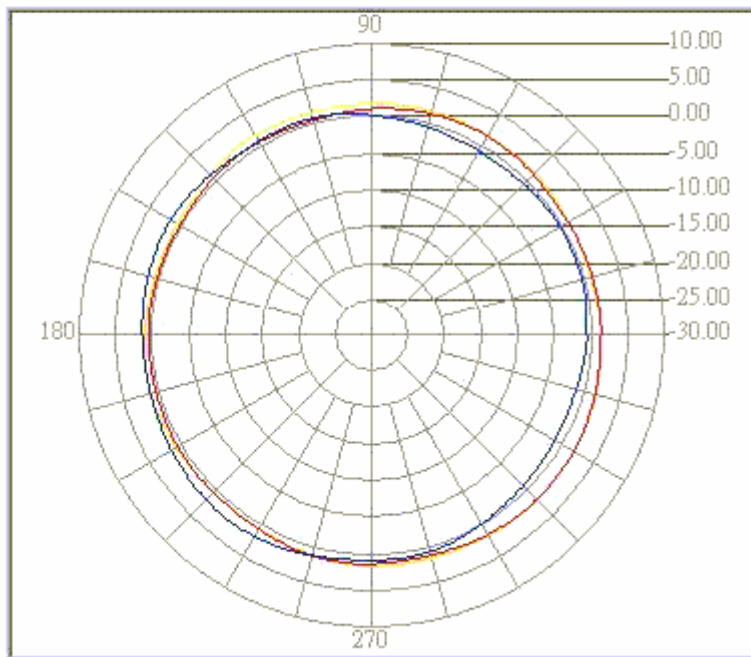

Freq(MHz)	peak(dBi)	Angle(o)	Avg(dBi)
2400.00	2.04	313.07	1.40
2450.00	2.02	322.95	1.11
2490.00	2.10	231.56	0.62

Electrical Properties

Radiation Pattern – E Plane



萬旭電業股份有限公司

Model No:

Antenna Position: Horizontal

Test Mode: E-PLANE

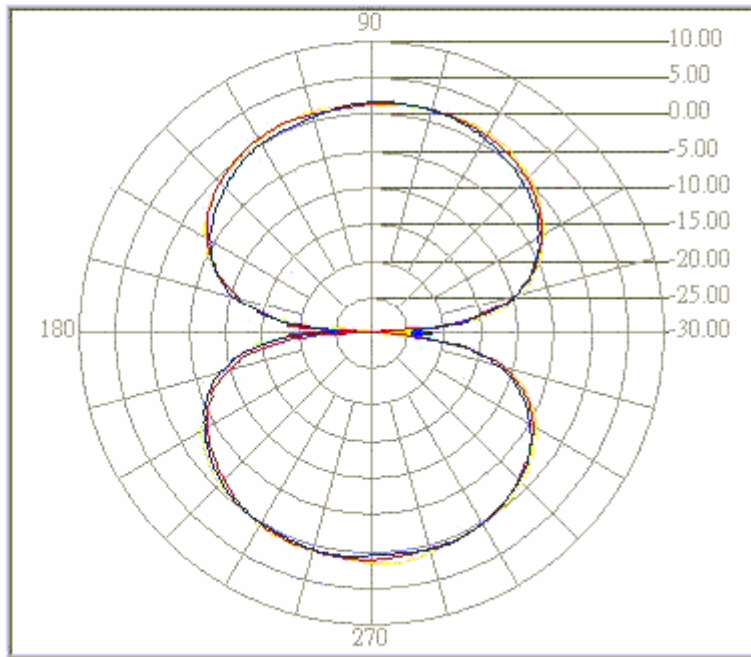

Freq(MHz)	peak(dBi)	Angle(o)	Avg(dBi)
2400.00	1.86	66.19	-1.03
2450.00	1.77	76.70	-1.27
2490.00	1.78	84.74	-1.49

Coaxial Cable Data Sheet
RG-178

SPECIFICATION FOR APPROVAL

DOCUMENT: A30178B001

STYLE : 200 30V
RG-178B/U

SIZE: 7/0.102 SCCS

RECOGNIZED:

WONDERFUL HI-TECH CO.,LTD

OFFICE : 72WU KONG 6TH ROAD,
WU KU IND. DISTRICT
TAIPEI HSIEN,TAIWAN

FACTORY : 17 PEI YUAN ROAD,
CHUNG-LI IND. PARK
TAIWAN, R.O.C.

TEL : (02)22988033
FAX : (02)22988031-2

TEL : (03)4527777
FAX : (03)4517214

WONDERFUL HI-TECH CO., LTD SPECIFICATION

STYLE	200 30V COAXIAL	DOCUMENT NO : A30178B001	
SIZE	RG-178B/U	ESTABLISHED DATE: 2003/02/13	
STANDARD : MIL-C-17			
Conductor	Size	AWG	30
	Material	----	Silver-Coated Copper Clad Steel
	Conductors No.	----	7
	Conductors Size	mm	0.102
	O.D.	mm	0.30
Insulation	Average Thickness	mm	0.28
	Diameter	mm	0.86
	Material	----	FEP
	Color	----	Clear
Braid	Material	----	Silver-Coated Copper
	Construction	mm	16 / 3 / 0.10
	Coverage	%	95
Jacket	Average Thickness	mm	0.25
	Diameter	mm	1.80 ±0.05
	Material	----	FEP
	Color	----	Brown
Marking			
Drawing			

AK001/210X297/1.0

PAGE : 1

EDITION : 1.1

REVISED DATE :

MAKER : C.Y.CHEN

CONFIRM : S.N.WONG

APPROVAL : W.J.WANG

WONDERFUL HI-TECH CO., LTD

SPECIFICATION

Electrical & Physical Properties						
Item		RG-178B/U				
Rating Temp Voltage		200 30V				
Conductor Resistance		838 OHM/KM/20 MAX.				
Insulation Resistance		3000 MEGA OHM/KM MIN.				
Dielectric Strength		AC 1.0 KV/Minute				
Spark Test		2.0 KV				
Insulation	Unaged	Tensile Strength	2500 PSI MIN.(1.76 Kg / m m ²)			
		Elongation	200% MIN.			
	Aged	Tensile Strength	UNAGED MIN 75%(168HRS×232)			
		Elongation	UNAGED MIN 75%(168HRS×232)			
Jacket	Unaged	Tensile Strength	2500 PSI MIN.(1.76 Kg / m m ²)			
		Elongation	200% MIN.			
	Aged	Tensile Strength	UNAGED MIN.75%(168HRS×232)			
		Elongation	UNAGED MIN.75%(168HRS×232)			
Nom. Impedance		50 Ohms				
Nom. Capacitance		95.8 pF/m				
Nom. Vel. of Prop.		69.5%				
VSWR (0 – 6 GHZ)		UNDER 1.3				
Attenuation (dB/100m)	100MHz	1GHz	1.8GHz	2.4GHz	5.2GHz	6GHz
	46	155	295	340	505	550

AK001/210X297/1.0

PAGE : 2

EDITION : 1.1

REVISED DATE :

MAKER : C.Y.CHEN

CONFIRM : S.N.WONG

APPROVAL : W.J.WANG

Housing Material Data Sheet

- Housing - TPU

Elastogran GmbH
Geschäftsbereich TPU-Elastomere



Elastogran GmbH - Postfach 1140 - 49440 Lamförde - Germany
WQJ COMPANY LTD.

P.O. BOX 36 - 431
RC TAOYUAN HSIEN

BASF Gruppe

Date 18.07.2001
No. 62046

Inspection Certificate EN 10 204-3.1 B (DIN 50048)

Product : ES 95 A 50 000 S No.: 15002939
Batch : 207672
Basic-Batch 207673

Property	Test method	Unit	Value
Dichte	DIN 53479	g/cm ³	1,24
Shore-Haerte D	DIN 53505	-	50
Zugfestigkeit	DIN 53504	MPa	53
Reissdehnung	DIN 53504	%	550
Abrieb	DIN 53516	mm ³	22

Dichte = Density/Densität, Shore Härte = Shore hardness/Shore Dureté, Zugfestigkeit = Tensile strength/Resistance traction,
Reißdehnung = Elongation at break/Allongement rupture, Weibenszweidenstand = Tear strength, Abrieb = Abrasion loss/Abrasion

The stated values are measured from a representative batch (basic-batch) of every product campaign.

Test platters are injection moulded from dry granulate with less than 0,05 % water content. Test platters tempered 20 hrs. at 100 °C,
then cooled to 23 °C / 50 % RH before testing. Test specimen cut from test platters.

We hereby certify, that the material described above complies with the terms of the order contract

Hübner Schoote

Works inspector

The above information is derived from our quality checks. It does not relieve the purchaser from examining the product upon delivery
and gives no assurance of suitability of the product for any particular purpose.

Landwehrweg
49448 Lamförde
Deutschland
Telefon (0 54 43) 12-0
Teletax (0 54 43) 12-25 55

Bankverbindung: Commerzbank AG, Osnabrück
(BLZ 265 400 70) Kto.-Nr. 53 56001/00
IBAN: DE 36 2654 0070 0535 6001 00
S.W.I.F.T.-Code: Cobadeff 265
Postbank München
(BLZ 700 100 80) Kto.-Nr. 1532 91 - 803

Sitz der Gesellschaft: 49448 Lamförde
Geschäftsführer:
Gerhard H.-J. Hellmann (Spracher)
Reinhard Leppkes
Registriergericht: Amtsgericht Diepholz
Eintragungsnummer: HRB 2183

- Hinge(Base/Holder)- Polycarbonate(PC)

DYNACHEM

TEIJIN POLYCARBONATE SINGAPORE PTE LTD.

152 BEACH ROAD #17-03/04
GATEWAY EAST SINGAPORE 189721

TELEPHONE: 295-8381
FAX: 298-6652

Date: OCT. 28, 2002

Att: To Whom it May Concern

CERTIFICATE OF ANALYSIS

COMMODITY: TEIJIN PANLITE (Polycarbonate Resin)

Grade No: L1250Y
Colour No: NAT
Lot No: S4E02911

ITEM	UNIT	TEST METHOD	TEIJIN POLYCARBONATE QUALITY STANDARD	TEST RESULT
IMPACT STRENGTH (IZOD NOTCHED 3.2mm thick)	K.gbm / cm	ASTM D256	≥80	PASS
FLEXURAL MODULUS	K.gf / cm ²	ASTM D790	22,700±1,500	PASS
TENSILE STRENGTH (AT BREAK)	K.gf / cm ²	ASTM D638	830±140	PASS

NOTE: ALL FIGURES ENTERED IN THIS LIST ARE SUBJECT TO OUR STANDARD TEST METHOD AND MAY NOT BE APPLICABLE FOR PRODUCTS THAT ARE USED UNDER DIFFERENT CONDITIONS.

Teijin Polycarbonate Pte Ltd

Chi Ling Chen

Y. SUZUKI
LOGISTICS MANAGER (SALES)