



Spectrum Research & Testing Lab., Inc.
No. 101-10, Ling 8,
Shan-Tong Li, Chung-Li
City, Taoyuan, Taiwan

TEST REPORT

Reference No.: C006032406
Report No.: FCCC05121206-02
FCC ID: I4L-MS6833B-M
Page: 1 of 96
Date: APR. 03, 2006

Product Name: Wireless LAN Card
Model No.: MS-6833B
Applicant: MICRO-STAR INT'L CO., LTD.
No. 69, Li-De St, Jung-He City, Taipei Hsien, Taiwan
Date of Receipt: Dec. 12, 2005
Finished date of Test: Jan. 06, 2006
Applicable Standards: 47 CFR Part 15, Subpart C
47 CFR Part 15, Subpart B
ANSI C63.4:2003

We, **Spectrum Research & Testing Laboratory Inc.**, hereby certify that one sample of the above was tested in our laboratory with positive results according to the above-mentioned standards. The records in the report are an accurate account of the results. Details of the results are given in the subsequent pages of this report.

Beside, the test report has to explain the EUT will be Class II changed for adding another 4 antennas.

However their gains of antennas are less than 3.42dBi of PIFA's Max, which are not tested in the report. Therefore we quote test data from the original report number: FCCC05121206 in support of the report.

The original FCC ID: I4L-MS6833B-M was approved by FCC, dated Mar. 28, 2006

Checked By : Nick Hsieh , Date: 2006-4-3
(Nick Hsieh)

Approved By : J Ho , Date: 4/3/2006
(Johnson Ho, Director)

NVLAP[®]

Lab Code: 200099-0



Table of Contents

1.	DOCUMENT POLICY AND TEST STATEMENT	4
1.1	DOCUMENT POLICY	4
1.2	TEST STATEMENT	4
1.3	EUT MODIFICATION	4
2.	DESCRIPTION OF EUT AND TEST MODE	5
2.1	GENERAL DESCRIPTION OF EUT	5
2.2	DESCRIPTION OF EUT INTERNAL DEVICE	6
2.3	DESCRIPTION OF TEST MODE	7
2.4	DESCRIPTION OF SUPPORT UNIT	7
3.	DESCRIPTION OF APPLIED STANDARDS	8
4.	TECHNICAL CHARACTERISTICS TEST	9
4.1	CONDUCTED EMISSION TEST	9
4.1.1	LIMIT	9
4.1.2	TEST EQUIPMENT	9
4.1.3	TEST SETUP	10
4.1.4	TEST PROCEDURE	10
4.1.5	EUT OPERATING CONDITION	10
4.1.6	TEST RESULT	11
4.2	RADIATED EMISSION TEST	25
4.2.1	LIMIT	25
4.2.2	TEST EQUIPMENT	26
4.2.3	TEST SET-UP	27
4.2.4	TEST PROCEDURE	28
4.2.5	EUT OPERATING CONDITION	28
4.2.6	TEST RESULT	29
4.3	6DBM BANDWIDTH TEST	43
4.3.1	LIMIT	43
4.3.2	TEST EQUIPMENT	43
4.3.3	TEST SET-UP	43
4.3.4	TEST PROCEDURE	43
4.3.5	EUT OPERATING CONDITION	43
4.3.6	TEST RESULT	44
4.4	PEAK POWER TEST	52
4.4.1	LIMIT	52
4.4.2	TEST EQUIPMENT	52
4.4.3	TEST SET-UP	53
4.4.4	TEST PROCEDURE	53
4.4.5	EUT OPERATING CONDITION	53
4.4.6	TEST RESULT	54
4.5	BAND EDGE TEST	62
4.5.1	LIMIT	62
4.5.2	TEST EQUIPMENT	62
4.5.3	TEST SET-UP	63
4.5.4	TEST PROCEDURE	64
4.5.5	EUT OPERATING CONDITION	64



**Spectrum Research &
Testing Lab., Inc.**
No. 101-10, Ling 8,
Shan-Tong Li, Chung-Li
City, Taoyuan, Taiwan

TEST REPORT

Reference No.: C006032406
Report No.: FCCC05121206-02
FCC ID: I4L-MS6833B-M
Page:3 of 96
Date: APR. 09, 2006

4.5.6 TEST RESULT	65
4.6 POWER DENSITY TEST	73
4.6.1 LIMIT	73
4.6.2 TEST EQUIPMENT	73
4.6.3 TEST SET-UP	73
4.6.4 TEST PROCEDURE	73
4.6.5 EUT OPERATING CONDITION	73
4.6.6 TEST RESULT	74
4.7 RF POWER EXPOSURE EVALUATION TEST	82
4.7.1 LIMIT	82
4.7.2 TEST EQUIPMENT	83
4.7.3 TEST SET-UP	83
4.7.4 TEST PROCEDURE	84
4.7.5 EUT OPERATING CONDITION	84
4.7.6 CONNECT POWER AT THE ANTENNA CONNECTOR RESULT	85
5. ANTENNA APPLICATION	87
5.1 ANTENNA REQUIREMENT	87
5.2 RESULT	87
6. PHOTOS OF TESTING	88
7. TERMS OF ABRIVATION	96



**Spectrum Research &
Testing Lab., Inc.**
No. 101-10, Ling 8,
Shan-Tong Li, Chung-Li
City, Taoyuan, Taiwan

TEST REPORT

Reference No.: C006032406
Report No.: FCCC05121206-02
FCC ID: I4L-MS6833B-M
Page:4 of 96
Date: APR. 09, 2006

1. DOCUMENT POLICY AND TEST STATEMENT

1.1 DOCUMENT POLICY

- The report shall not be reproduced except in full, without the written approval of SRT Lab, Inc.
- The report must not be used by the applicant to claim that the product is endorsed by NVLAP, TÜV, NEMKO and SRT.
- The NVLAP logo applies only to the applicable standards specified in this report.

1.2 TEST STATEMENT

- The test results in the report apply only to the unit tested by SRT Lab.
- There was no deviation from the requirements of test standards during the test.
- AC power source, 120 Vac/60 Hz, was used during the test.

1.3 EUT MODIFICATION

- No modification in SRT Lab.



Spectrum Research & Testing Lab., Inc.
No. 101-10, Ling 8,
Shan-Tong Li, Chung-Li
City, Taoyuan, Taiwan

TEST REPORT

Reference No.: C006032406
Report No.: FCCC05121206-02
FCC ID: I4L-MS6833B-M
Page:5 of 96
Date: APR. 09, 2006

2. DESCRIPTION OF EUT AND TEST MODE

2.1 GENERAL DESCRIPTION OF EUT

PRODUCT	Wireless LAN Card
MODEL NO.	MS-6833B
POWER SUPPLY	DC 3.3V, 410mA
FREQUENCY BAND	2.4 ~ 2.4835 GHz
NUMBER OF CHANNEL	11
CHANNEL SPACING	20MHz
RATED RF OUTPUT POWER	EIRP \leq 20 dBm
I.F. & L.O.	I.F.: 374 MHz; L.O.: 2730-2900MHz
MODULATION TYPE	OFDM, CCK
BIT RATE OF TRANSMISSION	1Mbps
DUTY CYCLE	10%
MODE OF OPERATION	duplex
BIT RATE/SPEED OF TRANSMISSION	11B: 1, 2, 5.5, 11Mbps; 11G: 6, 9, 12, 18, 24, 36, 48, 54Mbps
ANTENNA TYPE	Dipole, PIFA

NOTE :

For more detailed information, please refer to the EUT's specification or user's manual provided by manufacturer.



TEST REPORT

All Antennas were checked:

No.	Model #	Type of Ant.	Max. Ant Gain (dBi)	Be Tested
1	505900000110	DIPOLE	2.46	
2	5059000090110G	DIPOLE	0.80	
3	YQ-Z009-0545	DIPOLE	2.99	
4	RFA-02-3-C5H1-06-50	DIPOLE	2.52	
5	RFA-02-3-C5M3	DIPOLE	3.66	
6	RFA-02-5-F7H1-06-50	DIPOLE	3.94	√
7	M560A SK560WIPI01A	PIFA	0.87	
8	M540G K05007000403	PIFA	0.78	
9	M30	PIFA	0.98	
10	C05092208_1	PIFA	0.85	
11	THW1139A1	PIFA	3.42	√
12	EY1002430060R	DIPOLE	2.20	
13	CAN4313552012501B(L) CAN4313552022501B(R)	PIFA	-0.15	
14	0ACMS006004N(L) 0ACMS006005N(R)	PIFA	2.61	
15	SAA05-220580(L) SAA05-22058A(R)	PIFA	-4	
16	MS104-05351A	PIFA	2.31	

We tested antenna 6 (RFA-02-5-F7H1-06-50) (DIPOLE) and antenna 11 (THW1139A1) (PIFA). Both were worst case.

2.2 DESCRIPTION OF EUT INTERNAL DEVICE

DEVICE	BRAND / MAKER	MODEL	FCC ID/DOC	REMARK



2.3 DESCRIPTION OF TEST MODE

11 channels are provided by EUT. The 3 channels of lower, medium and higher were chosen for test.

There are test modes for each test configuration as below:

Mode	Modulation Type	Channel	Frequency (MHz)	
1	IEEE 802.11g	OFDM	CH1	2412
2			CH6	2437
3			CH11	2462
4	IEEE 802.11b	CCK	CH1	2412
5			CH6	2437
6			CH11	2462

NOTE :

1. Below 1 GHz, the channel 1, 6 and 11 were pre-tested in chamber. The channel 11, worst case one, was chosen for conducted and radiated emission test.
2. Above 1 GHz, the channel 1, 6 and 11 were tested individually

2.4 DESCRIPTION OF SUPPORT UNIT

The EUT was configured by the requirement of ANSI C63.4:2003. All interface ports were connected to the appropriate support units via specific cables. The support units and cables are listed below.

NO	DEVICE	BRAND	MODEL	FCC ID/ DOC	CABLE
1	NOTEBOOK	COMPAQ	PRESARIO B2000	N/A	1.8m unshielded power cord
2	PRINTER	EPSON	STYLUS C20SX	DOC	1.5m unshielded power cord 1.5m shielded data cord
3	USB HD	TERASYS	F12-UF	DOC	1.5m shielded data cord
4	WIRELESS HUB	PRISM	NCP600	N/A	1.8m unshielded power cord
5	Mini PCI to PCMCIA Card	N/A	N/A	N/A	N/A

NOTE : For the actual test configuration, please refer to the photos of testing.



**Spectrum Research &
Testing Lab., Inc.**
No. 101-10, Ling 8,
Shan-Tong Li, Chung-Li
City, Taoyuan, Taiwan

TEST REPORT

Reference No.: C006032406
Report No.: FCCC05121206-02
FCC ID: I4L-MS6833B-M
Page:8 of 96
Date: APR. 09, 2006

3. DESCRIPTION OF APPLIED STANDARDS

The EUT is a kind of wireless product. According to the specifications provided by the applicant, it must comply with the requirements of the following standards:

47 CFR Part 15, Subpart C

47 CFR Part 15, Subpart B

ANSI C63.4: 2003

Public DA00-1407 (March 2000)

All tests have been performed and recorded as the above standards.



4. TECHNICAL CHARACTERISTICS TEST

4.1 CONDUCTED EMISSION TEST

4.1.1 LIMIT

Frequency (MHz)	Class A (dB μ V)		Class B (dB μ V)	
	Quasi-peak	Average	Quasi-peak	Average
0.15 - 0.5	79	66	66 - 56	56 - 46
0.50 - 5.0	73	60	56	46
5.0 - 30.0	73	60	60	50

NOTE :

1. The lower limit shall apply at the transition frequencies.
2. The limit decreases in line with the logarithm of the frequency in the range of 0.15 to 0.50 MHz.

4.1.2 TEST EQUIPMENT

The following test equipment was used for the test:

EQUIPMENT/ FACILITIES	SPECIFICATIONS	MANUFACTURER	MODEL#/ SERIAL#	DUE DATE OF CAL. & CAL. CENTER
EMI TEST RECEIVER	9 kHz TO 30 MHz	ROHDE & SCHWARZ	ESHS30/ 826003/008	AUG. 2006 ETC
LISN (for EUT)	50 μ H, 50 ohm	FCC	FCC-LISN-50-25-2 / 01017	NOV. 2006 ETC
LISN (for Peripheral)	50 μ H, 50 ohm	FCC	FCC-LISN-50-25-2 / 01018	NOV. 2006 ETC
50 ohm TERMINATOR	50 ohm	HP	11593A/ 2	OCT. 2006 ETC
COAXIAL CABLE	3m	SUNCITY	J400/ 3M	JUL. 2006 SRT
ISOLATION TRANSFORMER	N/A	APC	AFC-11015/ F102040016	N/A
FILTER	2 LINE, 30A	FIL.COIL	FC-943/ 771	N/A
GROUND PLANE	2.3M (H) x 2.4M (W)	SRT	N/A	N/A
GROUND PLANE	2.4M (H) x 2.4M (W)	SRT	N/A	N/A

NOTE: The calibration interval of the above test equipment is one year and the calibrations are traceable to NML/ROC and NIST/USA.



4.1.3 TEST SETUP

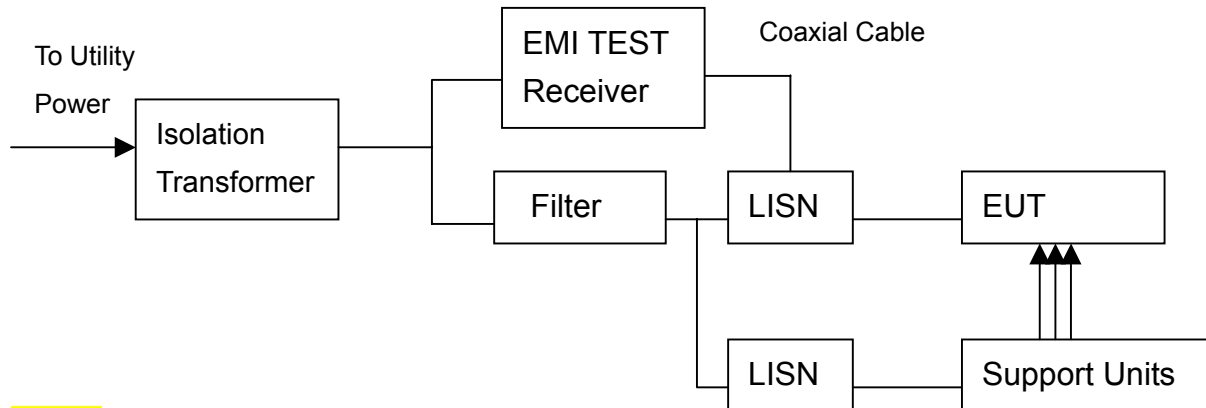

NOTE :

1. The EUT was put on a wooden table with 0.8m heights above ground plane, and 0.4m away from reference ground plane (> 2mx2m).
2. For the actual test configuration, please refer to the photos of testing.
3. The serial no. of the LISN connected to EUT is 01017.
4. The serial no. of the LISN connected to support units is 01018.

4.1.4 TEST PROCEDURE

The EUT was tested according to the requirement of ANSI C63.4:2003 and CISPR22:2003. The frequency spectrum from 0.15 MHz to 30 MHz was investigated. The LISN used was 50 ohm/50 μ H as specified. All readings were quasi-peak and average values with 10 kHz resolution bandwidth of the test receiver. The EUT system was operated in all typical methods by users. Both lines of the power mains of EUT were measured and the cables connected to EUT and support units were moved to find the maximum emission levels for each frequency. First, find the margin or higher points at least 6 points by software, then use manual to find the maximum data. The procedure is referred on the test procedure of SRT LAB.

4.1.5 EUT OPERATING CONDITION

1. Under Windows XP ran "EMI TEST" program and PC sent "H" pattern or accessed the following peripherals directly or via EUT:
 - NB
 - USB HD
 - Printer
 - Mini PCI to PCMCIA Card
 - Wireless HUB



4.1.6 TEST RESULT

Temperature:	21 °C	Humidity:	68 %RH
Frequency Range:	0.15 – 30 MHz	Tested Mode:	Link
Receiver Detector:	Q.P. and AV.	Modulation Type:	N/A
Tested By:	Nick Hsieh	Tested Channel:	N/A
Antenna Type:	PIFA	Tested Date:	Dec. 27, 2005

Power Line Measured : Line

Freq. (MHz)	Correct. Factor (dB)	Reading Value (dB μ V)		Emission Level (dB μ V)		Limit (dB μ V)		Margin (dB)	
		Q.P.	AV.	Q.P.	AV.	Q.P.	AV.	Q.P.	AV.
0.183	0.30	55.48	43.79	55.78	44.09	64.33	54.33	-8.55	-10.24
0.189	0.30	55.62	43.93	55.92	44.23	64.06	54.06	-8.14	-9.83
1.004	0.14	36.60	21.92	36.74	22.06	56.00	46.00	-19.26	-23.94
1.368	0.15	36.82	22.13	36.97	22.28	56.00	46.00	-19.03	-23.72
1.457	0.15	35.12	22.25	35.27	22.40	56.00	46.00	-20.73	-23.60
9.131	0.23	31.86	26.46	32.09	26.69	60.00	50.00	-27.91	-23.31

Power Line Measured : Neutral

Freq. (MHz)	Correct. Factor (dB)	Reading Value (dB μ V)		Emission Level (dB μ V)		Limit (dB μ V)		Margin (dB)	
		Q.P.	AV.	Q.P.	AV.	Q.P.	AV.	Q.P.	AV.
0.186	0.30	53.50	31.81	53.80	32.11	64.20	54.20	-10.40	-22.09
0.192	0.30	54.34	38.64	54.64	38.94	63.93	53.93	-9.29	-14.99
1.052	0.14	35.40	20.71	35.54	20.85	56.00	46.00	-20.46	-25.15
1.378	0.15	35.06	22.52	35.21	22.67	56.00	46.00	-20.79	-23.33
1.418	0.15	33.92	21.05	34.07	21.20	56.00	46.00	-21.93	-24.80
9.111	0.23	33.92	28.52	34.15	28.75	60.00	50.00	-25.85	-21.25

NOTE :

1. Measurement uncertainty is +/-1.32dB
2. Emission level = Reading value + Correction factor
3. Correction Factor = Cable loss + Insertion loss of LISN
4. Margin value = Emission level - Limit
5. The emission of other frequencies were very low against the limit.
6. "-": The Quasi-peak reading value also meets average limit and measurement with the average detector is unnecessary.



Temperature:	21 °C	Humidity:	68 %RH
Frequency Range:	0.15 – 30 MHz	Tested Mode:	IEEE 802.11g
Receiver Detector:	Q.P. and AV.	Modulation Type:	OFDM
Tested By:	Nick Hsieh	Tested Channel:	CH1: 2412MHz
Antenna Type:	PIFA	Tested Date:	Dec. 27, 2005

Power Line Measured : Line

Freq. (MHz)	Correct. Factor (dB)	Reading Value (dB μ V)		Emission Level (dB μ V)		Limit (dB μ V)		Margin (dB)	
		Q.P.	AV.	Q.P.	AV.	Q.P.	AV.	Q.P.	AV.
0.195	0.30	42.80	18.32	43.10	18.62	63.80	53.80	-20.70	-35.18
0.210	0.28	51.64	32.32	51.92	32.60	63.19	53.19	-11.26	-20.58
1.100	0.14	38.02	26.01	38.16	26.15	56.00	46.00	-17.84	-19.85
1.230	0.14	35.82	22.00	35.96	22.14	56.00	46.00	-20.04	-23.86
1.250	0.14	36.70	22.88	36.84	23.02	56.00	46.00	-19.16	-22.98
9.131	0.23	32.10	26.45	32.33	26.68	60.00	50.00	-27.67	-23.32

Power Line Measured : Neutral

Freq. (MHz)	Correct. Factor (dB)	Reading Value (dB μ V)		Emission Level (dB μ V)		Limit (dB μ V)		Margin (dB)	
		Q.P.	AV.	Q.P.	AV.	Q.P.	AV.	Q.P.	AV.
0.201	0.28	48.80	24.32	49.08	24.60	63.55	53.55	-14.47	-28.95
0.207	0.28	50.76	31.44	51.04	31.72	63.31	53.31	-12.26	-21.58
1.158	0.14	33.60	20.69	33.74	20.83	56.00	46.00	-22.26	-25.17
1.279	0.14	35.44	21.62	35.58	21.76	56.00	46.00	-20.42	-24.24
1.299	0.14	35.58	22.45	35.72	22.59	56.00	46.00	-20.28	-23.41
9.131	0.23	33.80	28.15	34.03	28.38	60.00	50.00	-25.97	-21.62

NOTE :

1. Measurement uncertainty is +/-1.32dB
2. Emission level = Reading value + Correction factor
3. Correction Factor = Cable loss + Insertion loss of LISN
4. Margin value = Emission level - Limit
5. The emission of other frequencies were very low against the limit.
6. "-": The Quasi-peak reading value also meets average limit and measurement with the average detector is unnecessary.



TEST REPORT

Temperature:	21 °C	Humidity:	68 %RH
Frequency Range:	0.15 – 30 MHz	Tested Mode:	IEEE 802.11g
Receiver Detector:	Q.P. and AV.	Modulation Type:	OFDM
Tested By:	Nick Hsieh	Tested Channel:	CH6: 2437MHz
Antenna Type:	PIFA	Tested Date:	Dec. 27, 2005

Power Line Measured : Line

Freq. (MHz)	Correct. Factor (dB)	Reading Value (dB μ V)		Emission Level (dB μ V)		Limit (dB μ V)		Margin (dB)	
		Q.P.	AV.	Q.P.	AV.	Q.P.	AV.	Q.P.	AV.
0.204	0.28	43.50	24.45	43.78	24.73	63.43	53.43	-19.65	-28.70
0.207	0.28	50.06	26.47	50.34	26.75	63.31	53.31	-12.96	-26.55
1.134	0.14	38.28	27.30	38.42	27.44	56.00	46.00	-17.58	-18.56
1.329	0.15	37.20	25.50	37.35	25.65	56.00	46.00	-18.65	-20.35
1.398	0.15	35.90	24.76	36.05	24.91	56.00	46.00	-19.95	-21.09
9.304	0.23	31.86	23.96	32.09	24.19	60.00	50.00	-27.91	-25.81

Power Line Measured : Neutral

Freq. (MHz)	Correct. Factor (dB)	Reading Value (dB μ V)		Emission Level (dB μ V)		Limit (dB μ V)		Margin (dB)	
		Q.P.	AV.	Q.P.	AV.	Q.P.	AV.	Q.P.	AV.
0.210	0.28	50.36	25.31	50.64	25.59	63.19	53.19	-12.54	-27.59
0.225	0.28	50.08	36.12	50.36	36.40	62.62	52.62	-12.25	-16.21
0.946	0.17	36.76	25.01	36.93	25.18	56.00	46.00	-19.07	-20.82
1.299	0.14	32.96	19.32	33.10	19.46	56.00	46.00	-22.90	-26.54
1.378	0.15	35.42	23.69	35.57	23.84	56.00	46.00	-20.43	-22.16
9.212	0.23	33.48	27.98	33.71	28.21	60.00	50.00	-26.29	-21.79

NOTE :

1. Measurement uncertainty is +/-1.32dB
2. Emission level = Reading value + Correction factor
3. Correction Factor = Cable loss + Insertion loss of LISN
4. Margin value = Emission level - Limit
5. The emission of other frequencies were very low against the limit.
6. "-": The Quasi-peak reading value also meets average limit and measurement with the average detector is unnecessary.



Temperature:	21 °C	Humidity:	68 %RH
Frequency Range:	0.15 – 30 MHz	Tested Mode:	IEEE 802.11g
Receiver Detector:	Q.P. and AV.	Modulation Type:	OFDM
Tested By:	Nick Hsieh	Tested Channel:	CH11: 2462MHz
Antenna Type:	PIFA	Tested Date:	Dec. 27, 2005

Power Line Measured : Line

Freq. (MHz)	Correct. Factor (dB)	Reading Value (dB μ V)		Emission Level (dB μ V)		Limit (dB μ V)		Margin (dB)	
		Q.P.	AV.	Q.P.	AV.	Q.P.	AV.	Q.P.	AV.
0.210	0.28	45.98	25.50	46.26	25.78	63.19	53.19	-16.92	-27.40
0.219	0.28	49.94	32.42	50.22	32.70	62.84	52.84	-12.62	-20.14
1.114	0.14	37.34	26.27	37.48	26.41	56.00	46.00	-18.52	-19.59
1.220	0.14	32.36	21.98	32.50	22.12	56.00	46.00	-23.50	-23.88
1.329	0.15	35.78	26.72	35.93	26.87	56.00	46.00	-20.07	-19.13
9.405	0.23	31.78	27.48	32.01	27.71	60.00	50.00	-27.99	-22.29

Power Line Measured : Neutral

Freq. (MHz)	Correct. Factor (dB)	Reading Value (dB μ V)		Emission Level (dB μ V)		Limit (dB μ V)		Margin (dB)	
		Q.P.	AV.	Q.P.	AV.	Q.P.	AV.	Q.P.	AV.
0.210	0.28	45.68	25.20	45.96	25.48	63.19	53.19	-17.22	-27.70
0.219	0.28	49.98	32.46	50.26	32.74	62.84	52.84	-12.58	-20.10
1.134	0.14	35.76	24.36	35.90	24.50	56.00	46.00	-20.10	-21.50
1.339	0.15	34.04	21.42	34.19	21.57	56.00	46.00	-21.81	-24.43
1.398	0.15	34.50	24.41	34.65	24.56	56.00	46.00	-21.35	-21.44
9.395	0.23	32.96	27.69	33.19	27.92	60.00	50.00	-26.81	-22.08

NOTE :

1. Measurement uncertainty is +/-1.32dB
2. Emission level = Reading value + Correction factor
3. Correction Factor = Cable loss + Insertion loss of LISN
4. Margin value = Emission level - Limit
5. The emission of other frequencies were very low against the limit.
6. "-": The Quasi-peak reading value also meets average limit and measurement with the average detector is unnecessary.



Temperature:	21 °C	Humidity:	68 %RH
Frequency Range:	0.15 – 30 MHz	Tested Mode:	IEEE 802.11b
Receiver Detector:	Q.P. and AV.	Modulation Type:	CCK
Tested By:	Nick Hsieh	Tested Channel:	CH1: 2412MHz
Antenna Type:	PIFA	Tested Date:	Dec. 27, 2005

Power Line Measured : Line

Freq. (MHz)	Correct. Factor (dB)	Reading Value (dB μ V)		Emission Level (dB μ V)		Limit (dB μ V)		Margin (dB)	
		Q.P.	AV.	Q.P.	AV.	Q.P.	AV.	Q.P.	AV.
0.222	0.28	48.46	30.96	48.74	31.24	62.73	52.73	-13.98	-21.48
0.225	0.28	47.52	36.60	47.80	36.88	62.62	52.62	-14.81	-15.73
1.191	0.14	37.74	31.47	37.88	31.61	56.00	46.00	-18.12	-14.39
1.398	0.15	35.74	29.47	35.89	29.62	56.00	46.00	-20.11	-16.38
1.487	0.15	30.84	24.57	30.99	24.72	56.00	46.00	-25.01	-21.28
9.557	0.23	31.28	25.01	31.51	25.24	60.00	50.00	-28.49	-24.76

Power Line Measured : Neutral

Freq. (MHz)	Correct. Factor (dB)	Reading Value (dB μ V)		Emission Level (dB μ V)		Limit (dB μ V)		Margin (dB)	
		Q.P.	AV.	Q.P.	AV.	Q.P.	AV.	Q.P.	AV.
0.219	0.28	45.68	28.18	45.96	28.46	62.84	52.84	-16.88	-24.38
0.231	0.28	48.66	37.74	48.94	38.02	62.40	52.40	-13.45	-14.37
1.191	0.14	36.02	29.75	36.16	29.89	56.00	46.00	-19.84	-16.11
1.200	0.14	37.32	30.80	37.46	30.94	56.00	46.00	-18.54	-15.06
1.418	0.15	33.98	25.37	34.13	25.52	56.00	46.00	-21.87	-20.48
9.182	0.23	33.02	27.62	33.25	27.85	60.00	50.00	-26.75	-22.15

NOTE :

1. Measurement uncertainty is +/-1.32dB
2. Emission level = Reading value + Correction factor
3. Correction Factor = Cable loss + Insertion loss of LISN
4. Margin value = Emission level - Limit
5. The emission of other frequencies were very low against the limit.
6. "-": The Quasi-peak reading value also meets average limit and measurement with the average detector is unnecessary.



Temperature:	21 °C	Humidity:	68 %RH
Frequency Range:	0.15 – 30 MHz	Tested Mode:	IEEE 802.11b
Receiver Detector:	Q.P. and AV.	Modulation Type:	CCK
Tested By:	Nick Hsieh	Tested Channel:	CH6: 2437MHz
Antenna Type:	PIFA	Tested Date:	Dec. 27, 2005

Power Line Measured : Line

Freq. (MHz)	Correct. Factor (dB)	Reading Value (dB μ V)		Emission Level (dB μ V)		Limit (dB μ V)		Margin (dB)	
		Q.P.	AV.	Q.P.	AV.	Q.P.	AV.	Q.P.	AV.
0.222	0.28	46.66	34.58	46.94	34.86	62.73	52.73	-15.78	-17.86
0.231	0.28	48.74	36.66	49.02	36.94	62.40	52.40	-13.37	-15.45
1.182	0.14	37.48	29.09	37.62	29.23	56.00	46.00	-18.38	-16.77
1.200	0.14	38.68	32.41	38.82	32.55	56.00	46.00	-17.18	-13.45
1.438	0.15	35.76	29.49	35.91	29.64	56.00	46.00	-20.09	-16.36
9.161	0.23	31.40	25.13	31.63	25.36	60.00	50.00	-28.37	-24.64

Power Line Measured : Neutral

Freq. (MHz)	Correct. Factor (dB)	Reading Value (dB μ V)		Emission Level (dB μ V)		Limit (dB μ V)		Margin (dB)	
		Q.P.	AV.	Q.P.	AV.	Q.P.	AV.	Q.P.	AV.
0.228	0.28	48.76	36.68	49.04	36.96	62.51	52.51	-13.46	-15.54
0.234	0.28	49.36	37.78	49.64	38.06	62.29	52.29	-12.65	-14.23
1.182	0.14	36.18	27.79	36.32	27.93	56.00	46.00	-19.68	-18.07
1.200	0.14	37.68	31.23	37.82	31.37	56.00	46.00	-18.18	-14.63
1.428	0.15	34.90	27.68	35.05	27.83	56.00	46.00	-20.95	-18.17
9.121	0.23	33.14	27.53	33.37	27.76	60.00	50.00	-26.63	-22.24

NOTE :

1. Measurement uncertainty is +/-1.32dB
2. Emission level = Reading value + Correction factor
3. Correction Factor = Cable loss + Insertion loss of LISN
4. Margin value = Emission level - Limit
5. The emission of other frequencies were very low against the limit.
6. "-": The Quasi-peak reading value also meets average limit and measurement with the average detector is unnecessary.



Temperature:	21 °C	Humidity:	68 %RH
Frequency Range:	0.15 – 30 MHz	Tested Mode:	IEEE 802.11b
Receiver Detector:	Q.P. and AV.	Modulation Type:	CCK
Tested By:	Nick Hsieh	Tested Channel:	CH11: 2462MHz
Antenna Type:	PIFA	Tested Date:	Dec. 27, 2005

Power Line Measured : Line

Freq. (MHz)	Correct. Factor (dB)	Reading Value (dB μ V)		Emission Level (dB μ V)		Limit (dB μ V)		Margin (dB)	
		Q.P.	AV.	Q.P.	AV.	Q.P.	AV.	Q.P.	AV.
0.234	0.28	49.12	38.06	49.40	38.34	62.29	52.29	-12.89	-13.95
0.237	0.28	48.58	35.27	48.86	35.55	62.18	52.18	-13.32	-16.63
1.201	0.14	38.72	31.88	38.86	32.02	56.00	46.00	-17.14	-13.98
1.527	0.15	31.68	24.84	31.83	24.99	56.00	46.00	-24.17	-21.01
1.537	0.15	32.00	25.16	32.15	25.31	56.00	46.00	-23.85	-20.69
9.263	0.23	31.32	25.93	31.55	26.16	60.00	50.00	-28.45	-23.84

Power Line Measured : Neutral

Freq. (MHz)	Correct. Factor (dB)	Reading Value (dB μ V)		Emission Level (dB μ V)		Limit (dB μ V)		Margin (dB)	
		Q.P.	AV.	Q.P.	AV.	Q.P.	AV.	Q.P.	AV.
0.234	0.28	49.14	38.08	49.42	38.36	62.29	52.29	-12.87	-13.93
0.237	0.28	48.88	35.57	49.16	35.85	62.18	52.18	-13.02	-16.33
1.172	0.14	35.80	26.40	35.94	26.54	56.00	46.00	-20.06	-19.46
1.200	0.14	37.44	30.60	37.58	30.74	56.00	46.00	-18.42	-15.26
1.408	0.15	34.58	24.97	34.73	25.12	56.00	46.00	-21.27	-20.88
9.070	0.23	32.82	27.43	33.05	27.66	60.00	50.00	-26.95	-22.34

NOTE :

1. Measurement uncertainty is +/-1.32dB
2. Emission level = Reading value + Correction factor
3. Correction Factor = Cable loss + Insertion loss of LISN
4. Margin value = Emission level - Limit
5. The emission of other frequencies were very low against the limit.
6. "-": The Quasi-peak reading value also meets average limit and measurement with the average detector is unnecessary.



TEST REPORT

Temperature:	21 °C	Humidity:	68 %RH
Frequency Range:	0.15 – 30 MHz	Tested Mode:	Link
Receiver Detector:	Q.P. and AV.	Modulation Type:	N/A
Tested By:	Nick Hsieh	Tested Channel:	N/A
Antenna Type:	DIPOLE	Tested Date:	Dec. 27, 2005

Power Line Measured : Line

Freq. (MHz)	Correct. Factor (dB)	Reading Value (dB μ V)		Emission Level (dB μ V)		Limit (dB μ V)		Margin (dB)	
		Q.P.	AV.	Q.P.	AV.	Q.P.	AV.	Q.P.	AV.
0.150	0.30	58.24	31.43	58.54	31.73	65.98	55.98	-7.44	-24.25
0.153	0.30	61.80	34.99	62.10	35.29	65.82	55.82	-3.72	-20.53
0.528	0.24	35.86	22.38	36.10	22.62	56.00	46.00	-19.90	-23.38
1.299	0.14	35.70	22.36	35.84	22.50	56.00	46.00	-20.16	-23.50
1.329	0.15	36.52	23.82	36.67	23.97	56.00	46.00	-19.33	-22.03
9.547	0.23	33.32	27.49	33.55	27.72	60.00	50.00	-26.45	-22.28

Power Line Measured : Neutral

Freq. (MHz)	Correct. Factor (dB)	Reading Value (dB μ V)		Emission Level (dB μ V)		Limit (dB μ V)		Margin (dB)	
		Q.P.	AV.	Q.P.	AV.	Q.P.	AV.	Q.P.	AV.
0.159	0.30	55.88	29.07	56.18	29.37	65.50	55.50	-9.32	-26.13
0.177	0.30	59.48	45.15	59.78	45.45	64.61	54.61	-4.83	-9.16
1.086	0.14	34.58	21.10	34.72	21.24	56.00	46.00	-21.28	-24.76
1.210	0.14	33.94	20.60	34.08	20.74	56.00	46.00	-21.92	-25.26
1.349	0.15	32.68	19.98	32.83	20.13	56.00	46.00	-23.17	-25.87
9.436	0.23	34.72	29.34	34.95	29.57	60.00	50.00	-25.05	-20.43

NOTE :

1. Measurement uncertainty is +/-1.32dB
2. Emission level = Reading value + Correction factor
3. Correction Factor = Cable loss + Insertion loss of LISN
4. Margin value = Emission level - Limit
5. The emission of other frequencies were very low against the limit.
6. "-": The Quasi-peak reading value also meets average limit and measurement with the average detector is unnecessary.



Temperature:	21 °C	Humidity:	68 %RH
Frequency Range:	0.15 – 30 MHz	Tested Mode:	IEEE 802.11g
Receiver Detector:	Q.P. and AV.	Modulation Type:	OFDM
Tested By:	Nick Hsieh	Tested Channel:	CH1: 2412MHz
Antenna Type:	DIPOLE	Tested Date:	Dec. 27, 2005

Power Line Measured : Line

Freq. (MHz)	Correct. Factor (dB)	Reading Value (dB μ V)		Emission Level (dB μ V)		Limit (dB μ V)		Margin (dB)	
		Q.P.	AV.	Q.P.	AV.	Q.P.	AV.	Q.P.	AV.
0.228	0.28	48.06	35.41	48.34	35.69	62.51	52.51	-14.16	-16.81
0.231	0.28	48.50	37.70	48.78	37.98	62.40	52.40	-13.61	-14.41
1.182	0.14	36.42	30.15	36.56	30.29	56.00	46.00	-19.44	-15.71
1.200	0.14	37.92	31.65	38.06	31.79	56.00	46.00	-17.94	-14.21
1.210	0.14	37.86	31.59	38.00	31.73	56.00	46.00	-18.00	-14.27
9.263	0.23	30.24	23.95	30.47	24.18	60.00	50.00	-29.53	-25.82

Power Line Measured : Neutral

Freq. (MHz)	Correct. Factor (dB)	Reading Value (dB μ V)		Emission Level (dB μ V)		Limit (dB μ V)		Margin (dB)	
		Q.P.	AV.	Q.P.	AV.	Q.P.	AV.	Q.P.	AV.
0.225	0.28	47.60	34.95	47.88	35.23	62.62	52.62	-14.73	-17.38
0.231	0.28	48.86	38.06	49.14	38.34	62.40	52.40	-13.25	-14.05
0.605	0.22	37.52	29.78	37.74	30.00	56.00	46.00	-18.26	-16.00
1.200	0.14	37.04	30.77	37.18	30.91	56.00	46.00	-18.82	-15.09
1.349	0.15	29.14	16.33	29.29	16.48	56.00	46.00	-26.71	-29.52
9.172	0.23	32.06	26.77	32.29	27.00	60.00	50.00	-27.71	-23.00

NOTE :

1. Measurement uncertainty is +/-1.32dB
2. Emission level = Reading value + Correction factor
3. Correction Factor = Cable loss + Insertion loss of LISN
4. Margin value = Emission level - Limit
5. The emission of other frequencies were very low against the limit.
6. "-": The Quasi-peak reading value also meets average limit and measurement with the average detector is unnecessary.



TEST REPORT

Temperature:	21 °C	Humidity:	68 %RH
Frequency Range:	0.15 – 30 MHz	Tested Mode:	IEEE 802.11g
Receiver Detector:	Q.P. and AV.	Modulation Type:	OFDM
Tested By:	Nick Hsieh	Tested Channel:	CH6: 2437MHz
Antenna Type:	DIPOLE	Tested Date:	Dec. 27, 2005

Power Line Measured : Line

Freq. (MHz)	Correct. Factor (dB)	Reading Value (dB μ V)		Emission Level (dB μ V)		Limit (dB μ V)		Margin (dB)	
		Q.P.	AV.	Q.P.	AV.	Q.P.	AV.	Q.P.	AV.
0.231	0.28	48.28	33.99	48.56	34.27	62.40	52.40	-13.83	-18.12
0.297	0.28	29.16	18.36	29.44	18.64	60.31	50.31	-30.87	-31.67
0.716	0.20	39.10	28.30	39.30	28.50	56.00	46.00	-16.70	-17.50
1.200	0.14	38.00	32.11	38.14	32.25	56.00	46.00	-17.86	-13.75
1.398	0.15	34.90	29.01	35.05	29.16	56.00	46.00	-20.95	-16.84
9.659	0.23	31.50	25.61	31.73	25.84	60.00	50.00	-28.27	-24.16

Power Line Measured : Neutral

Freq. (MHz)	Correct. Factor (dB)	Reading Value (dB μ V)		Emission Level (dB μ V)		Limit (dB μ V)		Margin (dB)	
		Q.P.	AV.	Q.P.	AV.	Q.P.	AV.	Q.P.	AV.
0.222	0.28	47.08	32.79	47.36	33.07	62.73	52.73	-15.36	-19.65
0.228	0.28	48.22	37.42	48.50	37.70	62.51	52.51	-14.00	-14.80
1.186	0.14	34.82	27.71	34.96	27.85	56.00	46.00	-21.04	-18.15
1.200	0.14	36.58	30.69	36.72	30.83	56.00	46.00	-19.28	-15.17
1.210	0.14	37.18	30.17	37.32	30.31	56.00	46.00	-18.68	-15.69
9.446	0.23	32.80	27.36	33.03	27.59	60.00	50.00	-26.97	-22.41

NOTE :

1. Measurement uncertainty is +/-1.32dB
2. Emission level = Reading value + Correction factor
3. Correction Factor = Cable loss + Insertion loss of LISN
4. Margin value = Emission level - Limit
5. The emission of other frequencies were very low against the limit.
6. "-": The Quasi-peak reading value also meets average limit and measurement with the average detector is unnecessary.



TEST REPORT

Temperature:	21 °C	Humidity:	68 %RH
Frequency Range:	0.15 – 30 MHz	Tested Mode:	IEEE 802.11g
Receiver Detector:	Q.P. and AV.	Modulation Type:	OFDM
Tested By:	Nick Hsieh	Tested Channel:	CH11: 2462MHz
Antenna Type:	DIPOLE	Tested Date:	Dec. 27, 2005

Power Line Measured : Line

Freq. (MHz)	Correct. Factor (dB)	Reading Value (dB μ V)		Emission Level (dB μ V)		Limit (dB μ V)		Margin (dB)	
		Q.P.	AV.	Q.P.	AV.	Q.P.	AV.	Q.P.	AV.
0.231	0.28	48.14	33.25	48.42	33.53	62.40	52.40	-13.97	-18.86
0.234	0.28	48.38	36.79	48.66	37.07	62.29	52.29	-13.63	-15.22
1.167	0.14	35.34	29.22	35.48	29.36	56.00	46.00	-20.52	-16.64
1.200	0.14	38.04	31.92	38.18	32.06	56.00	46.00	-17.82	-13.94
1.210	0.14	38.08	31.96	38.22	32.10	56.00	46.00	-17.78	-13.90
9.892	0.23	31.36	25.24	31.59	25.47	60.00	50.00	-28.41	-24.53

Power Line Measured : Neutral

Freq. (MHz)	Correct. Factor (dB)	Reading Value (dB μ V)		Emission Level (dB μ V)		Limit (dB μ V)		Margin (dB)	
		Q.P.	AV.	Q.P.	AV.	Q.P.	AV.	Q.P.	AV.
0.222	0.28	47.32	32.43	47.60	32.71	62.73	52.73	-15.12	-20.01
0.234	0.28	48.76	37.17	49.04	37.45	62.29	52.29	-13.25	-14.84
0.951	0.17	35.46	28.91	35.63	29.08	56.00	46.00	-20.37	-16.92
1.200	0.14	36.44	30.32	36.58	30.46	56.00	46.00	-19.42	-15.54
1.408	0.15	33.28	25.48	33.43	25.63	56.00	46.00	-22.57	-20.37
9.507	0.23	32.60	27.36	32.83	27.59	60.00	50.00	-27.17	-22.41

NOTE :

1. Measurement uncertainty is +/-1.32dB
2. Emission level = Reading value + Correction factor
3. Correction Factor = Cable loss + Insertion loss of LISN
4. Margin value = Emission level - Limit
5. The emission of other frequencies were very low against the limit.
6. "-": The Quasi-peak reading value also meets average limit and measurement with the average detector is unnecessary.



Temperature:	21 °C	Humidity:	68 %RH
Frequency Range:	0.15 – 30 MHz	Tested Mode:	IEEE 802.11b
Receiver Detector:	Q.P. and AV.	Modulation Type:	CCK
Tested By:	Nick Hsieh	Tested Channel:	CH1: 2412MHz
Antenna Type:	DIPOLE	Tested Date:	Dec. 27, 2005

Power Line Measured : Line

Freq. (MHz)	Correct. Factor (dB)	Reading Value (dB μ V)		Emission Level (dB μ V)		Limit (dB μ V)		Margin (dB)	
		Q.P.	AV.	Q.P.	AV.	Q.P.	AV.	Q.P.	AV.
0.231	0.28	48.98	37.03	49.26	37.31	62.40	52.40	-13.13	-15.08
0.234	0.28	49.02	37.07	49.30	37.35	62.29	52.29	-12.99	-14.94
1.200	0.14	39.04	32.36	39.18	32.50	56.00	46.00	-16.82	-13.50
1.201	0.14	39.22	32.54	39.36	32.68	56.00	46.00	-16.64	-13.32
1.398	0.15	35.98	26.97	36.13	27.12	56.00	46.00	-19.87	-18.88
9.293	0.23	30.60	25.27	30.83	25.50	60.00	50.00	-29.17	-24.50

Power Line Measured : Neutral

Freq. (MHz)	Correct. Factor (dB)	Reading Value (dB μ V)		Emission Level (dB μ V)		Limit (dB μ V)		Margin (dB)	
		Q.P.	AV.	Q.P.	AV.	Q.P.	AV.	Q.P.	AV.
0.150	0.30	47.32	33.42	47.62	33.72	65.98	55.98	-18.36	-22.26
0.228	0.28	48.80	36.85	49.08	37.13	62.51	52.51	-13.42	-15.37
1.177	0.14	35.78	27.78	35.92	27.92	56.00	46.00	-20.08	-18.08
1.200	0.14	37.54	30.86	37.68	31.00	56.00	46.00	-18.32	-15.00
1.210	0.14	36.74	27.73	36.88	27.87	56.00	46.00	-19.12	-18.13
9.537	0.23	32.64	27.31	32.87	27.54	60.00	50.00	-27.13	-22.46

NOTE :

1. Measurement uncertainty is +/-1.32dB
2. Emission level = Reading value + Correction factor
3. Correction Factor = Cable loss + Insertion loss of LISN
4. Margin value = Emission level - Limit
5. The emission of other frequencies were very low against the limit.
6. "-": The Quasi-peak reading value also meets average limit and measurement with the average detector is unnecessary.



TEST REPORT

Temperature:	21 °C	Humidity:	68 %RH
Frequency Range:	0.15 – 30 MHz	Tested Mode:	IEEE 802.11b
Receiver Detector:	Q.P. and AV.	Modulation Type:	CCK
Tested By:	Nick Hsieh	Tested Channel:	CH6: 2437MHz
Antenna Type:	DIPOLE	Tested Date:	Dec. 27, 2005

Power Line Measured : Line

Freq. (MHz)	Correct. Factor (dB)	Reading Value (dB μ V)		Emission Level (dB μ V)		Limit (dB μ V)		Margin (dB)	
		Q.P.	AV.	Q.P.	AV.	Q.P.	AV.	Q.P.	AV.
0.231	0.28	49.06	36.19	49.34	36.47	62.40	52.40	-13.05	-15.92
0.237	0.28	48.88	36.01	49.16	36.29	62.18	52.18	-13.02	-15.89
1.191	0.14	37.52	29.34	37.66	29.48	56.00	46.00	-18.34	-16.52
1.200	0.14	38.90	32.13	39.04	32.27	56.00	46.00	-16.96	-13.73
1.428	0.15	36.52	24.58	36.67	24.73	56.00	46.00	-19.33	-21.27
9.578	0.23	31.34	26.04	31.57	26.27	60.00	50.00	-28.43	-23.73

Power Line Measured : Neutral

Freq. (MHz)	Correct. Factor (dB)	Reading Value (dB μ V)		Emission Level (dB μ V)		Limit (dB μ V)		Margin (dB)	
		Q.P.	AV.	Q.P.	AV.	Q.P.	AV.	Q.P.	AV.
0.156	0.30	46.62	31.45	46.92	31.75	65.66	55.66	-18.74	-23.91
0.237	0.28	48.84	35.97	49.12	36.25	62.18	52.18	-13.06	-15.93
1.186	0.14	36.12	27.94	36.26	28.08	56.00	46.00	-19.74	-17.92
1.200	0.14	37.54	30.77	37.68	30.91	56.00	46.00	-18.32	-15.09
1.388	0.15	34.12	22.18	34.27	22.33	56.00	46.00	-21.73	-23.67
9.344	0.23	32.44	27.14	32.67	27.37	60.00	50.00	-27.33	-22.63

NOTE :

1. Measurement uncertainty is +/-1.32dB
2. Emission level = Reading value + Correction factor
3. Correction Factor = Cable loss + Insertion loss of LISN
4. Margin value = Emission level - Limit
5. The emission of other frequencies were very low against the limit.
6. "-": The Quasi-peak reading value also meets average limit and measurement with the average detector is unnecessary.



Temperature:	21 °C	Humidity:	68 %RH
Frequency Range:	0.15 – 30 MHz	Tested Mode:	IEEE 802.11b
Receiver Detector:	Q.P. and AV.	Modulation Type:	CCK
Tested By:	Nick Hsieh	Tested Channel:	CH11: 2462MHz
Antenna Type:	DIPOLE	Tested Date:	Dec. 27, 2005

Power Line Measured : Line

Freq. (MHz)	Correct. Factor (dB)	Reading Value (dB μ V)		Emission Level (dB μ V)		Limit (dB μ V)		Margin (dB)	
		Q.P.	AV.	Q.P.	AV.	Q.P.	AV.	Q.P.	AV.
0.228	0.28	48.26	31.89	48.54	32.17	62.51	52.51	-13.96	-20.33
0.234	0.28	48.82	38.43	49.10	38.71	62.29	52.29	-13.19	-13.58
1.172	0.14	36.78	27.68	36.92	27.82	56.00	46.00	-19.08	-18.18
1.210	0.14	38.30	32.19	38.44	32.33	56.00	46.00	-17.56	-13.67
1.418	0.15	35.62	26.52	35.77	26.67	56.00	46.00	-20.23	-19.33
9.395	0.23	31.02	25.54	31.25	25.77	60.00	50.00	-28.75	-24.23

Power Line Measured : Neutral

Freq. (MHz)	Correct. Factor (dB)	Reading Value (dB μ V)		Emission Level (dB μ V)		Limit (dB μ V)		Margin (dB)	
		Q.P.	AV.	Q.P.	AV.	Q.P.	AV.	Q.P.	AV.
0.222	0.28	47.78	31.41	48.06	31.69	62.73	52.73	-14.66	-21.03
0.231	0.28	48.98	38.59	49.26	38.87	62.40	52.40	-13.13	-13.52
1.186	0.14	36.04	27.91	36.18	28.05	56.00	46.00	-19.82	-17.95
1.200	0.14	37.66	31.55	37.80	31.69	56.00	46.00	-18.20	-14.31
1.408	0.15	34.46	25.36	34.61	25.51	56.00	46.00	-21.39	-20.49
9.913	0.23	32.38	26.90	32.61	27.13	60.00	50.00	-27.39	-22.87

NOTE :

1. Measurement uncertainty is +/-1.32dB
2. Emission level = Reading value + Correction factor
3. Correction Factor = Cable loss + Insertion loss of LISN
4. Margin value = Emission level - Limit
5. The emission of other frequencies were very low against the limit.
6. "-": The Quasi-peak reading value also meets average limit and measurement with the average detector is unnecessary.



4.2 RADIATED EMISSION TEST

4.2.1 LIMIT

FCC Part 15, Subpart C Section 15.209 limit of radiated emission for frequency below 1000 MHz. The emissions from an intentional radiator shall not exceed the field strength levels specified in the following table:

FREQUENCY (MHz)	DISTANCE (m)	FIELD STRENGTH (dB μ V/m)
30 - 88	3	40.0
88 - 216	3	43.5
216 - 960	3	46.0
Above 960	3	54.0

NOTE :

1. In the emission tables above, the tighter limit applies at the band edges.
2. Distance refers to the distance between measuring instrument, antenna, and the closest point of any part of the device or system.

FCC Part 15, Section 15.35(b) limit of radiated emission for frequency above 1000 MHz

FREQUENCY (MHz)	Class A (dB μ V/m) (at 3m)		Class B (dB μ V/m) (at 3m)	
	PEAK	AVERAGE	PEAK	AVERAGE
Above 1000	80.0	60.0	74.0	54.0



Spectrum Research & Testing Lab., Inc.
No. 101-10, Ling 8,
Shan-Tong Li, Chung-Li
City, Taoyuan, Taiwan

TEST REPORT

Reference No.: C006032406
Report No.: FCCC05121206-02
FCC ID: I4L-MS6833B-M
Page: 26 of 96
Date: APR. 09, 2006

4.2.2 TEST EQUIPMENT

The following test equipment was used during the radiated emission test:

EQUIPMENT/ FACILITIES	SPECIFICATIONS	MANUFACTURER	MODEL#/ SERIAL#	DUE DATE OF CAL. & CAL. CENTER
EMI TEST RECEIVER	9 kHz TO 2750 MHz	ROHDE & SCHWARZ	ESCS30/ 830245/012	OCT. 2006 ETC
BI-LOG ANTENNA	25 MHz TO 2 GHz	EMCO	3142/ 9701-1124	FEB. 2006 SRT
SPECTRUM ANALYZER	9 KHz TO 26.5 GHz	HP	8593E/ 3710A03220	MAY 2006 ETC
PRE-AMPLIFIER	1 GHz TO 26.5 GHz	HP	8449B/ 3008A01019	NOV. 2006 ETC
HORN ANTENNA	1 GHz TO 18 GHz	EMCO	3115/ 9602-4681	DEC. 2006 ETC
OATS	3 – 10 M MEASUREMENT	SRT	SRT-1	APR. 2006 SRT
COAXIAL CABLE	25M	SUNCITY	J400/ 25M	APR. 2006 SRT
FILTER	2 LINE, 30A	FIL.COIL	FC-943/ 869	N/A
FREQUENCY CONVERTER	N/A	APC	AFC-2KBB/ F100030031	AUG. 2006 SRT

NOTE:

1. The calibration interval of the above test equipment is one year and the calibrations are traceable to NML/ROC and NIST/USA.
2. The Open Area Test Site (SRT-1) is registered by FCC with No. 90957 and VCCI with No. R-1081.
3. The Open Area Test Site (SRT-2) is registered by FCC with No. 98458 and VCCI with No. R-1168.



4.2.3 TEST SET-UP

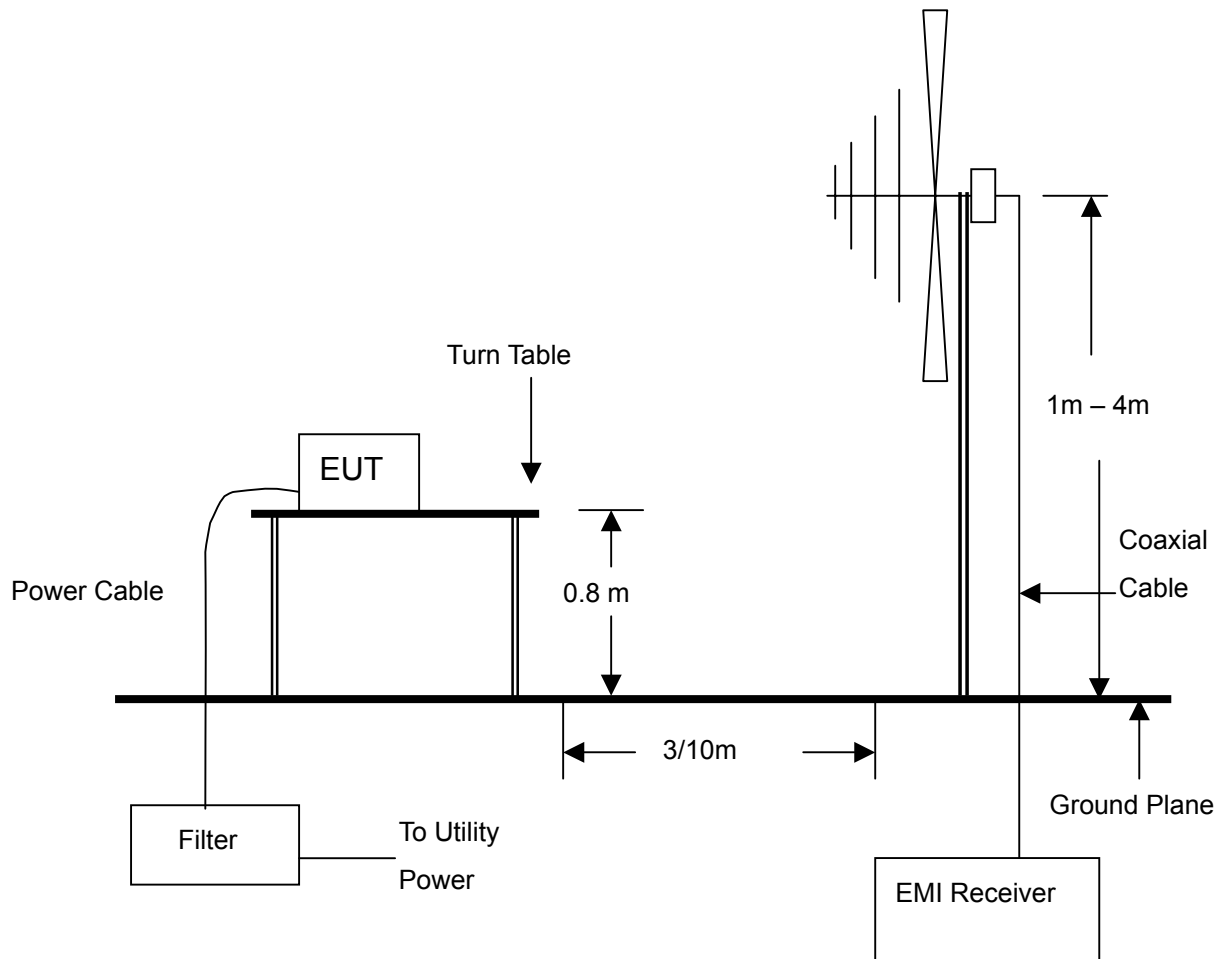

NOTE :

1. The EUT system was put on a wooden table with 0.8m heights above a ground plane.
2. For the actual test configuration, please refer to the photos of testing.



**Spectrum Research &
Testing Lab., Inc.**
No. 101-10, Ling 8,
Shan-Tong Li, Chung-Li
City, Taoyuan, Taiwan

TEST REPORT

Reference No.: C006032406
Report No.: FCCC05121206-02
FCC ID: I4L-MS6833B-M
Page: 28 of 96
Date: APR. 09, 2006

4.2.4 TEST PROCEDURE

The EUT was tested according to the requirement of ANSI C63.4:2003 and CISPR 22:2003. The measurements were made at an open area test site with 10 meter measurement distance under 1 GHz and with 3m distance above 1GHz. The frequency spectrum measured started from 30 MHz. Under 1 GHz, all readings were quasi-peak values with 120 kHz resolution bandwidth of the test receiver. Above 1 GHz, the measurements were made at an open area test site with 3 meter measurement distance and all readings were peak or average values with 1 MHz resolution bandwidth of the test receiver. The EUT system was operated in all typical methods by users. The cables connected to EUT and support units were moved to find the maximum emission levels for each frequency.

First, find the margin or higher points at least 6 points by software, then use manual to find the maximum data. The procedure is referred on the test procedure of SRT LAB.

4.2.5 EUT OPERATING CONDITION

Same as section 4.1.5 of this report.



4.2.6 TEST RESULT

Temperature:	20 °C	Humidity:	62 %RH
Frequency Range:	30 – 1000 MHz	Measured Distance:	3m
Receiver Detector:	Q.P.	Tested Mode:	Link
Tested By:	Nick Hsieh	Tested Date:	Jan. 06, 2006
Antenna Type:	PIFA		

Antenna Polarization: Horizontal

Frequency (MHz)	Cable Loss (dB)	Antenna Factor (dB/m)	Reading Data (dBμV)	Emission Level (dBμV/m)	Limit (dBμV/m)	Margin (dB)	AZ(°)	EL(m)
233.4945	2.68	10.92	23.7	37.3	46.0	-8.7	93.90	1.00
367.6720	3.38	15.17	7.6	26.2	46.0	-19.8	96.30	1.00
499.8950	4.12	16.10	11.9	32.1	46.0	-13.9	188.90	1.00
566.4100	4.44	16.96	18.2	39.6	46.0	-6.4	194.60	1.20
596.4800	4.58	17.35	7.9	29.8	46.0	-16.2	213.80	1.10
798.2400	5.32	21.88	7.6	34.8	46.0	-11.2	199.90	1.00

Antenna Polarization: Vertical

Frequency (MHz)	Cable Loss (dB)	Antenna Factor (dB/m)	Reading Data (dBμV)	Emission Level (dBμV/m)	Limit (dBμV/m)	Margin (dB)	AZ(°)	EL(m)
66.8600	1.52	5.38	17.8	24.7	40.0	-15.3	276.90	1.30
133.7900	2.06	8.48	17.9	28.4	43.5	-15.1	294.30	1.00
198.7800	2.47	9.88	19.6	32.0	43.5	-11.5	100.50	1.20
233.7000	2.68	10.92	12.8	26.4	46.0	-19.6	87.00	1.00
566.4100	4.44	16.96	8.6	30.0	46.0	-16.0	78.50	1.00
732.2800	5.13	21.29	8.8	35.2	46.0	-10.8	133.70	1.10

NOTE :

1. Measurement uncertainty is +/-2dB.
2. "**": Measurement does not apply for this frequency.
3. Emission Level = Reading Value + Ant. Factor + Cable Loss.
4. The field strength of other emission frequencies were very low against the limit.



TEST REPORT

Temperature:	20°C	Humidity:	62 %RH
Frequency Range:	1 – 25 GHz	Measured Distance:	3m
Receiver Detector:	PK. or AV.	Tested Mode:	IEEE 802.11g
Tested By:	Nick Hsieh	Tested Channel:	CH 1 : 2412MHz
Tested Date:	Jan. 06, 2005	Modulation Type:	OFDM
Antenna Type:	PIFA		

Antenna Polarization : Horizontal

Frequency (MHz)	Correct Factor (dB)	Ant. Factor (dB/m)	Reading Data (dBμV)		Emission Level (dBμV/m)		Limit (dBμV/m)		Margin (dB)		AZ (°)	EL (m)
			PK.	AV.	PK.	AV.	PK.	AV.	PK.	AV.		
2412.00	-32.18	28.56	92.3	89.6	88.7	86.0	74.0	54.0	14.7	32.0	132.70	1.10
4824.00	-30.41	33.66	61.8	46.3	65.0	49.5	74.0	54.0	-9.0	-4.5	122.90	1.10
7236.00	-28.98	36.29	57.9	42.7	65.2	50.0	74.0	54.0	-8.8	-4.0	98.30	1.10
2400.00	-32.16	28.00	60.6	43.1	56.4	38.9	74.0	54.0	-17.6	-15.1	99.10	1.00
2346.59	-32.35	27.89	61.7	44.3	57.2	39.8	74.0	54.0	-16.8	-14.2	187.70	1.00
2456.18	-32.23	28.11	62.1	43.9	58.0	39.8	74.0	54.0	-16.0	-14.2	189.90	1.20

Antenna Polarization : Vertical

Frequency (MHz)	Correct Factor (dB)	Ant. Factor (dB/m)	Reading Data (dBμV)		Emission Level (dBμV/m)		Limit (dBμV/m)		Margin (dB)		AZ (°)	EL (m)
			PK.	AV.	PK.	AV.	PK.	AV.	PK.	AV.		
2412.00	-32.18	28.02	96.9	89.8	92.7	85.6	74.0	54.0	18.7	31.6	287.10	1.00
4824.00	-30.41	33.66	61.0	43.8	64.2	47.0	74.0	54.0	-9.8	-7.0	301.20	1.00
7236.00	-28.98	36.29	60.2	44.2	67.5	51.5	74.0	54.0	-6.5	-2.5	89.30	1.00
2400.00	-32.16	28.00	63.4	43.7	59.2	39.5	74.0	54.0	-14.8	-14.5	90.90	1.10
2372.15	-32.27	27.94	62.7	43.3	58.4	39.0	74.0	54.0	-15.6	-15.0	115.00	1.10
2471.26	-32.21	28.14	61.3	43.9	57.2	39.8	74.0	54.0	-16.8	-14.2	310.50	1.20

NOTE :

1. Measurement uncertainty is +/-2dB.
2. "F": The Peak reading value also meets average limit and measurement with the average detector is unnecessary.
3. Emission Level = Reading Value + Ant. Factor + Correct Factor (incl.:Cable Loss and Pre-Amplifier Gain)
4. The field strength of other emission frequencies were very low against the limit.
5. (F):The field strength of fundamental frequency.



Temperature:	20C	Humidity:	62 %RH
Frequency Range:	1 – 25 GHz	Measured Distance:	3m
Receiver Detector:	PK. or AV.	Tested Mode:	IEEE 802.11g
Tested By:	Nick Hsieh	Tested Channel:	CH 6 : 2437MHz
Tested Date:	Jan. 06, 2006	Modulation Type:	OFDM
Antenna Type:	PIFA		

Antenna Polarization : Horizontal

Frequency (MHz)	Correct Factor (dB)	Ant. Factor (dB/m)	Reading Data (dB μ V)		Emission Level (dB μ V/m)		Limit (dB μ V/m)		Margin (dB)		AZ (°)	EL (m)
			PK.	AV.	PK.	AV.	PK.	AV.	PK.	AV.		
2437.00	-32.22	28.61	103.2	94.3	99.6	90.7	74.0	54.0	25.6	36.7	89.40	1.10
4874.00	-30.28	33.70	59.6	48.1	63.0	51.5	74.0	54.0	-11.0	-2.5	78.30	1.00
7311.00	-29.07	36.35	57.4	42.9	64.7	50.2	74.0	54.0	-9.3	-3.8	99.30	1.00
2424.20	-32.20	28.05	60.3	44.8	56.1	40.6	74.0	54.0	-17.9	-13.4	127.50	1.20
2468.26	-32.21	28.14	61.1	45.1	57.0	41.0	74.0	54.0	-17.0	-13.0	183.90	1.10
2480.16	-32.19	28.16	60.9	45.8	56.9	41.8	74.0	54.0	-17.1	-12.2	166.40	1.00

Antenna Polarization : Vertical

Frequency (MHz)	Correct Factor (dB)	Ant. Factor (dB/m)	Reading Data (dB μ V)		Emission Level (dB μ V/m)		Limit (dB μ V/m)		Margin (dB)		AZ (°)	EL (m)
			PK.	AV.	PK.	AV.	PK.	AV.	PK.	AV.		
2437.00	-32.22	28.07	102.5	92.3	98.4	88.2	74.0	54.0	24.4	34.2	221.50	1.00
4874.00	-30.28	33.70	61.2	45.4	64.6	48.8	74.0	54.0	-9.4	-5.2	178.80	1.00
7311.00	-29.07	36.35	82.3	44.7	89.6	52.0	74.0	54.0	15.6	-2.0	321.90	1.10
2397.16	-32.17	27.99	59.8	43.7	55.6	39.5	74.0	54.0	-18.4	-14.5	274.30	1.00
2417.00	-32.19	28.03	58.9	45.3	54.7	41.1	74.0	54.0	-19.3	-12.9	99.40	1.20
2468.19	-32.21	28.14	60.3	46.1	56.2	42.0	74.0	54.0	-17.8	-12.0	118.40	1.10

NOTE :

1. Measurement uncertainty is +/-2dB.
2. "F": The Peak reading value also meets average limit and measurement with the average detector is unnecessary.
3. Emission Level = Reading Value + Ant. Factor + Correct Factor (incl.:Cable Loss and Pre-Amplifier Gain)
4. The field strength of other emission frequencies were very low against the limit.
5. (F):The field strength of fundamental frequency.



TEST REPORT

Temperature:	20°C	Humidity:	62 %RH
Frequency Range:	1 – 25 GHz	Measured Distance:	3m
Receiver Detector:	PK. or AV.	Tested Mode:	IEEE 802.11g
Tested By:	Nick Hsieh	Tested Channel:	CH 11 : 2462MHz
Tested Date:	Jan. 06, 2006	Modulation Type:	OFDM
Antenna Type:	PIFA		

Antenna Polarization : Horizontal

Frequency (MHz)	Correct Factor (dB)	Ant. Factor (dB/m)	Reading Data (dBμV)		Emission Level (dBμV/m)		Limit (dBμV/m)		Margin (dB)		AZ (°)	EL (m)
			PK.	AV.	PK.	AV.	PK.	AV.	PK.	AV.		
2462.00	-32.22	28.69	101.3	91.3	97.8	87.8	74.0	54.0	23.8	33.8	167.20	1.00
4924.00	-30.23	33.74	63.2	45.7	66.7	49.2	74.0	54.0	-7.3	-4.8	86.00	1.10
7386.00	-28.94	36.41	62.7	43.7	70.2	51.2	74.0	54.0	-3.8	-2.8	322.40	1.10
2483.50	-32.19	28.17	59.6	44.8	55.6	40.8	74.0	54.0	-18.4	-13.2	78.90	1.20
2449.00	-32.24	28.10	61.2	45.7	57.1	41.6	74.0	54.0	-16.9	-12.4	77.90	1.10
2513.26	-32.07	28.27	62.1	47.3	58.3	43.5	74.0	54.0	-15.7	-10.5	107.00	1.00

Antenna Polarization : Vertical

Frequency (MHz)	Correct Factor (dB)	Ant. Factor (dB/m)	Reading Data (dBμV)		Emission Level (dBμV/m)		Limit (dBμV/m)		Margin (dB)		AZ (°)	EL (m)
			PK.	AV.	PK.	AV.	PK.	AV.	PK.	AV.		
2462.00	-32.22	28.12	99.7	90.5	95.6	86.4	74.0	54.0	21.6	32.4	99.40	1.00
4924.00	-30.23	33.74	62.7	45.3	66.2	48.8	74.0	54.0	-7.8	-5.2	66.80	1.00
7386.00	-28.94	36.41	61.9	44.2	69.4	51.7	74.0	54.0	-4.6	-2.3	183.00	1.00
2483.50	-32.19	28.17	60.2	43.9	56.2	39.9	74.0	54.0	-17.8	-14.1	56.60	1.00
2447.00	-32.24	28.09	60.7	44.2	56.6	40.1	74.0	54.0	-17.4	-13.9	78.90	1.10
2496.74	-32.17	28.19	60.9	45.1	56.9	41.1	74.0	54.0	-17.1	-12.9	234.50	1.20

NOTE :

1. Measurement uncertainty is +/-2dB.
2. "F": The Peak reading value also meets average limit and measurement with the average detector is unnecessary.
3. Emission Level = Reading Value + Ant. Factor + Correct Factor (incl.:Cable Loss and Pre-Amplifier Gain)
4. The field strength of other emission frequencies were very low against the limit.
5. (F):The field strength of fundamental frequency.



TEST REPORT

Temperature:	20°C	Humidity:	62%RH
Frequency Range:	1 – 25 GHz	Measured Distance:	3m
Receiver Detector:	PK. or AV.	Tested Mode:	IEEE 802.11b
Tested By:	Nick Hsieh	Tested Channel:	CH 1 : 2412MHz
Tested Date:	Jan. 06, 2006	Modulation Type:	CCK
Antenna Type:	PIFA		

Antenna Polarization : Horizontal

Frequency (MHz)	Correct Factor (dB)	Ant. Factor (dB/m)	Reading Data (dBμV)		Emission Level (dBμV/m)		Limit (dBμV/m)		Margin (dB)		AZ (°)	EL (m)
			PK.	AV.	PK.	AV.	PK.	AV.	PK.	AV.		
2412.00	-32.18	28.56	106.2	98.2	102.6	94.6	N/A	N/A	N/A	N/A	176.83	1.10
4824.00	-30.41	33.66	62.3	46.9	65.5	50.1	74.0	54.0	-8.5	-3.9	227.90	1.00
7236.00	-28.98	36.29	60.8	43.8	68.1	51.1	74.0	54.0	-5.9	-2.9	129.60	1.00
2400.00	-32.16	28.00	65.4	52.9	61.2	48.7	74.0	54.0	-12.8	-5.3	112.30	1.20
2342.57	-32.35	27.88	61.8	47.1	57.3	42.6	74.0	54.0	-16.7	-11.4	187.90	1.10
2429.60	-32.21	28.06	62.9	48.5	58.8	44.4	74.0	54.0	-15.2	-9.6	89.30	1.00

Antenna Polarization : Vertical

Frequency (MHz)	Correct Factor (dB)	Ant. Factor (dB/m)	Reading Data (dBμV)		Emission Level (dBμV/m)		Limit (dBμV/m)		Margin (dB)		AZ (°)	EL (m)
			PK.	AV.	PK.	AV.	PK.	AV.	PK.	AV.		
2412.00	-32.18	28.02	103.4	92.7	99.2	88.5	N/A	N/A	N/A	N/A	29.60	1.08
4824.00	-30.41	33.66	64.5	45.3	67.7	48.5	74.0	54.0	-6.3	-5.5	188.20	1.10
7236.00	-28.98	36.29	58.2	42.4	65.5	49.7	74.0	54.0	-8.5	-4.3	203.80	1.20
2400.00	-32.16	28.00	65.9	53.1	61.7	48.9	74.0	54.0	-12.3	-5.1	229.70	1.00
2367.58	-32.29	27.93	63.3	44.9	58.9	40.5	74.0	54.0	-15.1	-13.5	198.60	1.10
2425.00	-32.20	28.05	64.7	47.1	60.5	42.9	74.0	54.0	-13.5	-11.1	128.70	1.10

NOTE :

1. Measurement uncertainty is +/-2dB.
2. "": The Peak reading value also meets average limit and measurement with the average detector is unnecessary.
3. Emission Level = Reading Value + Ant. Factor + Correct Factor (incl.:Cable Loss and Pre-Amplifier Gain)
4. The field strength of other emission frequencies were very low against the limit.
5. (F):The field strength of fundamental frequency.



TEST REPORT

Temperature:	20 °C	Humidity:	62 %RH
Frequency Range:	1 – 25 GHz	Measured Distance:	3m
Receiver Detector:	PK. or AV.	Tested Mode:	IEEE 802.11b
Tested By:	Nick Hsieh	Tested Channel:	CH 6 : 2437MHz
Tested Date:	Jan. 06, 2006	Modulation Type:	CCK
Antenna Type:	PIFA		

Antenna Polarization : Horizontal

Frequency (MHz)	Correct Factor (dB)	Ant. Factor (dB/m)	Reading Data (dBµV)		Emission Level (dBµV/m)		Limit (dBµV/m)		Margin (dB)		AZ (°)	EL (m)
			PK.	AV.	PK.	AV.	PK.	AV.	PK.	AV.		
2437.00	-32.22	28.61	104.7	99.8	101.1	96.2	N/A	N/A	N/A	N/A	189.30	1.10
4874.00	-30.28	33.70	63.2	46.5	66.6	49.9	74.0	54.0	-7.4	-4.1	227.30	1.10
7311.00	-29.07	36.35	61.3	41.9	68.6	49.2	74.0	54.0	-5.4	-4.8	120.80	1.10
2341.74	-32.35	27.88	59.9	42.6	55.4	38.1	74.0	54.0	-18.6	-15.9	137.80	1.20
2419.00	-32.19	28.04	60.2	53.7	56.0	49.5	74.0	54.0	-18.0	-4.5	190.00	1.10
2483.16	-32.19	28.17	61.8	51.3	57.8	47.3	74.0	54.0	-16.2	-6.7	118.30	1.00

Antenna Polarization : Vertical

Frequency (MHz)	Correct Factor (dB)	Ant. Factor (dB/m)	Reading Data (dBµV)		Emission Level (dBµV/m)		Limit (dBµV/m)		Margin (dB)		AZ (°)	EL (m)
			PK.	AV.	PK.	AV.	PK.	AV.	PK.	AV.		
2437.00	-32.22	28.07	104.9	98.3	100.8	94.2	N/A	N/A	N/A	N/A	321.80	1.10
4874.00	-30.28	33.70	60.9	46.3	64.3	49.7	74.0	54.0	-9.7	-4.3	78.20	1.10
7311.00	-29.07	36.35	61.3	42.9	68.6	50.2	74.0	54.0	-5.4	-3.8	277.90	1.10
2363.18	-32.30	27.93	62.7	46.8	58.3	42.4	74.0	54.0	-15.7	-11.6	123.60	1.00
2452.13	-32.24	28.10	63.5	47.9	59.4	43.8	74.0	54.0	-14.6	-10.2	98.00	1.00
2489.07	-32.18	28.18	62.9	48.5	58.9	44.5	74.0	54.0	-15.1	-9.5	299.50	1.00

NOTE :

1. Measurement uncertainty is +/-2dB.
2. "": The Peak reading value also meets average limit and measurement with the average detector is unnecessary.
3. Emission Level = Reading Value + Ant. Factor + Correct Factor (incl.:Cable Loss and Pre-Amplifier Gain)
4. The field strength of other emission frequencies were very low against the limit.
5. (F):The field strength of fundamental frequency.



TEST REPORT

Temperature:	20 °C	Humidity:	62 %RH
Frequency Range:	1 – 25 GHz	Measured Distance:	3m
Receiver Detector:	PK. or AV.	Tested Mode:	IEEE 802.11b
Tested By:	Nick Hsieh	Tested Channel:	CH 11 : 2462MHz
Tested Date:	Jan. 06, 2006	Modulation Type:	CCK
Antenna Type:	PIFA		

Antenna Polarization : Horizontal

Frequency (MHz)	Correct Factor (dB)	Ant. Factor (dB/m)	Reading Data (dBµV)		Emission Level (dBµV/m)		Limit (dBµV/m)		Margin (dB)		AZ (°)	EL (m)
			PK.	AV.	PK.	AV.	PK.	AV.	PK.	AV.		
2462.00	-32.22	28.69	103.7	98.2	100.2	94.7	74.0	54.0	26.2	40.7	173.40	1.00
4924.00	-30.23	33.74	61.6	42.8	65.1	46.3	74.0	54.0	-8.9	-7.7	188.30	1.00
7386.00	-28.94	36.41	60.3	43.9	67.8	51.4	74.0	54.0	-6.2	-2.6	129.40	1.00
2483.50	-32.19	28.17	63.6	47.3	59.6	43.3	74.0	54.0	-14.4	-10.7	98.40	1.10
2447.40	-32.24	28.09	61.4	41.6	57.3	37.5	74.0	54.0	-16.7	-16.5	138.50	1.10
2512.34	-32.08	28.27	62.7	39.4	58.9	35.6	74.0	54.0	-15.1	-18.4	199.30	1.20

Antenna Polarization : Vertical

Frequency (MHz)	Correct Factor (dB)	Ant. Factor (dB/m)	Reading Data (dBµV)		Emission Level (dBµV/m)		Limit (dBµV/m)		Margin (dB)		AZ (°)	EL (m)
			PK.	AV.	PK.	AV.	PK.	AV.	PK.	AV.		
2462.00	-32.22	28.12	105.4	97.5	101.3	93.4	74.0	54.0	27.3	39.4	241.40	1.10
4924.00	-30.23	33.74	61.8	43.8	65.3	47.3	74.0	54.0	-8.7	-6.7	118.90	1.10
7386.00	-28.94	36.41	59.7	41.5	67.2	49.0	74.0	54.0	-6.8	-5.0	88.30	1.10
2483.50	-32.19	28.17	63.2	45.8	59.2	41.8	74.0	54.0	-14.8	-12.2	99.30	1.20
2446.60	-32.23	28.09	62.9	46.1	58.8	42.0	74.0	54.0	-15.2	-12.0	127.40	1.10
2520.18	-32.02	28.31	63.7	47.9	60.0	44.2	74.0	54.0	-14.0	-9.8	111.80	1.00

NOTE :

1. Measurement uncertainty is +/-2dB.
2. "": The Peak reading value also meets average limit and measurement with the average detector is unnecessary.
3. Emission Level = Reading Value + Ant. Factor + Correct Factor (incl.:Cable Loss and Pre-Amplifier Gain)
4. The field strength of other emission frequencies were very low against the limit.
5. (F):The field strength of fundamental frequency.



Spectrum Research & Testing Lab., Inc.
No. 101-10, Ling 8,
Shan-Tong Li, Chung-Li
City, Taoyuan, Taiwan

TEST REPORT

Reference No.: C006032406
Report No.: FCCC05121206-02
FCC ID: I4L-MS6833B-M
Page:36 of 96
Date: APR. 09, 2006

Temperature:	20 °C	Humidity:	62 %RH
Frequency Range:	30 – 1000 MHz	Measured Distance:	3m
Receiver Detector:	Q.P.	Tested Mode:	Link
Tested By:	Nick Hsieh	Tested Date:	Jan. 06, 2006
Antenna Type:	DIPOLE		

Antenna Polarization:Horizontal

Frequency (MHz)	Cable Loss (dB)	Antenna Factor (dB/m)	Reading Data (dBμV)	Emission Level (dBμV/m)	Limit (dBμV/m)	Margin (dB)	AZ(°)	EL(m)
133.0350	2.06	8.48	24.2	34.7	43.5	-8.8	268.9	1.4
365.3700	3.37	15.13	21.4	39.9	46.0	-6.1	130.2	1.2
499.4800	4.12	16.10	16.2	36.4	46.0	-9.6	98.2	1.2
564.9850	4.43	16.93	11.9	33.3	46.0	-12.7	129.6	1.1
666.6300	4.85	19.78	8.6	33.2	46.0	-12.8	78.3	1.1
730.8600	5.13	21.27	9.1	35.5	46.0	-10.5	220.6	1.2

Antenna Polarization:Vertical

Frequency (MHz)	Cable Loss (dB)	Antenna Factor (dB/m)	Reading Data (dBμV)	Emission Level (dBμV/m)	Limit (dBμV/m)	Margin (dB)	AZ(°)	EL(m)
132.8850	2.05	8.32	25.4	35.8	43.5	-7.7	221.1	1.3
163.3000	2.25	9.48	13.3	25.0	43.5	-18.5	296.3	1.2
215.5700	2.59	10.20	10.4	23.2	43.5	-20.3	88.7	1.1
563.8450	4.43	16.92	11.5	32.8	46.0	-13.2	20.3	1.1
663.0100	4.83	19.67	9.6	34.1	46.0	-11.9	117.2	1.0
729.3100	5.12	21.26	10.3	36.7	46.0	-9.3	89.5	1.0

NOTE :

1. Measurement uncertainty is +/-2dB.
2. "": Measurement does not apply for this frequency.
3. Emission Level = Reading Value + Ant. Factor + Cable Loss.
4. The field strength of other emission frequencies were very low against the limit.



TEST REPORT

Temperature:	20°C	Humidity:	62 %RH
Frequency Range:	1 – 25 GHz	Measured Distance:	3m
Receiver Detector:	PK. or AV.	Tested Mode:	IEEE 802.11g
Tested By:	Nick Hsieh	Tested Channel:	CH 1 : 2412MHz
Tested Date:	Jan. 06, 2005	Modulation Type:	OFDM
Antenna Type:	DIPOLE		

Antenna Polarization : Horizontal

Frequency (MHz)	Correct Factor (dB)	Ant. Factor (dB/m)	Reading Data (dBµV)		Emission Level (dBµV/m)		Limit (dBµV/m)		Margin (dB)		AZ (°)	EL (m)
			PK.	AV.	PK.	AV.	PK.	AV.	PK.	AV.		
2412.00	-32.18	28.56	102.3	92.3	98.7	88.7	N/A	N/A	N/A	N/A	78.00	1.1
2400.00	-32.16	28.00	62.7	46.7	58.5	42.5	74.0	54.0	-15.5	-11.5	89.00	1.1
4824.00	-30.41	33.66	63.1	46.2	66.3	49.4	74.0	54.0	-7.7	-4.6	103.00	1.1
7236.00	-28.98	36.29	62.4	42.8	69.7	50.1	74.0	54.0	-4.3	-3.9	182.00	1.2
2394.50	-32.18	27.99	63.1	46.8	58.9	42.6	74.0	54.0	-15.1	-11.4	193.00	1.4
2429.00	-32.21	28.06	63.3	45.2	59.2	41.1	74.0	54.0	-14.8	-12.9	321.00	1.3

Antenna Polarization : Vertical

Frequency (MHz)	Correct Factor (dB)	Ant. Factor (dB/m)	Reading Data (dBµV)		Emission Level (dBµV/m)		Limit (dBµV/m)		Margin (dB)		AZ (°)	EL (m)
			PK.	AV.	PK.	AV.	PK.	AV.	PK.	AV.		
2412.00	-32.18	28.02	101.9	94.3	97.7	90.1	N/A	N/A	N/A	N/A	278.00	1.3
4824.00	-30.41	33.66	64.8	46.5	68.0	49.7	74.0	54.0	-6.0	-4.3	316.00	1.2
7236.00	-28.98	36.29	61.5	43.2	68.8	50.5	74.0	54.0	-5.2	-3.5	223.00	1.2
2400.00	-32.16	28.00	62.9	41.9	58.7	37.7	74.0	54.0	-15.3	-16.3	87.00	1.0
2398.00	-32.17	28.00	63.7	43.7	59.5	39.5	74.0	54.0	-14.5	-14.5	97.00	1.0
2425.40	-32.20	28.05	64.1	43.8	59.9	39.6	74.0	54.0	-14.1	-14.4	39.00	1.0

NOTE :

1. Measurement uncertainty is +/-2dB.
2. "": The Peak reading value also meets average limit and measurement with the average detector is unnecessary.
3. Emission Level = Reading Value + Ant. Factor + Correct Factor (incl.:Cable Loss and Pre-Amplifier Gain)
4. The field strength of other emission frequencies were very low against the limit.
5. (F):The field strength of fundamental frequency.



TEST REPORT

Temperature:	20C	Humidity:	62 %RH
Frequency Range:	1 – 25 GHz	Measured Distance:	3m
Receiver Detector:	PK. or AV.	Tested Mode:	IEEE 802.11g
Tested By:	Nick Hsieh	Tested Channel:	CH 6 : 2437MHz
Tested Date:	Jan. 06, 2006	Modulation Type:	OFDM
Antenna Type:	DIPOLE		

Antenna Polarization : Horizontal

Frequency (MHz)	Correct Factor (dB)	Ant. Factor (dB/m)	Reading Data (dB μ V)		Emission Level (dB μ V/m)		Limit (dB μ V/m)		Margin (dB)		AZ (°)	EL (m)
			PK.	AV.	PK.	AV.	PK.	AV.	PK.	AV.		
2437.00	-32.22	28.61	103.2	93.2	99.6	89.6	N/A	N/A	N/A	N/A	215.00	1.4
4874.00	-30.28	33.70	61.3	46.5	64.7	49.9	74.0	54.0	-9.3	-4.1	348.00	1.2
7311.00	-29.07	36.35	62.3	43.1	69.6	50.4	74.0	54.0	-4.4	-3.6	321.00	1.2
2415.00	-32.18	28.03	61.2	45.3	57.0	41.1	74.0	54.0	-17.0	-12.9	332.00	1.3
2457.00	-32.23	28.11	62.9	45.8	58.8	41.7	74.0	54.0	-15.2	-12.3	68.00	1.2
2483.00	-32.19	28.17	62.4	46.9	58.4	42.9	74.0	54.0	-15.6	-11.1	76.00	1.2

Antenna Polarization : Vertical

Frequency (MHz)	Correct Factor (dB)	Ant. Factor (dB/m)	Reading Data (dB μ V)		Emission Level (dB μ V/m)		Limit (dB μ V/m)		Margin (dB)		AZ (°)	EL (m)
			PK.	AV.	PK.	AV.	PK.	AV.	PK.	AV.		
2437.00	-32.22	28.07	102.7	96.6	98.6	92.5	N/A	N/A	N/A	N/A	87.00	1.1
4874.00	-30.28	33.70	64.7	44.2	68.1	47.6	74.0	54.0	-5.9	-6.4	324.00	1.2
7311.00	-29.07	36.35	63.4	43.5	70.7	50.8	74.0	54.0	-3.3	-3.2	355.00	1.2
2421.40	-32.19	28.04	63.9	46.8	59.7	42.6	74.0	54.0	-14.3	-11.4	308.00	1.0
2417.20	-32.19	28.03	62.6	45.2	58.4	41.0	74.0	54.0	-15.6	-13.0	297.00	1.0
2449.80	-32.24	28.10	62.9	45.7	58.8	41.6	74.0	54.0	-15.2	-12.4	288.00	1.3

NOTE :

1. Measurement uncertainty is +/-2dB.
2. "": The Peak reading value also meets average limit and measurement with the average detector is unnecessary.
3. Emission Level = Reading Value + Ant. Factor + Correct Factor (incl.:Cable Loss and Pre-Amplifier Gain)
4. The field strength of other emission frequencies were very low against the limit.
5. (F):The field strength of fundamental frequency.



TEST REPORT

Temperature:	20°C	Humidity:	62 %RH
Frequency Range:	1 – 25 GHz	Measured Distance:	3m
Receiver Detector:	PK. or AV.	Tested Mode:	IEEE 802.11g
Tested By:	Nick Hsieh	Tested Channel:	CH 11 : 2462MHz
Tested Date:	Jan. 06, 2006	Modulation Type:	OFDM
Antenna Type:	DIPOLE		

Antenna Polarization : Horizontal

Frequency (MHz)	Correct Factor (dB)	Ant. Factor (dB/m)	Reading Data (dBµV)		Emission Level (dBµV/m)		Limit (dBµV/m)		Margin (dB)		AZ (°)	EL (m)
			PK.	AV.	PK.	AV.	PK.	AV.	PK.	AV.		
2462.00	-32.22	28.69	102.7	98.3	99.2	94.8	N/A	N/A	N/A	N/A	78.00	1.1
4924.00	-30.23	33.74	63.2	46.5	66.7	50.0	74.0	54.0	-7.3	-4.0	89.00	1.0
7386.00	-28.94	36.41	64.4	43.2	71.9	50.7	74.0	54.0	-2.1	-3.3	103.00	1.0
2483.50	-32.19	28.17	62.7	44.9	58.7	40.9	74.0	54.0	-15.3	-13.1	182.00	1.2
2475.00	-32.20	28.15	62.9	47.1	58.9	43.1	74.0	54.0	-15.1	-10.9	193.00	1.2
2449.55	-32.24	28.10	62.1	46.3	58.0	42.2	74.0	54.0	-16.0	-11.8	321.00	1.3

Antenna Polarization : Vertical

Frequency (MHz)	Correct Factor (dB)	Ant. Factor (dB/m)	Reading Data (dBµV)		Emission Level (dBµV/m)		Limit (dBµV/m)		Margin (dB)		AZ (°)	EL (m)
			PK.	AV.	PK.	AV.	PK.	AV.	PK.	AV.		
2462.00	-32.22	28.12	101.2	97.4	97.1	93.3	N/A	N/A	N/A	N/A	278.00	2.0
4924.00	-30.23	33.74	63.7	45.7	67.2	49.2	74.0	54.0	-6.8	-4.8	316.00	1.4
7386.00	-28.94	36.41	61.9	43.6	69.4	51.1	74.0	54.0	-4.6	-2.9	223.00	1.4
2483.50	-32.19	28.17	63.0	44.1	59.0	40.1	74.0	54.0	-15.0	-13.9	87.00	1.3
2449.00	-32.24	28.10	63.3	44.7	59.2	40.6	74.0	54.0	-14.8	-13.4	97.00	1.3
2474.00	-32.20	28.15	62.3	43.2	58.2	39.1	74.0	54.0	-15.8	-14.9	39.00	1.2

NOTE :

1. Measurement uncertainty is +/-2dB.
2. "": The Peak reading value also meets average limit and measurement with the average detector is unnecessary.
3. Emission Level = Reading Value + Ant. Factor + Correct Factor (incl.:Cable Loss and Pre-Amplifier Gain)
4. The field strength of other emission frequencies were very low against the limit.
5. (F):The field strength of fundamental frequency.



TEST REPORT

Temperature:	20°C	Humidity:	62%RH
Frequency Range:	1 – 25 GHz	Measured Distance:	3m
Receiver Detector:	PK. or AV.	Tested Mode:	IEEE 802.11b
Tested By:	Nick Hsieh	Tested Channel:	CH 1 : 2412MHz
Tested Date:	Jan. 06, 2006	Modulation Type:	CCK
Antenna Type:	DIPOLE		

Antenna Polarization : Horizontal

Frequency (MHz)	Correct Factor (dB)	Ant. Factor (dB/m)	Reading Data (dBμV)		Emission Level (dBμV/m)		Limit (dBμV/m)		Margin (dB)		AZ (°)	EL (m)
			PK.	AV.	PK.	AV.	PK.	AV.	PK.	AV.		
2412.00	-32.18	28.56	101.3	96.7	97.7	93.1	N/A	N/A	N/A	N/A	192.00	1.00
4824.00	-30.41	33.66	62.8	47.2	66.0	50.4	74.0	54.0	-8.0	-3.6	83.40	1.00
7236.00	-28.98	36.29	61.9	41.4	69.2	48.7	74.0	54.0	-4.8	-5.3	127.40	1.00
2400.00	-32.16	28.00	61.3	45.8	57.1	41.6	74.0	54.0	-16.9	-12.4	169.30	1.10
2368.00	-32.28	27.94	62.8	45.4	58.5	41.1	74.0	54.0	-15.5	-12.9	110.40	1.10
2427.00	-32.20	28.05	61.7	43.1	57.6	39.0	74.0	54.0	-16.4	-15.0	70.50	1.00

Antenna Polarization : Vertical

Frequency (MHz)	Correct Factor (dB)	Ant. Factor (dB/m)	Reading Data (dBμV)		Emission Level (dBμV/m)		Limit (dBμV/m)		Margin (dB)		AZ (°)	EL (m)
			PK.	AV.	PK.	AV.	PK.	AV.	PK.	AV.		
2412.00	-32.18	28.02	102.4	95.4	98.2	91.2	N/A	N/A	N/A	N/A	279.30	1.00
2400.00	-32.16	28.00	63.1	47.2	58.9	43.0	74.0	54.0	-15.1	-11.0	34.20	1.10
4824.00	-30.41	33.66	62.8	43.1	66.0	46.3	74.0	54.0	-8.0	-7.7	88.40	1.20
7236.00	-28.98	36.29	60.9	43.2	68.2	50.5	74.0	54.0	-5.8	-3.5	234.90	1.00
2394.00	-32.18	27.99	61.7	44.6	57.5	40.4	74.0	54.0	-16.5	-13.6	120.40	1.10
2429.00	-32.21	28.06	61.4	43.2	57.3	39.1	74.0	54.0	-16.7	-14.9	89.40	1.00

NOTE :

1. Measurement uncertainty is +/-2dB.
2. "": The Peak reading value also meets average limit and measurement with the average detector is unnecessary.
3. Emission Level = Reading Value + Ant. Factor + Correct Factor (incl.:Cable Loss and Pre-Amplifier Gain)
4. The field strength of other emission frequencies were very low against the limit.
5. (F):The field strength of fundamental frequency.



TEST REPORT

Temperature:	20 °C	Humidity:	62 %RH
Frequency Range:	1 – 25 GHz	Measured Distance:	3m
Receiver Detector:	PK. or AV.	Tested Mode:	IEEE 802.11b
Tested By:	Nick Hsieh	Tested Channel:	CH 6 : 2437MHz
Tested Date:	Jan. 06, 2006	Modulation Type:	CCK
Antenna Type:	DIPOLE		

Antenna Polarization : Horizontal

Frequency (MHz)	Correct Factor (dB)	Ant. Factor (dB/m)	Reading Data (dBµV)		Emission Level (dBµV/m)		Limit (dBµV/m)		Margin (dB)		AZ (°)	EL (m)
			PK.	AV.	PK.	AV.	PK.	AV.	PK.	AV.		
2437.00	-32.22	28.61	107.7	102.8	104.1	99.2	N/A	N/A	N/A	N/A	199.60	1.10
4874.00	-30.28	33.70	63.6	45.1	67.0	48.5	74.0	54.0	-7.0	-5.5	344.10	1.00
7311.00	-29.07	36.35	62.1	44.1	69.4	51.4	74.0	54.0	-4.6	-2.6	89.50	1.00
2452.20	-32.24	28.10	61.4	45.7	57.3	41.6	74.0	54.0	-16.7	-12.4	112.70	1.20
2473.21	-32.20	28.15	62.7	46.1	58.6	42.0	74.0	54.0	-15.4	-12.0	175.80	1.00
2510.36	-32.09	28.26	63.2	45.6	59.4	41.8	74.0	54.0	-14.6	-12.2	87.90	1.10

Antenna Polarization : Vertical

Frequency (MHz)	Correct Factor (dB)	Ant. Factor (dB/m)	Reading Data (dBµV)		Emission Level (dBµV/m)		Limit (dBµV/m)		Margin (dB)		AZ (°)	EL (m)
			PK.	AV.	PK.	AV.	PK.	AV.	PK.	AV.		
2437.00	-32.22	28.07	104.7	98.5	100.6	94.4	N/A	N/A	N/A	N/A	234.90	1.00
4874.00	-30.28	33.70	61.3	45.1	64.7	48.5	74.0	54.0	-9.3	-5.5	127.40	1.00
7311.00	-29.07	36.35	60.9	42.3	68.2	49.6	74.0	54.0	-5.8	-4.4	233.80	1.00
2415.00	-32.18	28.03	61.2	42.9	57.0	38.7	74.0	54.0	-17.0	-15.3	68.90	1.20
2457.00	-32.23	28.11	62.7	43.7	58.6	39.6	74.0	54.0	-15.4	-14.4	85.30	1.30
2483.00	-32.19	28.17	62.9	43.6	58.9	39.6	74.0	54.0	-15.1	-14.4	139.50	1.10

NOTE :

1. Measurement uncertainty is +/-2dB.
2. "F": The Peak reading value also meets average limit and measurement with the average detector is unnecessary.
3. Emission Level = Reading Value + Ant. Factor + Correct Factor (incl.:Cable Loss and Pre-Amplifier Gain)
4. The field strength of other emission frequencies were very low against the limit.
5. (F):The field strength of fundamental frequency.



TEST REPORT

Temperature:	25 °C	Humidity:	61 %RH
Frequency Range:	1 – 25 GHz	Measured Distance:	3m
Receiver Detector:	PK. or AV.	Tested Mode:	IEEE 802.11b
Tested By:	Julian Chiang	Tested Channel:	CH 11 : 2462MHz
Tested Date:	Nov. 14, 2005	Modulation Type:	CCK
Antenna Type:	DIPOLE		

Antenna Polarization : Horizontal

Frequency (MHz)	Correct Factor (dB)	Ant. Factor (dB/m)	Reading Data (dBµV)		Emission Level (dBµV/m)		Limit (dBµV/m)		Margin (dB)		AZ (°)	EL (m)
			PK.	AV.	PK.	AV.	PK.	AV.	PK.	AV.		
2462.00	-32.22	28.69	104.9	99.4	101.4	95.9	N/A	N/A	N/A	N/A	238.1	1.7
4924.00	-30.23	33.74	61.8	44.3	65.3	47.8	74.0	54.0	-8.7	-6.2	129.8	1.2
7386.00	-28.94	36.41	60.2	40.6	67.7	48.1	74.0	54.0	-6.3	-5.9	348.4	1.3
2483.50	-32.19	28.17	62.9	46.1	58.9	42.1	74.0	54.0	-15.1	-11.9	126.7	1.3
2476.80	-32.20	28.15	63.1	44.7	59.1	40.7	74.0	54.0	-14.9	-13.3	144.2	2.1
2447.00	-32.24	28.09	62.6	46.3	58.5	42.2	74.0	54.0	-15.5	-11.8	234.9	1.7

Antenna Polarization : Vertical

Frequency (MHz)	Correct Factor (dB)	Ant. Factor (dB/m)	Reading Data (dBµV)		Emission Level (dBµV/m)		Limit (dBµV/m)		Margin (dB)		AZ (°)	EL (m)
			PK.	AV.	PK.	AV.	PK.	AV.	PK.	AV.		
2462.00	-32.22	28.12	105.7	98.5	101.6	94.4	N/A	N/A	N/A	N/A	156.8	1.3
4924.00	-30.23	33.74	64.7	46.3	68.2	49.8	74.0	54.0	-5.8	-4.2	87.9	1.4
7386.00	-28.94	36.41	63.1	42.6	70.6	50.1	74.0	54.0	-3.4	-3.9	246.9	1.3
2483.50	-32.19	28.17	62.7	44.3	58.7	40.3	74.0	54.0	-15.3	-13.7	95.4	1.1
2475.00	-32.20	28.15	64.1	46.2	60.1	42.2	74.0	54.0	-13.9	-11.8	338.7	1.2
2449.55	-32.24	28.10	62.8	46.3	58.7	42.2	74.0	54.0	-15.3	-11.8	135.1	1.1

NOTE :

1. Measurement uncertainty is +/-2dB.
2. "F": The Peak reading value also meets average limit and measurement with the average detector is unnecessary.
3. Emission Level = Reading Value + Ant. Factor + Correct Factor (incl.:Cable Loss and Pre-Amplifier Gain)
4. The field strength of other emission frequencies were very low against the limit.
5. (F):The field strength of fundamental frequency.



4.3 6dBm BANDWIDTH TEST

4.3.1 LIMIT

FCC Part15, Subpart C Section 15.247(2). The minimum 6dBm bandwidth shall be at least 500 kHz.

4.3.2 TEST EQUIPMENT

The following test equipment was used during the test:

EQUIPMENT/ FACILITIES	SPECIFICATIONS	MANUFACTURER	MODEL#/ SERIAL#	DUE DATE OF CAL. & CAL. CENTER
SPECTRUM	9kHz-7GHz	ROHDE & SCHWARZ	FSP7/ 839511/010	APR. 2006 R&S

NOTE: The calibration interval of the above test equipment is one year and the calibrations are traceable to NML/ROC and NIST/USA.

4.3.3 TEST SET-UP

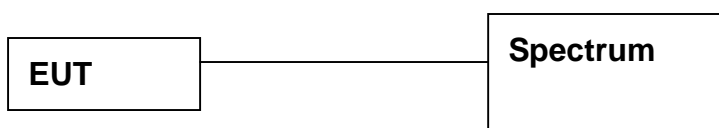

The EUT was connected to a spectrum through a 50Ω RF cable.

4.3.4 TEST PROCEDURE

The EUT was operating in the transmitter mode and could control its channels. The test result was printed by the hard copy function of the spectrum.

4.3.5 EUT OPERATING CONDITION

Same as section 4.1.5 of this report.



Spectrum Research & Testing Lab., Inc.
No. 101-10, Ling 8,
Shan-Tong Li, Chung-Li
City, Taoyuan, Taiwan

TEST REPORT

Reference No.: C006032406
Report No.: FCCC05121206-02
FCC ID: I4L-MS6833B-M
Page: 44 of 96
Date: APR. 09, 2006

4.3.6 TEST RESULT

Temperature:	23°C	Humidity:	60%RH
Spectrum Detector:	PK.	Tested Mode:	IEEE 802.11g
Tested By:	Nick Hsieh	Modulation Type:	OFDM
Tested Date:	Dec. 27, 2005	Antenna Type:	PIFA

CHANNEL NUMBER	CHANNEL FREQUENCY (MHz)	6dB DOWN BW (MHz)
1	2412	2.42
6	2437	2.45
11	2462	2.476

CH1:

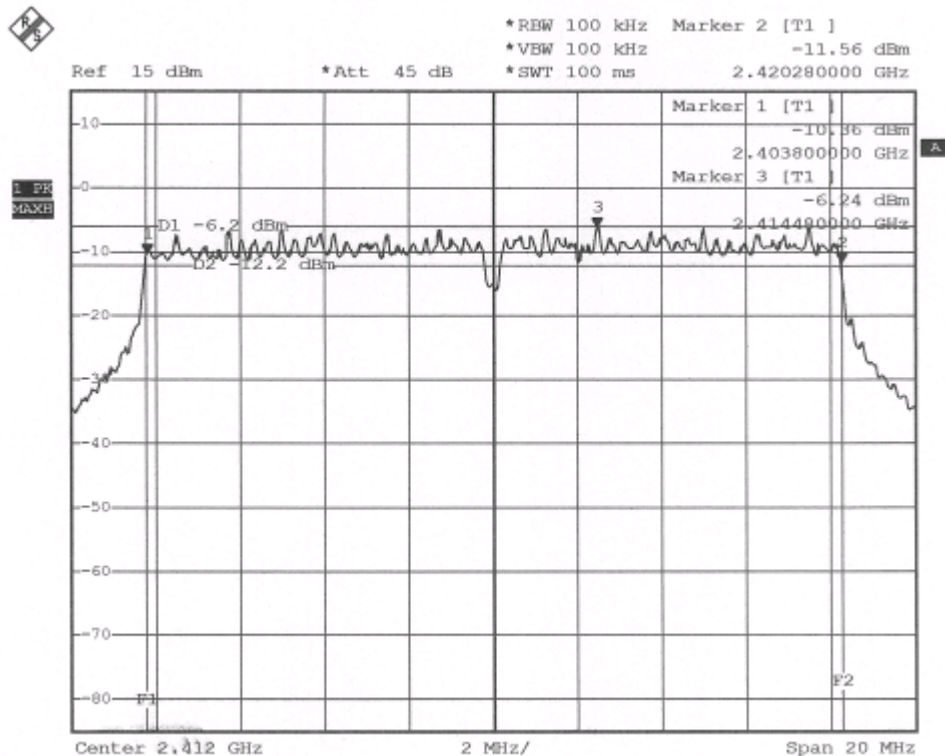



CH 6:

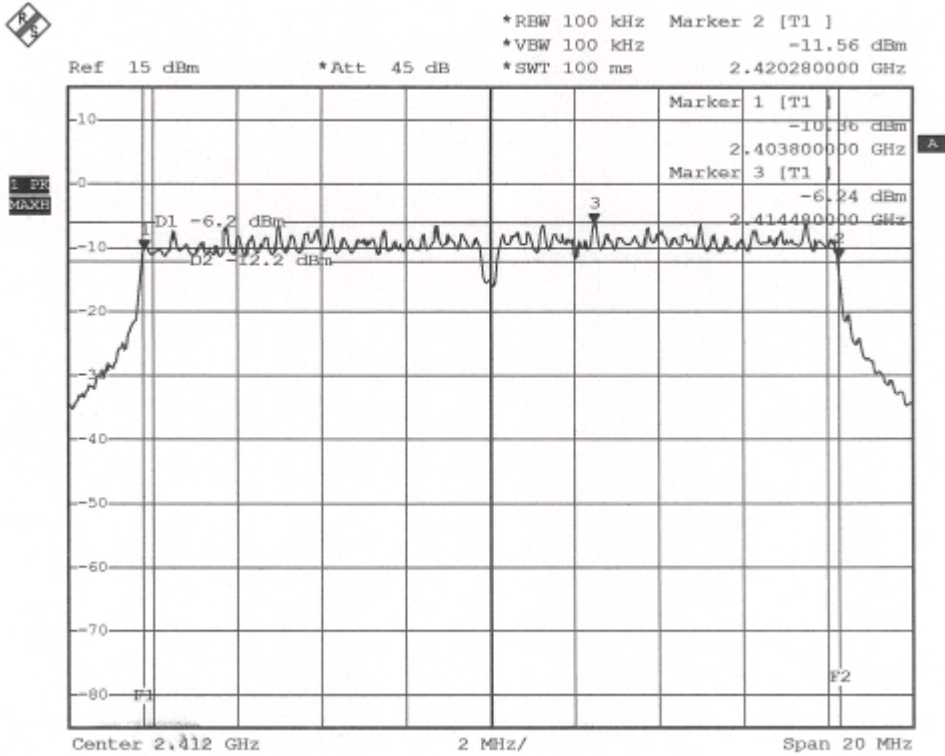

CH 11:

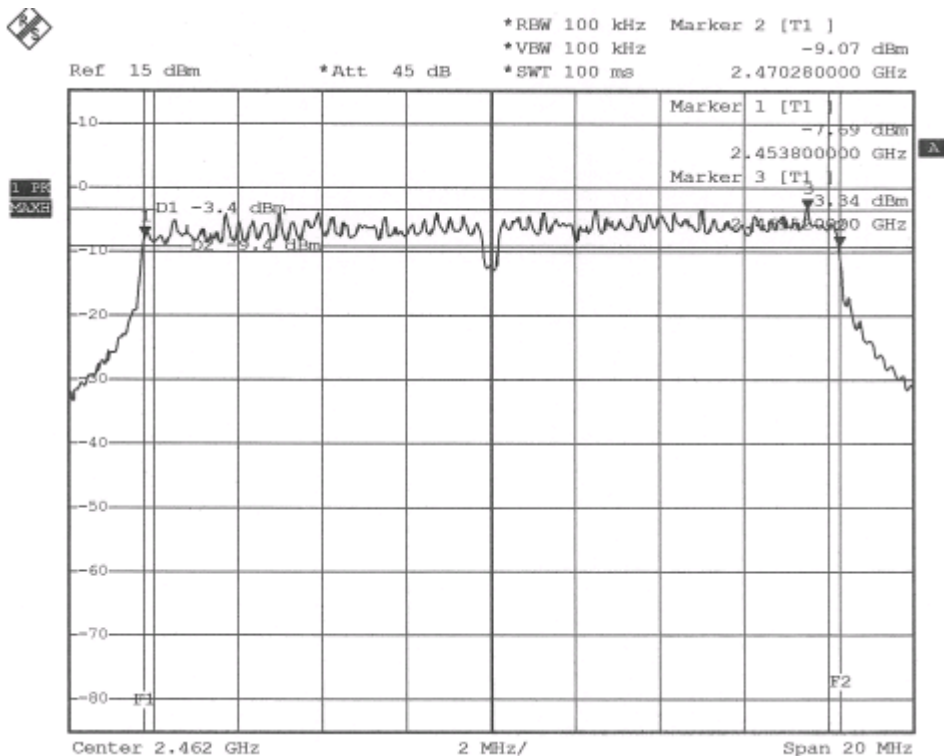



Spectrum Research & Testing Lab., Inc.
 No. 101-10, Ling 8,
 Shan-Tong Li, Chung-Li
 City, Taoyuan, Taiwan

TEST REPORT

Reference No.: C006032406
 Report No.: FCC05121206-02
 FCC ID: I4L-MS6833B-M
 Page: 46 of 96
 Date: APR. 09, 2006

Temperature:	<u>23°C</u>	Humidity:	<u>60%RH</u>
Spectrum Detector:	<u>PK.</u>	Tested Mode:	<u>IEEE 802.11b</u>
Tested By:	<u>Nick Hsieh</u>	Modulation Type:	<u>CCK</u>
Tested Date:	<u>Dec. 27, 2005</u>	Antenna Type:	<u>PIFA</u>

CHANNEL NUMBER	CHANNEL FREQUENCY (MHz)	6dB DOWN BW (MHz)
1	2412	2.41
6	2437	2.44
11	2462	2.47

CH1:

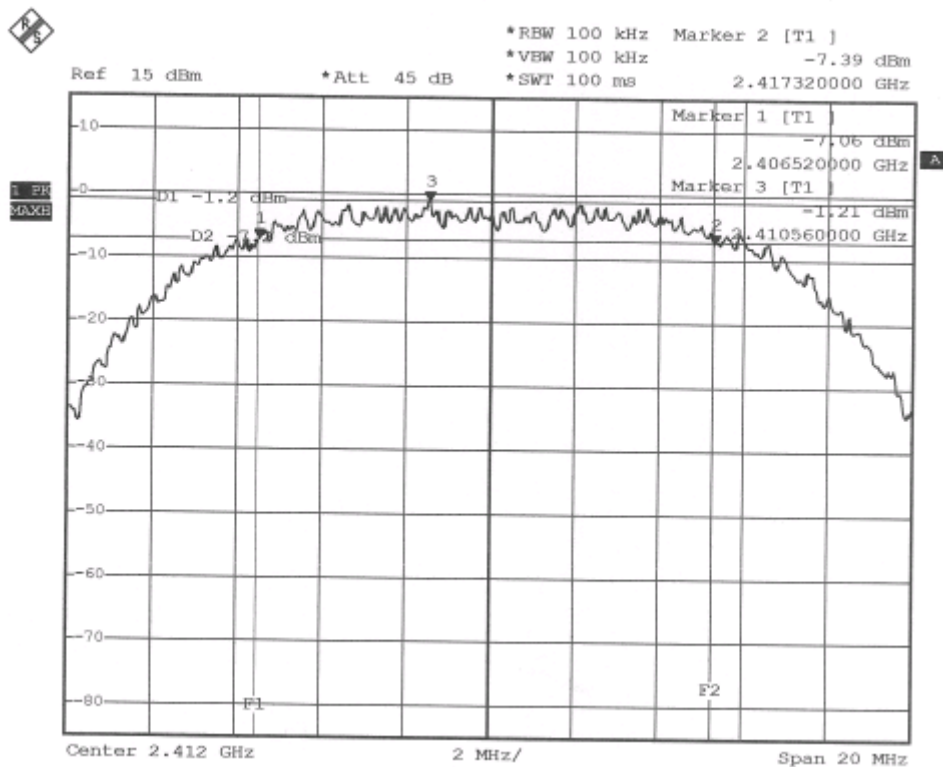



CH6

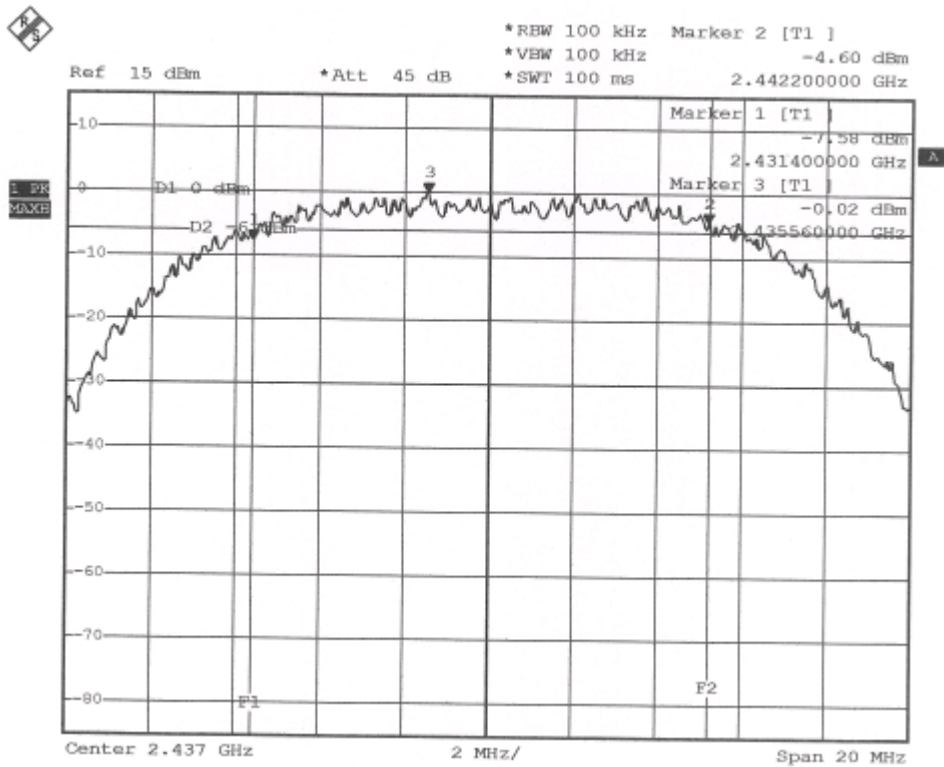

CH11

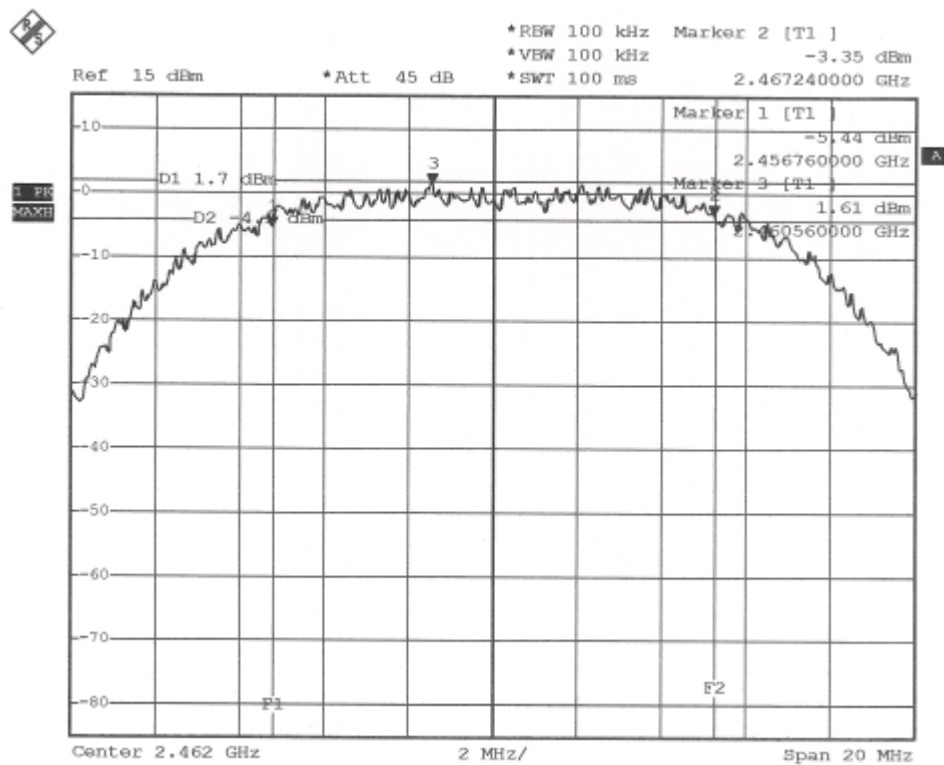



Spectrum Research & Testing Lab., Inc.
 No. 101-10, Ling 8,
 Shan-Tong Li, Chung-Li
 City, Taoyuan, Taiwan

TEST REPORT

Reference No.: C006032406
 Report No.: FCCC05121206-02
 FCC ID: I4L-MS6833B-M
 Page: 48 of 96
 Date: APR. 09, 2006

Temperature:	<u>23°C</u>	Humidity:	<u>60%RH</u>
Spectrum Detector:	<u>PK.</u>	Tested Mode:	<u>IEEE 802.11b</u>
Tested By:	<u>Nick Hsieh</u>	Modulation Type:	<u>OFDM</u>
Tested Date:	<u>Dec. 26, 2005</u>	Antenna Type:	<u>DIPOLE</u>

CHANNEL NUMBER	CHANNEL FREQUENCY (MHz)	6dB DOWN BW (MHz)
1	2412	16.48
6	2437	16.52
11	2462	16.52

CH1:

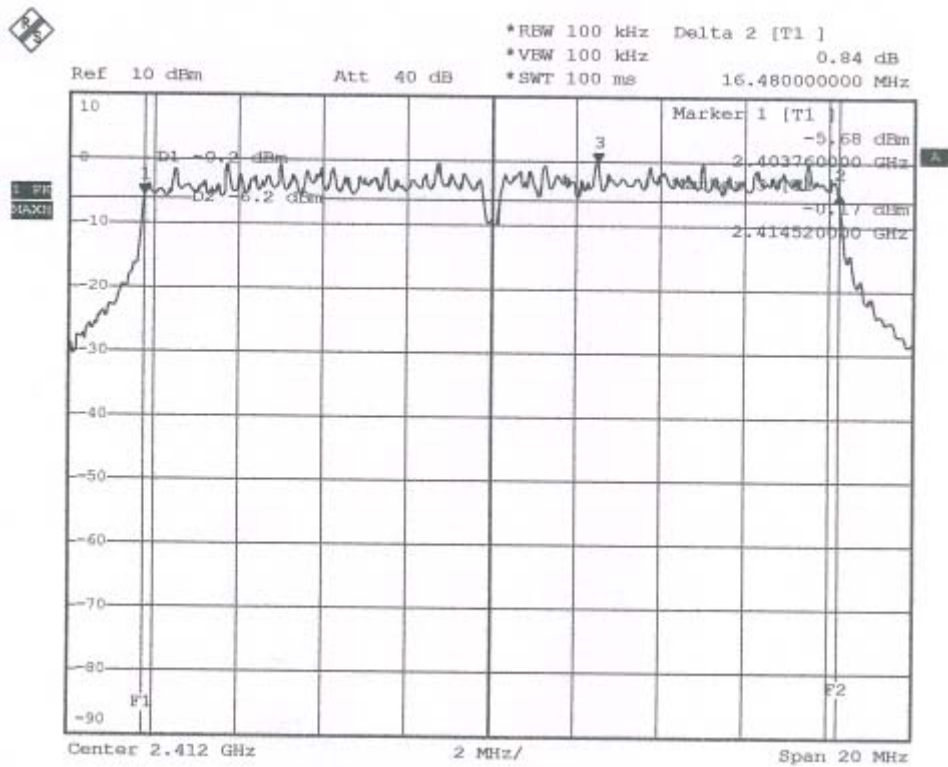



CH6

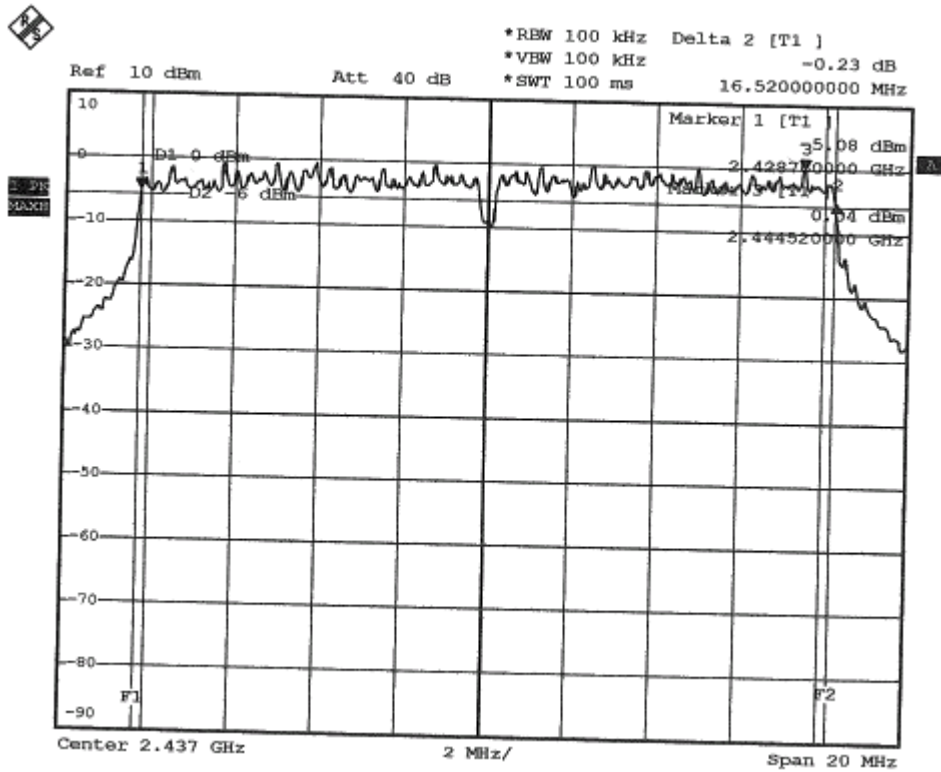

CH11

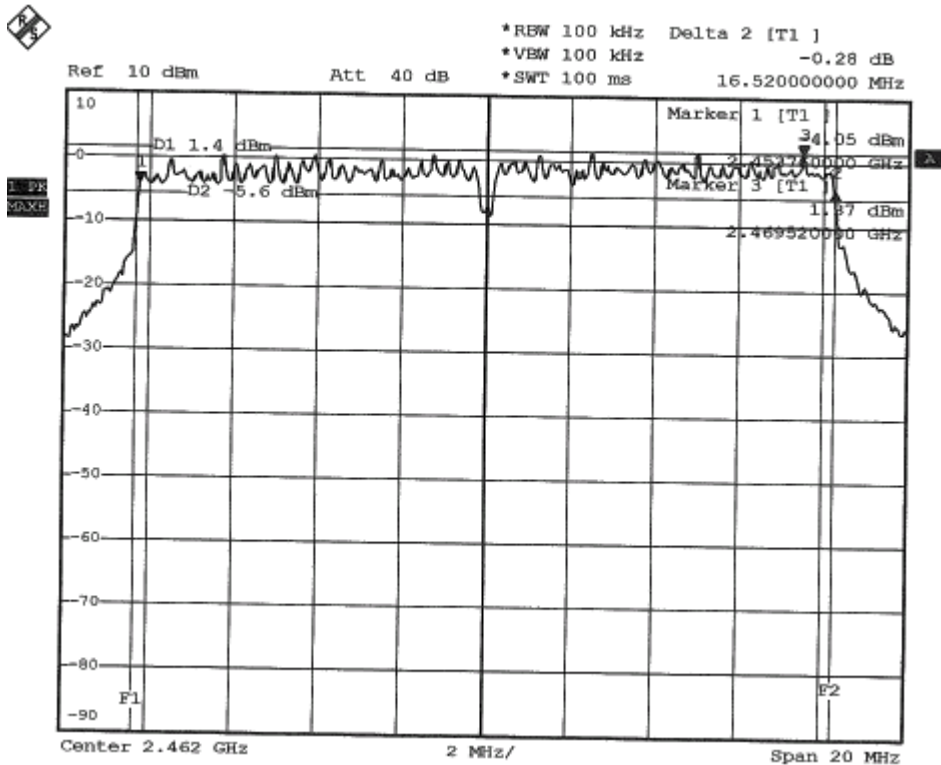



Spectrum Research & Testing Lab., Inc.
 No. 101-10, Ling 8,
 Shan-Tong Li, Chung-Li
 City, Taoyuan, Taiwan

TEST REPORT

Reference No.: C006032406
 Report No.: FCCC05121206-02
 FCC ID: I4L-MS6833B-M
 Page: 50 of 96
 Date: APR. 09, 2006

Temperature:	<u>23°C</u>	Humidity:	<u>60%RH</u>
Spectrum Detector:	<u>PK.</u>	Tested Mode:	<u>IEEE 802.11b</u>
Tested By:	<u>Nick Hsieh</u>	Modulation Type:	<u>CCK</u>
Tested Date:	<u>Dec. 26, 2005</u>	Antenna Type:	<u>DIPOLE</u>

CHANNEL NUMBER	CHANNEL FREQUENCY (MHz)	6dB DOWN BW (MHz)
1	2412	11.16
6	2437	11.12
11	2462	11.76

CH1:

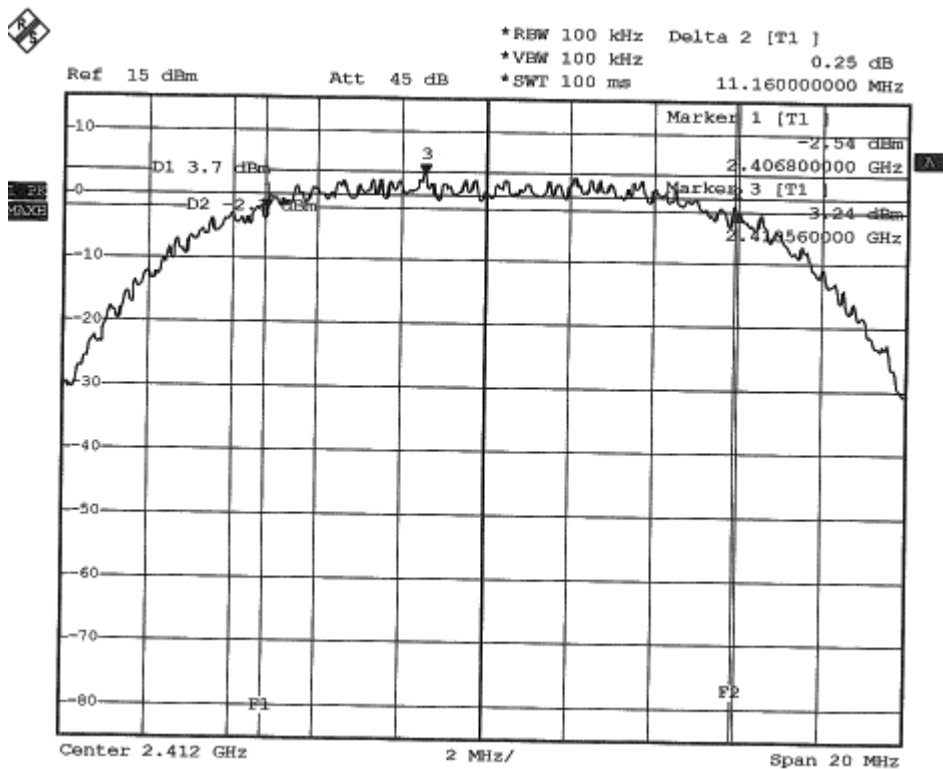



CH6

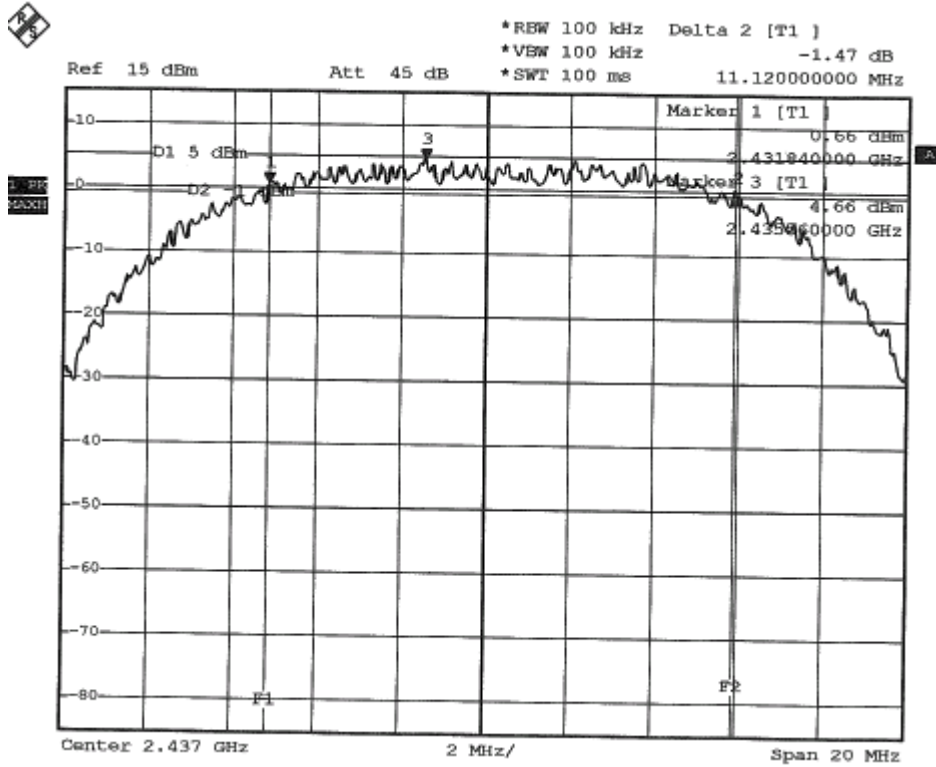

CH11

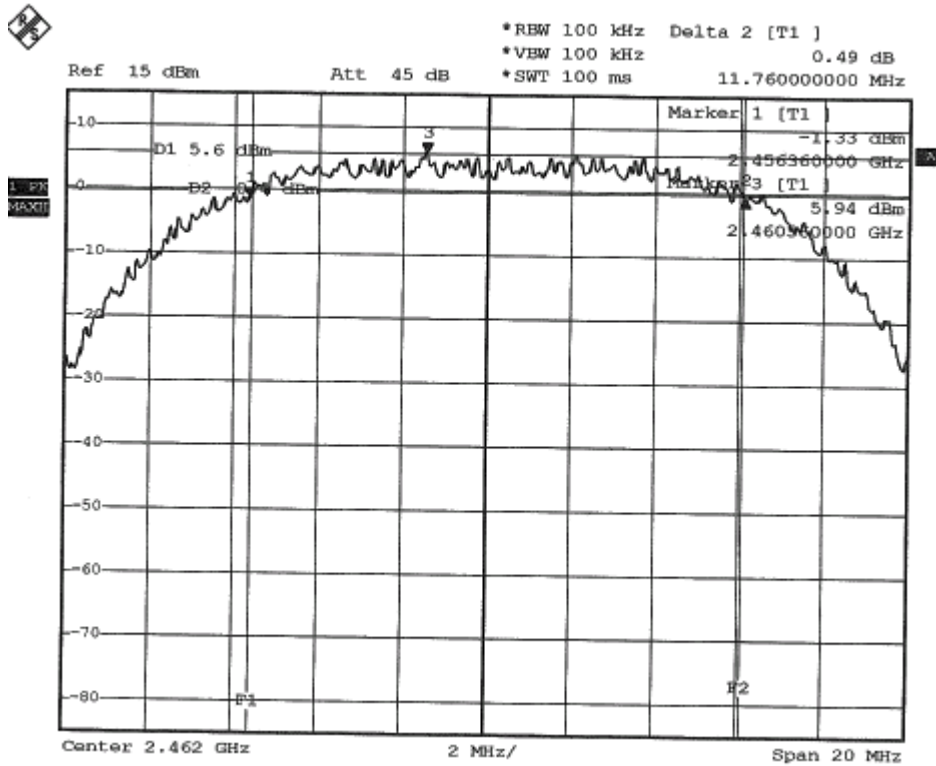



Spectrum Research & Testing Lab., Inc.
No. 101-10, Ling 8,
Shan-Tong Li, Chung-Li
City, Taoyuan, Taiwan

TEST REPORT

Reference No.: C006032406
Report No.: FCCC05121206-02
FCC ID: I4L-MS6833B-M
Page: 52 of 96
Date: APR. 09, 2006

4.4 PEAK POWER TEST

4.4.1 LIMIT

FCC Part15, Subpart C Section 15.247

FREQUENCY RANGE(MHz)	LIMIT(W)
902 - 928	1(30dBm)
2400 - 2483.5	1(30dBm)
5725 - 5850	1(30dBm)

4.4.2 TEST EQUIPMENT

The following test equipment was used during the test:

EQUIPMENT/ FACILITIES	SPECIFICATIONS	MANUFACTURER	MODEL#/ SERIAL#	DUE DATE OF CAL. & CAL. CENTER
SPECTRUM	9kHz-7GHz	ROHDE & SCHWARZ	FSP7/ 839511/010	APR. 2006 R&S
POWER METER	N/A	BOONTON	4232A/ 29001	MAY 2006 ETC
POWER SENSOR	DC-8GHz 50 Ω	BOONTON	51011EMC/ 31181	NOV. 2006 ETC

NOTE: The calibration interval of the above test equipment is one year and the calibrations are traceable to NML/ROC and NIST/USA.



4.4.3 TEST SET-UP

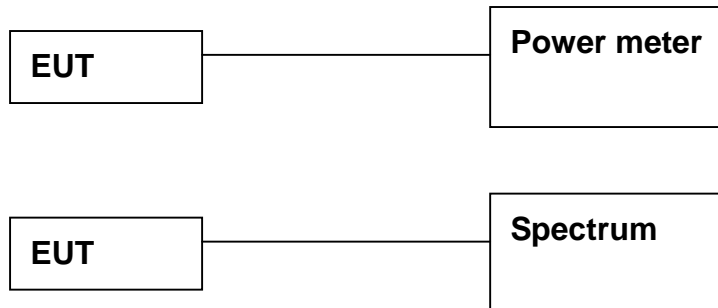

The EUT was connected to a spectrum through a 50Ω RF cable.

4.4.4 TEST PROCEDURE

The EUT was operating in transmitter mode and could control its channel.
Printed out the test result from the spectrum by hard copy function.
Recorded the read value of the power meter.

4.4.5 EUT OPERATING CONDITION

Same as section 4.1.5 of this report.



Spectrum Research & Testing Lab., Inc.
No. 101-10, Ling 8,
Shan-Tong Li, Chung-Li
City, Taoyuan, Taiwan

TEST REPORT

Reference No.: C006032406
Report No.: FCCC05121206-02
FCC ID: I4L-MS6833B-M
Page: 54 of 96
Date: APR. 09, 2006

4.4.6 TEST RESULT

Temperature:	23°C	Humidity:	60%RH
Spectrum Detector:	PK.	Tested Mode:	IEEE 802.11g
Tested By:	Nick Hsieh	Modulation Type:	OFDM
Tested Date:	Dec. 27, 2005	Antenna Type:	PIFA

CHANNEL NUMBER	CHANNEL FREQUENCY (MHz)	PEAK POWER OUTPUT (dBm)
1	2412	9.70
6	2437	9.65
11	2462	9.85

CH1:

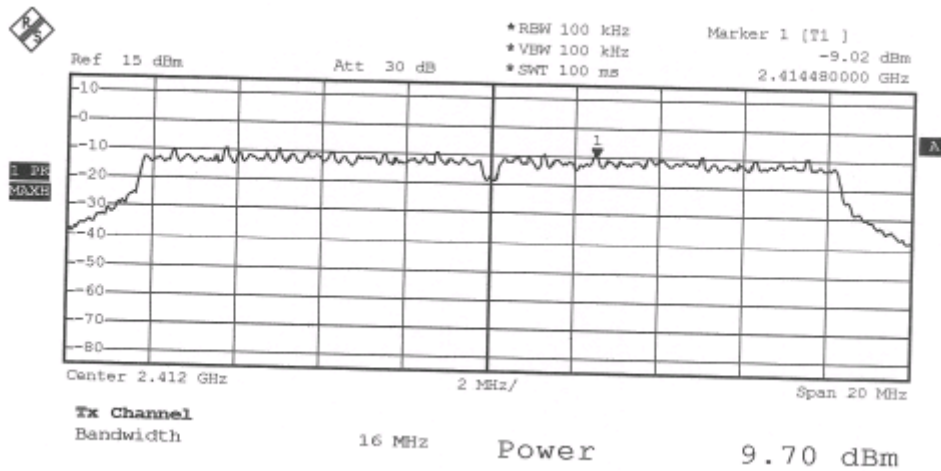



CH6

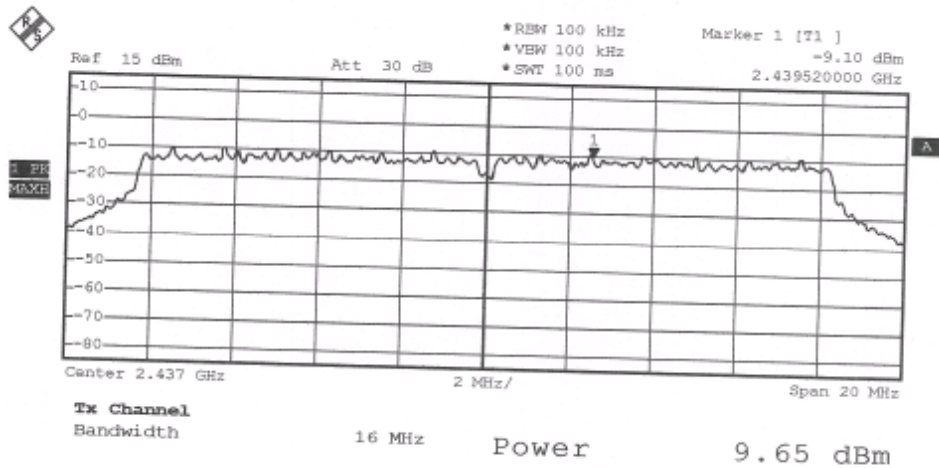

CH11

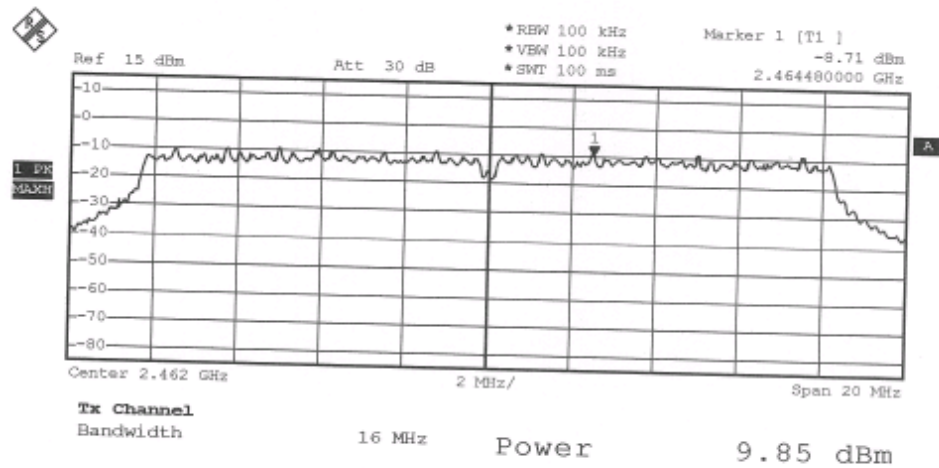



Spectrum Research & Testing Lab., Inc.
No. 101-10, Ling 8,
Shan-Tong Li, Chung-Li
City, Taoyuan, Taiwan

TEST REPORT

Reference No.: C006032406
Report No.: FCCC05121206-02
FCC ID: I4L-MS6833B-M
Page: 56 of 96
Date: APR. 09, 2006

Temperature:	23°C	Humidity:	60%RH
Spectrum Detector:	PK.	Tested Mode:	IEEE 802.11b
Tested By:	Nick Hsieh	Modulation Type:	CCK
Tested Date:	Dec. 27, 2005	Antenna Type:	PIFA

CHANNEL NUMBER	CHANNEL FREQUENCY (MHz)	PEAK POWER OUTPUT (dBm)
1	2412	14.65
6	2437	14.20
11	2462	14.48

CH1:

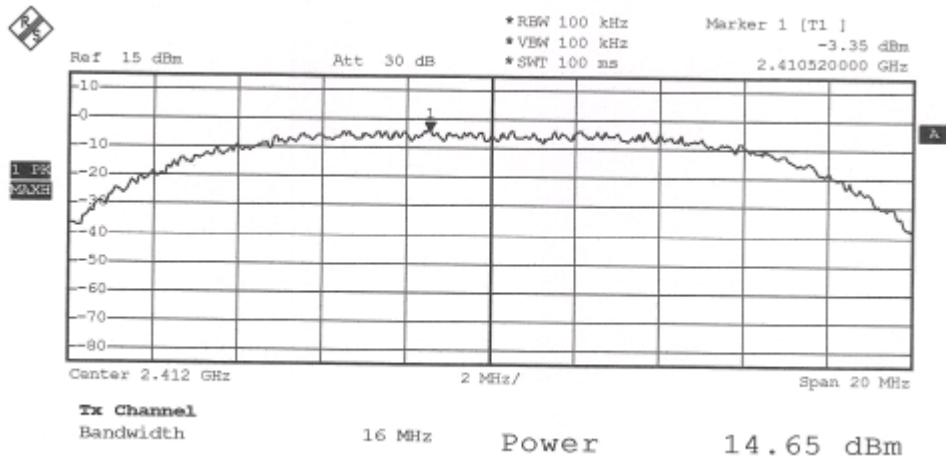



CH6

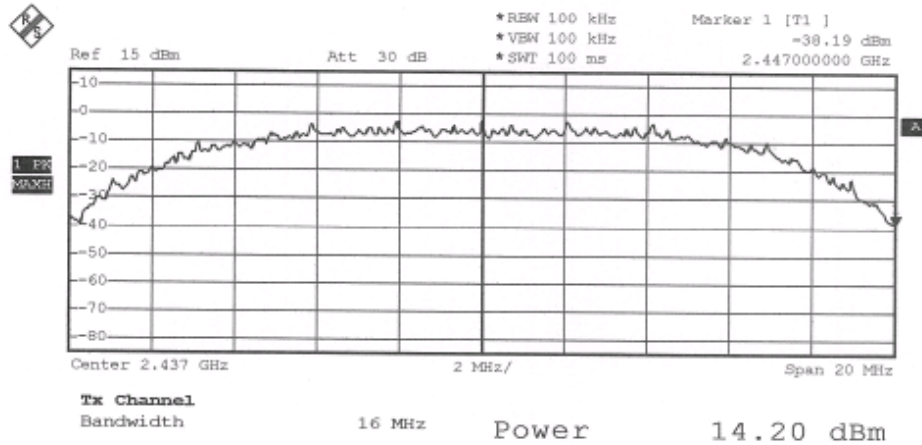

CH11

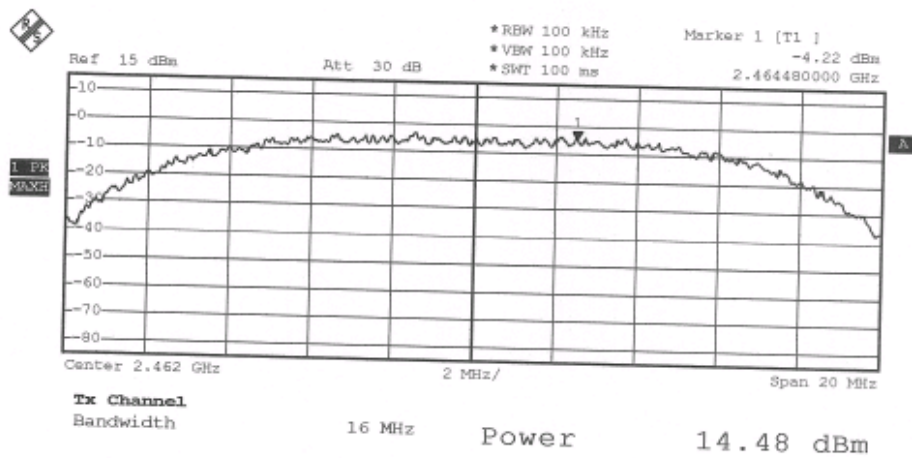



Spectrum Research & Testing Lab., Inc.
No. 101-10, Ling 8,
Shan-Tong Li, Chung-Li
City, Taoyuan, Taiwan

TEST REPORT

Reference No.: C006032406
Report No.: FCCC05121206-02
FCC ID: I4L-MS6833B-M
Page: 58 of 96
Date: APR. 09, 2006

Temperature:	23°C	Humidity:	60%RH
Spectrum Detector:	PK.	Tested Mode:	IEEE 802.11g
Tested By:	Nick Hsieh	Modulation Type:	OFDM
Tested Date:	Dec. 27, 2005	Antenna Type:	DIPOLE

CHANNEL NUMBER	CHANNEL FREQUENCY (MHz)	PEAK POWER OUTPUT (dBm)
1	2412	11.71
6	2437	11.41
11	2462	11.47

CH1:

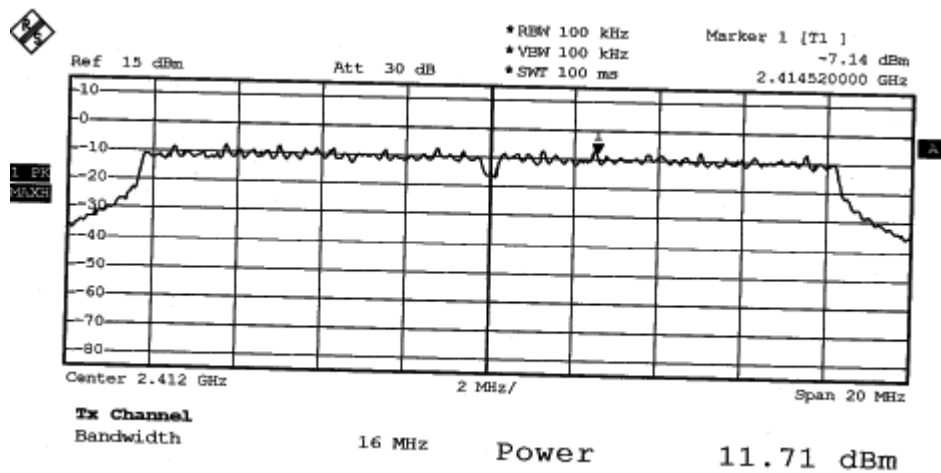



CH6

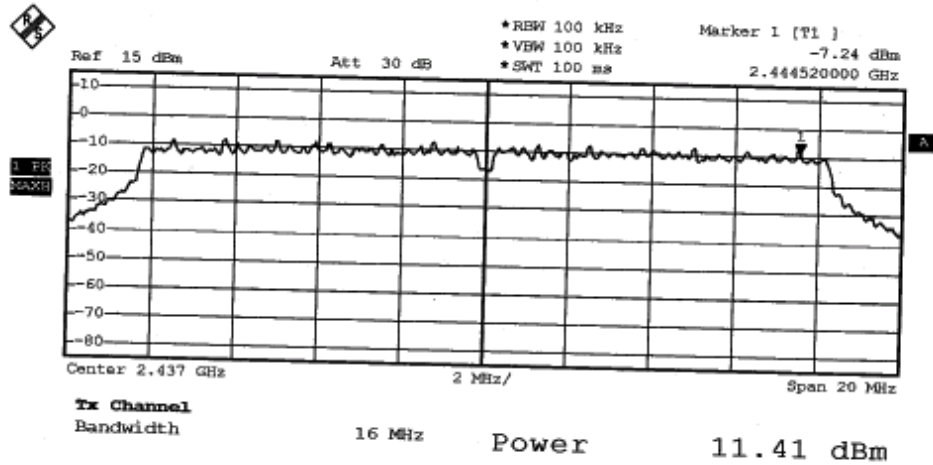

CH11

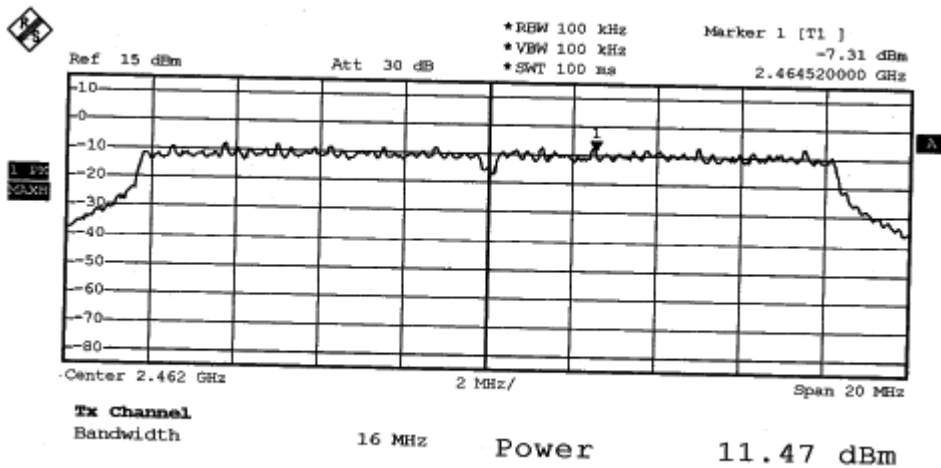



Spectrum Research & Testing Lab., Inc.
 No. 101-10, Ling 8,
 Shan-Tong Li, Chung-Li
 City, Taoyuan, Taiwan

TEST REPORT

Reference No.: C006032406
 Report No.: FCC05121206-02
 FCC ID: I4L-MS6833B-M
 Page: 60 of 96
 Date: APR. 09, 2006

Temperature:	<u>23°C</u>	Humidity:	<u>60%RH</u>
Spectrum Detector:	<u>PK.</u>	Tested Mode:	<u>IEEE 802.11b</u>
Tested By:	<u>Nick Hsieh</u>	Modulation Type:	<u>CCK</u>
Tested Date:	<u>Dec. 27, 2005</u>	Antenna Type:	<u>DIPOLE</u>

CHANNEL NUMBER	CHANNEL FREQUENCY (MHz)	PEAK POWER OUTPUT (dBm)
1	2412	16.54
6	2437	15.01
11	2462	16.10

CH1:

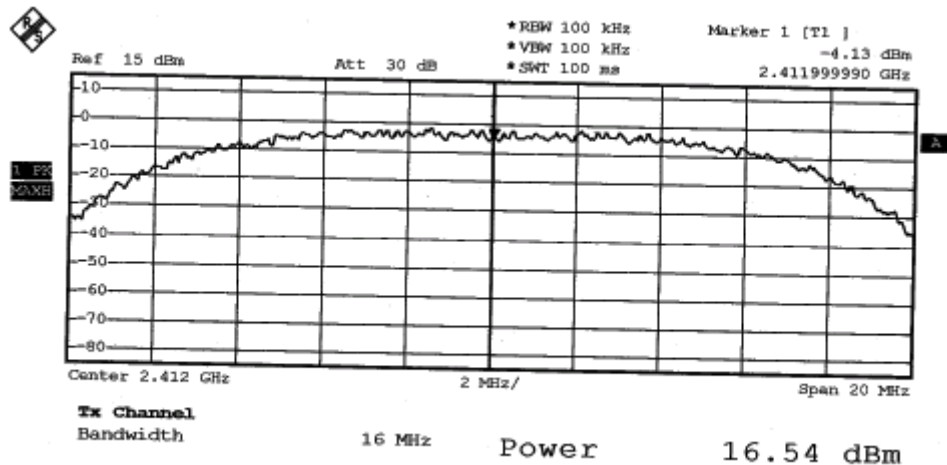



CH6

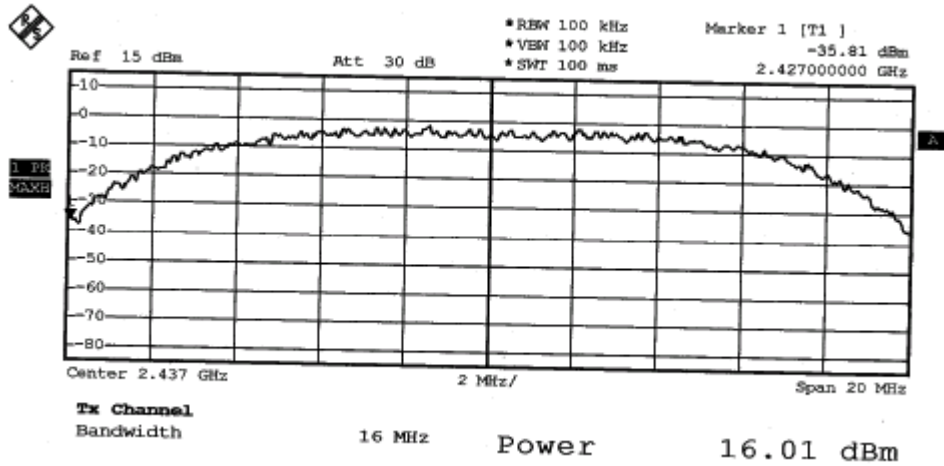

CH11

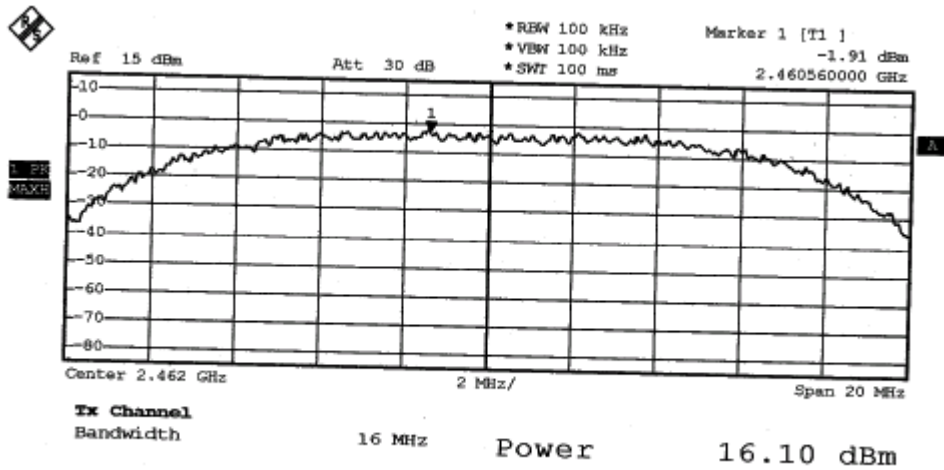



4.5 BAND EDGE TEST

4.5.1 LIMIT

FCC Part15, Subpart C Section 15.247. In any 100 kHz bandwidth outside the frequency band in which the spread spectrum intentional radiator is operating, the radio frequency power that is produced by the intentional radiator shall be at least 20 dB below that in the 100 kHz bandwidth within the band that contains the highest level of the desired power, based on either an RF conducted or a radiated measurement. Attenuation below the general limits specified in Section 15.209(a) is not required. In addition, radiated emissions which fall in the restricted bands, as defined in Section 15.205(a), must also comply with the radiated emission limits specified in Section 15.209(a) (see Section 15.205(c)).

OPERATING FREQUENCY RANGE (MHz)	SPURIOUS EMISSION FREQUENCY (MHz)	LIMIT	
		Peak power ration to emission(dBc)	Emission level(dBuV/m)
902 - 928	<902	>20	NA
	>928	>20	NA
	960-1240	NA	54
2400 - 2483.5	<2400	>20	NA
	>2483.5-2500	NA	54
5725 - 5850	<5350-5460	NA	54
	<5725	>20	NA
	>5850	>20	NA

4.5.2 TEST EQUIPMENT

The following test equipment was used during the test:

EQUIPMENT/FACILITIES	SPECIFICATIONS	MANUFACTURER	MODEL#/SERIAL#	DUE DATE OF CAL. & CAL. CENTER
SPECTRUM	9kHz-7GHz	ROHDE & SCHWARZ	FSP7/ 839511/010	APR. 2006 R&S
SPECTRUM	9KHz-26.5GHz	HP	8953E/ 3710A03220	MAY 2006 ETC
PRE-AMPLIFIER	1GHz-26.5GHz Gain:30dB(typ.)	HP	8449B/ 3008A01019	NOV. 2006 ETC
HORN ANTENNA	1GHz to 18GHz	EMCO	3115/ 9602-4681	DEC. 2006 ETC
OATS	3 - 10 M measurement	SRT	SRT-1	APR. 2006 SRT

NOTE: The calibration interval of the above test equipment is one year and the calibrations are traceable to NML/ROC and NIST/USA.



4.5.3 TEST SET-UP

FOR RF CONDUCTED TEST (dBc)

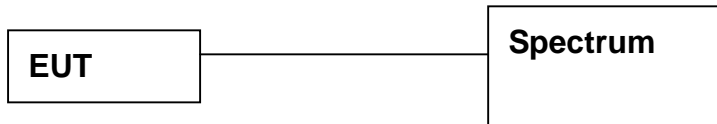

The EUT was connected to a spectrum through a 50Ω RF cable.

FOR RADIATED EMISSION TEST

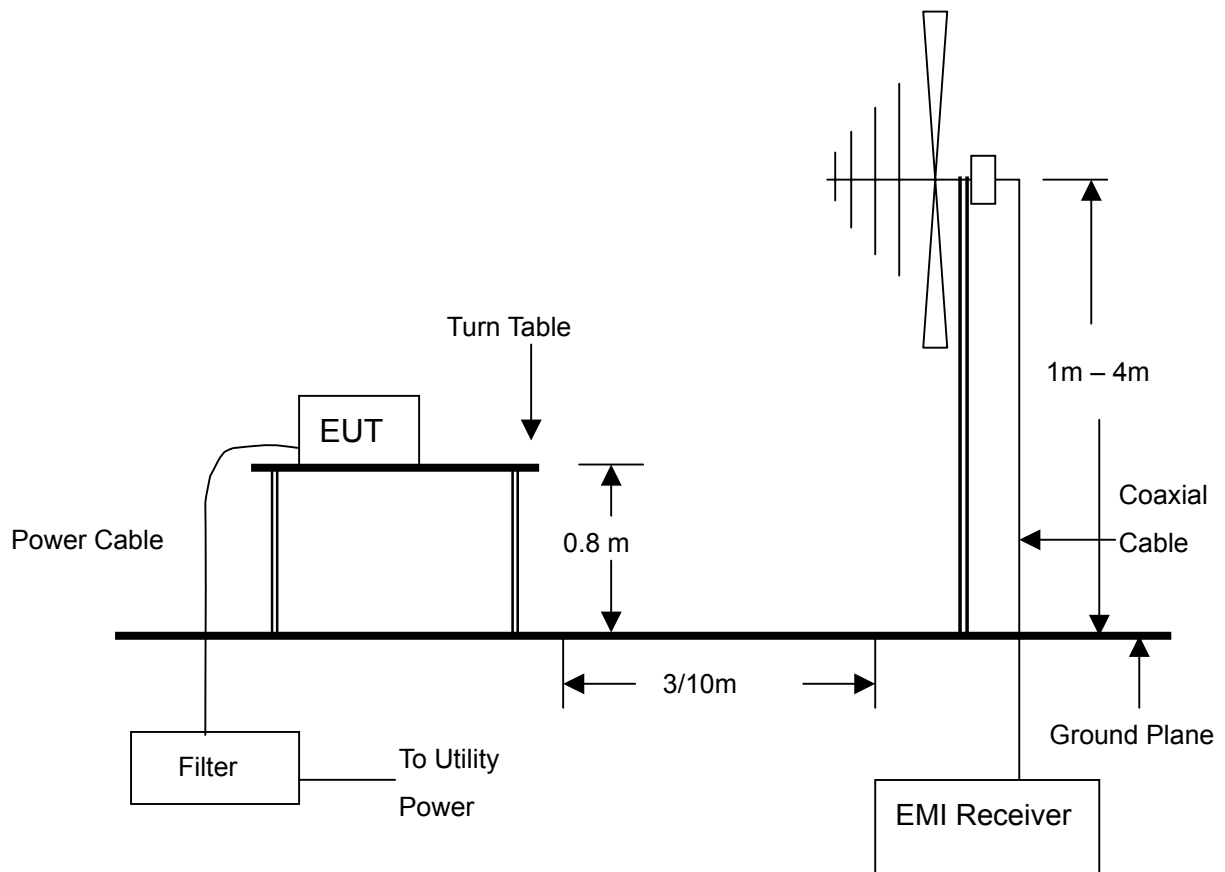

NOTE :

1. The EUT system was put on a wooden table with 0.8m heights above a ground plane.
2. For the actual test configuration, please refer to the photos of testing.



4.5.4 TEST PROCEDURE

1. The EUT was operating in transmitter mode and could be controlled its channel.
Printed out the test result from the spectrum by hard copy function.
2. The EUT was tested according to the requirement of ANSI C63.4 and CISPR 22.
The measurements were made at an open area test site with 10 meter measurement distance under 1 GHz and with 3m distance above 1GHz. The frequency spectrum measured started from 30 MHz. Under 1 GHz. All readings were quasi-peak values with 120 kHz resolution bandwidth of the test receiver. Above 1 GHz, the measurements were made at an open area test site with 3 meter measurement distance and all readings were peak and average values with 1 MHz resolution bandwidth of the test receiver. The EUT system was operated in all typical methods by users. The cables connected to EUT and support units were moved to find the maximum emission levels for each frequency.

4.5.5 EUT OPERATING CONDITION

Same as section 4.1.5 of this report.



Spectrum Research & Testing Lab., Inc.
 No. 101-10, Ling 8,
 Shan-Tong Li, Chung-Li
 City, Taoyuan, Taiwan

TEST REPORT

Reference No.: C006032406
 Report No.: FCCC05121206-02
 FCC ID: I4L-MS6833B-M
 Page: 65 of 96
 Date: APR. 09, 2006

4.5.6 TEST RESULT

Temperature:	<u>27°C</u>	Humidity:	<u>56%RH</u>
Spectrum Detector:	<u>PK. & AV.</u>	Tested Mode:	<u>IEEE 802.11g</u>
Tested By:	<u>Nick Hsieh</u>	Modulation Type:	<u>OFDM</u>
Tested Date:	<u>Dec. 27, 2005</u>	Antenna Type:	<u>PIFA</u>

1. Conducted test

Frequency (MHz)	PEAK POWER OUTPUT (dBm)	Emission read Value(dBm)	Result of Band edge (dBc)	Band edge LIMIT (dBc)
<2400	3.19	-31.22	34.41	>20dBc
>2483.5	6.20	-34.58	40.78	>20dBc

2. Radiated emission test

Frequency (MHz)	Antenna polarization (H/V)	Reading (dBuV)		Emission (dBuV/m)		Band edge Limit (dBuV/m)	
		PK	AV	PK	AV	PK	AV
<2400	V	62.7	44.3	58.4	40.0	74.0	54.0
>2483.5	V	60.8	45.4	56.8	41.4	74.0	54.0



CH1

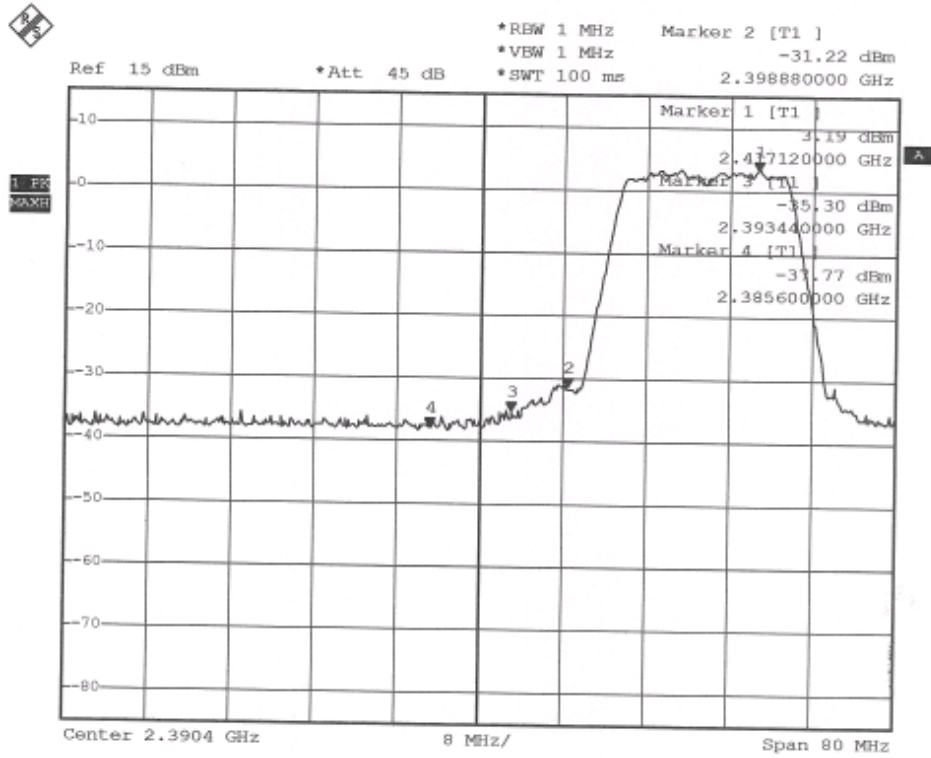

CH11

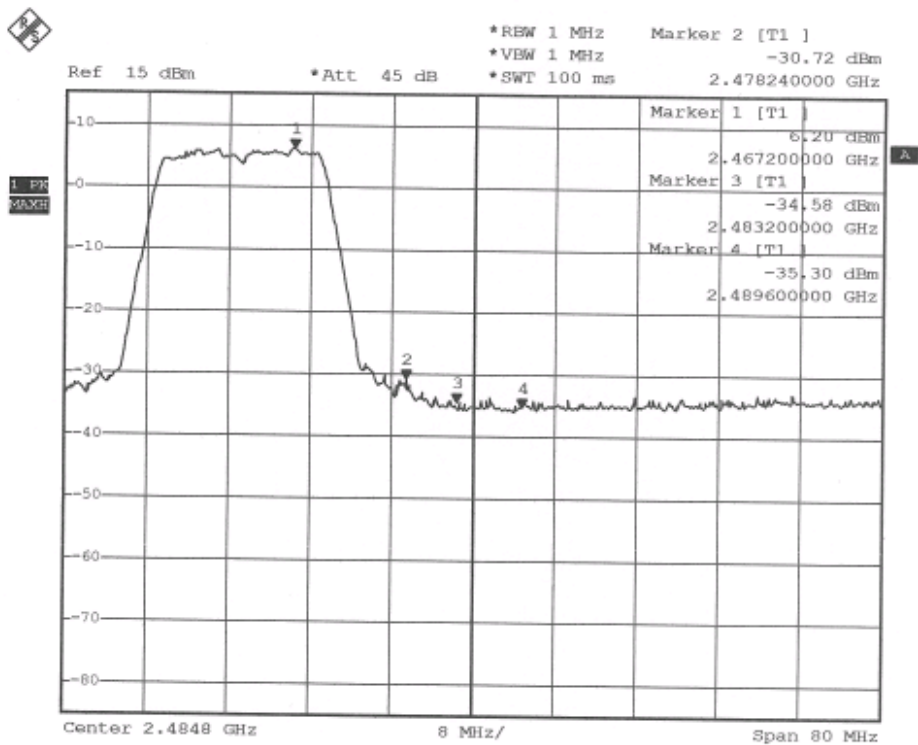



Spectrum Research & Testing Lab., Inc.
No. 101-10, Ling 8,
Shan-Tong Li, Chung-Li
City, Taoyuan, Taiwan

TEST REPORT

Reference No.: C006032406
Report No.: FCCC05121206-02
FCC ID: I4L-MS6833B-M
Page:67 of 96
Date: APR. 09, 2006

Temperature:	<u>27C</u>	Humidity:	<u>56%RH</u>
Spectrum Detector:	<u>PK. & AV.</u>	Tested Mode:	<u>IEEE 802.11b</u>
Tested By:	<u>Nick Hsieh</u>	Modulation Type:	<u>CCK</u>
Tested Date:	<u>Dec. 27, 2005</u>	Antenna Type:	<u>PIFA</u>

1. Conducted test

Frequency (MHz)	PEAK POWER OUTPUT (dBm)	Emission read Value(dBm)	Result of Band edge (dBc)	Band edge LIMIT (dBc)
<2400	6.16	-27.50	33.66	>20dBc
>2483.5	9.07	-34.34	43.41	>20dBc

2. Radiated emission test

Frequency (MHz)	Antenna polarization (H/V)	Reading (dBuV)		Emission (dBuV/m)		Band edge Limit (dBuV/m)	
		PK	AV	PK	AV	PK	AV
<2400	V	61.7	45.3	57.3	40.9	74.0	54.0
>2483.5	V	65.7	50.4	61.7	46.4	74.0	54.0



CH1

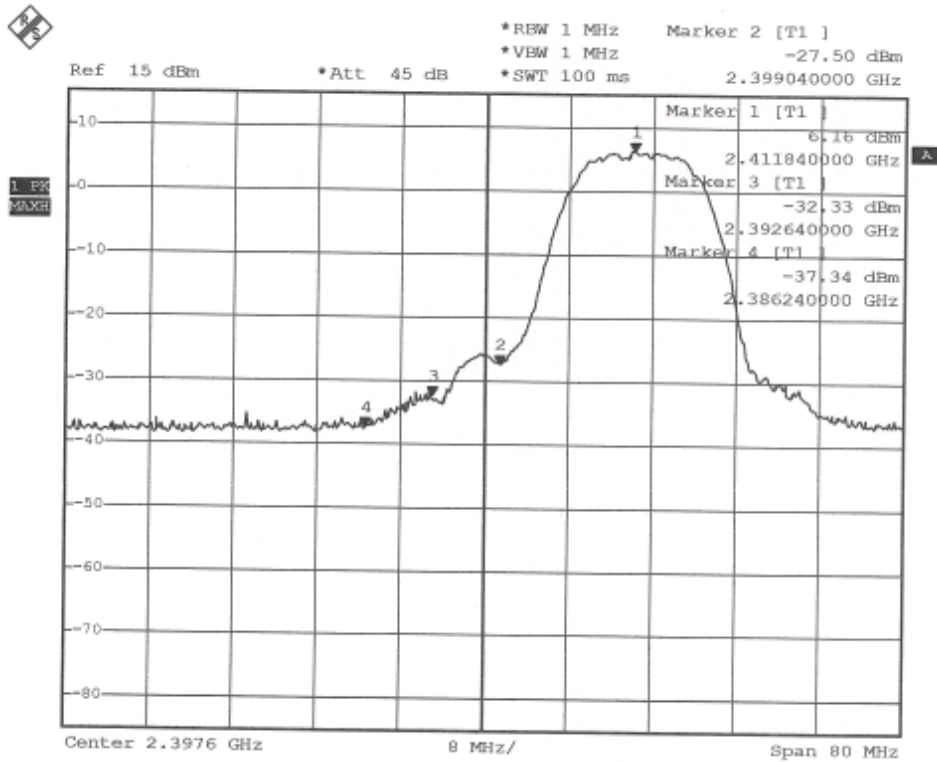

CH11

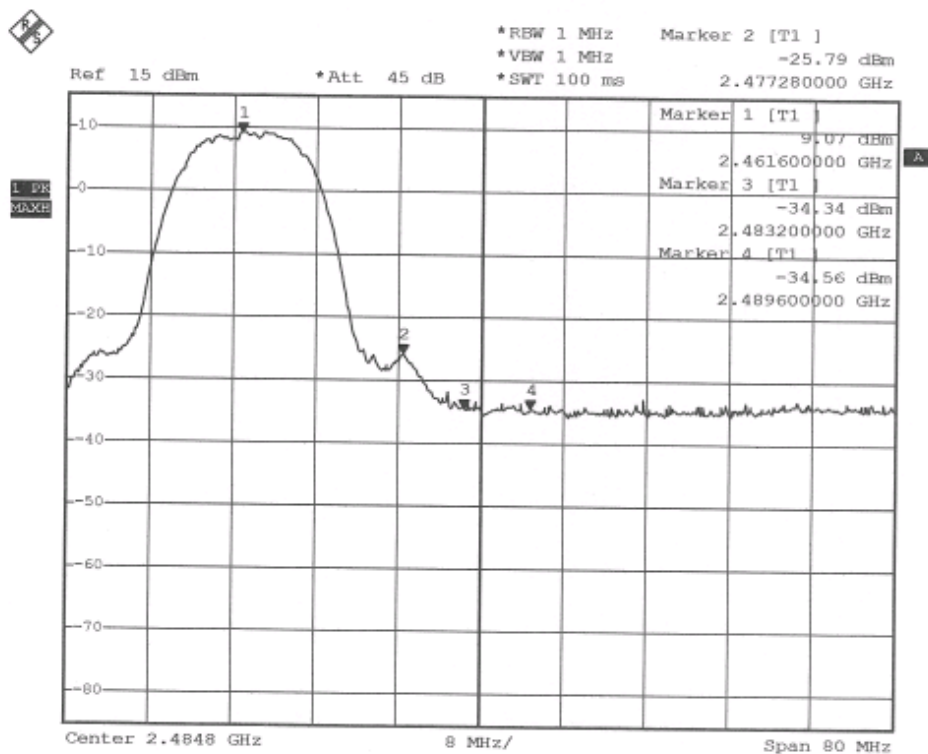



Spectrum Research & Testing Lab., Inc.
 No. 101-10, Ling 8,
 Shan-Tong Li, Chung-Li
 City, Taoyuan, Taiwan

TEST REPORT

Reference No.: C006032406
 Report No.: FCCC05121206-02
 FCC ID: I4L-MS6833B-M
 Page: 69 of 96
 Date: APR. 09, 2006

Temperature:	<u>27°C</u>	Humidity:	<u>56%RH</u>
Spectrum Detector:	<u>PK. & AV.</u>	Tested Mode:	<u>IEEE 802.11g</u>
Tested By:	<u>Nick Hsieh</u>	Modulation Type:	<u>OFDM</u>
Tested Date:	<u>Dec. 26, 2005</u>	Antenna Type:	<u>DIPOLE</u>

1. Conducted test

Frequency (MHz)	PEAK POWER OUTPUT (dBm)	Emission read Value(dBm)	Result of Band edge (dBc)	Band edge LIMIT (dBc)
<2400	7.58	-29.32	36.90	>20dBc
>2483.5	10.92	-20.84	31.76	>20dBc

2. Radiated emission test

Frequency (MHz)	Antenna polarization (H/V)	Reading (dBuV)		Emission (dBuV/m)		Band edge Limit (dBuV/m)	
		PK	AV	PK	AV	PK	AV
<2400	V	63.2	45.7	59.0	41.5	74.0	54.0
>2483.5	V	62.2	43.6	58.8	39.6	74.0	54.0



CH1

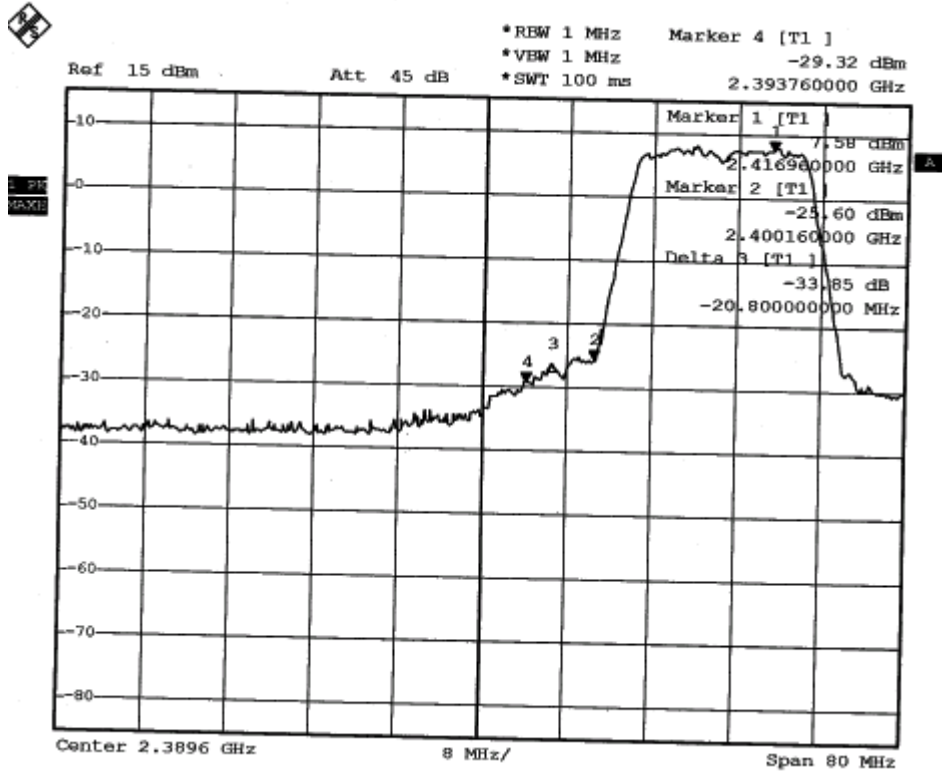

CH11

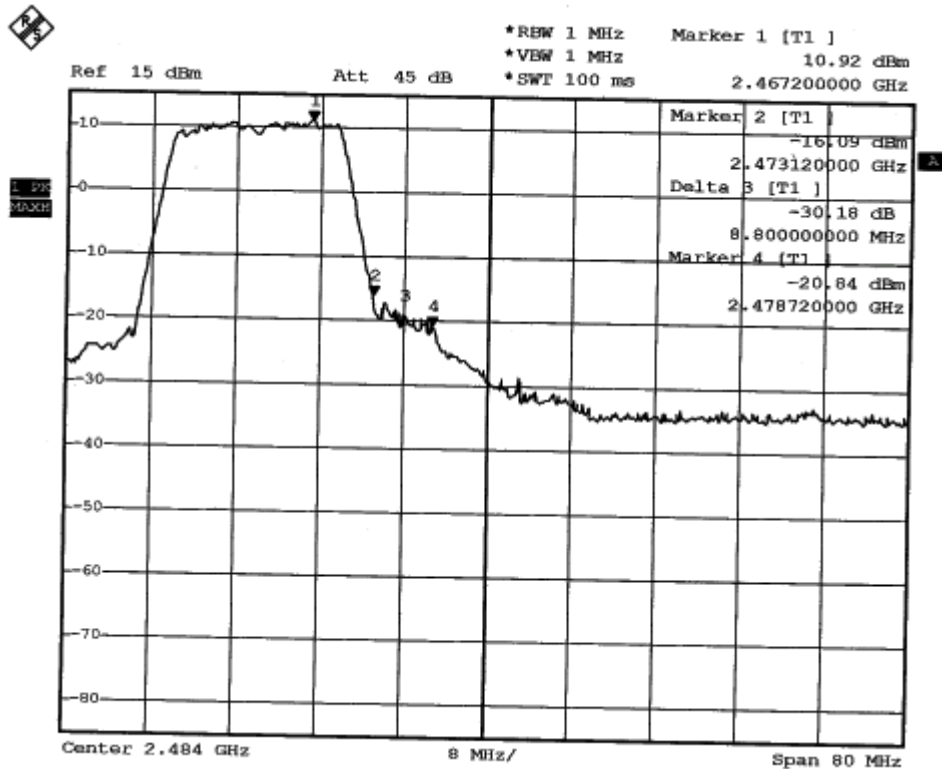



Spectrum Research & Testing Lab., Inc.
 No. 101-10, Ling 8,
 Shan-Tong Li, Chung-Li
 City, Taoyuan, Taiwan

TEST REPORT

Reference No.: C006032406
 Report No.: FCCC05121206-02
 FCC ID: I4L-MS6833B-M
 Page: 71 of 96
 Date: APR. 09, 2006

Temperature:	<u>27C</u>	Humidity:	<u>56%RH</u>
Spectrum Detector:	<u>PK. & AV.</u>	Tested Mode:	<u>IEEE 802.11b</u>
Tested By:	<u>Nick Hsieh</u>	Modulation Type:	<u>CCK</u>
Tested Date:	<u>Dec. 26, 2005</u>	Antenna Type:	<u>DIPOLE</u>

1. Conducted test

Frequency (MHz)	PEAK POWER OUTPUT (dBm)	Emission read Value(dBm)	Result of Band edge (dBc)	Band edge LIMIT (dBc)
<2400	10.63	-26.94	37.57	>20dBc
>2483.5	13.48	-30.60	44.08	>20dBc

2. Radiated emission test

Frequency (MHz)	Antenna polarization (H/V)	Reading (dBuV)		Emission (dBuV/m)		Band edge Limit (dBuV/m)	
		PK	AV	PK	AV	PK	AV
<2400	V	60.4	43.1	56.2	38.9	74.0	54.0
>2483.5	V	61.6	45.9	57.6	41.9	74.0	54.0



CH1

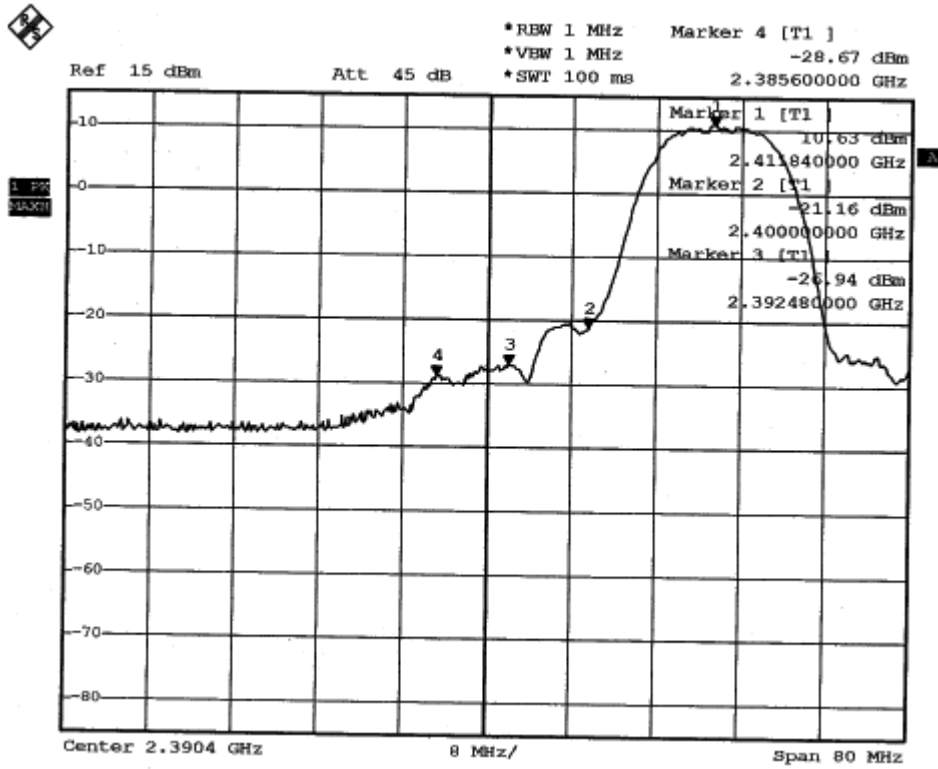

CH11

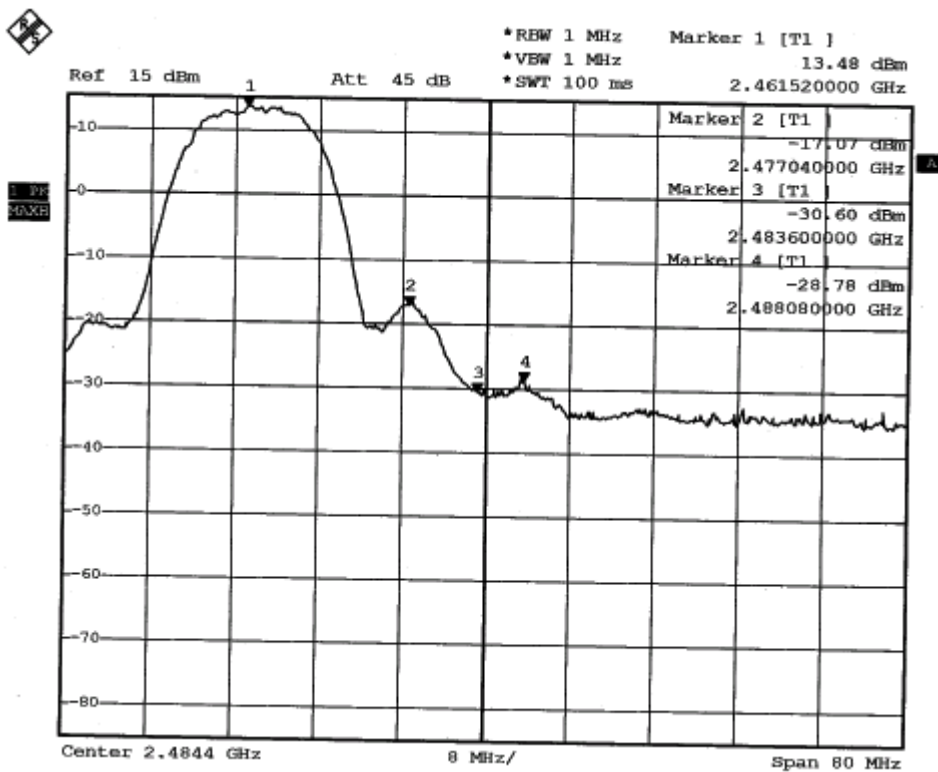



Spectrum Research & Testing Lab., Inc.
 No. 101-10, Ling 8,
 Shan-Tong Li, Chung-Li
 City, Taoyuan, Taiwan

TEST REPORT

Reference No.: C006032406
 Report No.: FCCC05121206-02
 FCC ID: I4L-MS6833B-M
 Page: 73 of 96
 Date: APR. 09, 2006

4.6 POWER DENSITY TEST

4.6.1 LIMIT

FCC Part15, Subpart C Section 15.247

FREQUENCY RANGE (MHz)	Limit(dBm/kHz)
902-928	8dBm/3kHz
2400-2483.5	
5725-5850	

4.6.2 TEST EQUIPMENT

The following test equipment was used during the radiated emission test:

EQUIPMENT/FACILITIES	SPECIFICATIONS	MANUFACTURER	MODEL#/SERIAL#	DUE DATE OF CAL. & CAL. CENTER
SPECTRUM	9kHz-7GHz	ROHDE & SCHWARZ	FSP7/ 839511/010	APR. 2006 R&S

NOTE: The calibration interval of the above test equipment is one year and the calibrations are traceable to NML/ROC and NIST/USA.

4.6.3 TEST SET-UP

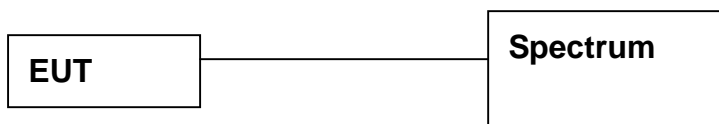

The EUT was connected to a spectrum through a 50Ω RF cable.

4.6.4 TEST PROCEDURE

The EUT was operating in transmitter mode and could be controlled its channel. Printed out the test result from the spectrum by hard copy function.

4.6.5 EUT OPERATING CONDITION

Same as section 4.1.5 of this report.



Spectrum Research & Testing Lab., Inc.
No. 101-10, Ling 8,
Shan-Tong Li, Chung-Li
City, Taoyuan, Taiwan

TEST REPORT

Reference No.: C006032406
Report No.: FCC05121206-02
FCC ID: I4L-MS6833B-M
Page: 74 of 96
Date: APR. 09, 2006

4.6.6 TEST RESULT

Temperature:	23°C	Humidity:	60%RH
Spectrum Detector:	PK.	Tested Mode:	IEEE 802.11g
Tested By:	Nick Hsieh	Modulation Type:	OFDM
Tested Date:	Dec. 27, 2005	Antenna Type:	PIFA

CHANNEL NUMBER	CHANNEL FREQUENCY (MHz)	RF POWER LEVEL IN 3kHz BW (dBm/3kHz)	MAXIMUM LIMIT (dBm/3kHz)
1	2412	-24.79	8
6	2437	-23.72	8
11	2462	-22.05	8

CH 1:

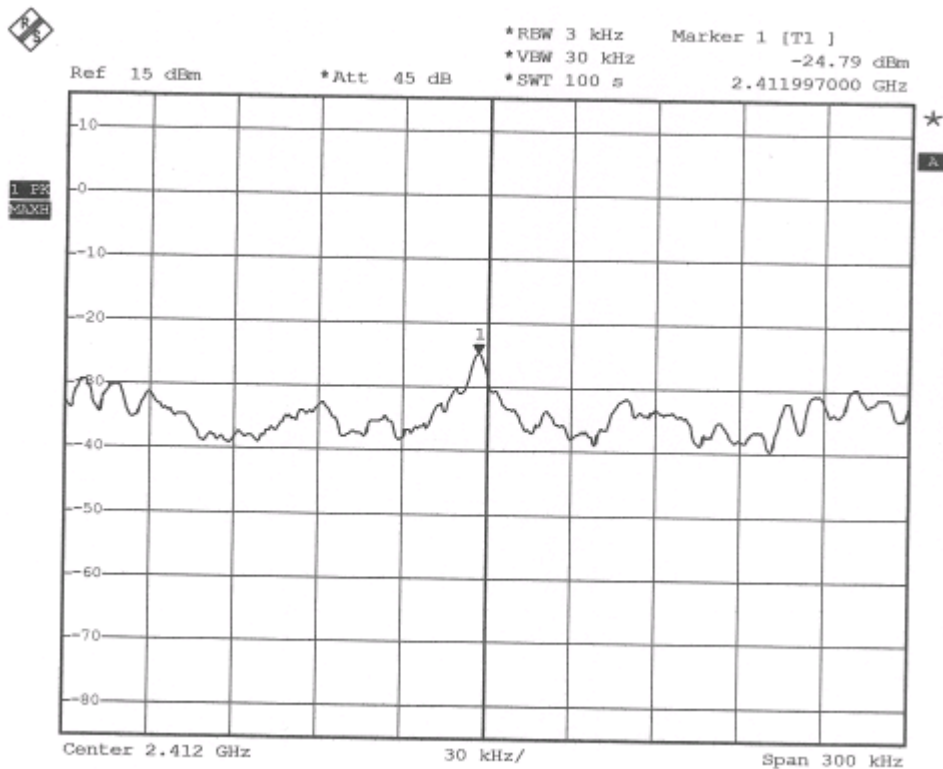



CH 6:

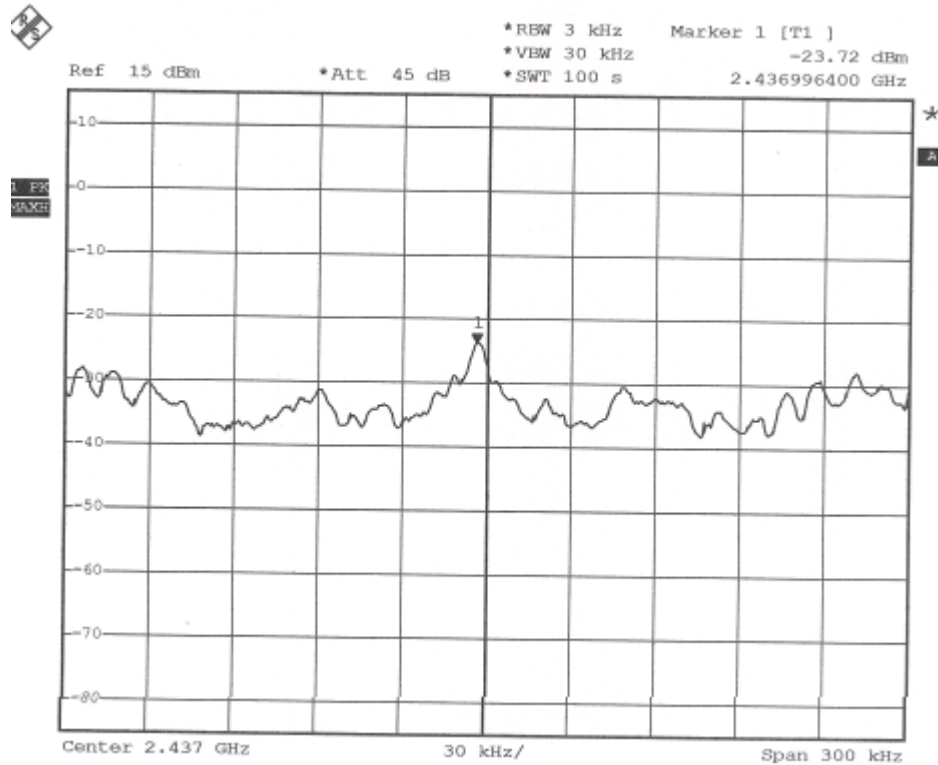

CH 11:

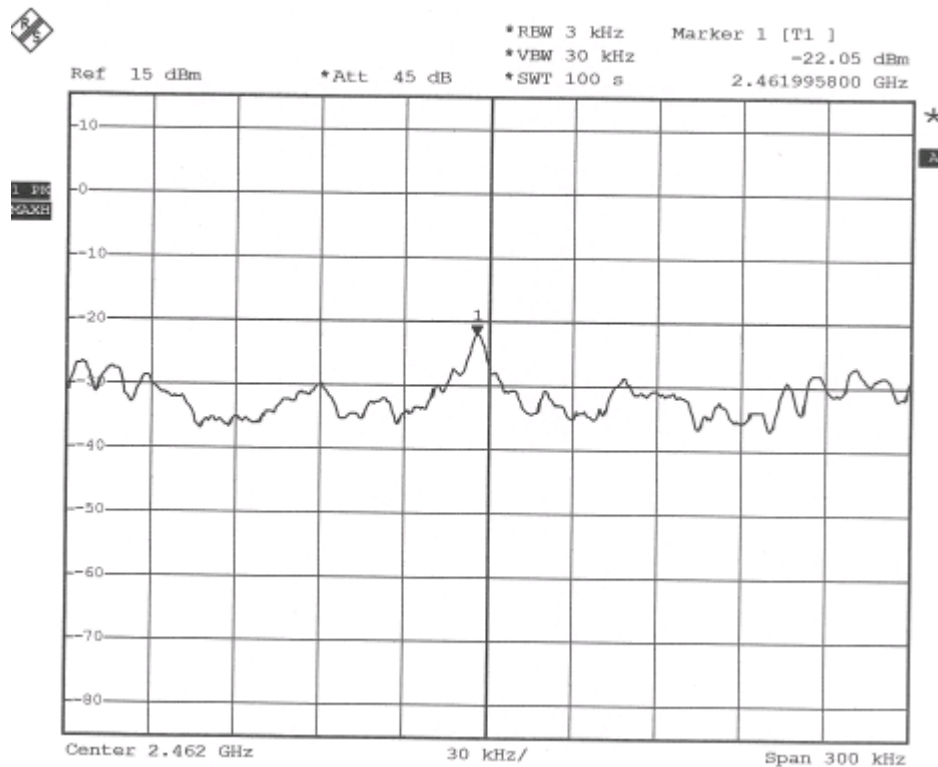



Spectrum Research & Testing Lab., Inc.
No. 101-10, Ling 8,
Shan-Tong Li, Chung-Li
City, Taoyuan, Taiwan

TEST REPORT

Reference No.: C006032406
Report No.: FCC05121206-02
FCC ID: I4L-MS6833B-M
Page: 76 of 96
Date: APR. 09, 2006

Temperature:	23°C	Humidity:	60%RH
Spectrum Detector:	PK.	Tested Mode:	IEEE 802.11b
Tested By:	Nick Hsieh	Modulation Type:	CCK
Tested Date:	Dec. 27, 2005	Antenna Type:	PIFA

CHANNEL NUMBER	CHANNEL FREQUENCY (MHz)	RF POWER LEVEL IN 3kHz BW (dBm/3kHz)	MAXIMUM LIMIT (dBm/3kHz)
1	2412	-17.39	8
6	2437	-16.16	8
11	2462	-14.63	8

CH 1:

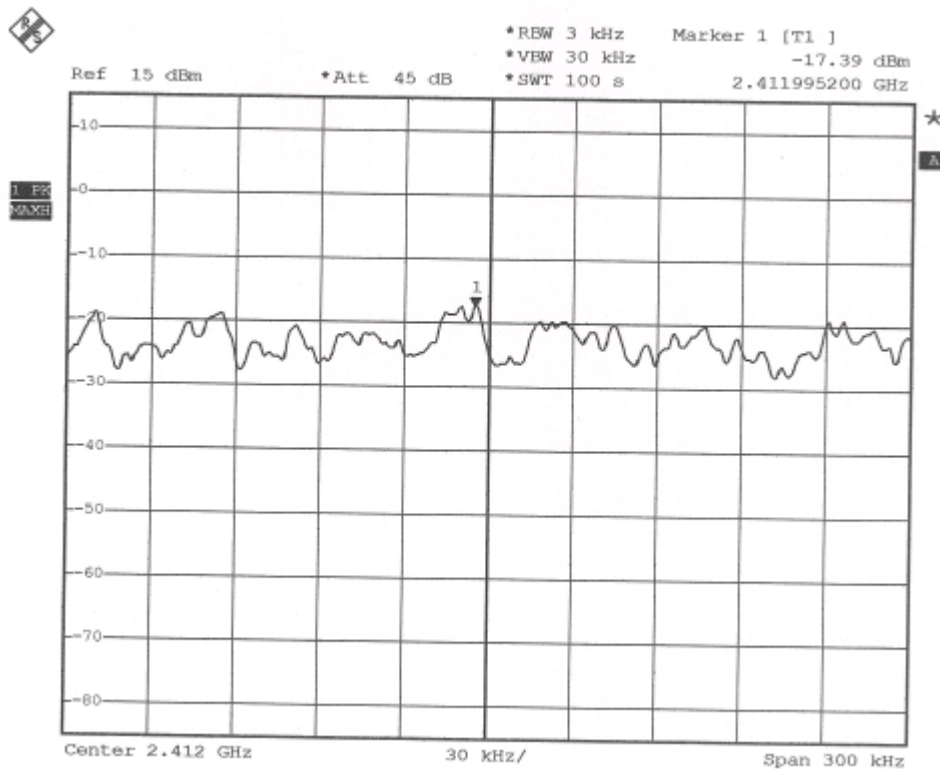



CH 6:

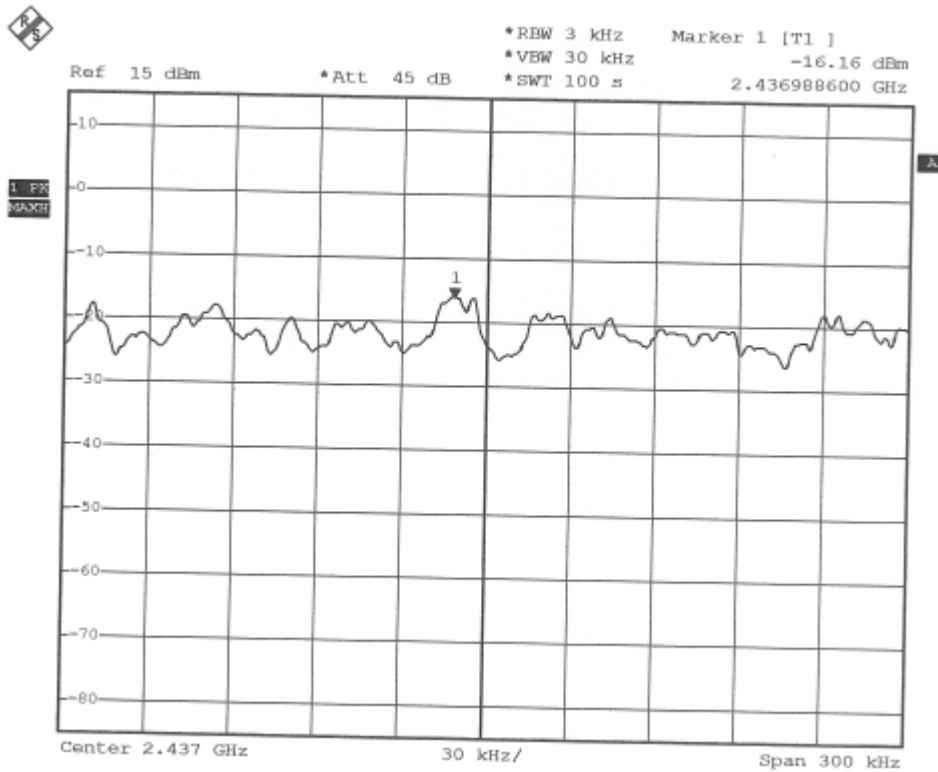

CH 11:

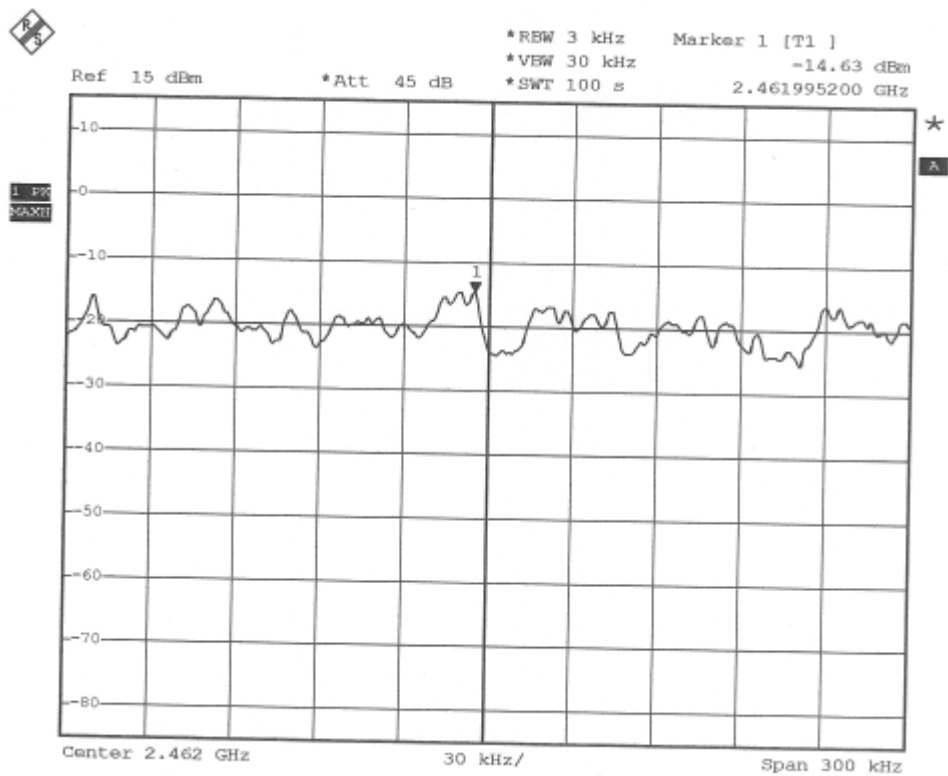



Spectrum Research & Testing Lab., Inc.
 No. 101-10, Ling 8,
 Shan-Tong Li, Chung-Li
 City, Taoyuan, Taiwan

TEST REPORT

Reference No.: C006032406
 Report No.: FCCC05121206-02
 FCC ID: I4L-MS6833B-M
 Page: 78 of 96
 Date: APR. 09, 2006

Temperature:	<u>23°C</u>	Humidity:	<u>60%RH</u>
Spectrum Detector:	<u>PK.</u>	Tested Mode:	<u>IEEE 802.11g</u>
Tested By:	<u>Nick Hsieh</u>	Modulation Type:	<u>OFDM</u>
Tested Date:	<u>Dec. 26, 2005</u>	Antenna Type:	<u>DIPOLE</u>

CHANNEL NUMBER	CHANNEL FREQUENCY (MHz)	RF POWER LEVEL IN 3kHz BW (dBm/3kHz)	MAXIMUM LIMIT (dBm/3kHz)
1	2412	-24.79	8
6	2437	-23.72	8
11	2462	-22.05	8

CH 1:

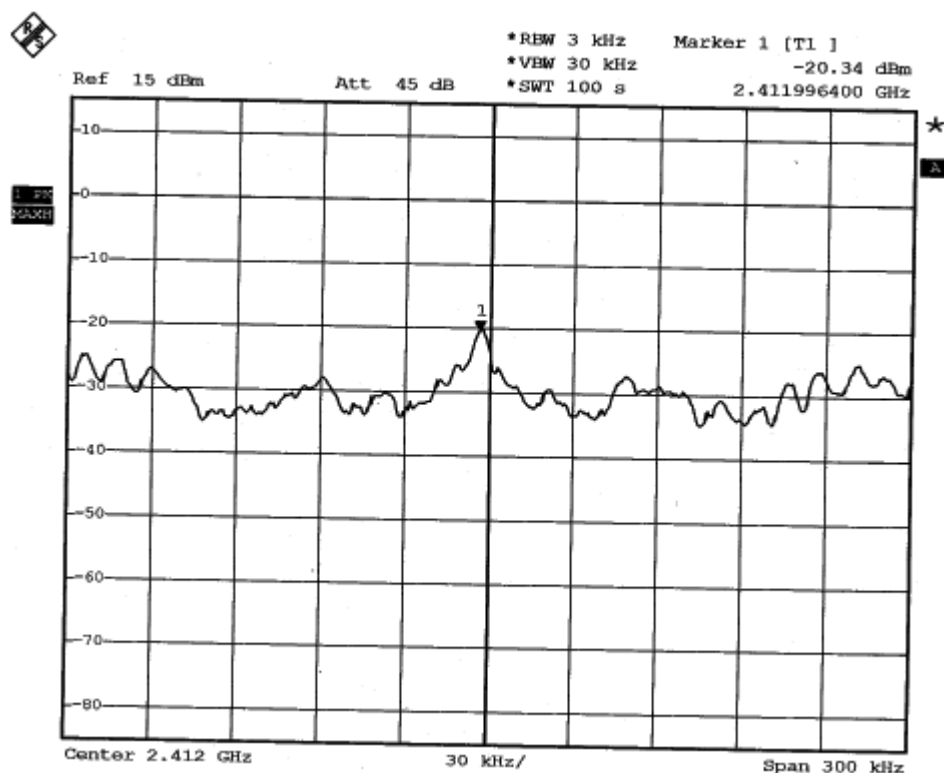



CH 6:

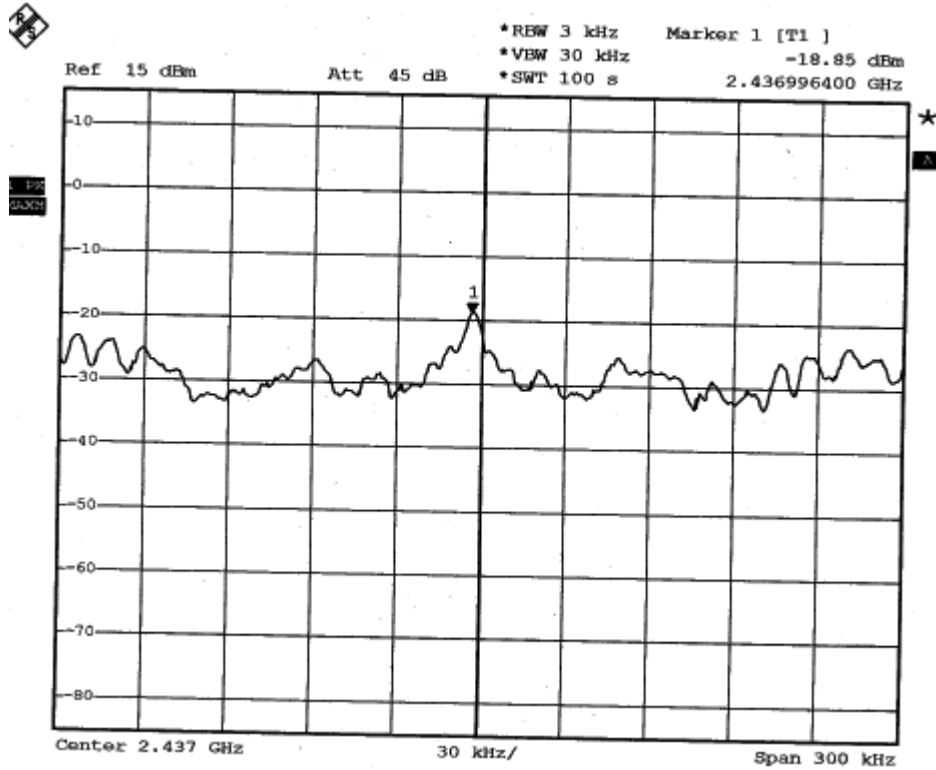

CH 11:

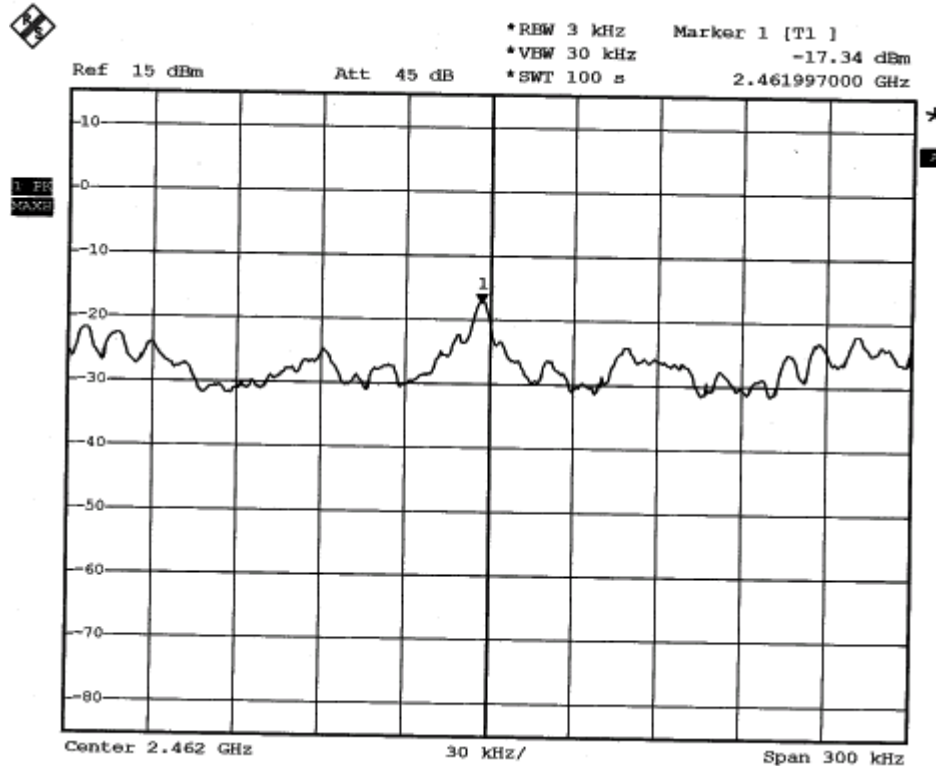



Spectrum Research & Testing Lab., Inc.
No. 101-10, Ling 8,
Shan-Tong Li, Chung-Li
City, Taoyuan, Taiwan

TEST REPORT

Reference No.: C006032406
Report No.: FCCC05121206-02
FCC ID: I4L-MS6833B-M
Page: 80 of 96
Date: APR. 09, 2006

Temperature:	23°C	Humidity:	60%RH
Spectrum Detector:	PK.	Tested Mode:	IEEE 802.11b
Tested By:	Nick Hsieh	Modulation Type:	CCK
Tested Date:	Dec. 26, 2005	Antenna Type:	DIPOLE

CHANNEL NUMBER	CHANNEL FREQUENCY (MHz)	RF POWER LEVEL IN 3kHz BW (dBm/3kHz)	MAXIMUM LIMIT (dBm/3kHz)
1	2412	-17.39	8
6	2437	-16.16	8
11	2462	-14.63	8

CH 1:

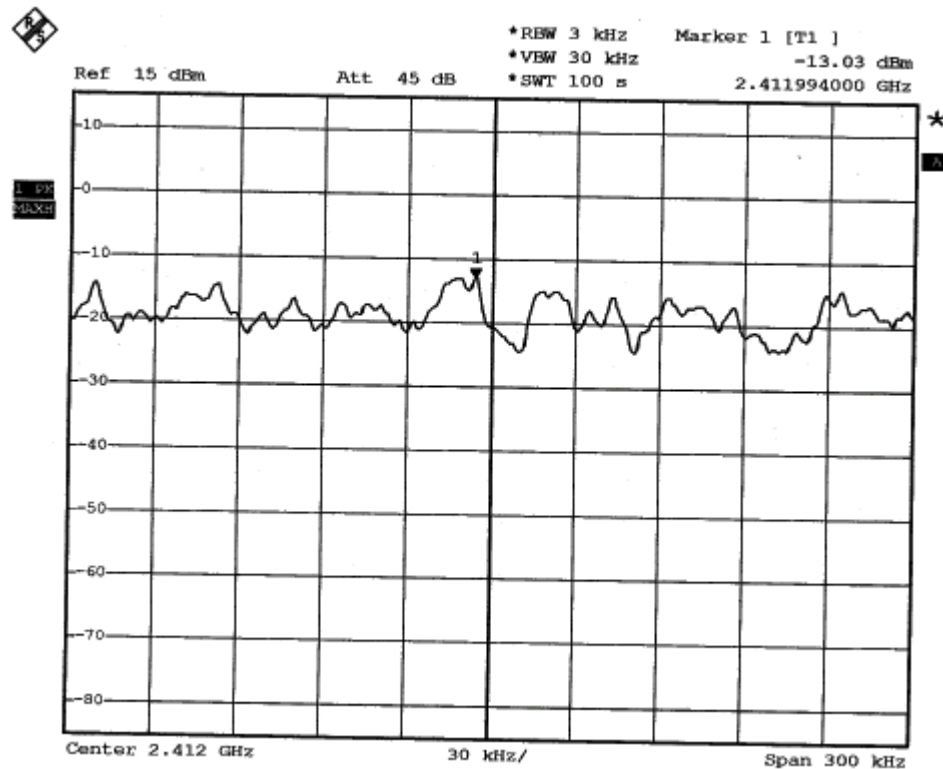



Spectrum Research & Testing Lab., Inc.
No. 101-10, Ling 8,
Shan-Tong Li, Chung-Li
City, Taoyuan, Taiwan

TEST REPORT

Reference No.: C006032406
Report No.: FCC05121206-02
FCC ID: I4L-MS6833B-M
Page: 81 of 96
Date: APR. 09, 2006

CH 6:

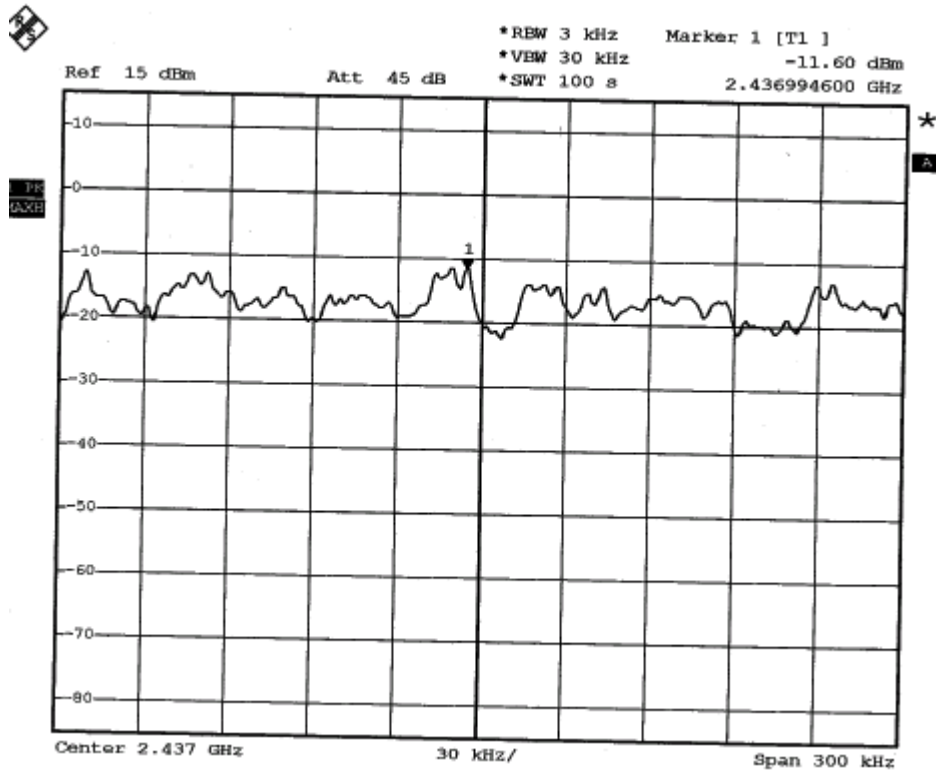

CH 11:

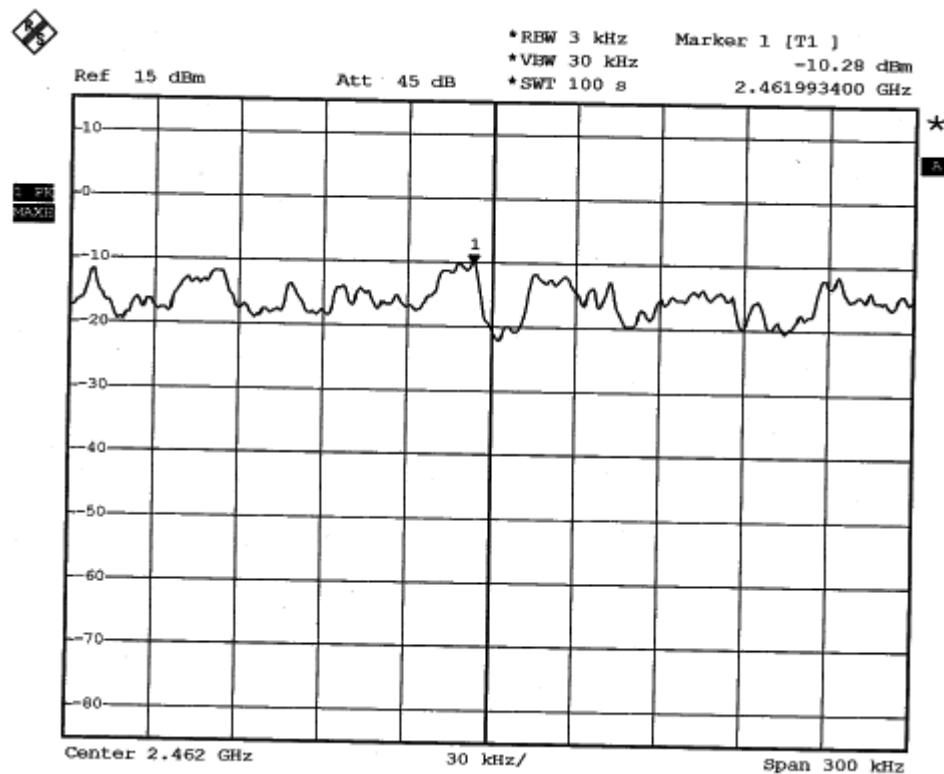



4.7 RF POWER EXPOSURE EVALUATION TEST

4.7.1 LIMIT

According to the requirement of IEEE C95.1 and FCC OET Bulletin 65.

Limits for Occupational/Controlled Exposure

Frequency Range (MHz)	Electric Field Strength(E) (V/m)	Magnetic Field Strength(H) (A/m)	Power density (S) (mW/cm ²)	Averaging Time E ² , H ² or S (minutes)
0.3-3.0	614	1.63	(100)*	6
3.0-30	1842/f	4.89/f	(900/f ²)*	6
30-300	61.4	0.163	1.0	6
300-1500	--	--	f/300	6
1500-100,000	--	--	5	6

Limits for General Population/Uncontrolled Exposure

Frequency Range (MHz)	Electric Field Strength(E) (V/m)	Magnetic Field Strength(H) (A/m)	Power density (S) (mW/cm ²)	Averaging Time E ² , H ² or S (minutes)
0.3-1.34	614	1.63	(100)*	30
1.34-30	824/f	2.19/f	(180/f ²)*	30
30-300	27.5	0.073	0.2	30
300-1500	--	--	f/1500	30
1500-100,000	--	--	1.0	30

f = frequency in MHz *Plane-wave equivalent power density

NOTE 1: Occupational/controlled limits apply in situations in which persons are exposed as a consequence of their employment provided those persons are fully aware of the potential for exposure and can exercise control over their exposure. Limits for occupational/controlled exposure also apply in situations when an individual is transient through a location where occupational/controlled limits apply provided he or she is made aware of the potential for exposure.

NOTE 2: General population/uncontrolled exposures apply in situations in which the general public may be exposed, or in which persons that are exposed as a consequence of their employment may not be fully aware of the potential for exposure or cannot exercise control over their exposure.



Spectrum Research & Testing Lab., Inc.
No. 101-10, Ling 8,
Shan-Tong Li, Chung-Li
City, Taoyuan, Taiwan

TEST REPORT

Reference No.: C006032406
Report No.: FCCC05121206-02
FCC ID: I4L-MS6833B-M
Page: 83 of 96
Date: APR. 09, 2006

4.7.2 TEST EQUIPMENT

The following test equipment was used during the test:

EQUIPMENT/ FACILITIES	SPECIFICATIONS	MANUFACTURER	MODEL#/ SERIAL#	DUE DATE OF CAL. & CAL. CENTER
POWER METER	N/A	BOONTON	4232A/ 29001	MAY 2006 ETC
POWER SENSOR	DC-8GHz 50 Ω	BOONTON	51011EMC/ 31181	NOV. 2006 ETC

NOTE: The calibration interval of the above test equipment is one year and the calibrations are traceable to NML/ROC and NIST/USA.

4.7.3 TEST SET-UP

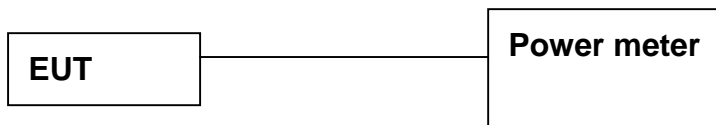

The EUT's antenna connector was connected to a power meter through a 50 Ω RF cable.



4.7.4 TEST PROCEDURE

1. The EUT was operating in transmitter mode and could be controlled its channel. The power meter read power value.
2. The EUT uses an sleeve dipole antenna and the antenna gain is 2dBi declared by manufacturer.
3. As discussed in OET Bulletin 65, calculations can be made to predict RF field strength and power density levels around typical RF sources. For example, in the case of a non-directional antenna, a prediction for power density in the far-field of the antenna can be made by use of the general Equations (1) or (2) below [for conversion to electric or magnetic field strength see Equation (3) above]. These equations are generally accurate in the far-field of an antenna but will over-predict power density in the near field, where it could be used for making a " worst case" or conservative prediction.

$$S = PG / 4 \pi R^2 \quad (\text{Eq. 1})$$

$$S = \text{connect power} / 4 \pi R^2 \quad (\text{Eq. 2})$$

$$S = E^2 / 3770 = 37.7 H^2 \quad (\text{Eq. 3})$$

where: S = power density (mW/cm²)

E = electric field strength (V/m)

H = magnetic field strength (A/m)

S = power density (in appropriate units, e.g. mW/cm²)

P = power input to the antenna (in appropriate units, e.g., mW)

G = power gain of the antenna in the direction of interest relative to an isotropic radiator (dBi)

R = distance to the center of radiation of the antenna (appropriate units, e.g., cm)

where: connect power = equivalent (or effective) isotropically radiated power.

4.7.5 EUT OPERATING CONDITION

Same as section 4.1.5 of this report.



4.7.6 CONNECT POWER AT THE ANTENNA CONNECTOR RESULT

Temperature: 23°C Humidity: 60%RH
Spectrum Detector: PK. Tested Mode: IEEE 802.11g
Tested By: Nick Hsieh Modulation Type: OFDM

CHANNEL NUMBER	CHANNEL FREQUENCY (MHz)	PEAK POWER OUTPUT (dBm)	POWER METER (dBm)	PEAK POWER LIMIT (dBm)
1	2412	9.85	9.71	30
6	2437	9.65	9.47	30
11	2462	9.70	9.56	30

Temperature: 23°C Humidity: 60%RH
Spectrum Detector: PK. Tested Mode: IEEE 802.11b
Tested By: Nick Hsieh Modulation Type: CCK
Antenna Type: PIFA

CHANNEL NUMBER	CHANNEL FREQUENCY (MHz)	PEAK POWER OUTPUT (dBm)	POWER METER (dBm)	PEAK POWER LIMIT (dBm)
1	2412	14.65	14.39	30
6	2437	14.20	14.04	30
11	2462	14.48	14.25	30

NOTE : The EUT uses a dipole antenna and the antenna gain is 0.5dBi (1.12 numeric)



Spectrum Research & Testing Lab., Inc.
No. 101-10, Ling 8,
Shan-Tong Li, Chung-Li
City, Taoyuan, Taiwan

TEST REPORT

Reference No.: C006032406
Report No.: FCCC05121206-02
FCC ID: I4L-MS6833B-M
Page:86 of 96
Date: APR. 09, 2006

Temperature: 23°C Humidity: 60%RH
Spectrum Detector: PK. Tested Mode: IEEE 802.11g
Tested By: Nick Hsieh Modulation Type: OFDM
Antenna Type: DIPOLE

CHANNEL NUMBER	CHANNEL FREQUENCY (MHz)	PEAK POWER OUTPUT (dBm)	POWER METER (dBm)	PEAK POWER LIMIT (dBm)
1	2412	11.71	11.51	30
6	2437	11.41	11.24	30
11	2462	11.47	11.22	30

Temperature: 23°C Humidity: 60%RH
Spectrum Detector: PK. Tested Mode: IEEE 802.11b
Tested By: Nick Hsieh Modulation Type: CCK
Antenna Type: DIPOLE

CHANNEL NUMBER	CHANNEL FREQUENCY (MHz)	PEAK POWER OUTPUT (dBm)	POWER METER (dBm)	PEAK POWER LIMIT (dBm)
1	2412	16.54	16.37	30
6	2437	16.01	15.84	30
11	2462	16.10	15.83	30

NOTE : The EUT uses a dipole antenna and the antenna gain is 0.5dBi (1.12 numeric)



**Spectrum Research &
Testing Lab., Inc.**
No. 101-10, Ling 8,
Shan-Tong Li, Chung-Li
City, Taoyuan, Taiwan

TEST REPORT

Reference No.: C006032406
Report No.: FCCC05121206-02
FCC ID: I4L-MS6833B-M
Page: 87 of 96
Date: APR. 09, 2006

5. Antenna application

5.1 Antenna requirement

The EUT's antenna is met the requirement of FCC part15C section15.203 and 15.204.

FCC part15C section15.247 requirement:

Systems operating in the 2400-2483.5 MHz band that are used exclusively for fixed, point-to-point operations may employ transmitting antennas with directional gain greater than 6 dBi provided the maximum peak output power of the intentional radiator is reduced by 1 dB for every 3 dB that the directional gain of the antenna exceeds 6 dBi.

5.2 Result

The EUT's antenna used an external dipole antenna. The type of connector is coaxial connector. The antenna's gain is 2dBi and meets the requirement.



6. PHOTOS OF TESTING

- Conducted test (PIFA-Link)

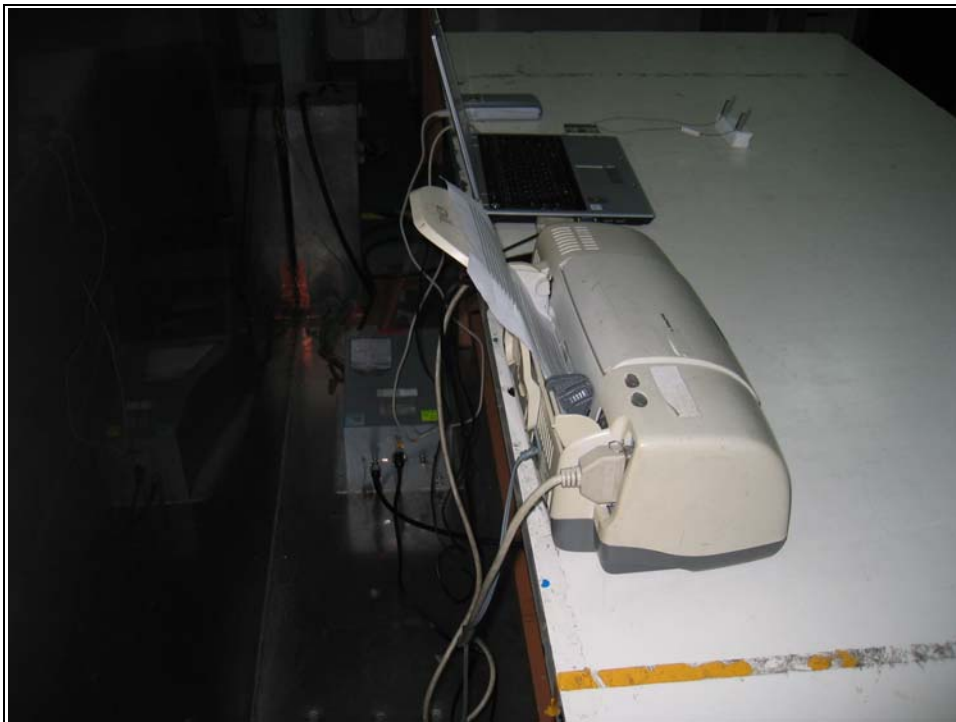



Spectrum Research & Testing Lab., Inc.
No. 101-10, Ling 8,
Shan-Tong Li, Chung-Li
City, Taoyuan, Taiwan

TEST REPORT

Reference No.: C006032406
Report No.: FCCC05121206-02
FCC ID: I4L-MS6833B-M
Page: 89 of 96
Date: APR. 09, 2006

- Conducted test (PIFA-TX)





Spectrum Research & Testing Lab., Inc.
No. 101-10, Ling 8,
Shan-Tong Li, Chung-Li
City, Taoyuan, Taiwan

TEST REPORT

Reference No.: C006032406
Report No.: FCCC05121206-02
FCC ID: I4L-MS6833B-M
Page:90 of 96
Date: APR. 09, 2006

- Conducted test (DIPOLE -Link)

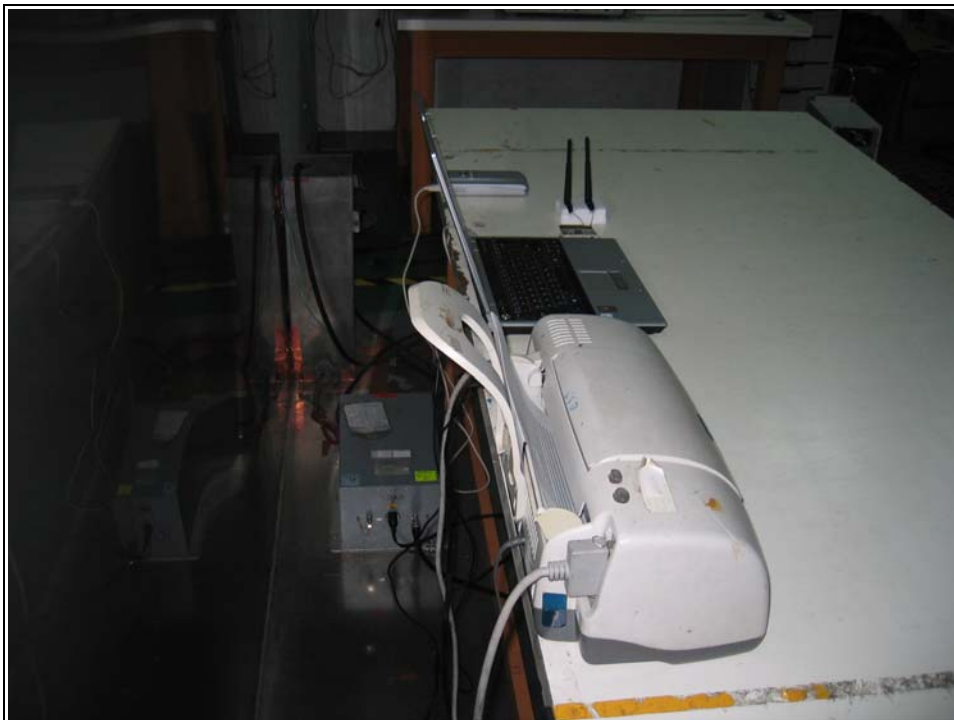



Spectrum Research & Testing Lab., Inc.
No. 101-10, Ling 8,
Shan-Tong Li, Chung-Li
City, Taoyuan, Taiwan

TEST REPORT

Reference No.: C006032406
Report No.: FCCC05121206-02
FCC ID: I4L-MS6833B-M
Page: 91 of 96
Date: APR. 09, 2006

- Conducted test (DIPOLE -TX)





- Radiated test (PIFA-Link)





Spectrum Research & Testing Lab., Inc.
No. 101-10, Ling 8,
Shan-Tong Li, Chung-Li
City, Taoyuan, Taiwan

TEST REPORT

Reference No.: C006032406
Report No.: FCCC05121206-02
FCC ID: I4L-MS6833B-M
Page: 93 of 96
Date: APR. 09, 2006

- Radiated test (DIPOLE - Link)





Radiated test (PIFA-TX)

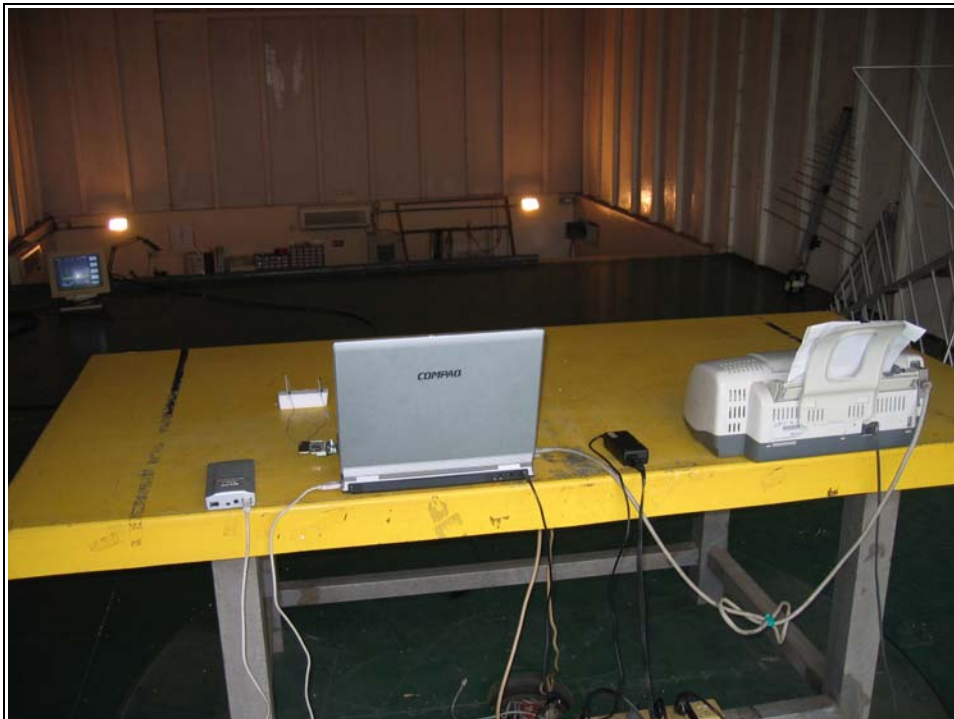



Radiated test (DIPOLE -TX)





Spectrum Research & Testing Lab., Inc.
No. 101-10, Ling 8,
Shan-Tong Li, Chung-Li
City, Taoyuan, Taiwan

TEST REPORT

Reference No.: C006032406
Report No.: FCCC05121206-02
FCC ID: I4L-MS6833B-M
Page: 96 of 96
Date: APR. 09, 2006

7. TERMS OF ABRIVATION

AV.	Average detection
AZ(°)	Turn table azimuth
Correct.	Correction
EL(m)	Antenna height (meter)
EUT	Equipment Under Test
Horiz.	Horizontal direction
LISN	Line Impedance Stabilization Network
NSA	Normalized Site Attenuation
Q.P.	Quasi-peak detection
SRT Lab	Spectrum Research & Testing Laboratory, Inc.
Vert.	Vertical direction