



## Test Report

Product Name : Mini PCI Card

Model No : MS-6833A

FCC ID : I4L-MS6833A

Applicant : MICRO-STAR INT'L Co., LTD

Address : No 69, Li-De st., Jung-He City, Taipei Hsien, Taiwan, R.O.C

Date of Receipt : Jul. 02, 2004

Issued Date : Jul. 15, 2004

Report No. : 047L030FI

The test results relate only to the samples tested.

The test report shall not be reproduced except in full without the written approval of Quietek Corporation.

This report must not be used to claim product endorsement by NVLAP any agency of the U.S. Government

# Test Report Certification

Issued Date : Jul. 15, 2004

Report No. : 047L030FI



Accredited by NIST (NVLAP)

NVLAP Lab Code: 200533-0

Product Name : Mini PCI Card

Applicant : MICRO-STAR INT'L Co., LTD

Address : No 69, Li-De st., Jung-He City, Taipei Hsien, Taiwan, R.O.C

Manufacturer : MICRO-STAR INT'L Co., LTD

Model No. : MS-6833A

Rated Voltage : DC 3.3V

Trade Name : MSI

Measurement Standard : FCC CFR Title 47 Part 15 Subpart C: 2003

Measurement Procedure : ANSI C63.4: 2001

Test Result : Complied



Test results relate only to the samples tested.

The test report shall not be reproduced except in full without the written approval of Quietek Corporation.

This report must not be used to claim product endorsement by NVLAP any agency of the U.S. Government

Documented By : Grace Lin  
( Grace Lin )

Tested By : Jeff Wu  
( Jeff Wu )

Approved By : Gene Chang  
( Gene Chang )

## TABLE OF CONTENTS

Description	Page
<b>1. GENERAL INFORMATION .....</b>	<b>4</b>
1.1. EUT Description.....	4
1.2. Operational Description .....	5
1.3. Tested System Details.....	6
1.4. Configuration of tested System .....	6
1.5. EUT Exercise Software .....	6
1.6. Test Facility .....	7
<b>2. Conducted Emission.....</b>	<b>8</b>
2.1. Test Equipment.....	8
2.2. Test Setup .....	8
2.3. Limits .....	8
2.4. Test Procedure .....	9
2.5. Uncertainty .....	9
2.6. Test Result of Conducted Emission.....	10
<b>3. Peak Power Output .....</b>	<b>22</b>
3.1. Test Equipment.....	22
3.2. Test Setup .....	22
3.3. Limits .....	22
3.4. Uncertainty .....	22
3.5. Test Result of Peak Power Output.....	23
<b>4. Radiated Emission.....</b>	<b>25</b>
4.1. Test Equipment.....	25
4.2. Test Setup .....	25
4.3. Limits .....	26
4.4. Test Procedure .....	27
4.5. Uncertainty .....	27
4.6. Test Result of Radiated Emission.....	28
<b>5. Band Edge .....</b>	<b>40</b>
5.1. Test Equipment.....	40
5.2. Test Setup .....	40
5.3. Limits .....	41
5.4. Test Procedure .....	41
5.5. Uncertainty .....	41
5.6. Test Result of Band Edge .....	42
<b>6. Occupied Bandwidth.....</b>	<b>46</b>
6.1. Test Equipment.....	46
6.2. Test Setup .....	46
6.3. Limits .....	46
6.4. Uncertainty .....	46
6.5. Test Result of Occupied Bandwidth .....	47
<b>7. Power Density .....</b>	<b>53</b>
7.1. Test Equipment.....	53
7.2. Test Setup .....	53
7.3. Limits .....	53
7.4. Uncertainty .....	53
7.5. Test Result of Power Density .....	54
<b>8. EMI Reduction Method During Compliance Testing .....</b>	<b>60</b>

Attachment 1: EUT Test Photographs

Attachment 2: EUT Detailed Photographs

## 1. GENERAL INFORMATION

### 1.1. EUT Description

Product Name	: Mini PCI Card
Trade Name	: MSI
Model No.	: MS-6833A
Frequency Range	: 2412MHz to 2462MHz
FCC ID	: I4L-MS6833A
Channel Number	: 11
Data Speed (IEEE 802.11b)	: 1Mbps, 2Mbps, 5.5Mbps, 11Mbps
Data Speed (IEEE 802.11g)	: 6Mbps, 9Mbps, 12Mbps, 18Mbps, 24Mbps, 36Mbps, 48Mbps, 54Mbps
Type of Modulation	: DSSS / OFDM
Antenna Type	: Connector
Antenna Gain	: MS-1002, 2.99dBi
	: FAVORTRON AN5, 2.85dBi
	: ADA3P-713K601, 2dBi
	: E12B Antenna, 1.92dBi
	: FIC, 1.56dBi
	: CLEVO 285P, 0.47dBi
	: E12S, 0.31dBi
	: 258KA0, 0.13dBi
	: FOXCONN N223, -0.06dBi
	: CLEVO 5600, -0.45dBi
	: SmartAnt UniWill U11, -1.16 dBi
	: M300N, -2.45dBi
Channel Control	: Auto
Channel separation	: 5M

Note: Base on the verification, the MS-1002 with maximum antenna gain was selected as final test.

#### Frequency of Each Channel:

Channel	Frequency	Channel	Frequency	Channel	Frequency
Channel 1:	2412 MHz	Channel 5:	2432 MHz	Channel 9:	2452 MHz
Channel 2:	2417 MHz	Channel 6:	2437 MHz	Channel 10:	2457 MHz
Channel 3:	2422 MHz	Channel 7:	2442 MHz	Channel 11:	2462 MHz
Channel 4:	2427 MHz	Channel 8:	2447 MHz		

Note:

1. This device is a 2.4GHz Mini PCI Card included a 2.4GHz receiving function, a 2.4GHz transmitting function.
2. Regards to the frequency band operation; the highest rate that was included the lowest , middle and highest frequency of channel were selected to perform the test, then shown on this report.
3. These tests were conducted on a sample of the equipment for the purpose of demonstrating compliance with Part 15 Subpart C Paragraph 15.247 for spread spectrum devices.

## 1.2. Operational Description

EUT is a Mini PCI Card with 11 channels. This device provided four kinds of transmitting speed 1, 2, 5.5 and 11Mbps. The device of RF carrier is DBPSK, DQPSK and CCK (IEEE 802.11b) or eight kinds of transmitting speed 6, 9, 12, 18, 24, 36, 48 and 54Mbps. The device of RF carrier is OFDM (IEEE 802.11g).

The device adapts direct sequence spread spectrum modulation. The antenna was Connector provides diversity function to improve the receiving function.

This Mini PCI Card, compliant with IEEE 802.11b and IEEE 802.11g, is a high-efficiency Wireless LAN adapter. It allows your computer to connect to a wireless network and to share resources, such as files or printers without being bound to the network wires. Operation in 2.4GHz Direst Sequence Spread Spectrum (DSSS) radio transmission, the Mini PCI Card Wired Equivalent Protection (WEP) algorithm is used. In addition, its standard compliance ensures that it can communicate with any IEEE 802.11b and IEEE 802.11g network.

Test Mode:	Mode 1: Transmitter 11Mbps
	Mode 1: Transmitter 54Mbps

### 1.3. Tested System Details

The types for all equipment, plus descriptions of all cables used in the tested system (including inserted cards) are:

	Product	Manufacturer	Model No.	Serial No.	FCC ID	Power Cord
(1)	Notebook PC	DELL	PP01L	N/A	DoC	Non-Shielded, 1.8m

	Signal Cable Type	Signal cable Description
A.	N/A	N/A

### 1.4. Configuration of tested System

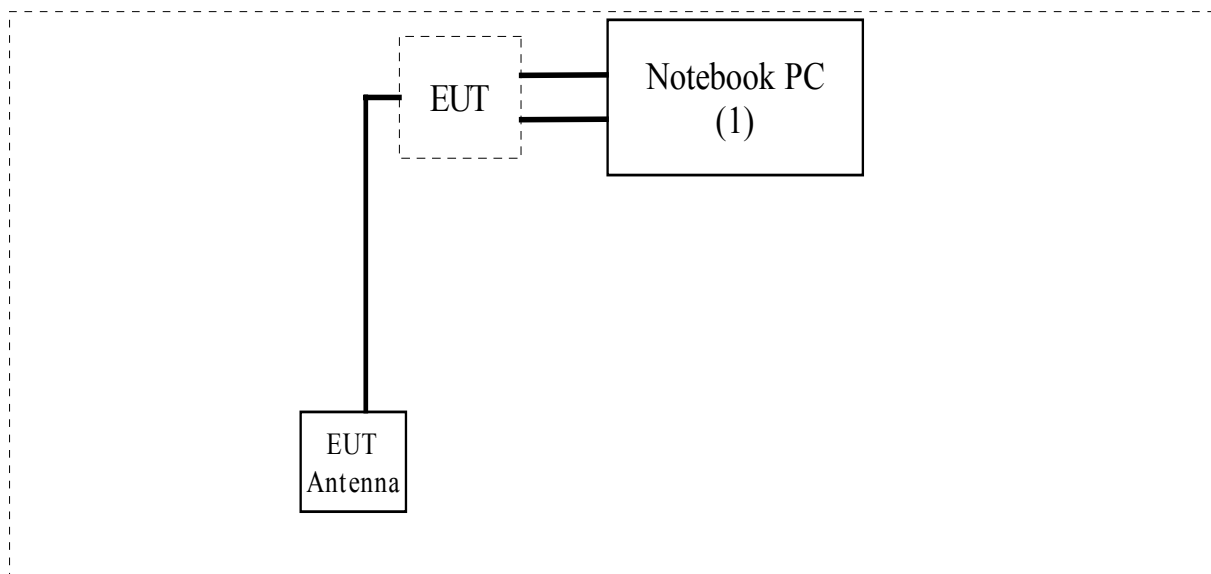

### 1.5. EUT Exercise Software

- (1) Setup the EUT and simulators as shown on 1.4
- (2) Turn on the power of all equipment.
- (3) PC reads data from disk.
- (4) Data will to coerce transmitting through EUT.
- (5) Repeat the above procedure (3) to (4)

**1.6. Test Facility**

Ambient conditions in the laboratory:

Items	Required (IEC 68-1)	Actual
Temperature (°C)	15-35	20-35
Humidity (%RH)	25-75	50-65
Barometric pressure (mbar)	860-1060	950-1000

Site Description: June 22, 2001 File on  
 Federal Communications Commission  
 FCC Engineering Laboratory  
 7435 Oakland Mills Road  
 Columbia, MD 21046  
 Reference 31040/SIT1300F2



0914

ILAC MRA

July 03, 2001 Accreditation on NVLAP  
 NVLAP Lab Code: 200533-0



Site Name: Quietek Corporation

Site Address: No. 5-22, Ruei-Shu Valley, Ruei-Ping Tsuen,  
 Lin-Kou Shiang, Taipei,  
 Taiwan, R.O.C.



TEL: 886-2-8601-3788 / FAX : 886-2-8601-3789

E-Mail : [service@quietek.com](mailto:service@quietek.com)

## 2. Conducted Emission

### 2.1. Test Equipment

The following test equipment are used during the conducted emission test:

Item	Instrument	Manufacturer	Type No./Serial No	Last Cal.	Remark
1	Test Receiver	R & S	ESCS 30/825442/17	May, 2004	
2	L.I.S.N.	R & S	ESH3-Z5/825016/6	May, 2004	EUT
3	L.I.S.N.	Kyoritsu	KNW-407/8-1420-3	May, 2004	Peripherals
4	Pulse Limiter	R & S	ESH3-Z2	May, 2004	
5	No.1 Shielded Room			N/A	

Note: All equipment upon which need to calibrated are with calibration period of 1 year.

### 2.2. Test Setup

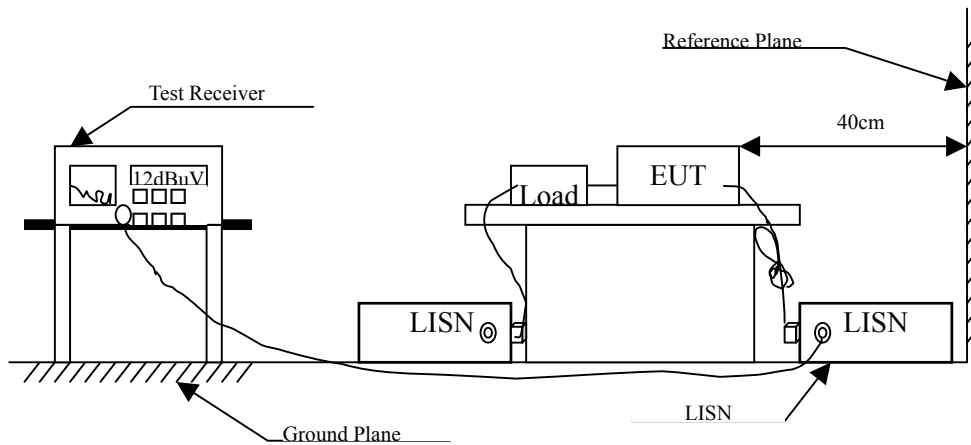

### 2.3. Limits

FCC Part 15 Subpart C Paragraph 15.207 (dBuV) Limit		
Frequency MHz	Limits	
	uV	dBuV
0.15 - 0.50	66-56 <sup>(註)</sup>	56-46 <sup>(註)</sup>
0.50-5.0	56	46
5.0 - 30	60	50



## 2.4. Test Procedure

The EUT and simulators are connected to the main power through a line impedance stabilization network (L.I.S.N.). This provides a 50 ohm /50uH coupling impedance for the measuring equipment. The peripheral devices are also connected to the main power through a LISN that provides a 50ohm /50uH coupling impedance with 50ohm termination. (Please refers to the block diagram of the test setup and photographs.)

Both sides of A.C. line are checked for maximum conducted interference. In order to find the maximum emission, the relative positions of equipment and all of the interface cables must be changed according to ANSI C63.4: 2001 on conducted measurement.

Conducted emissions were investigated over the frequency range from 0.15MHz to 30MHz using a receiver bandwidth of 9kHz.

## 2.5. Uncertainty

The measurement uncertainty is defined as  $\pm 2.02$  dB

## 2.6. Test Result of Conducted Emission

Product : Mini PCI Card  
 Test Item : Conducted Emission Test  
 Power Line : Line 1  
 Test Mode : Mode 1: Transmitter 11Mbps (Channel 1)

Frequency MHz	Cable Loss dB	LISN Factor dB	Reading Level dBuV	Emission Level dBuV	Limits dBuV
=====					
Quasi-Peak					
* 0.181	0.60	0.10	49.53	50.23	64.43
0.236	0.60	0.10	42.68	43.38	62.24
0.295	0.60	0.10	36.51	37.21	60.40
0.416	0.60	0.10	28.88	29.58	57.54
3.963	0.60	0.16	27.07	27.83	56.00
14.267	0.86	0.33	27.33	28.52	60.00
Average					
* 0.181	0.60	0.10	39.60	40.30	54.44
0.236	0.60	0.10	32.00	32.70	52.24
0.295	0.60	0.10	26.10	26.80	50.38
0.416	0.60	0.10	18.10	18.80	47.53
3.963	0.60	0.16	15.90	16.66	46.00
14.267	0.86	0.33	17.20	18.39	50.00

Note:

1. All Reading Levels are Quasi-Peak value.
2. “ \* ”, means this data is the worst emission level.
3. Emission Level = Reading Level + LISN Factor + Cable Loss.

Product : Mini PCI Card  
 Test Item : Conducted Emission Test  
 Power Line : Line 2  
 Test Mode : Mode 1: Transmitter 11Mbps (Channel 1)

Frequency	Cable	LISN	Reading	Emission	Limits
MHz	Loss	Factor	Level	Level	
	dB	dB	dBuV	dBuV	dBuV
=====					
Quasi-Peak					
* 0.177	0.60	0.10	51.76	52.46	64.61
0.236	0.60	0.10	42.86	43.56	62.24
0.298	0.60	0.10	35.80	36.50	60.29
0.416	0.60	0.10	31.25	31.95	57.54
10.787	0.66	0.23	26.44	27.33	60.00
14.279	0.86	0.33	26.32	27.51	60.00
Average					
* 0.177	0.60	0.10	41.70	42.40	54.63
0.236	0.60	0.10	31.00	31.70	52.24
0.298	0.60	0.10	26.50	27.20	50.30
0.416	0.60	0.10	26.10	26.80	47.53
10.787	0.66	0.23	21.60	22.49	50.00
14.279	0.86	0.33	16.20	17.39	50.00

Note:

1. All Reading Levels are Quasi-Peak value.
2. “ \* ”, means this data is the worst emission level.
3. Emission Level = Reading Level + LISN Factor + Cable Loss.

Product : Mini PCI Card  
 Test Item : Conducted Emission Test  
 Power Line : Line 1  
 Test Mode : Mode 1: Transmitter 11Mbps (Channel 6)

Frequency	Cable	LISN	Reading	Emission	Limits
MHz	Loss	Factor	Level	Level	dBuV
	dB	dB	dBuV	dBuV	
=====					
Quasi-Peak					
* 0.173	0.60	0.10	45.93	46.63	64.79
0.240	0.60	0.10	41.29	41.99	62.10
0.357	0.60	0.10	32.64	33.34	58.80
4.033	0.60	0.16	28.15	28.91	56.00
6.943	0.60	0.18	25.69	26.47	60.00
14.244	0.86	0.33	34.93	36.12	60.00
Average					
* 0.173	0.60	0.10	36.50	37.20	54.82
0.240	0.60	0.10	30.30	31.00	52.10
0.357	0.60	0.10	27.90	28.60	48.80
4.033	0.60	0.16	19.30	20.06	46.00
6.943	0.60	0.18	19.80	20.58	50.00
14.244	0.86	0.33	19.10	20.29	50.00

Note:

1. All Reading Levels are Quasi-Peak value.
2. “ \* ”, means this data is the worst emission level.
3. Emission Level = Reading Level + LISN Factor + Cable Loss.

Product : Mini PCI Card  
 Test Item : Conducted Emission Test  
 Power Line : Line 2  
 Test Mode : Mode 1: Transmitter 11Mbps (Channel 6)

Frequency	Cable	LISN	Reading	Emission	Limits
MHz	Loss	Factor	Level	Level	
	dB	dB	dBuV	dBuV	dBuV
=====					
Quasi-Peak					
* 0.177	0.60	0.10	51.21	51.91	64.61
0.240	0.60	0.10	41.94	42.64	62.10
0.353	0.60	0.10	33.80	34.50	58.89
3.802	0.60	0.16	30.52	31.28	56.00
6.795	0.60	0.18	25.91	26.69	60.00
13.545	0.83	0.31	30.51	31.65	60.00
Average					
* 0.177	0.60	0.10	41.20	41.90	54.63
0.240	0.60	0.10	30.70	31.40	52.10
0.353	0.60	0.10	26.30	27.00	48.89
3.802	0.60	0.16	23.20	23.96	46.00
6.795	0.60	0.18	13.90	14.68	50.00
13.545	0.83	0.31	22.00	23.14	50.00

Note:

1. All Reading Levels are Quasi-Peak value.
2. “ \* ”, means this data is the worst emission level.
3. Emission Level = Reading Level + LISN Factor + Cable Loss.

Product : Mini PCI Card  
 Test Item : Conducted Emission Test  
 Power Line : Line 1  
 Test Mode : Mode 1: Transmitter 11Mbps (Channel 11)

Frequency MHz	Cable Loss dB	LISN Factor dB	Reading Level dBuV	Emission Level dBuV	Limits dBuV
Quasi-Peak					
0.185	0.60	0.10	37.89	38.59	64.25
* 0.236	0.60	0.10	41.00	41.70	62.24
0.357	0.60	0.10	32.60	33.30	58.80
3.865	0.60	0.16	32.09	32.85	56.00
7.119	0.60	0.19	31.62	32.41	60.00
13.982	0.85	0.32	30.64	31.81	60.00
Average					
0.185	0.60	0.10	27.90	28.60	54.26
0.236	0.60	0.10	29.50	30.20	52.24
* 0.357	0.60	0.10	28.10	28.80	48.80
3.865	0.60	0.16	23.40	24.16	46.00
7.119	0.60	0.19	11.30	12.09	50.00
13.982	0.85	0.32	24.20	25.37	50.00

Note:

1. All Reading Levels are Quasi-Peak value.
2. “ \* ”, means this data is the worst emission level.
3. Emission Level = Reading Level + LISN Factor + Cable Loss.

Product : Mini PCI Card  
 Test Item : Conducted Emission Test  
 Power Line : Line 2  
 Test Mode : Mode 1: Transmitter 11Mbps (Channel 11)

Frequency	Cable	LISN	Reading	Emission	Limits
MHz	Loss	Factor	Level	Level	
	dB	dB	dBuV	dBuV	dBuV
=====					
Quasi-Peak					
* 0.181	0.60	0.10	49.81	50.51	64.43
0.236	0.60	0.10	41.47	42.17	62.24
0.357	0.60	0.10	35.91	36.61	58.80
4.107	0.60	0.16	29.71	30.47	56.00
7.115	0.60	0.19	30.53	31.32	60.00
14.236	0.86	0.33	35.51	36.70	60.00
Average					
* 0.181	0.60	0.10	39.70	40.40	54.44
0.236	0.60	0.10	30.40	31.10	52.24
0.357	0.60	0.10	28.90	29.60	48.80
4.107	0.60	0.16	21.10	21.86	46.00
7.115	0.60	0.19	11.20	11.99	50.00
14.236	0.86	0.33	19.50	20.69	50.00

Note:

1. All Reading Levels are Quasi-Peak value.
2. “ \* ”, means this data is the worst emission level.
3. Emission Level = Reading Level + LISN Factor + Cable Loss

Product : Mini PCI Card  
 Test Item : Conducted Emission Test  
 Power Line : Line 1  
 Test Mode : Mode 1: Transmitter 54Mbps (Channel 1)

Frequency MHz	Cable Loss dB	LISN Factor dB	Reading Level dBuV	Emission Level dBuV	Limits dBuV
=====					
Quasi-Peak					
0.173	0.60	0.10	40.69	41.39	64.79
* 0.240	0.60	0.10	40.31	41.01	62.10
0.361	0.60	0.10	30.67	31.37	58.71
4.002	0.60	0.16	31.74	32.50	56.00
6.986	0.60	0.18	26.73	27.51	60.00
13.951	0.84	0.32	28.75	29.91	60.00
Average					
0.173	0.60	0.10	30.20	30.90	54.82
0.240	0.60	0.10	28.80	29.50	52.10
* 0.361	0.60	0.10	26.50	27.20	48.71
4.002	0.60	0.16	22.40	23.16	46.00
6.986	0.60	0.18	20.70	21.48	50.00
13.951	0.84	0.32	21.50	22.66	50.00

Note:

1. All Reading Levels are Quasi-Peak value.
2. “ \* ”, means this data is the worst emission level.
3. Emission Level = Reading Level + LISN Factor + Cable Loss.



Product : Mini PCI Card  
 Test Item : Conducted Emission Test  
 Power Line : Line 2  
 Test Mode : Mode 1: Transmitter 54Mbps (Channel 1)

Frequency	Cable	LISN	Reading	Emission	Limits
MHz	Loss	Factor	Level	Level	dBuV
	dB	dB	dBuV	dBuV	
=====					
Quasi-Peak					
* 0.181	0.60	0.10	49.39	50.09	64.43
0.236	0.60	0.10	39.99	40.69	62.24
0.361	0.60	0.10	34.15	34.85	58.71
4.123	0.60	0.16	29.33	30.09	56.00
7.115	0.60	0.19	31.77	32.56	60.00
14.232	0.86	0.33	34.67	35.86	60.00
Average					
* 0.181	0.60	0.10	38.50	39.20	54.44
0.236	0.60	0.10	27.80	28.50	52.24
0.361	0.60	0.10	27.00	27.70	48.71
4.123	0.60	0.16	21.80	22.56	46.00
7.115	0.60	0.19	14.20	14.99	50.00
14.232	0.86	0.33	18.80	19.99	50.00

Note:

1. All Reading Levels are Quasi-Peak value.
2. “ \* ”, means this data is the worst emission level.
3. Emission Level = Reading Level + LISN Factor + Cable Loss.

Product : Mini PCI Card  
 Test Item : Conducted Emission Test  
 Power Line : Line 1  
 Test Mode : Mode 1: Transmitter 54Mbps (Channel 6)

Frequency	Cable	LISN	Reading	Emission	Limits
MHz	Loss	Factor	Level	Level	
	dB	dB	dBuV	dBuV	dBuV
=====					
Quasi-Peak					
* 0.177	0.60	0.10	48.66	49.36	64.61
0.236	0.60	0.10	38.56	39.26	62.24
0.298	0.60	0.10	34.62	35.32	60.29
3.584	0.60	0.16	30.13	30.89	56.00
6.752	0.60	0.18	27.09	27.87	60.00
14.248	0.86	0.33	26.40	27.59	60.00
Average					
* 0.177	0.60	0.10	38.50	39.20	54.63
0.236	0.60	0.10	27.40	28.10	52.24
0.298	0.60	0.10	23.50	24.20	50.30
3.584	0.60	0.16	21.60	22.36	46.00
6.752	0.60	0.18	17.10	17.88	50.00
14.248	0.86	0.33	14.90	16.09	50.00

Note:

1. All Reading Levels are Quasi-Peak value.
2. “ \* ”, means this data is the worst emission level.
3. Emission Level = Reading Level + LISN Factor + Cable Loss.

Product : Mini PCI Card  
 Test Item : Conducted Emission Test  
 Power Line : Line 2  
 Test Mode : Mode 1: Transmitter 54Mbps (Channel 6)

Frequency	Cable	LISN	Reading	Emission	Limits
MHz	Loss	Factor	Level	Level	
	dB	dB	dBuV	dBuV	dBuV
=====					
Quasi-Peak					
* 0.181	0.60	0.10	49.41	50.11	64.43
0.302	0.60	0.10	33.89	34.59	60.18
0.478	0.60	0.10	30.85	31.55	56.37
3.888	0.60	0.16	31.99	32.75	56.00
6.994	0.60	0.18	28.37	29.15	60.00
14.224	0.86	0.33	35.59	36.78	60.00
Average					
* 0.181	0.60	0.10	38.50	39.20	54.44
0.302	0.60	0.10	24.20	24.90	50.19
0.478	0.60	0.10	27.00	27.70	46.37
3.888	0.60	0.16	24.20	24.96	46.00
6.994	0.60	0.18	22.50	23.28	50.00
14.224	0.86	0.33	18.60	19.79	50.00

Note:

1. All Reading Levels are Quasi-Peak value.
2. “ \* ”, means this data is the worst emission level.
3. Emission Level = Reading Level + LISN Factor + Cable Loss.

Product : Mini PCI Card  
 Test Item : Conducted Emission Test  
 Power Line : Line 1  
 Test Mode : Mode 1: Transmitter 54Mbps (Channel 11)

Frequency	Cable	LISN	Reading	Emission	Limits
MHz	Loss	Factor	Level	Level	
	dB	dB	dBuV	dBuV	dBuV
=====					
Quasi-Peak					
* 0.177	0.60	0.10	48.49	49.19	64.61
0.236	0.60	0.10	38.26	38.96	62.24
0.298	0.60	0.10	34.60	35.30	60.29
0.361	0.60	0.10	30.86	31.56	58.71
3.888	0.60	0.16	33.22	33.98	56.00
14.244	0.86	0.33	27.27	28.46	60.00
Average					
* 0.177	0.60	0.10	38.20	38.90	54.63
0.236	0.60	0.10	26.90	27.60	52.24
0.298	0.60	0.10	23.70	24.40	50.30
0.361	0.60	0.10	27.00	27.70	48.71
3.888	0.60	0.16	24.90	25.66	46.00
14.244	0.86	0.33	16.60	17.79	50.00

Note:

1. All Reading Levels are Quasi-Peak value.
2. “ \* ”, means this data is the worst emission level.
3. Emission Level = Reading Level + LISN Factor + Cable Loss.

Product : Mini PCI Card  
 Test Item : Conducted Emission Test  
 Power Line : Line 2  
 Test Mode : Mode 1: Transmitter 54Mbps (Channel 11)

Frequency	Cable	LISN	Reading	Emission	Limits
MHz	Loss	Factor	Level	Level	
	dB	dB	dBuV	dBuV	dBuV
=====					
Quasi-Peak					
* 0.181	0.60	0.10	49.35	50.05	64.43
0.236	0.60	0.10	38.78	39.48	62.24
0.361	0.60	0.10	34.57	35.27	58.71
3.830	0.60	0.16	31.07	31.83	56.00
6.994	0.60	0.18	27.74	28.52	60.00
13.990	0.85	0.32	28.57	29.74	60.00
Average					
* 0.181	0.60	0.10	38.40	39.10	54.44
0.236	0.60	0.10	27.10	27.80	52.24
0.361	0.60	0.10	27.50	28.20	48.71
3.830	0.60	0.16	22.70	23.46	46.00
6.994	0.60	0.18	21.40	22.18	50.00
13.990	0.85	0.32	20.80	21.97	50.00

Note:

1. All Reading Levels are Quasi-Peak value.
2. “ \* ”, means this data is the worst emission level.
3. Emission Level = Reading Level + LISN Factor + Cable Loss.

### 3. Peak Power Output

#### 3.1. Test Equipment

The following test equipments are used during the radiated emission tests:

	Equipment	Manufacturer	Model No./Serial No.	Last Cal.
X	Spectrum Analyzer	Advantest	R3272 / 72421194	May, 2004

Note: 1. All equipment upon which need to calibrated are with calibration period of 1 year.  
 2. Mark "X" test instruments are used to measure the final test results.

#### 3.2. Test Setup

##### Conduction Power Measurement

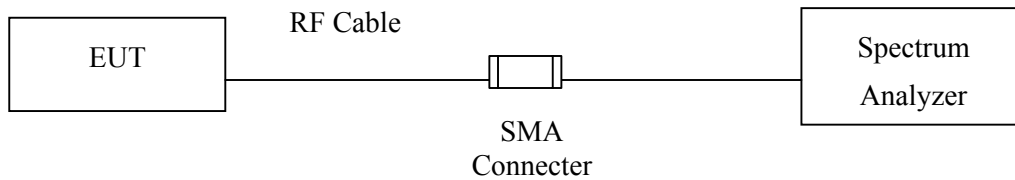

#### 3.3. Limits

The maximum peak power shall be less 1 Watt.

#### 3.4. Uncertainty

The measurement uncertainty is defined as  $\pm 1.27$  dB

### 3.5. Test Result of Peak Power Output

Product : Mini PCI Card  
 Test Item : Peak Power Output Data  
 Test Site : No.3OATS  
 Test Mode : Transmitter 11Mbps

#### Data Speed: 11Mbps

Channel No.	Frequency (MHz)	Measurement	Required Limit	Result
1	2412.00	14.07dBm	1 Watt= 30 dBm	Pass
6	2437.00	14.61dBm	1 Watt= 30 dBm	Pass
11	2462.00	13.98dBm	1 Watt= 30 dBm	Pass

11Mbps-Ch01

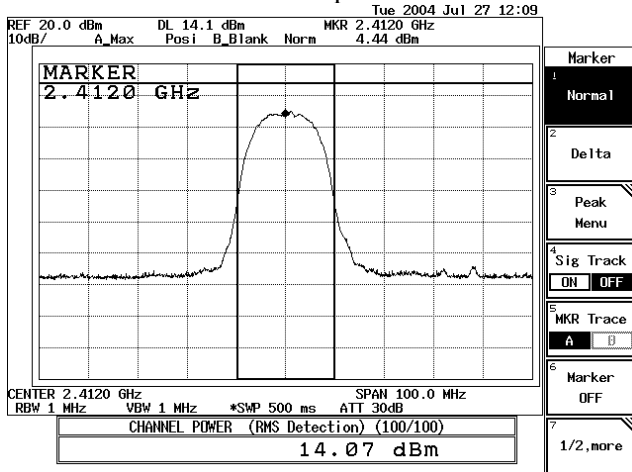

11Mbps-Ch06

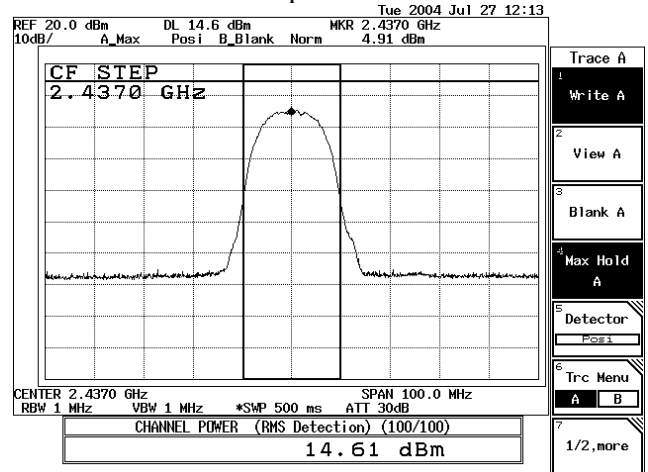

11Mbps-Ch 11

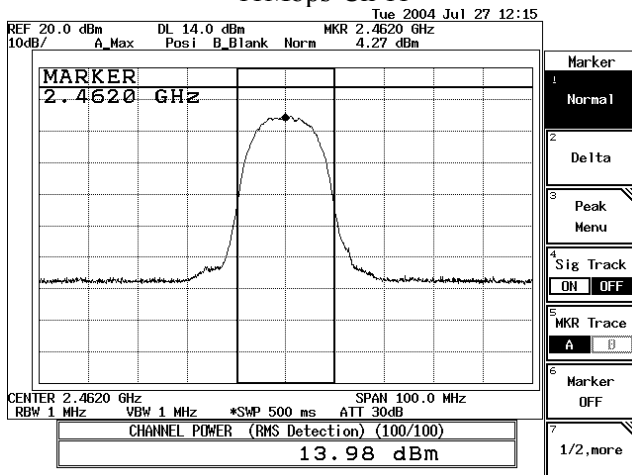

Product : Mini PCI Card  
 Test Item : Peak Power Output Data  
 Test Site : No.3OATS  
 Test Mode : Transmitter 54Mbps

**Data Speed: 54Mbps**

Channel No.	Frequency (MHz)	Measurement	Required Limit	Result
1	2412.00	13.85dBm	1 Watt= 30 dBm	Pass
6	2437.00	14.01dBm	1 Watt= 30 dBm	Pass
11	2462.00	14.01dBm	1 Watt= 30 dBm	Pass

54Mbps-Ch01

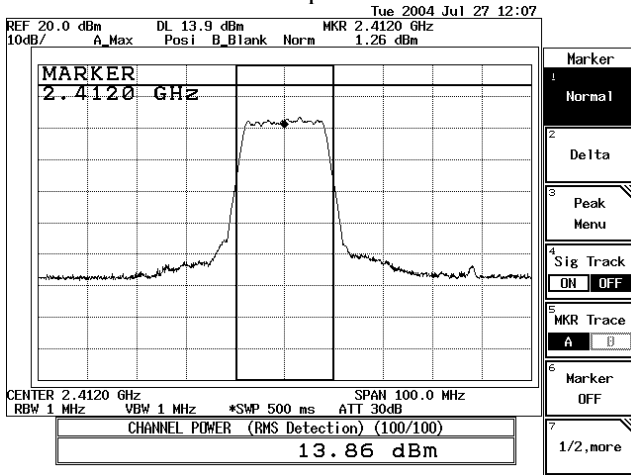

54Mbps-Ch06

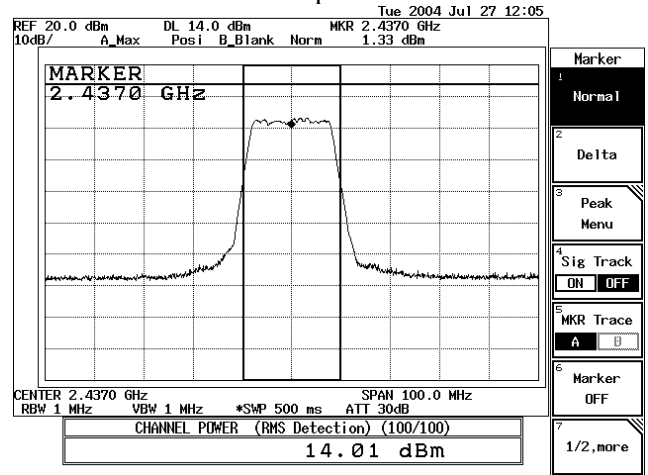

54Mbps-Ch11

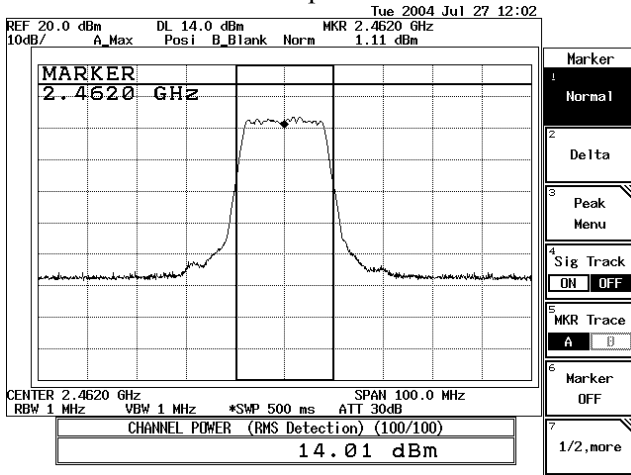



## 4. Radiated Emission

### 4.1. Test Equipment

The following test equipment are used during the radiated emission test:

Test Site	Equipment	Manufacturer	Model No./Serial No.	Last Cal.
Site # 1	Test Receiver	R & S	ESCS 30 / 825442/14	May, 2004
	Spectrum Analyzer	Advantest	R3261C / 71720140	May, 2004
	Pre-Amplifier	HP	8447D/3307A01812	May, 2004
	Bilog Antenna	Chase	CBL6112B / 12452	Sep., 2003
	Horn Antenna	EM	EM6917 / 103325	May, 2004
Site # 2	Test Receiver	R & S	ESCS 30 / 825442/17	May, 2004
	Spectrum Analyzer	Advantest	R3261C / 71720609	May, 2004
	Pre-Amplifier	HP	8447D/3307A01814	May, 2004
	Bilog Antenna	Chase	CBL6112B / 2455	Sep., 2003
	Horn Antenna	EM	EM6917 / 103325	May, 2004
Site # 3	X Test Receiver	R & S	ESI 26 / 838786 / 004	May, 2004
	X Spectrum Analyzer	Advantest	R3162 / 100803480	May, 2004
	X Pre-Amplifier	QTK	QTK-AMP-03 / 0003	May, 2004
	X Bilog Antenna	SCHAFFNER	CBL6112B / 2697	May, 2004
	X Horn Antenna	Schwarzbeck	BBHA9170/708	July, 2004
	X Horn Antenna	ETS	3115 / 0005-6160	Jul., 2004
	X Pre-Amplifier	QTK	QTK-AMP-01 / 0001	Jul., 2004

- Note:
1. All equipments that need to calibrate are with calibration period of 1 year.
  2. Mark "X" test instruments are used to measure the final test results.

### 4.2. Test Setup

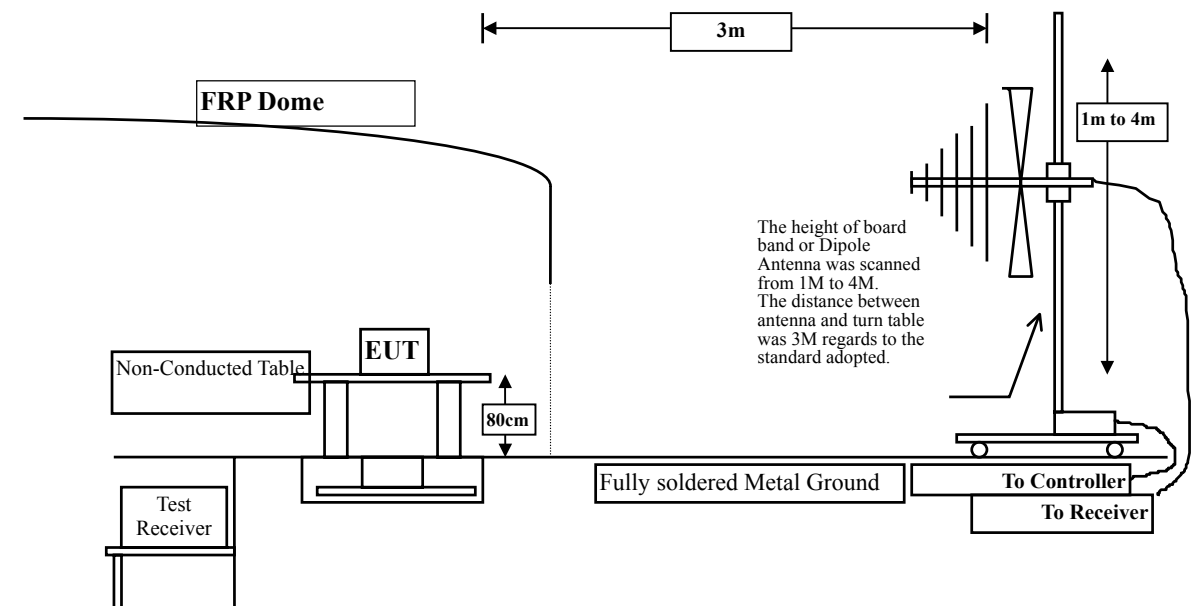

### 4.3. Limits

#### ➤ General Radiated Emission Limits

Emissions radiated outside of the specified frequency bands, except for harmonics, shall be attenuated by at least 20dB below the level of the fundamental or to the general radiated emission limits in paragraph 15.209, whichever is the lesser attenuation.

<b>FCC Part 15 Subpart C Paragraph 15.209(a) Limits</b>		
Frequency MHz	uV/m @3m	dBuV/m@3m
30-88	100	40
88-216	150	43.5
216-960	200	46
Above 960	500	54

- Remarks :
1. RF Voltage (dBuV) = 20 log RF Voltage (uV)
  2. In the Above Table, the tighter limit applies at the band edges.
  3. Distance refers to the distance in meters between the measuring instrument antenna and the closed point of any part of the device or system.

#### 4.4. Test Procedure

The EUT and its simulators are placed on a turn table which is 0.8 meter above ground. The turn table can rotate 360 degrees to determine the position of the maximum emission level. The EUT was positioned such that the distance from antenna to the EUT was 3 meters.

The antenna can move up and down between 1 meter and 4 meters to find out the maximum emission level.

Both horizontal and vertical polarization of the antenna are set on measurement. In order to find the maximum emission, all of the interface cables must be manipulated according to ANSI C63.4: 2001 on radiated measurement.

The additional latch filter below 1GHz was used to measure the level of harmonics radiated emission during field strength of harmonics measurement.

The bandwidth below 1GHz setting on the field strength meter (R&S Test Receiver ESCS 30 )is 120 kHz, above 1GHz are 1 MHz.

The frequency range from 30MHz to 10th harmonics is checked.

#### 4.5. Uncertainty

The measurement uncertainty is defined as  $\pm 3.8$  dB above 1GHz as  $\pm 3.9$  dB

#### 4.6. Test Result of Radiated Emission

Product : Mini PCI Card  
 Test Item : Harmonic Radiated Emission Data  
 Test Site : No.3OATS  
 Test Mode : Mode 1: Transmitter 11Mbps(Channel 1)

Frequency MHz	Cable Loss dB	Probe Factor dB/m	PreAMP dB	Reading Level dBuV	Emission Level dBuV/m	Margin dB	Limit dBuV/m
<b>Horizontal</b>							
<b>Peak Detector</b>							
4824.000	4.23	31.21	34.68	45.59	46.35	27.65	74.00
7236.000	5.63	35.87	34.99	43.91	50.42	23.58	74.00
9648.000	7.00	37.84	35.10	43.84	53.58	20.42	74.00
12060.00	8.40	38.62	34.14	43.74	56.61	17.39	74.00
14472.00	9.77	40.93	34.03	36.10	52.77	21.23	74.00
16884.00	11.17	36.25	34.06	39.65	53.01	20.99	74.00
19296.00	11.80	36.71	33.80	38.93	53.64	20.36	74.00
21708.00	11.80	37.15	33.80	38.56	53.71	20.29	74.00
24120.00	11.80	37.70	33.80	38.23	53.93	20.07	74.00
<b>Average Detector</b>							
12060.00	8.40	38.62	34.14	32.50	45.37	8.63	54.00
<b>Vertical</b>							
<b>Peak Detector</b>							
4824.000	4.23	31.21	34.68	44.87	45.63	28.37	74.00
7236.000	5.63	35.87	34.99	43.44	49.95	24.05	74.00
9648.000	7.00	37.84	35.10	43.95	53.69	20.31	74.00
12060.00	8.40	38.62	34.14	43.23	56.10	17.90	74.00
14472.00	9.77	40.93	34.03	34.86	51.53	22.47	74.00
16884.00	11.17	36.25	34.06	38.52	51.88	22.12	74.00
19296.00	11.80	36.71	33.80	37.58	52.29	21.71	74.00
21708.00	11.80	37.15	33.80	37.56	52.71	21.29	74.00
24120.00	11.80	37.70	33.80	37.42	53.12	20.88	74.00
<b>Average Detector</b>							
12060.00	8.40	38.62	34.14	32.27	45.14	8.86	54.00

Note:

1. All Readings below 1GHz are Quasi-Peak, above are average value.
2. Receiver setting (Peak Detector) : RBW:1MHz; VBW:1MHz; Span:100MHz ◦
3. Receiver setting (AVG Detector) : RBW:1MHz; VBW:30Hz; Span:20MHz ◦
4. Emission Level = Reading Level + Probe Factor + Cable Loss- PreAMP.
5. The average measurement was not performed when the peak measured data under the limit of average detection. If the readings given are average, peak measurement should also be supplied.

Product : Mini PCI Card  
 Test Item : Harmonic Radiated Emission Data  
 Test Site : No.3 OATS  
 Test Mode : Mode 1: Transmitter 11Mbps(Channel 6)

Frequency MHz	Cable Loss dB	Probe Factor dB/m	PreAMP dB	Reading Level dBuV	Emission Level dBuV/m	Margin dB	Limit dBuV/m
<b>Horizontal</b>							
<b>Peak Detector</b>							
4874.000	4.26	31.37	34.69	44.20	45.15	28.85	74.00
7311.000	5.67	36.00	35.01	43.44	50.10	23.90	74.00
9748.000	7.06	37.90	35.10	44.56	54.42	19.58	74.00
12185.00	8.47	38.65	34.09	43.47	56.50	17.50	74.00
14622.00	9.87	40.71	34.05	35.33	51.86	22.14	74.00
17059.00	11.25	36.27	34.04	38.84	52.32	21.68	74.00
19496.00	11.80	36.79	33.80	37.75	52.54	21.46	74.00
21933.00	11.80	37.18	33.80	37.78	52.96	21.04	74.00
24370.00	11.80	37.68	33.80	37.83	53.51	20.49	74.00
<b>Average Detector</b>							
9748.000	7.06	37.90	35.10	33.33	43.19	10.81	54.00
12185.00	8.47	38.65	34.09	32.90	45.93	8.07	54.00
<b>Vertical</b>							
<b>Peak Detector</b>							
4874.000	4.26	31.37	34.69	43.98	44.93	29.07	74.00
7311.000	5.67	36.00	35.01	43.23	49.89	24.11	74.00
9748.000	7.06	37.90	35.10	43.80	53.66	20.34	74.00
12185.00	8.47	38.65	34.09	43.83	56.86	17.14	74.00
14622.00	9.87	40.71	34.05	34.58	51.11	22.89	74.00
17059.00	11.25	36.27	34.04	38.25	51.73	22.27	74.00
19496.00	11.80	36.79	33.80	37.71	52.50	21.50	74.00
21933.00	11.80	37.18	33.80	37.80	52.98	21.02	74.00
24370.00	11.80	37.68	33.80	37.69	53.37	20.63	74.00
<b>Average Detector</b>							
12185.00	8.47	38.65	34.09	32.63	45.66	8.34	54.00

Note:

1. All Readings below 1GHz are Quasi-Peak, above are average value.
2. Receiver setting (Peak Detector) : RBW:1MHz; VBW:1MHz; Span:100MHz ◦
3. Receiver setting (AVG Detector) : RBW:1MHz; VBW:30Hz; Span:20MHz ◦
4. Emission Level = Reading Level + Probe Factor + Cable Loss- PreAMP.
5. The average measurement was not performed when the peak measured data under the limit of average detection. If the readings given are average, peak measurement should also be supplied.

Product : Mini PCI Card  
 Test Item : Harmonic Radiated Emission Data  
 Test Site : No.3 OATS  
 Test Mode : Mode 1: Transmitter 11Mbps(Channel 11)

Frequency MHz	Cable Loss dB	Probe Factor dB/m	PreAMP dB	Reading Level dBuV	Emission Level dBuV/m	Margin dB	Limit dBuV/m
<b>Horizontal</b>							
<b>Peak Detector</b>							
4924.000	4.31	31.43	34.69	42.83	43.88	30.12	74.00
7386.000	5.72	36.12	35.02	42.86	49.68	24.32	74.00
9848.000	7.13	38.00	35.07	43.88	53.94	20.06	74.00
12310.00	8.53	38.68	34.03	43.18	56.36	17.64	74.00
14772.00	9.95	40.50	34.05	35.11	51.50	22.50	74.00
17234.00	11.35	36.23	34.02	38.19	51.75	22.25	74.00
19696.00	11.80	36.84	33.80	37.88	52.72	21.28	74.00
22158.00	11.80	37.18	33.80	37.98	53.16	20.84	74.00
24620.00	11.80	37.66	33.80	37.71	53.37	20.63	74.00
<b>Average Detector</b>							
12310.00	8.53	38.68	34.03	32.73	45.91	8.09	54.00
<b>Vertical</b>							
<b>Peak Detector</b>							
4924.000	4.31	31.43	34.69	43.19	44.24	29.76	74.00
7386.000	5.72	36.12	35.02	42.61	49.43	24.57	74.00
9848.000	7.13	38.00	35.07	43.80	53.86	20.14	74.00
12310.00	8.53	38.68	34.03	43.66	56.84	17.16	74.00
14772.00	9.95	40.50	34.05	35.00	51.39	22.61	74.00
17234.00	11.35	36.23	34.02	38.35	51.91	22.09	74.00
19696.00	11.80	36.84	33.80	37.71	52.55	21.45	74.00
22158.00	11.80	37.18	33.80	37.85	53.03	20.97	74.00
24620.00	11.80	37.66	33.80	37.96	53.62	20.38	74.00
<b>Average Detector</b>							
12310.00	8.53	38.68	34.03	32.21	45.39	8.61	54.00

Note:

1. All Readings below 1GHz are Quasi-Peak, above are average value.
2. Receiver setting (Peak Detector) : RBW:1MHz; VBW:1MHz; Span:100MHz ◦
3. Receiver setting (AVG Detector) : RBW:1MHz; VBW:30Hz; Span:20MHz ◦
4. Emission Level = Reading Level + Probe Factor + Cable Loss- PreAMP.
5. The average measurement was not performed when the peak measured data under the limit of average detection. If the readings given are average, peak measurement should also be supplied.

Product : Mini PCI Card  
 Test Item : Harmonic Radiated Emission Data  
 Test Site : No.3OATS  
 Test Mode : Mode 1: Transmitter 54Mbps (Channel 1)

Frequency	Cable	Probe	PreAMP	Reading	Emission	Margin	Limit
MHz	Loss	Factor		Level	Level		
	dB	dB/m	dB	dBuV	dBuV/m	dB	dBuV/m
<b>Horizontal</b>							
<b>Peak Detector</b>							
4824.000	4.23	31.21	34.68	43.03	43.79	30.21	74.00
7236.000	5.63	35.87	34.99	45.00	51.51	22.49	74.00
9648.000	7.00	37.84	35.10	43.55	53.29	20.71	74.00
12060.00	8.40	38.62	34.14	40.56	53.43	20.57	74.00
14472.00	9.77	40.93	34.03	34.80	51.47	22.53	74.00
16884.00	11.17	36.25	34.06	38.50	51.86	22.14	74.00
19296.00	11.80	36.71	33.80	37.40	52.11	21.89	74.00
21708.00	11.80	37.15	33.80	37.56	52.71	21.29	74.00
24120.00	11.80	37.70	33.80	37.42	53.12	20.88	74.00
<b>Average Detector</b>							
---							
<b>Vertical</b>							
<b>Peak Detector</b>							
4824.000	4.23	31.21	34.68	43.91	44.67	29.33	74.00
7236.000	5.63	35.87	34.99	43.71	50.22	23.78	74.00
9648.000	7.00	37.84	35.10	43.98	53.72	20.28	74.00
12060.00	8.40	38.62	34.14	40.86	53.73	20.27	74.00
14472.00	9.77	40.93	34.03	34.86	51.53	22.47	74.00
16884.00	11.17	36.25	34.06	38.52	51.88	22.12	74.00
19296.00	11.80	36.71	33.80	37.59	52.30	21.70	74.00
21708.00	11.80	37.15	33.80	37.56	52.71	21.29	74.00
24120.00	11.80	37.70	33.80	37.62	53.32	20.68	74.00
<b>Average Detector</b>							
---							

Note:

1. All Readings below 1GHz are Quasi-Peak, above are average value.
2. Receiver setting (Peak Detector) : RBW:1MHz; VBW:1MHz; Span:100MHz °
3. Receiver setting (AVG Detector) : RBW:1MHz; VBW:30Hz; Span:20MHz °
4. Emission Level = Reading Level + Probe Factor + Cable Loss- PreAMP.
5. The average measurement was not performed when the peak measured data under the limit of average detection. If the readings given are average, peak measurement should also be supplied.

Product : Mini PCI Card  
 Test Item : Harmonic Radiated Emission Data  
 Test Site : No.3 OATS  
 Test Mode : Mode 1: Transmitter 54Mbps (Channel 6)

Frequency MHz	Cable Loss dB	Probe Factor dB/m	PreAMP dB	Reading Level dBuV	Emission Level dBuV/m	Margin dB	Limit dBuV/m
<b>Horizontal</b>							
<b>Peak Detector</b>							
4874.000	4.26	31.37	34.69	44.44	45.39	28.61	74.00
7311.000	5.67	36.00	35.01	42.80	49.46	24.54	74.00
9748.000	7.06	37.90	35.10	43.19	53.05	20.95	74.00
12185.00	8.47	38.65	34.09	40.16	53.19	20.81	74.00
14622.00	9.87	40.71	34.05	35.07	51.60	22.40	74.00
17059.00	11.25	36.27	34.04	38.15	51.63	22.37	74.00
19496.00	11.80	36.79	33.80	37.46	52.25	21.75	74.00
21933.00	11.80	37.18	33.80	37.75	52.93	21.07	74.00
24370.00	11.80	37.68	33.80	37.69	53.37	20.63	74.00
<b>Average Detector</b>							
---							
<b>Vertical</b>							
<b>Peak Detector</b>							
4874.000	4.26	31.37	34.69	43.18	44.13	29.87	74.00
7311.000	5.67	36.00	35.01	42.51	49.17	24.83	74.00
9748.000	7.06	37.90	35.10	43.59	53.45	20.55	74.00
12185.00	8.47	38.65	34.09	40.30	53.33	20.67	74.00
14622.00	9.87	40.71	34.05	34.59	51.12	22.88	74.00
17059.00	11.25	36.27	34.04	38.29	51.77	22.23	74.00
19496.00	11.80	36.79	33.80	37.71	52.50	21.50	74.00
21933.00	11.80	37.18	33.80	37.75	52.93	21.07	74.00
24370.00	11.80	37.68	33.80	37.69	53.37	20.63	74.00
<b>Average Detector</b>							
--							

Note:

1. All Readings below 1GHz are Quasi-Peak, above are average value.
2. Receiver setting (Peak Detector) : RBW:1MHz; VBW:1MHz; Span:100MHz ◦
3. Receiver setting (AVG Detector) : RBW:1MHz; VBW:30Hz; Span:20MHz ◦
4. Emission Level = Reading Level + Probe Factor + Cable Loss- PreAMP.
5. The average measurement was not performed when the peak measured data under the limit of average detection. If the readings given are average, peak measurement should also be supplied.



Product : Mini PCI Card  
 Test Item : Harmonic Radiated Emission Data  
 Test Site : No.3 OATS  
 Test Mode : Mode 1: Transmitter 54Mbps(Channel 11)

Frequency MHz	Cable Loss dB	Probe Factor dB/m	PreAMP dB	Reading Level dBuV	Emission Level dBuV/m	Margin dB	Limit dBuV/m
<b>Horizontal</b>							
<b>Peak Detector</b>							
4924.000	4.31	31.43	34.69	44.09	45.14	28.86	74.00
7386.000	5.72	36.12	35.02	42.82	49.64	24.36	74.00
9848.000	7.13	38.00	35.07	43.69	53.75	20.25	74.00
12310.00	8.53	38.68	34.03	40.75	53.93	20.07	74.00
14772.00	9.95	40.50	34.05	34.68	51.07	22.93	74.00
17234.00	11.35	36.23	34.02	37.83	51.39	22.61	74.00
19696.00	11.80	36.84	33.80	37.22	52.06	21.94	74.00
22158.00	11.80	37.18	33.80	37.70	52.88	21.12	74.00
24620.00	11.80	37.66	33.80	37.96	53.62	20.38	74.00
<b>Average Detector</b>							
--							
<b>Vertical</b>							
<b>Peak Detector</b>							
4924.000	4.31	31.43	34.69	43.04	44.09	29.91	74.00
7386.000	5.72	36.12	35.02	43.68	50.50	23.50	74.00
9848.000	7.13	38.00	35.07	43.68	53.74	20.26	74.00
12310.00	8.53	38.68	34.03	40.68	53.86	20.14	74.00
14772.00	9.95	40.50	34.05	35.38	51.77	22.23	74.00
17234.00	11.35	36.23	34.02	38.25	51.81	22.19	74.00
19696.00	11.80	36.84	33.80	37.39	52.23	21.77	74.00
22158.00	11.80	37.18	33.80	37.61	52.79	21.21	74.00
24620.00	11.80	37.66	33.80	37.96	53.62	20.38	74.00
<b>Average Detector</b>							
--							

Note:

1. All Readings below 1GHz are Quasi-Peak, above are average value.
2. Receiver setting (Peak Detector) : RBW:1MHz; VBW:1MHz; Span:100MHz ◦
3. Receiver setting (AVG Detector) : RBW:1MHz; VBW:30Hz; Span:20MHz ◦
4. Emission Level = Reading Level + Probe Factor + Cable Loss- PreAMP.
5. The average measurement was not performed when the peak measured data under the limit of average detection. If the readings given are average, peak measurement should also be supplied.

Product : Mini PCI Card  
 Test Item : General Radiated Emission Data  
 Test Site : No.3 OATS  
 Test Mode : Mode 1: Transmitter 11Mbps (Channel 1)

Frequency	Cable Loss	Probe Factor	PreAMP	Reading Level	Emission Level	Margin	Limit
MHz	dB	dB/m	dB	dBuV	dBuV/m	dB	dBuV/m

**Horizontal:**

99.840	1.23	11.55	0.00	14.52	27.30	16.20	43.50
* 132.820	1.40	11.49	0.00	23.12	36.01	7.49	43.50
502.390	3.30	16.37	0.00	10.30	29.97	16.03	46.00
613.940	3.88	18.33	0.00	8.98	31.19	14.81	46.00
669.230	4.16	18.27	0.00	9.96	32.39	13.61	46.00
801.150	4.84	19.20	0.00	7.15	31.20	14.80	46.00

**Vertical:**

* 132.820	1.40	10.55	0.00	20.32	32.27	11.23	43.50
446.130	3.01	17.05	0.00	9.18	29.24	16.76	46.00
545.070	3.52	18.61	0.00	5.35	27.48	18.52	46.00
605.210	3.83	19.49	0.00	4.79	28.11	17.89	46.00
914.640	5.43	21.26	0.00	2.71	29.39	16.61	46.00
980.600	5.77	19.94	0.00	3.99	29.70	24.30	54.00

Note:

1. All Readings below 1GHz are Quasi-Peak, above are average value.
2. “ \* ”, means this data is the worst emission level.
3. Emission Level = Reading Level + Probe Factor + Cable Loss.

Product : Mini PCI Card  
 Test Item : General Radiated Emission Data  
 Test Site : No.3 OATS  
 Test Mode : Mode 1: Transmitter 11Mbps (Channel 6)

Frequency	Cable Loss	Probe Factor	PreAMP	Reading Level	Emission Level	Margin	Limit
MHz	dB	dB/m	dB	dBuV	dBuV/m	dB	dBuV/m
<b>Horizontal:</b>							
99.840	1.23	11.55	0.00	13.95	26.73	16.77	43.50
* 133.790	1.40	11.39	0.00	22.55	35.34	8.16	43.50
500.450	3.29	16.26	0.00	12.38	31.93	14.07	46.00
669.230	4.16	18.27	0.00	9.60	32.03	13.97	46.00
701.240	4.33	18.10	0.00	12.29	34.72	11.28	46.00
987.390	5.80	20.60	0.00	3.61	30.02	23.98	54.00
<b>Vertical:</b>							
* 132.820	1.40	10.55	0.00	19.87	31.82	11.68	43.50
364.650	2.59	14.64	0.00	10.13	27.37	18.63	46.00
446.130	3.01	17.05	0.00	7.59	27.65	18.35	46.00
656.620	4.10	17.65	0.00	6.56	28.31	17.69	46.00
757.500	4.62	20.38	0.00	3.48	28.48	17.52	46.00
937.920	5.55	21.15	0.00	2.08	28.78	17.22	46.00

Note:

1. All Readings below 1GHz are Quasi-Peak, above are average value.
2. “ \* ”, means this data is the worst emission level.
3. Emission Level = Reading Level + Probe Factor + Cable Loss.

Product : Mini PCI Card  
 Test Item : General Radiated Emission Data  
 Test Site : No.3 OATS  
 Test Mode : Mode 1: Transmitter 11Mbps (Channel 11)

Frequency	Cable Loss	Probe Factor	PreAMP	Reading Level	Emission Level	Margin	Limit
MHz	dB	dB/m	dB	dBuV	dBuV/m	dB	dBuV/m

**Horizontal:**

99.840	1.23	11.55	0.00	14.99	27.77	15.73	43.50
* 133.790	1.40	11.39	0.00	23.77	36.56	6.94	43.50
446.130	3.01	16.16	0.00	11.99	31.17	14.83	46.00
543.130	3.51	17.80	0.00	10.75	32.06	13.94	46.00
577.080	3.69	17.62	0.00	13.54	34.85	11.15	46.00
601.330	3.81	17.66	0.00	11.16	32.63	13.37	46.00

**Vertical:**

* 133.790	1.40	10.49	0.00	19.75	31.65	11.85	43.50
543.130	3.51	18.49	0.00	9.46	31.46	14.54	46.00
577.080	3.69	19.37	0.00	8.37	31.43	14.57	46.00
613.940	3.88	19.33	0.00	9.55	32.76	13.24	46.00
701.240	4.33	18.30	0.00	6.74	29.37	16.63	46.00
945.680	5.59	20.98	0.00	3.48	30.05	15.95	46.00

Note:

1. All Readings below 1GHz are Quasi-Peak, above are average value.
2. “ \* ”, means this data is the worst emission level.
3. Emission Level = Reading Level + Probe Factor + Cable Loss.

Product : Mini PCI Card  
 Test Item : General Radiated Emission Data  
 Test Site : No.3 OATS  
 Test Mode : Mode 1: Transmitter 54Mbps (Channel 1)

Frequency	Cable Loss	Probe Factor	PreAMP	Reading Level	Emission Level	Margin	Limit
MHz	dB	dB/m	dB	dBuV	dBuV/m	dB	dBuV/m

**Horizontal:**

100.810	1.23	11.33	0.00	13.75	26.31	17.19	43.50
* 133.790	1.40	11.39	0.00	21.65	34.44	9.06	43.50
400.540	2.78	14.85	0.00	13.70	31.33	14.67	46.00
577.080	3.69	17.62	0.00	10.08	31.39	14.61	46.00
611.030	3.86	18.12	0.00	10.59	32.57	13.43	46.00
669.230	4.16	18.27	0.00	9.37	31.80	14.20	46.00

**Vertical:**

99.840	1.23	9.76	0.00	14.62	25.61	17.89	43.50
* 132.820	1.40	10.55	0.00	18.65	30.60	12.90	43.50
298.690	2.25	12.14	0.00	14.90	29.30	16.70	46.00
475.230	3.16	16.56	0.00	9.13	28.85	17.15	46.00
577.080	3.69	19.37	0.00	8.00	31.06	14.94	46.00
669.230	4.16	17.66	0.00	9.39	31.21	14.79	46.00

Note:

1. All Readings below 1GHz are Quasi-Peak, above are average value.
2. “ \* ”, means this data is the worst emission level.
3. Emission Level = Reading Level + Probe Factor + Cable Loss.

Product : Mini PCI Card  
 Test Item : General Radiated Emission Data  
 Test Site : No.3 OATS  
 Test Mode : Mode 1: Transmitter 54Mbps (Channel 6)

Frequency	Cable Loss	Probe Factor	PreAMP	Reading Level	Emission Level	Margin	Limit
MHz	dB	dB/m	dB	dBuV	dBuV/m	dB	dBuV/m
<b>Horizontal:</b>							
99.840	1.23	11.55	0.00	13.34	26.12	17.38	43.50
* 133.790	1.40	11.39	0.00	21.95	34.74	8.76	43.50
401.510	2.78	14.76	0.00	13.50	31.05	14.95	46.00
601.330	3.81	17.66	0.00	11.60	33.07	12.93	46.00
669.230	4.16	18.27	0.00	12.03	34.46	11.54	46.00
696.390	4.30	18.48	0.00	10.42	33.20	12.80	46.00
<b>Vertical:</b>							
133.790	1.40	10.49	0.00	16.06	27.96	15.54	43.50
300.630	2.26	12.06	0.00	13.01	27.33	18.67	46.00
390.630	2.73	15.45	0.00	9.15	27.33	18.67	46.00
* 577.080	3.69	19.37	0.00	9.34	32.40	13.60	46.00
613.940	3.88	19.33	0.00	8.99	32.20	13.80	46.00
669.230	4.16	17.66	0.00	10.09	31.91	14.09	46.00

Note:

1. All Readings below 1GHz are Quasi-Peak, above are average value.
2. “ \* ”, means this data is the worst emission level.
3. Emission Level = Reading Level + Probe Factor + Cable Loss.

Product : Mini PCI Card  
 Test Item : General Radiated Emission Data  
 Test Site : No.3 OATS  
 Test Mode : Mode 1: Transmitter 54Mbps (Channel 11)

Frequency	Cable Loss	Probe Factor	PreAMP	Reading Level	Emission Level	Margin	Limit
MHz	dB	dB/m	dB	dBuV	dBuV/m	dB	dBuV/m

**Horizontal:**

99.840	1.23	11.55	0.00	13.56	26.34	17.16	43.50
* 132.820	1.40	11.49	0.00	22.09	34.98	8.52	43.50
389.870	2.72	14.12	0.00	13.53	30.37	15.63	46.00
543.130	3.51	17.80	0.00	9.91	31.22	14.78	46.00
611.030	3.86	18.12	0.00	11.10	33.08	12.92	46.00
669.230	4.16	18.27	0.00	10.39	32.82	13.18	46.00

**Vertical:**

133.790	1.40	10.49	0.00	15.62	27.52	15.98	43.50
390.840	2.73	15.45	0.00	11.02	29.20	16.80	46.00
543.130	3.51	18.49	0.00	7.87	29.87	16.13	46.00
577.080	3.69	19.37	0.00	7.91	30.97	15.03	46.00
* 613.940	3.88	19.33	0.00	8.66	31.87	14.13	46.00
669.230	4.16	17.66	0.00	9.49	31.31	14.69	46.00

Note:

1. All Readings below 1GHz are Quasi-Peak, above are average value.
2. “ \* ”, means this data is the worst emission level.
3. Emission Level = Reading Level + Probe Factor + Cable Loss.

## 5. Band Edge

### 5.1. Test Equipment

The following test equipments are used during the band edge tests:

Equipment	Manufacturer	Model No./Serial No.	Last Cal.
X Spectrum Analyzer	Advantest	R3272 / 72421194	May, 2004
X Test Receiver	R & S	ESCS 30 / 825442/14	May, 2004
X Spectrum Analyzer	Advantest	R3261C / 71720140	May, 2004
X Pre-Amplifier	HP	8447D/3307A01812	May, 2004
X Bilog Antenna	Chase	CBL6112B / 12452	Sep., 2003
X Horn Antenna	EM	EM6917 / 103325	May, 2004

- Note: 1. All equipments that need to calibrate are with calibration period of 1 year.  
 2. Mark "X" test instruments are used to measure the final test results.

### 5.2. Test Setup

#### RF Conducted Measurement:

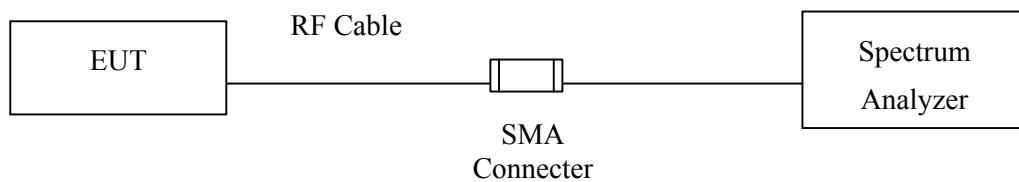

#### RF Radiated Measurement:

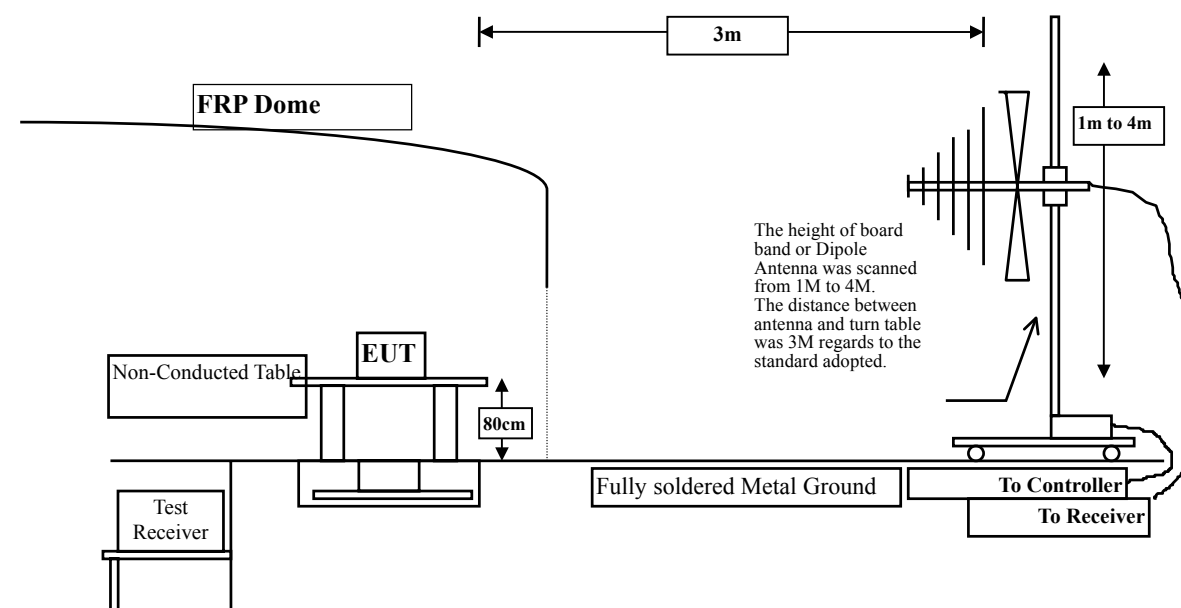



### 5.3. Limits

In any 100 kHz bandwidth outside the frequency band in which the spread spectrum intentional radiator is operating, the radio frequency power that is produced by the intentional radiator shall be at least 20 dB below that in the 100 kHz bandwidth within the band that contains the highest level of the desired power, based on either an RF conducted or a radiated measurement. Attenuation below the general limits specified in Section 15.209(a) is not required. In addition, radiated emissions which fall in the restricted bands, as defined in Section 15.205(a), must also comply with the radiated emission limits specified in Section 15.209(a) (see Section 15.205(c)).

### 5.4. Test Procedure

The EUT and its simulators are placed on a turn table which is 0.8 meter above ground. The turn table can rotate 360 degrees to determine the position of the maximum emission level. The EUT was positioned such that the distance from antenna to the EUT was 3 meters.

The antenna can move up and down between 1 meter and 4 meters to find out the maximum emission level.

Both horizontal and vertical polarization of the antenna are set on measurement. In order to find the maximum emission, all of the interface cables must be manipulated according to ANSI C63.4: 2001 on radiated measurement.

The bandwidth below 1GHz setting on the field strength meter (R&S Test Receiver ESCS 30 )is 120 kHz, above 1GHz are 1 MHz.

### 5.5. Uncertainty

The measurement uncertainty is defined as  $\pm 1$  MHz

### 5.6. Test Result of Band Edge

Product : Mini PCI Card  
 Test Item : Band Edge Data  
 Test Site : No.3 OATS  
 Test Mode : Mode 1: Transmitter 11Mbps

#### RF Radiated Measurement:

Channel No.	Frequency (MHz)	Required Limit (dBc)	Result
1 (Horizontal)	<2400	>20	Pass
1 (Vertical)	<2400	>20	Pass

Figure Channel 1: (Horizontal)

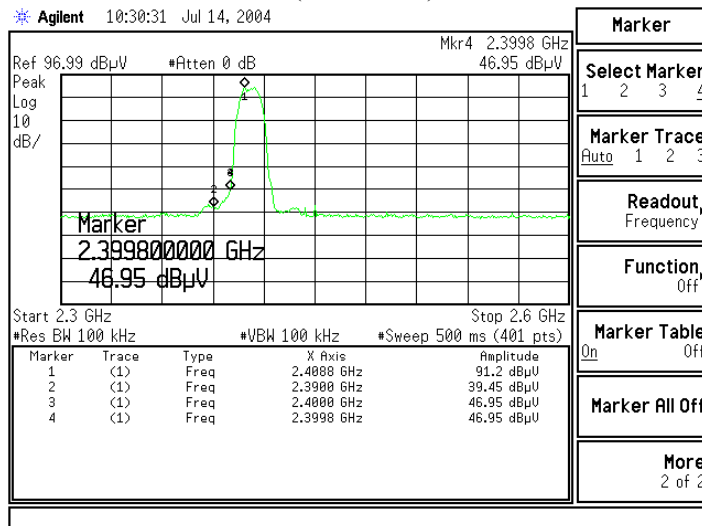
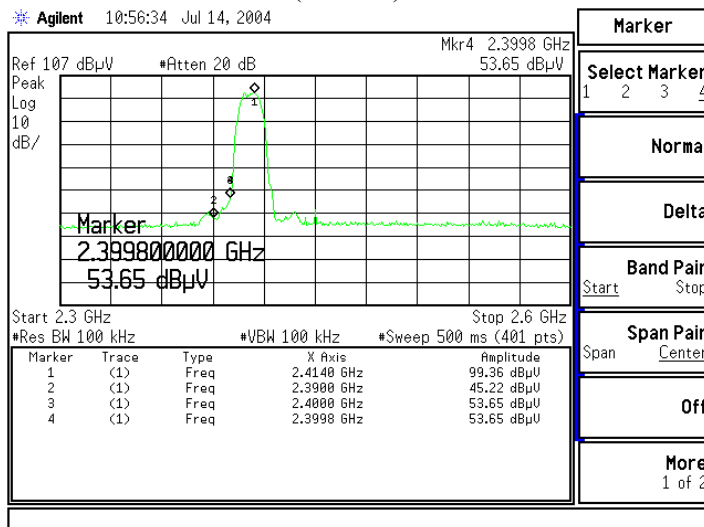

Figure Channel 1: (Vertical)



Product : Mini PCI Card  
 Test Item : Band Edge Data  
 Test Site : No.3 OATS  
 Test Mode : Mode 1: Transmitter 11Mbps

**RF Radiated Measurement (Peak):**

Channel No.	Frequency (MHz)	Reading Level (dBuV)	Emission Level (dBuV/m)	Peak Limit (dBuV/m)	Average Limit (dBuV/m)	Result
11(Horizontal)	2492.800	57.09	52.54	74.00	54.00	Pass
11(Vertical)	2486.800	58.27	53.72	74.00	54.00	Pass

**RF Radiated Measurement (Average):**

Channel No.	Frequency (MHz)	Reading Level (dBuV)	Emission Level (dBuV/m)	Peak Limit (dBuV/m)	Average Limit (dBuV/m)	Result
11(Horizontal)	--	--	--	74.00	54.00	Pass
11(Vertical)	--	--	--	74.00	54.00	Pass

**Figure Channel 11:** (Horizontal)

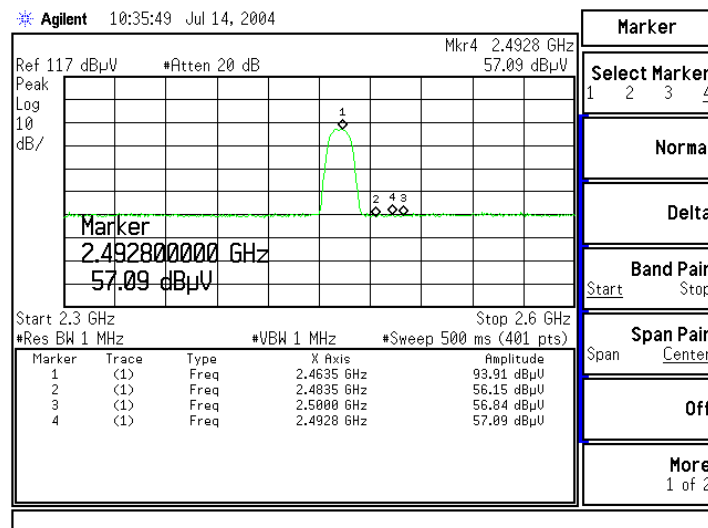

**Figure Channel 11:** (Vertical)

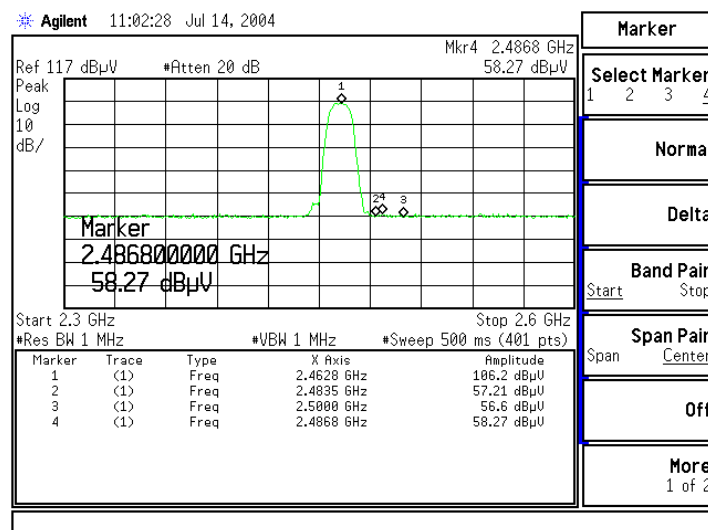

Product : Mini PCI Card  
 Test Item : Band Edge Data  
 Test Site : No.3 OATS  
 Test Mode : Mode 1: Transmitter 54Mbps

**RF Radiated Measurement:**

Channel No.	Frequency (MHz)	Required Limit (dBc)	Result
1 (Horizontal)	<2400	>20	Pass
1 (Vertical)	<2400	>20	Pass

**Figure Channel 1:** (Horizontal)

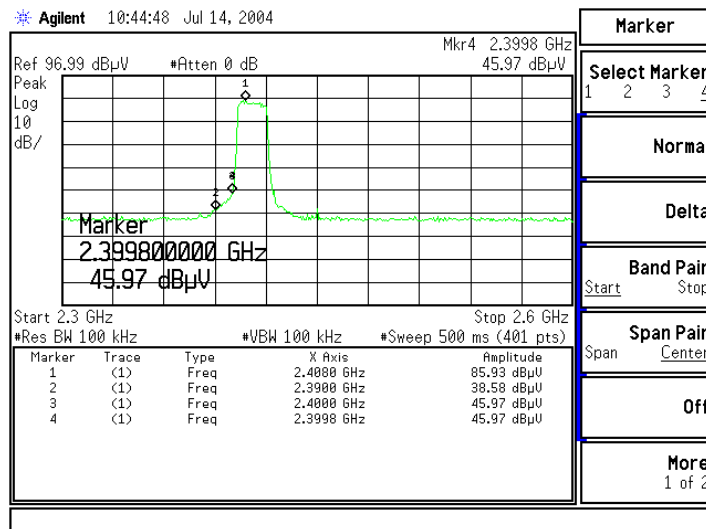

**Figure Channel 1:** (Vertical)

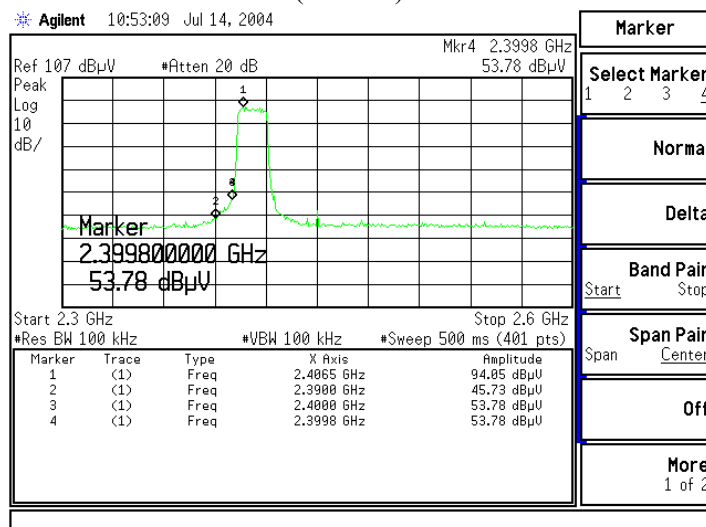

Product : Mini PCI Card  
 Test Item : Band Edge Data  
 Test Site : No.3 OATS  
 Test Mode : Mode 1: Transmitter 54Mbps

**RF Radiated Measurement (Peak):**

Channel No.	Frequency (MHz)	Reading Level (dBuV)	Emission Level (dBuV/m)	Peak Limit (dBuV/m)	Average Limit (dBuV/m)	Result
11(Horizontal)	2489.00	57.10	52.55	74.00	54.00	Pass
11(Vertical)	2485.300	58.57	54.02	74.00	54.00	Pass

**RF Radiated Measurement (Average):**

Channel No.	Frequency (MHz)	Reading Level (dBuV)	Emission Level (dBuV/m)	Peak Limit (dBuV/m)	Average Limit (dBuV/m)	Result
11(Horizontal)	--	--	--	74.00	54.00	Pass
11(Vertical)	2485.300	48.03	43.48	74.00	54.00	Pass

**Figure Channel 11:** (Horizontal)

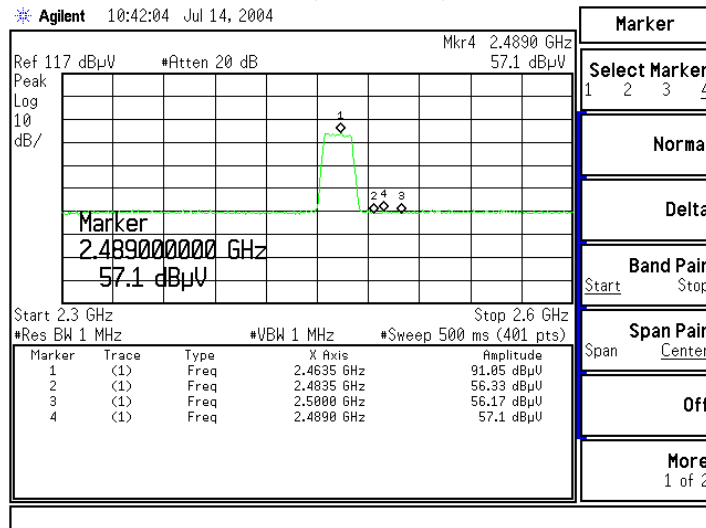

**Figure Channel 11:** (Vertical)

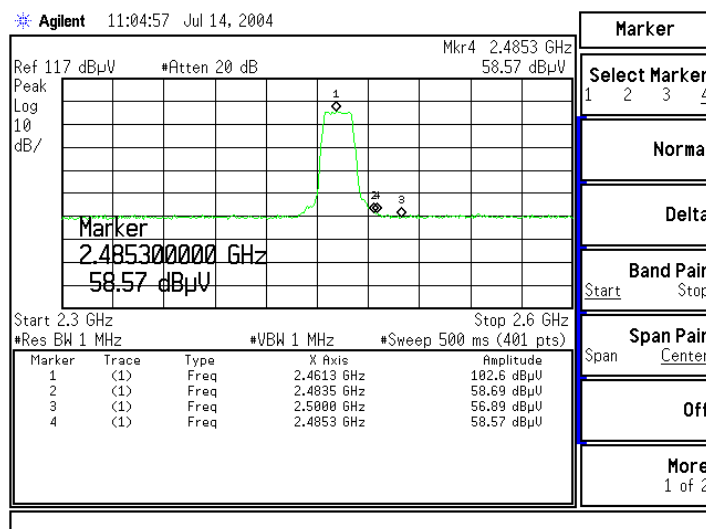

Note: The average measurement was not performed when the peak measured data under the limit of average detection. If the readings given are average, peak measurement should also be supplied.

## 6. Occupied Bandwidth

### 6.1. Test Equipment

The following test equipments are used during the radiated emission tests:

	Equipment	Manufacturer	Model No./Serial No.	Last Cal.
X	Spectrum Analyzer	Advantest	R3272 / 72421194	May, 2004

Note: 1. All equipment upon which need to calibrated are with calibration period of 1 year.  
 2. Mark "X" test instruments are used to measure the final test results.

### 6.2. Test Setup

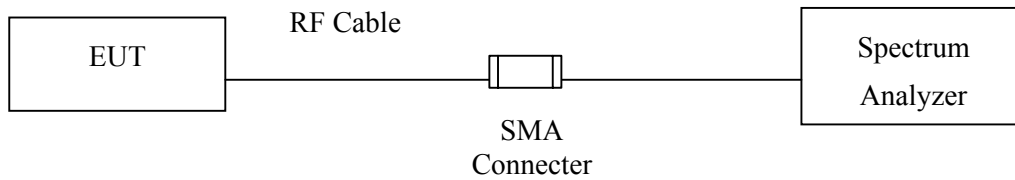

### 6.3. Limits

The minimum bandwidth shall be at least 500kHz.

### 6.4. Uncertainty

The measurement uncertainty is defined as  $\pm 1.27$  dB

### 6.5. Test Result of Occupied Bandwidth

Product : Mini PCI Card  
 Test Item : Occupied Bandwidth Data  
 Test Site : No.3 OATS  
 Test Mode : Transmitter 11Mbps (Channel 1)

Channel No.	Frequency (MHz)	Measurement Level (kHz)	Required Limit (kHz)	Result
1 (11Mbps)	2412.00	12150	>500	Pass

Figure Channel 1: 11Mbps

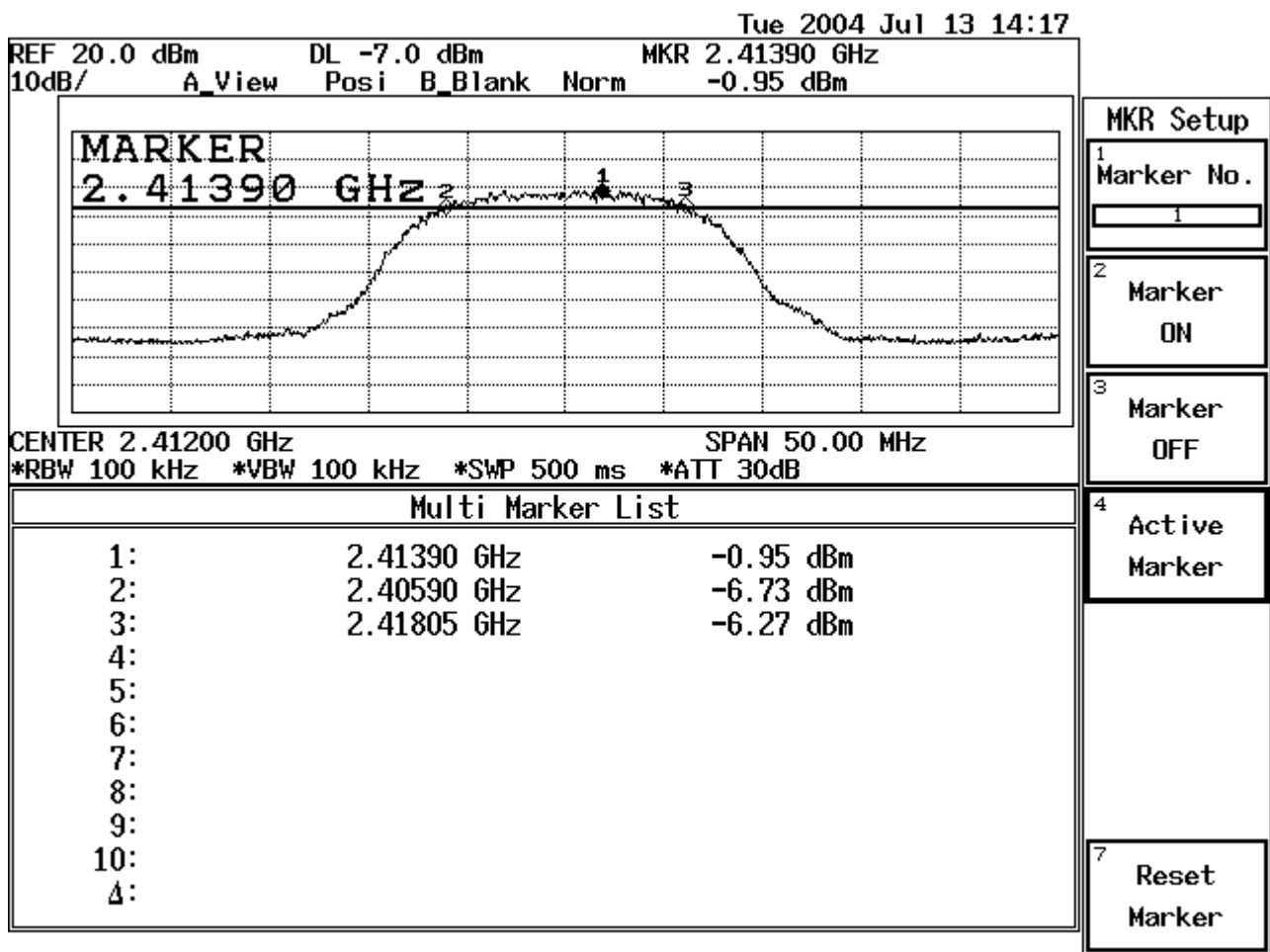

Product : Mini PCI Card  
 Test Item : Occupied Bandwidth Data  
 Test Site : No.3 OATS  
 Test Mode : Transmitter 11Mbps (Channel 6)

Channel No.	Frequency (MHz)	Measurement Level (kHz)	Required Limit (kHz)	Result
6 (11Mbps)	2437.00	12150	>500	Pass

Figure Channel 6: 11Mbps

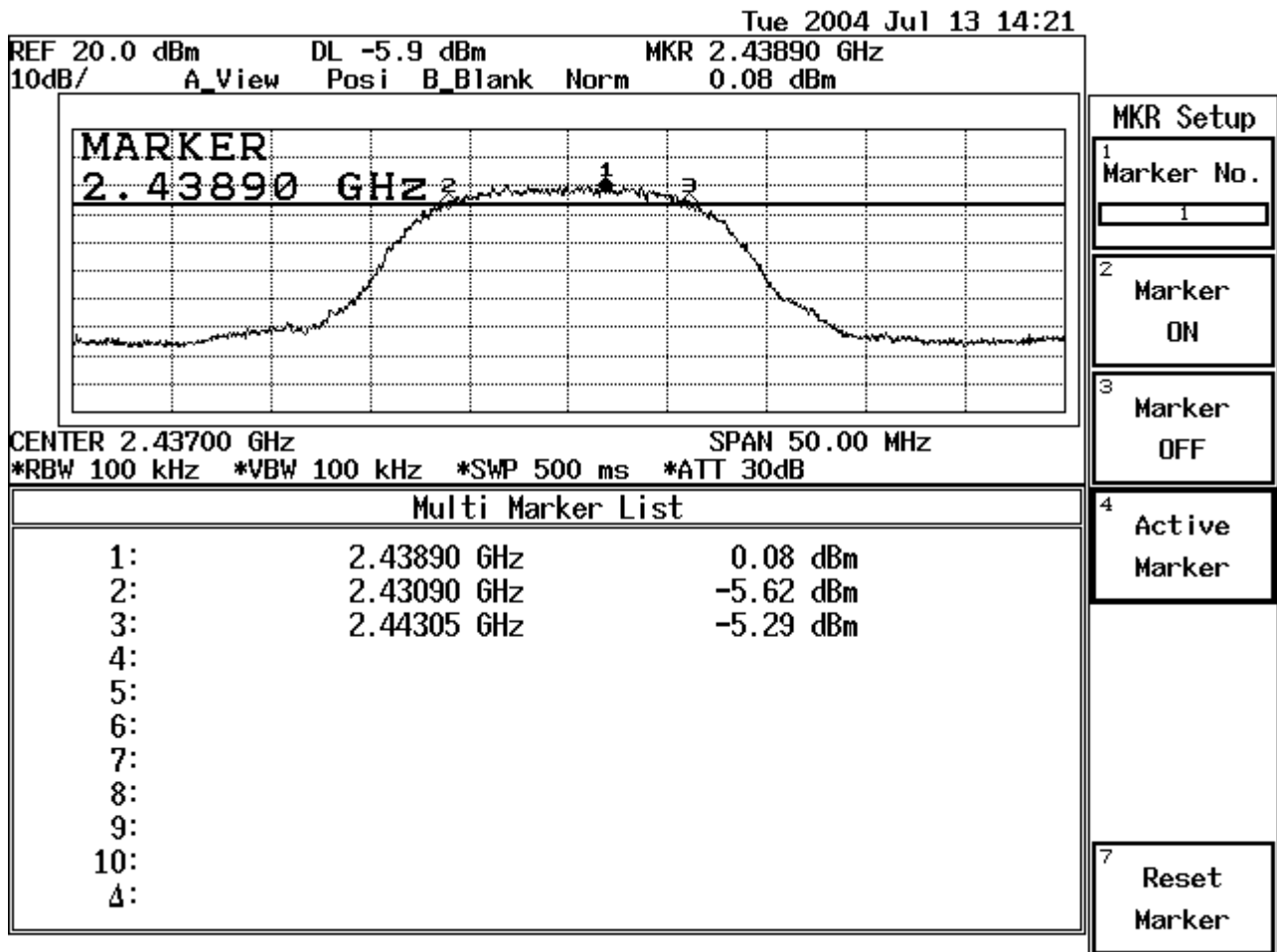



Product : Mini PCI Card  
 Test Item : Occupied Bandwidth Data  
 Test Site : No.3 OATS  
 Test Mode : Transmitter 11Mbps (Channel 11)

Channel No.	Frequency (MHz)	Measurement Level (kHz)	Required Limit (kHz)	Result
11 (11Mbps)	2462	11900	>500	Pass

**Figure Channel 11:** 11Mbps

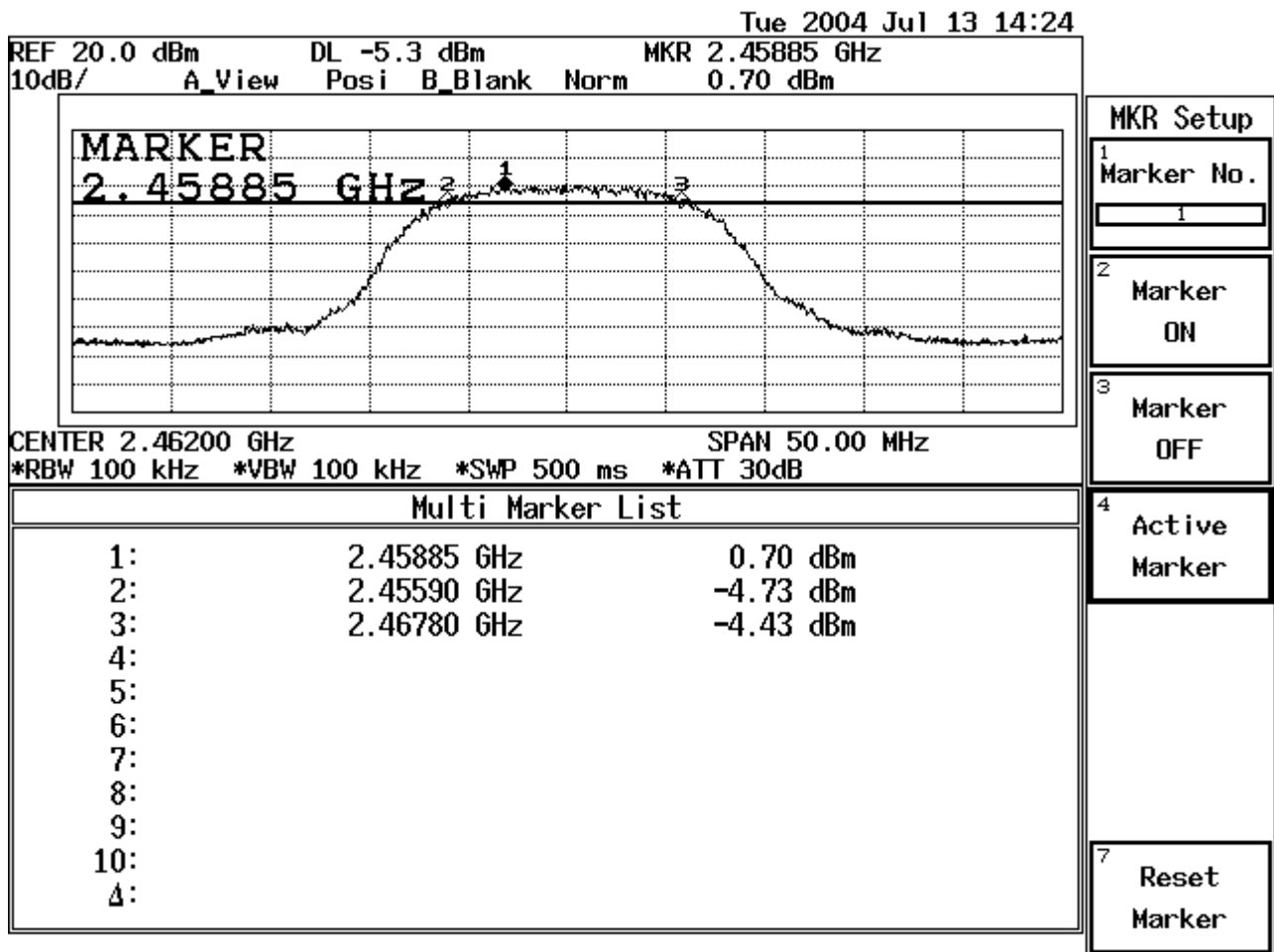

Product : Mini PCI Card  
 Test Item : Occupied Bandwidth Data  
 Test Site : No.3 OATS  
 Test Mode : Transmitter 54Mbps (Channel 1)

Channel No.	Frequency (MHz)	Measurement Level (kHz)	Required Limit (kHz)	Result
1 (54Mbps)	2412	16500	>500	Pass

**Figure Channel 1:** 54Mbps

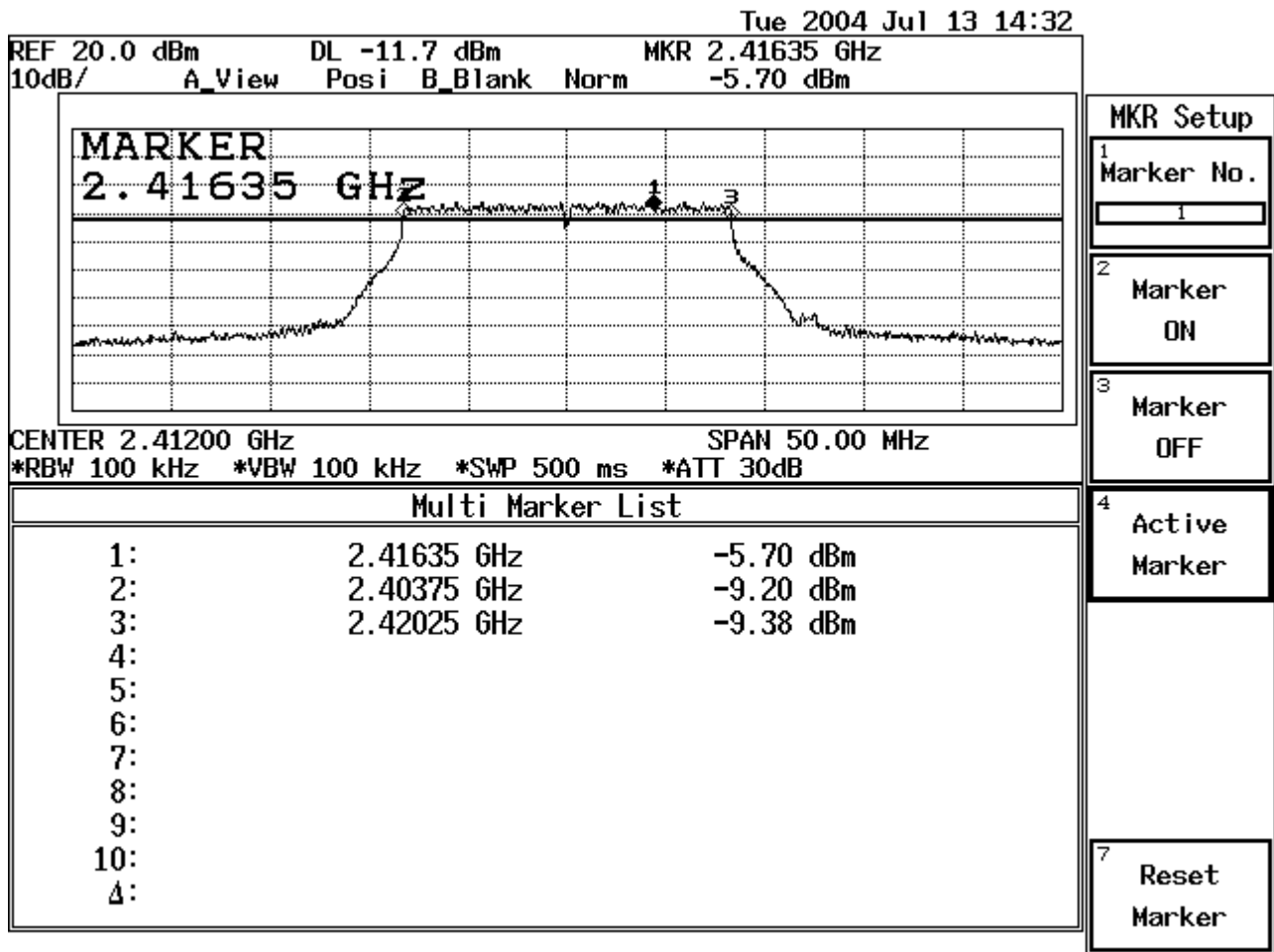

Product : Mini PCI Card  
 Test Item : Occupied Bandwidth Data  
 Test Site : No.3 OATS  
 Test Mode : Transmitter 54Mbps (Channel 06)

Channel No.	Frequency (MHz)	Measurement Level (kHz)	Required Limit (kHz)	Result
6 (54Mbps)	2437	16500	>500	Pass

Figure Channel 6: 54Mbps

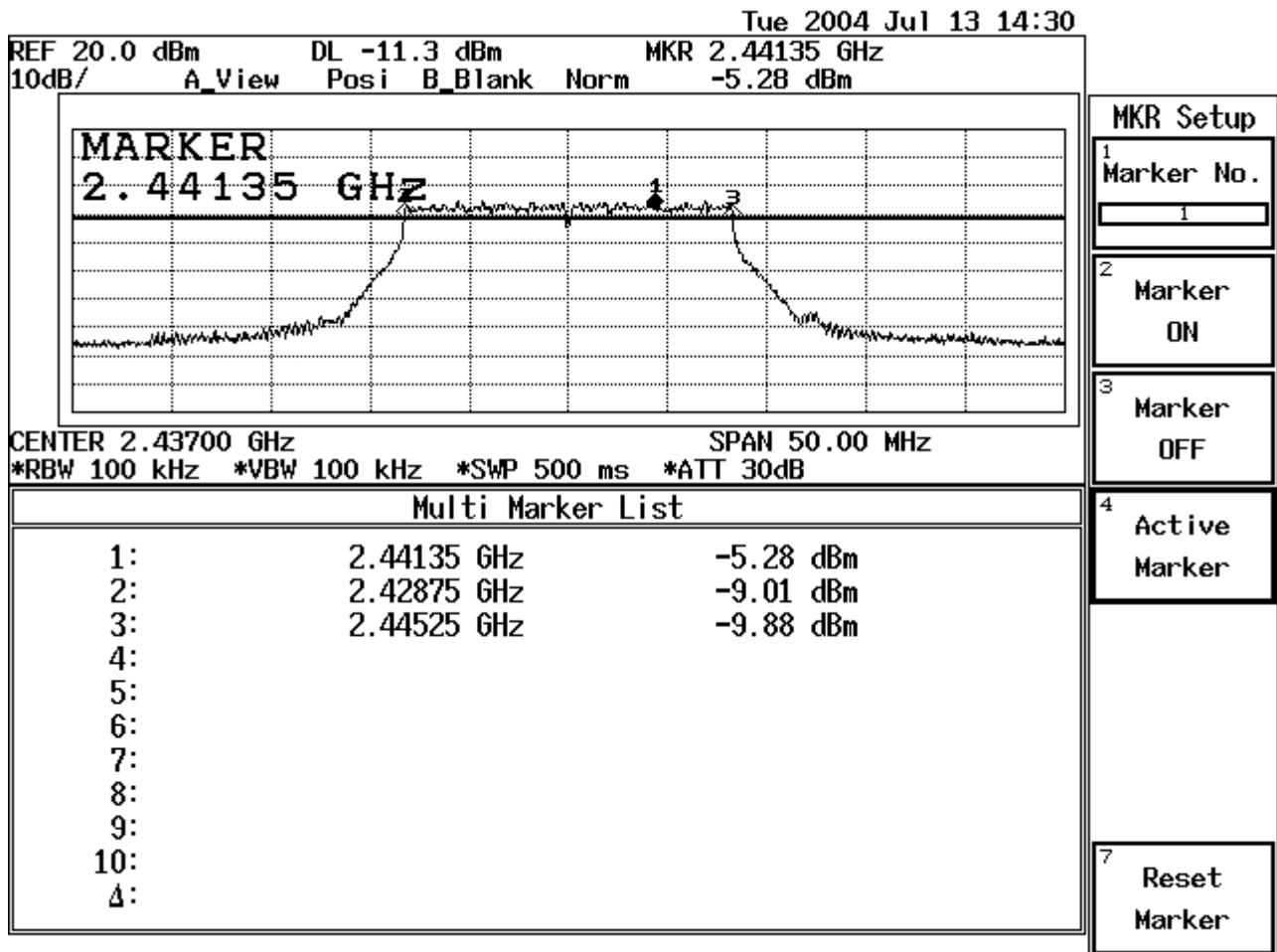

Product : Mini PCI Card  
 Test Item : Occupied Bandwidth Data  
 Test Site : No.3 OATS  
 Test Mode : Transmitter 54Mbps (Channel 11)

Channel No.	Frequency (MHz)	Measurement Level (kHz)	Required Limit (kHz)	Result
11 (54Mbps)	2462	16550	>500	Pass

**Figure Channel 11:** 54Mbps

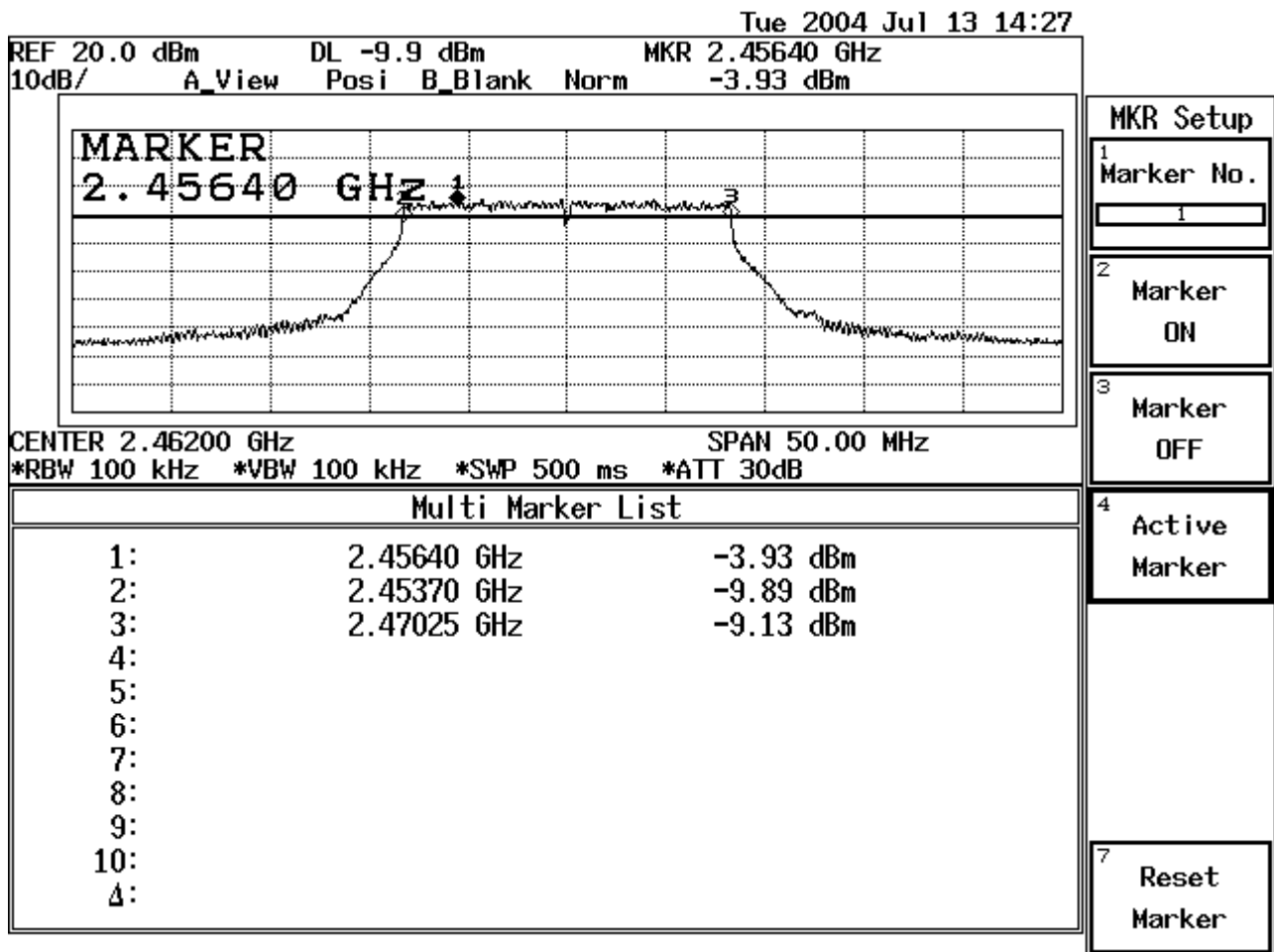

**7. Power Density**

**7.1. Test Equipment**

The following test equipments are used during the radiated emission tests:

	Equipment	Manufacturer	Model No./Serial No.	Last Cal.
X	Spectrum Analyzer	Advantest	R3272 / 72421194	May, 2004

Note: 1. All equipment upon which need to calibrated are with calibration period of 1 year.  
 2. Mark "X" test instruments are used to measure the final test results.

**7.2. Test Setup**

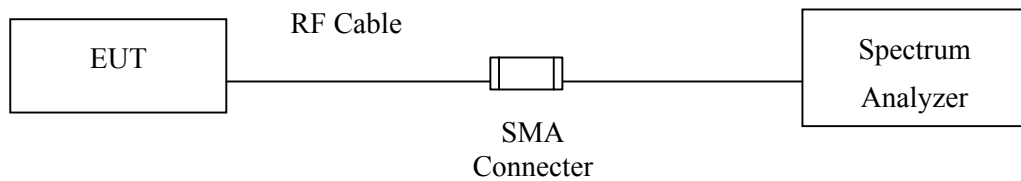

**7.3. Limits**

The transmitted power density averaged over any 1 second interval shall not be greater +8dBm in any 3kHz bandwidth.

**7.4. Uncertainty**

The measurement uncertainty is defined as  $\pm 1.27$  dB

### 7.5. Test Result of Power Density

Product : Mini PCI Card  
 Test Item : Power Density Data  
 Test Site : No.3 OATS  
 Test Mode : Transmitter 11Mbps (Channel 1)

Channel No.	Frequency (MHz)	Measure Level (dBm)	Limit (dBm)	Result
1 (11Mbps)	2412	-11.09	< 8dBm	Pass

**Figure Channel 1:** 11Mbps

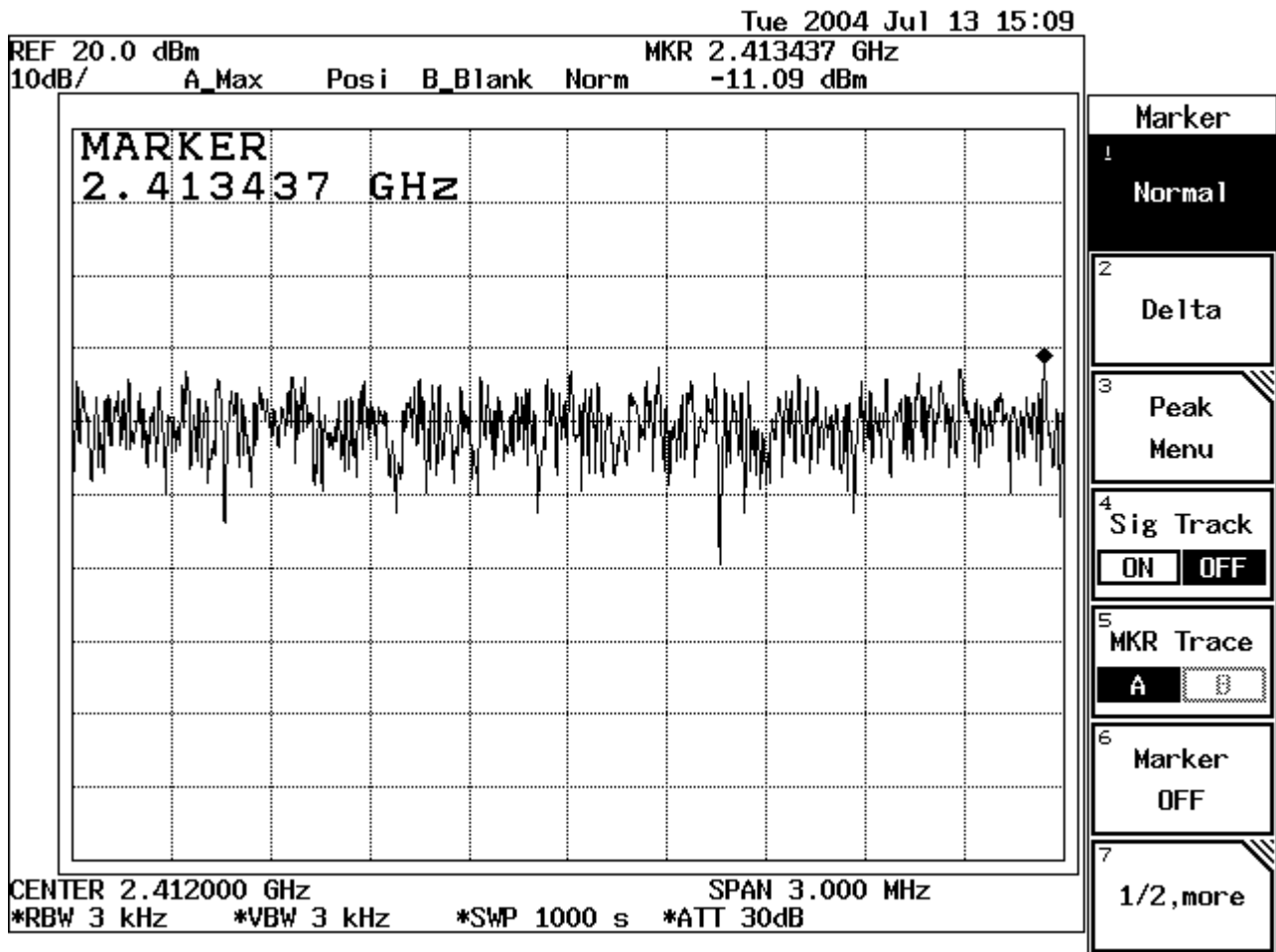

Product : Mini PCI Card  
 Test Item : Power Density Data  
 Test Site : No.3OATS  
 Test Mode : Transmitter 11Mbps (Channel 6)

Channel No.	Frequency (MHz)	Measurement Level (dBm)	Required Limit (dBm)	Result
6 (11Mbps)	2437.000	-10.70	< 8dBm	Pass

**Figure Channel 6:** 11Mbps

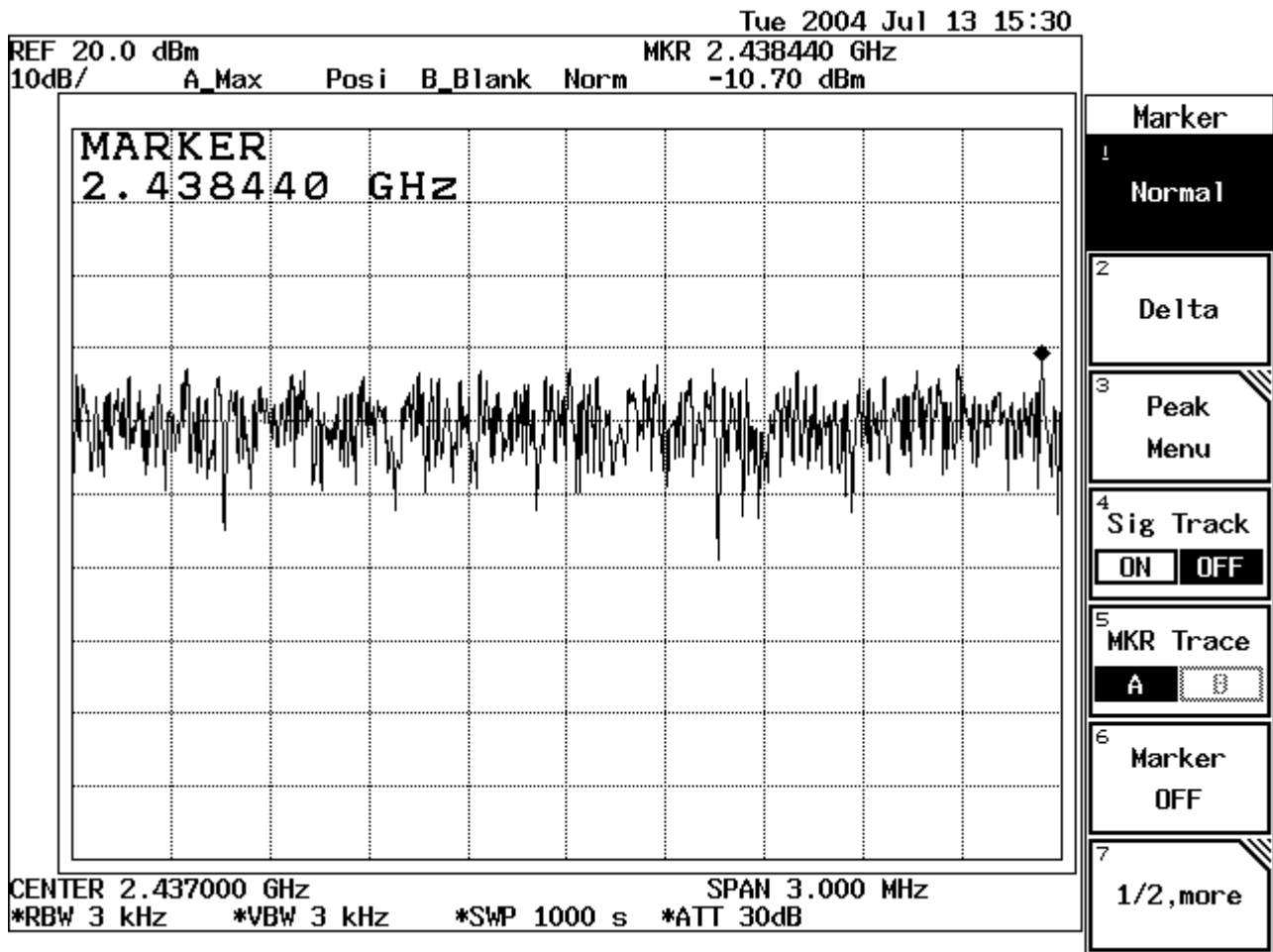

Product : Mini PCI Card  
 Test Item : Density Data  
 Test Site : No.3 OATS  
 Test Mode : Transmitter 11Mbps (Channel 11)

Channel No.	Frequency (MHz)	Measurement Level (dBm)	Required Limit (dBm)	Result
11 (11Mbps)	2462	-10.86	< 8dBm	Pass

**Figure Channel 11:** 11Mbps

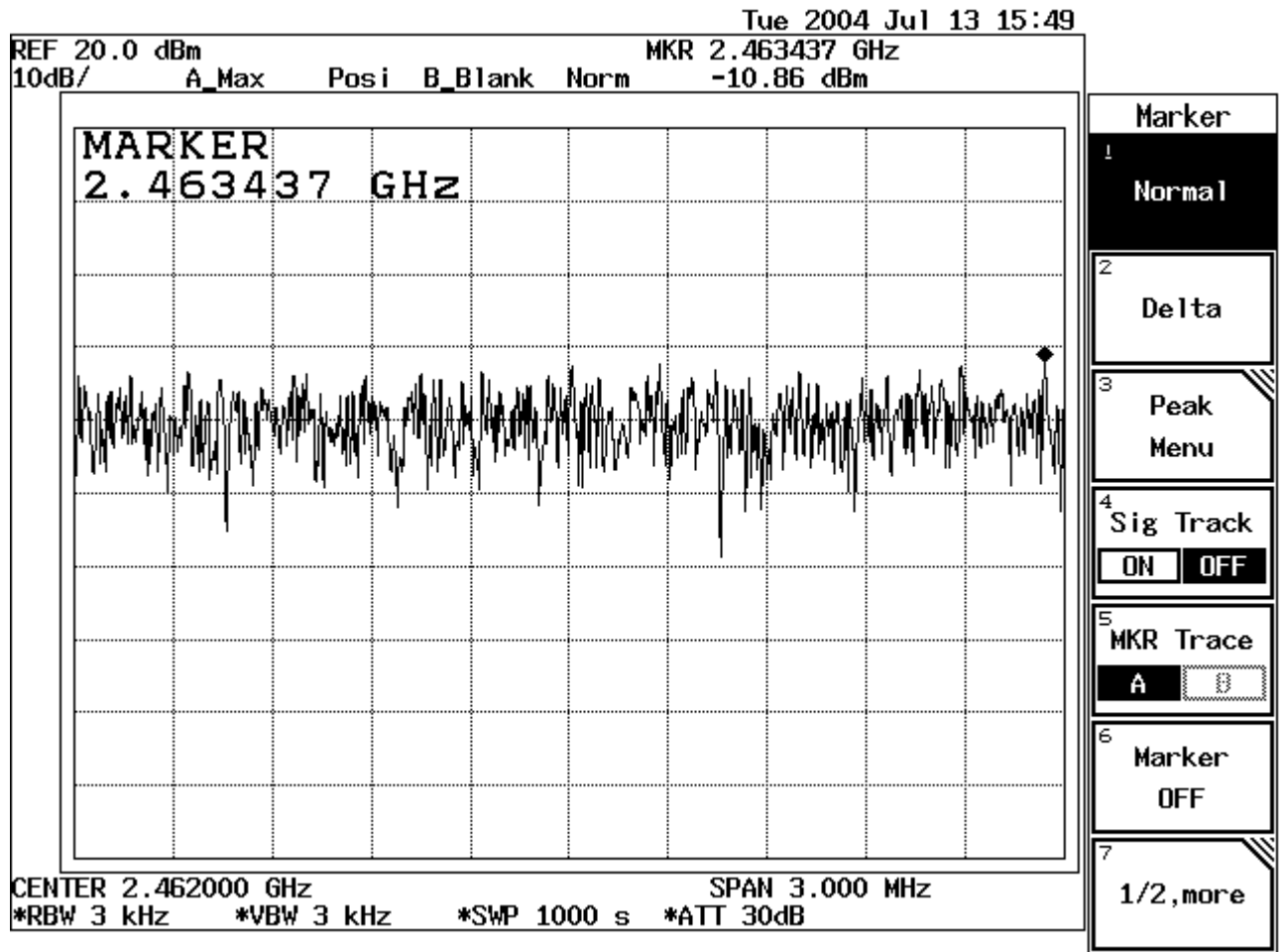



Product : Mini PCI Card  
 Test Item : Power Density Data  
 Test Site : No.3 OATS  
 Test Mode : Transmitter 54Mbps (Channel 1)

Channel No.	Frequency (MHz)	Measure Level (dBm)	Limit (dBm)	Result
1 (54Mbps)	2412	-18.39	< 8dBm	Pass

**Figure Channel 1:** 54Mbps

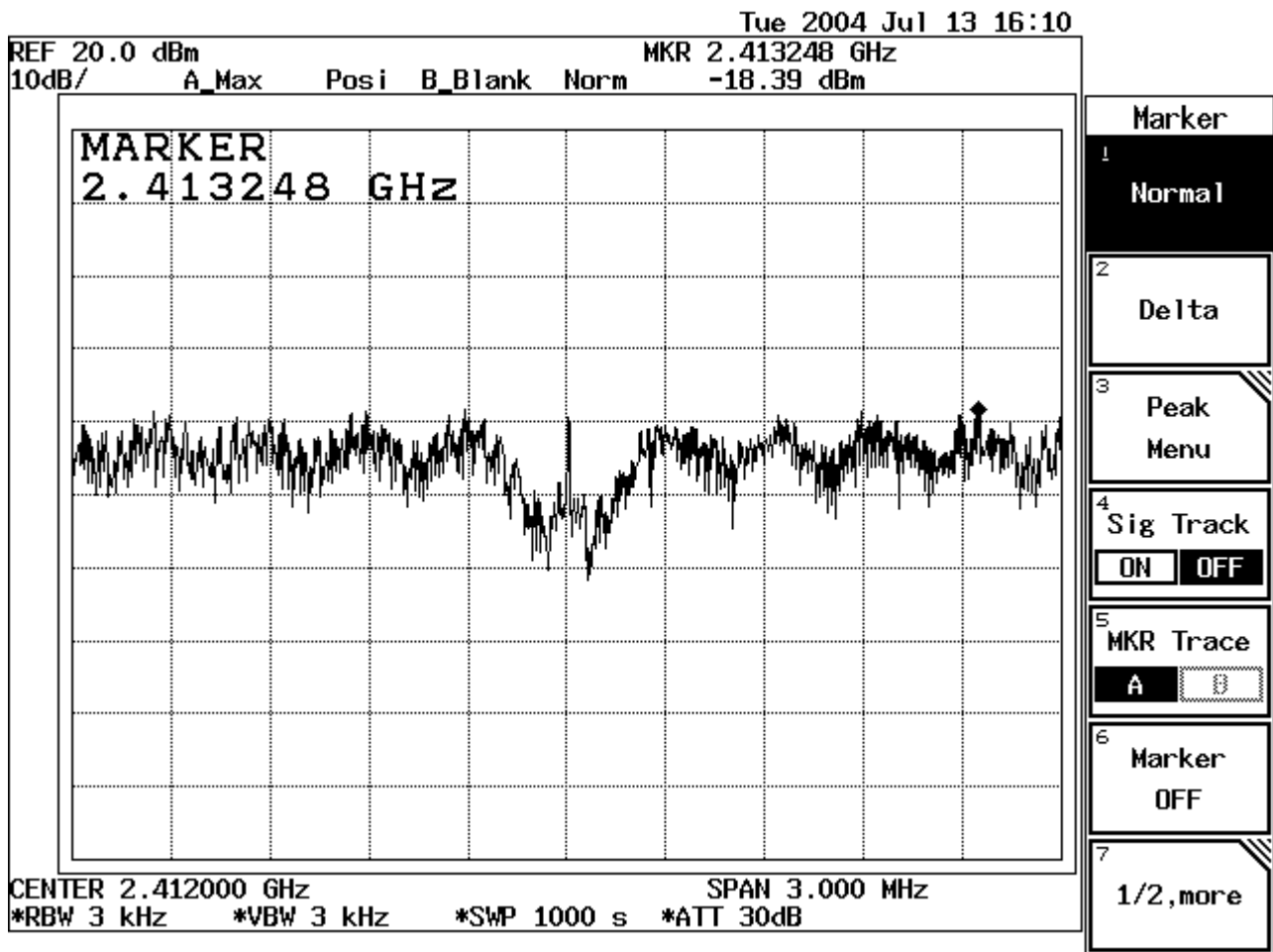

Product : Mini PCI Card  
 Test Item : Power Density Data  
 Test Site : No.3OATS  
 Test Mode : Transmitter 54Mbps (Channel 6)

Channel No.	Frequency (MHz)	Measurement Level (dBm)	Required Limit (dBm)	Result
6 (54Mbps)	2437	-17.46	< 8dBm	Pass

**Figure Channel 6:** 54Mbps

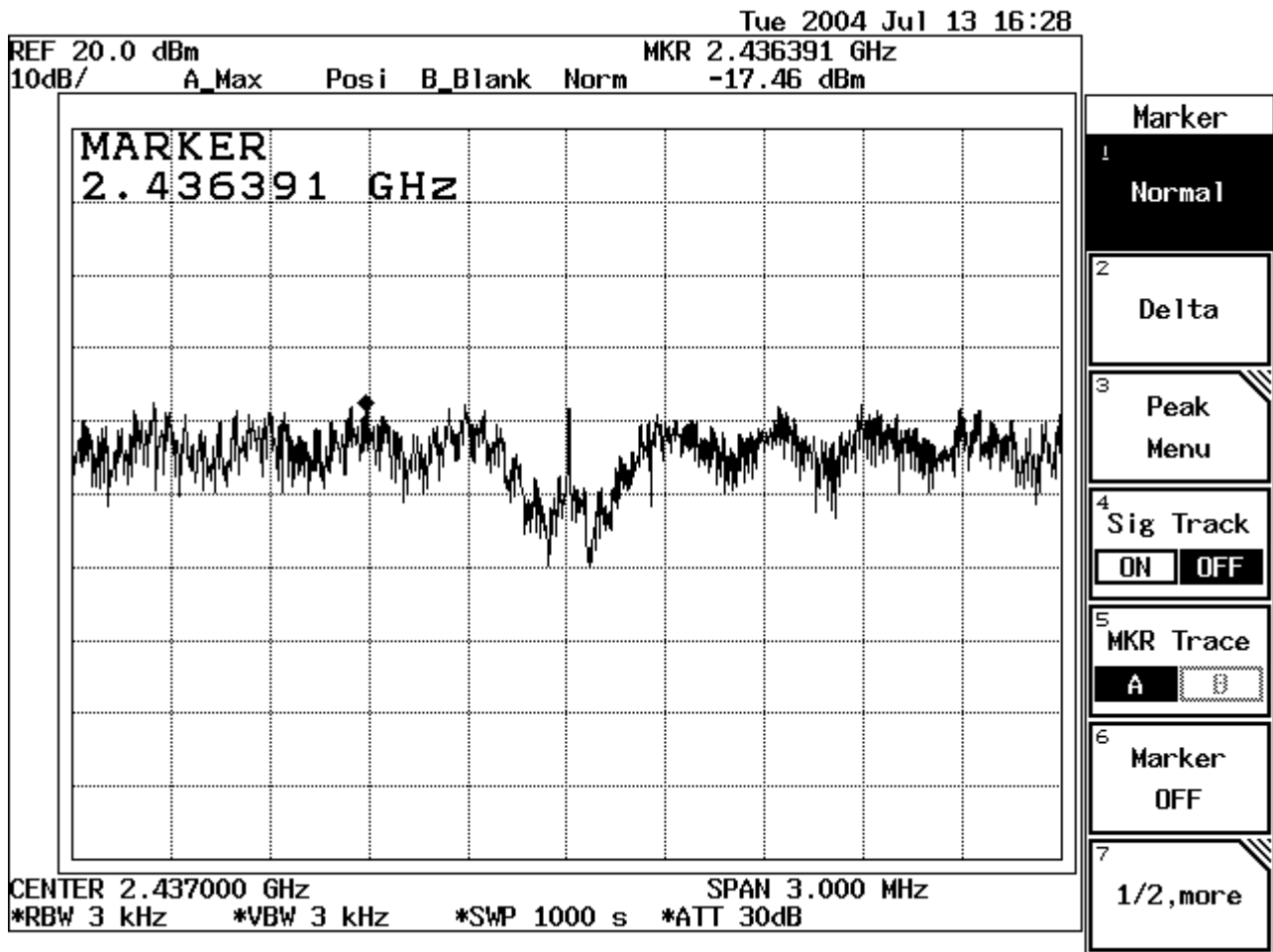

Product : Mini PCI Card  
 Test Item : Density Data  
 Test Site : No.3 OATS  
 Test Mode : Transmitter 54Mbps (Channel 11)

Channel No.	Frequency (MHz)	Measurement Level (dBm)	Required Limit (dBm)	Result
11 (54Mbps)	2462	-17.38	< 8dBm	Pass

**Figure Channel 11:** 54Mbps

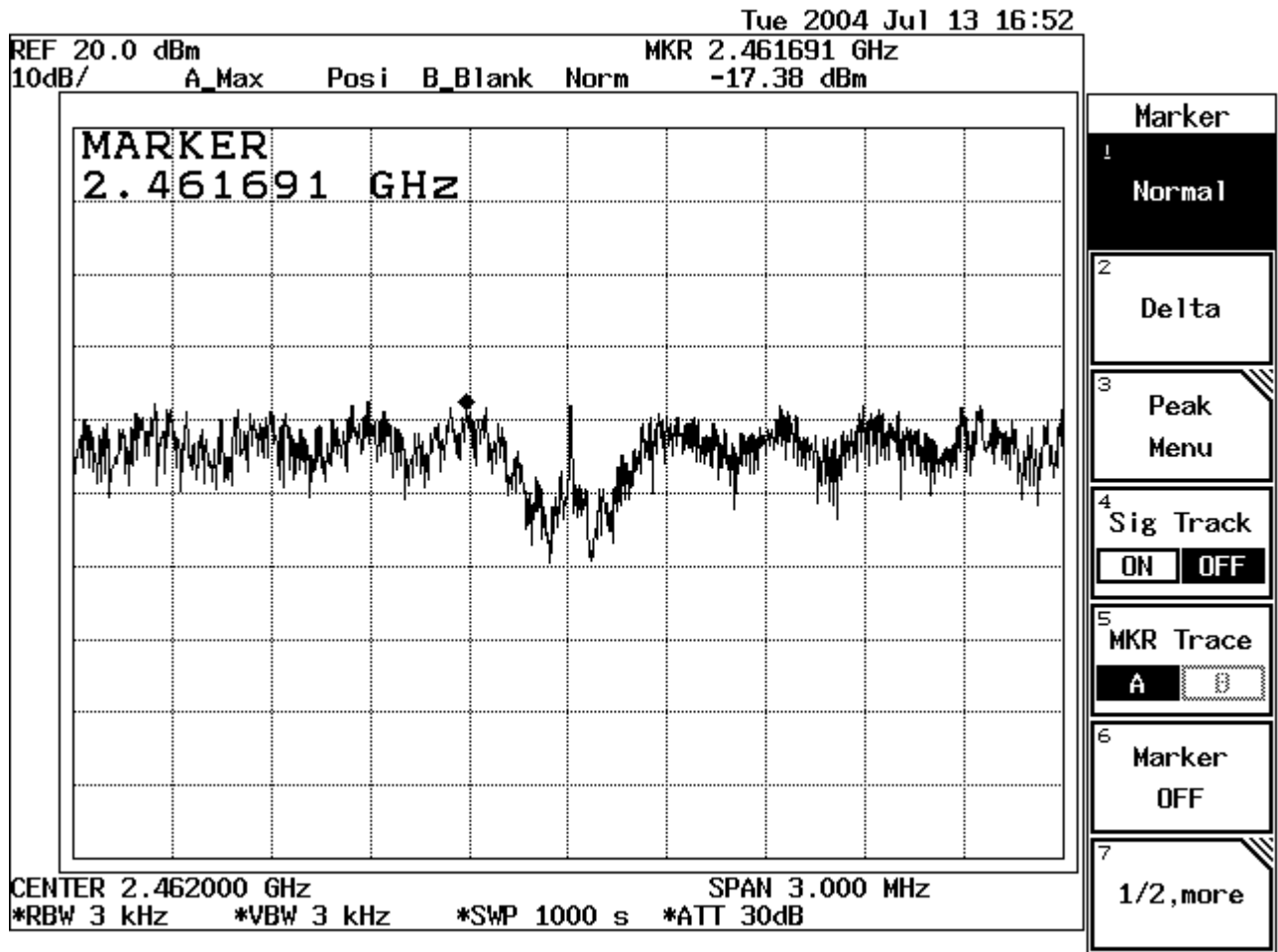

## 8. EMI Reduction Method During Compliance Testing

No modification was made during testing.

## Attachment 1: EUT Test Photographs

**Attachment 1: EUT Test Setup Photographs**

Front View of Conducted Test



Back View of Conducted Test



Front View of Radiated Test

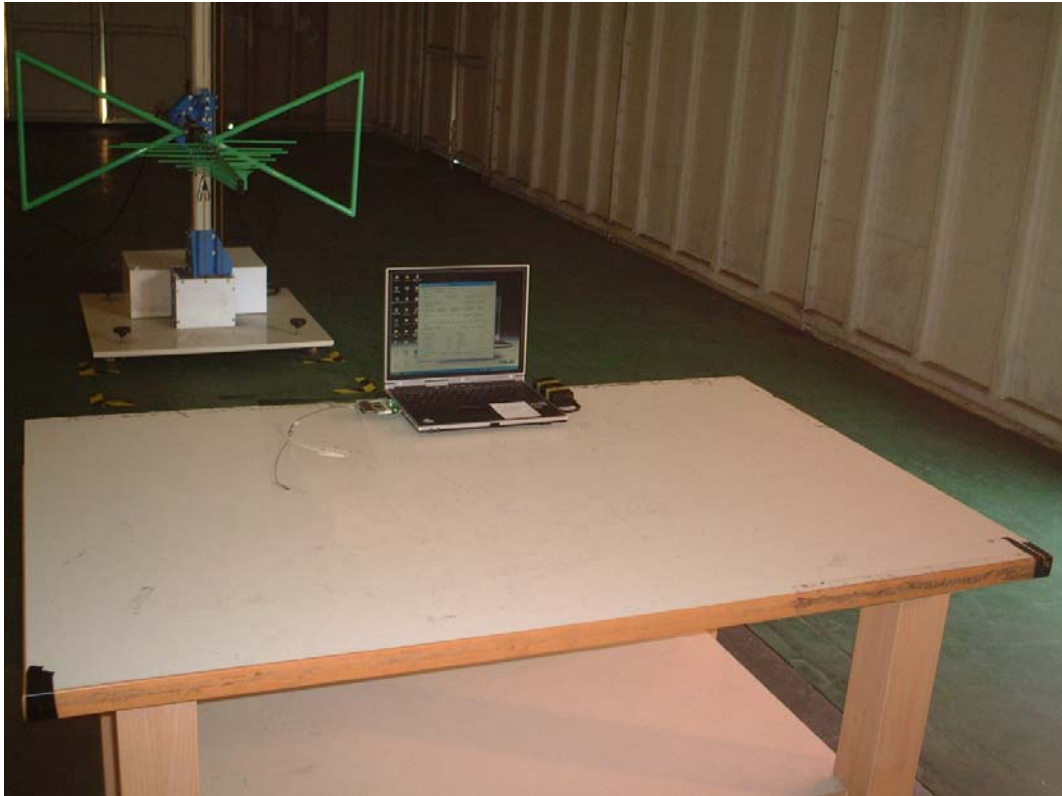

Back View of Radiated Test



Front View of Radiated Test (Horn)



Back View of Radiated Test (Horn)





## Attachment 2: EUT Detailed Photographs

## Attachment 2 : EUT Detailed Photographs

(1) EUT Photo

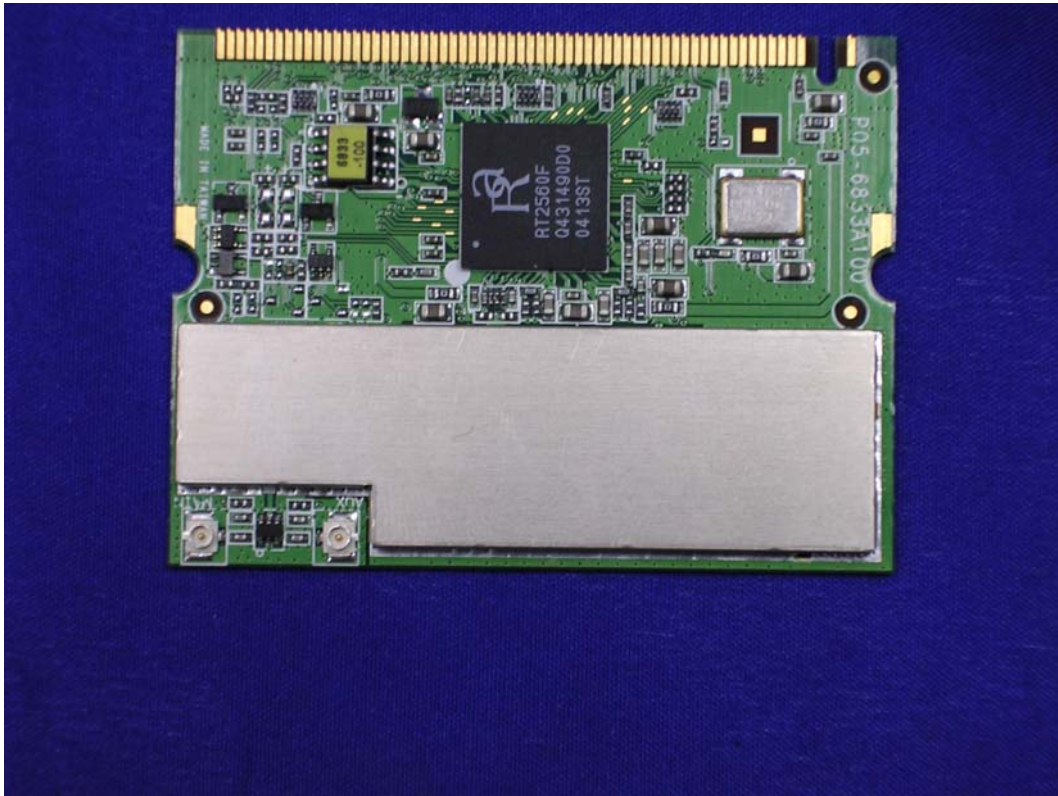

(2) EUT Photo



(3) EUT Photo

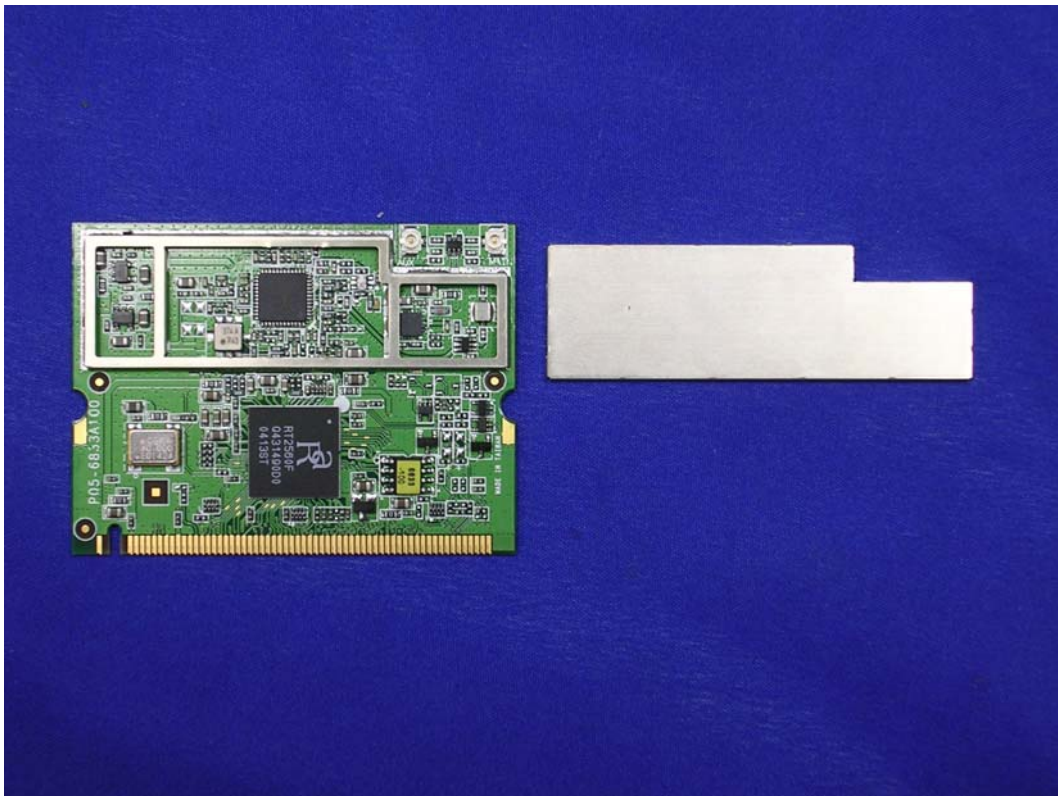

(4) EUT Photo

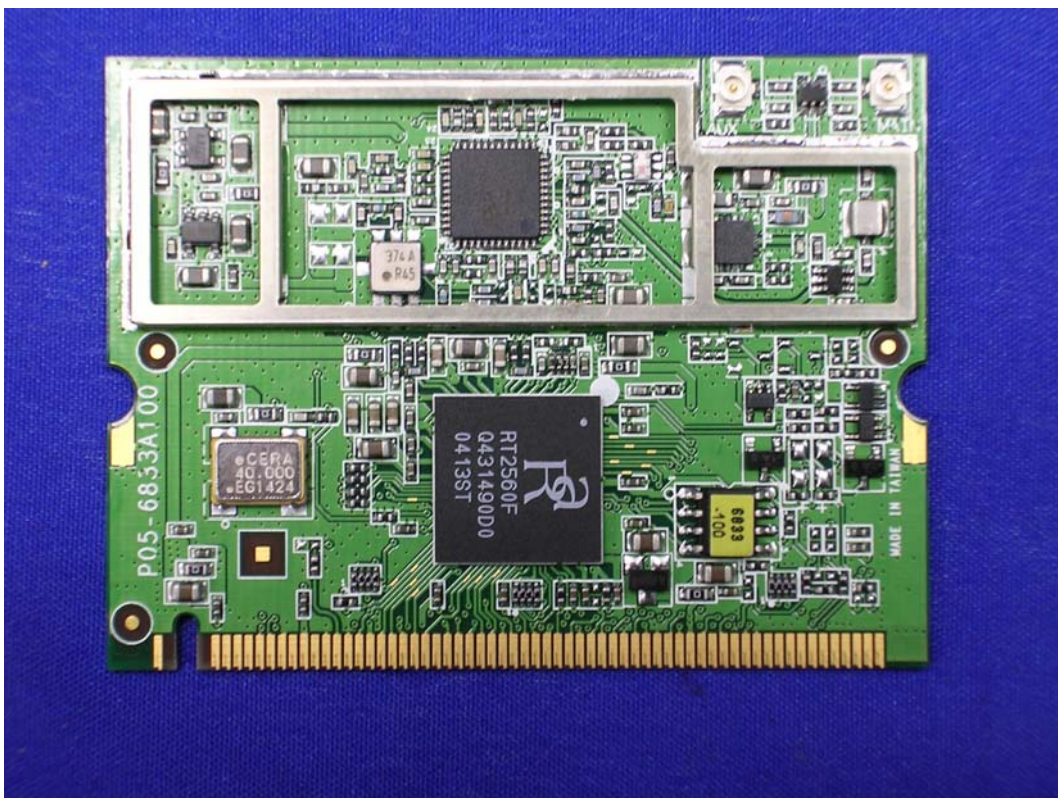

(5) EUT Photo



(6) EUT Photo

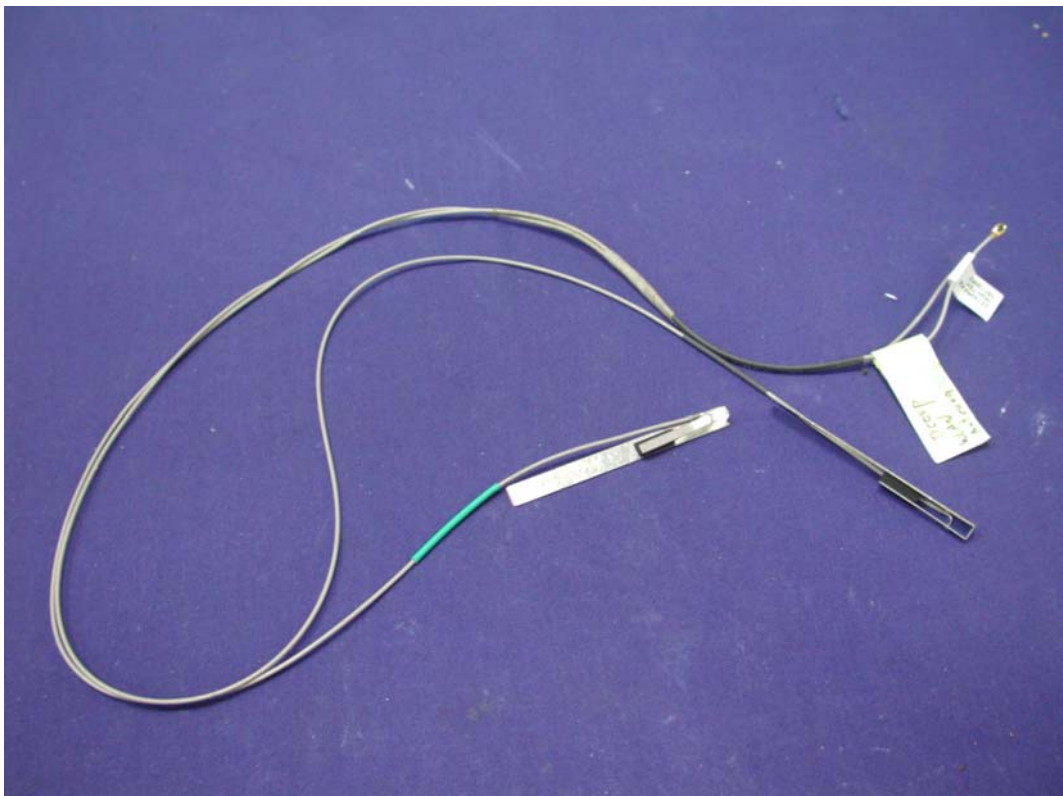

(7) EUT Photo

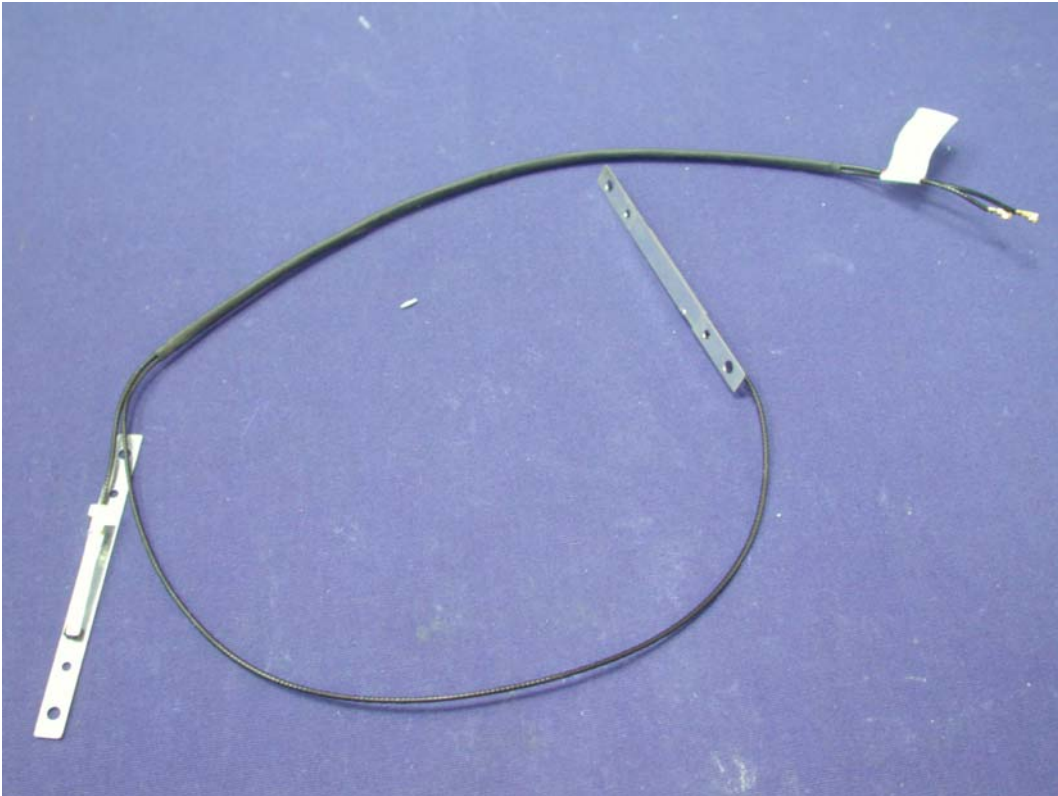

(8) EUT Photo

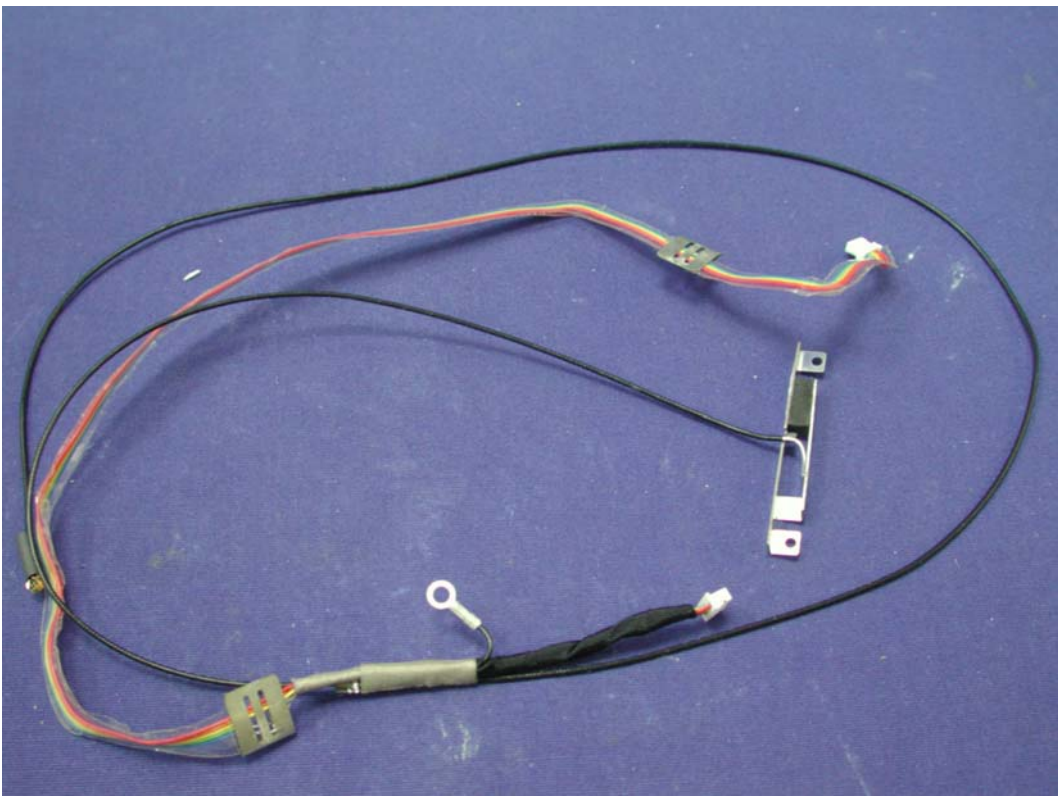

(9) EUT Photo



(10) EUT Photo

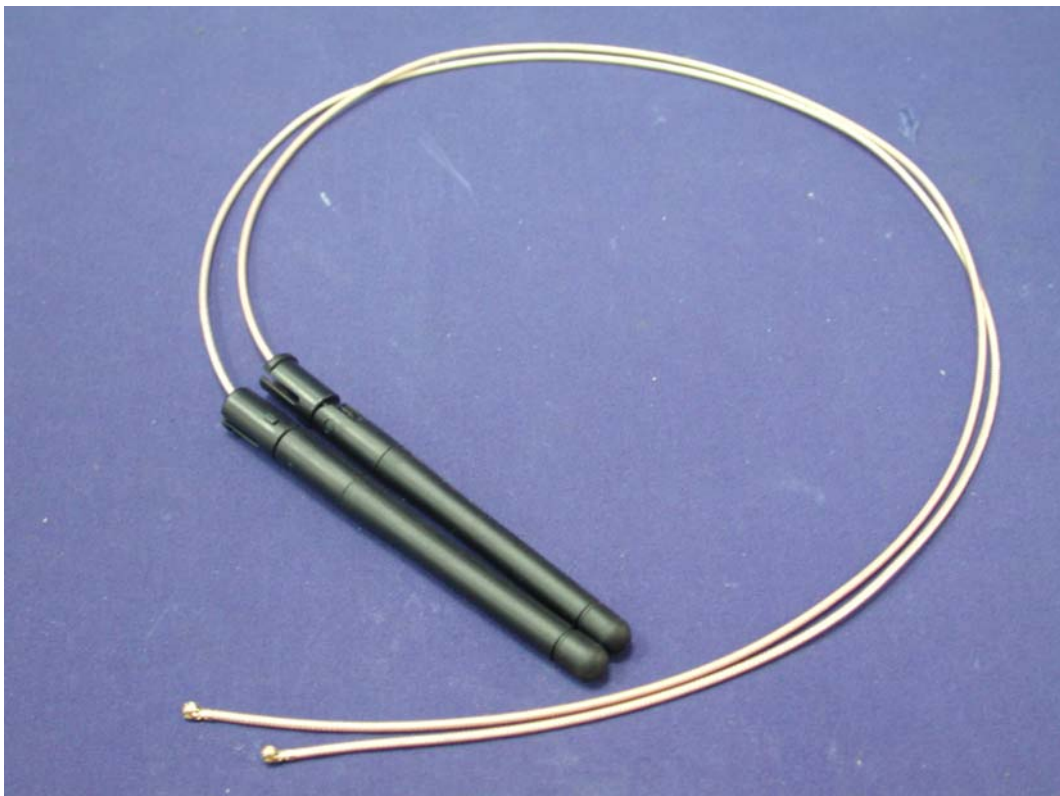

(11) EUT Photo

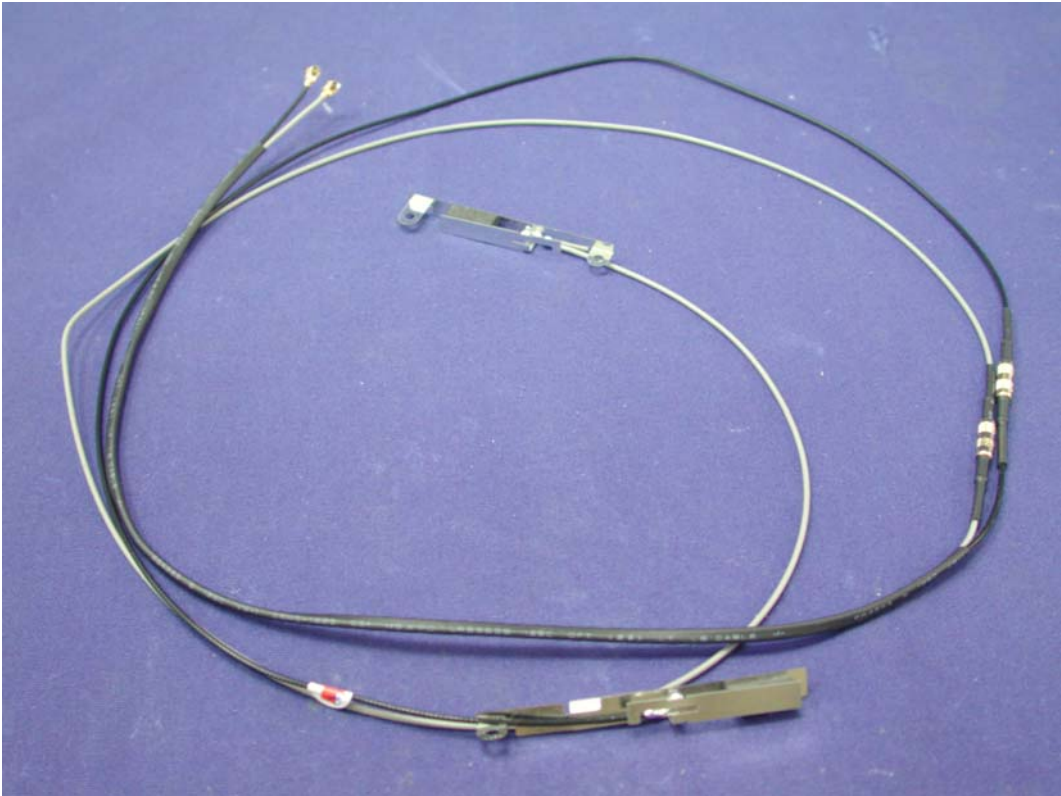

(12) EUT Photo

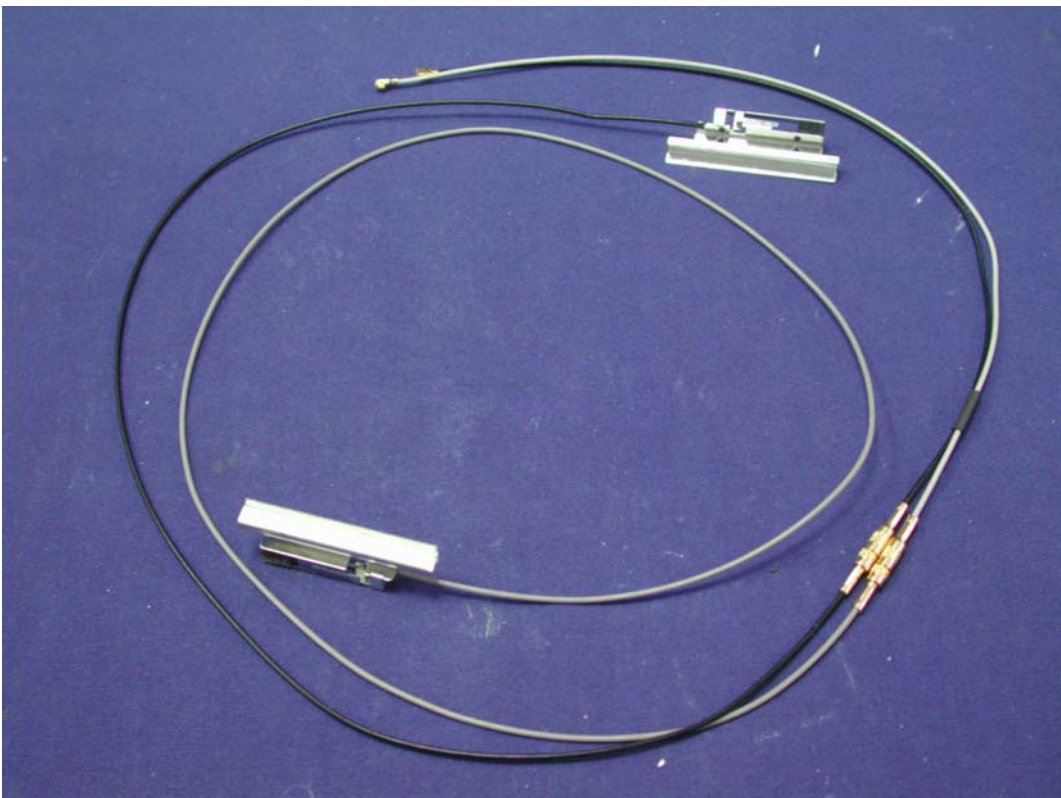

(13) EUT Photo

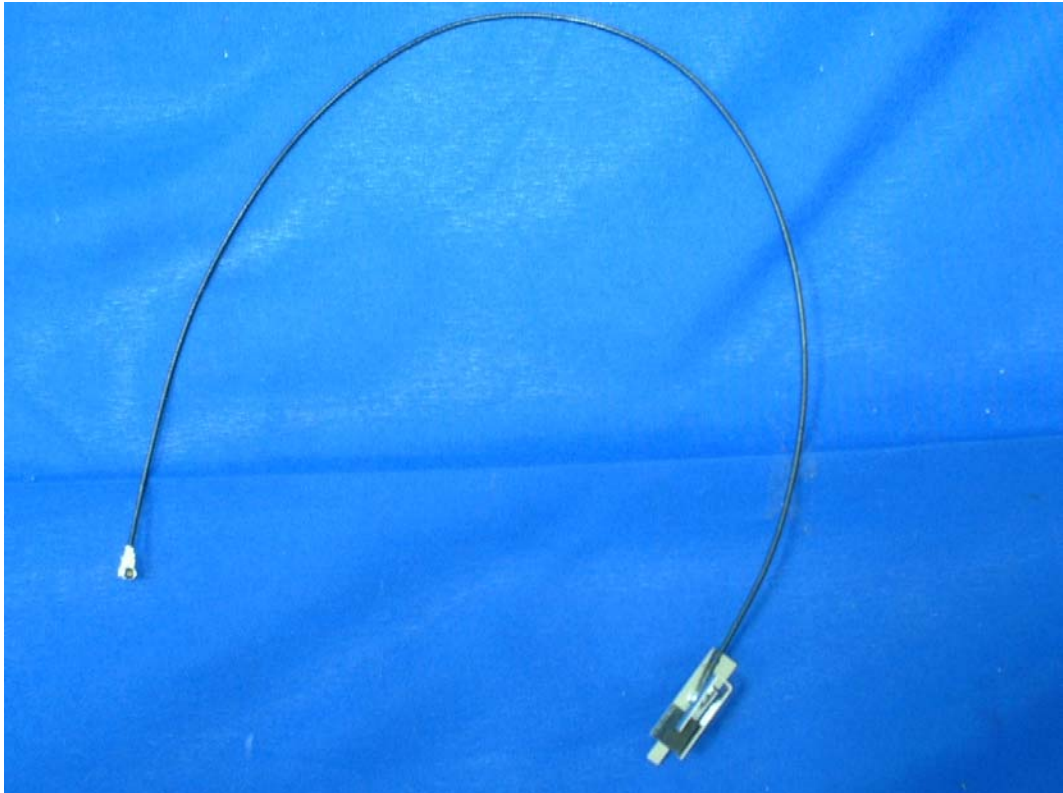

(14) EUT Photo

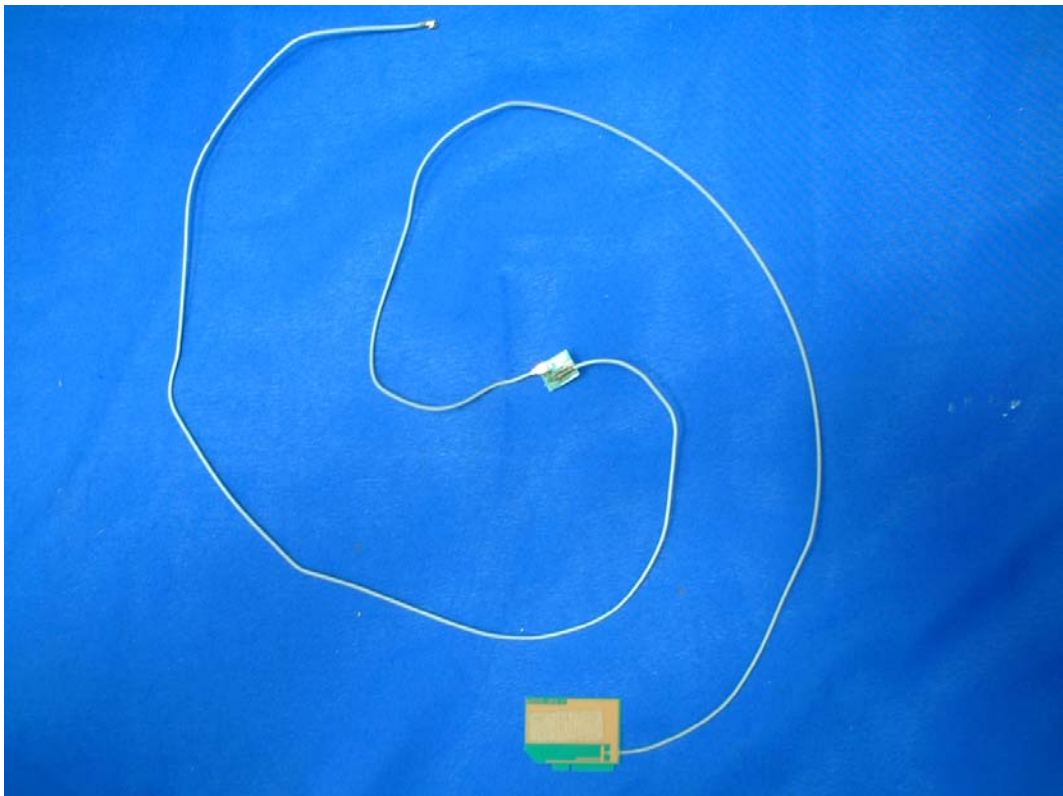



(15) EUT Photo



(16) EUT Photo

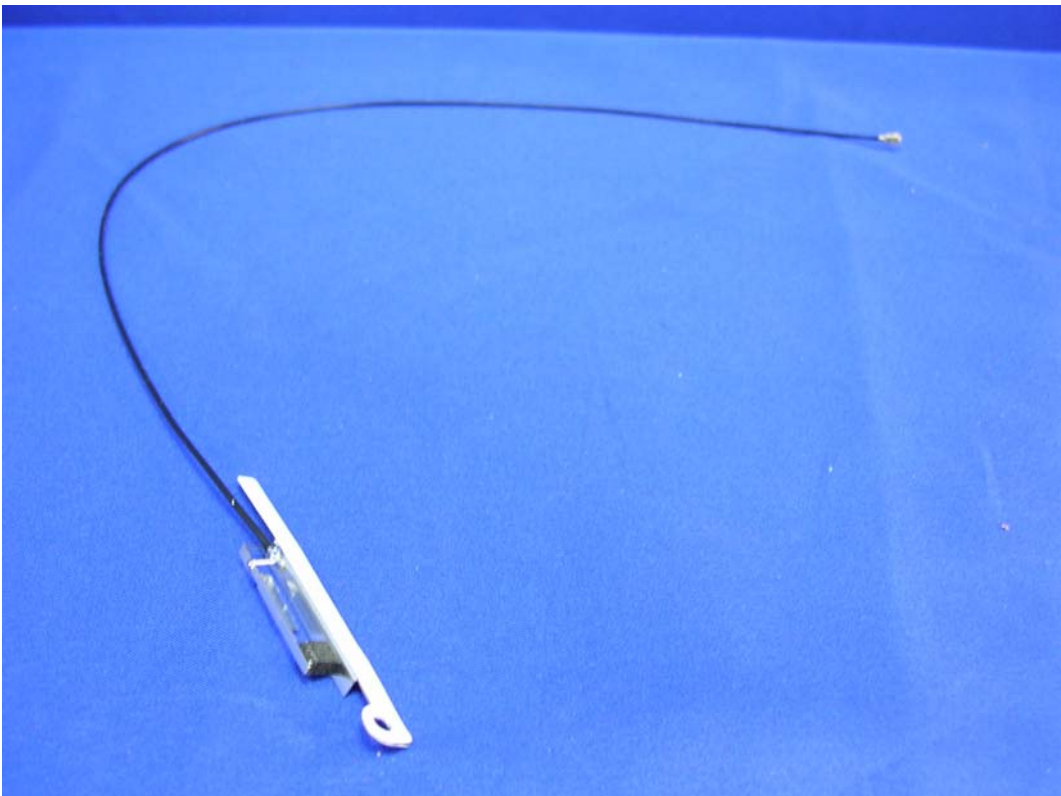

(17) EUT Photo

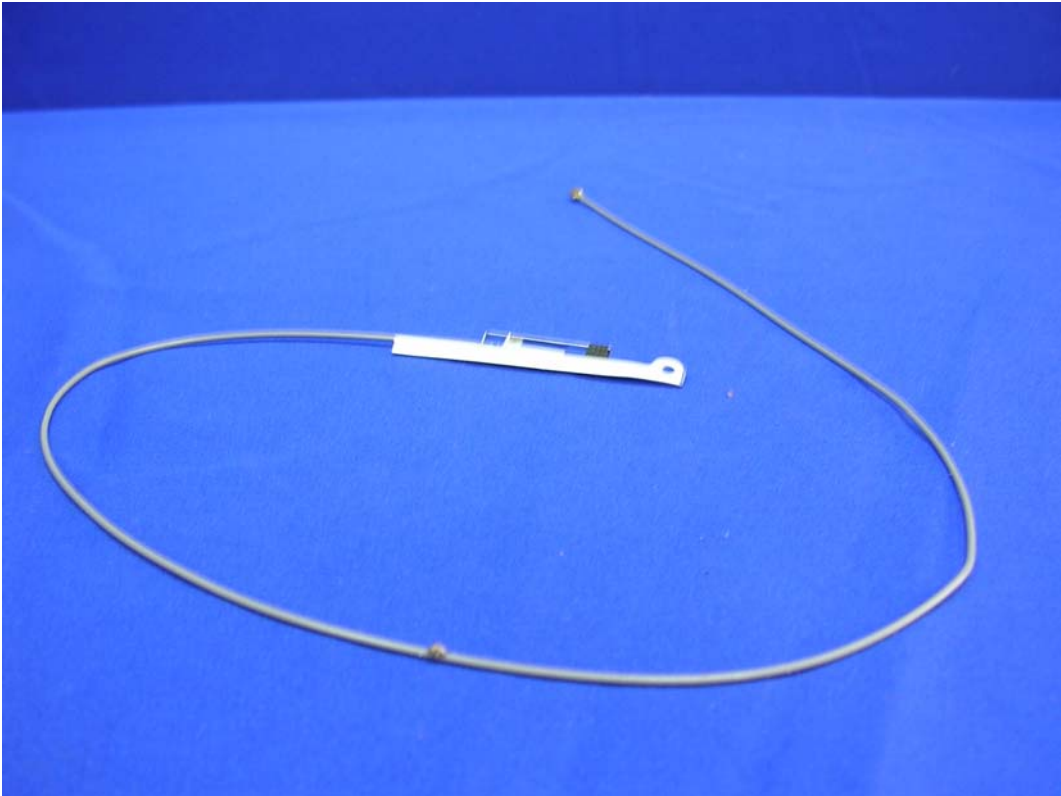

(18) EUT Photo

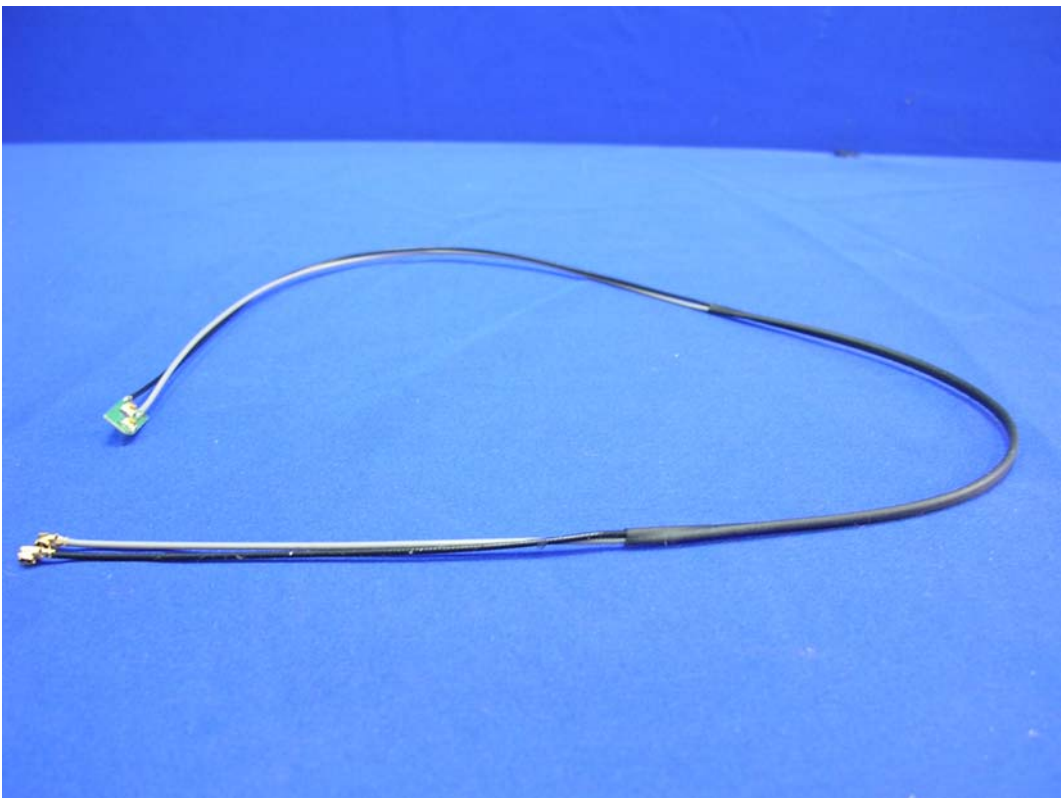

## RF Exposure Evaluation declaration

Product Name : Mini PCI Card

Model No : MS-6833A

FCC ID. : I4L-MS6833A

Applicant : MICRO-STAR INT'L Co., LTD

Address : No 69, Li-De st., Jung-He City, Taipei Hsien, Taiwan, R.O.C

Date of Receipt : Jul. 02, 2004

Issued Date : Jul. 15, 2004

Report No. : 047L030FI

The declaration results relate only to the samples calculated.

The declaration shall not be reproduced except in full without the written approval of QuieTek Corporation.

This report must not be used to claim product endorsement by NVLAP any agency of the U.S. Government

## 1. RF Exposure Evaluation

### 1.1. Limits

According to FCC 1.1310: The criteria listed in the following table shall be used to evaluate the environment impact of human exposure to radio frequency (RF) radiation as specified in 1.1307(b) LIMITS FOR MAXIMUM PERMISSIBLE EXPOSURE (MPE)

Frequency Range (MHz)	Electric Field Strength (V/m)	Magnetic Field Strength (A/m)	Power Density (mW/cm <sup>2</sup> )	Average Time (Minutes)
(A) Limits for Occupational/ Control Exposures				
300-1500	--	--	F/300	6
1500-100,000	--	--	5	6
(B) Limits for General Population/ Uncontrolled Exposures				
300-1500	--	--	F/1500	6
1500-100,000	--	--	1	30

F= Frequency in MHz

Friis Formula

Friis transmission formula:  $P_d = (P_{out} * G) / (4 * \pi * r^2)$

Where

$P_d$  = power density in mW/cm<sup>2</sup>

$P_{out}$  = output power to antenna in mW

G = gain of antenna in linear scale

$\pi$  = 3.1416

R = distance between observation point and center of the radiator in cm

$P_d$  is the limit of MPE, 1 mW/cm<sup>2</sup>. If we know the maximum gain of the antenna and the total power input to the antenna, through the calculation, we will know the distance r where the MPE limit is reached.

### 1.2. Test Procedure

Software provided by client enabled the EUT to transmit and receive data at lowest, middle and highest channel individually.

The temperature and related humidity: 18°C and 78% RH.

### 1.3. Test Result of RF Exposure Evaluation

Product : Mini PCI Card  
 Test Item : RF Exposure Evaluation  
 Test Site : No.3 OATS

#### Antenna Gain

Antenna Gain: The maximum Gain measured in fully anechoic chamber in linear scale.

#### (802.11b)

##### Output Power Into Antenna & RF Exposure Evaluation Distance (2.99dBi):

Channel	Frequency (MHz)	Output Power to Antenna (mW)	Power Density at R = 2.5 cm (mW/cm <sup>2</sup> )
1	2412.70	25.5270	0.6470
6	2437.70	28.9068	0.7327
11	2462.70	25.0035	0.6337

#### (802.11g)

##### Output Power Into Antenna & RF Exposure Evaluation Distance (2.99 dBi):

Channel	Frequency (MHz)	Output Power to Antenna (mW)	Power Density at R = 2.5 cm (mW/cm <sup>2</sup> )
1	2412.70	24.2661	0.6151
6	2437.70	25.1768	0.6381
11	2462.70	25.1768	0.6381

The distance  $r$  (4<sup>th</sup> column) calculated from the Friis transmission formula is far shorter than 2.5 cm separation requirement.