

FCC RADIO TEST REPORT

according to

47 CFR FCC Part 15 Subpart C § 15.247

Equipment : CM11BGN-BT
Model No. : MS-3870
Brand Name : MSI
Filing Type : New Application
Applicant : Micro-Star Int'l Co.,Ltd.
No.69 Li-Te St, Chung-Ho City, Taipei Hsien, Taiwan
FCC ID : I4L-MS3870
Manufacturer : Micro-Star Int'l Co.,Ltd.
No.69 Li-Te St, Chung-Ho City, Taipei Hsien, Taiwan
Received Date : Sep. 21, 2009
Final Test Date : Nov. 16, 2009

Statement

Test result included is only for the Bluetooth part of the product.

The test result in this report refers exclusively to the presented test model / sample.

Without written approval of SPORTON International Inc., the test report shall not be reproduced except in full.

The measurements and test results shown in this test report were made in accordance with the procedures and found in compliance with the limit given in **ANSI C63.4-2003** and **47 CFR FCC Part 15 Subpart C**.

The test equipment used to perform the test is calibrated and traceable to NML/ROC.



SPORTON International Inc.

6F, No. 106, Sec. 1, Hsin Tai Wu Rd., Hsi Chih, Taipei Hsien, Taiwan, R.O.C.

Table of Contents

1 SUMMARY OF THE TEST RESULT 2

2 GENERAL INFORMATION..... 3

2.1 Product Details 3

2.2 Table for Filed Antenna 3

2.3 Table for Carrier Frequencies 3

2.4 Table for Test Modes 4

2.5 Table for Testing Locations 4

2.6 Table for Supporting Units..... 4

2.7 Table for Parameters of Test Software Setting 5

2.8 EUT Operation during Test 5

2.9 Test Configurations 6

3 TEST RESULT 8

3.1 AC Power Line Conducted Emissions Measurement..... 8

3.2 Maximum Peak Output Power Measurement..... 12

3.3 Hopping Channel Separation Measurement 14

3.4 Number of Hopping Frequency Measurement 19

3.5 Dwell Time Measurement..... 21

3.6 Radiated Emissions Measurement..... 28

3.7 Band Edge and Fundamental Emissions Measurement 40

3.8 Antenna Requirements..... 45

4 LIST OF MEASURING EQUIPMENTS 46

5 TEST LOCATION..... 48

6 TAF CERTIFICATE OF ACCREDITATION 49

APPENDIX A. TEST PHOTOS A1 ~ A7

APPENDIX B. PHOTOGRAPHS OF EUT B1 ~ B3

History of This Test Report

Original Issue Date: Nov. 24, 2009

Report No.: FR9O2025AD

No additional attachment.

Additional attachment were issued as following record:

Attachment No.	Issue Date	Description

CERTIFICATE OF COMPLIANCE

according to

47 CFR FCC Part 15 Subpart C § 15.247

Equipment : CM11BGN-BT
Model No. : MS-3870
Brand Name : MSI
Applicant : Micro-Star Int'l Co.,Ltd.
No.69 Li-Te St, Chung-Ho City, Taipei Hsien, Taiwan

Sporton International as requested by the applicant to evaluate the EMC performance of the product sample received on Sep. 21, 2009 would like to declare that the tested sample has been evaluated and found to be in compliance with the tested rule parts. The data recorded as well as the test configuration specified is true and accurate for showing the sample's EMC nature.



Wayne Hsu

SPORTON International Inc.

6F, No.106, Sec. 1, Hsin Tai Wu Rd., Hsi Chih, Taipei Hsien, Taiwan, R.O.C.

1 SUMMARY OF THE TEST RESULT

Applied Standard: 47 CFR FCC Part 15 Subpart C				
Part	Rule Section	Description of Test	Result	Under Limit
3.1	15.207	AC Power Line Conducted Emissions	Complies	6.47 dB
3.2	15.247(b)(1)	Maximum Peak Conducted Output Power	Complies	25.44 dB
3.3	15.247(a)(1)	Hopping Channel Separation	Complies	-
3.4	15.247(b)(1)	Number of Hopping Frequency	Complies	-
3.5	15.247(a)(1)	Dwell Time	Complies	-
3.6	15.247(d)	Radiated Emissions	Complies	6.45 dB
3.7	15.247(d)	Band Edge Emissions	Complies	3.87 dB
3.8	15.203	Antenna Requirements	Complies	-

Test Items	Uncertainty	Remark
AC Power Line Conducted Emissions	±2.3dB	Confidence levels of 95%
Maximum Peak Conducted Output Power	±0.8dB	Confidence levels of 95%
Hopping Channel Separation	±8.5×10 ⁻⁸	Confidence levels of 95%
Radiated Emissions (9kHz~30MHz)	±0.8dB	Confidence levels of 95%
Radiated Emissions (30MHz~1000MHz)	±1.9dB	Confidence levels of 95%
Radiated / Band Edge Emissions (1GHz~18GHz)	±1.9dB	Confidence levels of 95%
Radiated Emissions (18GHz~40GHz)	±1.9dB	Confidence levels of 95%
Temperature	±0.7	Confidence levels of 95%
Humidity	±3.2%	Confidence levels of 95%
DC / AC Power Source	±1.4%	Confidence levels of 95%

2 GENERAL INFORMATION

2.1 Product Details

Only the radio detail of Bluetooth is shown in the table below. For more detailed features description, please refer to the manufacturer’s specifications or user’s manual.

Items	Description
Power Type	From host
Modulation	FHSS (GFSK/ $\pi/4$ -DQPSK/ 8DPSK)
Data Rate (Mbps)	GFSK: 1/ $\pi/4$ -DQPSK: 2/ 8DPSK: 3
Frequency Range	2400 ~ 2483.5MHz
Channel Number	79
Channel Band Width (99%)	1.212 MHz
Conducted Output Power	1.75 dBm

2.2 Table for Filed Antenna

Ant.	Antenna Type	Connector	Gain (dBi)	Remark
A	Printed Antenna	Fixed on Board	4.58	TX / RX

2.3 Table for Carrier Frequencies

Frequency Band	Channel No.	Frequency
2400~2483.5MHz	0	2402 MHz
	1	2403 MHz
	:	:
	38	2440 MHz
	39	2441 MHz
	40	2442 MHz
	:	:
	77	2479 MHz
	78	2480 MHz

2.4 Table for Test Modes

Preliminary tests were performed in different data rate to find the worst radiated emission. The data rate shown in the table below is the worst-case rate with respect to the specific test item. Investigation has been done on all the possible configurations for searching the worst cases. The following table is a list of the test modes shown in this test report.

Test Items	Mode	Data Rate	Channel
AC Power Conducted Emissions	Normal Mode	Auto	-
Max. Conducted Output Power	GFSK/ $\pi/4$ -DQPSK/ 8DPSK	1 Mbps/ 2 Mbps/ 3 Mbps	0/39/78
Hopping Channel Separation	8DPSK	3 Mbps	0~1/39~40/77~78
Number of Hopping Frequency	8DPSK	3 Mbps	0~78
Dwell Time	DH1/DH3/DH5	3 Mbps	0/39/78
Radiated Emissions Below 1GHz	GFSK	1 Mbps	39
Radiated Emissions Above 1GHz	GFSK	1 Mbps	0/39/78
Band Edge Emissions	GFSK/ $\pi/4$ -DQPSK/ 8DPSK	1 Mbps/ 2 Mbps/ 3 Mbps	0/78

2.5 Table for Testing Locations

Test Site No.	Site Category	Location	FCC Reg. No.	IC File No.
CO04-HY	Conduction	Hwa Ya	643075	IC 4086C
TH01-HY	OVEN Room	Hwa Ya	-	-
03CH02-HY	SAC	Hwa Ya	643075	IC 4086B

Semi Anechoic Chamber (SAC).

2.6 Table for Supporting Units

Support Unit	Brand	Model	FCC ID	Remark
Notebook	DELL	D505	DoC	Conducted
Modem	ACEEX	DM1414	IFAXDM1414	
Printer	EPSON	LQ300+	DoC	
Test Fixture	-	-	-	
Notebook	DELL	D505	DoC	Radiated
Modem	ACEEX	DM1414	IFAXDM1414	
Printer	EPSON	LQ680	DoC	
Test Fixture	-	-	-	

2.7 Table for Parameters of Test Software Setting

During testing, Channel & Power Controlling Software provided by the customer was used to control the operating channel as well as the output power level. The RF output power selection is for the setting of RF output power expected by the customer and is going to be fixed on the firmware of the final end product.

Power Parameters of Bluetooth

Test Software Version	Blue Test		
Frequency	2402 MHz	2441 MHz	2480 MHz
Power Parameters (1Mbps)	63	63	63
Power Parameters (2Mbps)	120	120	120
Power Parameters (3Mbps)	160	160	160

2.8 EUT Operation during Test

An executive program, "EMCTEST.EXE" under WIN XP, which generates a complete line of continuously repeating "H" pattern was used as the test software.

The program was executed as follows :

- a. Turn on the power of all equipment.
- b. The PC reads the test program from the hard disk drive and runs it.
- c. The PC sends "H" messages to the monitor, and the monitor displays "H" patterns on the screen.
- d. The PC sends "H" messages to the printer, and then the printer prints them on the paper.
- e. The PC sends messages to the modem.
- f. The PC sends "H" messages to the internal hard disk, and the hard disk reads and writes the message.
- g. Repeat the steps from c to f.

At the same time, the following programs were executed:

- Executed "Blue Test" to keep transmitting signals at fixed frequency.

2.9 Test Configurations

2.9.1 Radiation Emissions Test Configuration

For radiated emissions 9kHz~1GHz

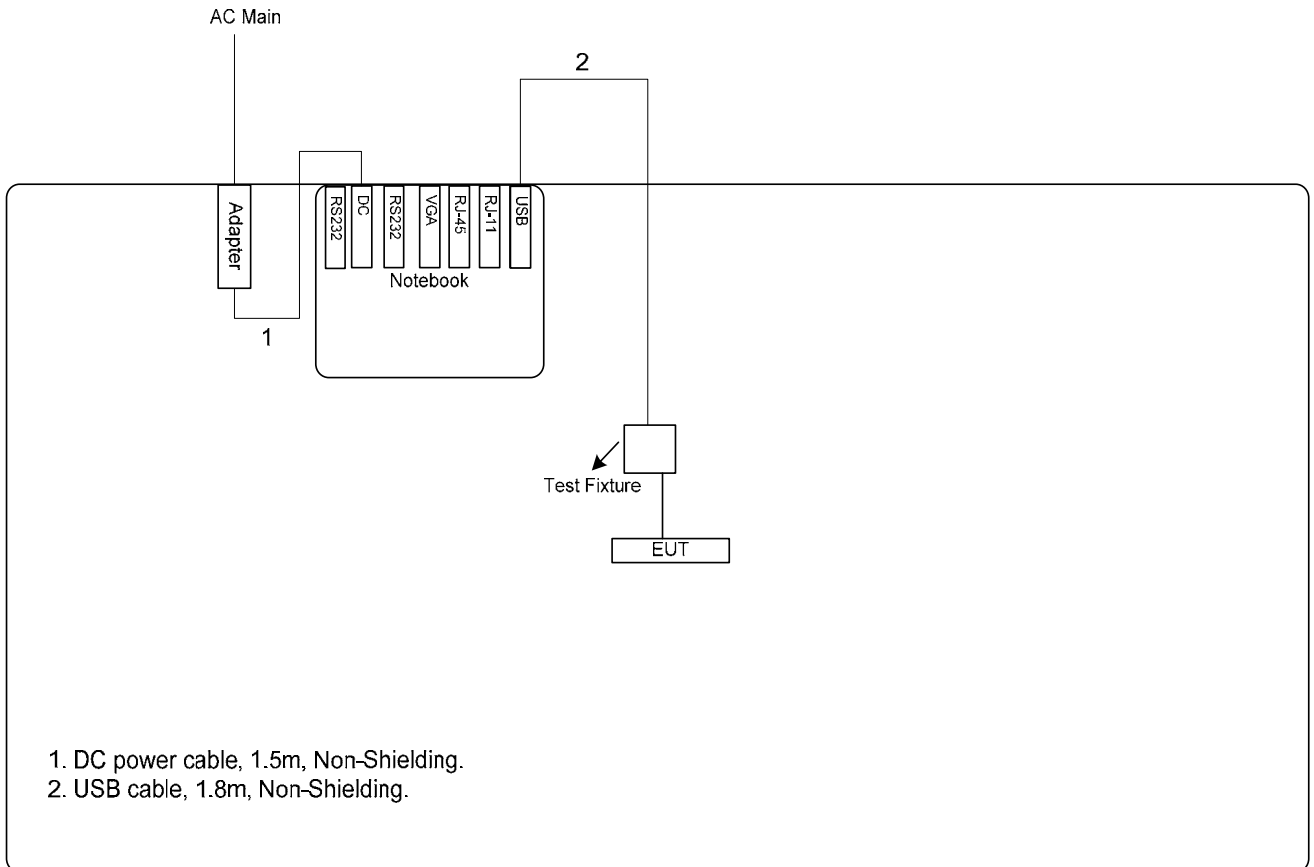

For radiated emissions above 1GHz

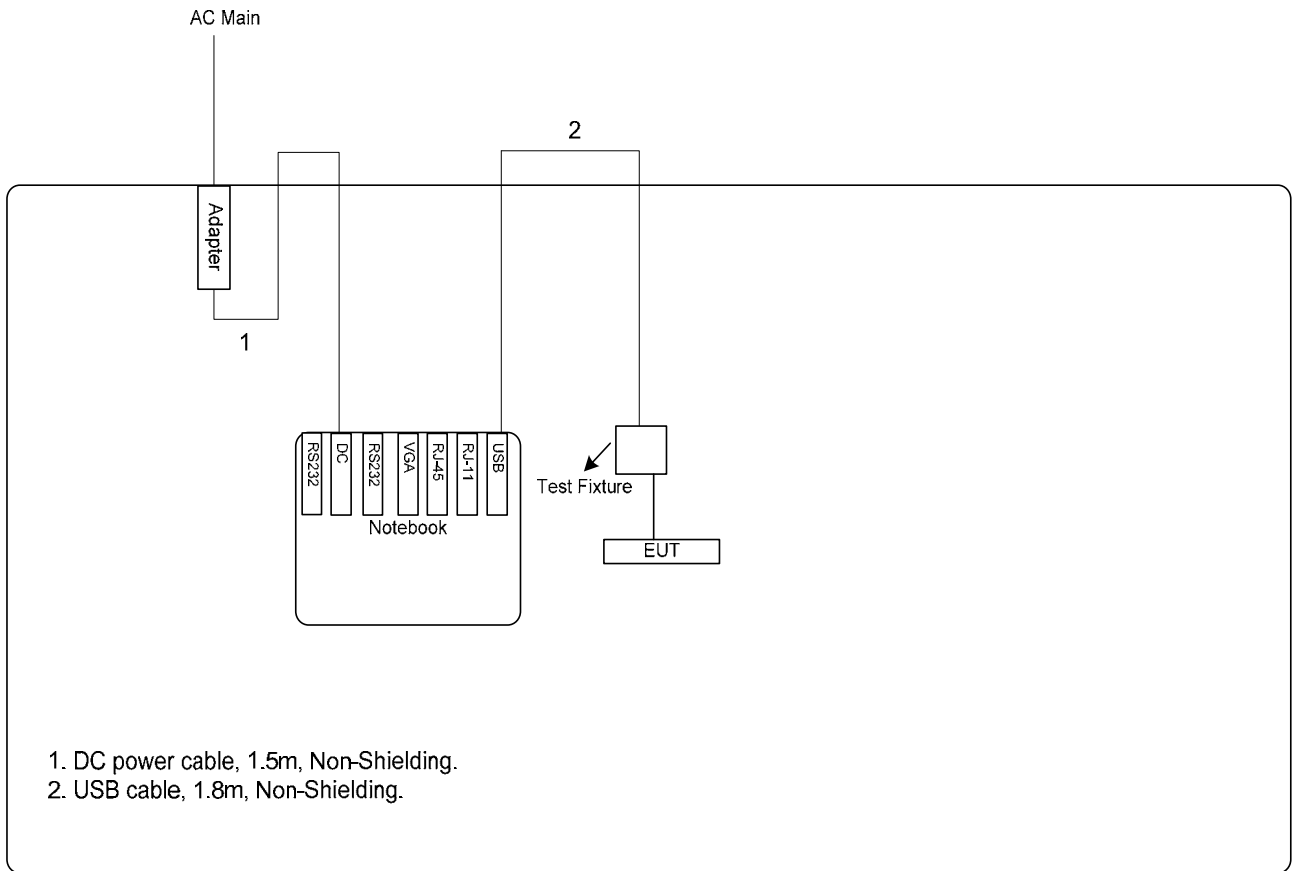

3 TEST RESULT

3.1 AC Power Line Conducted Emissions Measurement

3.1.1 Limit

For this product which is designed to be connected to the AC power line, the radio frequency voltage that is conducted back onto the AC power line on any frequency or frequencies within the band 150 kHz to 30 MHz shall not exceed below limits table.

Class B

Frequency (MHz)	QP Limit (dBuV)	AV Limit (dBuV)
0.15~0.5	66~56	56~46
0.5~5	56	46
5~30	60	50

3.1.2 Measuring Instruments and Setting

Please refer to section 4 of equipments list in this report. The following table is the setting of the receiver.

Receiver Parameters	Setting
Attenuation	10 dB
Start Frequency	0.15 MHz
Stop Frequency	30 MHz
IF Bandwidth	9 KHz

3.1.3 Test Procedures

1. Configure the EUT according to ANSI C63.4. The EUT or host of EUT has to be placed 0.4 meter far from the conducting wall of the shielding room and at least 80 centimeters from any other grounded conducting surface.
2. Connect EUT or host of EUT to the power mains through a line impedance stabilization network (LISN).
3. All the support units are connected to the other LISNs. The LISN should provide 50uH/50ohms coupling impedance.
4. The frequency range from 150 KHz to 30 MHz was searched.
5. Set the test-receiver system to Peak Detect Function and Specified Bandwidth with Maximum Hold Mode.
6. The measurement has to be done between each power line and ground at the power terminal.

3.1.4 Test Setup Layout

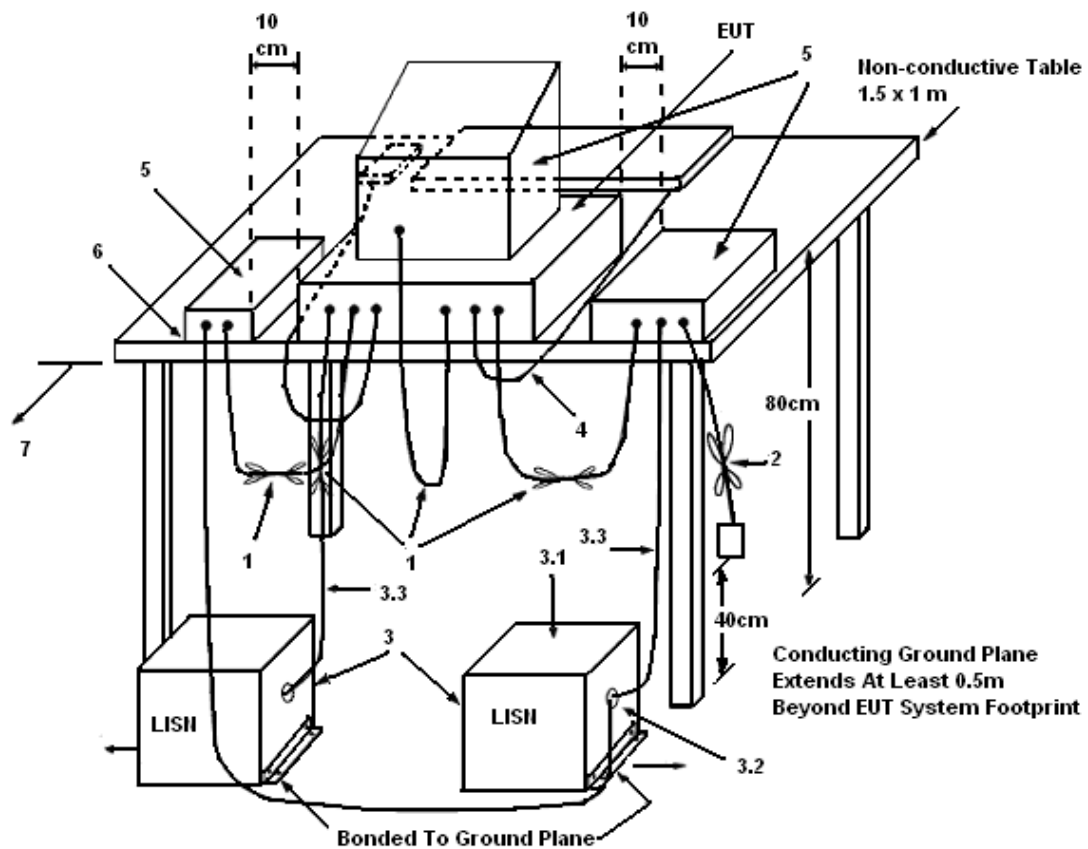

LEGEND:

- (1) Interconnecting cables that hang closer than 40 cm to the ground plane shall be folded back and forth in the center forming a bundle 30 to 40 cm long.
- (2) I/O cables that are not connected to a peripheral shall be bundled in the center. The end of the cable may be terminated, if required, using the correct terminating impedance. The overall length shall not exceed 1 m.
- (3) EUT connected to one LISN. Unused LISN measuring port connectors shall be terminated in 50 Ω. LISN can be placed on top of, or immediately beneath, reference ground plane.
- (3.1) All other equipment powered from additional LISN(s).
- (3.2) Multiple outlet strip can be used for multiple power cords of non-EUT equipment.
- (3.3) LISN at least 80 cm from nearest part of EUT chassis.
- (4) Cables of hand-operated devices, such as keyboards, mice, etc., shall be placed as for normal use.
- (5) Non-EUT components of EUT system being tested.
- (6) Rear of EUT, including peripherals, shall all be aligned and flush with rear of tabletop.
- (7) Rear of tabletop shall be 40 cm removed from a vertical conducting plane that is bonded to the ground plane.

3.1.5 Test Deviation

There is no deviation with the original standard.

3.1.6 EUT Operation during Test

The EUT was placed on the test table and programmed in normal function.

3.1.7 Results of AC Power Line Conducted Emissions Measurement

Final Test Date	Nov. 16, 2009	Test Site No.	CO04-HY
Temperature	25	Humidity	55%
Test Engineer	Chris	Configuration	Normal Mode

Line

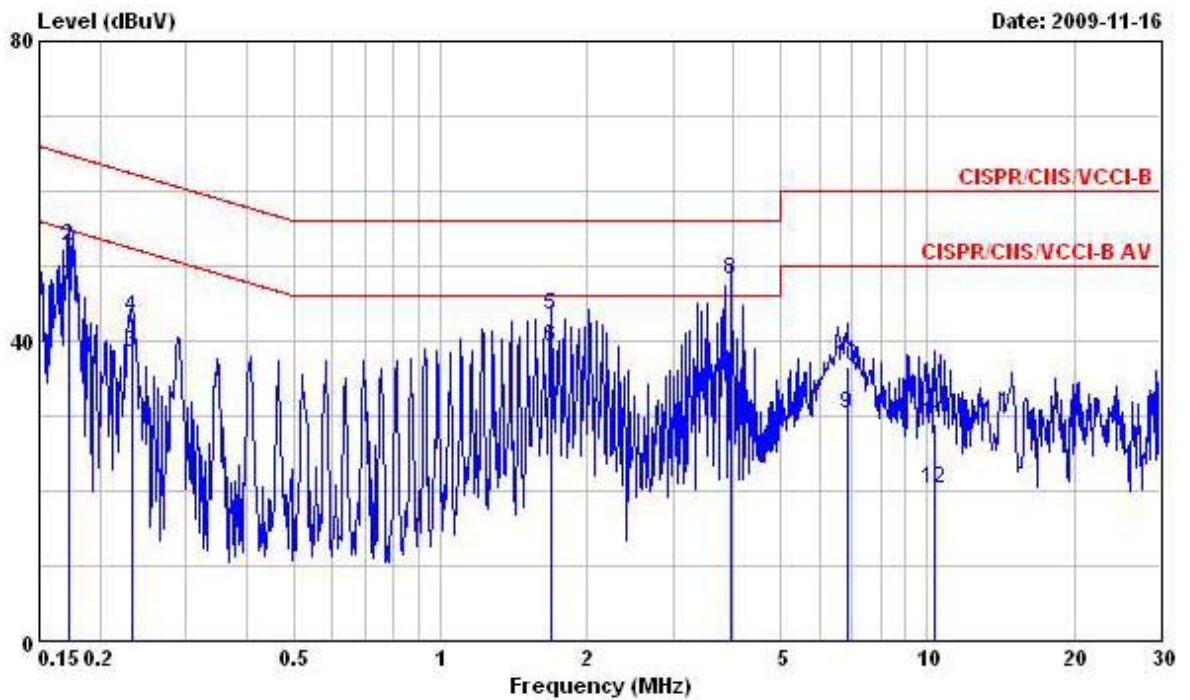

	Freq	Level	Over Limit	Limit Line	Read Level	LISN Factor	Cable Loss	Remark
	MHz	dBuV	dB	dBuV	dBuV	dB	dB	
1	@ 0.1730690	47.25	-7.56	54.81	47.13	0.08	0.04	Average
2	0.1730690	52.62	-12.19	64.81	52.50	0.08	0.04	QP
3	0.2328500	38.54	-13.81	52.35	38.41	0.08	0.05	Average
4	0.2328500	43.19	-19.16	62.35	43.06	0.08	0.05	QP
5	1.680	43.49	-12.51	56.00	43.23	0.12	0.14	QP
6	@ 1.680	39.31	-6.69	46.00	39.05	0.12	0.14	Average
7	3.940	33.88	-12.12	46.00	33.50	0.16	0.22	Average
8	@ 3.940	48.21	-7.79	56.00	47.83	0.16	0.22	QP
9	6.840	30.30	-19.70	50.00	29.79	0.22	0.29	Average
10	6.840	36.65	-23.35	60.00	36.14	0.22	0.29	QP
11	10.340	28.90	-31.10	60.00	28.28	0.27	0.35	QP
12	10.340	20.16	-29.84	50.00	19.54	0.27	0.35	Average

Neutral

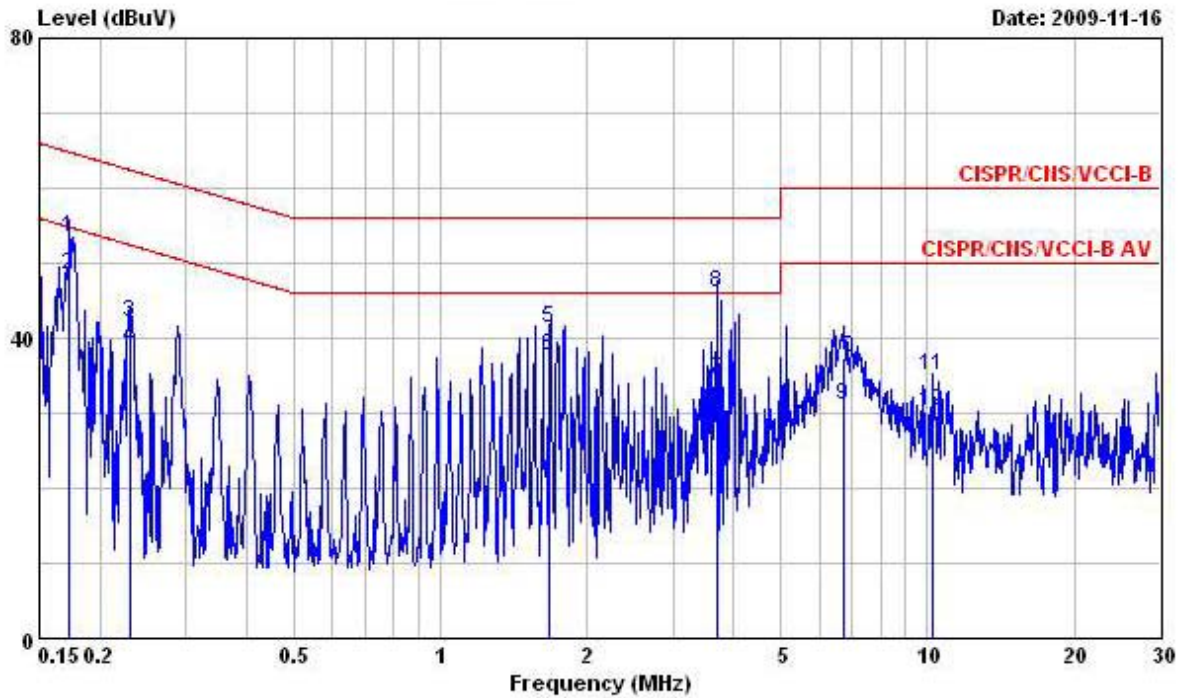

	Freq	Level	Over Limit	Limit Line	Read Level	LISN Factor	Cable Loss	Remark
	MHz	dBuV	dB	dBuV	dBuV	dB	dB	
1	0.1730690	53.48	-11.33	64.81	53.36	0.08	0.04	QP
2	0.1730690	48.34	-6.47	54.81	48.22	0.08	0.04	Average
3	0.2316200	42.17	-20.22	62.39	42.04	0.08	0.05	QP
4	0.2316200	38.76	-13.63	52.39	38.63	0.08	0.05	Average
5	1.677	41.41	-14.59	56.00	41.16	0.11	0.14	QP
6	1.677	37.62	-8.38	46.00	37.37	0.11	0.14	Average
7	3.700	34.52	-11.48	46.00	34.16	0.15	0.21	Average
8	3.700	45.96	-10.04	56.00	45.60	0.15	0.21	QP
9	6.730	31.16	-18.84	50.00	30.66	0.21	0.29	Average
10	6.730	37.41	-22.59	60.00	36.91	0.21	0.29	QP
11	10.283	35.07	-24.93	60.00	34.46	0.26	0.35	QP
12	10.283	30.24	-19.76	50.00	29.63	0.26	0.35	Average

Note:

Level = Read Level + LISN Factor + Cable Loss.

3.2 Maximum Peak Output Power Measurement

3.2.1 Limit

For frequency hopping systems operating in the 2400-2483.5 MHz band employing at least 75 non-overlapping hopping channels, the limit for peak output power is 30dBm. The limited has to be reduced by the amount in dB that the gain of the antenna exceeds 6dBi. In case of point-to-point operation, the limit has to be reduced by 1dB for every 3dB that the directional gain of the antenna exceeds 6dBi.

3.2.2 Measuring Instruments and Setting

Please refer to section 4 of equipments list in this report. The following table is the setting of the power meter.

Power Meter Parameter	Setting
Filter No.	Auto
Measurement time	0.135 s ~ 26 s
Used Peak Sensor	NRV-Z32 (model 04)

3.2.3 Test Procedures

1. The transmitter output (antenna port) was connected to the power meter.
2. Turn on the EUT and power meter and then record the peak power value.
3. Repeat above procedures on all channels needed to be tested.

3.2.4 Test Setup Layout

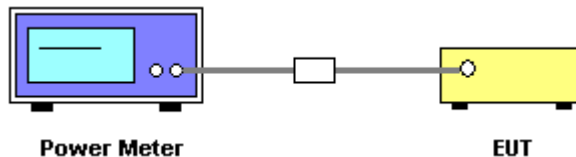

3.2.5 Test Deviation

There is no deviation with the original standard.

3.2.6 EUT Operation during Test

The EUT was programmed to be in continuously transmitting mode.

3.2.7 Test Result of Maximum Peak Output Power

Final Test Date	Sep. 21, 2009	Test Site No.	TH01-HY
Temperature	25	Humidity	56%
Test Engineer	Duncan	Configurations	GFSK / π/4-DQPSK / 8DPSK

1Mbps

Channel	Frequency	Conducted Power (dBm)	Max. Limit (dBm)	Result
0	2402 MHz	-0.97	30.00	Complies
39	2441 MHz	1.21	30.00	Complies
78	2480 MHz	1.75	30.00	Complies

2Mbps

Channel	Frequency	Conducted Power (dBm)	Max. Limit (dBm)	Result
0	2402 MHz	-3.32	30.00	Complies
39	2441 MHz	-1.24	30.00	Complies
78	2480 MHz	-0.78	30.00	Complies

3Mbps

Channel	Frequency	Conducted Power (dBm)	Max. Limit (dBm)	Result
0	2402 MHz	-3.36	30.00	Complies
39	2441 MHz	-1.26	30.00	Complies
78	2480 MHz	-0.86	30.00	Complies

3.3 Hopping Channel Separation Measurement

3.3.1 Limit

Frequency hopping systems shall have hopping channel carrier frequencies separated by a minimum of 25 kHz or the 20 dB bandwidth of the hopping channel, whichever is greater. Alternatively, frequency hopping systems operating in the 2400-2483.5 MHz band may have hopping channel carrier frequencies that are separated by 25 kHz or two-thirds of the 20 dB bandwidth of the hopping channel, whichever is greater.

3.3.2 Measuring Instruments and Setting

Please refer to section 4 of equipments list in this report. The following table is the setting of spectrum analyzer.

Spectrum Parameter	Setting
Attenuation	Auto
Span Frequency	> Measurement Bandwidth or Channel Separation
RB	100 kHz (20dB Bandwidth) / 100 kHz (Channel Separation)
VB	100 kHz (20dB Bandwidth) / 100 kHz (Channel Separation)
Detector	Peak
Trace	Max Hold
Sweep Time	Auto

3.3.3 Test Procedures

1. The transmitter output (antenna port) was connected to the spectrum analyzer in peak hold mode.
2. The resolution bandwidth of 30 kHz and the video bandwidth of 100 kHz were utilized for 20 dB bandwidth measurement.
3. The resolution bandwidth of 100 kHz and the video bandwidth of 100 kHz were utilized for channel separation measurement.

3.3.4 Test Setup Layout

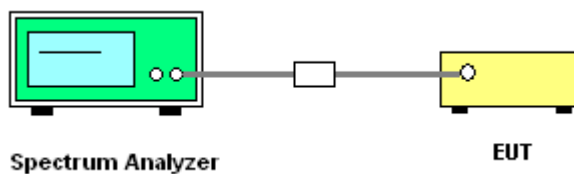

3.3.5 Test Deviation

There is no deviation with the original standard.

3.3.6 EUT Operation during Test

The EUT was programmed to be in continuously transmitting mode.

3.3.7 Test Result of Hopping Channel Separation

Final Test Date	Sep. 21, 2009	Test Site No.	TH01-HY
Temperature	25	Humidity	56%
Test Engineer	Duncan	Configurations	8DPSK

Frequency	Ch. Separation (MHz)	20dB Bandwidth (MHz)	99% Occupied Bandwidth (MHz)	Result
2402 MHz	1.000	1.368	1.206	Complies
2441 MHz	1.000	1.368	1.212	Complies
2480 MHz	1.000	1.368	1.212	Complies

Ch. Separation Limits: > 20dB bandwidth

20 dB Bandwidth Plot on Channel 0 / 2402 MHz

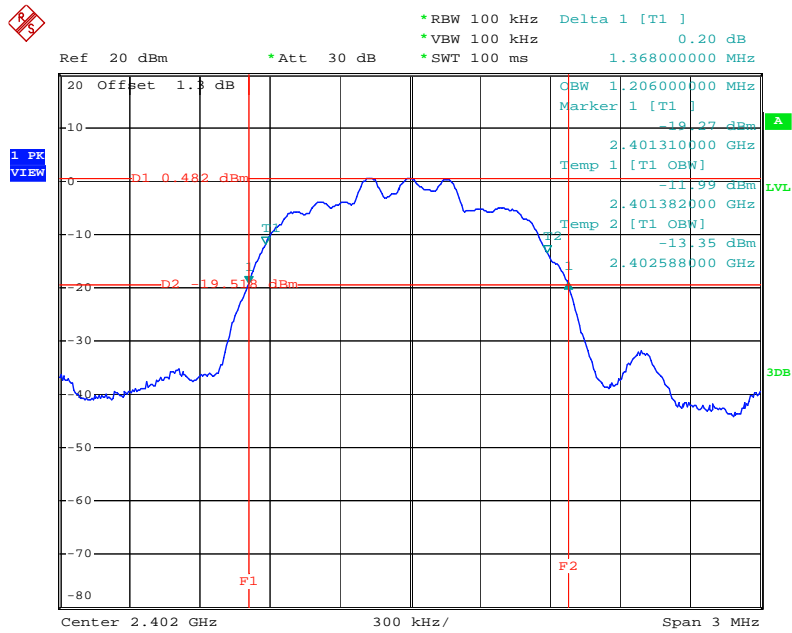

Date: 21.SEP.2009 15:16:12

20 dB Bandwidth Plot on Channel 39 / 2441 MHz

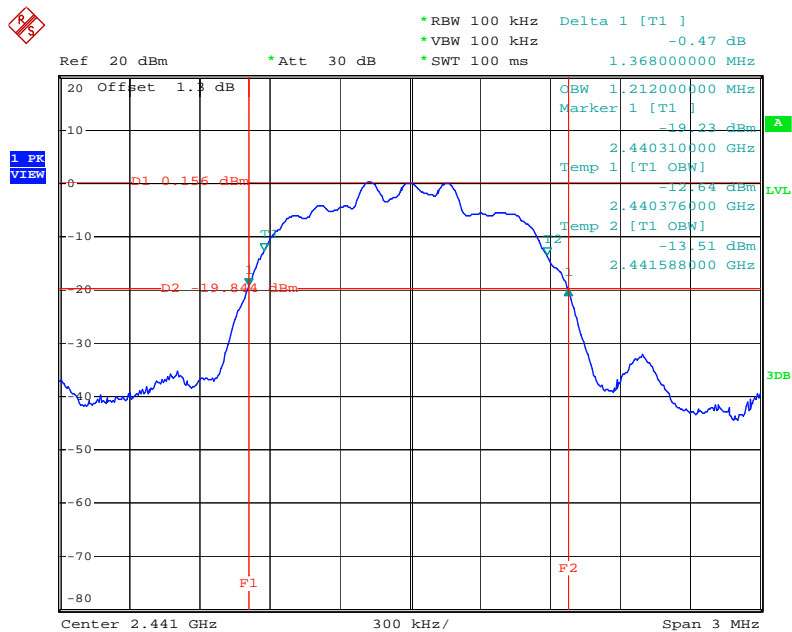

Date: 21.SEP.2009 15:16:51

20 dB Bandwidth Plot on Channel 78 / 2480 MHz

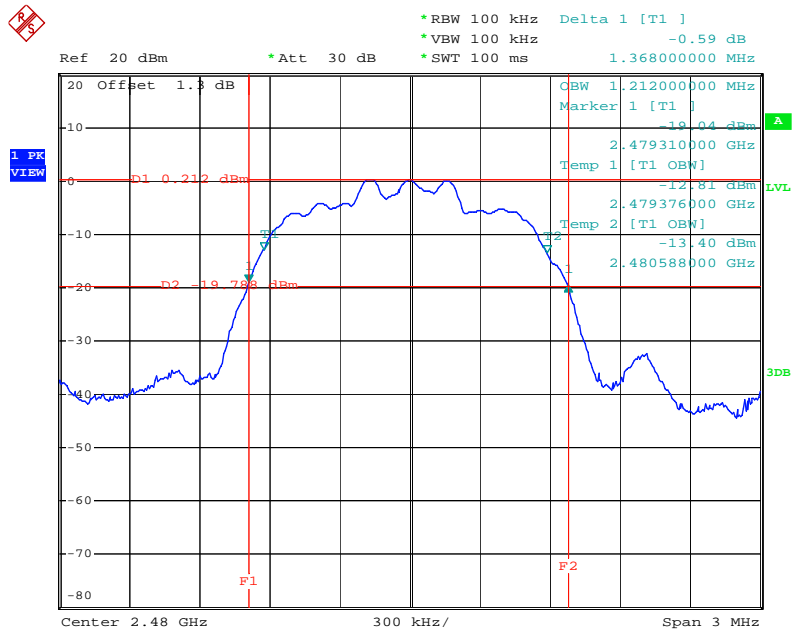

Date: 21.SEP.2009 15:17:23

Channel Separation Plot on Channel 0~1 / 2402 MHz ~ 2403 MHz

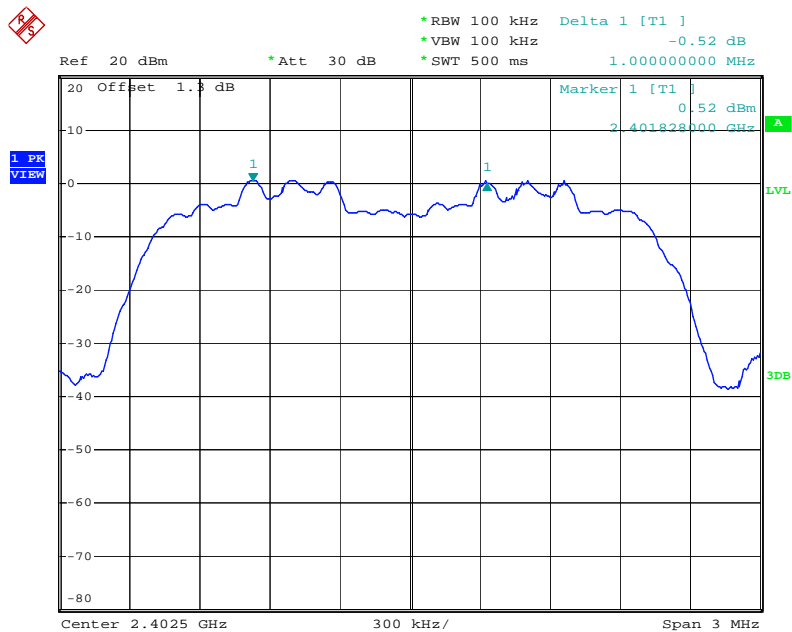

Date: 21.SEP.2009 15:20:20

Channel Separation Plot on Channel 39~40 / 2441 MHz ~ 2442 MHz

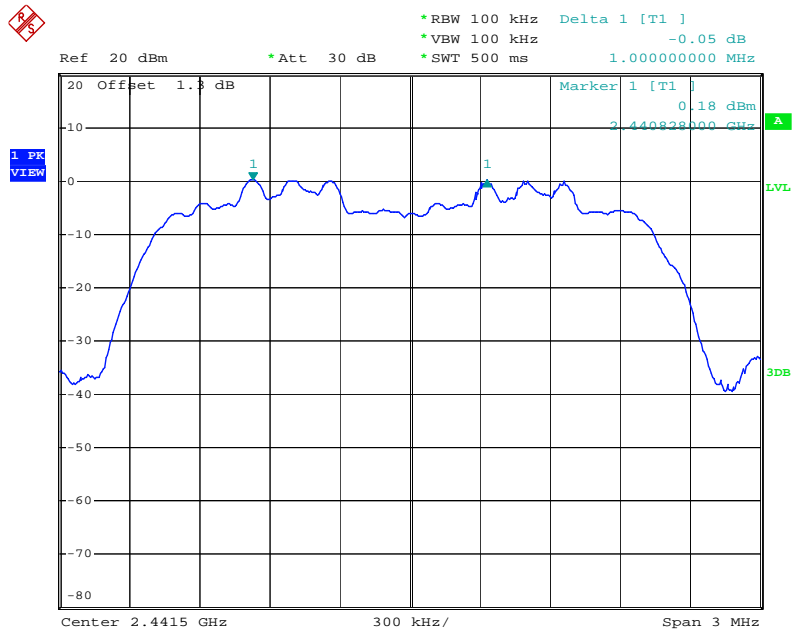

Date: 21.SEP.2009 15:23:12

Channel Separation Plot on Channel 77~78 / 2479 MHz ~ 2480 MHz

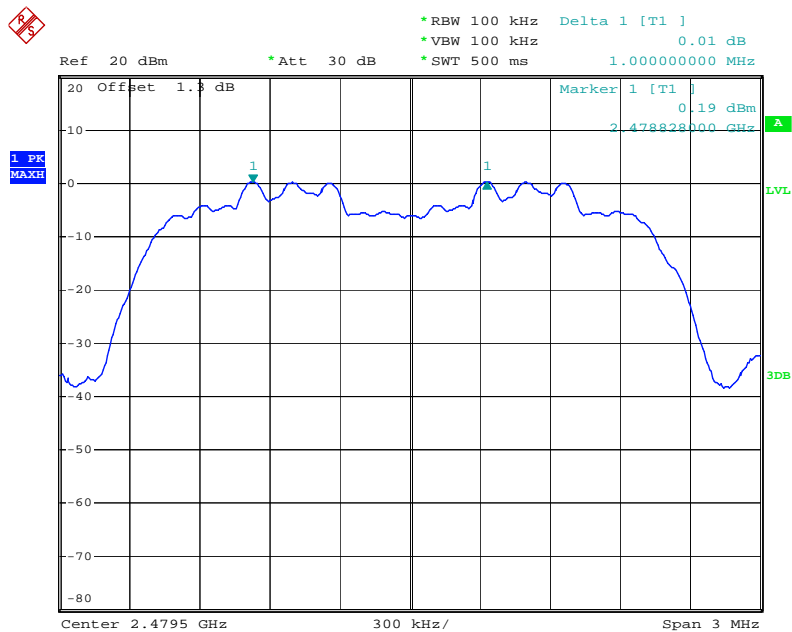

Date: 21.SEP.2009 15:24:42

3.4 Number of Hopping Frequency Measurement

3.4.1 Limit

For frequency hopping systems operating in the 2400-2483.5 MHz band employing at least 75 non-overlapping hopping channels.

3.4.2 Measuring Instruments and Setting

Please refer to section 4 of equipments list in this report. The following table is the setting of spectrum analyzer.

Spectrum Parameters	Setting
Attenuation	Auto
Span Frequency	> Operating Frequency Range
RB	100 kHz
VB	100 kHz
Detector	Peak
Trace	Max Hold
Sweep Time	Auto

3.4.3 Test Procedures

1. The transmitter output (antenna port) was connected to the spectrum analyzer in peak hold mode.
2. The resolution bandwidth of 100 kHz and the video bandwidth of 100 kHz were utilized.
3. Observe frequency hopping in 2400MHz~2483.5MHz, there are at least 75 non-overlapping channels.

3.4.4 Test Setup Layout

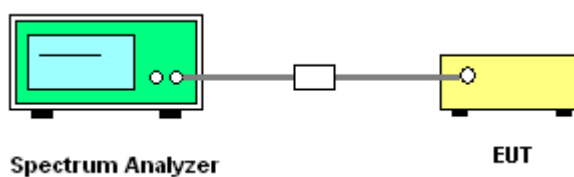

3.4.5 Test Deviation

There is no deviation with the original standard.

3.4.6 EUT Operation during Test

The EUT was programmed to be in continuously transmitting mode.

3.4.7 Test Result of Number of Hopping Frequency

Final Test Date	Sep. 21, 2009	Test Site No.	TH01-HY
Temperature	25	Humidity	56%
Test Engineer	Duncan	Configurations	8DPSK

Modulation Type	Channel No.	Frequency (MHz)	Hopping Ch. (Channels)	Min. Limit (Channels)	Test Result
GFSK	0 ~ 78	2402 ~ 2480	79	75	Complies

Number of Hopping Channel Plot on Channel 0~78 / 2402 MHz ~ 2480 MHz

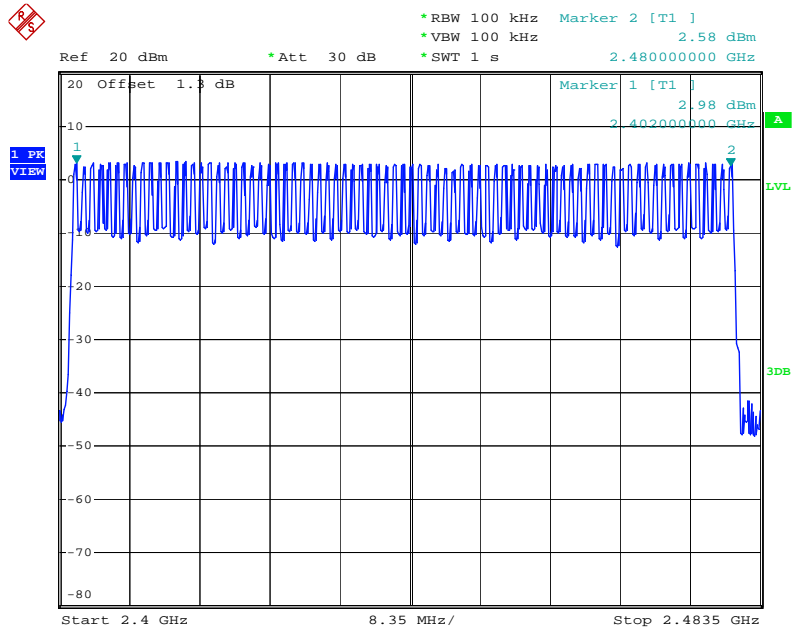

Date: 21.SEP.2009 15:30:06

3.5 Dwell Time Measurement

3.5.1 Limit

Frequency hopping systems in the 2400-2483.5 MHz band shall use at least 15 channels. The average time of occupancy on any channel shall not be greater than 0.4 seconds within a period of 0.4 seconds multiplied by the number of hopping channels employed.

3.5.2 Measuring Instruments and Setting

Please refer to section 4 of equipments list in this report. The following table is the setting of spectrum analyzer.

Spectrum Parameter	Setting
Attenuation	Auto
Span Frequency	0 MHz
RB	1 MHz
VB	1 MHz
Detector	Peak
Trace	Single Trigger

3.5.3 Test Procedures

1. The transmitter output (antenna port) was connected to the spectrum analyzer
2. Set RBW of spectrum analyzer to 1MHz and VBW to 1MHz.
3. Use a video trigger with the trigger level set to enable triggering only on full pulses.
4. Sweep Time is more than once pulse time.
5. Set the center frequency on any frequency would be measure and set the frequency span to zero span.
6. Measure the maximum time duration of one single pulse.
7. Set the EUT for DH5, DH3 and DH1 packet transmitting.
8. Measure the maximum time duration of one single pulse.
9. DH5 Packet permit maximum $1600 / 79 / 6 = 3.37$ hops per second in each channel (5 time slots RX, 1 time slot TX). So, the dwell time is the time duration of the pulse times $3.37 \times 31.6 = 106.6$ within 31.6 seconds
10. DH3 Packet permit maximum $1600 / 79 / 4 = 5.06$ hops per second in each channel (3 time slots RX, 1 time slot TX). So, the dwell time is the time duration of the pulse times $5.06 \times 31.6 = 160$ within 31.6 seconds.
11. DH1 Packet permit maximum $1600 / 79 / 2 = 10.12$ hops per second in each channel (1 time slot RX, 1 time slot TX). So, the dwell time is the time duration of the pulse times $10.12 \times 31.6 = 320$ within 31.6 seconds.

3.5.4 Test Setup Layout

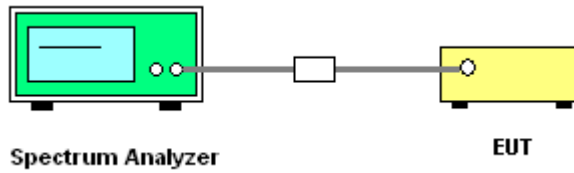

3.5.5 Test Deviation

There is no deviation with the original standard.

3.5.6 EUT Operation during Test

The EUT was programmed to be in continuously transmitting mode.

3.5.7 Test Result of Dwell Time

Final Test Date	Sep. 21, 2009	Test Site No.	TH01-HY
Temperature	25	Humidity	56%
Test Engineer	Duncan	Configurations	8DPSK 3DH1/3DH3/3DH5

Data Packet	Frequency	Pulse Duration (ms)	Dwell Time (s)	Limits (s)	Test Result
DH5	2402 MHz	3.0800	0.3285	0.4000	Complies
DH3	2402 MHz	1.8200	0.2912	0.4000	Complies
DH1	2402 MHz	0.5600	0.1792	0.4000	Complies
DH5	2441 MHz	3.0800	0.3285	0.4000	Complies
DH3	2441 MHz	1.8200	0.2912	0.4000	Complies
DH1	2441 MHz	0.5600	0.1792	0.4000	Complies
DH5	2480 MHz	3.0800	0.3285	0.4000	Complies
DH3	2480 MHz	1.8200	0.2912	0.4000	Complies
DH1	2480 MHz	0.5600	0.1792	0.4000	Complies

DH5 Dwell Time Plot on Channel 0 / 2402 MHz

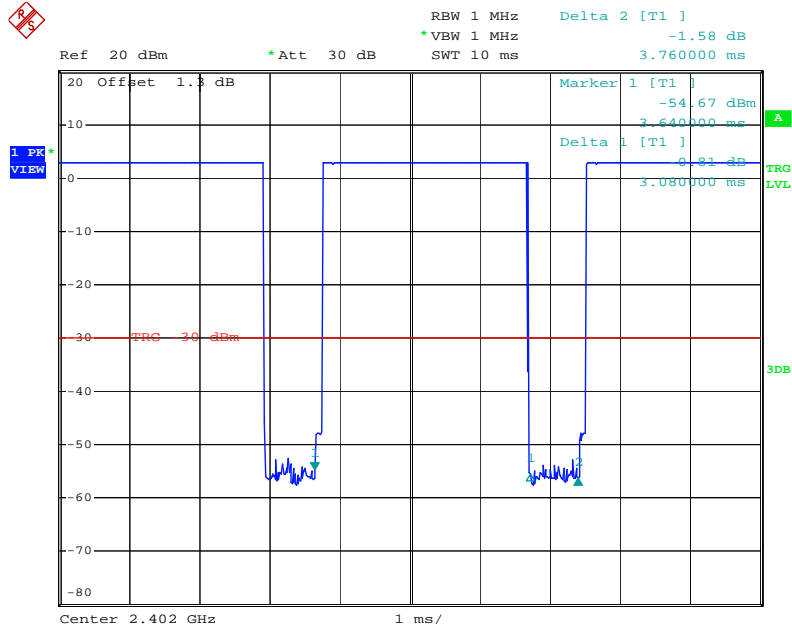

Date: 21.SEP.2009 15:11:45

DH3 Dwell Time Plot on Channel 0 / 2402 MHz

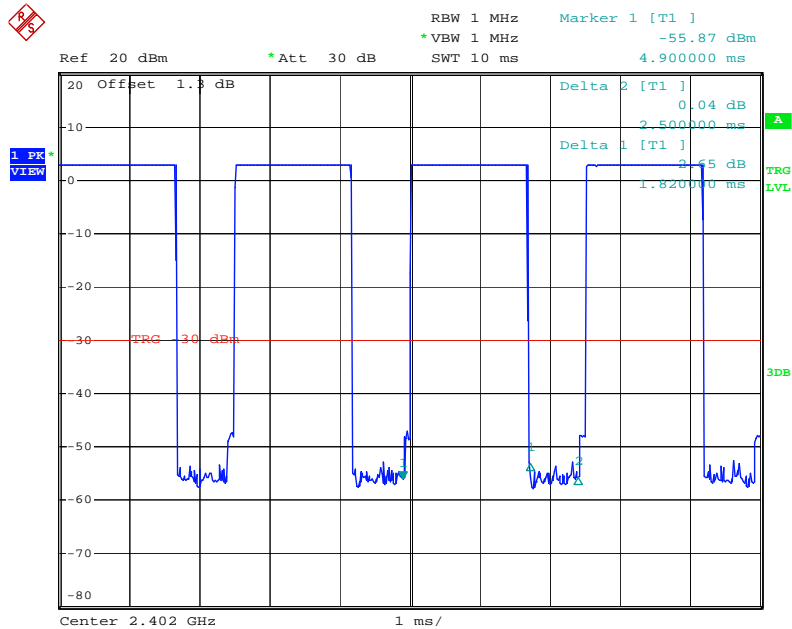

Date: 21.SEP.2009 15:11:16

DH1 Dwell Time Plot on Channel 0 / 2402 MHz

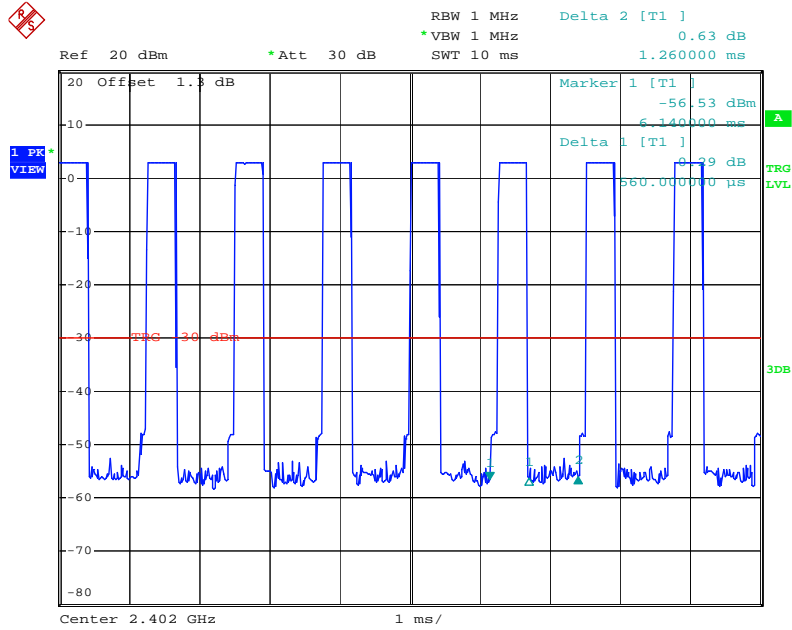

Date: 21.SEP.2009 15:07:22

DH5 Dwell Time Plot on Channel 39 / 2441 MHz

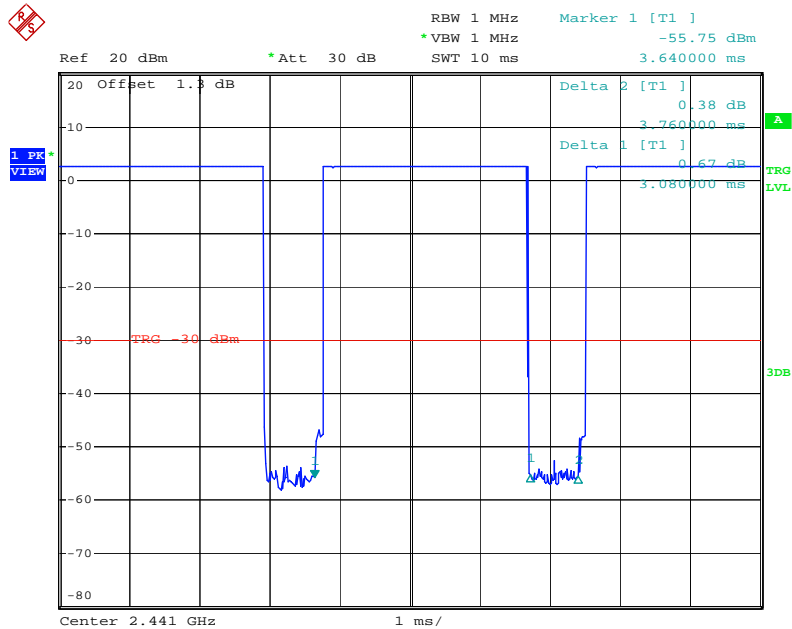

Date: 21.SEP.2009 15:12:16

DH3 Dwell Time Plot on Channel 39 / 2441 MHz

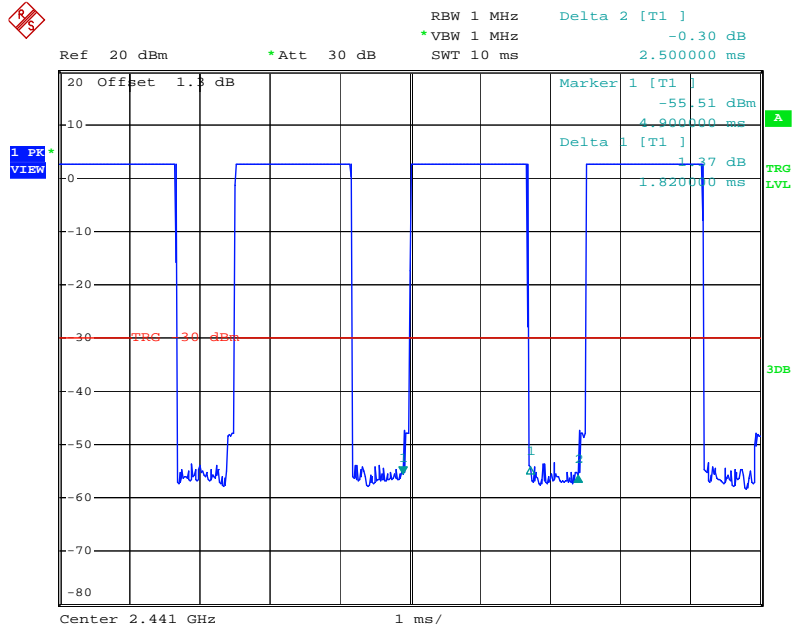

Date: 21.SEP.2009 15:10:43

DH1 Dwell Time Plot on Channel 39 / 2441 MHz

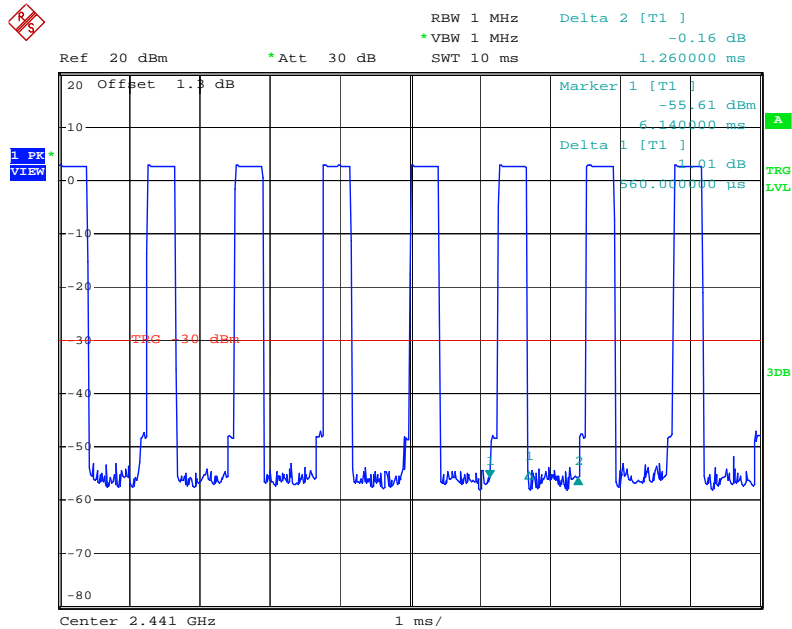

Date: 21.SEP.2009 15:08:54

DH5 Dwell Time Plot on Channel 78 / 2480 MHz

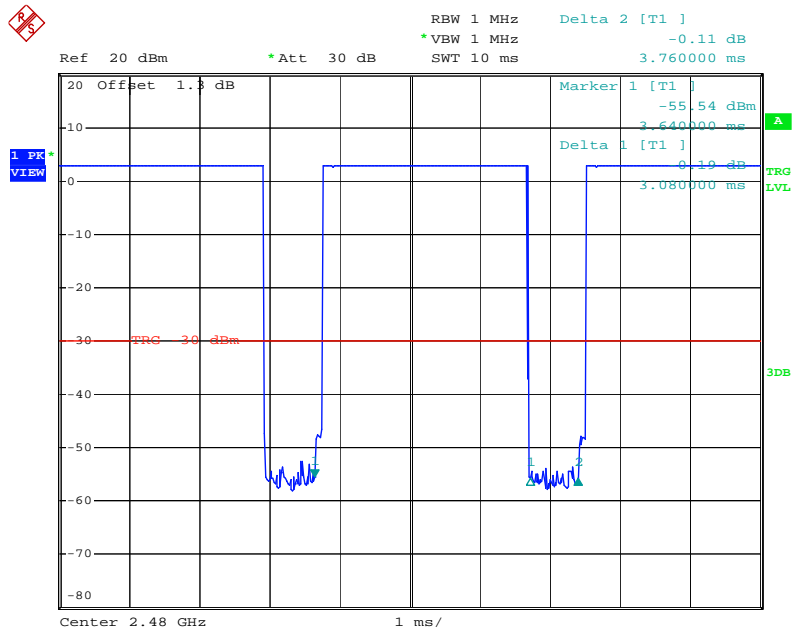

Date: 21.SEP.2009 15:12:45

DH3 Dwell Time Plot on Channel 78 / 2480 MHz

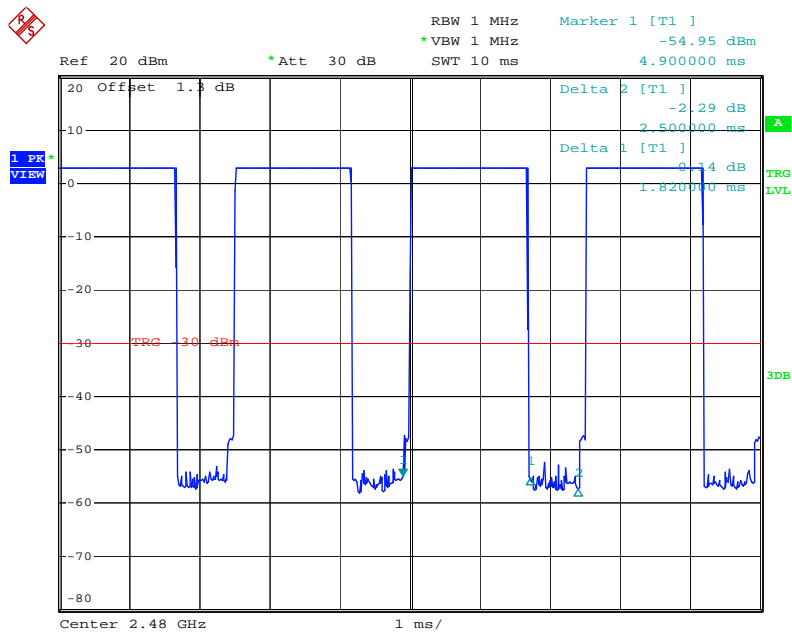

Date: 21.SEP.2009 15:10:11

DH1 Dwell Time Plot on Channel 78 / 2480 MHz

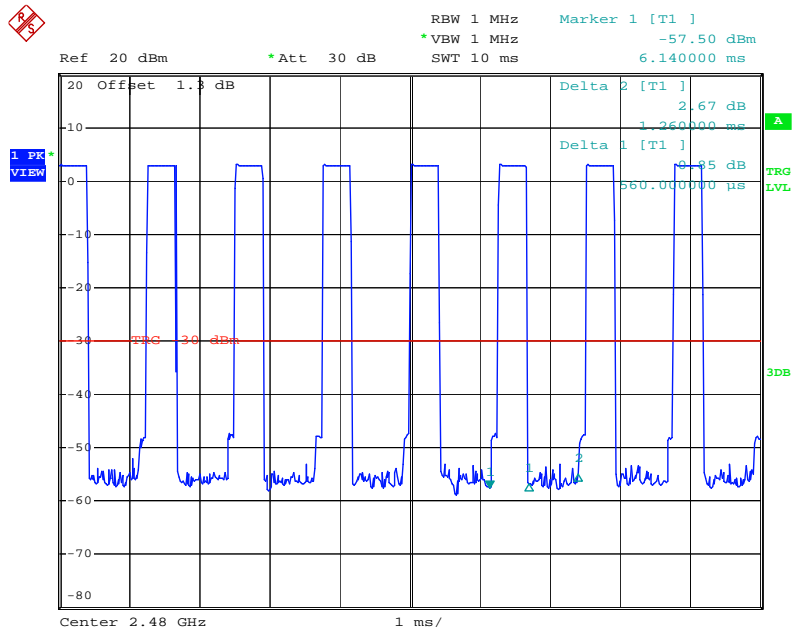

Date: 21.SEP.2009 15:09:25

3.6 Radiated Emissions Measurement

3.6.1 Limit

20dBc in any 100 kHz bandwidth outside the operating frequency band. In case the emission fall within the restricted band specified on 15.205(a), then the 15.209(a) limit in the table below has to be followed.

Frequencies (MHz)	Field Strength (micorvolts/meter)	Measurement Distance (meters)
0.009~0.490	2400/F(KHz)	300
0.490~1.705	24000/F(KHz)	30
1.705~30.0	30	30
30~88	100	3
88~216	150	3
216~960	200	3
Above 960	500	3

3.6.2 Measuring Instruments and Setting

Please refer to section 4 of equipments list in this report. The following table is the setting of spectrum analyzer and receiver.

Spectrum Parameter	Setting
Attenuation	Auto
Start Frequency	1000 MHz
Stop Frequency	10th carrier harmonic
RB / VB (Emission in restricted band)	1MHz / 1MHz for Peak, 1 MHz / 10Hz for Average
RB / VB (Emission in non-restricted band)	1MHz / 1MHz for peak

Receiver Parameter	Setting
Attenuation	Auto
Start ~ Stop Frequency	9kHz~150kHz / RB 200Hz for QP
Start ~ Stop Frequency	150kHz~30MHz / RB 9kHz for QP
Start ~ Stop Frequency	30MHz~1000MHz / RB 120kHz for QP

3.6.3 Test Procedures

1. Configure the EUT according to ANSI C63.4. The EUT was placed on the top of the turntable 0.8 meter above ground. The phase center of the receiving antenna mounted on the top of a height-variable antenna tower was placed 3 meters far away from the turntable.
2. Power on the EUT and all the supporting units. The turntable was rotated by 360 degrees to determine the position of the highest radiation.
3. The height of the broadband receiving antenna was varied between one meter and four meters above ground to find the maximum emissions field strength of both horizontal and vertical polarization.
4. For each suspected emissions, the antenna tower was scan (from 1 M to 4 M) and then the turntable was rotated (from 0 degree to 360 degrees) to find the maximum reading.
5. Set the test-receiver system to Peak or CISPR quasi-peak Detect Function with specified bandwidth under Maximum Hold Mode.
6. For emissions above 1GHz, use 1MHz VBW and RBW for peak reading. Then 1MHz RBW and 10Hz VBW for average reading in spectrum analyzer.
7. When the radiated emissions limits are expressed in terms of the average value of the emissions, and pulsed operation is employed, the measurement field strength shall be determined by averaging over one complete pulse train, including blanking intervals, as long as the pulse train does not exceed 0.1 seconds. As an alternative (provided the transmitter operates for longer than 0.1 seconds) or in cases where the pulse train exceeds 0.1 seconds, the measured field strength shall be determined from the average absolute voltage during a 0.1 second interval during which the field strength is at its maximum value.
8. If the emissions level of the EUT in peak mode was 3 dB lower than the average limit specified, then testing will be stopped and peak values of EUT will be reported, otherwise, the emissions which do not have 3 dB margin will be repeated one by one using the quasi-peak method for below 1GHz.
9. For testing above 1GHz, the emissions level of the EUT in peak mode was lower than average limit (that means the emissions level in peak mode also complies with the limit in average mode), then testing will be stopped and peak values of EUT will be reported, otherwise, the emissions will be measured in average mode again and reported.
10. In case the emission is lower than 30MHz, loop antenna has to be used for measurement and the recorded data should be QP measured by receiver. High – Low scan is not required in this case.

3.6.4 Test Setup Layout

For radiated emissions below 30MHz

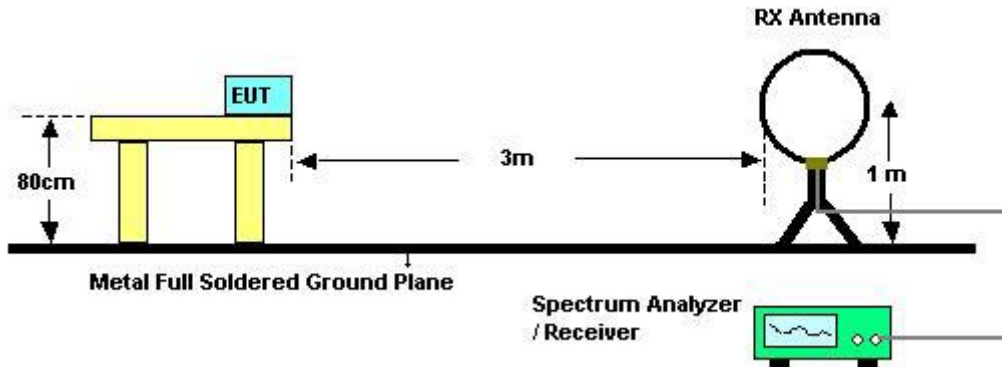

For radiated emissions above 30MHz

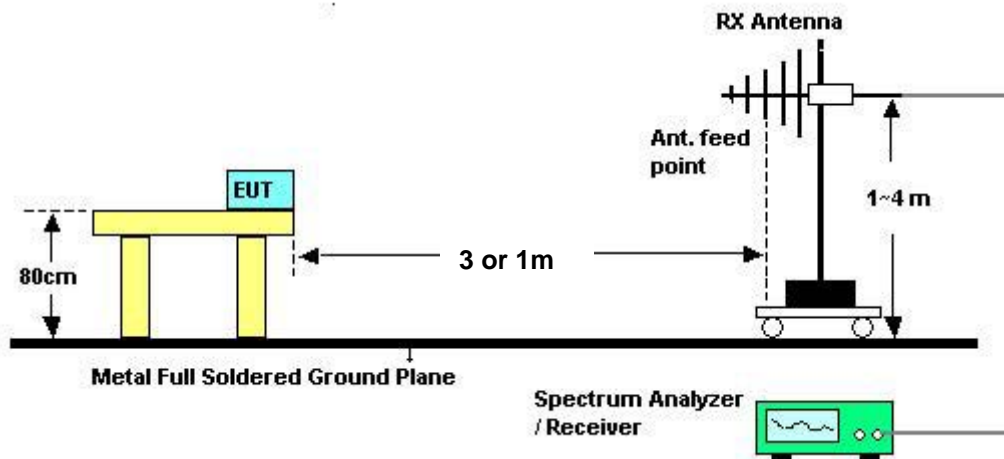

Above 10 GHz shall be extrapolated to the specified distance using an extrapolation factor of 20 dB/decade from 3m to 1m.

Distance extrapolation factor = $20 \log (\text{specific distance [3m]} / \text{test distance [1m]})$ (dB);

Limit line = specific limits (dBuV) + distance extrapolation factor [9.54 dB].

3.6.5 Test Deviation

There is no deviation with the original standard.

3.6.6 EUT Operation during Test

The EUT was programmed to be in continuously transmitting mode.

3.6.7 Results of Radiated Emissions (9kHz~30MHz)

Final Test Date	Oct. 16, 2009	Test Site No.	03CH02-HY
Temperature	25.5	Humidity	52%
Test Engineer	Kobe		

Freq. (MHz)	Level (dBuV)	Over Limit (dB)	Limit Line (dBuV)	Remark
-	-	-	-	See Note

Note:

The amplitude of spurious emissions which are attenuated by more than 20dB below the permissible value has no need to be reported.

Distance extrapolation factor = $40 \log(\text{specific distance} / \text{test distance})$ (dB);

Limit line = specific limits (dBuV) + distance extrapolation factor.

3.6.8 Results of Radiated Emissions (30MHz~1GHz)

Final Test Date	Oct. 16, 2009	Test Site No.	03CH02-HY
Temperature	25.5	Humidity	52%
Test Engineer	Kobe	Configuration	Channel 39

Horizontal

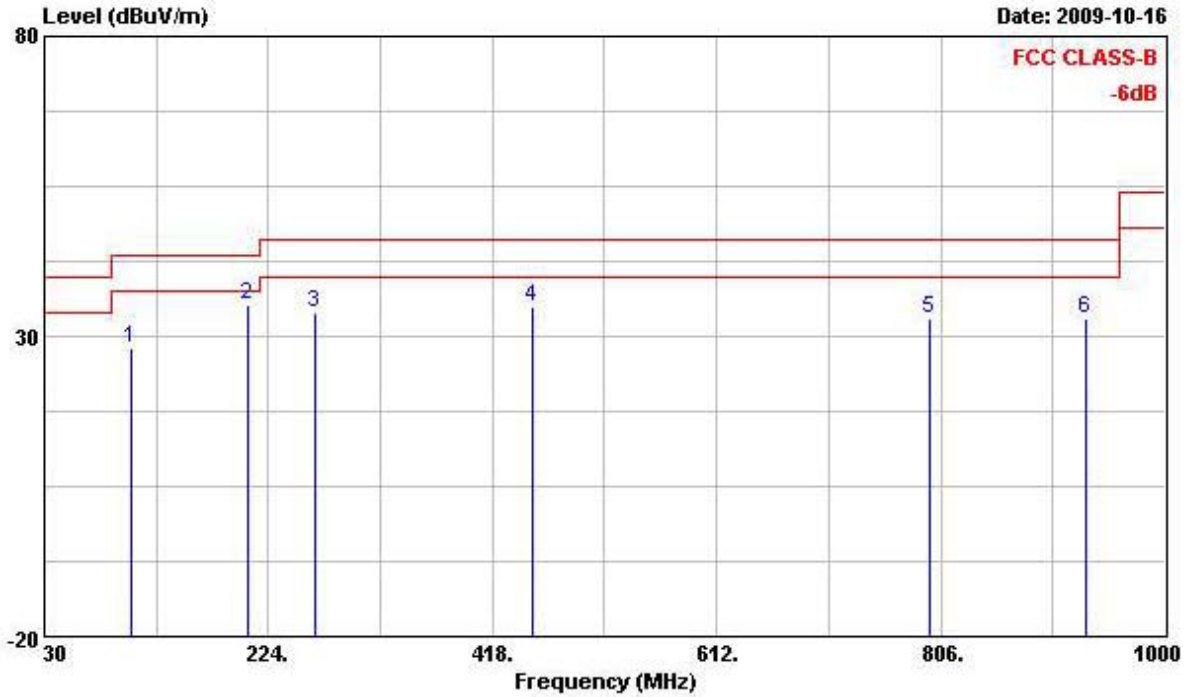

	Freq	Level	Over Limit	Limit Line	ReadAntenna Level	Antenna Factor	Cable Loss	Preamp Factor	Remark
	MHz	dBuV/m	dB	dBuV/m	dBuV	dB/m	dB	dB	
1	105.660	28.04	-15.46	43.50	44.86	11.88	2.09	30.79	Peak
2	206.540	35.15	-8.35	43.50	51.29	11.57	2.88	30.59	Peak
3	263.770	33.86	-12.14	46.00	47.92	13.19	3.22	30.47	Peak
4	451.950	34.81	-11.19	46.00	44.45	16.31	4.09	30.04	Peak
5	797.270	33.11	-12.89	46.00	36.40	20.23	5.49	29.01	Peak
6	932.100	32.91	-13.09	46.00	34.62	20.82	6.04	28.57	Peak

Vertical

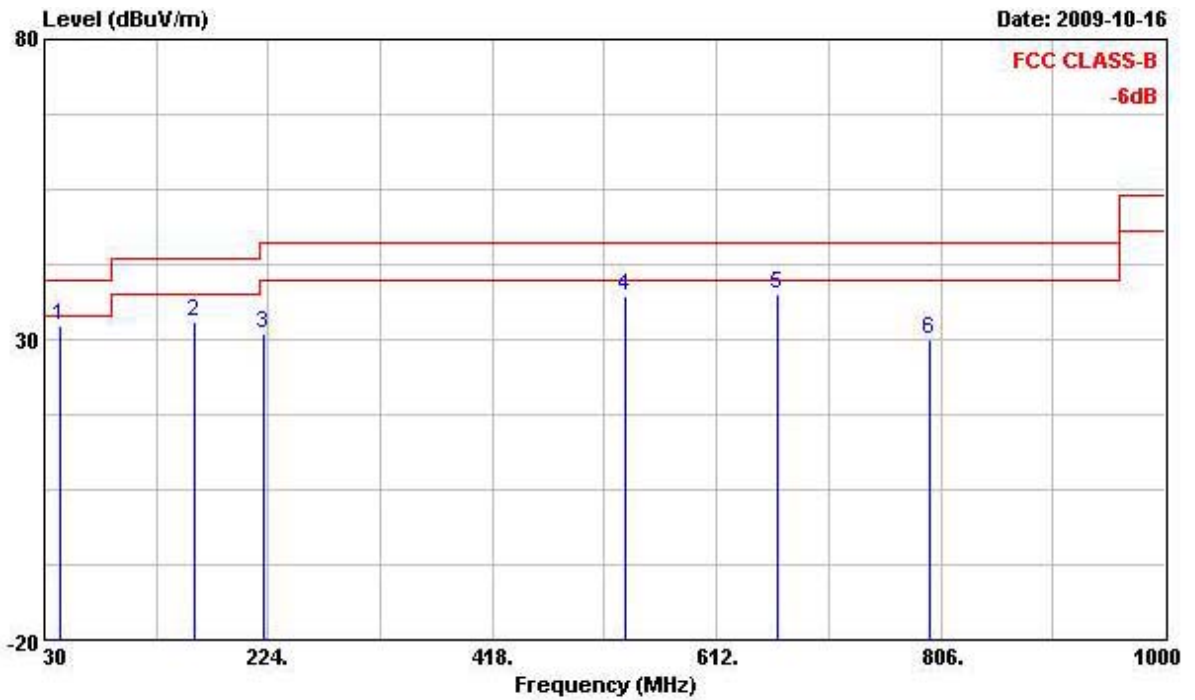

	Freq	Level	Over Limit	Limit Line	ReadAntenna Level	Antenna Factor	Cable Loss	Preamp Factor	Remark
	MHz	dBUV/m	dB	dBUV/m	dBUV	dB/m	dB	dB	
1	43.580	32.17	-7.83	40.00	49.35	12.27	1.38	30.83	Peak
2	159.980	33.05	-10.45	43.50	50.62	10.55	2.56	30.68	Peak
3	219.150	30.85	-15.15	46.00	46.49	11.98	2.94	30.56	Peak
4	532.460	37.16	-8.84	46.00	44.35	18.21	4.40	29.80	Peak
5	664.380	37.56	-8.44	46.00	42.43	19.32	5.15	29.34	Peak
6	797.270	30.14	-15.86	46.00	33.43	20.23	5.49	29.01	Peak

Note:

The amplitude of spurious emissions which are attenuated by more than 20dB below the permissible value has no need to be reported.

Emission level (dBUV/m) = 20 log Emission level (uV/m).

Corrected Reading: Antenna Factor + Cable Loss + Read Level - Preamp Factor = Level.

3.6.9 Results for Radiated Emissions (1GHz~10th Harmonic)

Final Test Date	Oct. 16, 2009	Test Site No.	03CH02-HY
Temperature	25.5	Humidity	52%
Test Engineer	Kobe	Configurations	Channel 0

Horizontal

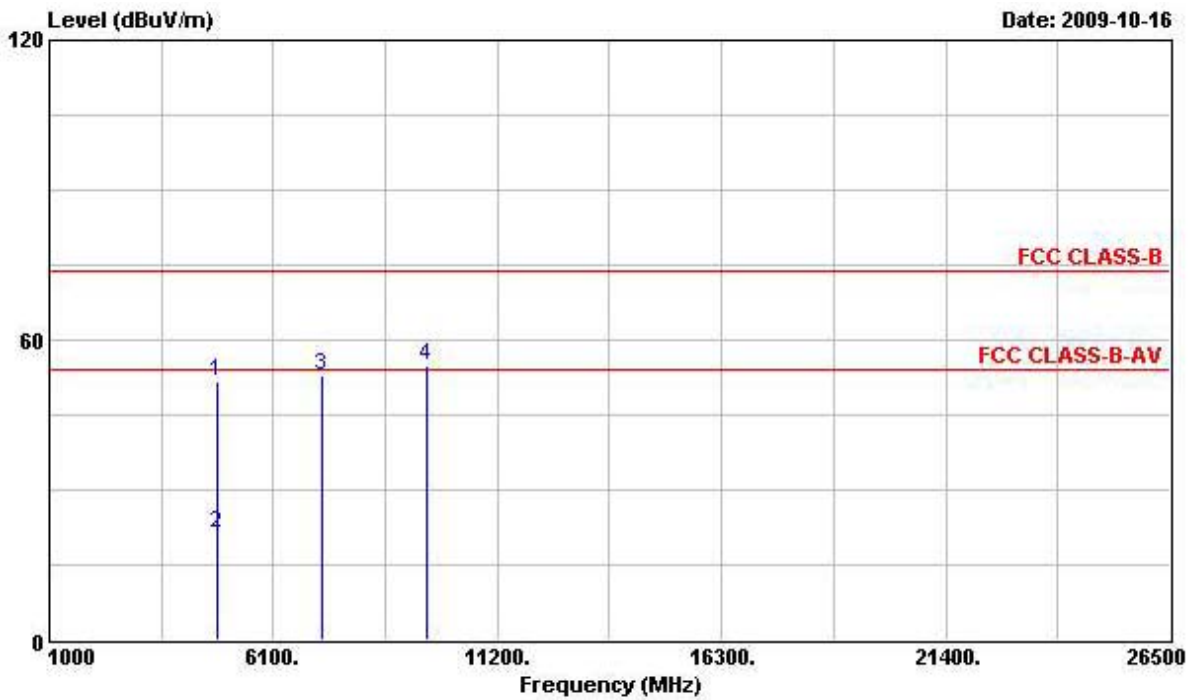

	Freq	Level	Over Limit	Limit Line	ReadAntenna Level	Antenna Factor	Cable Loss	Preamp Factor	Remark
	MHz	dBuV/m	dB	dBuV/m	dBuV	dB/m	dB	dB	
1	4804.000	51.89	-22.11	74.00	46.13	35.73	4.58	34.55	Peak
2	4804.000	21.38	-32.62	54.00	15.62	35.73	4.58	34.55	Average
3	7206.000	52.97			43.80	37.84	5.62	34.29	Peak
4	9608.000	54.71			43.69	39.32	6.34	34.64	Peak

Note: An item 3 and 4 are on un-restricted band, so the limit is -20dB for the field strength of the fundamental emissions (see section 3.7.7).

Vertical

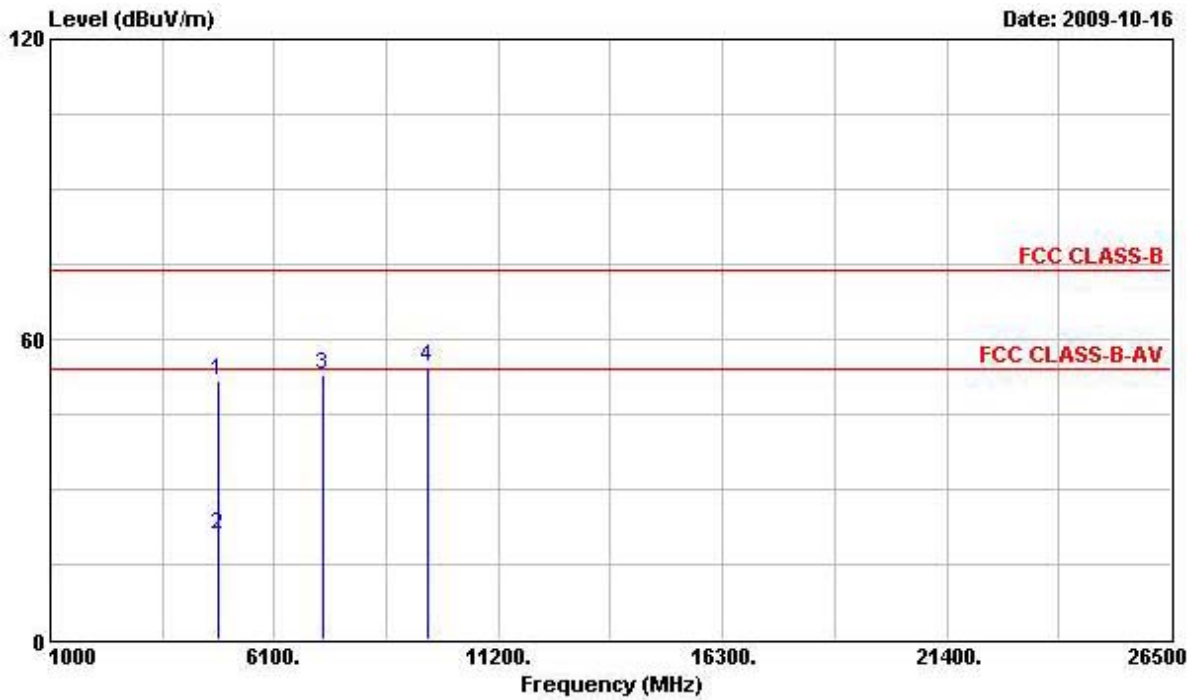

	Freq	Level	Over Limit	Limit Line	ReadAntenna Level	Antenna Factor	Cable Loss	Preamp Factor	Remark
	MHz	dBuV/m	dB	dBuV/m	dBuV	dB/m	dB	dB	
1	4804.000	51.58	-22.42	74.00	46.44	35.11	4.58	34.55	Peak
2	4804.000	20.87	-33.13	54.00	15.73	35.11	4.58	34.55	Average
3	7206.000	52.74			44.53	36.88	5.62	34.29	Peak
4	9608.000	54.39			44.17	38.52	6.34	34.64	Peak

Note: An item 3 and 4 are on un-restricted band, so the limit is -20dB for the field strength of the fundamental emissions (see section 3.7.7).

Final Test Date	Oct. 16, 2009	Test Site No.	03CH02-HY
Temperature	25.5	Humidity	52%
Test Engineer	Kobe	Configurations	Channel 39

Horizontal

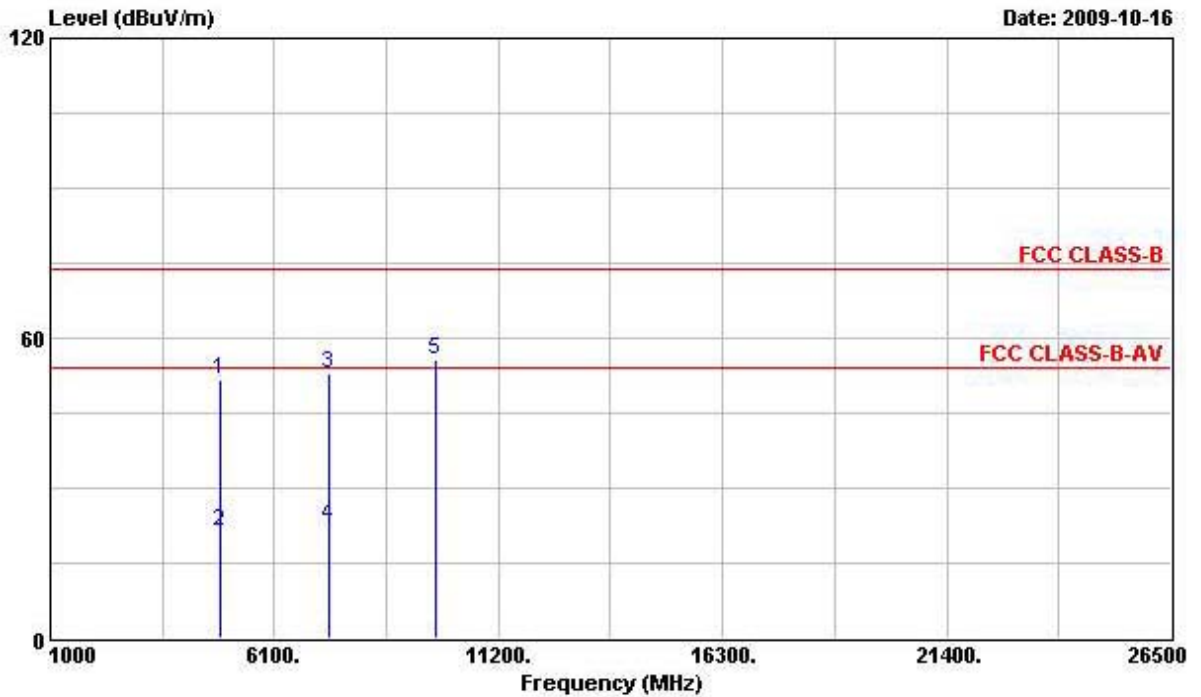

	Freq	Level	Over Limit	Limit Line	ReadAntenna Level	Antenna Factor	Cable Loss	Preamp Factor	Remark
	MHz	dBuV/m	dB	dBuV/m	dBuV	dB/m	dB	dB	
1	4882.000	51.89	-22.11	74.00	45.87	35.83	4.64	34.45	Peak
2	4882.000	21.38	-32.62	54.00	15.36	35.83	4.64	34.45	Average
3	7323.000	53.00	-21.00	74.00	43.78	37.87	5.64	34.29	Peak
4	7323.000	22.49	-31.51	54.00	13.27	37.87	5.64	34.29	Average
5	9764.000	55.48			44.16	39.53	6.36	34.57	Peak

Note: An item 5 is on un-restricted band, so the limit is -20dB for the field strength of the fundamental emissions (see section 3.7.7).

Vertical

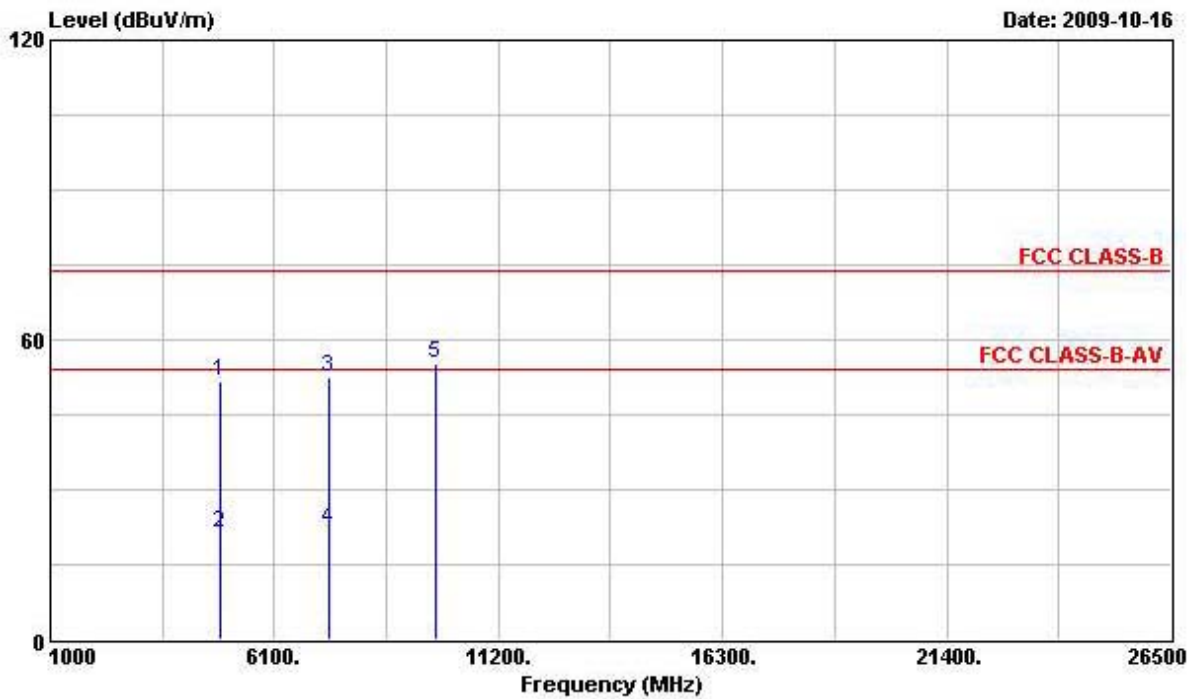

	Freq	Level	Over Limit	Limit Line	ReadAntenna Level	Antenna Factor	Cable Loss	Preamp Factor	Remark
	MHz	dBuV/m	dB	dBuV/m	dBuV	dB/m	dB	dB	
1	4882.000	51.75	-22.25	74.00	46.38	35.18	4.64	34.45	Peak
2	4882.000	21.24	-32.76	54.00	15.87	35.18	4.64	34.45	Average
3	7323.000	52.44	-21.56	74.00	44.16	36.93	5.64	34.29	Peak
4	7323.000	21.93	-32.07	54.00	13.65	36.93	5.64	34.29	Average
5	9764.000	55.10			44.58	38.73	6.36	34.57	Peak

Note: An item 5 is on un-restricted band, so the limit is -20dB for the field strength of the fundamental emissions (see section 3.7.7).

Final Test Date	Oct. 16, 2009	Test Site No.	03CH02-HY
Temperature	25.5	Humidity	52%
Test Engineer	Kobe	Configurations	Channel 78

Horizontal

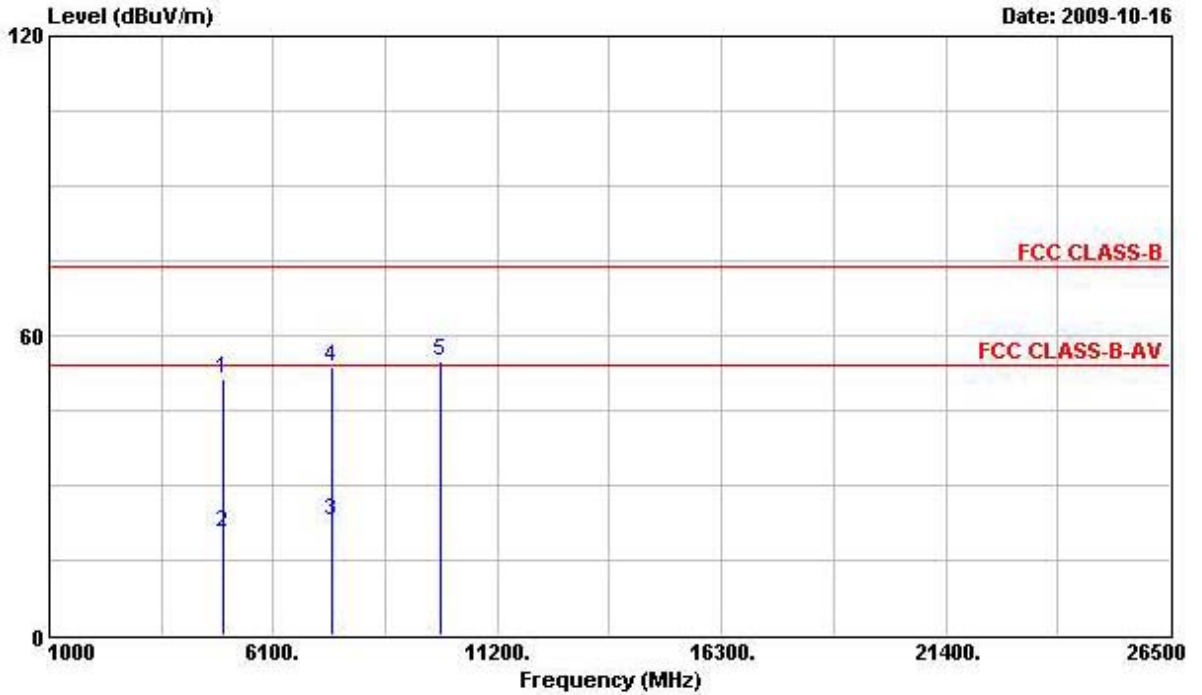

	Freq	Level	Over Limit	Limit Line	ReadAntenna Level	Antenna Factor	Cable Loss	Preamp Factor	Remark
	MHz	dBuV/m	dB	dBuV/m	dBuV	dB/m	dB	dB	
1	4960.000	51.17	-22.83	74.00	44.86	35.95	4.71	34.35	Peak
2	4960.000	20.66	-33.34	54.00	14.35	35.95	4.71	34.35	Average
3	7440.000	23.02	-30.98	54.00	13.77	37.89	5.65	34.29	Average
4	7440.000	53.53	-20.47	74.00	44.28	37.89	5.65	34.29	Peak
5	9920.000	54.89			43.29	39.72	6.39	34.51	Peak

Note: An item 5 is on un-restricted band, so the limit is -20dB for the field strength of the fundamental emissions (see section 3.7.7).

Vertical

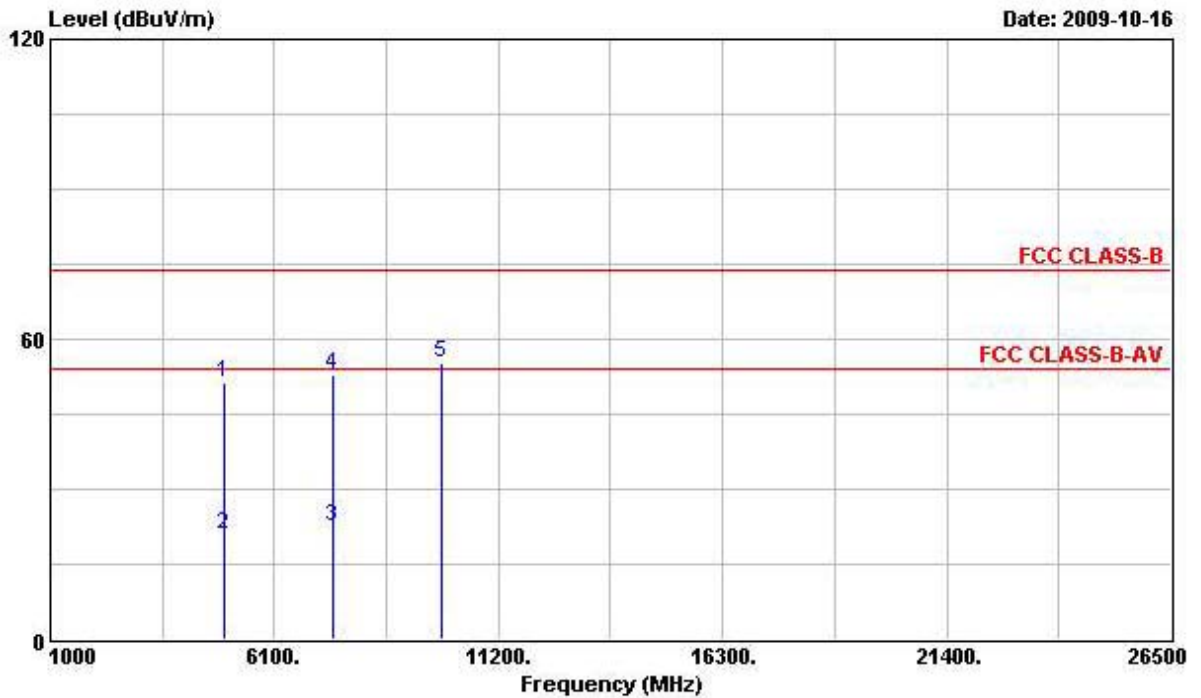

	Freq	Level	Over Limit	Limit Line	ReadAntenna Level	Antenna Factor	Cable Loss	Preamp Factor	Remark
	MHz	dBuV/m	dB	dBuV/m	dBuV	dB/m	dB	dB	
1	4960.000	51.49	-22.51	74.00	45.86	35.27	4.71	34.35	Peak
2	4960.000	20.98	-33.02	54.00	15.35	35.27	4.71	34.35	Average
3	7440.000	22.56	-31.44	54.00	14.22	36.98	5.65	34.29	Average
4	7440.000	53.07	-20.93	74.00	44.73	36.98	5.65	34.29	Peak
5	9920.000	55.21			44.41	38.92	6.39	34.51	Peak

Note: An item 5 is on un-restricted band, so the limit is -20dB for the field strength of the fundamental emissions (see section 3.7.7).

The amplitude of spurious emissions, which are attenuated by more than 20dB below, the permissible value has no need to be reported.

Emission level (dBUV/m) = 20 log Emission level (uV/m).

Corrected Reading: Antenna Factor + Cable Loss + Read Level - Preamp Factor = Level.

3.7 Band Edge and Fundamental Emissions Measurement

3.7.1 Limit

20dBc in any 100 kHz bandwidth outside the operating frequency band. In case the emission fall within the restricted band specified on 15.205(a), then the 15.209(a) limit in the table below has to be followed.

Frequencies (MHz)	Field Strength (micorvolts/meter)	Measurement Distance (meters)
0.009~0.490	2400/F(KHz)	300
0.490~1.705	24000/F(KHz)	30
1.705~30.0	30	30
30~88	100	3
88~216	150	3
216~960	200	3
Above 960	500	3

3.7.2 Measuring Instruments and Setting

Please refer to section 4 of equipments list in this report. The following table is the setting of the spectrum analyzer.

Spectrum Parameter	Setting
Attenuation	Auto
Span Frequency	100 MHz
RB / VB (Emission in restricted band)	1MHz / 1MHz for Peak, 1 MHz / 10Hz for Average
RB / VB (Emission in non-restricted band)	1MHz/1MHz for Peak

3.7.3 Test Procedures

1. The test procedure is the same as section 3.5.3, only the frequency range investigated is limited to 100MHz around band edges.
2. In case the emission is fail due to the used RB/VB is too wide, marker-delta method of FCC Public Notice DA00-705 will be followed.

3.7.4 Test Setup Layout

This test setup layout is the same as that shown in section 3.6.4.

3.7.5 Test Deviation

There is no deviation with the original standard.

3.7.6 EUT Operation during Test

The EUT was programmed to be in continuously transmitting mode.

3.7.7 Test Result of Band Edge and Fundamental Emissions

Final Test Date	Oct. 20, 2009	Test Site No.	03CH02-HY
Temperature	25.5	Humidity	52%
Test Engineer	Kobe	Configurations	Channel 0, 39, 78

1Mbps

Channel 0

	Freq	Level	Over Limit	Limit Line	ReadAntenna Level	Antenna Factor	Cable Loss	Preamp Factor	Remark
	MHz	dBuV/m	dB	dBuV/m	dBuV	dB/m	dB	dB	
1	2314.940	62.22	-11.78	74.00	27.82	31.44	2.96	0.00	Peak
2 @	2402.340	95.34			60.53	31.79	3.02	0.00	Peak
1 @	2373.650	48.37	-5.63	54.00	13.66	31.72	2.99	0.00	Average
2 @	2401.770	75.35			40.54	31.79	3.02	0.00	Average

An item 2 is Fundamental Emissions.

Channel 39

	Freq	Level	Over Limit	Limit Line	ReadAntenna Level	Antenna Factor	Cable Loss	Preamp Factor	Remark
	MHz	dBuV/m	dB	dBuV/m	dBuV	dB/m	dB	dB	
1 @	2441.100	95.63			60.59	31.99	3.05	0.00	Peak
1 @	2441.100	75.53			40.49	31.99	3.05	0.00	Average

An item 1 is Fundamental Emissions.

Channel 78

	Freq	Level	Over Limit	Limit Line	ReadAntenna Level	Antenna Factor	Cable Loss	Preamp Factor	Remark
	MHz	dBuV/m	dB	dBuV/m	dBuV	dB/m	dB	dB	
1 @	2480.050	96.82			61.61	32.13	3.08	0.00	Peak
2	2483.500	65.08	-8.92	74.00	29.87	32.13	3.08	0.00	Peak
1 @	2479.860	76.54			41.33	32.13	3.08	0.00	Average
2	2483.500	27.60	-26.40	54.00	-7.61	32.13	3.08	0.00	Average

An item 1 is Fundamental Emissions.

Note:

Emission level (dBuV/m) = 20 log Emission level (uV/m).

Corrected Reading: Antenna Factor + Cable Loss + Read Level - Preamp Factor = Level.

2Mbps

Channel 0

	Freq	Level	Over Limit	Limit Line	ReadAntenna Level	Antenna Factor	Cable Loss	Preamp Factor	Remark
	MHz	dBuV/m	dB	dBuV/m	dBuV	dB/m	dB	dB	
1	2389.610	59.81	-14.19	74.00	25.00	31.79	3.02	0.00	Peak
2 @	2401.770	92.20			57.39	31.79	3.02	0.00	Peak
1 @	2369.090	47.69	-6.31	54.00	12.98	31.72	2.99	0.00	Average
2 @	2401.770	72.71			37.90	31.79	3.02	0.00	Average

An item 2 is Fundamental Emissions.

Channel 39

	Freq	Level	Over Limit	Limit Line	ReadAntenna Level	Antenna Factor	Cable Loss	Preamp Factor	Remark
	MHz	dBuV/m	dB	dBuV/m	dBuV	dB/m	dB	dB	
1 @	2440.530	92.34			57.30	31.99	3.05	0.00	Peak
1 @	2441.100	72.92			37.88	31.99	3.05	0.00	Average

An item 1 is Fundamental Emissions.

Channel 78

	Freq	Level	Over Limit	Limit Line	ReadAntenna Level	Antenna Factor	Cable Loss	Preamp Factor	Remark
	MHz	dBuV/m	dB	dBuV/m	dBuV	dB/m	dB	dB	
1 @	2479.860	93.23			58.02	32.13	3.08	0.00	Peak
2	2483.500	64.30	-9.70	74.00	29.09	32.13	3.08	0.00	Peak
1 @	2479.860	73.56			38.35	32.13	3.08	0.00	Average
2	2483.500	24.33	-29.67	54.00	-10.88	32.13	3.08	0.00	Average

An item 1 is Fundamental Emissions.

Note:

Emission level (dBuV/m) = 20 log Emission level (uV/m).

Corrected Reading: Antenna Factor + Cable Loss + Read Level - Preamp Factor = Level.

3Mbps

Channel 0

	Freq	Level	Over Limit	Limit Line	Read Level	Antenna Factor	Cable Loss	Preamp Factor	Remark
	MHz	dBuV/m	dB	dBuV/m	dBuV	dB/m	dB	dB	
1	2385.810	60.80	-13.20	74.00	25.99	31.79	3.02	0.00	Peak
2 @	2401.770	101.10			66.29	31.79	3.02	0.00	Peak
1 @	2375.740	47.91	-6.09	54.00	13.20	31.72	2.99	0.00	Average
2 @	2401.770	78.24			43.43	31.79	3.02	0.00	Average

An item 2 is Fundamental Emissions.

Channel 39

	Freq	Level	Over Limit	Limit Line	Read Level	Antenna Factor	Cable Loss	Preamp Factor	Remark
	MHz	dBuV/m	dB	dBuV/m	dBuV	dB/m	dB	dB	
1 @	2441.100	99.91			64.87	31.99	3.05	0.00	Peak
2	2492.970	60.20	-13.80	74.00	24.92	32.20	3.08	0.00	Peak
1 @	2441.100	77.52			42.48	31.99	3.05	0.00	Average
2 @	2496.580	48.20	-5.80	54.00	12.92	32.20	3.08	0.00	Average

An item 1 is Fundamental Emissions.

Channel 78

	Freq	Level	Over Limit	Limit Line	Read Level	Antenna Factor	Cable Loss	Preamp Factor	Remark
	MHz	dBuV/m	dB	dBuV/m	dBuV	dB/m	dB	dB	
1 @	2480.050	101.45			66.24	32.13	3.08	0.00	Peak
2 @	2483.500	70.13	-3.87	74.00	34.92	32.13	3.08	0.00	Peak
1 @	2480.050	78.57			43.36	32.13	3.08	0.00	Average
2	2483.500	31.85	-22.15	54.00	-3.36	32.13	3.08	0.00	Average

An item 1 is Fundamental Emissions.

Note:

Emission level (dBuV/m) = 20 log Emission level (uV/m).

Corrected Reading: Antenna Factor + Cable Loss + Read Level - Preamp Factor = Level.

For Emission not in Restricted Band

Low Band Edge Plot on Channel 0 / 2402 MHz

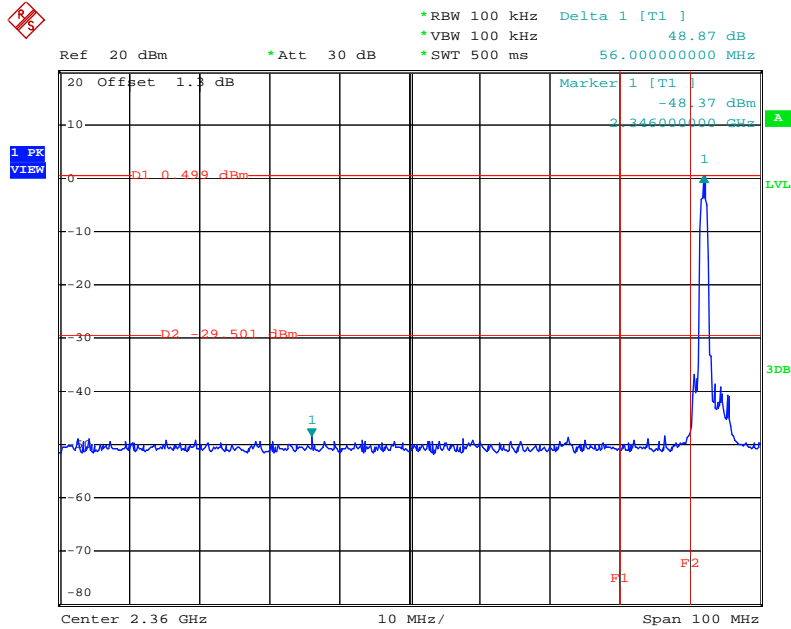

Date: 21.SEP.2009 15:19:14

High Band Edge Plot on Channel 78 / 2480 MHz

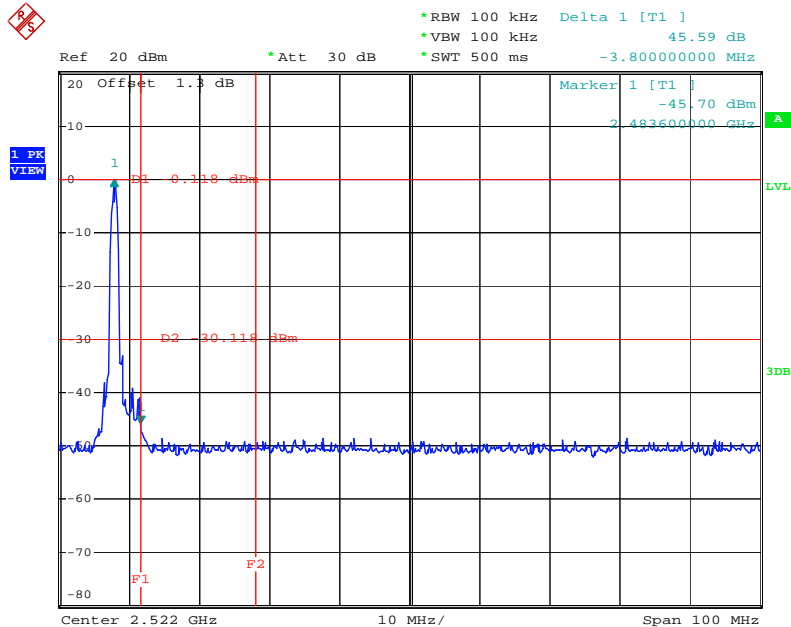

Date: 21.SEP.2009 15:18:13

3.8 Antenna Requirements

3.8.1 Limit

Except for special regulations, the Low-power Radio-frequency Devices must not be equipped with any jacket for installing an antenna with extension cable. An intentional radiator shall be designed to ensure that no antenna other than that furnished by the responsible party shall be used with the device. The use of a permanently attached antenna or of an antenna that uses a unique coupling to the intentional radiator shall be considered sufficient to comply with the provisions of this Section. The manufacturer may design the unit so that the user can replace a broken antenna, but the use of a standard antenna jack or electrical connector is prohibited.

3.8.2 Antenna Connector Construction

Please refer to section 2.2 in this test report; antenna connector complied with the requirements.

4 LIST OF MEASURING EQUIPMENTS

Instrument	Manufacturer	Model No.	Serial No.	Characteristics	Calibration Date	Remark
EMC Receiver	R&S	ESCS 30	100174	9kHz – 2.75GHz	Apr. 15, 2009	Conduction (CO04-HY)
LISN	MessTec	NNB-2/16Z	99079	9kHz – 30MHz	Mar. 23, 2009	Conduction (CO04-HY)
LISN (Support Unit)	EMCO	3810/2NM	9703-1839	9kHz – 30MHz	Mar. 22, 2009	Conduction (CO04-HY)
RF Cable-CON	UTIFLEX	3102-26886-4	CB049	9kHz – 30MHz	Apr. 20, 2009	Conduction (CO04-HY)

Note: Calibration Interval of instruments listed above is one year.

Instrument	Manufacturer	Model No.	Serial No.	Characteristics	Calibration Date	Remark
Spectrum Analyzer	R&S	FSU26.5	100015	20Hz ~ 26.5GHz	Oct. 28, 2008	Conducted (TH01-HY)
Power Meter	R&S	NRVS	100444	DC ~ 40GHz	Jul. 31, 2009	Conducted (TH01-HY)
Power Sensor	R&S	NRV-Z51	100666	DC ~ 30GHz	Aug. 05, 2009	Conducted (TH01-HY)
Power Sensor	R&S	NRV-Z32	100057	30MHz ~ 6GHz	Jul. 31, 2009	Conducted (TH01-HY)
DC Power Source	G.W.	GPC-6030D	C671845	DC 1V ~ 60V	Mar. 13, 2009	Conducted (TH01-HY)
Temp. and Humidity Chamber	Giant Force	GTH-225-20-S	MAB0103-001	N/A	Aug. 06, 2009	Conducted (TH01-HY)
RF CABLE-1m	Jye Bao	RG142	CB034-1m	20MHz ~ 7GHz	Dec. 01, 2008	Conducted (TH01-HY)
RF CABLE-2m	Jye Bao	RG142	CB035-2m	20MHz ~ 1GHz	Dec. 01, 2008	Conducted (TH01-HY)

Note: Calibration Interval of instruments listed above is one year.

Instrument	Manufacturer	Model No.	Serial No.	Characteristics	Calibration Date	Remark
AC Power Source	HPC	HPA-500W	HPA-9100024	AC 0 ~ 300V	Jul. 12, 2009*	Conducted (TH01-HY)

Note: Calibration Interval of instruments listed above is two year.

Instrument	Manufacturer	Model No.	Serial No.	Characteristics	Calibration Date	Remark
Bilog Antenna	SCHAFFNER	CBL61128	2723	30 MHz - 2 GHz	Nov. 30, 2008	Radiation (03CH02-HY)
RF Cable-R03m	Jye Bao	RG142	CB020	30 MHz - 1 GHz	Dec. 17, 2008	Radiation (03CH02-HY)
RF Cable-HIGH	SUHNER	SUCOFLEX106	03CH02-HY	1GHz~40GHz	Dec. 17, 2008	Radiation (03CH02-HY)
Spectrum Analyzer	R&S	FSP40	100305/040	9 kHz - 40GHz	Feb. 04, 2009	Radiation (03CH02-HY)
3m Semi Anechoic Chamber	SIDT FRANKONIA	SAC-3M	03CH02-HY	30 MHz - 1 GHz 3m	May 11, 2009	Radiation (03CH02-HY)
Amplifier	Agilent	8447D	2944A11146	100 kHz – 1.3 GHz	Jul. 07, 2009	Radiation (03CH02-HY)
Amplifier	Agilent	8449B	3008A02373	1GHz – 26.5 GHz	Jul. 16, 2009	Radiation (03CH02-HY)
Horn Antenna	EMCO	3115	6741	1GHz ~ 18GHz	Apr. 28, 2009	Radiation (03CH02-HY)
Turn Table	HD	DS 420	420/649/00	0 - 360 degree	N/A	Radiation (03CH02-HY)
Antenna Mast	HD	MA 240	240/559/00	1 m - 4 m	N/A	Radiation (03CH02-HY)

Note: Calibration Interval of instruments listed above is one year.

Instrument	Manufacturer	Model No.	Serial No.	Characteristics	Calibration Date	Remark
Loop Antenna	R&S	HFH2-Z2	860004/001	9 kHz - 30 MHz	Jul 28, 2008*	Radiation (03CH02-HY)

Note: Calibration Interval of instruments listed above is two year.

5 TEST LOCATION

SHIJR	ADD : 6Fl., No. 106, Sec. 1, Shintai 5th Rd., Shijr City, Taipei, Taiwan 221, R.O.C. TEL : 886-2-2696-2468 FAX : 886-2-2696-2255
HWA YA	ADD : No. 52, Hwa Ya 1st Rd., Kwei-Shan Hsiang, Tao Yuan Hsien, Taiwan, R.O.C. TEL : 886-3-327-3456 FAX : 886-3-318-0055
LINKOU	ADD : No. 30-2, Dingfu Tsuen, Linkou Shiang, Taipei, Taiwan 244, R.O.C TEL : 886-2-2601-1640 FAX : 886-2-2601-1695
DUNGHU	ADD : No. 3, Lane 238, Kangle St., Neihu Chiu, Taipei, Taiwan 114, R.O.C. TEL : 886-2-2631-4739 FAX : 886-2-2631-9740
JUNGHE	ADD : 7Fl., No. 758, Jungjeng Rd., Junghe City, Taipei, Taiwan 235, R.O.C. TEL : 886-2-8227-2020 FAX : 886-2-8227-2626
NEIHU	ADD : 4Fl., No. 339, Hsin Hu 2 nd Rd., Taipei 114, Taiwan, R.O.C. TEL : 886-2-2794-8886 FAX : 886-2-2794-9777
JHUBEI	ADD : No.8, Lane 728, Bo-ai St., Jhubei City, HsinChu County 302, Taiwan, R.O.C. TEL : 886-3-656-9065 FAX : 886-3-656-9085

6 TAF CERTIFICATE OF ACCREDITATION



Certificate No. : L1190-090318

財團法人全國認證基金會
Taiwan Accreditation Foundation

Certificate of Accreditation

This is to certify that

Sporton International Inc.
EMC & Wireless Communications Laboratory
No.52, Hwa Ya 1st Rd., Hwa Ya Technology Park, Kwei-Shan Hsiang, Tao Yuan Hsien,
Taiwan, R.O.C.

is accredited in respect of laboratory

Accreditation Criteria	: ISO/IEC 17025:2005
Accreditation Number	: 1190
Originally Accredited	: December 15, 2003
Effective Period	: January 10, 2007 to January 09, 2010
Accredited Scope	: Testing Field, see described in the Appendix
Specific Accreditation Program	: Accreditation Program for Designated Testing Laboratory for Commodities Inspection Accreditation Program for Telecommunication Equipment Testing Laboratory Accreditation Program for BSMI Mutual Recognition Arrangement with Foreign Authorities



Jay-San Chen
President, Taiwan Accreditation Foundation
Date : March 18, 2009

PI, total 19 pages

The Appendix forms an integral part of this Certificate, which shall be invalid when use without the Appendix



Annex

Declaration for Bluetooth Device acc to Part 15.247



1 Output power and channel separation of a Bluetooth device in the different operating modes:

The different operating modes (data-mode, acquisition-mode) of a Bluetooth device has no influence on the output power and the channel spacing. There is only one transmitter which is driven by identical input parameters concerning these two parameters.

Only a different hopping sequence will be used. For this reason the check of these RF parameters in one op-mode is sufficient.

2 Frequency range of a Bluetooth device:

Hereby we declare that the maximum frequency of this device is: 2402 – 2480 MHz. This is according to the Bluetooth Core Specification (+ critical errata) for devices which will be operated in the USA.

This was checked during the Bluetooth Qualification tests (Test Case: TRM/CA/04-E). Other frequency ranges (e.g. for Spain, France, Japan) which are allowed according the Core Specification are not supported by this device.

3 Co-ordination of the hopping sequence in data mode to avoid simultaneous occupancy by multiple transmitters:

Bluetooth units which want to communicate with other units must be organised in a structure called piconet. This piconet consist of max. 8 Bluetooth units. One unit is the master the other seven are the slaves. The master co-ordinates frequency occupation in this piconet for all units. As the master hop sequence is derived from its BD address which is unique for each Bluetooth device, additional masters intending to establish new piconets will always use different hop sequences.

4 Example of a hopping sequence in data mode:

Example of a 79 hopping sequence in data mode:

40, 21, 44, 23, 42, 53, 46, 55, 48, 33, 52, 35, 50, 65, 54, 67,
56, 37, 60, 39, 58, 69, 62, 71, 64, 25, 68, 27, 66, 57, 70, 59,
72, 29, 76, 31, 74, 61, 78, 63, 01, 41, 05, 43, 03, 73, 07, 75,
09, 45, 13, 47, 11, 77, 15, 00, 64, 49, 66, 53, 68, 02, 70, 06,
01, 51, 03, 55, 05, 04



5 Equally average use of frequencies in data mode and behaviour for short transmissions:

The generation of the hopping sequence in connection mode depends essentially on two input values:

1. LAP/UAP of the master of the connection
2. Internal master clock

The LAP (lower address part) are the 24 LSB's of the 48 BD_ADDRESS. The BD_ADDRESS is an unambiguous number of every Bluetooth unit. The UAP (upper address part) are the 24 MSB's of the 48 BD_ADDRESS.

The internal clock of a Bluetooth unit is derived from a free running clock which is never adjusted and is never turned off. For synchronisation with other units only offset are used. It has no relation to the time of the day. Its resolution is at least half the RX/TX slot length of 312.5 μ s. The clock has a cycle of about one day (23h30). In most case it is implemented as 28 bit counter. For the deriving of the hopping sequence the entire

LAP (24 bits), 4 LSB's (4 bits) (Input 1) and the 27 MSB's of the clock (Input 2) are used. With this input values different mathematical procedures (permutations, additions, XOR- operations) are performed to generate the sequence. This will be done at the beginning of every new transmission.

Regarding short transmissions the Bluetooth system has the following behaviour:

The first connection between the two devices is established, a hopping sequence was generated. For transmitting the wanted data the complete hopping sequence was not used. The connection ended.

The second connection will be established. A new hopping sequence is generated. Due to the fact that the Bluetooth clock has a different value, because the period between the two transmission is longer (and it cannot be shorter) than the minimum resolution of the clock (312.5 μ s). The hopping sequence will always differ from the first one.

6 Receiver input bandwidth and behaviour for repeated single or multiple packets:

The input bandwidth of the receiver is 1 MHz. In every connection one Bluetooth device is the master and the other one is the slave. The master determines the hopping sequence (see chapter 5). The slave follows this sequence. Both devices shift between RX and TX time slot according to the clock of the master.

Additionally the type of connection (e.g. single or multislot packet) is set up at the beginning of the connection. The master adapts its hopping frequency and its TX/RX timing according to the packet type of the connection. Also the slave of the connection will use these settings.

Repeating of a packet has no influence on the hopping sequence. The hopping sequence generated by the master of the connection will be followed in any case. That means, a repeated packet will not be send on the same frequency, it is send on the next frequency of the hopping sequence.



7 Dwell time in data mode

The dwell time of 0.3797s within a 30 second period in data mode is independent from the packet type (packet length). The calculation for a 30 second period is as follows:

Dwell time = time slot length * hop rate / number of hopping channels * 30s

Example for a DH1 packet (with a maximum length of one time slot) Dwell time = $625 \mu\text{s} * 1600 \text{ 1/s} / 79 * 30\text{s} = 0.3797\text{s}$ (in a 30s period)

For multislot packet the hopping is reduced according to the length of the packet. Example for a DH5 packet (with a maximum length of five time slots)

Dwell time = $5 * 625 \mu\text{s} * 1600 * 1/5 * 1/\text{s} / 79 * 30\text{s} = 0.3797\text{s}$ (in a 30s period).

This is according to the Bluetooth Core Specification V 1.0B (+ critical errata) for all Bluetooth devices. Therefore all Bluetooth devices **comply** with the FCC dwell time requirement in data mode. This was checked during the Bluetooth Qualification tests. The Dwell time in hybrid mode is measured and stated in the test report.

8 Channel Separation in hybrid mode

The nominal channel spacing of the Bluetooth system is 1MHz independent of the operating mode.

The maximum "initial carrier frequency tolerance" which is allowed for Bluetooth is $f_{\text{center}} = 75 \text{ kHz}$.

This was checked during the Bluetooth Qualification tests (Test Case: TRM/CA/07-E) for three frequencies (2402, 2441, 2480 MHz).

Additionally an example for the channel separation is given in the test report

9 Derivation and examples for a hopping sequence in hybrid mode

For the generation of the inquiry and page hop sequences the same procedures as described for the data mode are used (see chapter 5), but this time with different input vectors:

- For the inquiry hop sequence, a predefined fixed address is always used. This results in the same 32 frequencies used by all devices doing an inquiry but every time with a different start frequency and phase in this sequence.
- For the page hop sequence, the device address of the paged unit is used as input vector. This results in the use of a subset of 32 frequencies which is specific for that initial state of the connection establishment between the two units. A page to different devices would result in a different subset of 32 frequencies.

So it is ensured that also in hybrid mode the frequency use is equally averaged.

Example of a hopping sequence in inquiry mode:

48, 50, 09, 13, 52, 54, 41, 45, 56, 58, 11, 15, 60, 62, 43, 47, 00, 02, 64, 68, 04, 06, 17, 21, 08, 10, 66, 70, 12, 14, 19, 23



Example of a hopping sequence in paging mode:

08, 57, 68, 70, 51, 02, 42, 40, 04, 61, 44, 46, 63, 14, 50, 48, 16, 65, 52, 54, 67, 18, 58, 56, 20, 53, 60, 62, 55, 06, 66, 64

10 Receiver input bandwidth and synchronisation in hybrid mode:

The receiver input bandwidth is the same as in the data mode (1 MHz). When two Bluetooth devices establish contact for the first time, one device sends an inquiry access code, the other device is scanning for this inquiry access code. If two devices have been connected previously and want to start a new transmission, a similar procedure takes place. The only difference is, instead of the inquiry access code, a special access code, derived from the BD_ADDRESS of the paged device will be, will be sent by the master of this connection.

Due to the fact that both units have been connected before (in the inquiry procedure) the paging unit has timing and frequency information about the page scan of the paged unit. For this reason the time to establish the connection is reduced considerable.

11 Spread rate / data rate of the direct sequence signal

The Spread rate / Data rate in inquiry and paging mode can be defined via the access code. The access code is the only criterion for the system to check if there is a valid transmission or not. If you regard the presence of a valid access code as one bit of information, and compare it with the length of the access code of 68 bits, the Spread rate / Data rate will be 68/1.

12 Spurious emission in hybrid mode

The dwell time in hybrid mode is shorter than in data mode. For this reason the spurious emissions average level in data mode is worst case. The spurious emissions peak level is the same for both modes.

13 Peak power spectral density measurement

Since the transmitter is only active for some milliseconds on one channel you would get a result with many interruptions if using a sweep time of e.g. 1s as stated in the FCC rules. Therefore a fast sweep in maxhold function is used instead and the EUT is activated several times until the measurement curve has stabilized.