



# FCC RADIO TEST REPORT

Applicant : Micro-Star Int'l Co.,Ltd.  
Address : No.69, Lide St., Zhonghe Dist. New Taipei City 235  
Taiwan  
Equipment : Wireless Mouse  
Model No. : MS-8ZBD  
Trade Name : msi  
FCC ID : I4L-MS-8ZBD

**I HEREBY CERTIFY THAT :**

The sample was received on Aug. 02, 2024 and the testing was completed on Sep. 02, 2024 at CerpPASS Technology Corp. The test result refers exclusively to the test presented test model / sample. Without written approval of CerpPASS Technology Corp., the test report shall not be reproduced except in full.

Approved by:

Mark Liao / Supervisor

Laboratory Accreditation:

CerpPASS Technology Corporation Test Laboratory





**CONTENTS**

- 1. Summary of Test Procedure and Test Results ..... 5**
  - 1.1 Applicable Standards ..... 5
- 2. Test Configuration of Equipment under Test ..... 6**
  - 2.1 Feature of Equipment under Test..... 6
  - 2.2 Carrier Frequency of Channels ..... 7
  - 2.3 Test Mode and Test Software ..... 8
  - 2.4 Description of Test System..... 9
  - 2.5 General Information of Test ..... 10
  - 2.6 Measurement Uncertainty ..... 11
- 3. Test Equipment and Ancillaries Used for Tests ..... 12**
- 4. Antenna Requirements ..... 14**
  - 4.1 Standard Applicable ..... 14
  - 4.2 Antenna Construction and Directional Gain ..... 14
- 5. Test of AC Power Line Conducted Emission ..... 15**
  - 5.1 Test Limit ..... 15
  - 5.2 Test Procedures ..... 15
  - 5.3 Typical Test Setup ..... 16
  - 5.4 Test Result and Data ..... 17
  - 5.5 Test Photographs ..... 19
- 6. Test of Spurious Emission (Radiated) ..... 20**
  - 6.1 Test Limit ..... 20
  - 6.2 Test Procedures ..... 21
  - 6.3 Typical Test Setup ..... 22
  - 6.4 Test Result and Data (9kHz ~ 30MHz)..... 24
  - 6.5 Test Result and Data (30MHz ~ 1GHz) ..... 24
  - 6.6 Test Result and Data (1GHz ~ 25GHz)..... 26
  - 6.7 Restricted Bands of Operation ..... 38
  - 6.8 Test Photographs (30MHz ~ 1GHz) ..... 39
  - 6.9 Test Photographs (1GHz ~ 25GHz) ..... 40
- 7. Test of Spurious Emission (Conducted)..... 42**
  - 7.1 Test Limit ..... 42
  - 7.2 Test Procedure ..... 42
  - 7.3 Test Setup Layout ..... 42
  - 7.4 Test Result and Data ..... 42
- 8. On Time, Duty Cycle and Measurement methods ..... 47**
  - 8.1 Test Limit ..... 47
  - 8.2 Test Procedure ..... 47
  - 8.3 Test Setup Layout ..... 47
  - 8.4 Test Result and Data ..... 47
- 9. 6dB Bandwidth Measurement Data ..... 48**
  - 9.1 Test Limit ..... 48



9.2 Test Procedures ..... 48

9.3 Test Setup Layout ..... 48

9.4 Test Result and Data ..... 48

**10. Maximum Average Output Power ..... 50**

10.1 Test Limit ..... 50

10.2 Test Procedures ..... 50

10.3 Test Setup Layout ..... 50

10.4 Test Result and Data ..... 50

**11. Power Spectral Density ..... 51**

11.1 Test Limit ..... 51

11.2 Test Procedures ..... 51

11.3 Test Setup Layout ..... 51

11.4 Test Result and Data ..... 51

**12. Radio Frequency Exposure ..... 53**

12.1 Applicable Standards ..... 53

12.2 EUT Specification ..... 54

12.3 Result ..... 54



### History of this test report

Report No.	Issued Date	Description
24070625-TRFCC01	Sep. 13, 2024	Original



# 1. Summary of Test Procedure and Test Results

## 1.1 Applicable Standards

**ANSI C63.10:2013**

**FCC Rules and Regulations Part 15 Subpart C §15.247**

FCC Rule	Description of Test	Result
15.203	Antenna Requirement	PASS
15.207	AC Power Line Conducted Emission	PASS
15.209 15.205	Radiated Spurious Emission	PASS
15.247(d)	Conducted Spurious Emission	PASS
15.247(a)(2)	6dB Bandwidth	PASS
15.247(b)	Maximum Output Power	PASS
15.247(e)	Power Spectral Density	PASS
2.1093	Radio Frequency Exposure	N/A

\*The lab has reduced the uncertainty risk factor from test equipment, environment and staff technicians which according to the standard on contract. Therefore, the test result will only be determined by standard requirement, measurement uncertainty evaluation is not considered.



## 2. Test Configuration of Equipment under Test

### 2.1 Feature of Equipment under Test

Operation Frequency Range	2400MHz-2483.5MHz
Center Frequency Range	2402MHz-2480MHz
Modulation Type	SRD: GFSK BLE: GFSK
Modulation Technology	SRD: DTS BLE: DTS
Data Rate	SRD: GFSK: 1Mbps BLE: GFSK: 1Mbps, GFSK: 2Mbps
Antenna Type	PCB Antenna
Antenna Gain	1.43 dBi
Battery	Brand: Dongguan Heng xun Energy Technology CO., Ltd Model:HX 582728
Type-C Cable	msi \ VERSA 300 Type-C

Note: For more details, please refer to the User’s manual of the EUT.



### 2.2 Carrier Frequency of Channels

Channel	Frequency (MHz)	Channel	Frequency (MHz)	Channel	Frequency (MHz)
<b>*00</b>	<b>2402</b>	14	2430	28	2458
01	2404	15	2432	29	2460
02	2406	16	2434	30	2462
03	2408	17	2436	31	2464
04	2410	18	2438	32	2466
05	2412	<b>*19</b>	<b>2440</b>	33	2468
06	2414	20	2442	34	2470
07	2416	21	2444	35	2472
08	2418	22	2446	36	2474
09	2420	23	2448	37	2476
10	2422	24	2450	38	2478
11	2424	25	2452	<b>*39</b>	<b>2480</b>
12	2426	26	2454	--	--
13	2428	27	2456	--	--

Note: Channels remarked \* are selected to perform test.



### 2.3 Test Mode and Test Software

- a. During testing, the interface cables and equipment positions were varied according to ANSI C63.10.
- b. The complete test system included Notebook and EUT for RF test.
- c. An executive program, " FCC Assist Ver. 1.0.4" under Windows OS system was executed to transmit and receive data via Bluetooth.
- d. The following test modes were performed for the test:

Conducted Emissions from the AC mains power ports	
Test Mode	Operating Description
1	GFSK (1Mbps), From System (120V/60Hz)
2	GFSK (1Mbps), From System (240V/60Hz)
3	GFSK (2Mbps), From System (120V/60Hz)
4	GFSK (2Mbps), From System (240V/60Hz)
caused "Test Mode 4" generated the worst case, it was reported as the final data.	
Radiation Emissions (30MHz ~ 1GHz)	
Test Mode	Operating Description
1	GFSK (1Mbps), From System (120V/60Hz)
2	GFSK (1Mbps), From System (240V/60Hz)
3	GFSK (2Mbps), From System (120V/60Hz)
4	GFSK (2Mbps), From System (240V/60Hz)
caused "Test Mode 3" generated the worst case, it was reported as the final data.	
Radiation Emissions (1GHz ~ 25GHz)	
Test Mode	Operating Description
1	GFSK (1Mbps), From System (120V/60Hz)
2	GFSK (2Mbps), From System (120V/60Hz)
caused "Test Mode 1,2" generated the worst case, they were reported as the final data.	

Modulation Type	TX CONFIGURATION
GFSK (1Mbps)	1TX





### 2.4 Description of Test System

RF Conducted				
Equipment	Brand	Model	Length/Type	Power cord/Length/Type
Notebook	lenovo	S1GL2W	N/A	N/A
testfixture	YD-TECH	MCS-73-LV	N/A	N/A
Radiated Emissions				
Equipment	Brand	Model	Length/Type	Power cord/Length/Type
Notebook	ASUS	P2430U	N/A	Adapter / 1.8m / NS
USB Cable(A to B)	BENEVO	BUSB3100AMF	1m / NS	N/A
testfixture	YD-TECH	MCS-73-LV	N/A	N/A
AC Power Line Conducted Emission				
Equipment	Brand	Model	Length/Type	Power cord/Length/Type
Notebook	ASUS	P2430U	N/A	Adapter / 1.8m / NS
USB Cable(A to B)	BENEVO	BUSB3100AMF	1m / NS	N/A



2.5 General Information of Test

☒ Test Site	CerpPASS Technology Corporation Test Laboratory Address: No.10, Ln. 2, Lianfu St., Luzhu Dist., Taoyuan City 33848, Taiwan (R.O.C.) Tel: +886-3-3226-888 Fax: +886-3-3226-881	
	FCC	TW1439, TW1079
	IC	4934E-1, 4934E-2
Frequency Range Investigated	Conducted: from 150kHz to 30 MHz Radiation: from 9 kHz to 25,000MHz	
Test Distance	The test distance of radiated emission from antenna to EUT is 3 M.	

Test Item	Test Site	Test period	Environmental Conditions	Tested By
RF Conducted	RFCON01-NK	2024/09/01	31.1°C / 46%	Leon Huang
RF Conducted	RFCON01-NK	2024/09/02	30.5°C / 44%	Leon Huang
Radiated Emissions	3M02-NK	2024/08/30	26°C / 48%	Park Chen
AC Power Line Conducted Emission	CON02-NK	2024/08/30	22.6°C / 65%	Park Chen



## 2.6 Measurement Uncertainty

ISO/IEC 17025 requires that an estimate of the measurement uncertainties associated with the emissions test results be included in the report. The measurement uncertainties given below are based on a 95% confidence level (based on a coverage factor (k=2))

Measurement Item	Uncertainty
AC Power Line Conduction(150K~30MHz)	±3.12dB
Radiated Spurious Emission(9KHz~30MHz)	±3.5dB
Radiated Spurious Emission(30MHz~1GHz)	±5.1dB
Radiated Spurious Emission(1GHz~40GHz)	±5.2dB
Conducted Spurious Emission	±2.1dB
6dB Bandwidth	±5.4%
20dB Bandwidth	±4.4%
Occupied Bandwidth	±4.5%
Peak Output Power(Conducted Power Meter)	±1.1dB
Dwell Time / Deactivation Time	±7.6%
Power Spectral Density	±2.0dB
Duty Cycle	±3.5%



### 3. Test Equipment and Ancillaries Used for Tests

Test Item	Radiated Emissions				
Test Site	Semi Anechoic Room(3M02-NK)				
Instrument	Manufacturer	Model No	Serial No	Calibration Date	Valid Date
Bilog Antenna	Schwarzbeck	VULB9168	369	2024/02/19	2025/02/18
Active Loop Antenna	Schwarzbeck	FMZB 1513	414	2024/01/16	2025/01/15
Horn Antenna	EMCO	3115	31589	2024/02/26	2025/02/25
Horn Antenna	EMCO	3116	31974	2023/10/16	2024/10/15
EMI Receiver	ROHDE & SCHWARZ	ESR 7	101906	2024/05/13	2025/05/12
Spectrum Analyzer	ROHDE & SCHWARZ	FSV 40-N	101329	2024/07/16	2025/07/15
Preamplifier	Agilent	8449B	3008A01954	2024/03/01	2025/02/28
Preamplifier	EMC INSTRUMENTS	EMC184045	980065	2023/10/13	2024/10/12
Preamplifier	EM Electronics corp.	EM330	60659	2024/02/17	2025/02/16
Cable-4m(9k-3G)	EMEC	RG-223	18274M	2024/08/08	2025/08/07
Cable-3in1(30M-1G)	HARBOUR INDUSTRIES	LL142	CCE1315	2024/02/23	2025/02/22
Cable-0.5m(1G-40G)	HUBER SUHNER	SUCOFLEX 104	805443/4	2024/03/05	2025/03/04
Cable-3m(1G-40G)	HUBER SUHNER	SUCOFLEX 104	805796/4	2024/03/05	2025/03/04
Cable-8m(1G-26.5G)	WOKEN	WCBA-WCA20 3SM	CCE1374	2024/03/05	2025/03/04
Cable-1m(1G-40G)	HUBER SUHNER	HUBER SUHNER / SF102	804398/2	2023/10/12	2024/10/11
Cable-3m(1G-40G)	HUBER SUHNER	HUBER SUHNER / SF102	804619/2	2023/10/12	2024/10/11
E3	AUDIX	v8.2014-8-6	RK-000529	NA	NA
High Pass Filter	Warison	WFIL-H3000-18 000F-03	WRJ5CFWC2J1	2024/07/03	2025/07/02
Notch Filter	Warison	WFIL-N5925-71 25F-04	WRQ4BFWC4M1	2024/03/11	2025/03/10
Hipass Filter	Warison	WFIL-H7500-18 000F	WRQ4BFWC2J1	2024/03/11	2025/03/10



Test Item	RF Conducted				
Test Site	RFCON01-NK				
Instrument	Manufacturer	Model No	Serial No	Calibration Date	Valid Date
CAX Signal Analyzer	KEYSIGHT	N9000B	MY57100339	2023/11/06	2024/11/05
Power Meter	Anritsu	ML2495A	1224005	2024/02/17	2025/02/16
Power Sensor	Anritsu	MA2411B	1207295	2024/02/17	2025/02/16
Attenuator	KEYSIGHT	8491B	MY39250703	2024/02/20	2025/02/19

Test Item	AC Power Line Conducted Emission				
Test Site	CON02-NK				
Instrument	Manufacturer	Model No	Serial No	Calibration Date	Valid Date
EMI Receiver	ROHDE & SCHWARZ	ESR 7	101906	2024/05/13	2025/05/12
Two-Line V-Network	ROHDE & SCHWARZ	ENV216	102185	2024/08/27	2025/08/26
Cable-4m(9k-3G)	EMEC	RG-223	18274M	2024/08/08	2025/08/07
E3	AUDIX	v8.2014-8-6	RK-000536	NA	NA



## 4. Antenna Requirements

### 4.1 Standard Applicable

For intentional device, according to FCC 47 CFR Section 15.203, an intentional radiator shall be designed to ensure that no antenna other than that furnished by the responsible party shall be used with the device.

And according to FCC 47 CFR Section 15.247 (b), if transmitting antennas of directional gain greater than 6dBi are used, the power shall be reduced by the amount in dB that the directional gain of the antenna exceeds 6dBi.

### 4.2 Antenna Construction and Directional Gain

Antenna Type	PCB Antenna
Antenna Gain	1.43dBi



## 5. Test of AC Power Line Conducted Emission

### 5.1 Test Limit

Conducted Emissions were measured from 150 kHz to 30 MHz with a bandwidth of 9 KHz, according to the methods defined in ANSI C63.10-2013. The EUT was placed on a nonmetallic stand in a shielded room 0.8 meters above the ground plane. The interface cables and equipment positioning were varied within limits of reasonable applications to determine the position produced maximum conducted emissions.

Frequency (MHz)	Quasi Peak (dB $\mu$ V)	Average (dB $\mu$ V)
0.15 – 0.5	66-56*	56-46*
0.5 – 5.0	56	46
5.0 – 30.0	60	50

\*Decreases with the logarithm of the frequency.

### 5.2 Test Procedures

- a. The EUT was placed 0.4 meter from the conducting wall of the shielding room was kept at least 80 centimeters from any other grounded conducting surface.
- b. Connect EUT to the power mains through a line impedance stabilization network (LISN).
- c. All the support units are connecting to the other LISN.
- d. The LISN provides 50 ohm coupling impedance for the measuring instrument.
- e. The FCC states that a 50 ohm, 50 micro-Henry LISN should be used.
- f. Both sides of AC line were checked for maximum conducted interference.
- g. The frequency range from 150 kHz to 30 MHz was searched.
- h. Set the test-receiver system to Peak Detect Function and Specified Bandwidth with Maximum Hold Mode.



### 5.3 Typical Test Setup

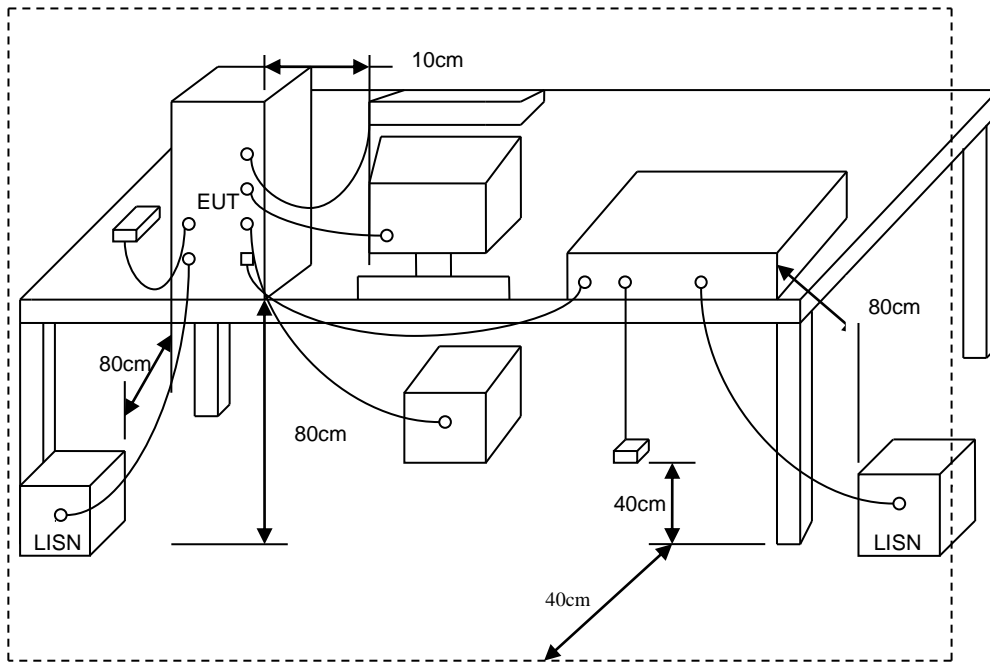





5.4 Test Result and Data

Power	: AC 240V / 60Hz	Pol/Phase	: LINE
Test Mode	: Mode 4		:

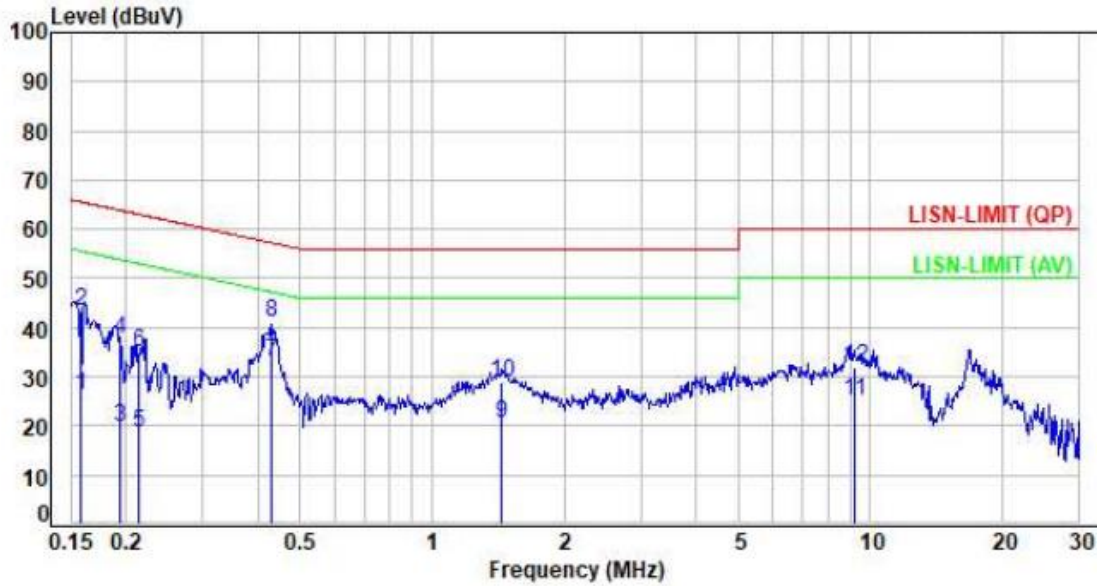

No.	Frequency (MHz)	Factor (dB)	Reading (dBuV)	Level (dBuV)	Limit (dBuV)	Margin (dB)	Detector	P/F
1	0.1584	9.63	16.54	26.17	55.55	-29.38	Average	P
2	0.1584	9.63	33.61	43.24	65.55	-22.31	QP	P
3	0.1946	9.63	10.01	19.64	53.84	-34.20	Average	P
4	0.1946	9.63	27.97	37.60	63.84	-26.24	QP	P
5	0.2148	9.63	8.96	18.59	53.02	-34.43	Average	P
6	0.2148	9.63	25.18	34.81	63.02	-28.21	QP	P
7	0.4304	9.65	23.30	32.95	47.25	-14.30	Average	P
8	0.4304	9.65	31.24	40.89	57.25	-16.36	QP	P
9	1.4399	9.67	10.74	20.41	46.00	-25.59	Average	P
10	1.4399	9.67	19.25	28.92	56.00	-27.08	QP	P
11	9.2076	9.82	15.46	25.28	50.00	-24.72	Average	P
12	9.2076	9.82	21.99	31.81	60.00	-28.19	QP	P

Note: Level=Reading+Factor  
 Margin=Level-Limit  
 Factor=(LISN or ISN or Current Probe)Factor + Cable Loss



Power	: AC 240V / 60Hz	Pol/Phase	: NEUTRAL
Test Mode	: Mode 4		

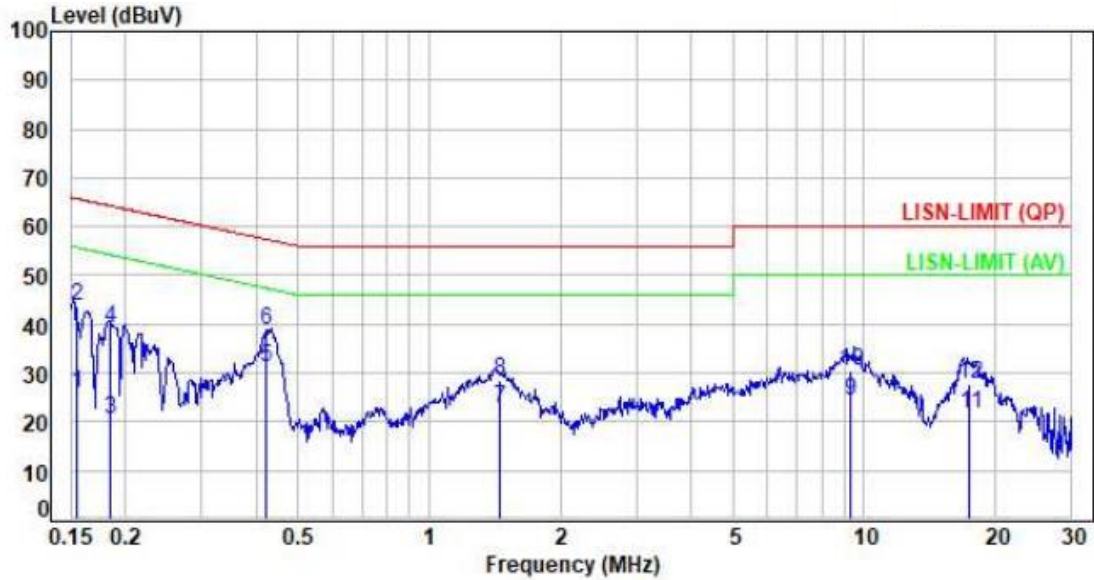

No.	Frequency (MHz)	Factor (dB)	Reading (dBuV)	Level (dBuV)	Limit (dBuV)	Margin (dB)	Detector	P/F
1	0.1548	9.58	16.10	25.68	55.74	-30.06	Average	P
2	0.1548	9.58	34.17	43.75	65.74	-21.99	QP	P
3	0.1855	9.60	11.07	20.67	54.24	-33.57	Average	P
4	0.1855	9.60	29.52	39.12	64.24	-25.12	QP	P
5	0.4236	9.59	21.76	31.35	47.38	-16.03	Average	P
6	0.4236	9.59	29.22	38.81	57.38	-18.57	QP	P
7	1.4524	9.63	13.18	22.81	46.00	-23.19	Average	P
8	1.4524	9.63	18.78	28.41	56.00	-27.59	QP	P
9	9.2721	9.82	14.68	24.50	50.00	-25.50	Average	P
10	9.2721	9.82	20.69	30.51	60.00	-29.49	QP	P
11	17.5271	9.94	11.73	21.67	50.00	-28.33	Average	P
12	17.5271	9.94	17.88	27.82	60.00	-32.18	QP	P

Note: Level=Reading+Factor  
 Margin=Level-Limit  
 Factor=(LISN or ISN or Current Probe)Factor + Cable Loss



## 6. Test of Spurious Emission (Radiated)

### 6.1 Test Limit

In any 100kHz bandwidth outside the frequency band in which the spread spectrum or digitally modulated intentional radiator is operating, the radio frequency power that is produced by the intentional radiator shall be at least 20dB below that in the 100kHz bandwidth within the band that contains the highest level of the desired power, based on either an RF conducted or a radiated measurement. If the transmitter measurement is based on the maximum conducted output power, the attenuation required under this paragraph shall be 30dB instead of 20dB. In addition, radiated emissions which fall in section 15.205(a) the restricted bands must also comply with the radiated emission limit specified in section 15.209(a).

Frequency (MHz)	Field Strength (microvolt/meter)	Measurement Distance (meters)
0.009 ~ 0.490	2400/F(kHz)	300
0.490 ~ 1.705	24000/F(kHz)	30
1.705 ~ 30.0	30	30
30 ~ 88	100	3
88 ~ 216	150	3
216 ~ 960	200	3
Above 960	500	3



## 6.2 Test Procedures

- a. The EUT was placed on a rotatable table top 0.8 meter above ground.
- b. The EUT was set 3 meters from the interference receiving antenna which was mounted on the top of a variable height antenna tower.
- c. The table was rotated 360 degrees to determine the position of the highest radiation.
- d. The antenna is a broadband antenna and its height is varied between one meter and four meters above ground to find the maximum value of the field strength both horizontal polarization and vertical polarization of the antenna are set to make the measurement.
- e. For each suspected emission the EUT was arranged to its worst case and then tune the antenna tower (from 1 M to 4 M) and turn table (from 0 degree to 360 degrees) to find the maximum reading.
- f. Set the test-receiver system to Peak or CISPR quasi-peak Detect Function and specified bandwidth with Maximum Hold Mode.
- g. If the emission level of the EUT in peak mode was 3 dB lower than the limit specified, then testing will be stopped and peak values of EUT will be reported, otherwise, the emissions which do not have 3 dB margin will be repeated one by one using the quasi-peak method and reported.
- h. For testing above 1GHz, the emission level of the EUT in peak mode was 20dB lower than average limit (that means the emission level in peak mode also complies with the limit in average mode), then testing will be stopped and peak values of EUT will be reported, otherwise, the emissions will be measured in average mode again and reported.
- i. "Cone of radiation" has been considered to be 3dB bandwidth of the measurement antenna.

Note:

- 1.The supporting fixture shall permit orientation of the EUT in each of three orthogonal axis positions such that emissions from the EUT are maximized.
- 2.Due to the test software function limit the operation band setting(200dBuV/m).  
There's no corresponding limitation in the actual test item.



### 6.3 Typical Test Setup

Below 30MHz test setup

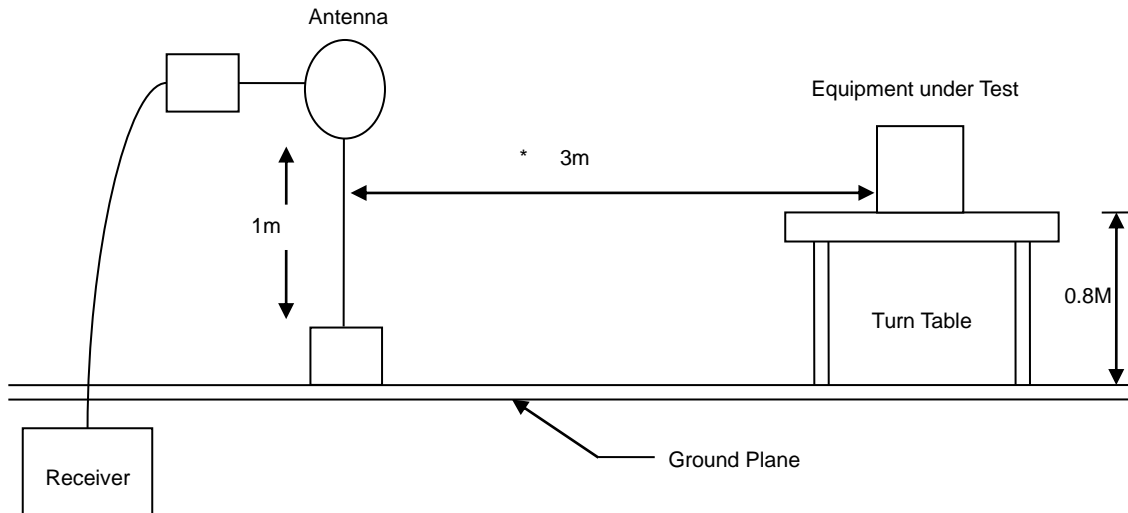

30MHz- 1GHz Test Setup

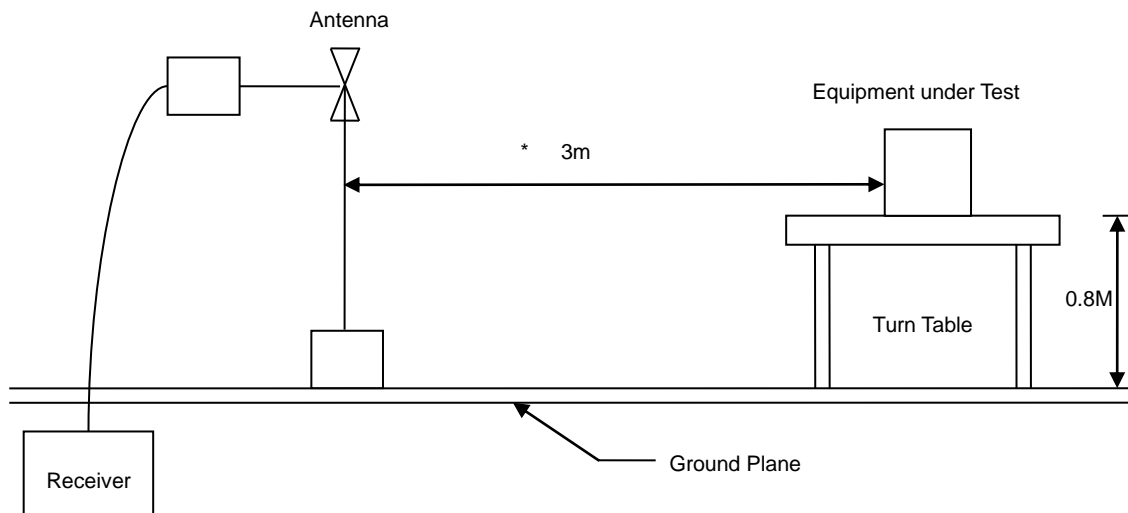



Above 1GHz Test Setup

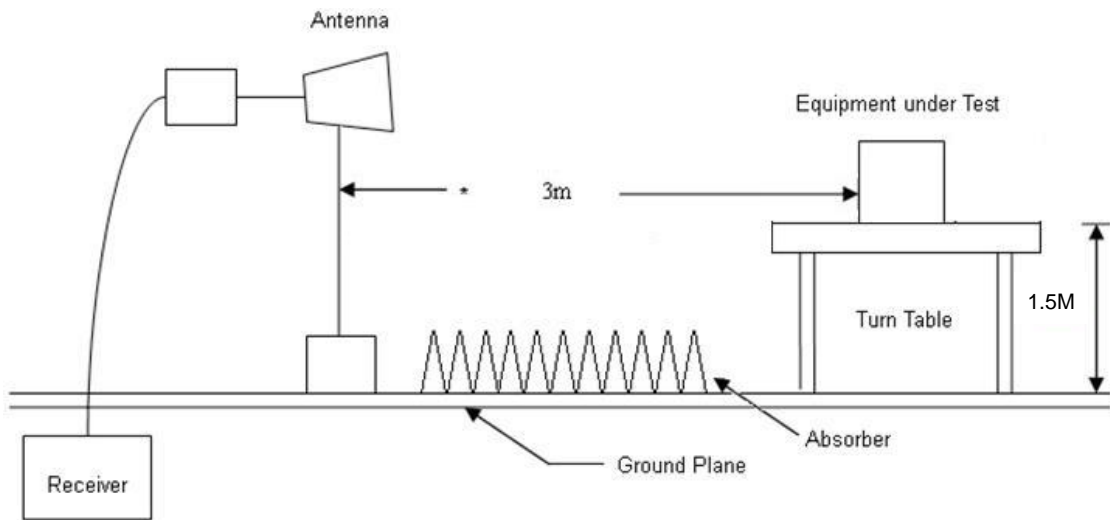



### 6.4 Test Result and Data (9kHz ~ 30MHz)

The 9kHz - 30MHz spurious emission is under limit 20dB more.

### 6.5 Test Result and Data (30MHz ~ 1GHz)

Power	: AC 120V / 60Hz	Pol/Phase	: VERTICAL
Test Mode	: Mode 3		:

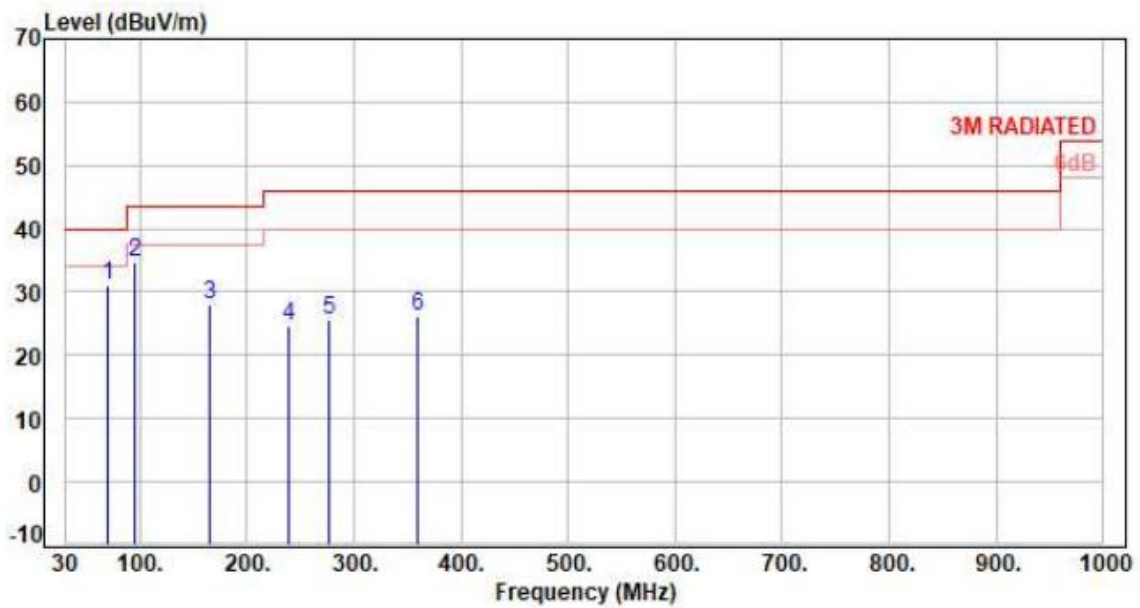

No.	Frequency (MHz)	Factor (dB)	Reading (dBuV)	Level (dBuV/m)	Limit (dBuV/m)	Margin (dB)	Detector	Height (cm)	Azimuth (deg)	P/F
1	70.74	-12.04	43.13	31.09	40.00	-8.91	Peak	400	0	P
2	95.96	-15.13	50.00	34.87	43.50	-8.63	Peak	400	0	P
3	165.80	-9.46	37.38	27.92	43.50	-15.58	Peak	400	0	P
4	239.52	-10.52	35.19	24.67	46.00	-21.33	Peak	400	0	P
5	276.38	-9.34	34.86	25.52	46.00	-20.48	Peak	400	0	P
6	359.80	-6.94	33.08	26.14	46.00	-19.86	Peak	400	0	P

Note: Level=Reading+Factor  
Margin=Level-Limit  
Factor=Antenna Factor + cable loss - Amplifier Factor





Power	: AC 120V / 60Hz	Pol/Phase	: HORIZONTAL
Test Mode	: Mode 3		:

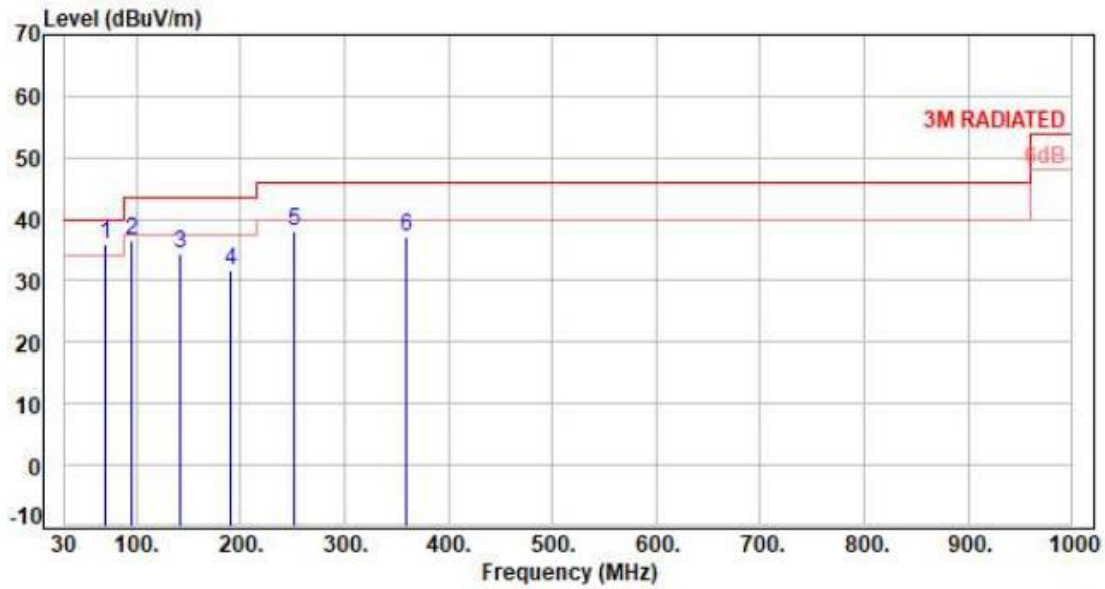

No.	Frequency (MHz)	Factor (dB)	Reading (dBuV)	Level (dBuV/m)	Limit (dBuV/m)	Margin (dB)	Detector	Height (cm)	Azimuth (deg)	P/F
1	70.74	-12.04	47.93	35.89	40.00	-4.11	Peak	400	0	P
2	95.96	-15.13	51.71	36.58	43.50	-6.92	Peak	400	0	P
3	142.52	-9.93	44.49	34.56	43.50	-8.94	Peak	400	0	P
4	191.02	-11.60	43.34	31.74	43.50	-11.76	Peak	400	0	P
5	251.16	-10.13	48.13	38.00	46.00	-8.00	Peak	400	0	P
6	359.80	-6.94	44.13	37.19	46.00	-8.81	Peak	400	0	P

Note: Level=Reading+Factor  
 Margin=Level-Limit  
 Factor=Antenna Factor + cable loss - Amplifier Factor





6.6 Test Result and Data (1GHz ~ 25GHz)

Power	: AC 120V / 60Hz	Pol/Phase	: VERTICAL
Test Mode	: Mode 1, CH00		:

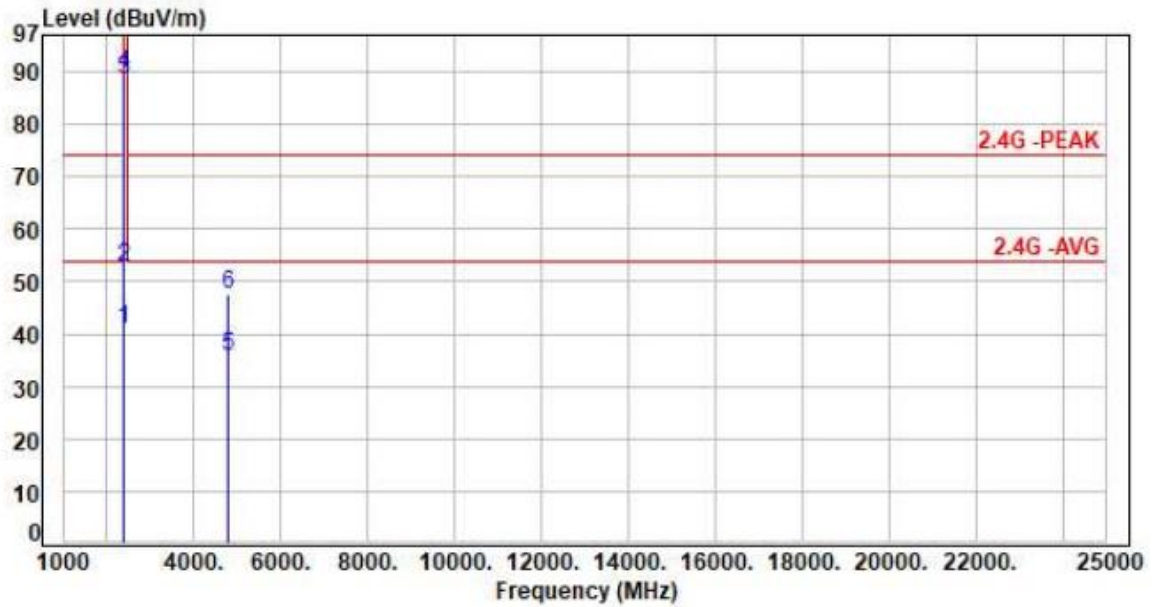

No.	Frequency (MHz)	Factor (dB)	Reading (dBuV)	Level (dBuV/m)	Limit (dBuV/m)	Margin (dB)	Detector	Height (cm)	Azimuth (deg)	P/F
1	2390.00	-2.33	43.20	40.87	54.00	-13.13	Average	177	395	P
2	2390.00	-2.33	55.13	52.80	74.00	-21.20	Peak	177	395	P
3	2402.00	-2.32	90.90	88.58	200.00	-111.42	Average	177	395	P
4	2402.00	-2.32	91.98	89.66	200.00	-110.34	Peak	177	395	P
5	4804.00	5.89	30.03	35.92	54.00	-18.08	Average	100	77	P
6	4804.00	5.89	41.64	47.53	74.00	-26.47	Peak	100	77	P

Note: Level=Reading+Factor  
 Margin=Level-Limit  
 Factor=Antenna Factor + cable loss - Amplifier Factor



Power	: AC 120V / 60Hz	Pol/Phase	: HORIZONTAL
Test Mode	: Mode 1, CH00		:

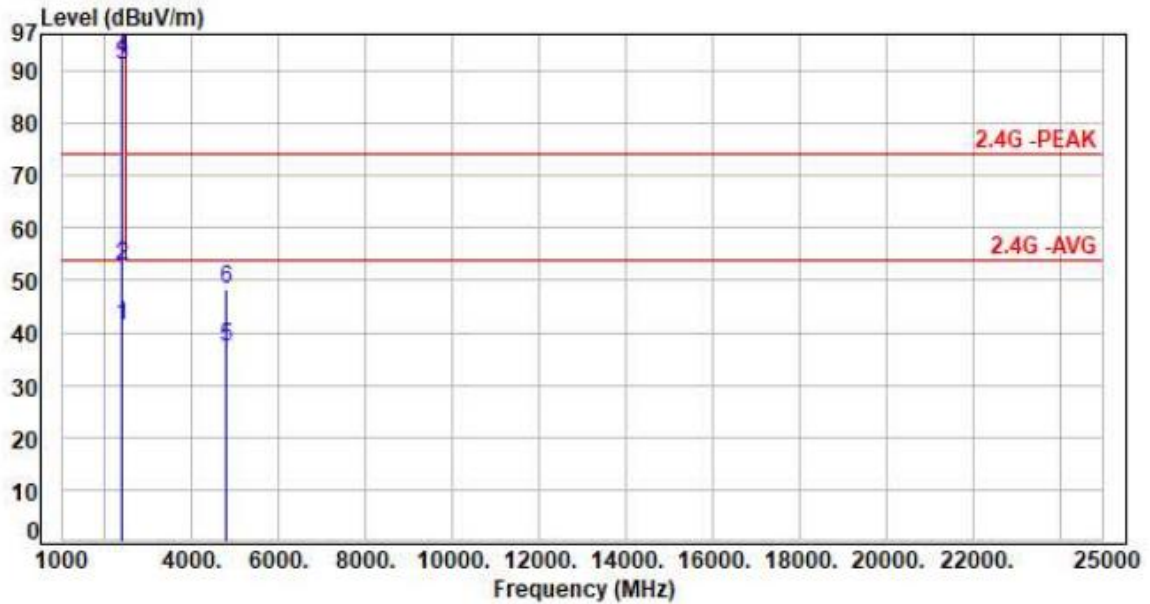

No.	Frequency (MHz)	Factor (dB)	Reading (dBuV)	Level (dBuV/m)	Limit (dBuV/m)	Margin (dB)	Detector	Height (cm)	Azimuth (deg)	P/F
1	2390.00	-2.33	43.74	41.41	54.00	-12.59	Average	138	154	P
2	2390.00	-2.33	55.23	52.90	74.00	-21.10	Peak	138	154	P
3	2402.00	-2.32	93.42	91.10	200.00	-108.90	Average	138	154	P
4	2402.00	-2.32	94.52	92.20	200.00	-107.80	Peak	138	154	P
5	4804.00	5.89	31.40	37.29	54.00	-16.71	Average	100	214	P
6	4804.00	5.89	42.57	48.46	74.00	-25.54	Peak	100	214	P

Note: Level=Reading+Factor  
 Margin=Level-Limit  
 Factor=Antenna Factor + cable loss - Amplifier Factor



Power	: AC 120V / 60Hz	Pol/Phase	: VERTICAL
Test Mode	: Mode 1, CH19		:

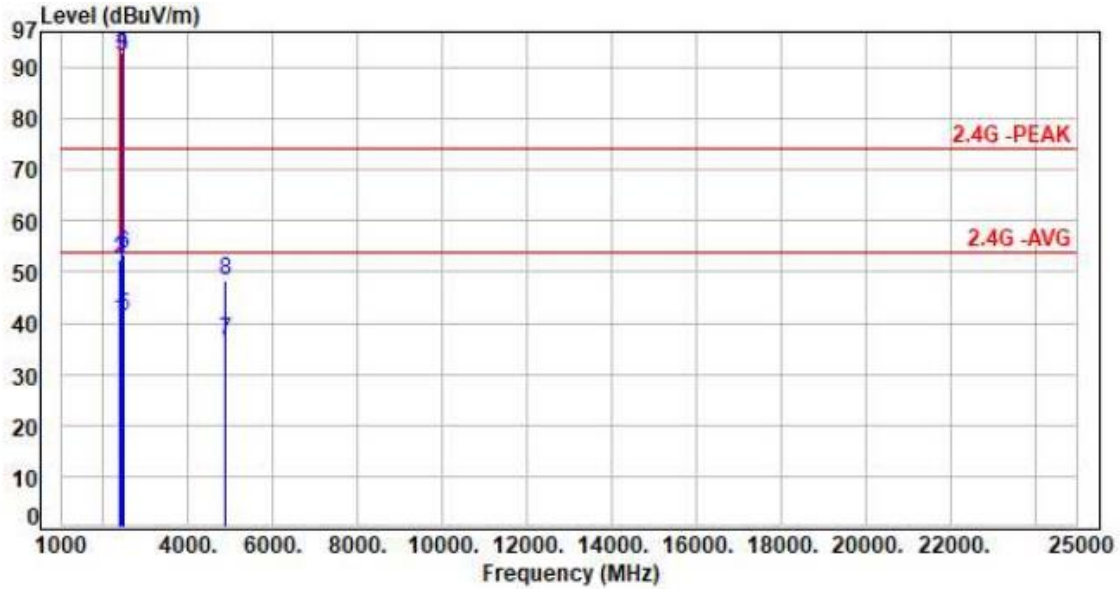

No.	Frequency (MHz)	Factor (dB)	Reading (dBuV)	Level (dBuV/m)	Limit (dBuV/m)	Margin (dB)	Detector	Height (cm)	Azimuth (deg)	P/F
1	2390.00	-2.33	43.06	40.73	54.00	-13.27	Average	384	178	P
2	2390.00	-2.33	54.85	52.52	74.00	-21.48	Peak	384	178	P
3	2440.00	-2.16	94.24	92.08	200.00	-107.92	Average	384	178	P
4	2440.00	-2.16	95.13	92.97	200.00	-107.03	Peak	384	178	P
5	2483.50	-2.01	43.44	41.43	54.00	-12.57	Average	384	178	P
6	2483.50	-2.01	55.32	53.31	74.00	-20.69	Peak	384	178	P
7	4880.00	6.12	30.29	36.41	54.00	-17.59	Average	100	75	P
8	4880.00	6.12	42.22	48.34	74.00	-25.66	Peak	100	75	P

Note: Level=Reading+Factor  
 Margin=Level-Limit  
 Factor=Antenna Factor + cable loss - Amplifier Factor



Power	: AC 120V / 60Hz	Pol/Phase	: HORIZONTAL
Test Mode	: Mode 1, CH19		:

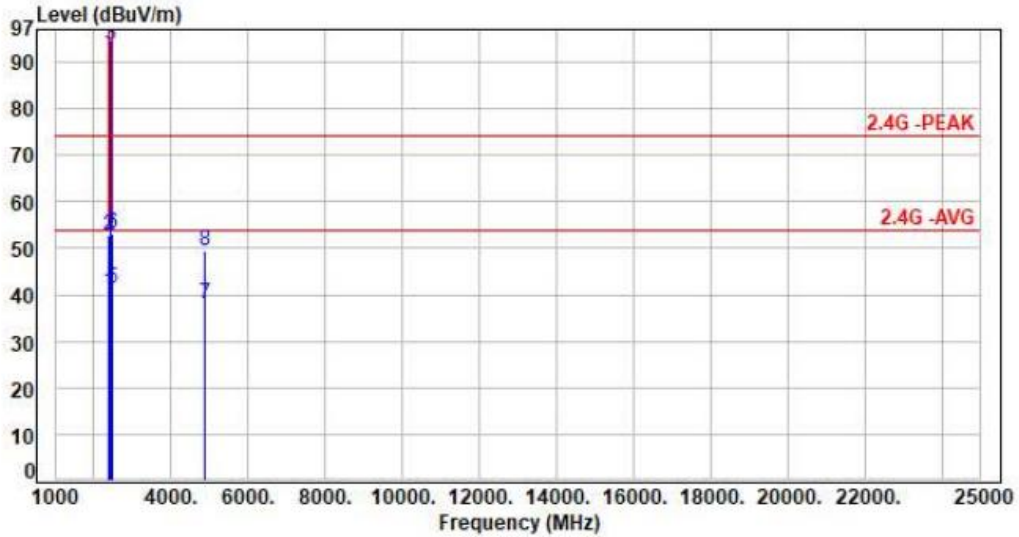

No.	Frequency (MHz)	Factor (dB)	Reading (dBuV)	Level (dBuV/m)	Limit (dBuV/m)	Margin (dB)	Detector	Height (cm)	Azimuth (deg)	P/F
1	2390.00	-2.33	42.97	40.64	54.00	-13.36	Average	152	157	P
2	2390.00	-2.33	54.90	52.57	74.00	-21.43	Peak	152	157	P
3	2440.00	-2.16	95.76	93.60	200.00	-106.40	Average	152	157	P
4	2440.00	-2.16	96.83	94.67	200.00	-105.33	Peak	152	157	P
5	2483.50	-2.01	43.32	41.31	54.00	-12.69	Average	152	157	P
6	2483.50	-2.01	55.21	53.20	74.00	-20.80	Peak	152	157	P
7	4880.00	6.12	31.93	38.05	54.00	-15.95	Average	100	212	P
8	4880.00	6.12	43.18	49.30	74.00	-24.70	Peak	100	212	P

Note: Level=Reading+Factor  
 Margin=Level-Limit  
 Factor=Antenna Factor + cable loss - Amplifier Factor



Power	: AC 120V / 60Hz	Pol/Phase	: VERTICAL
Test Mode	: Mode 1, CH39		:

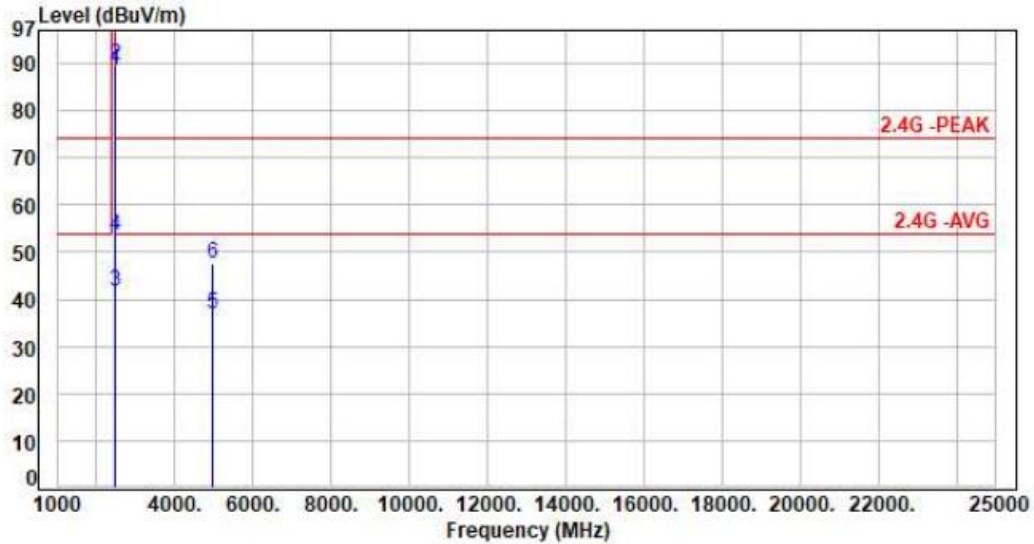

No.	Frequency (MHz)	Factor (dB)	Reading (dBuV)	Level (dBuV/m)	Limit (dBuV/m)	Margin (dB)	Detector	Height (cm)	Azimuth (deg)	P/F
1	2480.00	-2.01	90.40	88.39	200.00	-111.61	Average	365	177	P
2	2480.00	-2.01	91.70	89.69	200.00	-110.31	Peak	365	177	P
3	2483.50	-2.01	43.64	41.63	54.00	-12.37	Average	365	177	P
4	2483.50	-2.01	55.31	53.30	74.00	-20.70	Peak	365	177	P
5	4960.00	6.37	30.47	36.84	54.00	-17.16	Average	100	76	P
6	4960.00	6.37	41.34	47.71	74.00	-26.29	Peak	100	76	P

Note: Level=Reading+Factor  
 Margin=Level-Limit  
 Factor=Antenna Factor + cable loss - Amplifier Factor





Power	: AC 120V / 60Hz	Pol/Phase	: HORIZONTAL
Test Mode	: Mode 1, CH39		:

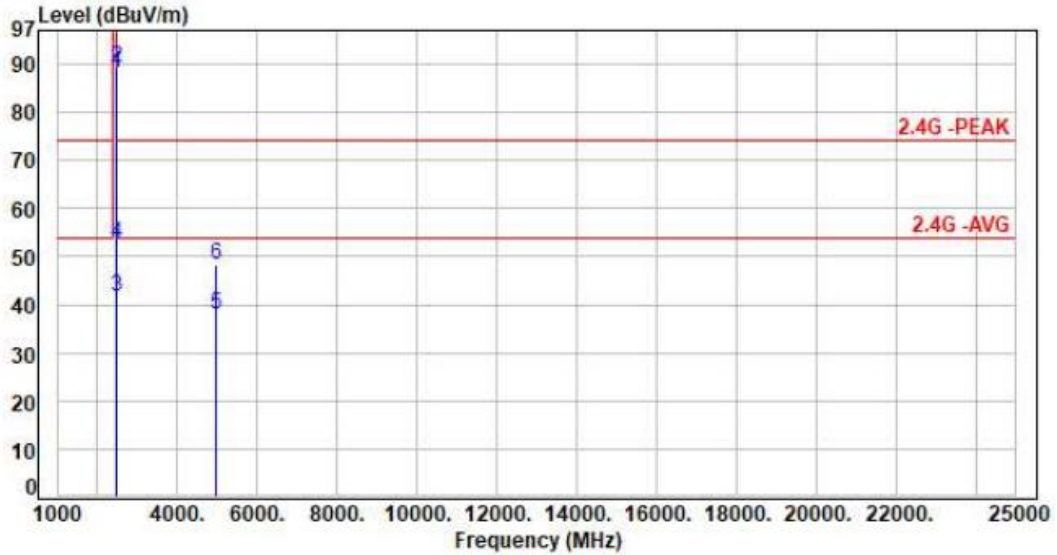

No.	Frequency (MHz)	Factor (dB)	Reading (dBuV)	Level (dBuV/m)	Limit (dBuV/m)	Margin (dB)	Detector	Height (cm)	Azimuth (deg)	P/F
1	2480.00	-2.01	90.13	88.12	200.00	-111.88	Average	162	155	P
2	2480.00	-2.01	91.33	89.32	200.00	-110.68	Peak	162	155	P
3	2483.50	-2.01	43.83	41.82	54.00	-12.18	Average	162	155	P
4	2483.50	-2.01	54.79	52.78	74.00	-21.22	Peak	162	155	P
5	4960.00	6.37	31.63	38.00	54.00	-16.00	Average	100	212	P
6	4960.00	6.37	42.11	48.48	74.00	-25.52	Peak	100	212	P

Note: Level=Reading+Factor  
Margin=Level-Limit  
Factor=Antenna Factor + cable loss - Amplifier Factor



Power	: AC 120V / 60Hz	Pol/Phase	: VERTICAL
Test Mode	: Mode 2, CH00		:

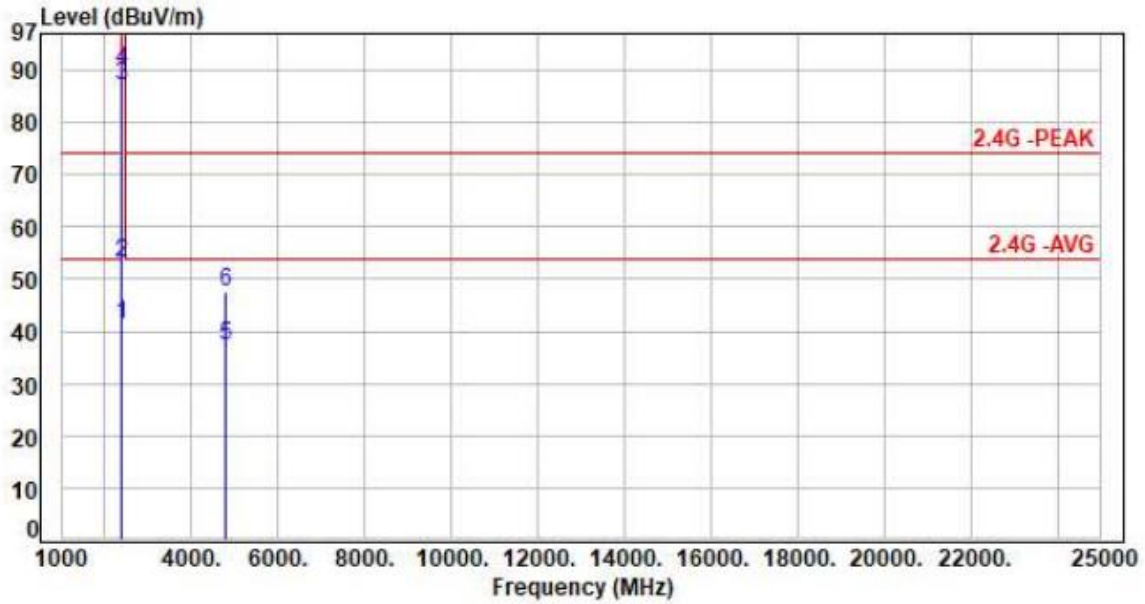

No.	Frequency (MHz)	Factor (dB)	Reading (dBuV)	Level (dBuV/m)	Limit (dBuV/m)	Margin (dB)	Detector	Height (cm)	Azimuth (deg)	P/F
1	2390.00	-2.33	43.74	41.41	54.00	-12.59	Average	387	177	P
2	2390.00	-2.33	55.57	53.24	74.00	-20.76	Peak	387	177	P
3	2402.00	-2.32	89.32	87.00	200.00	-113.00	Average	387	177	P
4	2402.00	-2.32	92.13	89.81	200.00	-110.19	Peak	387	177	P
5	4804.00	5.89	31.44	37.33	54.00	-16.67	Average	100	77	P
6	4804.00	5.89	41.85	47.74	74.00	-26.26	Peak	100	77	P

Note: Level=Reading+Factor  
 Margin=Level-Limit  
 Factor=Antenna Factor + cable loss - Amplifier Factor



Power	: AC 120V / 60Hz	Pol/Phase	: HORIZONTAL
Test Mode	: Mode 2, CH00		:

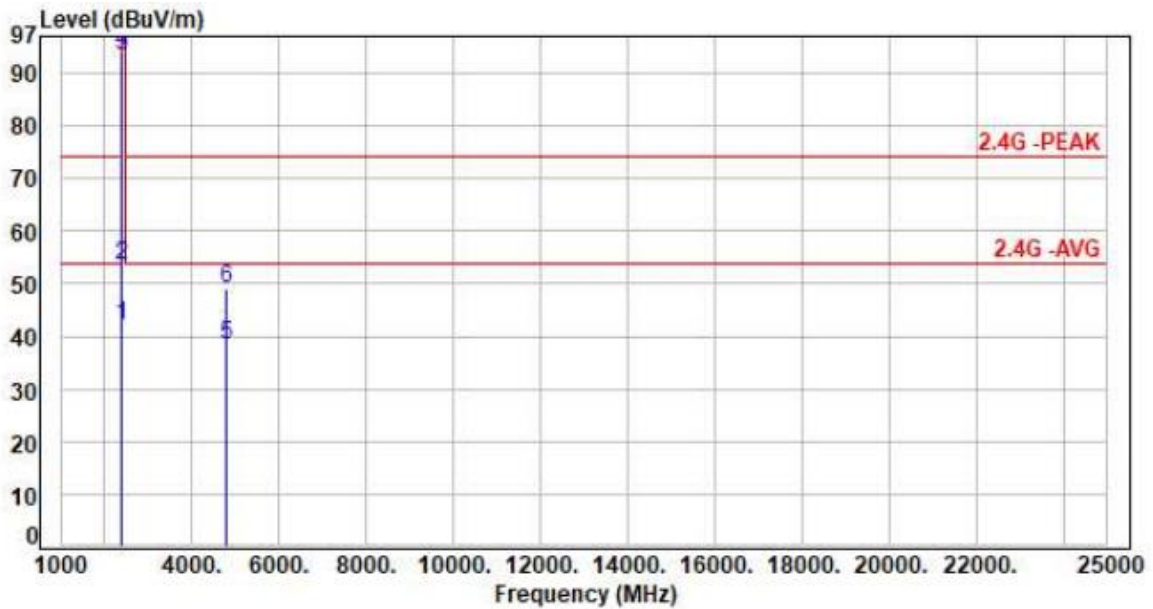

No.	Frequency (MHz)	Factor (dB)	Reading (dBuV)	Level (dBuV/m)	Limit (dBuV/m)	Margin (dB)	Detector	Height (cm)	Azimuth (deg)	P/F
1	2390.00	-2.33	44.45	42.12	54.00	-11.88	Average	162	154	P
2	2390.00	-2.33	55.63	53.30	74.00	-20.70	Peak	162	154	P
3	2402.00	-2.32	95.61	93.29	200.00	-106.71	Average	162	154	P
4	2402.00	-2.32	96.54	94.22	200.00	-105.78	Peak	162	154	P
5	4804.00	5.89	32.37	38.26	54.00	-15.74	Average	100	213	P
6	4804.00	5.89	42.99	48.88	74.00	-25.12	Peak	100	213	P

Note: Level=Reading+Factor  
 Margin=Level-Limit  
 Factor=Antenna Factor + cable loss - Amplifier Factor





Power	: AC 120V / 60Hz	Pol/Phase	: VERTICAL
Test Mode	: Mode 2, CH19		:

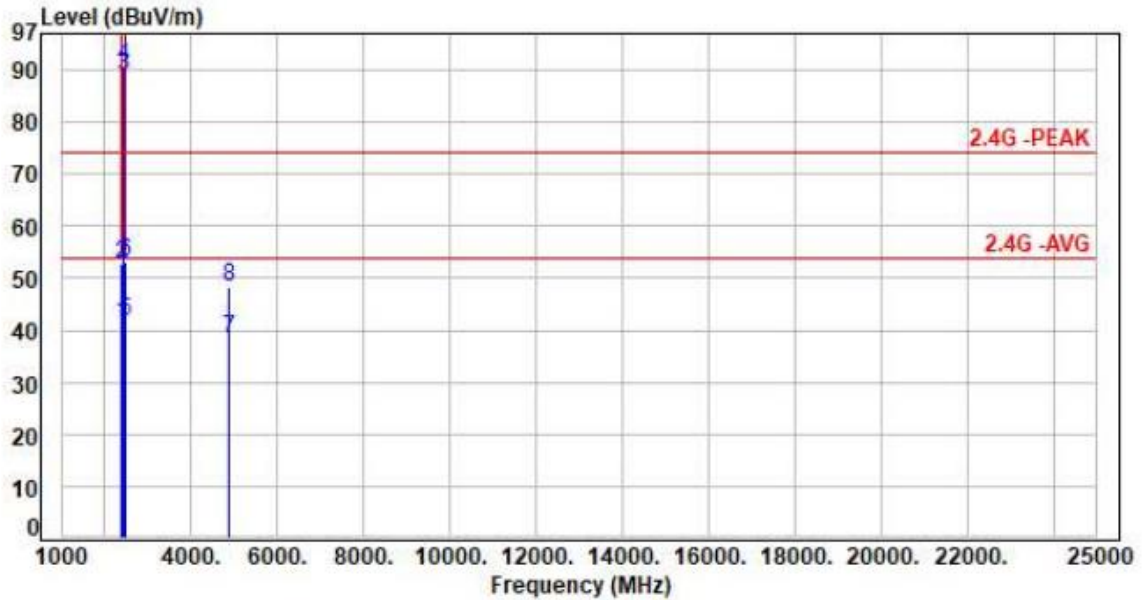

No.	Frequency (MHz)	Factor (dB)	Reading (dBuV)	Level (dBuV/m)	Limit (dBuV/m)	Margin (dB)	Detector	Height (cm)	Azimuth (deg)	P/F
1	2390.00	-2.33	43.60	41.27	54.00	-12.73	Average	382	176	P
2	2390.00	-2.33	55.18	52.85	74.00	-21.15	Peak	382	176	P
3	2440.00	-2.16	91.08	88.92	200.00	-111.08	Average	382	176	P
4	2440.00	-2.16	92.90	90.74	200.00	-109.26	Peak	382	176	P
5	2483.50	-2.01	43.77	41.76	54.00	-12.24	Average	382	176	P
6	2483.50	-2.01	55.22	53.21	74.00	-20.79	Peak	382	176	P
7	4880.00	6.12	32.40	38.52	54.00	-15.48	Average	100	78	P
8	4880.00	6.12	42.19	48.31	74.00	-25.69	Peak	100	78	P

Note: Level=Reading+Factor  
Margin=Level-Limit  
Factor=Antenna Factor + cable loss - Amplifier Factor



Power	: AC 120V / 60Hz	Pol/Phase	: HORIZONTAL
Test Mode	: Mode 2, CH19		:

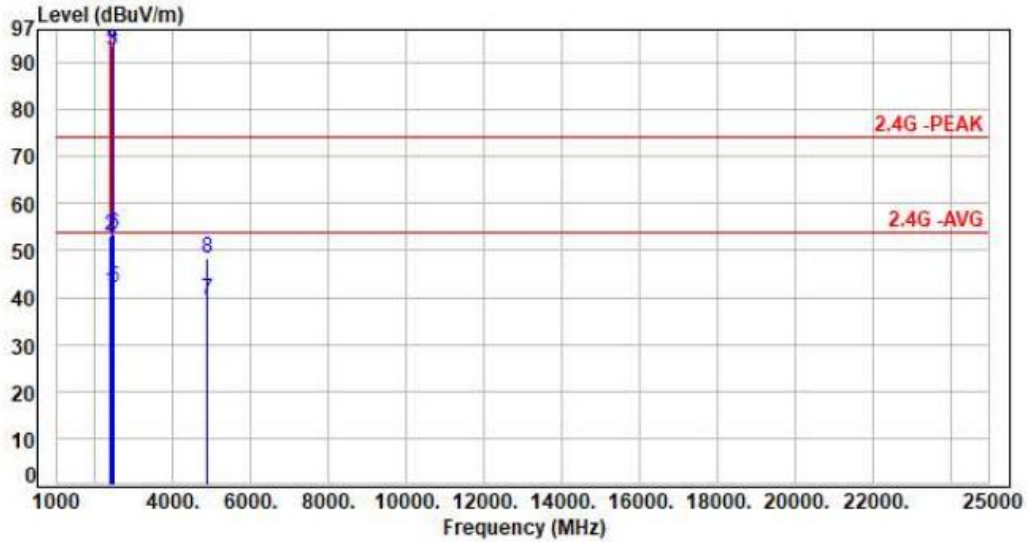

No.	Frequency (MHz)	Factor (dB)	Reading (dBuV)	Level (dBuV/m)	Limit (dBuV/m)	Margin (dB)	Detector	Height (cm)	Azimuth (deg)	P/F
1	2390.00	-2.33	43.62	41.29	54.00	-12.71	Average	135	156	P
2	2390.00	-2.33	55.26	52.93	74.00	-21.07	Peak	135	156	P
3	2440.00	-2.16	94.71	92.55	200.00	-107.45	Average	135	156	P
4	2440.00	-2.16	95.76	93.60	200.00	-106.40	Peak	135	156	P
5	2483.50	-2.01	43.99	41.98	54.00	-12.02	Average	135	156	P
6	2483.50	-2.01	55.33	53.32	74.00	-20.68	Peak	135	156	P
7	4880.00	6.12	33.42	39.54	54.00	-14.46	Average	100	215	P
8	4880.00	6.12	42.27	48.39	74.00	-25.61	Peak	100	215	P

Note: Level=Reading+Factor  
 Margin=Level-Limit  
 Factor=Antenna Factor + cable loss - Amplifier Factor



Power	: AC 120V / 60Hz	Pol/Phase	: VERTICAL
Test Mode	: Mode 2, CH39		:

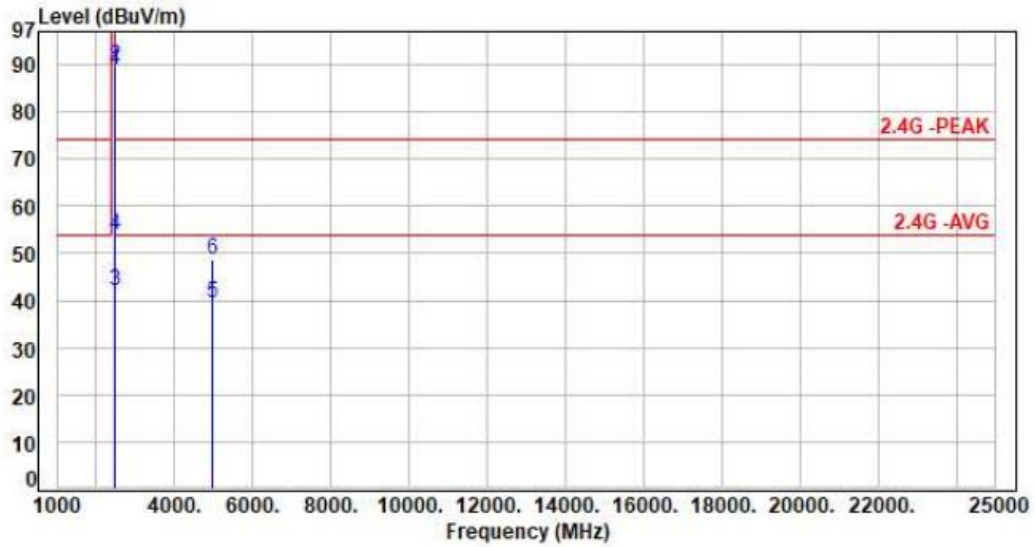

No.	Frequency (MHz)	Factor (dB)	Reading (dBuV)	Level (dBuV/m)	Limit (dBuV/m)	Margin (dB)	Detector	Height (cm)	Azimuth (deg)	P/F
1	2480.00	-2.01	90.83	88.82	200.00	-111.18	Average	366	176	P
2	2480.00	-2.01	91.69	89.68	200.00	-110.32	Peak	366	176	P
3	2483.50	-2.01	44.18	42.17	54.00	-11.83	Average	366	176	P
4	2483.50	-2.01	55.71	53.70	74.00	-20.30	Peak	366	176	P
5	4960.00	6.37	33.07	39.44	54.00	-14.56	Average	100	75	P
6	4960.00	6.37	42.28	48.65	74.00	-25.35	Peak	100	75	P

Note: Level=Reading+Factor  
 Margin=Level-Limit  
 Factor=Antenna Factor + cable loss - Amplifier Factor



Power	: AC 120V / 60Hz	Pol/Phase	: HORIZONTAL
Test Mode	: Mode 2, CH39		:

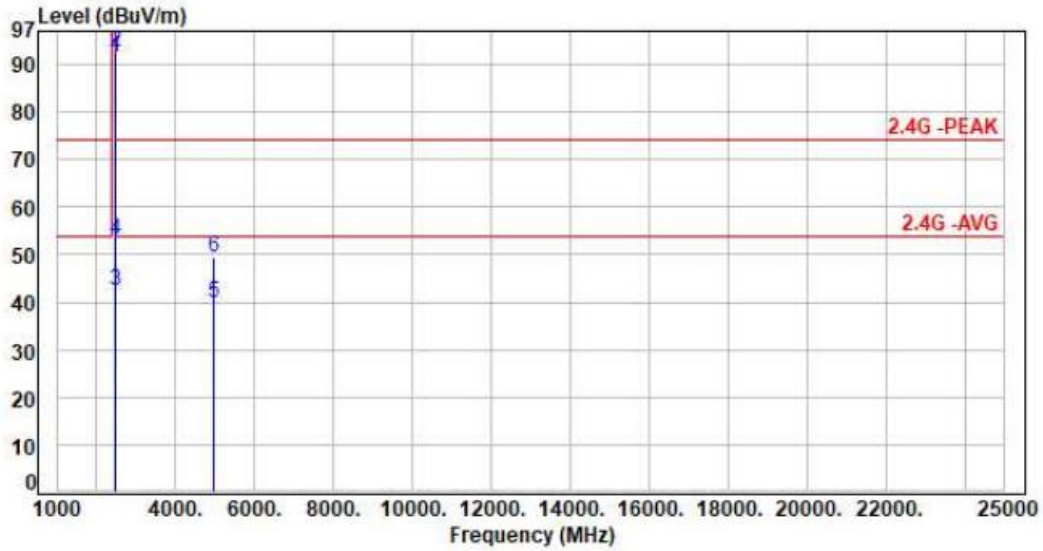

No.	Frequency (MHz)	Factor (dB)	Reading (dBuV)	Level (dBuV/m)	Limit (dBuV/m)	Margin (dB)	Detector	Height (cm)	Azimuth (deg)	P/F
1	2480.00	-2.01	93.58	91.57	200.00	-108.43	Average	145	156	P
2	2480.00	-2.01	94.72	92.71	200.00	-107.29	Peak	145	156	P
3	2483.50	-2.01	44.30	42.29	54.00	-11.71	Average	145	156	P
4	2483.50	-2.01	55.17	53.16	74.00	-20.84	Peak	145	156	P
5	4960.00	6.37	33.58	39.95	54.00	-14.05	Average	100	212	P
6	4960.00	6.37	42.98	49.35	74.00	-24.65	Peak	100	212	P

Note: Level=Reading+Factor  
Margin=Level-Limit  
Factor=Antenna Factor + cable loss - Amplifier Factor



### 6.7 Restricted Bands of Operation

Only spurious emissions are permitted in any of the frequency bands listed below:

MHz	MHz	MHz	GHz
0.09000 – 0.11000	16.42000 – 16.42300	399.9 – 410.0	4.500 – 5.250
0.49500 – 0.505**	16.69475 – 16.69525	608.0 – 614.0	5.350 – 5.460
2.17350 – 2.19050	16.80425 – 16.80475	960.0 – 1240.0	7.250 – 7.750
4.12500 – 4.12800	25.50000 – 25.67000	1300.0 – 1427.0	8.025 – 8.500
4.17725 – 4.17775	37.50000 – 38.25000	1435.0 – 1626.5	9.000 – 9.200
4.20725 – 4.20775	73.00000 – 74.60000	1645.5 – 1646.5	9.300 – 9.500
6.21500 – 6.21800	74.80000 – 75.20000	1660.0 – 1710.0	10.600 – 12.700
6.26775 – 6.26825	108.00000 – 121.94000	1718.8 – 1722.2	13.250 – 13.400
6.31175 – 6.31225	123.00000 – 138.00000	2200.0 – 2300.0	14.470 – 14.500
8.29100 – 8.29400	149.90000 – 150.05000	2310.0 – 2390.0	15.350 – 16.200
8.36200 – 8.36600	156.52475 – 156.52525	2483.5 – 2500.0	17.700 – 21.400
8.37625 – 8.38675	156.70000 – 156.90000	2655.0 – 2900.0	22.010 – 23.120
8.41425 – 8.41475	162.01250 – 167.17000	3260.0 – 3267.0	23.600 – 24.000
12.29000 – 12.29300	167.72000 – 173.20000	3332.0 – 3339.0	31.200 – 31.800
12.51975 – 12.52025	240.00000 – 285.00000	3345.8 – 3358.0	36.430 – 36.500
12.57675 – 12.57725	322.00000 – 335.40000	3600.0 – 4400.0	Above 38.6
13.36000 – 13.41000			

\*\* : Until February 1, 1999, this restricted band shall be 0.490-0.510 MHz



## 7. Test of Spurious Emission (Conducted)

### 7.1 Test Limit

According to the methods defined in ANSI C63.10-2013 Section 11.11.1

Below -30dB of the highest emission level of operating band (In 100 kHz Resolution Bandwidth)

### 7.2 Test Procedure

According to the methods defined in ANSI C63.10-2013 Section 11.11.2 & 11.11.3

- a. The transmitter output was connected to the spectrum analyzer via a low loss cable.
- b. Set RBW of spectrum analyzer to 100 KHz and VBW of spectrum analyzer to 300 KHz with convenient frequency span including 100 KHz bandwidth from band edge.
- c. Peak conducted output power measured within any 100 kHz outside the authorized frequency band shall be attenuated by at least 30dB relative to the maximum measured in-band peak PSD level.
- d. The band edges was measured and recorded.

### 7.3 Test Setup Layout

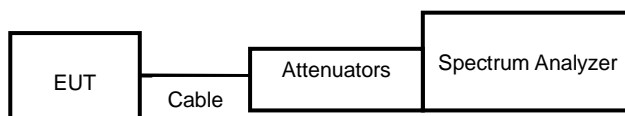

### 7.4 Test Result and Data

Note: Test plots refer to the following pages.



Modulation Type: GFSK(1Mbps)  
CH00

Modulation Type: GFSK(1Mbps)  
CH19

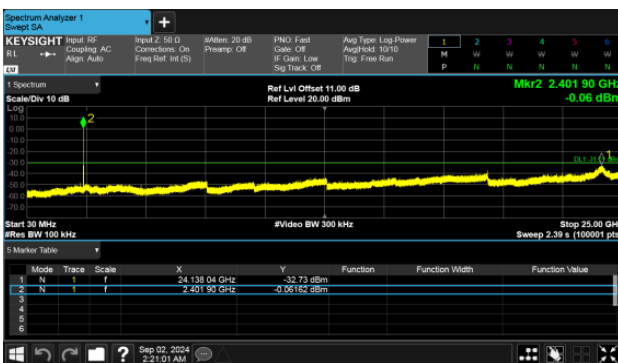
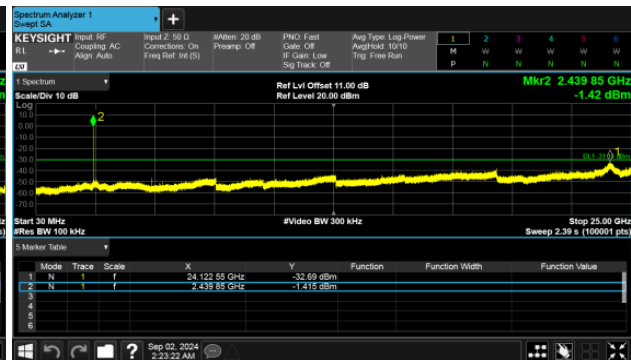
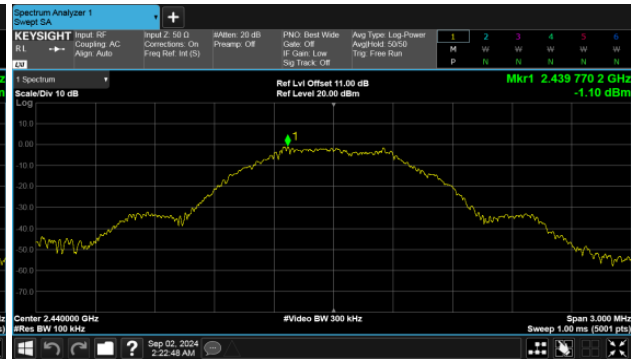
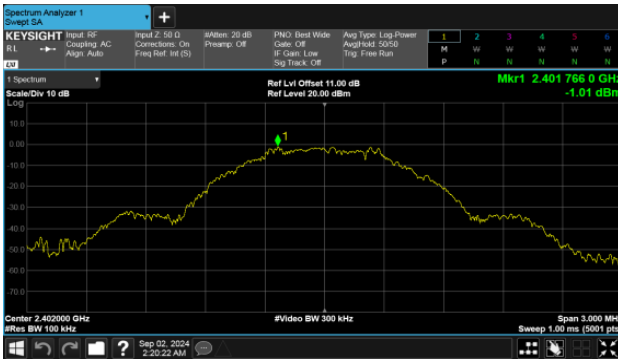





Modulation Type: GFSK(1Mbps)  
CH39

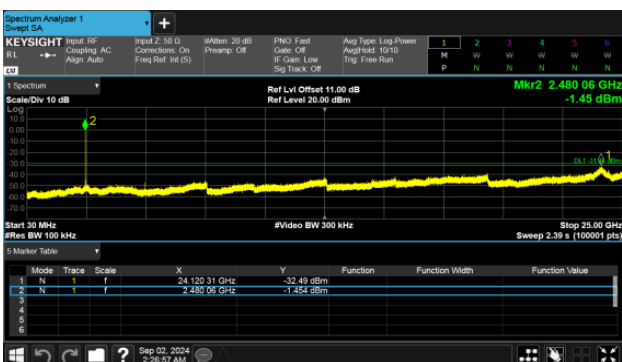
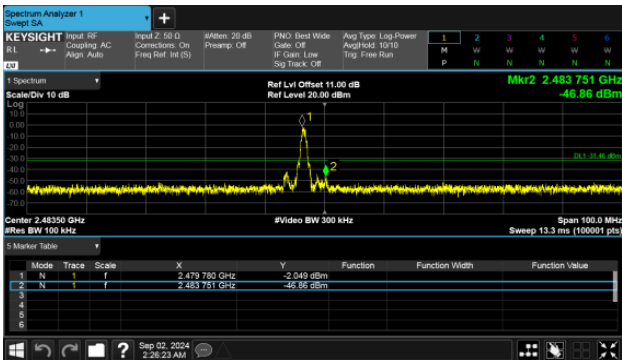
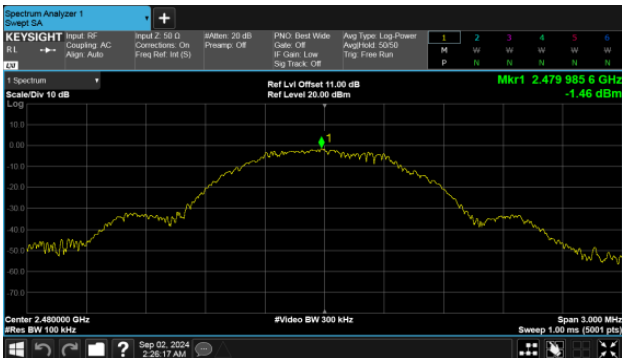





Modulation Type: GFSK(2Mbps)  
CH00

Modulation Type: GFSK(2Mbps)  
CH19

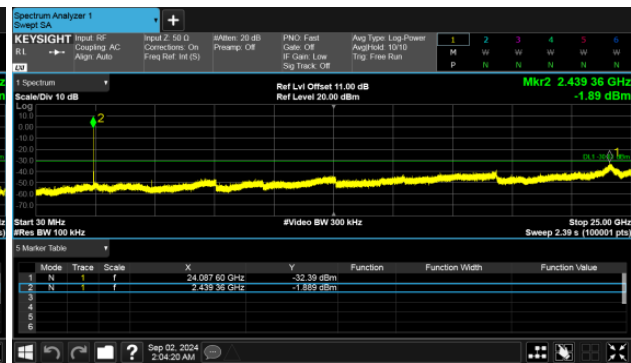
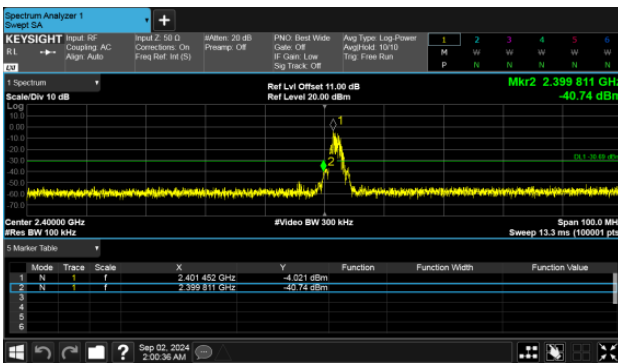
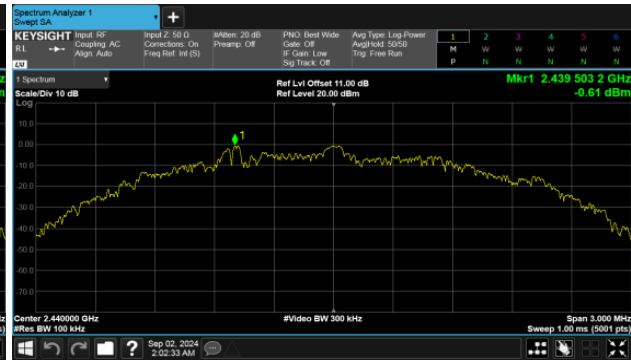
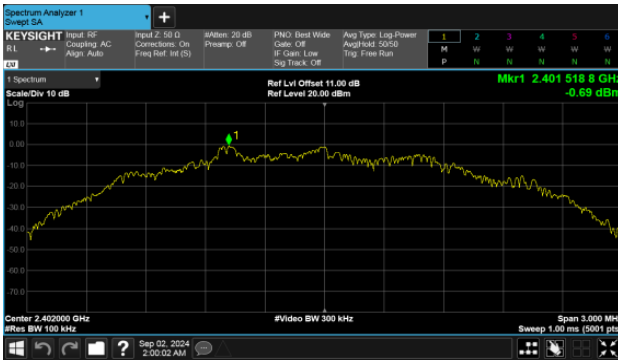



Modulation Type: GFSK(2Mbps)  
CH39

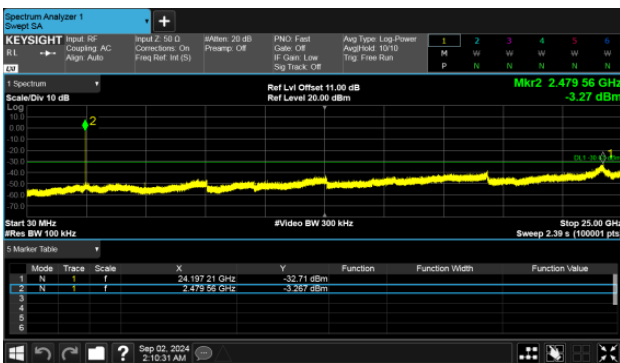
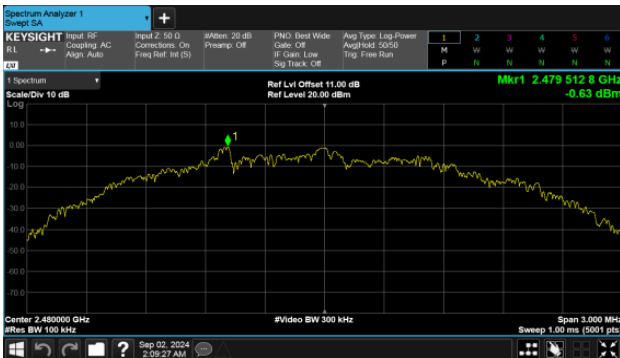



### 8. On Time, Duty Cycle and Measurement methods

#### 8.1 Test Limit

None; for reporting purposes only.

#### 8.2 Test Procedure

According to the methods defined in ANSI C63.10-2013 Section 11.6  
Zero-Span Spectrum Analyzer Method.

#### 8.3 Test Setup Layout

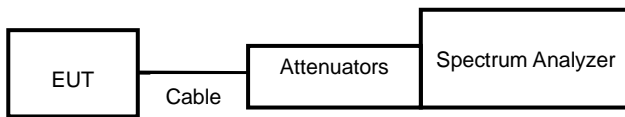

#### 8.4 Test Result and Data

Modulation Type	On Time (ms)	Period Time (ms)	Duty Cycle (%)
GFSK(1Mbps)	0.396	0.625	63.30%
GFSK(2Mbps)	0.213	0.625	34.10%

Modulation Type: GFSK(1Mbps)

Modulation Type: GFSK(2Mbps)

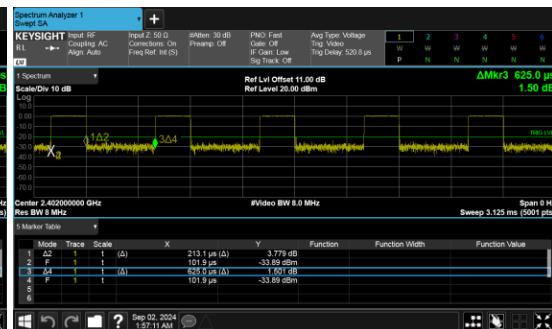
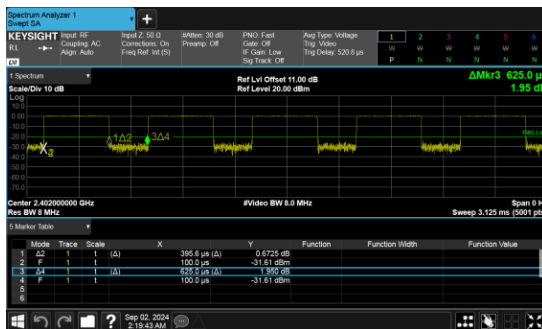



### 9. 6dB Bandwidth Measurement Data

#### 9.1 Test Limit

The minimum of 6dB Bandwidth Measurement is 0.5 MHz.

#### 9.2 Test Procedures

According to the methods defined in ANSI C63.10-2013 Section 11.8

- a. The transmitter output was connected to the spectrum analyzer.
- b. Set RBW of spectrum analyzer to 100 KHz and VBW to 300 KHz.
- c. The 6 dB bandwidth is defined as the total spectrum the power of which is higher than peak power minus 6 dB.
- d. The 6dB Bandwidth was measured and recorded.

#### 9.3 Test Setup Layout

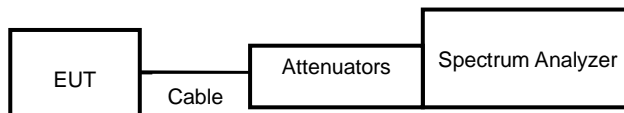

#### 9.4 Test Result and Data

Modulation Type	Channel	Frequency (MHz)	6dB Bandwidth (kHz)	Limit (kHz)
GFSK (1Mbps)	0	2402	663.20	500
	19	2440	664.60	500
	39	2480	673.00	500

Modulation Type	Channel	Frequency (MHz)	6dB Bandwidth (kHz)	Limit (kHz)
GFSK (2Mbps)	0	2402	1156.00	500
	19	2440	1146.00	500
	39	2480	1145.00	500



Modulation Type: GFSK(1Mbps)  
CH00

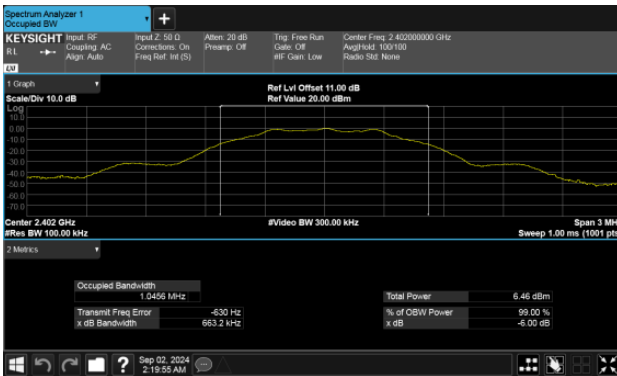

Modulation Type: GFSK(2Mbps)  
CH00

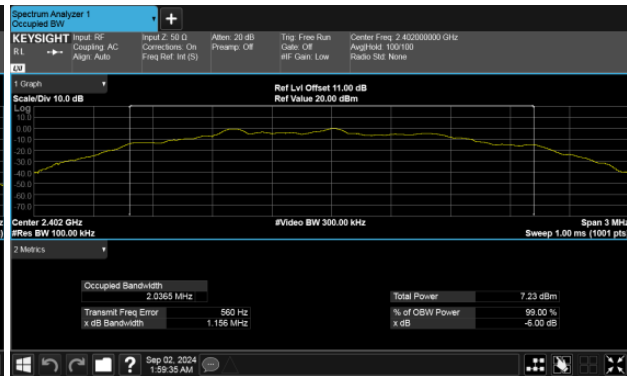

Modulation Type: GFSK(1Mbps)



Modulation Type: GFSK(2Mbps)



CH39

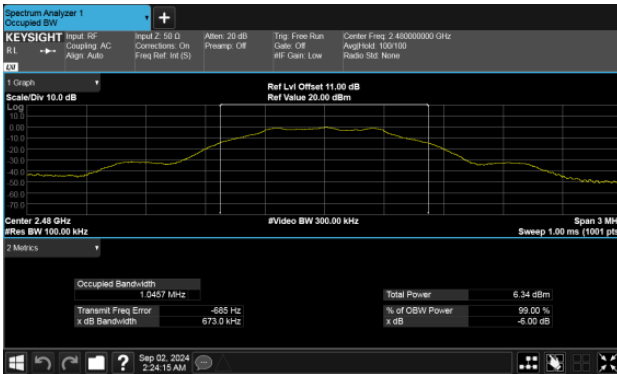

CH39

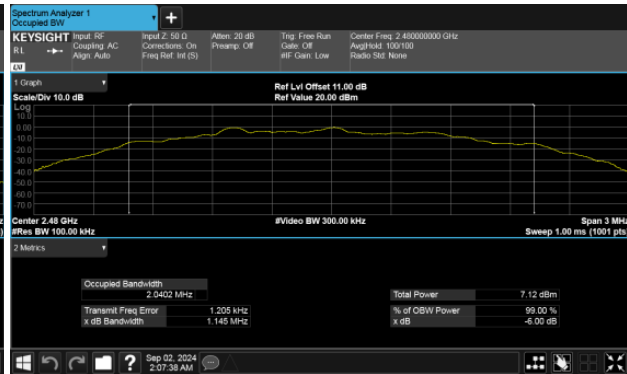

SK(2Mbps)



### 10. Maximum Average Output Power

#### 10.1 Test Limit

The Maximum Output Power Measurement is 30dBm.

#### 10.2 Test Procedures

According to the methods defined in ANSI C63.10-2013 Section 11.9.2.3.2

The antenna port (RF output) of the EUT was connected to the input (RF input) of a power meter. Power was read directly from the meter and cable loss connection was added to the reading to obtain power at the EUT antenna terminal. The EUT Output Power was set to maximum to produce the worse case test result.

#### 10.3 Test Setup Layout

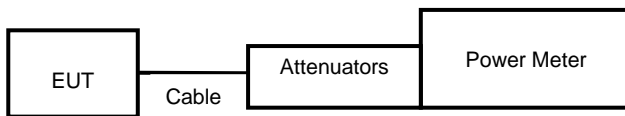

#### 10.4 Test Result and Data

GFSK(1Mbps)

Conducted Setting	Modulation Type	Channel	Frequency (MHz)	Power Output (dBm)	Power Output (mW)
				Average	Average
10	GFSK	0	2402	-0.04	0.991
10		19	2440	-0.02	0.995
10		39	2480	-0.29	0.935

GFSK(2Mbps)

Conducted Setting	Modulation Type	Channel	Frequency (MHz)	Power Output (dBm)	Power Output (mW)
				Average	Average
10	GFSK	0	2402	-0.02	0.995
10		19	2440	0.01	1.002
10		39	2480	-0.27	0.940



### 11. Power Spectral Density

#### 11.1 Test Limit

The Maximum of Power Spectral Density Measurement is 8dBm.

If transmitting antennas of directional gain greater than 6 dBi are used, the power spectral density shall be reduced by the amount in dB that the directional gain of the antenna exceeds 6 dBi

#### 11.2 Test Procedures

According to the methods defined in ANSI C63.10-2013 Section 11.10.1

#### 11.3 Test Setup Layout

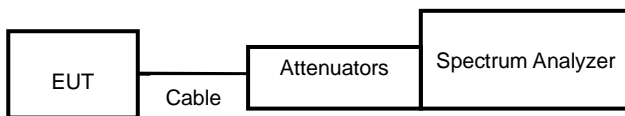

#### 11.4 Test Result and Data

Modulation Type	Channel	Frequency (MHz)	Maximum Power Density of 10KHz Bandwidth(dBm)	Duty Cycle CF(dB)	Total PSD (dBm)	Limit
GFSK (1Mbps)	0	2402	-16.735	1.99	-14.75	8.00
	19	2440	-16.898	1.99	-14.91	8.00
	39	2480	-16.819	1.99	-14.83	8.00

Modulation Type	Channel	Frequency (MHz)	Maximum Power Density of 10KHz Bandwidth(dBm)	Duty Cycle CF(dB)	Total PSD (dBm)	Limit
GFSK (2Mbps)	0	2402	-20.809	4.67	-16.14	8.00
	19	2440	-20.895	4.67	-16.22	8.00
	39	2480	-20.953	4.67	-16.28	8.00



Modulation Type: GFSK(1Mbps)  
CH00

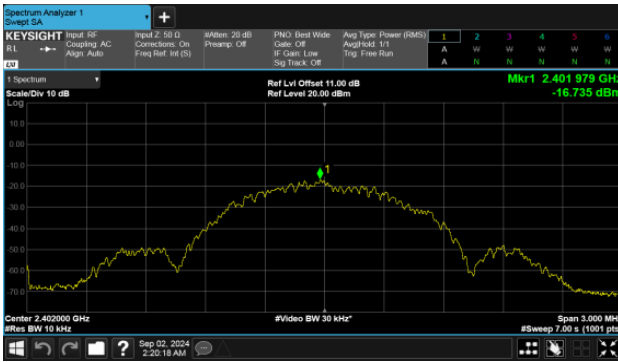

Modulation Type: GFSK(2Mbps)  
CH00

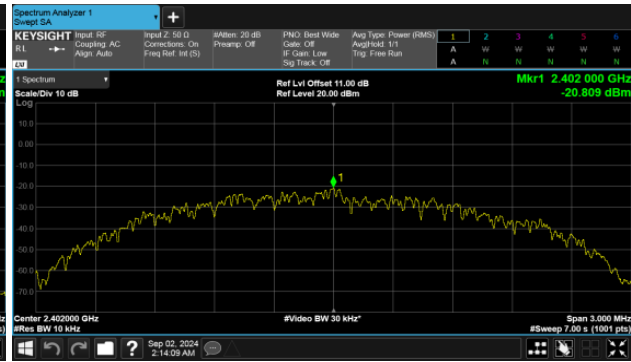

Modulation Type: GFSK(1Mbps)  
CH19

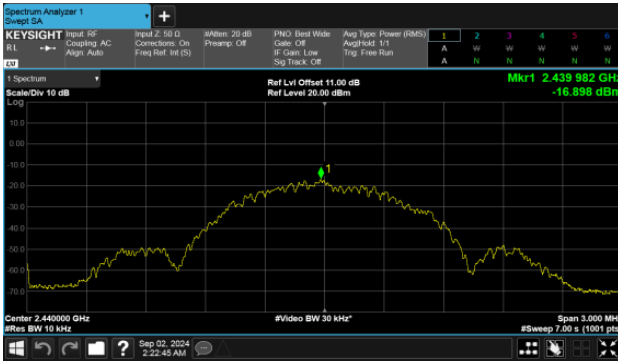

Modulation Type: GFSK(2Mbps)  
CH19

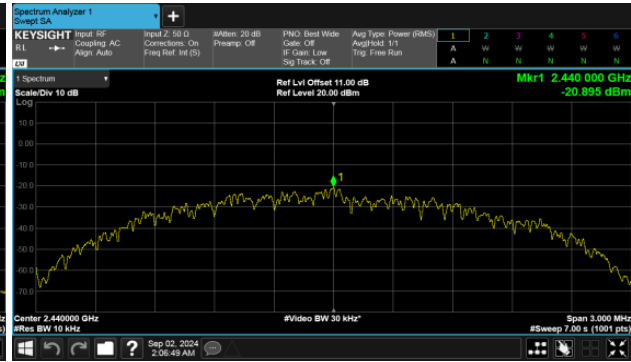

Modulation Type: GFSK(1Mbps)  
CH39

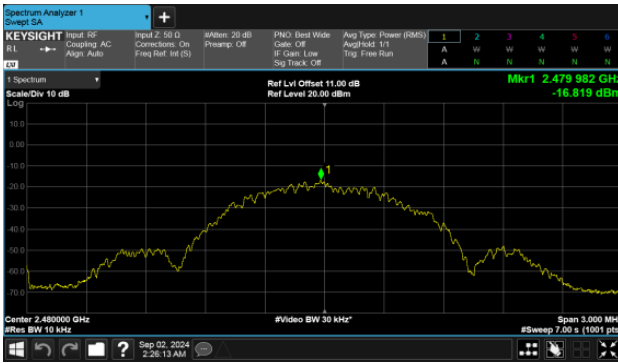

Modulation Type: GFSK(2Mbps)  
CH39

