

FCC Test Report

Report No.: RF190916C10-2

FCC ID: I4L-LAVIEPM9560

Test Model: PC-PM75GNAR

Received Date: Sep. 16, 2019

Test Date: Oct. 03 ~ Oct. 09, 2019

Issued Date: Oct. 18, 2019

Applicant: Micro-Star International Co., Ltd.

Address: No. 69, Lide St., Zhonghe Dist., 235 New Taipei City Taiwan

Issued By: Bureau Veritas Consumer Products Services (H.K.) Ltd., Taoyuan Branch
Lin Kou Laboratories

Lab Address: No. 47-2, 14th Ling, Chia Pau Vil., Lin Kou Dist., New Taipei City, Taiwan

Test Location (1): No.19, Hwa Ya 2nd Rd., Wen Hwa Vil., Kwei Shan Dist., Taoyuan City
33383, Taiwan

Test Location (2): B2F., No.215, Sec. 3, Beixin Rd., Xindian Dist., New Taipei City 231, Taiwan

**FCC Registration /
Designation Number:** 427177 / TW0011



This report is for your exclusive use. Any copying or replication of this report to or for any other person or entity, or use of our name or trademark, is permitted only with our prior written permission. This report sets forth our findings solely with respect to the test samples identified herein. The results set forth in this report are not indicative or representative of the quality or characteristics of the lot from which a test sample was taken or any similar or identical product unless specifically and expressly noted. Our report includes all of the tests requested by you and the results thereof based upon the information that you provided to us. You have 60 days from date of issuance of this report to notify us of any material error or omission caused by our negligence, provided, however, that such notice shall be in writing and shall specifically address the issue you wish to raise. A failure to raise such issue within the prescribed time shall constitute your unqualified acceptance of the completeness of this report, the tests conducted and the correctness of the report contents. Unless specific mention, the uncertainty of measurement has been explicitly taken into account to declare the compliance or non-compliance to the specification. The report must not be used by the client to claim product certification, approval, or endorsement by TAF or any government agencies.

Table of Contents

Release Control Record	4
1 Certificate of Conformity	5
2 Summary of Test Results	6
2.1 Measurement Uncertainty	6
2.2 Modification Record	6
3 General Information	7
3.1 General Description of EUT	7
3.2 Description of Test Modes	9
3.2.1 Test Mode Applicability and Tested Channel Detail	10
3.3 Duty Cycle of Test Signal	12
3.4 Description of Support Units	13
3.4.1 Configuration of System under Test	13
3.5 General Description of Applied Standards	13
4 Test Types and Results	14
4.1 Radiated Emission and Bandedge Measurement	14
4.1.1 Limits of Radiated Emission and Bandedge Measurement	14
4.1.2 Test Instruments	15
4.1.3 Test Procedures	16
4.1.4 Deviation from Test Standard	17
4.1.5 Test Set Up	17
4.1.6 EUT Operating Conditions	18
4.1.7 Test Results	19
4.2 Conducted Emission Measurement	41
4.2.1 Limits of Conducted Emission Measurement	41
4.2.2 Test Instruments	41
4.2.3 Test Procedures	42
4.2.4 Deviation from Test Standard	42
4.2.5 Test Setup	42
4.2.6 EUT Operating Conditions	42
4.2.7 Test Results	43
4.3 6 dB Bandwidth Measurement	45
4.3.1 Limits of 6 dB Bandwidth Measurement	45
4.3.2 Test Setup	45
4.3.3 Test Instruments	45
4.3.4 Test Procedure	45
4.3.5 Deviation from Test Standard	45
4.3.6 EUT Operating Conditions	45
4.3.7 Test Results	46
4.4 Occupied Bandwidth Measurement	48
4.4.1 Test Setup	48
4.4.2 Test Instruments	48
4.4.3 Test Procedure	48
4.4.4 Deviation from Test Standard	48
4.4.5 EUT Operating Conditions	48
4.4.6 Test Results	49
4.5 Conducted Output Power Measurement	51
4.5.1 Limits of Conducted Output Power Measurement	51
4.5.2 Test Setup	51
4.5.3 Test Instruments	51
4.5.4 Test Procedures	51
4.5.5 Deviation from Test Standard	51
4.5.6 EUT Operating Conditions	51
4.5.7 Test Results	52

4.6	Power Spectral Density Measurement	53
4.6.1	Limits of Power Spectral Density Measurement.....	53
4.6.2	Test Setup.....	53
4.6.3	Test Instruments	53
4.6.4	Test Procedure	53
4.6.5	Deviation from Test Standard	53
4.6.6	EUT Operating Condition	53
4.6.7	Test Results	54
4.7	Conducted Out of Band Emission Measurement	57
4.7.1	Limits of Conducted Out of Band Emission Measurement.....	57
4.7.2	Test Setup.....	57
4.7.3	Test Instruments	57
4.7.4	Test Procedure	57
4.7.5	Deviation from Test Standard	57
4.7.6	EUT Operating Condition	57
4.7.7	Test Results	58
5	Pictures of Test Arrangements.....	70
	Appendix – Information of the Testing Laboratories	71

Release Control Record

Issue No.	Description	Date Issued
RF190916C10-2	Original Release	Oct. 18, 2019

1 Certificate of Conformity

Product: Notebook

Brand: NEC Personal Computers, Ltd.

Test Model: PC-PM75GNAR

Sample Status: Mass product

Applicant: Micro-Star International Co., Ltd.

Test Date: Oct. 03 ~ Oct. 09, 2019

Standards: 47 CFR FCC Part 15, Subpart C (Section 15.247)
ANSI C63.10:2013

The above equipment has been tested by **Bureau Veritas Consumer Products Services (H.K.) Ltd., Taoyuan Branch**, and found compliance with the requirement of the above standards. The test record, data evaluation & Equipment Under Test (EUT) configurations represented herein are true and accurate accounts of the measurements of the sample's RF characteristics under the conditions specified in this report.

Prepared by : Gina Liu, **Date:** Oct. 18, 2019
Gina Liu / Specialist

Approved by : Dylan Chiou, **Date:** Oct. 18, 2019
Dylan Chiou / Project Engineer

2 Summary of Test Results

47 CFR FCC Part 15, Subpart C (Section 15.247)			
FCC Clause	Test Item	Result	Remarks
15.207	AC Power Conducted Emission	Pass	Meet the requirement of limit. Minimum passing margin is -18.15 dB at 0.1545 MHz.
15.205 / 15.209 / 15.247(d)	Radiated Emissions and Band Edge Measurement	Pass	Meet the requirement of limit. Minimum passing margin is -1.01 dB at 2389.83 MHz.
15.247(d)	Antenna Port Emission	Pass	Meet the requirement of limit.
15.247(a)(2)	6 dB Bandwidth	Pass	Meet the requirement of limit.
---	Occupied Bandwidth Measurement	Pass	Reference only
15.247(b)	Conducted power	Pass	Meet the requirement of limit.
15.247(e)	Power Spectral Density	Pass	Meet the requirement of limit.
15.203	Antenna Requirement	Pass	No antenna connector is used.

Note: Determining compliance based on the results of the compliance measurement, not taking into account measurement instrumentation uncertainty.

2.1 Measurement Uncertainty

Where relevant, the following measurement uncertainty levels have been estimated for tests performed on the EUT as specified in CISPR 16-4-2:

Measurement	Frequency	Expanded Uncertainty (k=2) (±)
Conducted Emissions at mains ports	150 kHz ~ 30 MHz	2.94 dB
Radiated Emissions up to 1 GHz	9 kHz ~ 30 MHz	3.04 dB
	30 MHz ~ 200 MHz	2.0153 dB
	200 MHz ~ 1000 MHz	2.0224 dB
Radiated Emissions above 1 GHz	1 GHz ~ 18 GHz	1.0121 dB
	18 GHz ~ 40 GHz	1.1508 dB

2.2 Modification Record

There were no modifications required for compliance.

3 General Information

3.1 General Description of EUT

Product	Notebook
Brand	NEC Personal Computers, Ltd.
Test Model	PC-PM75GNAR
Status of EUT	Mass product
Power Supply Rating	20 / 15 / 9 / 5 Vdc (adapter) 3.84 / 11.52 Vdc (Li-ion battery)
Modulation Type	CCK, DQPSK, DBPSK for DSSS 256QAM, 64QAM, 16QAM, QPSK, BPSK for OFDM
Modulation Technology	DSSS, OFDM
Transfer Rate	802.11b: 11.0 / 5.5 / 2.0 / 1.0 Mbps 802.11g: 54.0 / 48.0 / 36.0 / 24.0 / 18.0 / 12.0 / 9.0 / 6.0 Mbps 802.11n: up to MCS7 802.11ac: up to MCS9
Operating Frequency	2412 ~ 2472 MHz
Number of Channel	13 for 802.11b, 802.11g, 802.11n (HT20), 802.11ac (VHT20) 9 for 802.11n (HT40), 802.11ac (VHT40)
Output Power	351.111 mW
Antenna Type	PIFA antenna with -0.15 dBi gain
Antenna Connector	N/A
Accessory Device	Refer to Note as below
Data Cable Supplied	Refer to Note as below

Note:

1. The EUT incorporates a MIMO function. Physically, the EUT provides two completed transmitters and two receivers.

Modulation Mode	Tx Function
802.11b	1TX
802.11g	1TX
802.11n (HT20)	2TX
802.11n (HT40)	2TX
802.11ac (VHT20)	2TX
802.11ac (VHT40)	2TX

* The modulation and bandwidth are similar for 802.11n mode for HT20 / HT40 and 802.11ac mode for VHT20 / VHT40, therefore investigated worst case to representative mode in test report. (Final test mode refer section 3.2.1)

2. The EUT contains following accessory devices.

Product	Brand	Model	Description
Adapter	Lenovo	ADLX45YLC2D	I/P: 100-240 Vac, 50-60 Hz, 1.3 A O/P: 20 Vdc, 2.25 A; 15 Vdc, 3 A; 9 Vdc, 2 A; 5 Vdc, 2A
Battery	SIMPLO	945QA007H	SYS BATTERY PACK,LITHIUM-ION POLYMER,SMP/945QA007H,COSLIGHT/3.84V/3870MAH,3CELLS /3S1P,11.52V,3870MAH,CA485490G,BLACK,,13H1 FOR NEC- Hibiki,RoHS COMPLIANCE
CPU 1	Intel	Ci7-8565U(WHL-U)	w/ 8GB, w/ LTE/FPR connector
CPU 2	Intel	Ci5-8265U(WHL-U)	w/ 8GB, w/ LTE/FPR connector
CPU 3	Intel	Ci7-8565U(V0)	FOR NEC CONSIGN,CPU,WHISKEY LAKE,QUAD CORE i7-8565U,INTEL/CL8068404064407(QRYYY),1.8GHz,BGA-1528pin, 15W,V0 STEPPING/MM#999CN4,RoHS COMPLIANCE
CPU 4	Intel	Ci5-8265U(V0)	FOR NEC CONSIGN,CPU,WHISKEY LAKE,QUAD CORE i5--8265U,INTEL/CL8068404064608(QRZ0),1.6GHz,BGA-1528pin, 15W,V0 STEPPING/MM#999CN8,RoHS COMPLIANCE
WWAN Module	Intel	9560D2W	-

3. The above EUT information is declared by manufacturer and for more detailed features description, please refers to the manufacturer's specifications or user's manual.

3.2 Description of Test Modes

13 channels are provided for 802.11b, 802.11g, 802.11n (HT20) and 802.11ac (VHT20):

Channel	Frequency (MHz)	Channel	Frequency (MHz)
1	2412	8	2447
2	2417	9	2452
3	2422	10	2457
4	2427	11	2462
5	2432	12	2467
6	2437	13	2472
7	2442		

9 channels are provided for 802.11n (HT40) and 802.11ac (VHT40):

Channel	Frequency (MHz)	Channel	Frequency (MHz)
3	2422	8	2447
4	2427	9	2452
5	2432	10	2457
6	2437	11	2462
7	2442		

3.2.1 Test Mode Applicability and Tested Channel Detail

EUT Configure Mode	Applicable To				Description
	RE≥1G	RE<1G	PLC	APCM	
-	√	√	√	√	-

Where **RE≥1G**: Radiated Emission above 1 GHz **RE<1G**: Radiated Emission below 1 GHz
PLC: Power Line Conducted Emission **APCM**: Antenna Port Conducted Measurement

NOTE: “-” means no effect.

Radiated Emission Test (Above 1 GHz):

- Pre-Scan has been conducted to determine the worst-case mode from all possible combinations between available modulations, data rates and antenna ports (if EUT with antenna diversity architecture).
- Following channel(s) was (were) selected for the final test as listed below.

EUT Configure Mode	Mode	Available Channel	Tested Channel	Modulation Technology	Modulation Type	Data Rate (Mbps)
-	802.11b	1 to 13	1, 6, 11, 12, 13	DSSS	DBPSK	1.0
-	802.11g	1 to 13	1, 6, 11, 12, 13	OFDM	BPSK	6.0
-	802.11n (HT20)	1 to 13	1, 6, 11, 12, 13	OFDM	BPSK	6.5
-	802.11n (HT40)	3 to 11	3, 6, 9, 10, 11	OFDM	BPSK	13.5

Radiated Emission Test (Below 1 GHz):

- Pre-Scan has been conducted to determine the worst-case mode from all possible combinations between available modulations, data rates and antenna ports (if EUT with antenna diversity architecture).
- Following channel(s) was (were) selected for the final test as listed below.

EUT Configure Mode	Mode	Available Channel	Tested Channel	Modulation Technology	Modulation Type	Data Rate (Mbps)
-	802.11b	1 to 13	1	DSSS	DBPSK	1.0

Power Line Conducted Emission Test:

- Pre-Scan has been conducted to determine the worst-case mode from all possible combinations between available modulations, data rates and antenna ports (if EUT with antenna diversity architecture).
- Following channel(s) was (were) selected for the final test as listed below.

EUT Configure Mode	Mode	Available Channel	Tested Channel	Modulation Technology	Modulation Type	Data Rate (Mbps)
-	802.11b	1 to 13	1	DSSS	DBPSK	1.0

Bandedge Measurement:

- Pre-Scan has been conducted to determine the worst-case mode from all possible combinations between available modulations, data rates and antenna ports (if EUT with antenna diversity architecture).
- Following channel(s) was (were) selected for the final test as listed below.

EUT Configure Mode	Mode	Available Channel	Tested Channel	Modulation Technology	Modulation Type	Data Rate (Mbps)
-	802.11b	1 to 13	1, 11, 12, 13	DSSS	DBPSK	1.0
-	802.11g	1 to 13	1, 11, 12, 13	OFDM	BPSK	6.0
-	802.11n (HT20)	1 to 13	1, 11, 12, 13	OFDM	BPSK	6.5
-	802.11n (HT40)	3 to 9	3, 9, 10, 11	OFDM	BPSK	13.5

Antenna Port Conducted Measurement:

- This item includes all test value of each mode, but only includes spectrum plot of worst value of each mode.
- Pre-Scan has been conducted to determine the worst-case mode from all possible combinations between available modulations, data rates and antenna ports (if EUT with antenna diversity architecture).
- Following channel(s) was (were) selected for the final test as listed below.

EUT Configure Mode	Mode	Available Channel	Tested Channel	Modulation Technology	Modulation Type	Data Rate (Mbps)
-	802.11b	1 to 13	1, 6, 11, 12, 13	DSSS	DBPSK	1.0
-	802.11g	1 to 13	1, 6, 11, 12, 13	OFDM	BPSK	6.0
-	802.11n (HT20)	1 to 13	1, 6, 11, 12, 13	OFDM	BPSK	6.5
-	802.11n (HT40)	3 to 9	3, 6, 9, 10, 11	OFDM	BPSK	13.5

Test Condition:

Applicable To	Environmental Conditions	Input Power	Tested by
RE≥1G	25 deg. C, 65 % RH	120 Vac, 60 Hz	Karl Lee, Charles Hsiao, Harry Hsueh
RE<1G	25 deg. C, 65 % RH	120 Vac, 60 Hz	Karl Lee
PLC	25 deg. C, 65 % RH	120 Vac, 60 Hz	Getaz Yang
APCM	25 deg. C, 65 % RH	11.52 Vdc	Wayne Lin

3.3 Duty Cycle of Test Signal

802.11b: Duty cycle of test signal is $\geq 98\%$, duty factor is not required.

802.11g: Duty cycle = $2.046/2.089 = 0.979$, Duty factor = $10 * \log(1/0.979) = 0.09$

802.11n (HT20): Duty cycle = $1.906/1.949 = 0.978$, Duty factor = $10 * \log(1/0.978) = 0.10$

802.11n (HT40): Duty cycle = $0.936/0.977 = 0.958$, Duty factor = $10 * \log(1/0.958) = 0.19$

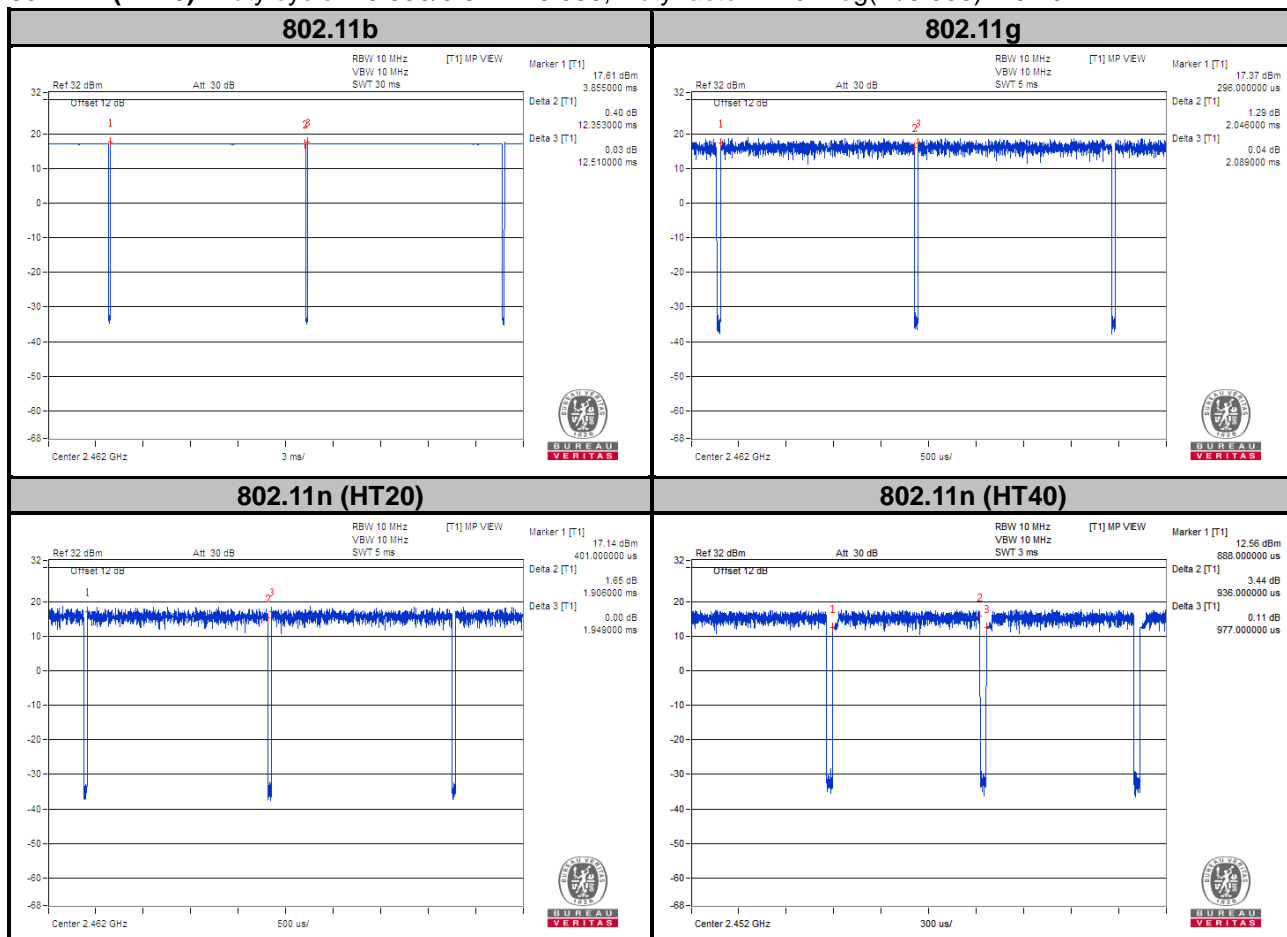

3.4 Description of Support Units

The EUT has been tested as an independent unit together with other necessary accessories or support units.

3.4.1 Configuration of System under Test

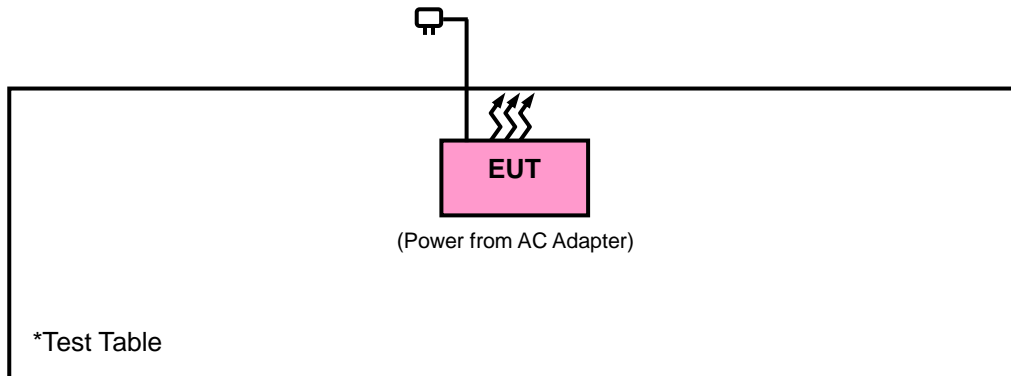

3.5 General Description of Applied Standards

The EUT is a RF Product. According to the specifications of the manufacturer, it must comply with the requirements of the following standards:

FCC Part 15, Subpart C (15.247)

KDB 558074 D01 15.247 Meas Guidance v05r02

KDB 662911 D01 Multiple Transmitter Output v02r01

ANSI C63.10-2013

All test items have been performed and recorded as per the above standards.

4 Test Types and Results

4.1 Radiated Emission and Bandedge Measurement

4.1.1 Limits of Radiated Emission and Bandedge Measurement

Radiated emissions which fall in the restricted bands must comply with the radiated emission limits specified as below table. Other emissions shall be at least 20 dB below the highest level of the desired power:

Frequencies (MHz)	Field Strength (microvolts/meter)	Measurement Distance (meters)
0.009 ~ 0.490	2400/F (kHz)	300
0.490 ~ 1.705	24000/F (kHz)	30
1.705 ~ 30.0	30	30
30 ~ 88	100	3
88 ~ 216	150	3
216 ~ 960	200	3
Above 960	500	3

NOTE:

1. The lower limit shall apply at the transition frequencies.
2. Emission level (dBuV/m) = 20 log Emission level (uV/m).
3. For frequencies above 1000 MHz, the field strength limits are based on average detector, however, the peak field strength of any emission shall not exceed the maximum permitted average limits, specified above by more than 20 dB under any condition of modulation.

4.1.2 Test Instruments

Description & Manufacturer	Model No.	Serial No.	Date of Calibration	Due Date of Calibration
Test Receiver Agilent Technologies	N9038A	MY52260177	Aug. 26, 2019	Aug. 25, 2020
Spectrum Analyzer ROHDE & SCHWARZ	FSU43	101261	Apr. 15, 2019	Apr. 14, 2020
BILOG Antenna SCHWARZBECK	VULB 9168	9168-616	Nov. 27, 2018	Nov. 26, 2019
HORN Antenna ETS-Lindgren	3117	00143293	Nov. 25, 2018	Nov. 24, 2019
HORN Antenna SCHWARZBECK	BBHA 9170	9170-480	Nov. 25, 2018	Nov. 24, 2019
Fixed Attenuator Mini-Circuits	MDCS18N-10	MDCS18N-10-01	Apr. 15, 2019	Apr. 14, 2020
Loop Antenna	HLA 6121	45745	Jul. 01, 2019	Jun. 30, 2020
Preamplifier Agilent	310N	187226	Jun. 18, 2019	Jun. 17, 2020
Preamplifier Agilent	83017A	MY39501357	Jun. 18, 2019	Jun. 17, 2020
Power Meter Anritsu	ML2495A	1012010	Sep. 04, 2019	Sep. 03, 2020
Power Sensor Anritsu	MA2411B	1315050	Sep. 04, 2019	Sep. 03, 2020
RF signal cable ETS-LINDGREN	5D-FB	Cable-CH1-01(RFC -SMS-100-SMS-12 0+RFC-SMS-100-S MS-400)	Jun. 18, 2019	Jun. 17, 2020
RF signal cable ETS-LINDGREN	8D-FB	Cable-CH1-02(RFC -SMS-100-SMS-24)	Jun. 18, 2019	Jun. 17, 2020
Software BV ADT	E3 8.130425b	NA	NA	NA
Antenna Tower MF	NA	NA	NA	NA
Turn Table MF	NA	NA	NA	NA
Antenna Tower & Turn Table Controller MF	MF-7802	NA	NA	NA

- Note: 1. The calibration interval of the above test instruments is 12 months and the calibrations are traceable to NML/ROC and NIST/USA.
2. The test was performed in HsinTien Chamber 1.

4.1.3 Test Procedures

For Radiated Emission below 30 MHz

- a. The EUT was placed on the top of a rotating table 0.8 meters above the ground at a 3 meter chamber room. The table was rotated 360 degrees to determine the position of the highest radiation.
- b. The EUT was set 3 meters away from the interference-receiving antenna, which was mounted on the top of a variable-height antenna tower.
- c. Parallel, perpendicular, and ground-parallel orientations of the antenna are set to make the measurement.
- d. For each suspected emission, the EUT was arranged to its worst case and the rotatable table was turned from 0 degrees to 360 degrees to find the maximum reading.
- e. The test-receiver system was set to Quasi-Peak Detect Function and Specified Bandwidth with Maximum Hold Mode.

Note:

1. The resolution bandwidth and video bandwidth of test receiver/spectrum analyzer is 9 kHz at frequency below 30 MHz.

For Radiated Emission above 30 MHz

- a. The EUT was placed on the top of a rotating table 0.8 meters (for 30 MHz ~ 1 GHz) / 1.5 meters (for above 1 GHz) above the ground at 3 meter chamber room for test. The table was rotated 360 degrees to determine the position of the highest radiation.
- b. The EUT was set 3 meters away from the interference-receiving antenna, which was mounted on the top of a variable-height antenna tower.
- c. The height of antenna is varied from one meter to four meters above the ground to determine the maximum value of the field strength. Both horizontal and vertical polarizations of the antenna are set to make the measurement.
- d. For each suspected emission, the EUT was arranged to its worst case and then the antenna was tuned to heights from 1 meter to 4 meters and the rotatable table was turned from 0 degrees to 360 degrees to find the maximum reading.
- e. The test-receiver system was set to quasi-peak detect function and specified bandwidth with maximum hold mode when the test frequency is below 1 GHz.
- f. The test-receiver system was set to peak and average detected function and specified bandwidth with maximum hold mode when the test frequency is above 1 GHz. If the peak reading value also meets average limit, measurement with the average detector is unnecessary.

Note:

1. The resolution bandwidth and video bandwidth of test receiver/spectrum analyzer is 120 kHz for Quasi-peak detection (QP) or Peak detection (PK) at frequency below 1 GHz.
2. The resolution bandwidth of test receiver/spectrum analyzer is 1 MHz and the video bandwidth is 3 MHz for Peak detection (PK) at frequency above 1 GHz.
3. The resolution bandwidth of test receiver/spectrum analyzer is 1 MHz and the video bandwidth is $\geq 1/T$ (Duty cycle < 98 %) or 10 Hz (Duty cycle ≥ 98 %) for Average detection (AV) at frequency above 1 GHz.
(11b: RBW = 1 MHz, VBW = 1 Hz ; 11g: RBW = 1 MHz, VBW = 1 kHz ;
11n (HT20): RBW = 1 MHz, VBW = 1 kHz ; 11n (HT40): RBW = 1 MHz, VBW = 2 kHz)
4. All modes of operation were investigated and the worst-case emissions are reported.

4.1.4 Deviation from Test Standard

No deviation.

4.1.5 Test Set Up

<Radiated Emission below 30 MHz>

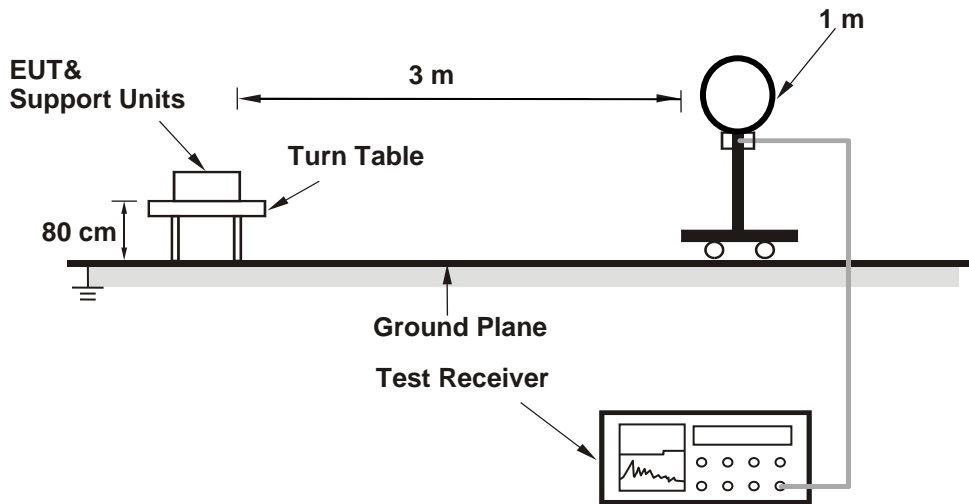

<Radiated Emission 30 MHz to 1 GHz>

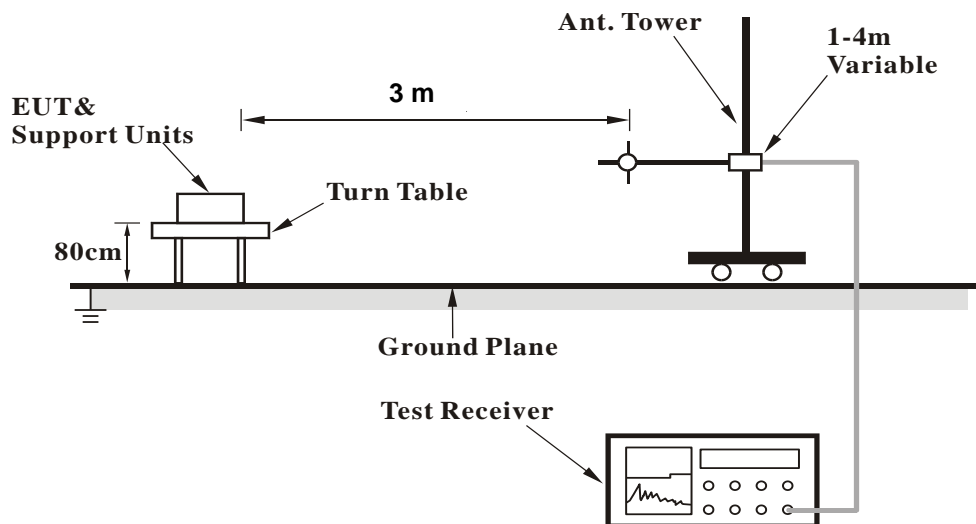

<Radiated Emission above 1 GHz>

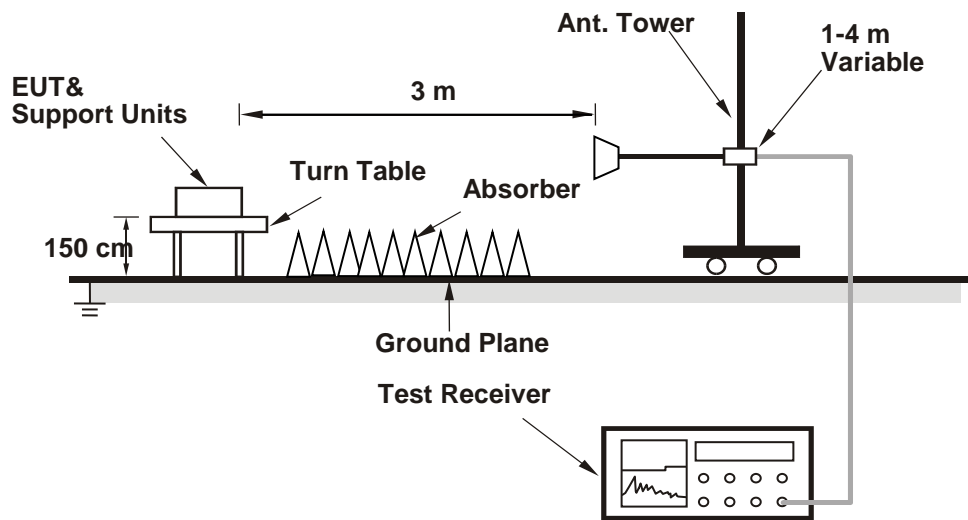

For the actual test configuration, please refer to the attached file (Test Setup Photo).

4.1.6 EUT Operating Conditions

- a. Placed the EUT on a testing table.
- b. Use the software to control the EUT under transmission condition continuously at specific channel frequency.

4.1.7 Test Results

Above 1 GHz Data :
802.11b

EUT Test Condition		Measurement Detail	
Channel	Channel 1	Frequency Range	1 GHz ~ 25 GHz
Input Power	120 Vac, 60 Hz	Detector Function	Peak (PK) Average (AV)
Environmental Conditions	25 deg. C, 65 % RH	Tested By	Karl Lee

Antenna Polarity & Test Distance: Horizontal at 3 m								
Frequency (MHz)	Emission Level (dBuV/m)	Read Level (dBuV)	Factor (dB/m)	Limit (dBuV/m)	Margin (dB)	Antenna Height (cm)	Table Angle (Degree)	Remark
2389.83	52.99	48.49	4.5	54	-1.01	100	240	Average
2389.83	66.5	62	4.5	74	-7.5	100	240	Peak
2412	103.1	98.55	4.55			100	240	Average
2412	105.33	100.78	4.55			100	240	Peak
4824	40.86	30.57	10.29	54	-13.14	159	131	Average
4824	47.03	36.74	10.29	74	-26.97	159	131	Peak

Antenna Polarity & Test Distance: Vertical at 3 m								
Frequency (MHz)	Emission Level (dBuV/m)	Read Level (dBuV)	Factor (dB/m)	Limit (dBuV/m)	Margin (dB)	Antenna Height (cm)	Table Angle (Degree)	Remark
2389.29	52.28	47.79	4.49	54	-1.72	129	262	Average
2389.29	64.28	59.79	4.49	74	-9.72	129	262	Peak
2412	101.28	96.73	4.55			129	262	Average
2412	103.64	99.09	4.55			129	262	Peak
4824	41.26	30.97	10.29	54	-12.74	132	110	Average
4824	47.55	37.26	10.29	74	-26.45	132	110	Peak

Remarks:

- Emission Level = Read Level + Factor
Margin value = Emission level – Limit value
- 2412 MHz: Fundamental frequency.
- The emission levels of other frequencies were very low against the limit.

EUT Test Condition		Measurement Detail	
Channel	Channel 6	Frequency Range	1 GHz ~ 25 GHz
Input Power	120 Vac, 60 Hz	Detector Function	Peak (PK) Average (AV)
Environmental Conditions	25 deg. C, 65 % RH	Tested By	Karl Lee

Antenna Polarity & Test Distance: Horizontal at 3 m								
Frequency (MHz)	Emission Level (dBuV/m)	Read Level (dBuV)	Factor (dB/m)	Limit (dBuV/m)	Margin (dB)	Antenna Height (cm)	Table Angle (Degree)	Remark
2388.48	50.64	46.15	4.49	54	-3.36	114	240	Average
2388.48	58.65	54.16	4.49	74	-15.35	114	240	Peak
2437	105.47	100.88	4.59			114	240	Average
2437	108.91	104.32	4.59			114	240	Peak
2485.72	50.17	45.51	4.66	54	-3.83	114	240	Average
2485.72	57.08	52.42	4.66	74	-16.92	114	240	Peak
4874	41.51	31.3	10.21	54	-12.49	196	241	Average
4874	47.78	37.57	10.21	74	-26.22	196	241	Peak

Antenna Polarity & Test Distance: Vertical at 3 m								
Frequency (MHz)	Emission Level (dBuV/m)	Read Level (dBuV)	Factor (dB/m)	Limit (dBuV/m)	Margin (dB)	Antenna Height (cm)	Table Angle (Degree)	Remark
2388.39	48.69	44.2	4.49	54	-5.31	118	262	Average
2388.39	55.69	51.2	4.49	74	-18.31	118	262	Peak
2437	104.56	99.97	4.59			118	262	Average
2437	107.79	103.2	4.59			118	262	Peak
2484.52	47.8	43.14	4.66	54	-6.2	118	262	Average
2484.52	54.88	50.22	4.66	74	-19.12	118	262	Peak
4874	40.18	29.97	10.21	54	-13.82	104	137	Average
4874	46.42	36.21	10.21	74	-27.58	104	137	Peak

Remarks:

- Emission Level = Read Level + Factor
Margin value = Emission level – Limit value
- 2437 MHz: Fundamental frequency.
- The emission levels of other frequencies were very low against the limit.

EUT Test Condition		Measurement Detail	
Channel	Channel 11	Frequency Range	1 GHz ~ 25 GHz
Input Power	120 Vac, 60 Hz	Detector Function	Peak (PK) Average (AV)
Environmental Conditions	25 deg. C, 65 % RH	Tested By	Karl Lee

Antenna Polarity & Test Distance: Horizontal at 3 m								
Frequency (MHz)	Emission Level (dBuV/m)	Read Level (dBuV)	Factor (dB/m)	Limit (dBuV/m)	Margin (dB)	Antenna Height (cm)	Table Angle (Degree)	Remark
2462	102.36	97.74	4.62			109	240	Average
2462	106.06	101.44	4.62			109	240	Peak
2484.04	52.3	47.64	4.66	54	-1.7	109	240	Average
2484.04	67.57	62.91	4.66	74	-6.43	109	240	Peak
4924	41.66	31.41	10.25	54	-12.34	150	175	Average
4924	47.87	37.62	10.25	74	-26.13	150	175	Peak
Antenna Polarity & Test Distance: Vertical at 3 m								
Frequency (MHz)	Emission Level (dBuV/m)	Read Level (dBuV)	Factor (dB/m)	Limit (dBuV/m)	Margin (dB)	Antenna Height (cm)	Table Angle (Degree)	Remark
2462	100.98	96.36	4.62			148	262	Average
2462	104.44	99.82	4.62			148	262	Peak
2484.08	49.62	44.96	4.66	54	-4.38	148	262	Average
2484.08	64.95	60.29	4.66	74	-9.05	148	262	Peak
4924	41.26	31.01	10.25	54	-12.74	174	115	Average
4924	47.6	37.35	10.25	74	-26.4	174	115	Peak

Remarks:

- Emission Level = Read Level + Factor
Margin value = Emission level – Limit value
- 2462 MHz: Fundamental frequency.
- The emission levels of other frequencies were very low against the limit.

EUT Test Condition		Measurement Detail	
Channel	Channel 12	Frequency Range	1 GHz ~ 25 GHz
Input Power	120 Vac, 60 Hz	Detector Function	Peak (PK) Average (AV)
Environmental Conditions	25 deg. C, 65 % RH	Tested By	Karl Lee

Antenna Polarity & Test Distance: Horizontal at 3 m								
Frequency (MHz)	Emission Level (dBuV/m)	Read Level (dBuV)	Factor (dB/m)	Limit (dBuV/m)	Margin (dB)	Antenna Height (cm)	Table Angle (Degree)	Remark
2467	99.09	94.46	4.63			110	240	Average
2467	102.5	97.87	4.63			110	240	Peak
2483.88	52.66	48	4.66	54	-1.34	110	240	Average
2483.88	67.19	62.53	4.66	74	-6.81	110	240	Peak
4934	42.15	31.89	10.26	54	-11.85	160	304	Average
4934	48.07	37.81	10.26	74	-25.93	160	304	Peak
Antenna Polarity & Test Distance: Vertical at 3 m								
Frequency (MHz)	Emission Level (dBuV/m)	Read Level (dBuV)	Factor (dB/m)	Limit (dBuV/m)	Margin (dB)	Antenna Height (cm)	Table Angle (Degree)	Remark
2467	96.73	92.1	4.63			148	262	Average
2467	100.31	95.68	4.63			148	262	Peak
2484.24	50.19	45.53	4.66	54	-3.81	148	262	Average
2484.24	64.41	59.75	4.66	74	-9.59	148	262	Peak
4934	41.46	31.2	10.26	54	-12.54	181	104	Average
4934	47.61	37.35	10.26	74	-26.39	181	104	Peak

Remarks:

- Emission Level = Read Level + Factor
Margin value = Emission level – Limit value
- 2467 MHz: Fundamental frequency.
- The emission levels of other frequencies were very low against the limit.

EUT Test Condition		Measurement Detail	
Channel	Channel 13	Frequency Range	1 GHz ~ 25 GHz
Input Power	120 Vac, 60 Hz	Detector Function	Peak (PK) Average (AV)
Environmental Conditions	25 deg. C, 65 % RH	Tested By	Karl Lee

Antenna Polarity & Test Distance: Horizontal at 3 m								
Frequency (MHz)	Emission Level (dBuV/m)	Read Level (dBuV)	Factor (dB/m)	Limit (dBuV/m)	Margin (dB)	Antenna Height (cm)	Table Angle (Degree)	Remark
2472	96.57	91.93	4.64			118	240	Average
2472	98.65	94.01	4.64			118	240	Peak
2483.6	52.67	48.01	4.66	54	-1.33	118	240	Average
2483.6	69.66	65	4.66	74	-4.34	118	240	Peak
4944	42.06	31.71	10.35	54	-11.94	138	52	Average
4944	48.14	37.79	10.35	74	-25.86	138	52	Peak
Antenna Polarity & Test Distance: Vertical at 3 m								
Frequency (MHz)	Emission Level (dBuV/m)	Read Level (dBuV)	Factor (dB/m)	Limit (dBuV/m)	Margin (dB)	Antenna Height (cm)	Table Angle (Degree)	Remark
2472	94.68	90.04	4.64			148	262	Average
2472	97.09	92.45	4.64			148	262	Peak
2483.8	49.96	45.3	4.66	54	-4.04	148	262	Average
2483.8	66.4	61.74	4.66	74	-7.6	148	262	Peak
4944	41.29	30.94	10.35	54	-12.71	151	134	Average
4944	47.5	37.15	10.35	74	-26.5	151	134	Peak

Remarks:

- Emission Level = Read Level + Factor
Margin value = Emission level – Limit value
- 2472 MHz: Fundamental frequency.
- The emission levels of other frequencies were very low against the limit.

802.11g

EUT Test Condition		Measurement Detail	
Channel	Channel 1	Frequency Range	1 GHz ~ 25 GHz
Input Power	120 Vac, 60 Hz	Detector Function	Peak (PK) Average (AV)
Environmental Conditions	25 deg. C, 65 % RH	Tested By	Karl Lee

Antenna Polarity & Test Distance: Horizontal at 3 m								
Frequency (MHz)	Emission Level (dBuV/m)	Read Level (dBuV)	Factor (dB/m)	Limit (dBuV/m)	Margin (dB)	Antenna Height (cm)	Table Angle (Degree)	Remark
2389.92	52.19	47.69	4.5	54	-1.81	100	240	Average
2389.92	66.27	61.77	4.5	74	-7.73	100	240	Peak
2412	99.92	95.37	4.55			100	240	Average
2412	107.66	103.11	4.55			100	240	Peak
4824	41.58	31.29	10.29	54	-12.42	136	6	Average
4824	46.84	36.55	10.29	74	-27.16	136	6	Peak
Antenna Polarity & Test Distance: Vertical at 3 m								
Frequency (MHz)	Emission Level (dBuV/m)	Read Level (dBuV)	Factor (dB/m)	Limit (dBuV/m)	Margin (dB)	Antenna Height (cm)	Table Angle (Degree)	Remark
2389.92	50.82	46.32	4.5	54	-3.18	129	262	Average
2389.92	64.25	59.75	4.5	74	-9.75	129	262	Peak
2412	97.73	93.18	4.55			129	262	Average
2412	106.27	101.72	4.55			129	262	Peak
4824	41.57	31.28	10.29	54	-12.43	134	113	Average
4824	47.6	37.31	10.29	74	-26.4	134	113	Peak

Remarks:

- Emission Level = Read Level + Factor
Margin value = Emission level – Limit value
- 2412 MHz: Fundamental frequency.
- The emission levels of other frequencies were very low against the limit.

EUT Test Condition		Measurement Detail	
Channel	Channel 6	Frequency Range	1 GHz ~ 25 GHz
Input Power	120 Vac, 60 Hz	Detector Function	Peak (PK) Average (AV)
Environmental Conditions	25 deg. C, 65 % RH	Tested By	Karl Lee

Antenna Polarity & Test Distance: Horizontal at 3 m								
Frequency (MHz)	Emission Level (dBuV/m)	Read Level (dBuV)	Factor (dB/m)	Limit (dBuV/m)	Margin (dB)	Antenna Height (cm)	Table Angle (Degree)	Remark
2389.83	48.04	43.54	4.5	54	-5.96	114	240	Average
2389.83	61.24	56.74	4.5	74	-12.76	114	240	Peak
2437	101.87	97.28	4.59			114	240	Average
2437	109.69	105.1	4.59			114	240	Peak
2484	49.59	44.93	4.66	54	-4.41	114	240	Average
2484	66.65	61.99	4.66	74	-7.35	114	240	Peak
4874	41.45	31.24	10.21	54	-12.55	174	19	Average
4874	47.5	37.29	10.21	74	-26.5	174	19	Peak

Antenna Polarity & Test Distance: Vertical at 3 m								
Frequency (MHz)	Emission Level (dBuV/m)	Read Level (dBuV)	Factor (dB/m)	Limit (dBuV/m)	Margin (dB)	Antenna Height (cm)	Table Angle (Degree)	Remark
2389.92	46.09	41.59	4.5	54	-7.91	118	262	Average
2389.92	59.94	55.44	4.5	74	-14.06	118	262	Peak
2437	100.12	95.53	4.59			118	262	Average
2437	108.76	104.17	4.59			118	262	Peak
2483.52	47.61	42.95	4.66	54	-6.39	118	262	Average
2483.52	61.55	56.89	4.66	74	-12.45	118	262	Peak
4874	41.53	31.32	10.21	54	-12.47	127	208	Average
4874	46.98	36.77	10.21	74	-27.02	127	208	Peak

Remarks:

- Emission Level = Read Level + Factor
Margin value = Emission level – Limit value
- 2437 MHz: Fundamental frequency.
- The emission levels of other frequencies were very low against the limit.

EUT Test Condition		Measurement Detail	
Channel	Channel 11	Frequency Range	1 GHz ~ 25 GHz
Input Power	120 Vac, 60 Hz	Detector Function	Peak (PK) Average (AV)
Environmental Conditions	25 deg. C, 65 % RH	Tested By	Karl Lee

Antenna Polarity & Test Distance: Horizontal at 3 m								
Frequency (MHz)	Emission Level (dBuV/m)	Read Level (dBuV)	Factor (dB/m)	Limit (dBuV/m)	Margin (dB)	Antenna Height (cm)	Table Angle (Degree)	Remark
2462	99.62	95	4.62			109	240	Average
2462	107.95	103.33	4.62			109	240	Peak
2483.6	52.49	15.36	37.13	54	-1.51	109	240	Average
2483.6	65.29	60.63	4.66	74	-8.71	109	240	Peak
4924	41.74	31.49	10.25	54	-12.26	151	34	Average
4924	46.92	36.67	10.25	74	-27.08	151	34	Peak
Antenna Polarity & Test Distance: Vertical at 3 m								
Frequency (MHz)	Emission Level (dBuV/m)	Read Level (dBuV)	Factor (dB/m)	Limit (dBuV/m)	Margin (dB)	Antenna Height (cm)	Table Angle (Degree)	Remark
2462	96.88	92.26	4.62			148	262	Average
2462	105.52	100.9	4.62			148	262	Peak
2483.56	50.09	45.43	4.66	54	-3.91	148	262	Average
2483.56	63.67	59.01	4.66	74	-10.33	148	262	Peak
4924	41.7	31.45	10.25	54	-12.3	144	167	Average
4924	46.94	36.69	10.25	74	-27.06	144	167	Peak

Remarks:

- Emission Level = Read Level + Factor
Margin value = Emission level – Limit value
- 2462 MHz: Fundamental frequency.
- The emission levels of other frequencies were very low against the limit.

EUT Test Condition		Measurement Detail	
Channel	Channel 12	Frequency Range	1 GHz ~ 25 GHz
Input Power	120 Vac, 60 Hz	Detector Function	Peak (PK) Average (AV)
Environmental Conditions	25 deg. C, 65 % RH	Tested By	Karl Lee

Antenna Polarity & Test Distance: Horizontal at 3 m								
Frequency (MHz)	Emission Level (dBuV/m)	Read Level (dBuV)	Factor (dB/m)	Limit (dBuV/m)	Margin (dB)	Antenna Height (cm)	Table Angle (Degree)	Remark
2467	96.81	92.18	4.63			110	240	Average
2467	103.59	98.96	4.63			110	240	Peak
2483.52	50.93	46.27	4.66	54	-3.07	110	240	Average
2483.52	63.28	58.62	4.66	74	-10.72	110	240	Peak
4934	41.64	31.38	10.26	54	-12.36	166	36	Average
4934	48.29	38.03	10.26	74	-25.71	166	36	Peak
Antenna Polarity & Test Distance: Vertical at 3 m								
Frequency (MHz)	Emission Level (dBuV/m)	Read Level (dBuV)	Factor (dB/m)	Limit (dBuV/m)	Margin (dB)	Antenna Height (cm)	Table Angle (Degree)	Remark
2467	94.38	89.75	4.63			148	262	Average
2467	102.43	97.8	4.63			148	262	Peak
2483.52	48.49	43.83	4.66	54	-5.51	148	262	Average
2483.52	60.42	55.76	4.66	74	-13.58	148	262	Peak
4934	41.7	31.44	10.26	54	-12.3	149	65	Average
4934	48.07	37.81	10.26	74	-25.93	149	65	Peak

Remarks:

- Emission Level = Read Level + Factor
Margin value = Emission level – Limit value
- 2467 MHz: Fundamental frequency.
- The emission levels of other frequencies were very low against the limit.

EUT Test Condition		Measurement Detail	
Channel	Channel 13	Frequency Range	1 GHz ~ 25 GHz
Input Power	120 Vac, 60 Hz	Detector Function	Peak (PK) Average (AV)
Environmental Conditions	25 deg. C, 65 % RH	Tested By	Karl Lee

Antenna Polarity & Test Distance: Horizontal at 3 m								
Frequency (MHz)	Emission Level (dBuV/m)	Read Level (dBuV)	Factor (dB/m)	Limit (dBuV/m)	Margin (dB)	Antenna Height (cm)	Table Angle (Degree)	Remark
2472	77.65	73.01	4.64			118	240	Average
2472	84.86	80.22	4.64			118	240	Peak
2483.52	52.94	48.28	4.66	54	-1.06	118	240	Average
2483.52	63.97	59.31	4.66	74	-10.03	118	240	Peak
4944	41.74	31.39	10.35	54	-12.26	155	165	Average
4944	48.16	37.81	10.35	74	-25.84	155	165	Peak
Antenna Polarity & Test Distance: Vertical at 3 m								
Frequency (MHz)	Emission Level (dBuV/m)	Read Level (dBuV)	Factor (dB/m)	Limit (dBuV/m)	Margin (dB)	Antenna Height (cm)	Table Angle (Degree)	Remark
2472	74.77	70.13	4.64			148	262	Average
2472	83.15	78.51	4.64			148	262	Peak
2483.52	49.71	45.05	4.66	54	-4.29	148	262	Average
2483.52	60.75	56.09	4.66	74	-13.25	148	262	Peak
4944	41.8	31.45	10.35	54	-12.2	171	44	Average
4944	47.65	37.3	10.35	74	-26.35	171	44	Peak

Remarks:

- Emission Level = Read Level + Factor
Margin value = Emission level – Limit value
- 2472 MHz: Fundamental frequency.
- The emission levels of other frequencies were very low against the limit.

802.11n (HT20)

EUT Test Condition		Measurement Detail	
Channel	Channel 1	Frequency Range	1 GHz ~ 25 GHz
Input Power	120 Vac, 60 Hz	Detector Function	Peak (PK) Average (AV)
Environmental Conditions	25 deg. C, 65 % RH	Tested By	Charles Hsiao

Antenna Polarity & Test Distance: Horizontal at 3 m								
Frequency (MHz)	Emission Level (dBuV/m)	Read Level (dBuV)	Factor (dB/m)	Limit (dBuV/m)	Margin (dB)	Antenna Height (cm)	Table Angle (Degree)	Remark
2389.92	52.59	48.09	4.5	54	-1.41	100	240	Average
2389.92	65.79	61.29	4.5	74	-8.21	100	240	Peak
2412	100.27	95.72	4.55			101	240	Average
2412	107.61	103.06	4.55			101	240	Peak
4824	41.65	31.36	10.29	54	-12.35	197	114	Average
4824	47.91	37.62	10.29	74	-26.09	197	114	Peak
Antenna Polarity & Test Distance: Vertical at 3 m								
Frequency (MHz)	Emission Level (dBuV/m)	Read Level (dBuV)	Factor (dB/m)	Limit (dBuV/m)	Margin (dB)	Antenna Height (cm)	Table Angle (Degree)	Remark
2389.92	51.98	47.48	4.5	54	-2.02	150	98	Average
2389.92	63.9	59.4	4.5	74	-10.1	150	98	Peak
2412	98.55	94	4.55			150	98	Average
2412	105.82	101.27	4.55			150	98	Peak
4824	41.57	31.28	10.29	54	-12.43	164	25	Average
4824	47.56	37.27	10.29	74	-26.44	164	25	Peak

Remarks:

- Emission Level = Read Level + Factor
Margin value = Emission level – Limit value
- 2412 MHz: Fundamental frequency.
- The emission levels of other frequencies were very low against the limit.

EUT Test Condition		Measurement Detail	
Channel	Channel 6	Frequency Range	1 GHz ~ 25 GHz
Input Power	120 Vac, 60 Hz	Detector Function	Peak (PK) Average (AV)
Environmental Conditions	25 deg. C, 65 % RH	Tested By	Charles Hsiao

Antenna Polarity & Test Distance: Horizontal at 3 m								
Frequency (MHz)	Emission Level (dBuV/m)	Read Level (dBuV)	Factor (dB/m)	Limit (dBuV/m)	Margin (dB)	Antenna Height (cm)	Table Angle (Degree)	Remark
2389.38	47.88	43.39	4.49	54	-6.12	100	240	Average
2389.38	61.41	56.92	4.49	74	-12.59	100	240	Peak
2437	104.28	99.69	4.59			101	239	Average
2437	111.6	107.01	4.59			101	239	Peak
2483.6	52.33	47.67	4.66	54	-1.67	100	240	Average
2483.6	65.9	61.24	4.66	74	-8.1	100	240	Peak
4874	41.57	31.36	10.21	54	-12.43	166	15	Average
4874	47.86	37.65	10.21	74	-26.14	166	15	Peak

Antenna Polarity & Test Distance: Vertical at 3 m								
Frequency (MHz)	Emission Level (dBuV/m)	Read Level (dBuV)	Factor (dB/m)	Limit (dBuV/m)	Margin (dB)	Antenna Height (cm)	Table Angle (Degree)	Remark
2389.83	46.49	41.99	4.5	54	-7.51	150	98	Average
2389.83	58.67	54.17	4.5	74	-15.33	150	98	Peak
2437	102.56	97.97	4.59			150	98	Average
2437	109.1	104.51	4.59			150	98	Peak
2483.64	47.73	43.07	4.66	54	-6.27	150	98	Average
2483.64	59.27	54.61	4.66	74	-14.73	150	98	Peak
4874	41.58	31.37	10.21	54	-12.42	189	197	Average
4874	48.19	37.98	10.21	74	-25.81	189	197	Peak

Remarks:

- Emission Level = Read Level + Factor
Margin value = Emission level – Limit value
- 2437 MHz: Fundamental frequency.
- The emission levels of other frequencies were very low against the limit.

EUT Test Condition		Measurement Detail	
Channel	Channel 11	Frequency Range	1 GHz ~ 25 GHz
Input Power	120 Vac, 60 Hz	Detector Function	Peak (PK) Average (AV)
Environmental Conditions	25 deg. C, 65 % RH	Tested By	Charles Hsiao

Antenna Polarity & Test Distance: Horizontal at 3 m								
Frequency (MHz)	Emission Level (dBuV/m)	Read Level (dBuV)	Factor (dB/m)	Limit (dBuV/m)	Margin (dB)	Antenna Height (cm)	Table Angle (Degree)	Remark
2462	99.95	95.33	4.62			100	240	Average
2462	106.25	101.63	4.62			100	240	Peak
2483.6	51.46	46.8	4.66	54	-2.54	100	240	Average
2483.6	64.29	59.63	4.66	74	-9.71	100	240	Peak
4924	41.71	31.46	10.25	54	-12.29	185	111	Average
4924	48.26	38.01	10.25	74	-25.74	185	111	Peak
Antenna Polarity & Test Distance: Vertical at 3 m								
Frequency (MHz)	Emission Level (dBuV/m)	Read Level (dBuV)	Factor (dB/m)	Limit (dBuV/m)	Margin (dB)	Antenna Height (cm)	Table Angle (Degree)	Remark
2462	97.41	92.79	4.62			150	98	Average
2462	104.07	99.45	4.62			150	98	Peak
2483.56	46.85	42.19	4.66	54	-7.15	150	98	Average
2483.56	61.06	56.4	4.66	74	-12.94	150	98	Peak
4924	41.62	31.37	10.25	54	-12.38	154	19	Average
4924	47.45	37.2	10.25	74	-26.55	154	19	Peak

Remarks:

- Emission Level = Read Level + Factor
Margin value = Emission level – Limit value
- 2462 MHz: Fundamental frequency.
- The emission levels of other frequencies were very low against the limit.

EUT Test Condition		Measurement Detail	
Channel	Channel 12	Frequency Range	1 GHz ~ 25 GHz
Input Power	120 Vac, 60 Hz	Detector Function	Peak (PK) Average (AV)
Environmental Conditions	25 deg. C, 65 % RH	Tested By	Charles Hsiao

Antenna Polarity & Test Distance: Horizontal at 3 m								
Frequency (MHz)	Emission Level (dBuV/m)	Read Level (dBuV)	Factor (dB/m)	Limit (dBuV/m)	Margin (dB)	Antenna Height (cm)	Table Angle (Degree)	Remark
2467	98.56	93.93	4.63			102	238	Average
2467	105.39	100.76	4.63			102	238	Peak
2483.52	51.07	46.41	4.66	54	-2.93	100	240	Average
2483.52	61.02	56.36	4.66	74	-12.98	100	240	Peak
4934	41.53	31.27	10.26	54	-12.47	154	4	Average
4934	47.74	37.48	10.26	74	-26.26	154	4	Peak
Antenna Polarity & Test Distance: Vertical at 3 m								
Frequency (MHz)	Emission Level (dBuV/m)	Read Level (dBuV)	Factor (dB/m)	Limit (dBuV/m)	Margin (dB)	Antenna Height (cm)	Table Angle (Degree)	Remark
2467	96.17	91.54	4.63			150	98	Average
2467	103.57	98.94	4.63			150	98	Peak
2483.52	46.42	41.76	4.66	54	-7.58	150	98	Average
2483.52	57.13	52.47	4.66	74	-16.87	150	98	Peak
4934	41.54	31.28	10.26	54	-12.46	135	319	Average
4934	47.92	37.66	10.26	74	-26.08	135	319	Peak

Remarks:

- Emission Level = Read Level + Factor
Margin value = Emission level – Limit value
- 2467 MHz: Fundamental frequency.
- The emission levels of other frequencies were very low against the limit.

EUT Test Condition		Measurement Detail	
Channel	Channel 13	Frequency Range	1 GHz ~ 25 GHz
Input Power	120 Vac, 60 Hz	Detector Function	Peak (PK) Average (AV)
Environmental Conditions	25 deg. C, 65 % RH	Tested By	Charles Hsiao

Antenna Polarity & Test Distance: Horizontal at 3 m								
Frequency (MHz)	Emission Level (dBuV/m)	Read Level (dBuV)	Factor (dB/m)	Limit (dBuV/m)	Margin (dB)	Antenna Height (cm)	Table Angle (Degree)	Remark
2472	80.53	75.89	4.64			101	240	Average
2472	87.34	82.7	4.64			101	240	Peak
2483.56	52.71	48.05	4.66	54	-1.29	100	240	Average
2483.56	64.32	59.66	4.66	74	-9.68	100	240	Peak
4944	41.75	31.4	10.35	54	-12.25	195	26	Average
4944	47.54	37.19	10.35	74	-26.46	195	26	Peak
Antenna Polarity & Test Distance: Vertical at 3 m								
Frequency (MHz)	Emission Level (dBuV/m)	Read Level (dBuV)	Factor (dB/m)	Limit (dBuV/m)	Margin (dB)	Antenna Height (cm)	Table Angle (Degree)	Remark
2472	78.46	73.82	4.64			150	98	Average
2472	85.92	81.28	4.64			150	98	Peak
2483.52	49.73	45.07	4.66	54	-4.27	150	98	Average
2483.52	62.57	57.91	4.66	74	-11.43	150	98	Peak
4944	41.61	31.26	10.35	54	-12.39	132	225	Average
4944	47.47	37.12	10.35	74	-26.53	132	225	Peak

Remarks:

- Emission Level = Read Level + Factor
Margin value = Emission level – Limit value
- 2472 MHz: Fundamental frequency.
- The emission levels of other frequencies were very low against the limit.

802.11n (HT40)

EUT Test Condition		Measurement Detail	
Channel	Channel 3	Frequency Range	1 GHz ~ 25 GHz
Input Power	120 Vac, 60 Hz	Detector Function	Peak (PK) Average (AV)
Environmental Conditions	25 deg. C, 65 % RH	Tested By	Harry Hsueh

Antenna Polarity & Test Distance: Horizontal at 3 m

Frequency (MHz)	Emission Level (dBuV/m)	Read Level (dBuV)	Factor (dB/m)	Limit (dBuV/m)	Margin (dB)	Antenna Height (cm)	Table Angle (Degree)	Remark
2389.74	52.3	47.81	4.49	54	-1.7	117	240	Average
2389.74	63.48	58.99	4.49	74	-10.52	117	240	Peak
2422	95.59	91.03	4.56			117	240	Average
2422	103.73	99.17	4.56			117	240	Peak
2484.04	43.95	39.29	4.66	54	-10.05	117	240	Average
2484.04	53.54	48.88	4.66	74	-20.46	117	240	Peak
4844	41.35	31.12	10.23	54	-12.65	128	195	Average
4844	48.47	38.24	10.23	74	-25.53	128	195	Peak

Antenna Polarity & Test Distance: Vertical at 3 m

Frequency (MHz)	Emission Level (dBuV/m)	Read Level (dBuV)	Factor (dB/m)	Limit (dBuV/m)	Margin (dB)	Antenna Height (cm)	Table Angle (Degree)	Remark
2389.38	50.58	46.09	4.49	54	-3.42	256	262	Average
2389.38	61.34	56.85	4.49	74	-12.66	256	262	Peak
2422	94.45	89.89	4.56			256	262	Average
2422	102.21	97.65	4.56			256	262	Peak
2484.52	42.52	37.86	4.66	54	-11.48	256	262	Average
2484.52	53.53	48.87	4.66	74	-20.47	256	262	Peak
4844	41.46	31.23	10.23	54	-12.54	169	197	Average
4844	46.72	36.49	10.23	74	-27.28	169	197	Peak

Remarks:

- Emission Level = Read Level + Factor
Margin value = Emission level – Limit value
- 2422 MHz: Fundamental frequency.
- The emission levels of other frequencies were very low against the limit.

EUT Test Condition		Measurement Detail	
Channel	Channel 6	Frequency Range	1 GHz ~ 25 GHz
Input Power	120 Vac, 60 Hz	Detector Function	Peak (PK) Average (AV)
Environmental Conditions	25 deg. C, 65 % RH	Tested By	Harry Hsueh

Antenna Polarity & Test Distance: Horizontal at 3 m								
Frequency (MHz)	Emission Level (dBuV/m)	Read Level (dBuV)	Factor (dB/m)	Limit (dBuV/m)	Margin (dB)	Antenna Height (cm)	Table Angle (Degree)	Remark
2389.65	52.46	47.97	4.49	54	-1.54	101	240	Average
2389.65	64.35	59.86	4.49	74	-9.65	101	240	Peak
2437	96.62	92.03	4.59			101	240	Average
2437	104.59	100	4.59			101	240	Peak
2483.88	52.72	48.06	4.66	54	-1.28	101	240	Average
2483.88	63.08	58.42	4.66	74	-10.92	101	240	Peak
4874	42.42	32.21	10.21	54	-11.58	123	141	Average
4874	47.58	37.37	10.21	74	-26.42	123	141	Peak

Antenna Polarity & Test Distance: Vertical at 3 m								
Frequency (MHz)	Emission Level (dBuV/m)	Read Level (dBuV)	Factor (dB/m)	Limit (dBuV/m)	Margin (dB)	Antenna Height (cm)	Table Angle (Degree)	Remark
2389.2	50.98	46.49	4.49	54	-3.02	150	98	Average
2389.2	62.21	57.72	4.49	74	-11.79	150	98	Peak
2437	95.62	91.03	4.59			150	98	Average
2437	103.8	99.21	4.59			150	98	Peak
2483.6	50.98	46.32	4.66	54	-3.02	150	98	Average
2483.6	60.92	56.26	4.66	74	-13.08	150	98	Peak
4874	41.79	31.58	10.21	54	-12.21	169	157	Average
4874	47.94	37.73	10.21	74	-26.06	169	157	Peak

Remarks:

- Emission Level = Read Level + Factor
Margin value = Emission level – Limit value
- 2437 MHz: Fundamental frequency.
- The emission levels of other frequencies were very low against the limit.

EUT Test Condition		Measurement Detail	
Channel	Channel 9	Frequency Range	1 GHz ~ 25 GHz
Input Power	120 Vac, 60 Hz	Detector Function	Peak (PK) Average (AV)
Environmental Conditions	25 deg. C, 65 % RH	Tested By	Harry Hsueh

Antenna Polarity & Test Distance: Horizontal at 3 m								
Frequency (MHz)	Emission Level (dBuV/m)	Read Level (dBuV)	Factor (dB/m)	Limit (dBuV/m)	Margin (dB)	Antenna Height (cm)	Table Angle (Degree)	Remark
2385.33	42.37	37.9	4.47	54	-11.63	102	240	Average
2385.33	53.22	48.75	4.47	74	-20.78	102	240	Peak
2452	94.63	90.03	4.6			102	240	Average
2452	102.88	98.28	4.6			102	240	Peak
2487.96	52.21	47.53	4.68	54	-1.79	102	240	Average
2487.96	65.85	61.17	4.68	74	-8.15	102	240	Peak
4904	41.38	31.24	10.14	54	-12.62	141	102	Average
4904	47.4	37.26	10.14	74	-26.6	141	102	Peak

Antenna Polarity & Test Distance: Vertical at 3 m								
Frequency (MHz)	Emission Level (dBuV/m)	Read Level (dBuV)	Factor (dB/m)	Limit (dBuV/m)	Margin (dB)	Antenna Height (cm)	Table Angle (Degree)	Remark
2389.47	42.15	37.66	4.49	54	-11.85	150	98	Average
2389.47	52.67	48.18	4.49	74	-21.33	150	98	Peak
2452	93.63	89.03	4.6			150	98	Average
2452	101.82	97.22	4.6			150	98	Peak
2483.72	47.79	43.13	4.66	54	-6.21	150	98	Average
2483.72	61.76	57.1	4.66	74	-12.24	150	98	Peak
4904	41.2	31.06	10.14	54	-12.8	167	184	Average
4904	47.35	37.21	10.14	74	-26.65	167	184	Peak

Remarks:

- Emission Level = Read Level + Factor
Margin value = Emission level – Limit value
- 2452 MHz: Fundamental frequency.
- The emission levels of other frequencies were very low against the limit.

EUT Test Condition		Measurement Detail	
Channel	Channel 10	Frequency Range	1 GHz ~ 25 GHz
Input Power	120 Vac, 60 Hz	Detector Function	Peak (PK) Average (AV)
Environmental Conditions	25 deg. C, 65 % RH	Tested By	Harry Hsueh

Antenna Polarity & Test Distance: Horizontal at 3 m								
Frequency (MHz)	Emission Level (dBuV/m)	Read Level (dBuV)	Factor (dB/m)	Limit (dBuV/m)	Margin (dB)	Antenna Height (cm)	Table Angle (Degree)	Remark
2384.88	41.93	37.46	4.47	54	-12.07	102	241	Average
2384.88	52.71	48.24	4.47	74	-21.29	102	241	Peak
2457	89.32	84.7	4.62			102	241	Average
2457	97.91	93.29	4.62			102	241	Peak
2486.36	52.75	48.09	4.66	54	-1.25	102	241	Average
2486.36	64.6	59.94	4.66	74	-9.4	102	241	Peak
4914	41.41	31.26	10.15	54	-12.59	157	184	Average
4914	47.01	36.86	10.15	74	-26.99	157	184	Peak

Antenna Polarity & Test Distance: Vertical at 3 m								
Frequency (MHz)	Emission Level (dBuV/m)	Read Level (dBuV)	Factor (dB/m)	Limit (dBuV/m)	Margin (dB)	Antenna Height (cm)	Table Angle (Degree)	Remark
2388.12	41.33	36.84	4.49	54	-12.67	150	98	Average
2388.12	53.14	48.65	4.49	74	-20.86	150	98	Peak
2457	88.34	83.72	4.62			150	98	Average
2457	96.83	92.21	4.62			150	98	Peak
2483.6	47.85	43.19	4.66	54	-6.15	150	98	Average
2483.6	62.7	58.04	4.66	74	-11.3	150	98	Peak
4914	41.36	31.21	10.15	54	-12.64	136	214	Average
4914	47.57	37.42	10.15	74	-26.43	136	214	Peak

Remarks:

- Emission Level = Read Level + Factor
Margin value = Emission level – Limit value
- 2457 MHz: Fundamental frequency.
- The emission levels of other frequencies were very low against the limit.

EUT Test Condition		Measurement Detail	
Channel	Channel 11	Frequency Range	1 GHz ~ 25 GHz
Input Power	120 Vac, 60 Hz	Detector Function	Peak (PK) Average (AV)
Environmental Conditions	25 deg. C, 65 % RH	Tested By	Harry Hsueh

Antenna Polarity & Test Distance: Horizontal at 3 m								
Frequency (MHz)	Emission Level (dBuV/m)	Read Level (dBuV)	Factor (dB/m)	Limit (dBuV/m)	Margin (dB)	Antenna Height (cm)	Table Angle (Degree)	Remark
2385.42	40.71	36.24	4.47	54	-13.29	118	240	Average
2385.42	51.95	47.48	4.47	74	-22.05	118	240	Peak
2462	83.65	79.03	4.62			118	240	Average
2462	91.7	87.08	4.62			118	240	Peak
2483.52	52.72	48.06	4.66	54	-1.28	118	240	Average
2483.52	65.22	60.56	4.66	74	-8.78	118	240	Peak
4924	41.48	31.23	10.25	54	-12.52	165	157	Average
4924	46.61	36.36	10.25	74	-27.39	165	157	Peak

Antenna Polarity & Test Distance: Vertical at 3 m								
Frequency (MHz)	Emission Level (dBuV/m)	Read Level (dBuV)	Factor (dB/m)	Limit (dBuV/m)	Margin (dB)	Antenna Height (cm)	Table Angle (Degree)	Remark
2370.03	40.55	36.1	4.45	54	-13.45	150	98	Average
2370.03	51.4	46.95	4.45	74	-22.6	150	98	Peak
2462	82.65	78.03	4.62			150	98	Average
2462	90.67	86.05	4.62			150	98	Peak
2483.6	48.4	43.74	4.66	54	-5.6	150	98	Average
2483.6	61.81	57.15	4.66	74	-12.19	150	98	Peak
4924	41.46	31.21	10.25	54	-12.54	157	195	Average
4924	47.23	36.98	10.25	74	-26.77	157	195	Peak

Remarks:

- Emission Level = Read Level + Factor
Margin value = Emission level – Limit value
- 2462 MHz: Fundamental frequency.
- The emission levels of other frequencies were very low against the limit.

9 kHz ~ 30 MHz Data:

The amplitude of spurious emissions attenuated more than 20 dB below the permissible value is not required to be report.

30 MHz ~ 1 GHz Worst-Case Data:

802.11b

EUT Test Condition		Measurement Detail	
Channel	Channel 1	Frequency Range	30 MHz ~ 1 GHz
Input Power	120 Vac, 60 Hz	Detector Function	Peak (PK) Quasi-peak (QP)
Environmental Conditions	25 deg. C, 65 % RH	Tested By	Karl Lee

Horizontal

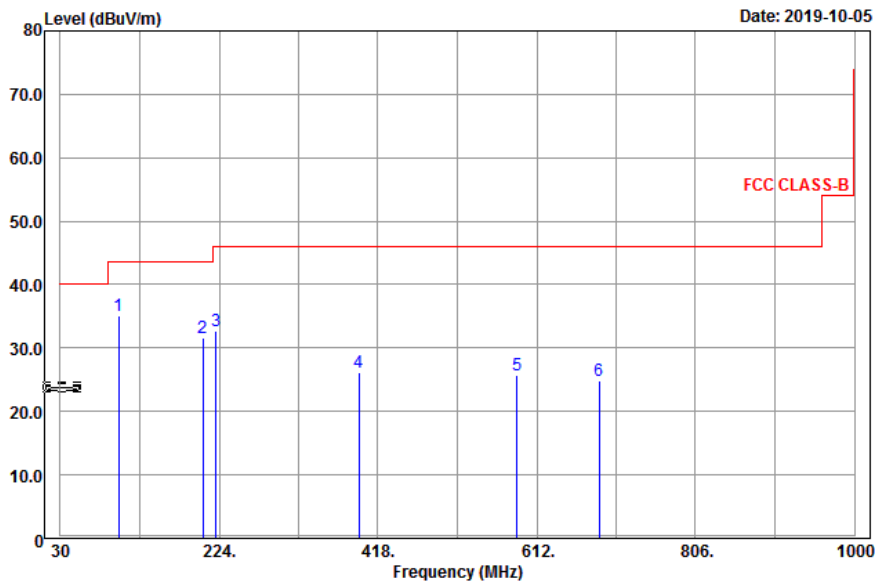

Vertical

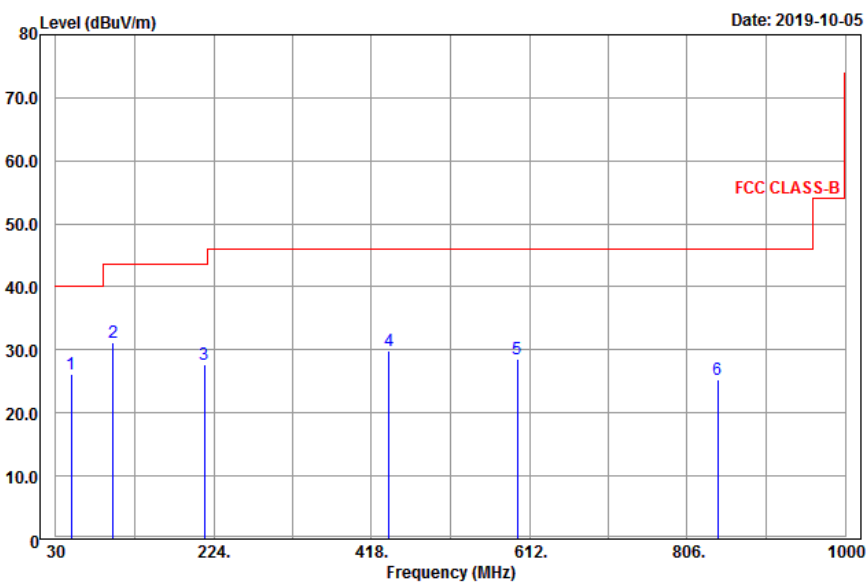

Antenna Polarity & Test Distance: Horizontal at 3 m

Frequency (MHz)	Emission Level (dBuV/m)	Read Level (dBuV)	Factor (dB/m)	Limit (dBuV/m)	Margin (dB)	Antenna Height (cm)	Table Angle (Degree)	Remark
101.55	35.08	52.24	-17.16	43.5	-8.42	197	99	Peak
203.88	31.66	49.85	-18.19	43.5	-11.84	124	205	Peak
220.35	32.75	50.6	-17.85	46	-13.25	135	335	Peak
395.2	26.13	40.17	-14.04	46	-19.87	195	326	Peak
587.7	25.73	36.63	-10.9	46	-20.27	175	174	Peak
688.5	24.89	34.22	-9.33	46	-21.11	188	58	Peak

Antenna Polarity & Test Distance: Vertical at 3 m

Frequency (MHz)	Emission Level (dBuV/m)	Read Level (dBuV)	Factor (dB/m)	Limit (dBuV/m)	Margin (dB)	Antenna Height (cm)	Table Angle (Degree)	Remark
49.17	26.08	41.23	-15.15	40	-13.92	149	117	Peak
100.2	31.21	48.41	-17.2	43.5	-12.29	100	104	Peak
212.79	27.73	45.8	-18.07	43.5	-15.77	121	228	Peak
439.3	29.94	43.36	-13.42	46	-16.06	163	333	Peak
597.5	28.61	39.24	-10.63	46	-17.39	159	278	Peak
843.9	25.28	32.18	-6.9	46	-20.72	105	224	Peak

Remarks:

- Emission Level = Read Level + Factor
Margin value = Emission level – Limit value.
- The emission levels of other frequencies were very low against the limit.

4.2 Conducted Emission Measurement

4.2.1 Limits of Conducted Emission Measurement

Frequency (MHz)	Conducted Limit (dBuV)	
	Quasi-Peak	Average
0.15 - 0.5	66 - 56	56 - 46
0.50 - 5.0	56	46
5.0 - 30.0	60	50

- Note: 1. The lower limit shall apply at the transition frequencies.
 2. The limit decreases in line with the logarithm of the frequency in the range of 0.15 to 0.50 MHz.

4.2.2 Test Instruments

Description & Manufacturer	Model No.	Serial No.	Date of Calibration	Due Date of Calibration
Test Receiver ROHDE & SCHWARZ	ESR3	102412	Feb. 14, 2019	Feb. 13, 2020
RF signal cable Woken	5D-FB	Cable-cond2-01	Sep. 05, 2019	Sep. 04, 2020
LISN/AMN ROHDE & SCHWARZ (EUT)	ESH2-Z5	100100	Jan. 30, 2019	Jan. 29, 2020
LISN/AMN ROHDE & SCHWARZ (Peripheral)	ESH3-Z5	100312	Aug. 13, 2019	Aug. 12, 2020
Software ADT	BV ADT_Cond_ V7.3.7.4	NA	NA	NA

- Note: 1. The calibration interval of the above test instruments is 12 months and the calibrations are traceable to NML/ROC and NIST/USA.
 2. The test was performed in HwaYa Shielded Room 2.
 3. The VCCI Site Registration No. is C-12047.

4.2.3 Test Procedures

- a. The EUT was placed 0.4 meters from the conducting wall of the shielded room with EUT being connected to the power mains through a line impedance stabilization network (LISN). Other support units were connected to the power mains through another LISN. The two LISNs provide 50 ohm/50 uH of coupling impedance for the measuring instrument.
- b. Both lines of the power mains connected to the EUT were checked for maximum conducted interference.
- c. The frequency range from 150 kHz to 30 MHz was searched. Emission levels under (Limit – 20 dB) was not recorded.

Note: The resolution bandwidth and video bandwidth of test receiver is 9 kHz for quasi-peak detection (QP) and average detection (AV) at frequency 0.15 MHz – 30 MHz.

4.2.4 Deviation from Test Standard

No deviation.

4.2.5 Test Setup

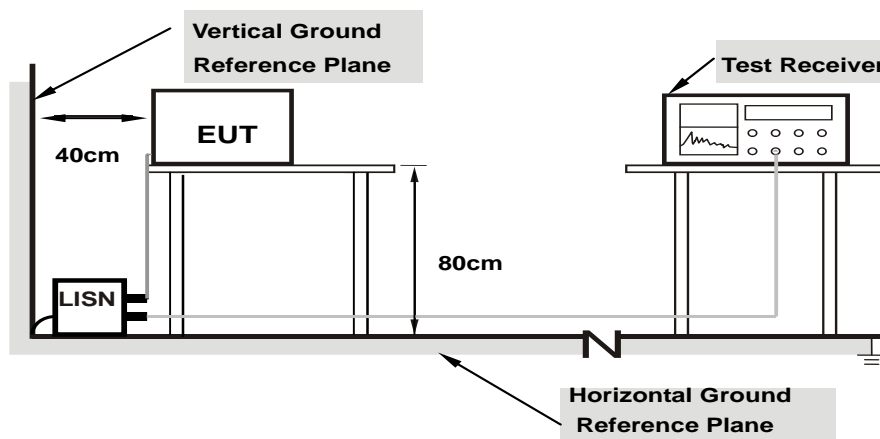

Note: 1.Support units were connected to second LISN.

For the actual test configuration, please refer to the attached file (Test Setup Photo).

4.2.6 EUT Operating Conditions

- a. Placed the EUT on a testing table.
- b. Use the software to control the EUT under transmission condition continuously at specific channel frequency.

4.2.7 Test Results

Frequency Range	150kHz ~ 30MHz	Detector Function & Resolution Bandwidth	Quasi-Peak (QP) / Average (AV), 9kHz
Input Power	120Vac, 60Hz	Environmental Conditions	22°C, 66%RH
Tested by	Getaz Yang	Test Date	2019/10/8

Phase Of Power : Line (L)										
No	Frequency (MHz)	Correction Factor (dB)	Reading Value (dBuV)		Emission Level (dBuV)		Limit (dBuV)		Margin (dB)	
			Q.P.	AV.	Q.P.	AV.	Q.P.	AV.	Q.P.	AV.
1	0.15450	10.11	37.49	21.78	47.60	31.89	65.75	55.75	-18.15	-23.86
2	0.25816	10.13	20.05	7.91	30.18	18.04	61.49	51.49	-31.31	-33.45
3	0.57525	10.18	22.42	9.44	32.60	19.62	56.00	46.00	-23.40	-26.38
4	3.00750	10.31	19.03	7.70	29.34	18.01	56.00	46.00	-26.66	-27.99
5	7.33425	10.39	25.09	11.54	35.48	21.93	60.00	50.00	-24.52	-28.07
6	11.53050	10.46	24.11	11.02	34.57	21.48	60.00	50.00	-25.43	-28.52

Remarks:

1. Q.P. and AV. are abbreviations of quasi-peak and average individually.
2. The emission levels of other frequencies were very low against the limit.
3. Margin value = Emission level – Limit value
4. Correction factor = Insertion loss + Cable loss
5. Emission Level = Correction Factor + Reading Value

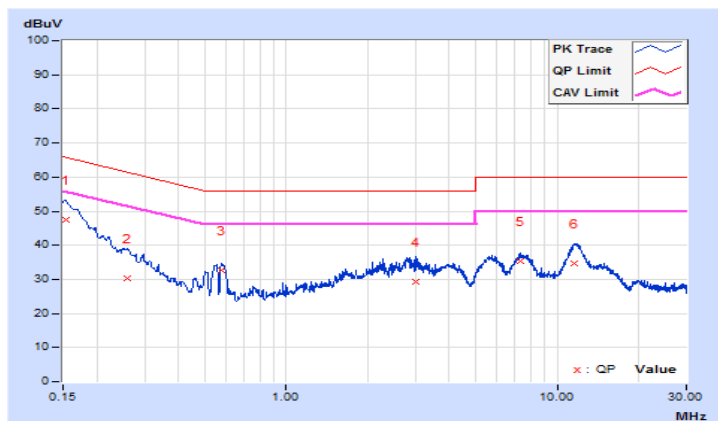

Frequency Range	150kHz ~ 30MHz	Detector Function & Resolution Bandwidth	Quasi-Peak (QP) / Average (AV), 9kHz
Input Power	120Vac, 60Hz	Environmental Conditions	22°C, 66%RH
Tested by	Getaz Yang	Test Date	2019/10/8

Phase Of Power : Neutral (N)										
No	Frequency (MHz)	Correction Factor (dB)	Reading Value (dBuV)		Emission Level (dBuV)		Limit (dBuV)		Margin (dB)	
			Q.P.	AV.	Q.P.	AV.	Q.P.	AV.	Q.P.	AV.
1	0.15675	10.16	35.12	16.36	45.28	26.52	65.63	55.63	-20.35	-29.11
2	0.20791	10.18	25.94	10.33	36.12	20.51	63.29	53.29	-27.17	-32.78
3	0.55950	10.24	22.03	10.73	32.27	20.97	56.00	46.00	-23.73	-25.03
4	2.15688	10.33	20.84	9.38	31.17	19.71	56.00	46.00	-24.83	-26.29
5	5.21475	10.45	21.66	8.59	32.11	19.04	60.00	50.00	-27.89	-30.96
6	11.34600	10.58	20.16	9.06	30.74	19.64	60.00	50.00	-29.26	-30.36

Remarks:

1. Q.P. and AV. are abbreviations of quasi-peak and average individually.
2. The emission levels of other frequencies were very low against the limit.
3. Margin value = Emission level – Limit value
4. Correction factor = Insertion loss + Cable loss
5. Emission Level = Correction Factor + Reading Value

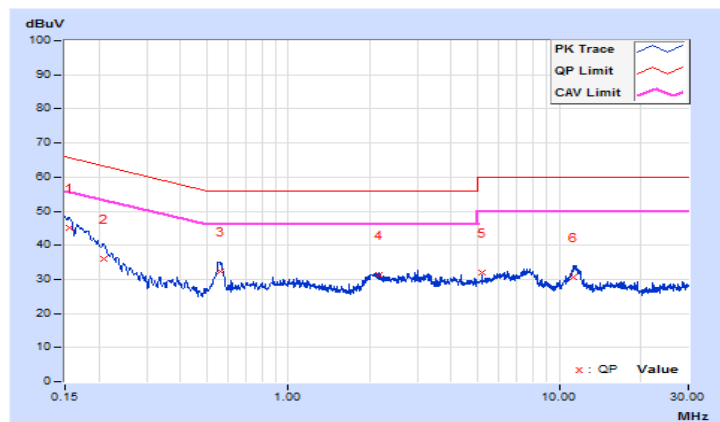

4.3 6 dB Bandwidth Measurement

4.3.1 Limits of 6 dB Bandwidth Measurement

The minimum of 6 dB Bandwidth Measurement is 0.5 MHz.

4.3.2 Test Setup

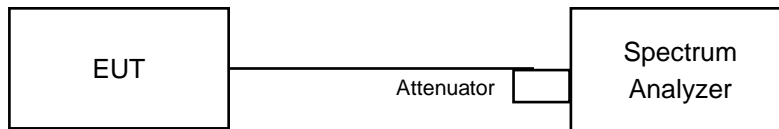

4.3.3 Test Instruments

Refer to section 4.1.2 to get information of above instrument.

4.3.4 Test Procedure

- Set resolution bandwidth (RBW) = 100 kHz
- Set the video bandwidth (VBW) $\geq 3 \times$ RBW, Detector = Peak.
- Trace mode = max hold.
- Sweep = auto couple.
- Measure the maximum width of the emission that is constrained by the frequencies associated with the two amplitude points (upper and lower) that are attenuated by 6 dB relative to the maximum level measured in the fundamental emission

4.3.5 Deviation from Test Standard

No deviation.

4.3.6 EUT Operating Conditions

The software provided by client to enable the EUT under transmission condition continuously at lowest, middle and highest channel frequencies individually.

4.3.7 Test Results

802.11b

Channel	Frequency (MHz)	6 dB Bandwidth (MHz)	Minimum Limit (MHz)	Pass / Fail
1	2412	10.09	0.5	Pass
6	2437	9.56	0.5	Pass
11	2462	10.10	0.5	Pass
12	2467	10.09	0.5	Pass
13	2472	9.59	0.5	Pass

802.11g

Channel	Frequency (MHz)	6 dB Bandwidth (MHz)	Minimum Limit (MHz)	Pass / Fail
1	2412	16.38	0.5	Pass
6	2437	16.36	0.5	Pass
11	2462	16.39	0.5	Pass
12	2467	16.37	0.5	Pass
13	2472	16.39	0.5	Pass

802.11n (HT20)

Channel	Frequency (MHz)	6 dB Bandwidth (MHz)		Minimum Limit (MHz)	Pass / Fail
		Chain 0	Chain 1		
1	2412	17.61	17.63	0.5	Pass
6	2437	17.63	17.64	0.5	Pass
11	2462	17.63	17.65	0.5	Pass
12	2467	17.62	17.63	0.5	Pass
13	2472	17.62	17.64	0.5	Pass

802.11n (HT40)

Channel	Frequency (MHz)	6 dB Bandwidth (MHz)		Minimum Limit (MHz)	Pass / Fail
		Chain 0	Chain 1		
3	2422	35.83	36.44	0.5	Pass
6	2437	36.41	36.44	0.5	Pass
9	2452	36.41	36.44	0.5	Pass
10	2457	36.42	36.43	0.5	Pass
11	2462	36.42	36.44	0.5	Pass

Spectrum Plot of Worst Value

802.11b

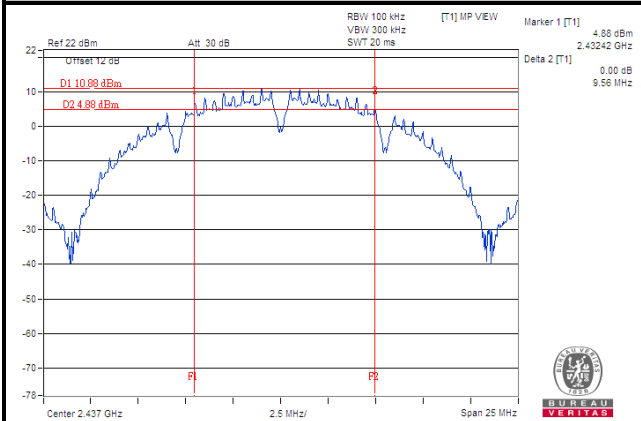

802.11g

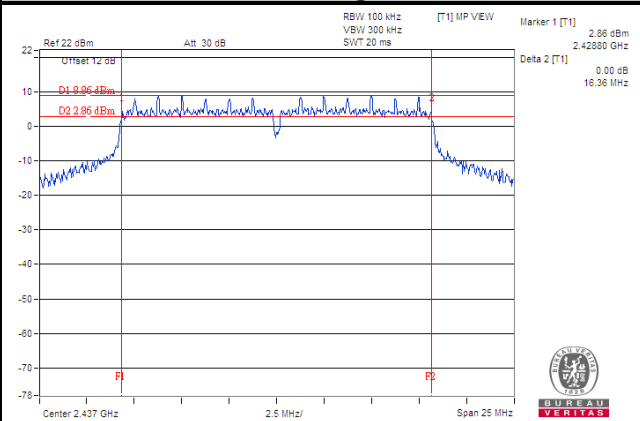

802.11n (HT20)

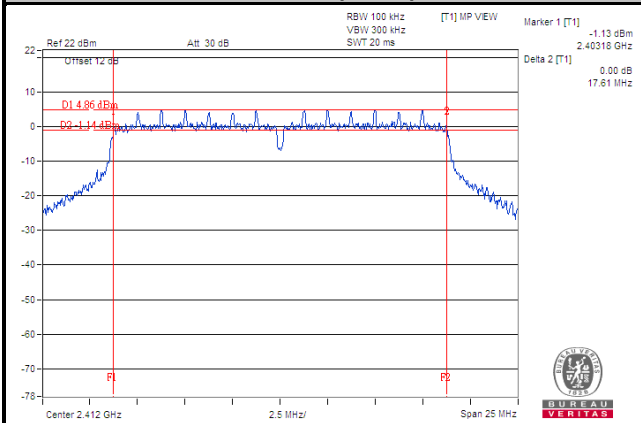

802.11n (HT40)

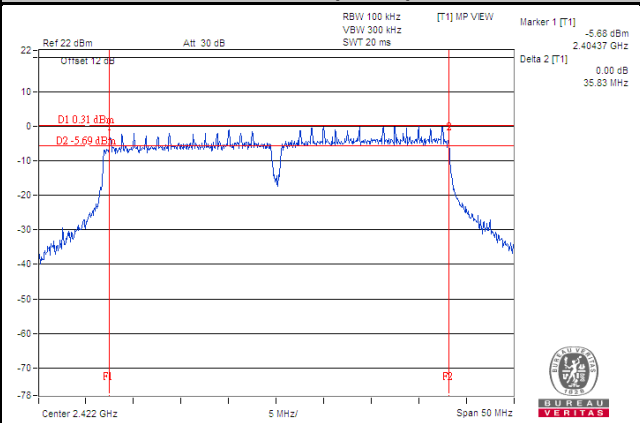

4.4 Occupied Bandwidth Measurement

4.4.1 Test Setup

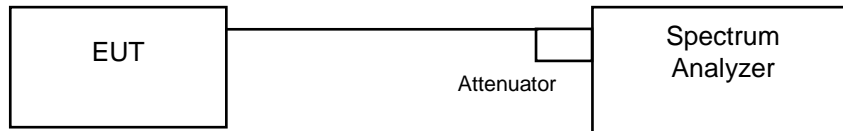

4.4.2 Test Instruments

Refer to section 4.1.2 to get information of above instrument.

4.4.3 Test Procedure

The transmitter output was connected to the spectrum analyzer through an attenuator. The bandwidth of the fundamental frequency was measured by spectrum analyzer with resolution bandwidth in the range of 1 % to 5 % of the anticipated emission bandwidth, and a video bandwidth at least 3x the resolution bandwidth and set the detector to sampling. The width of a frequency band such that, below the lower and above the upper frequency limits, the mean powers emitted are each equal to a specified percentage 0.5 % of the total mean power of a given emission.

4.4.4 Deviation from Test Standard

No deviation.

4.4.5 EUT Operating Conditions

The software provided by client to enable the EUT under transmission condition continuously at lowest, middle and highest channel frequencies individually.

4.4.6 Test Results

802.11b

Channel	Frequency (MHz)	Occupied Bandwidth (MHz)	Pass / Fail
1	2412	14.96	Pass
6	2437	15.82	Pass
11	2462	14.96	Pass
12	2467	14.87	Pass
13	2472	14.87	Pass

802.11g

Channel	Frequency (MHz)	Occupied Bandwidth (MHz)	Pass / Fail
1	2412	17.04	Pass
6	2437	19.13	Pass
11	2462	17.04	Pass
12	2467	16.95	Pass
13	2472	17.40	Pass

802.11n (HT20)

Channel	Frequency (MHz)	Occupied Bandwidth (MHz)		Pass / Fail
		Chain 0	Chain 1	
1	2412	18.17	18.08	Pass
6	2437	19.83	18.52	Pass
11	2462	18.08	17.92	Pass
12	2467	18.08	17.92	Pass
13	2472	18.44	18.17	Pass

802.11n (HT40)

Channel	Frequency (MHz)	Occupied Bandwidth (MHz)		Pass / Fail
		Chain 0	Chain 1	
3	2422	36.78	36.78	Pass
6	2437	36.78	36.70	Pass
9	2452	36.78	36.70	Pass
10	2457	36.78	36.70	Pass
11	2462	36.78	36.70	Pass

Spectrum Plot of Worst Value

802.11b

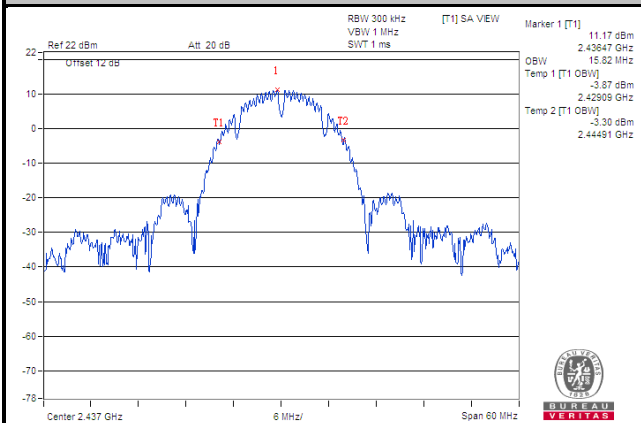

802.11g

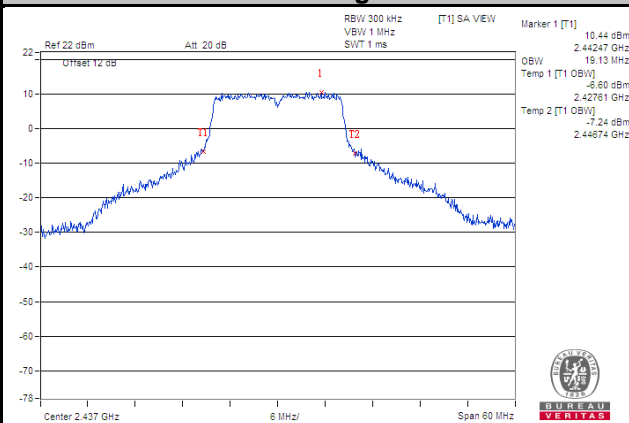

802.11n (HT20)

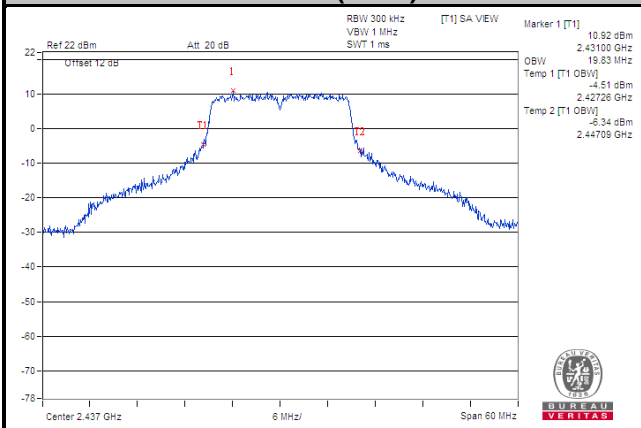

802.11n (HT40)

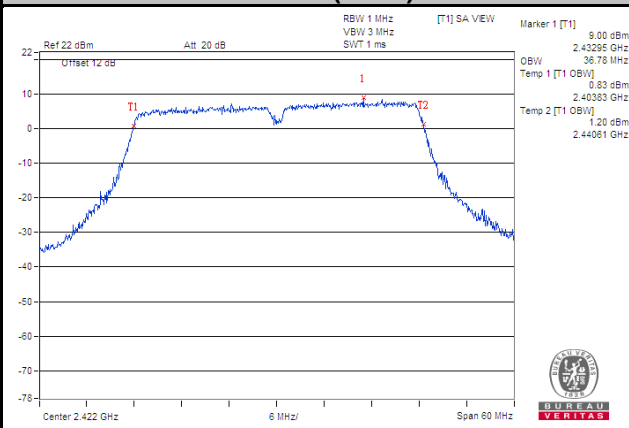

4.5 Conducted Output Power Measurement

4.5.1 Limits of Conducted Output Power Measurement

For systems using digital modulation in the 2400–2483.5 MHz bands: 1 Watt (30 dBm)

Per KDB 662911 D01 Multiple Transmitter Output Method of conducted output power measurement on IEEE 802.11 devices,

Array Gain = 0 dB (i.e., no array gain) for $NANT \leq 4$;

Array Gain = 0 dB (i.e., no array gain) for channel widths ≥ 40 MHz for any NANT;

Array Gain = $5 \log(NANT/NSS)$ dB or 3 dB, whichever is less for 20 MHz channel widths with $NANT \geq 5$.

For power measurements on all other devices: Array Gain = $10 \log(NANT/NSS)$ dB.

4.5.2 Test Setup

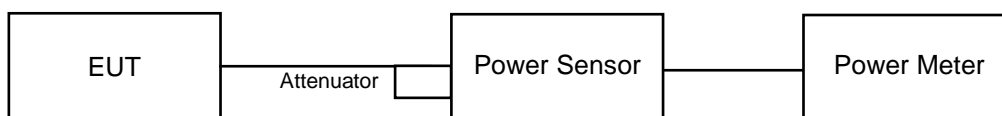

4.5.3 Test Instruments

Refer to section 4.1.2 to get information of above instrument.

4.5.4 Test Procedures

A peak power sensor was used on the output port of the EUT. A power meter was used to read the response of the peak power sensor. Record the power level.

4.5.5 Deviation from Test Standard

No deviation.

4.5.6 EUT Operating Conditions

The software provided by client to enable the EUT under transmission condition continuously at lowest, middle and highest channel frequencies individually.

4.5.7 Test Results

802.11b

Channel	Frequency (MHz)	Peak Power (mW)	Peak Power (dBm)	Limit (dBm)	Pass / Fail
1	2412	59.566	17.75	30	Pass
6	2437	129.718	21.13	30	Pass
11	2462	68.549	18.36	30	Pass
12	2467	30.903	14.90	30	Pass
13	2472	16.106	12.07	30	Pass

802.11g

Channel	Frequency (MHz)	Peak Power (mW)	Peak Power (dBm)	Limit (dBm)	Pass / Fail
1	2412	116.413	20.66	30	Pass
6	2437	169.434	22.29	30	Pass
11	2462	127.35	21.05	30	Pass
12	2467	71.45	18.54	30	Pass
13	2472	0.7379	-1.32	30	Pass

802.11n (HT20)

Channel	Frequency (MHz)	Peak Power (dBm)		Total Power (mW)	Total Power (dBm)	Limit (dBm)	Pass / Fail
		Chain 0	Chain 1				
1	2412	20.03	20.32	208.34	23.19	30	Pass
6	2437	22.25	22.63	351.111	25.45	30	Pass
11	2462	20.12	20.31	210.201	23.23	30	Pass
12	2467	17.75	17.86	120.66	20.82	30	Pass
13	2472	-0.97	-0.99	1.596	2.03	30	Pass

802.11n (HT40)

Channel	Frequency (MHz)	Peak Power (dBm)		Total Power (mW)	Total Power (dBm)	Limit (dBm)	Pass / Fail
		Chain 0	Chain 1				
3	2422	18.45	18.71	144.286	21.59	30	Pass
6	2437	20.23	20.89	228.183	23.58	30	Pass
9	2452	17.35	17.94	116.555	20.67	30	Pass
10	2457	14.89	15.35	65.109	18.14	30	Pass
11	2462	10.04	9.92	19.91	12.99	30	Pass

4.6 Power Spectral Density Measurement

4.6.1 Limits of Power Spectral Density Measurement

The Maximum of Power Spectral Density Measurement is 8 dBm in any 3 kHz band during any time interval of continuous transmission.

4.6.2 Test Setup

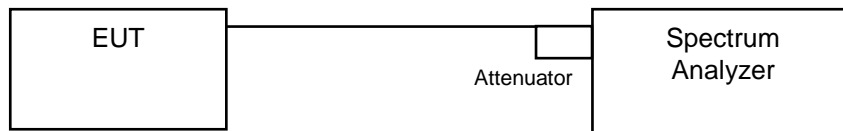

4.6.3 Test Instruments

Refer to section 4.1.2 to get information of above instrument.

4.6.4 Test Procedure

- a. Set analyzer center frequency to DTS channel center frequency.
- b. Set the span to 1.5 times the DTS bandwidth.
- c. Set the RBW to: $3 \text{ kHz} \leq \text{RBW} \leq 100 \text{ kHz}$.
- d. Set the VBW $\geq 3 \times \text{RBW}$.
- e. Detector = peak.
- f. Sweep time = auto couple.
- g. Trace mode = max hold.
- h. Allow trace to fully stabilize.
- i. Use the peak marker function to determine the maximum amplitude level within the RBW.

4.6.5 Deviation from Test Standard

No deviation.

4.6.6 EUT Operating Condition

The software provided by client to enable the EUT under transmission condition continuously at lowest, middle and highest channel frequencies individually.

4.6.7 Test Results

802.11b

Channel	Frequency (MHz)	PSD (dBm/3 kHz)	Limit (dBm/3 kHz)	Pass / Fail
1	2412	-5.97	8	Pass
6	2437	-2.32	8	Pass
11	2462	-5.36	8	Pass
12	2467	-8.90	8	Pass
13	2472	-11.71	8	Pass

802.11g

Channel	Frequency (MHz)	PSD (dBm/3 kHz)	Limit (dBm/3 kHz)	Pass / Fail
1	2412	-8.53	8	Pass
6	2437	-5.08	8	Pass
11	2462	-7.91	8	Pass
12	2467	-10.98	8	Pass
13	2472	-30.86	8	Pass

802.11n (HT20)

TX Chain	Channel	Freq. (MHz)	PSD (dBm/3 kHz)	10 log (N=2) dB	Total PSD (dBm/3 kHz)	Limit (dBm/3 kHz)	Pass / Fail
0	1	2412	-10.70	3.01	-7.69	8	Pass
	6	2437	-5.67	3.01	-2.66	8	Pass
	11	2462	-9.25	3.01	-6.24	8	Pass
	12	2467	-11.75	3.01	-8.74	8	Pass
	13	2472	-30.67	3.01	-27.66	8	Pass
1	1	2412	-9.48	3.01	-6.47	8	Pass
	6	2437	-5.56	3.01	-2.55	8	Pass
	11	2462	-9.53	3.01	-6.52	8	Pass
	12	2467	-11.93	3.01	-8.92	8	Pass
	13	2472	-30.71	3.01	-27.70	8	Pass

NOTE:

1. Directional gain = $-0.15 \text{ dBi} + 10\log(2) = 2.86 \text{ dBi} < 6 \text{ dBi}$, so the limit no need to be reduced.
2. Method E) 2) c) of power density measurement of KDB 662911 is using for calculating total power density.

802.11n (HT40)

TX Chain	Channel	Freq. (MHz)	PSD (dBm/3 kHz)	10 log (N=2) dB	Total PSD (dBm/3 kHz)	Limit (dBm/3 kHz)	Pass / Fail
0	3	2422	-12.90	3.01	-9.89	8	Pass
	6	2437	-11.33	3.01	-8.32	8	Pass
	9	2452	-14.37	3.01	-11.36	8	Pass
	10	2457	-18.75	3.01	-15.74	8	Pass
	11	2462	-24.87	3.01	-21.86	8	Pass
1	3	2422	-13.45	3.01	-10.44	8	Pass
	6	2437	-11.23	3.01	-8.22	8	Pass
	9	2452	-14.52	3.01	-11.51	8	Pass
	10	2457	-18.25	3.01	-15.24	8	Pass
	11	2462	-23.91	3.01	-20.90	8	Pass

NOTE:

1. Directional gain = $-0.15 \text{ dBi} + 10\log(2) = 2.86 \text{ dBi} < 6 \text{ dBi}$, so the limit no need to be reduced.
2. Method E) 2) c) of power density measurement of KDB 662911 is using for calculating total power density.

Spectrum Plot of Worst Value

802.11b

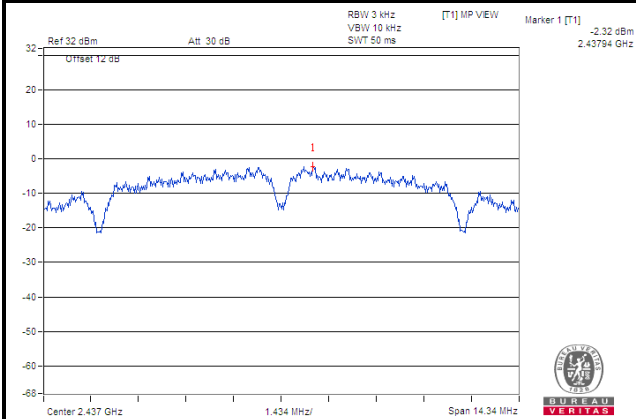

802.11g

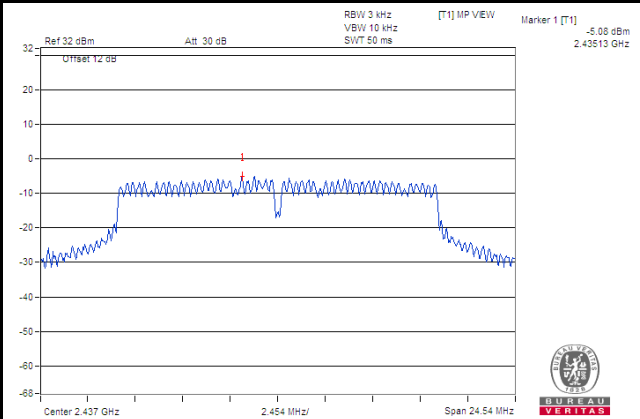

802.11n (HT20)

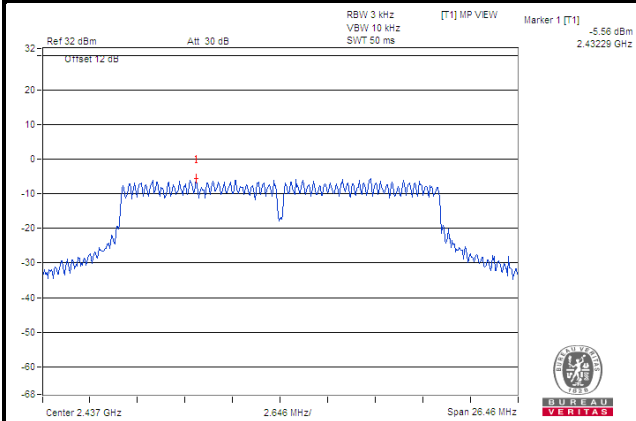

802.11n (HT40)

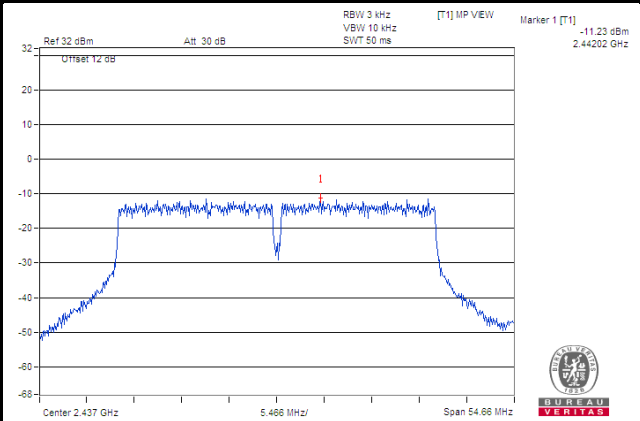

4.7 Conducted Out of Band Emission Measurement

4.7.1 Limits of Conducted Out of Band Emission Measurement

Below -20 dB of the highest emission level of operating band (in 100 kHz Resolution Bandwidth).

4.7.2 Test Setup

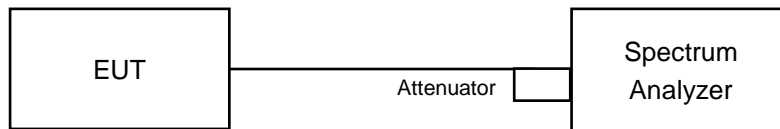

4.7.3 Test Instruments

Refer to section 4.1.2 to get information of above instrument.

4.7.4 Test Procedure

MEASUREMENT PROCEDURE REF

1. Set the RBW = 100 kHz.
2. Set the VBW \geq 300 kHz.
3. Detector = peak.
4. Sweep time = auto couple.
5. Trace mode = max hold.
6. Allow trace to fully stabilize.
7. Use the peak marker function to determine the maximum power level in any 100 kHz band segment within the fundamental EBW.

MEASUREMENT PROCEDURE OOB

1. Set RBW = 100 kHz.
2. Set VBW \geq 300 kHz.
3. Detector = peak.
4. Sweep = auto couple.
5. Trace Mode = max hold.
6. Allow trace to fully stabilize.
7. Use the peak marker function to determine the maximum amplitude level.

4.7.5 Deviation from Test Standard

No deviation.

4.7.6 EUT Operating Condition

The software provided by client to enable the EUT under transmission condition continuously at lowest, middle and highest channel frequencies individually.

4.7.7 Test Results

The conducted emission test is performed on each TX port of operating mode without summing or adding 10log (N) since the limit is relative emission limit.

The spectrum plots are attached on the following images. D1 line indicates the highest level, and D2 line indicates the 20 dB offset below D1. It shows compliance with the requirement.

802.11b

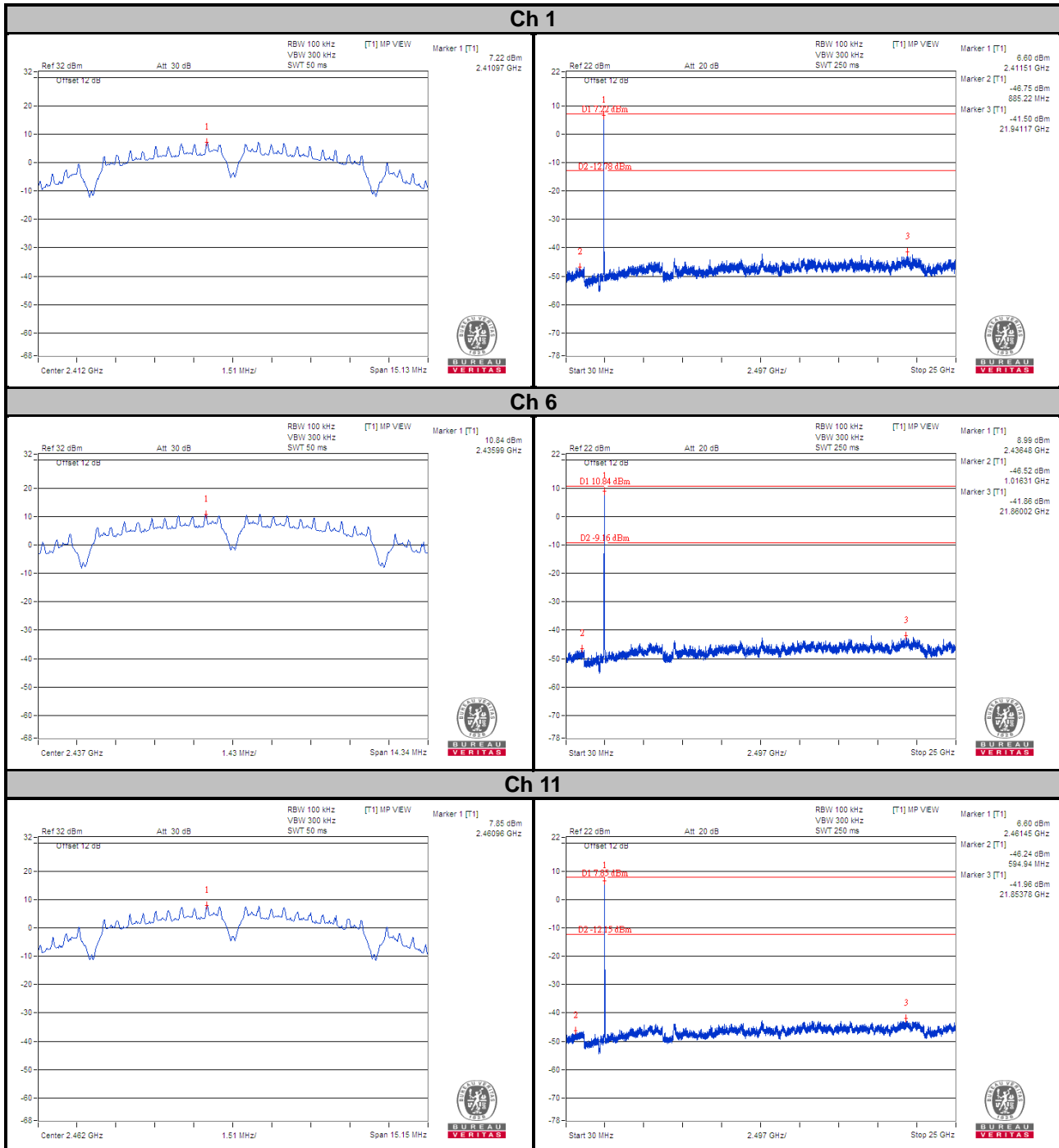

Ch 12

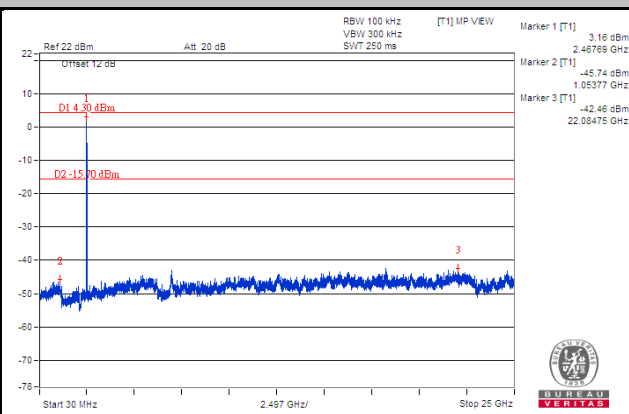
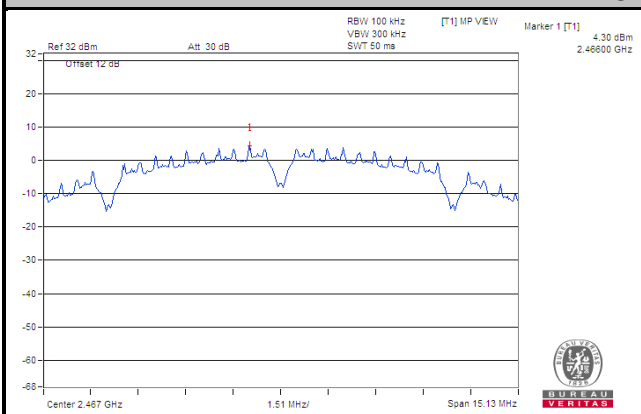

Ch 13

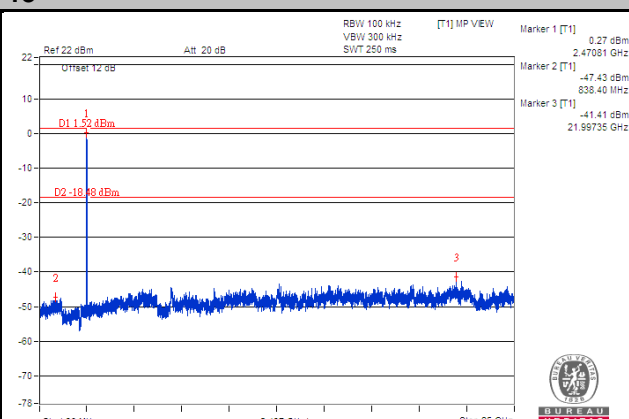
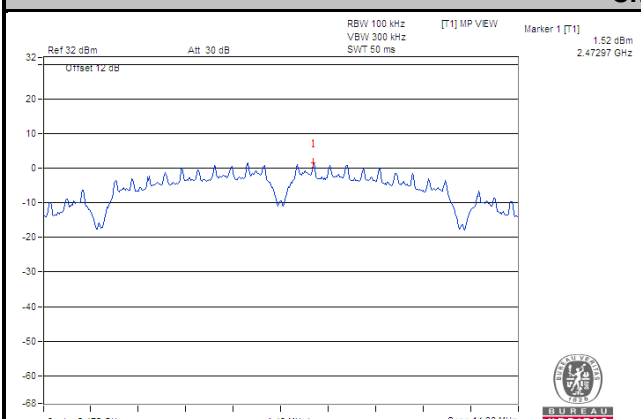

Ch 1 Band Edge

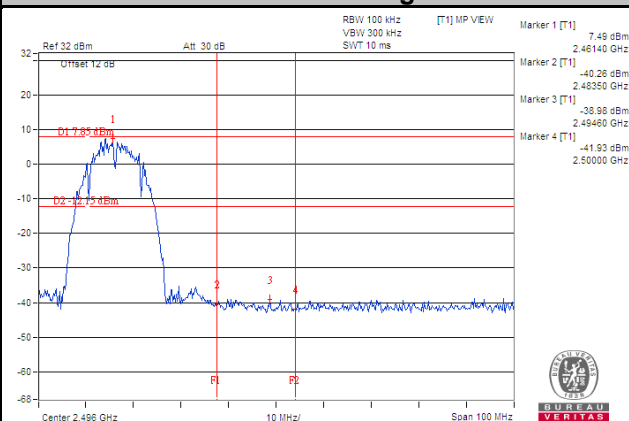
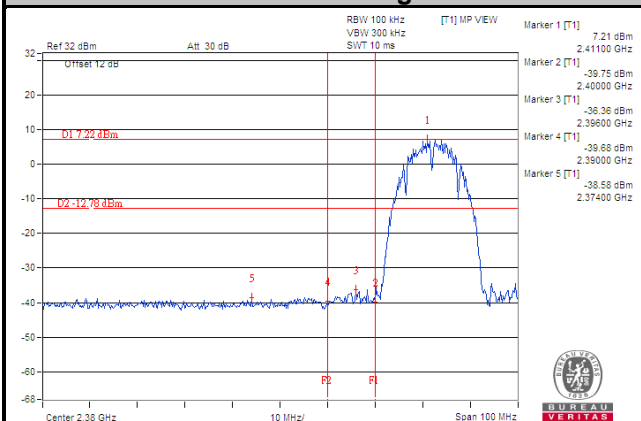

Ch 12 Band Edge

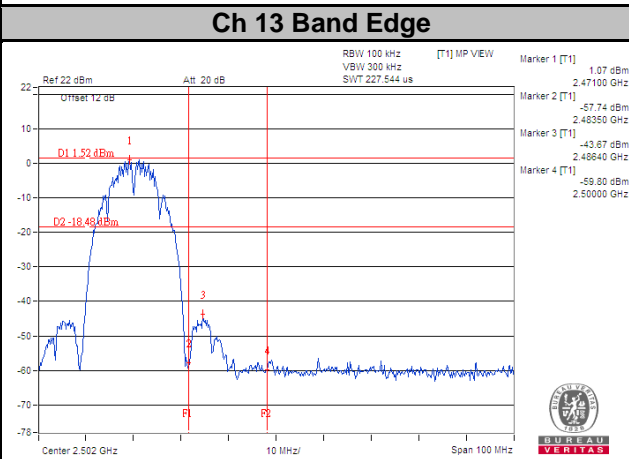
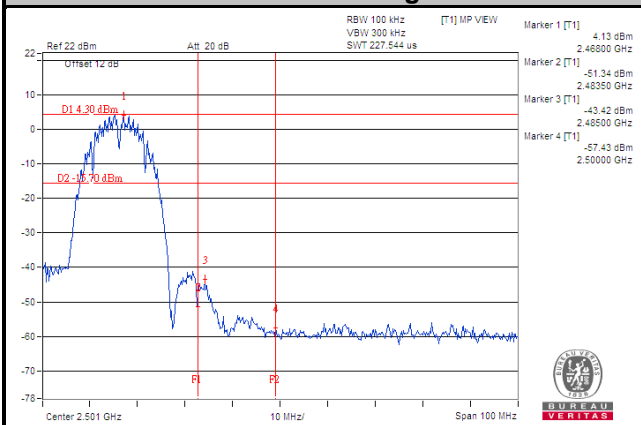

802.11g

Ch 1

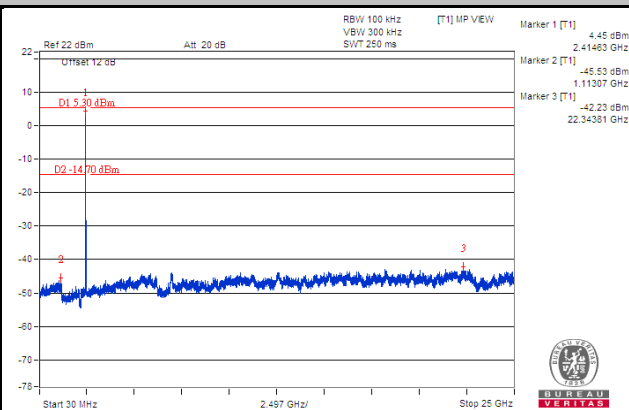
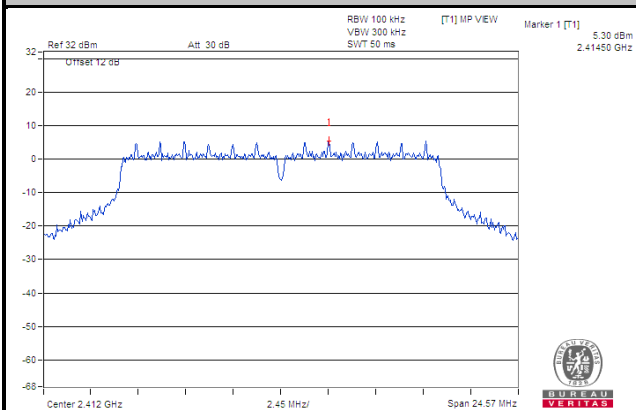

Ch 6

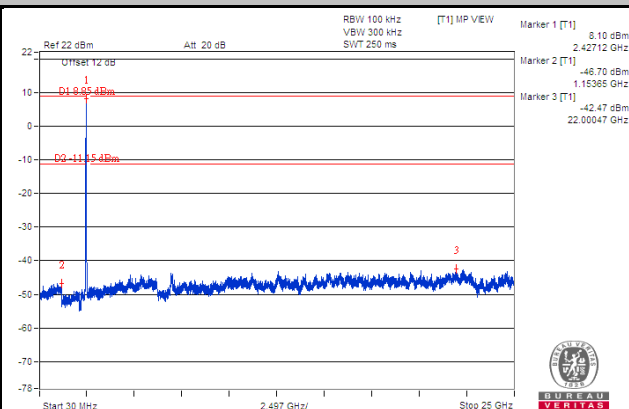
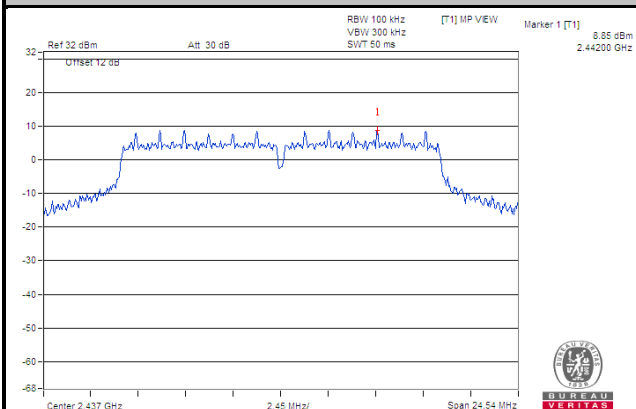

Ch 11

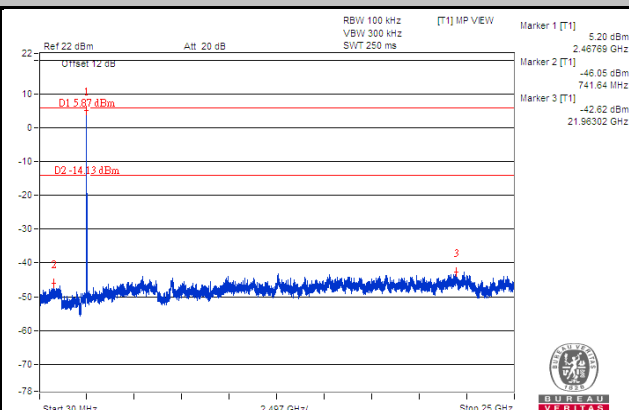
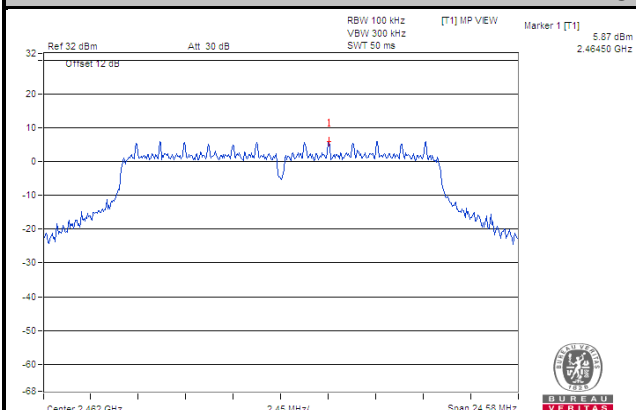

Ch 12

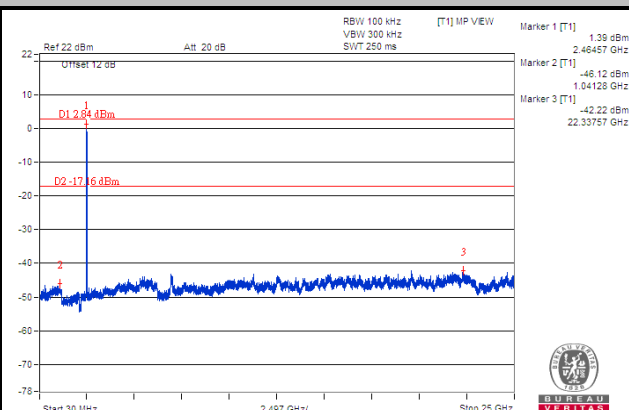
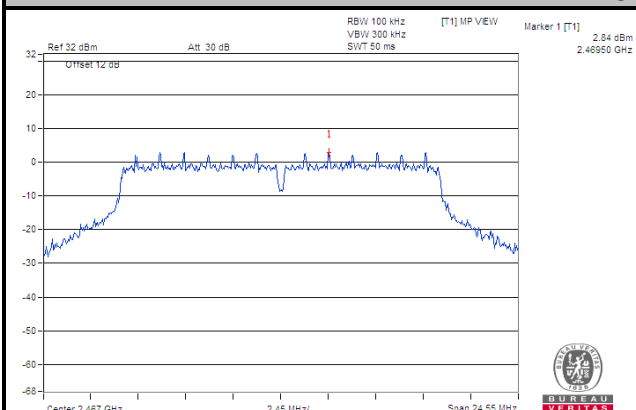

Ch 13

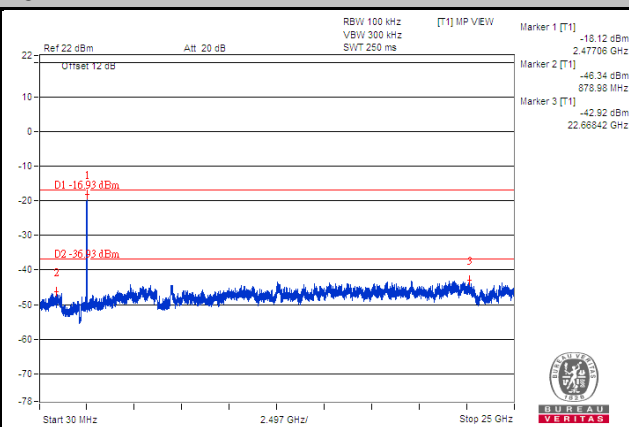
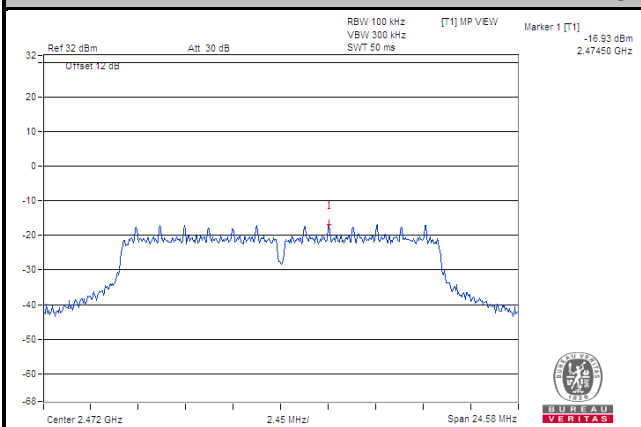

Ch 1 Band Edge

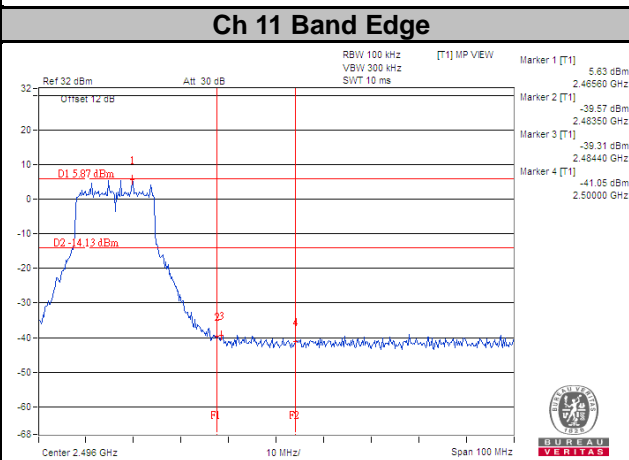
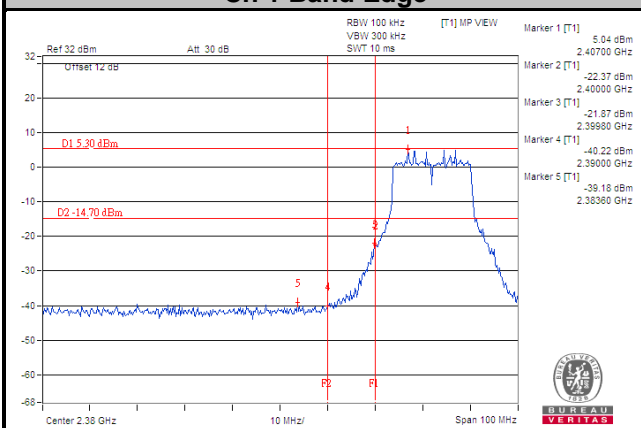

Ch 12 Band Edge

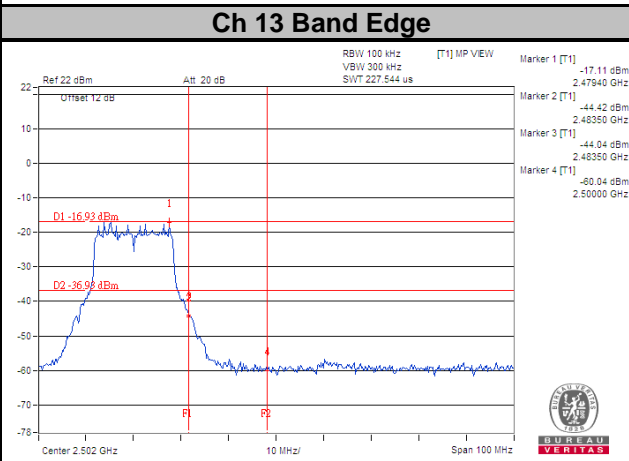
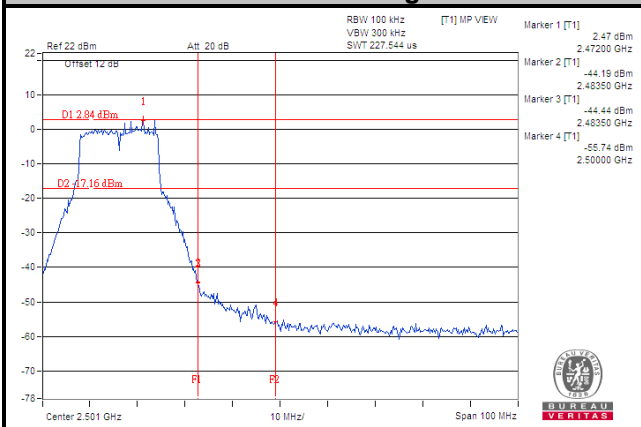

802.11n (HT20)
CHAIN 0

Ch 1

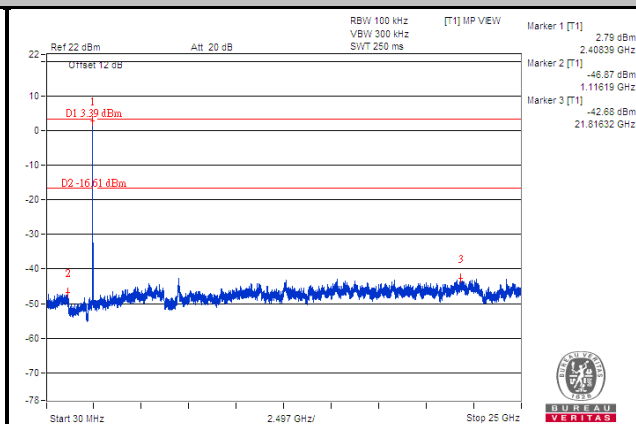
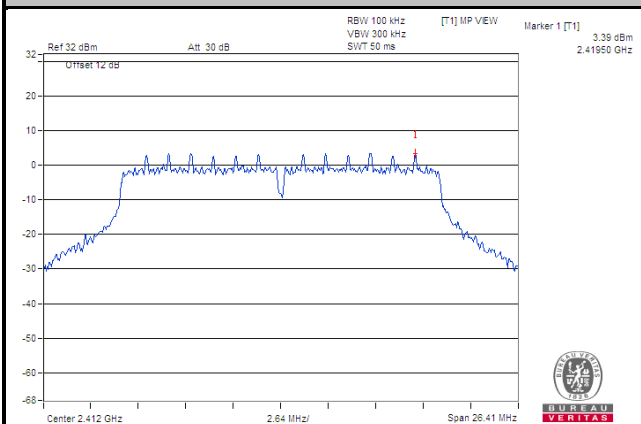

Ch 6

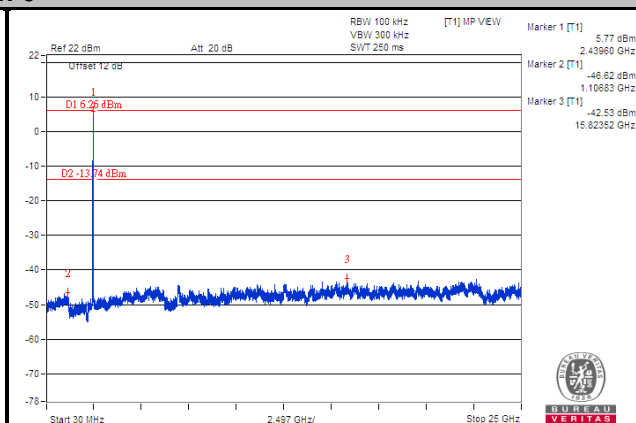
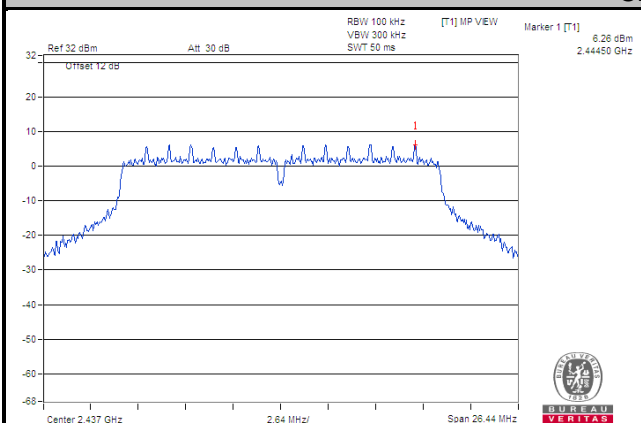

Ch 11

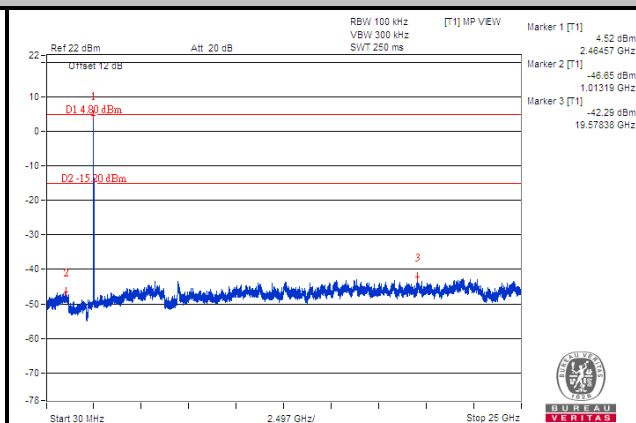
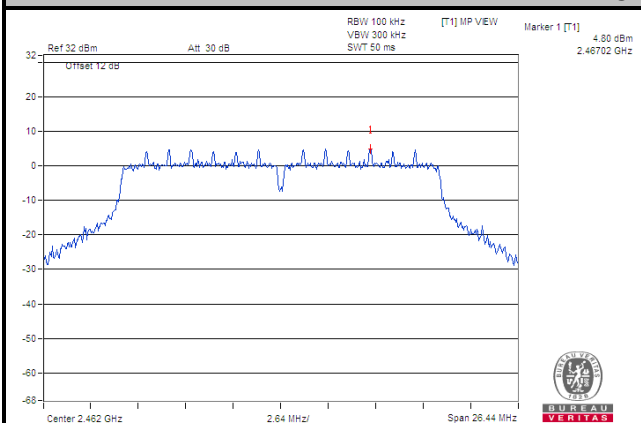

Ch 12

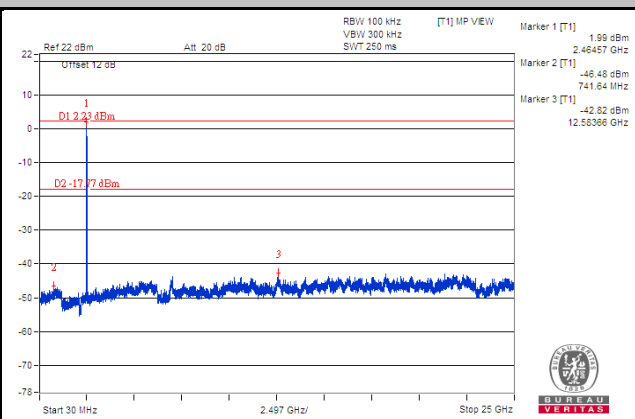
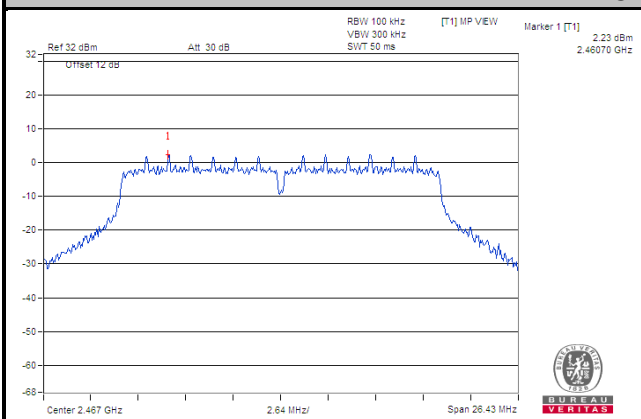

Ch 13

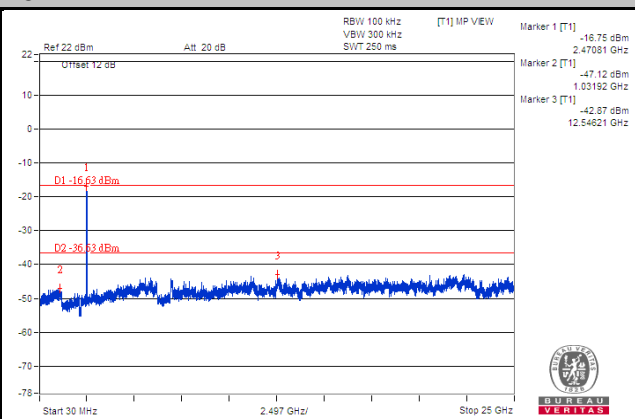
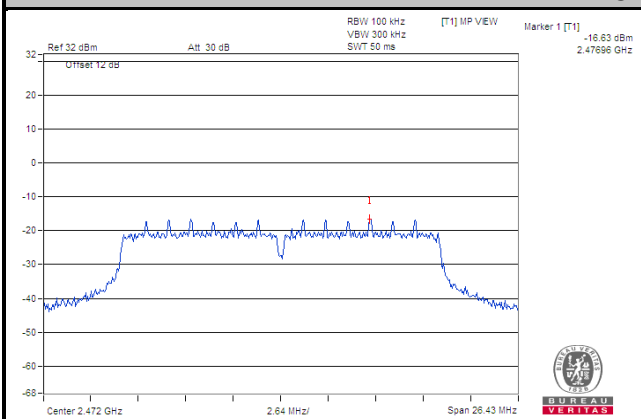

Ch 1 Band Edge

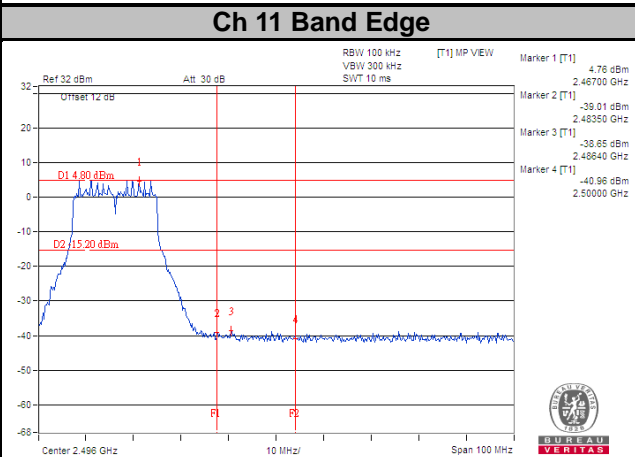
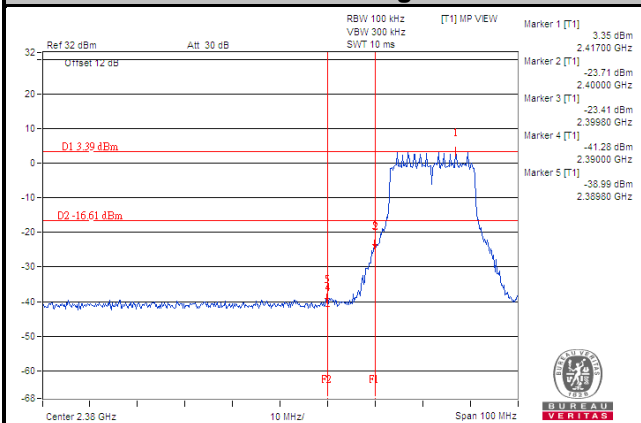

Ch 12 Band Edge

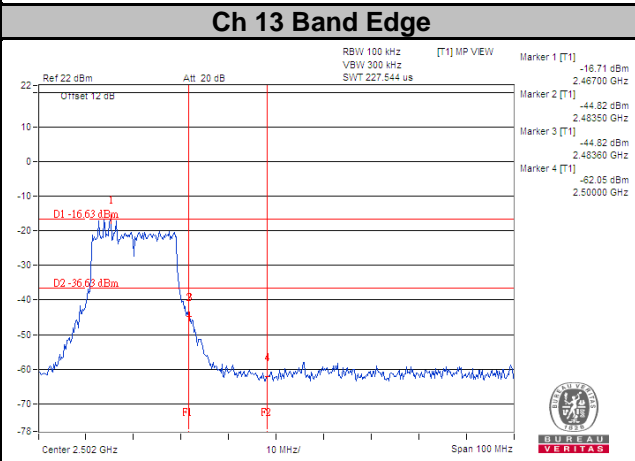
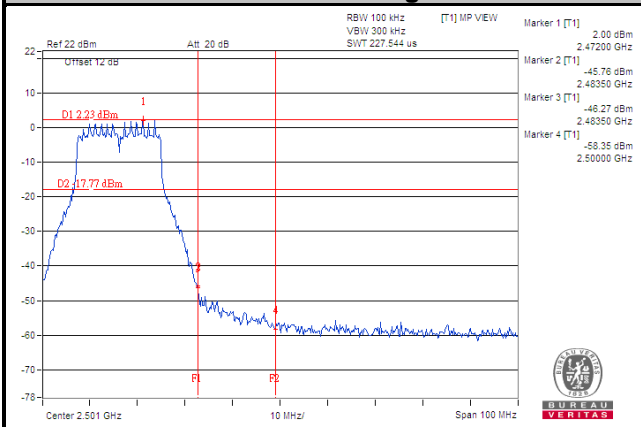

CHAIN 1

Ch 1

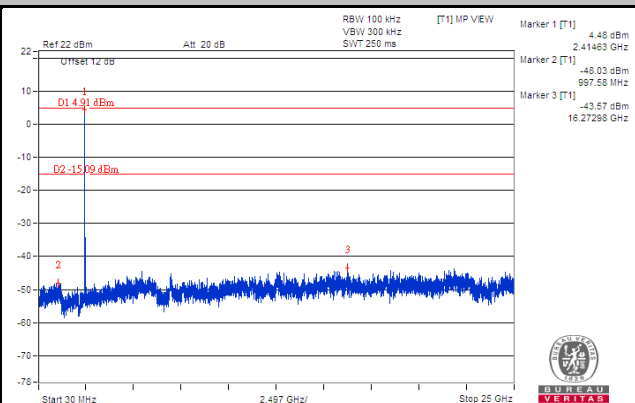
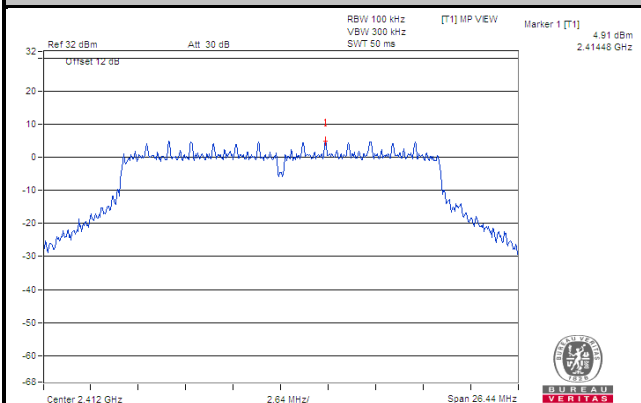

Ch 6

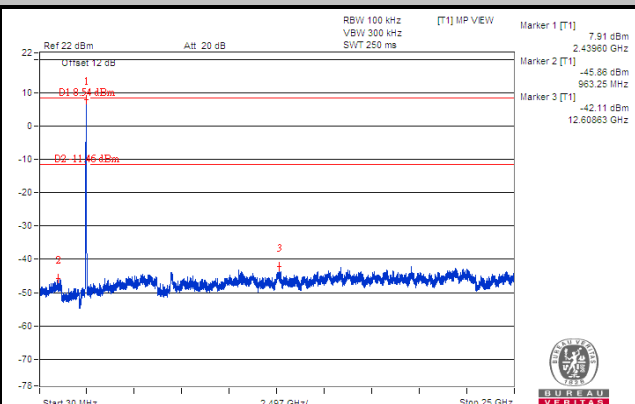
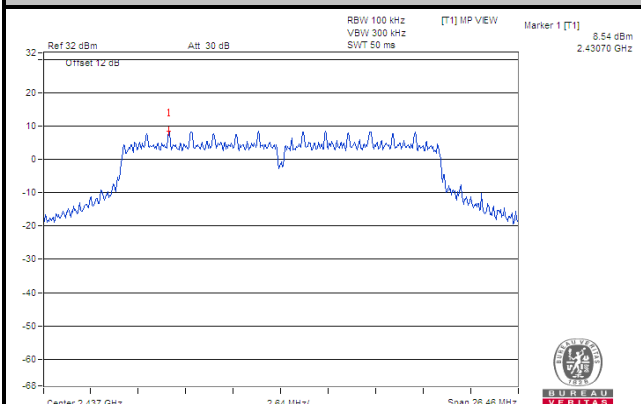

Ch 11

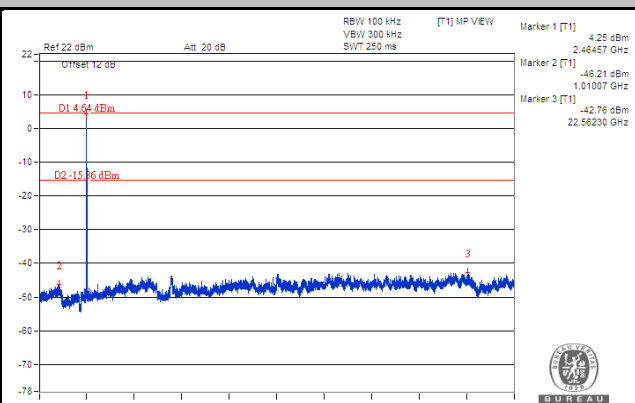
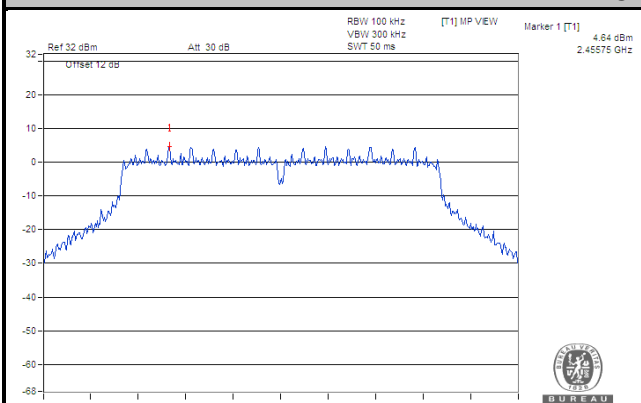

Ch 12

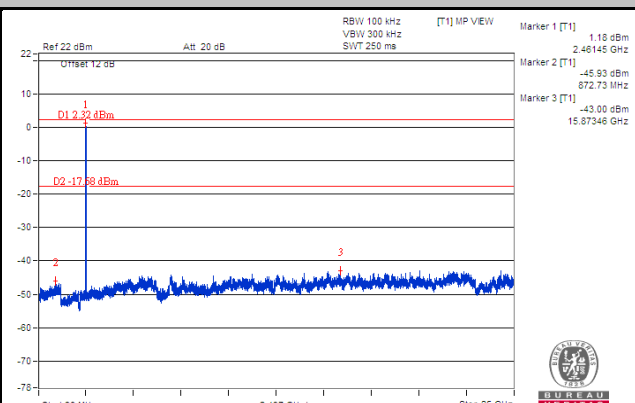
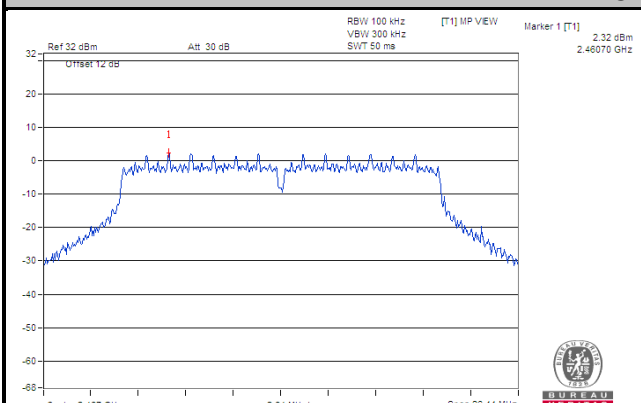

Ch 13

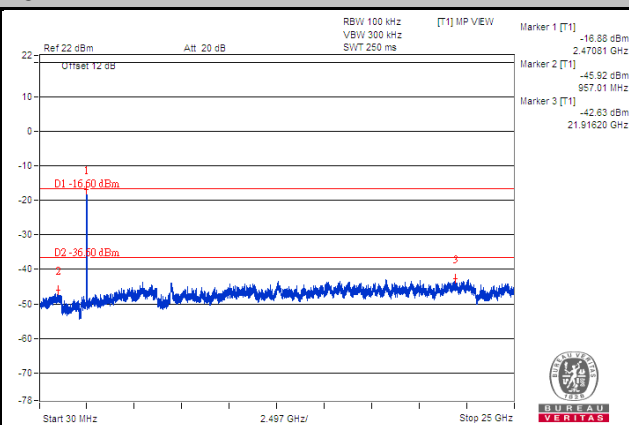
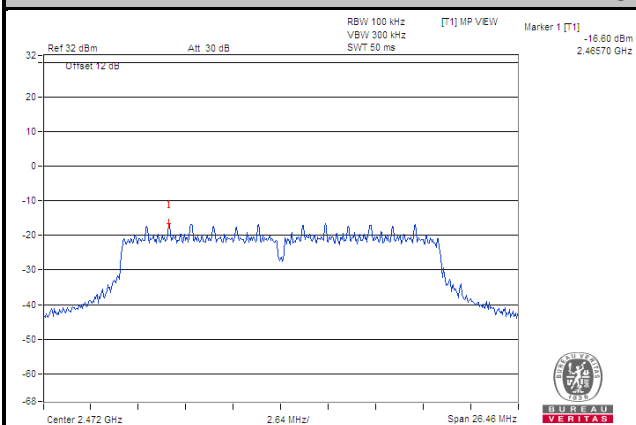

Ch 1 Band Edge

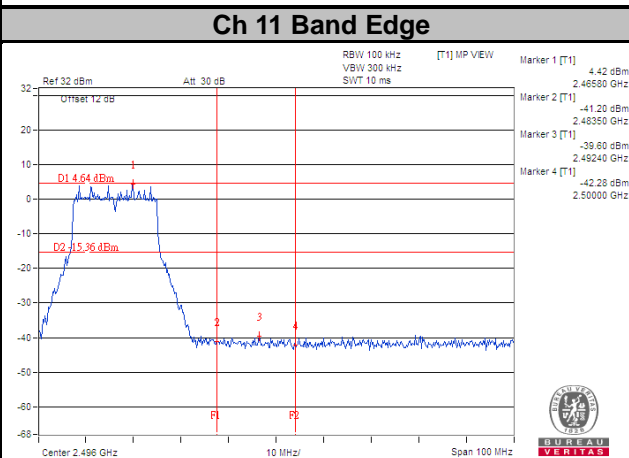
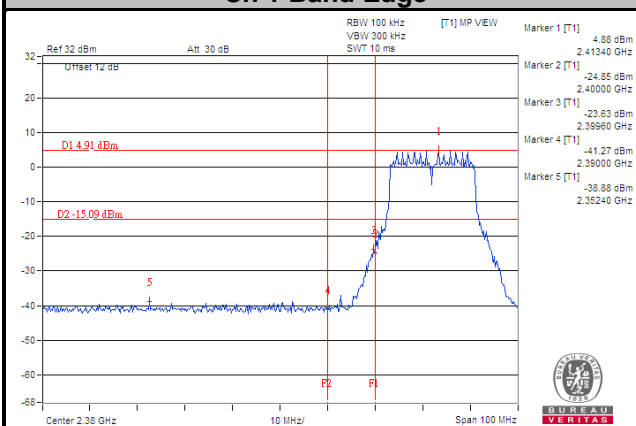

Ch 12 Band Edge

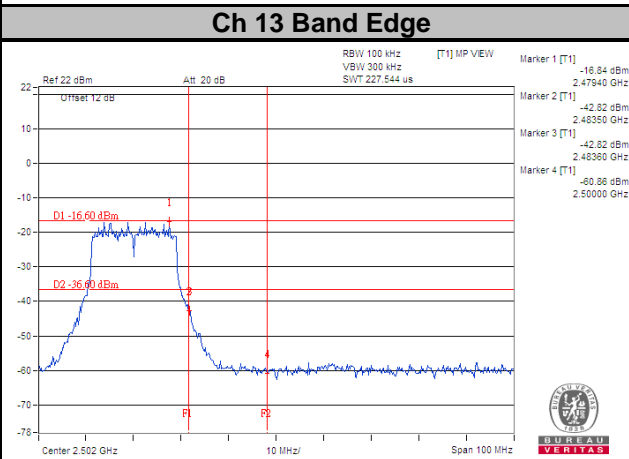
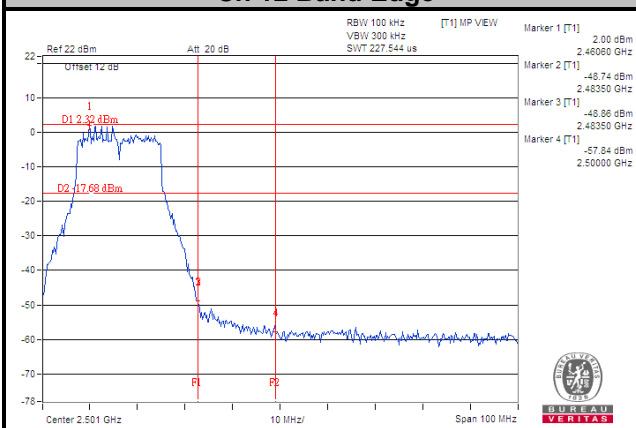

802.11n (HT40)
CHAIN 0

Ch 3

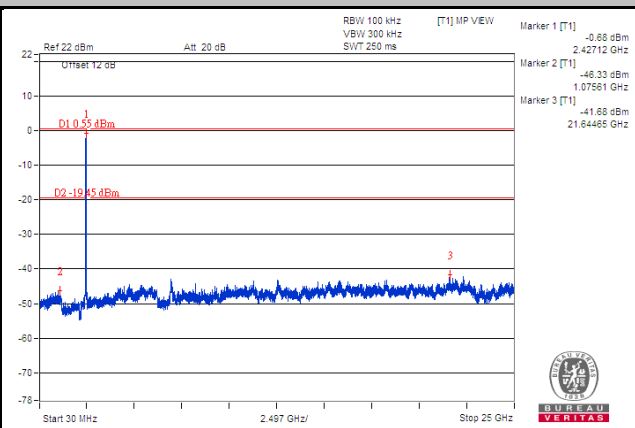
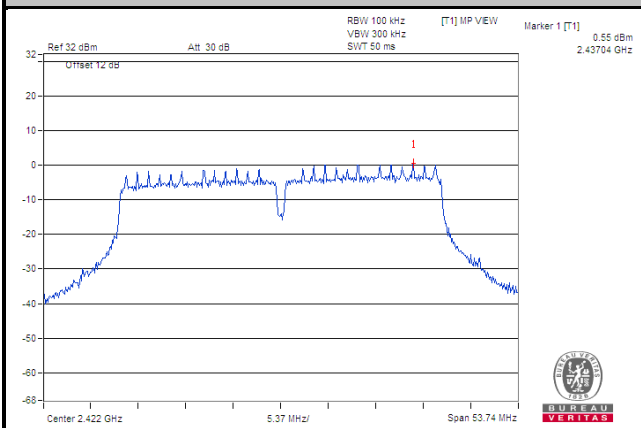

Ch 6

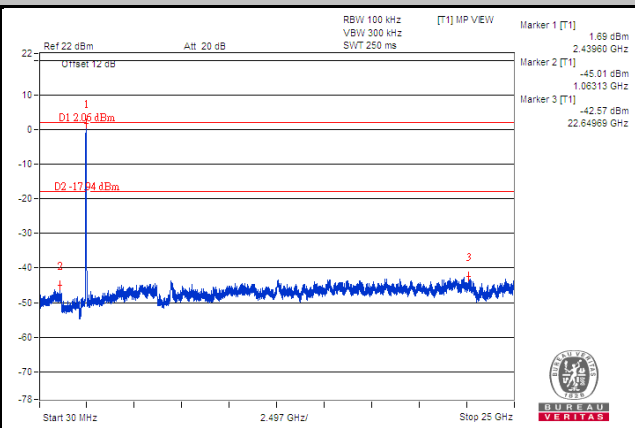
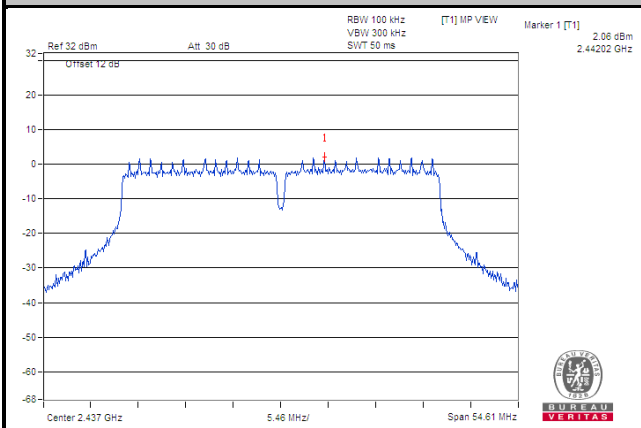

Ch 9

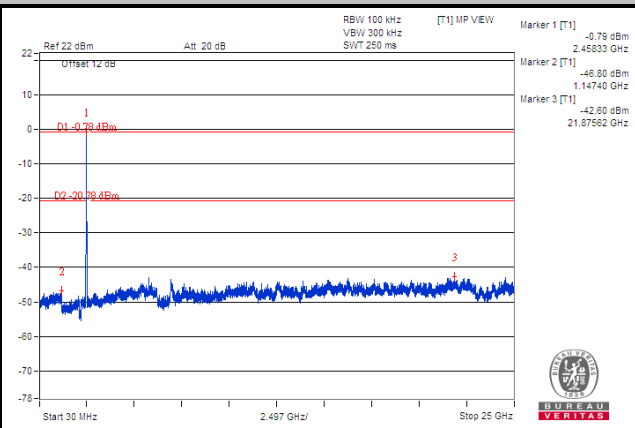
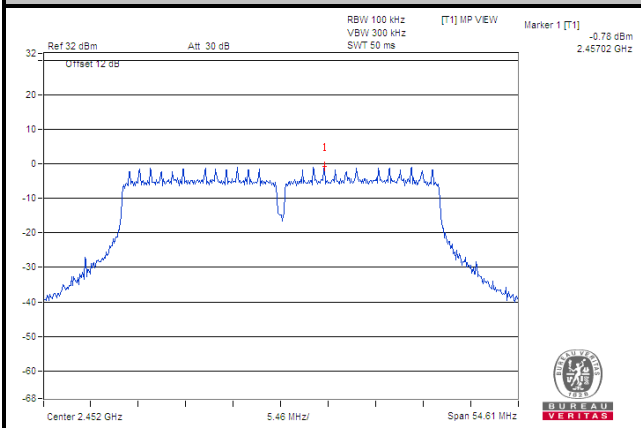

Ch 10

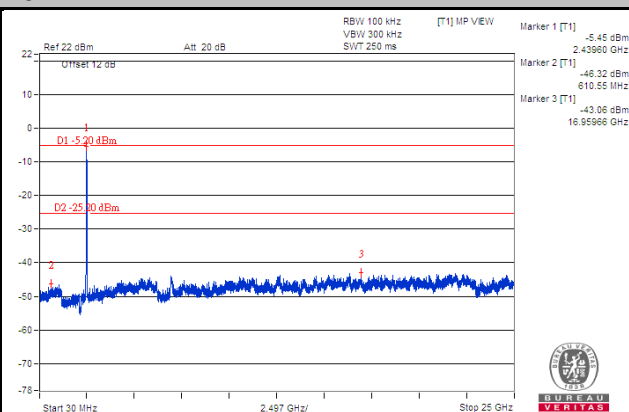
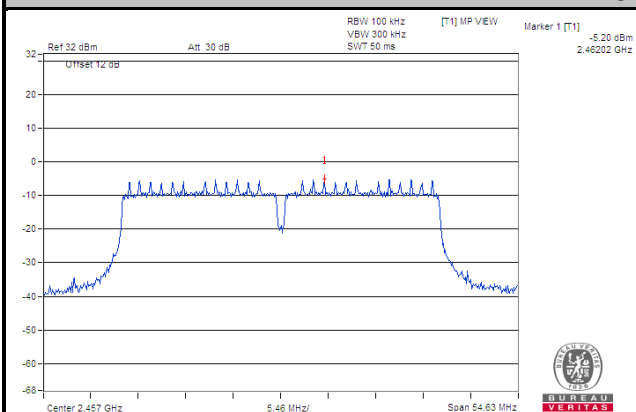

Ch 11

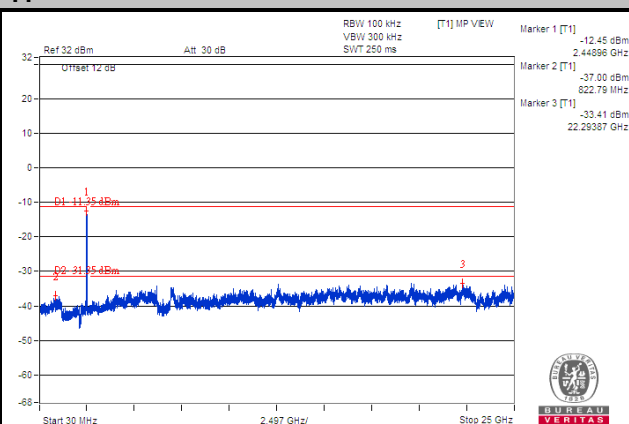
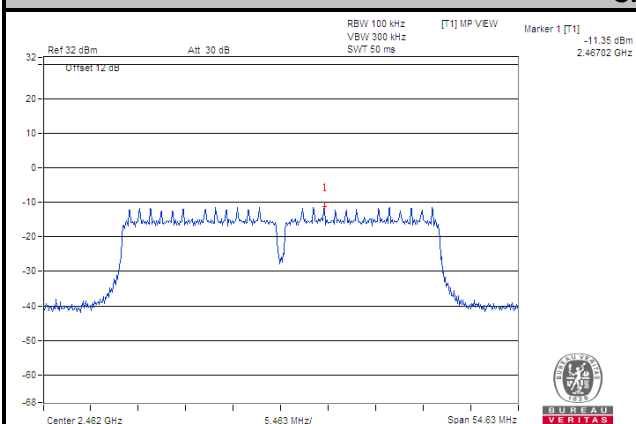

Ch 3 Band Edge

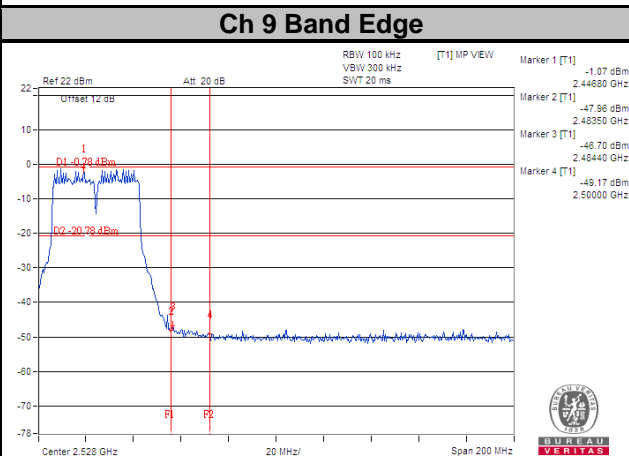
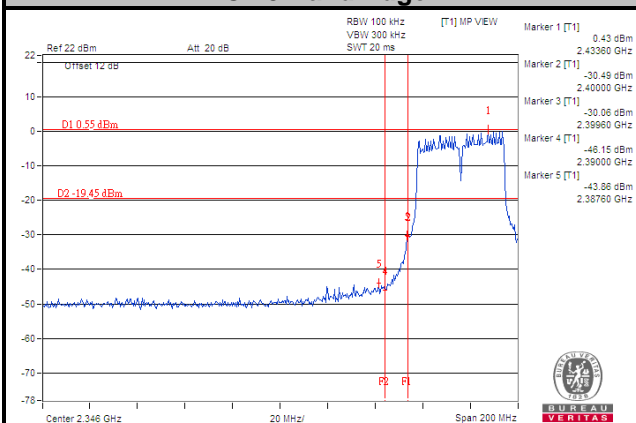

Ch 10 Band Edge

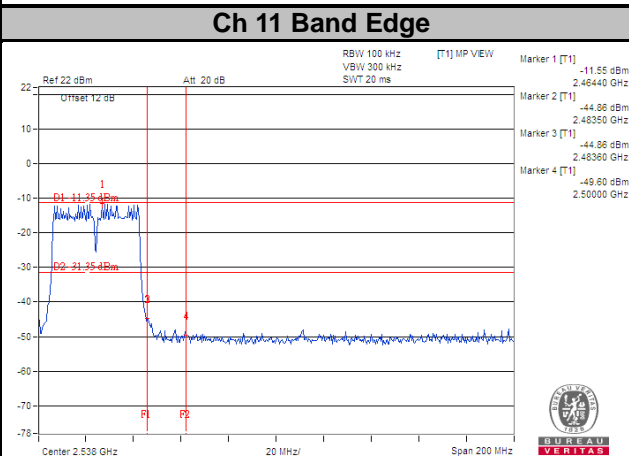
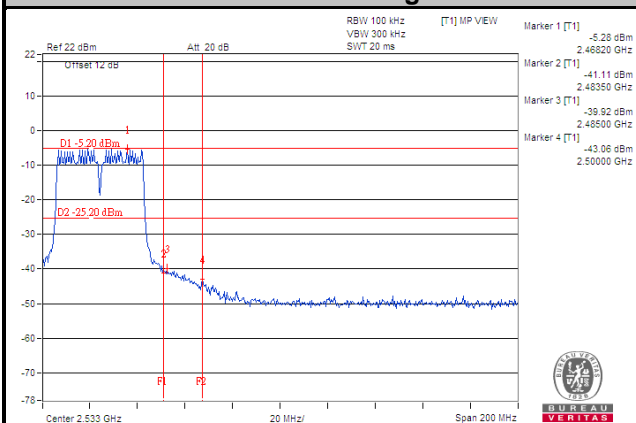

CHAIN 1

Ch 3

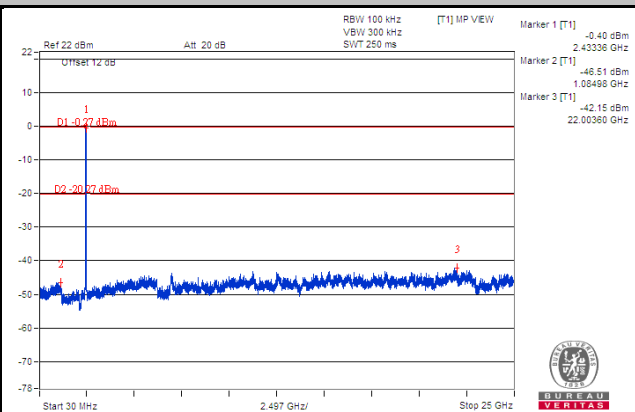
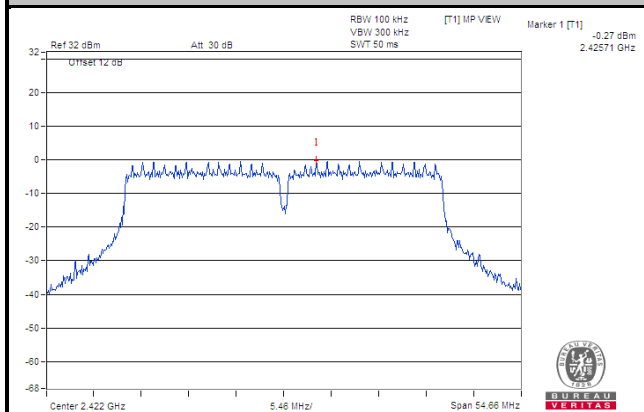

Ch 6

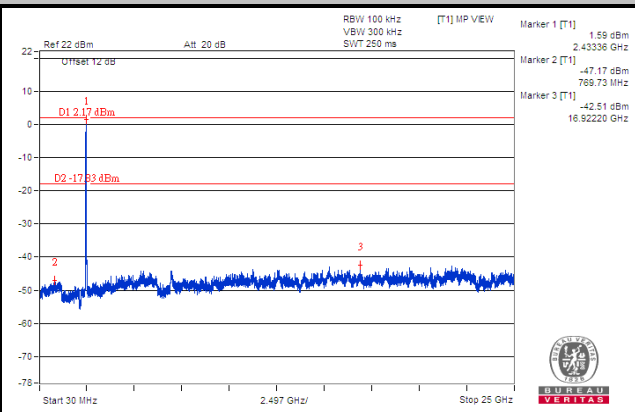
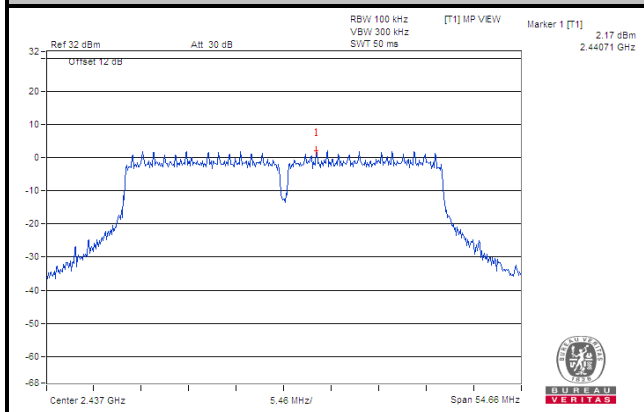

Ch 9

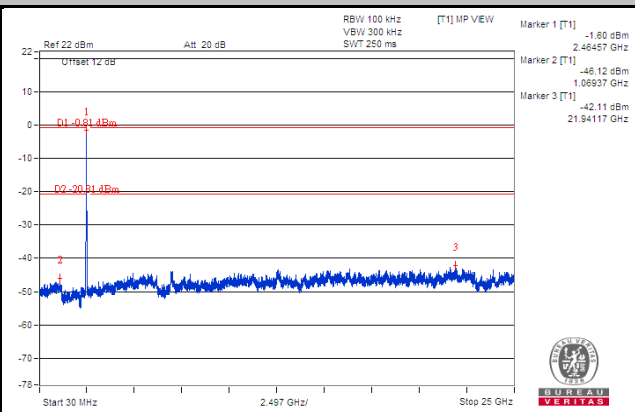
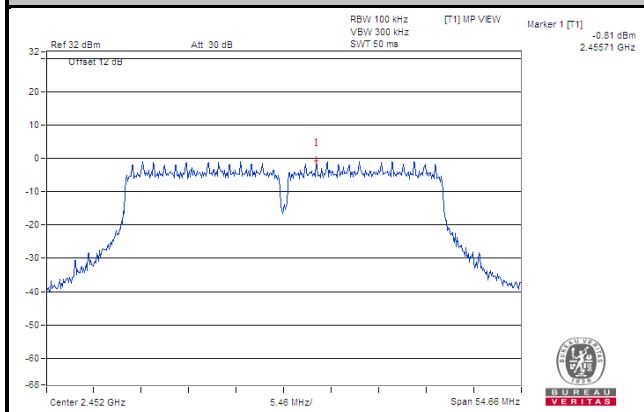

Ch 10

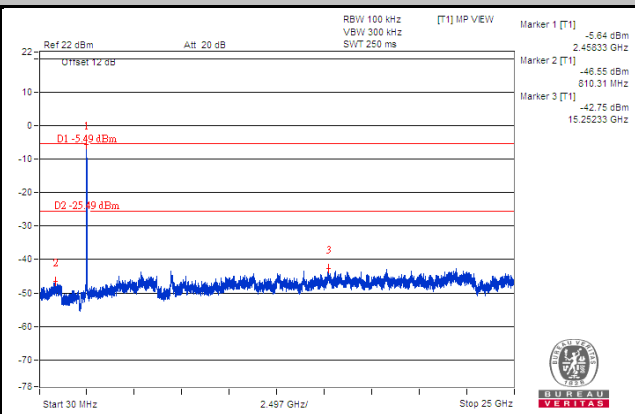
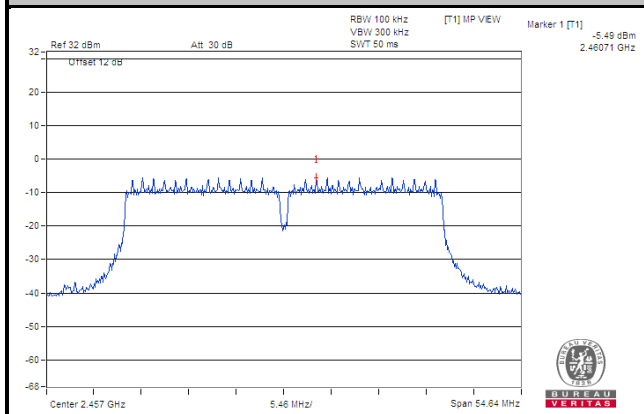

Ch 11

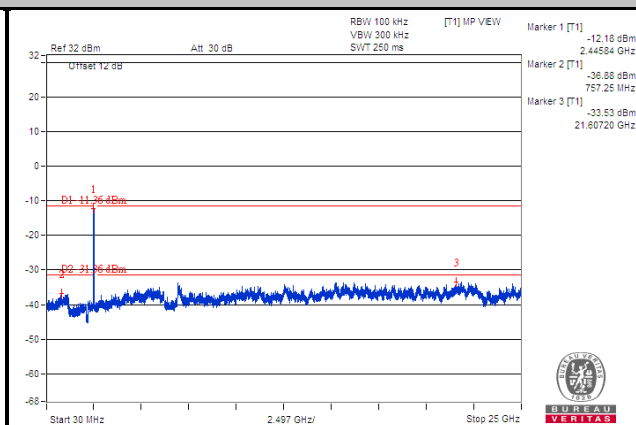
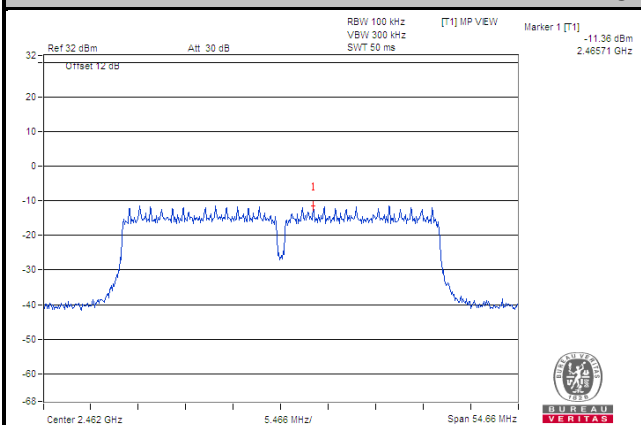

Ch 3 Band Edge

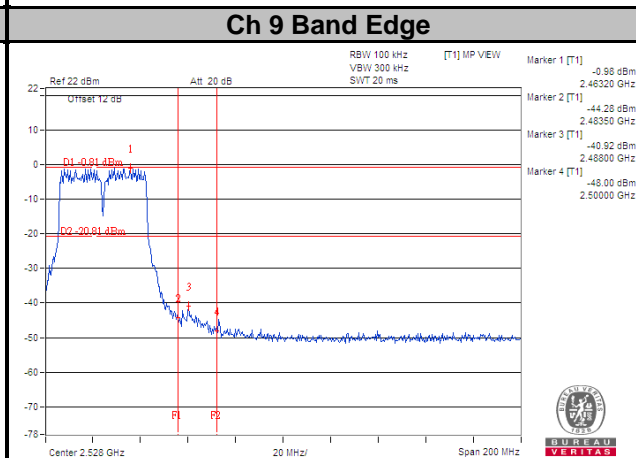
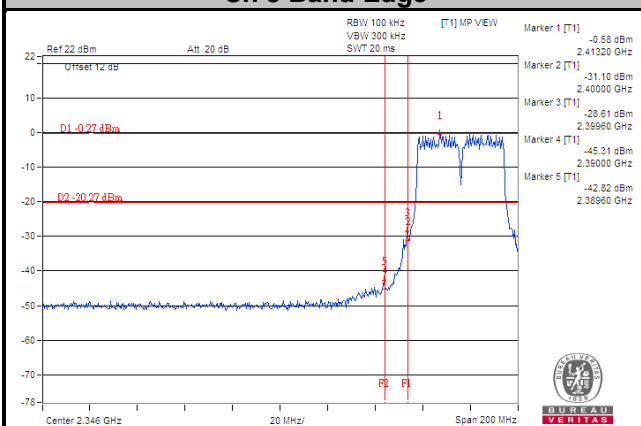

Ch 10 Band Edge

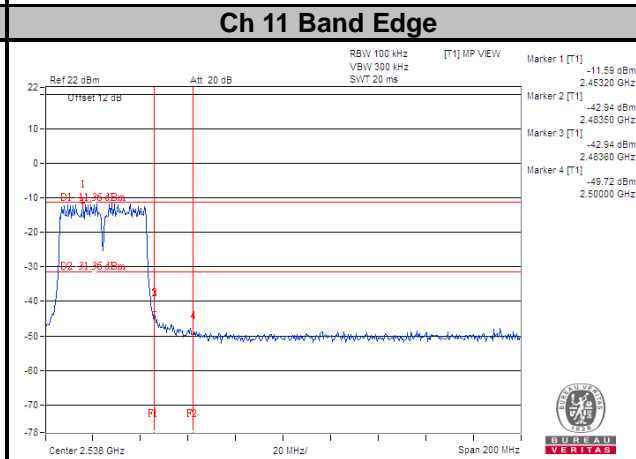
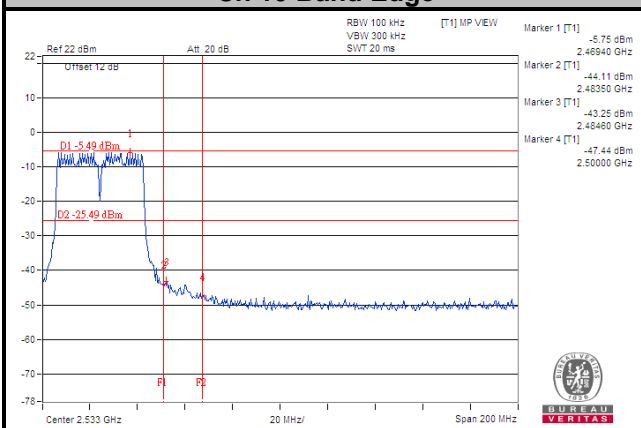

5 Pictures of Test Arrangements

Please refer to the attached file (Test Setup Photo).

Appendix – Information of the Testing Laboratories

We, Bureau Veritas Consumer Products Services (H.K.) Ltd., Taoyuan Branch, were founded in 1988 to provide our best service in EMC, Radio, Telecom and Safety consultation. Our laboratories are FCC recognized accredited test firms and accredited according to ISO/IEC 17025.

If you have any comments, please feel free to contact us at the following:

Lin Kou EMC/RF Lab

Tel: 886-2-26052180

Fax: 886-2-26051924

Hsin Chu EMC/RF/Telecom Lab

Tel: 886-3-6668565

Fax: 886-3-6668323

Hwa Ya EMC/RF/Safety Lab

Tel: 886-3-3183232

Fax: 886-3-3270892

Email: service.adt@tw.bureauveritas.com

Web Site: www.bureauveritas-adt.com

The address and road map of all our labs can be found in our web site also.

--- END ---