



# FCC RADIO TEST REPORT

Applicant : Micro-Star Int'l Co.,Ltd.  
Address : No.69, Lide St., Zhonghe Dist. New Taipei City 235  
Taiwan  
Equipment : WiFi USB Adapter  
Model No. : GUAXE54  
Trade Name : msi  
FCC ID : I4L-GUAXE54

## I HEREBY CERTIFY THAT :

The sample was received on Jun. 16, 2023 and the testing was completed on Sep. 28, 2023 at CerpPASS Technology Corp. The test result refers exclusively to the test presented test model / sample. Without written approval of CerpPASS Technology Corp., the test report shall not be reproduced except in full.

Approved by:

Mark Liao / Supervisor

Laboratory Accreditation:

CerpPASS Technology Corporation Test Laboratory





CONTENTS

- 1. Summary of Test Procedure and Test Results ..... 5
  - 1.1. Applicable Standards .....5
- 2. Test Configuration of Equipment under Test ..... 6
  - 2.1. Feature of Equipment under Test.....6
  - 2.2. Carrier Frequency of Channels ..... 7
  - 2.3. Test Mode and Test Software .....8
  - 2.4. Description of Test System.....9
  - 2.5. General Information of Test..... 10
  - 2.6. Measurement Uncertainty ..... 11
- 3. Test Equipment and Ancillaries Used for Tests ..... 12
- 4. Antenna Requirements ..... 14
  - 4.1. Standard Applicable ..... 14
  - 4.2. Antenna Construction and Directional Gain..... 14
- 5. Test of AC Power Line Conducted Emission ..... 15
  - 5.1. Test Limit ..... 15
  - 5.2. Test Procedures ..... 15
  - 5.3. Typical Test Setup ..... 16
  - 5.4. Test Result and Data..... 17
  - 5.5. Test Photographs ..... 19
- 6. Test of Undesirable Emission (Radiated)..... 20
  - 6.1. Test Limit .....20
  - 6.2. Test Procedures .....21
  - 6.3. Typical Test Setup .....22
  - 6.4. Test Result and Data (9kHz ~ 30MHz).....23
  - 6.5. Test Result and Data (30MHz ~ 1GHz) .....23
  - 6.6. Test Result and Data (1GHz ~ 40GHz).....25
  - 6.7. In-Band Emission ..... 107
  - 6.8. Restricted Bands of Operation ..... 133
  - 6.9. Test Photographs (30MHz ~ 1GHz) ..... 134
  - 6.10. Test Photographs (1GHz ~ 40GHz) ..... 135
- 7. On Time, Duty Cycle ..... 137
  - 7.1. Test Limit ..... 137
  - 7.2. Test Procedure ..... 137
  - 7.3. Test Setup Layout ..... 137
  - 7.4. Test Result and Data..... 137
- 8. 26dB Bandwidth & 99% Occupied Bandwidth ..... 139
  - 8.1. Test Limit ..... 139
  - 8.2. Test Procedure ..... 139
  - 8.3. Test Setup Layout ..... 139
  - 8.4. Test Result and Data (26dB Bandwidth) ..... 140
  - 8.5. Test Result and Data (99% Occupied Bandwidth) ..... 144
- 9. Maximum Equivalent Isotropically Radiated Power(E.I.R.P.)..... 208



- 9.1. Test Limit ..... 208
- 9.2. Test Procedure ..... 209
- 9.3. Test Setup Layout ..... 209
- 9.4. Test Result and Data ..... 211
- 10. Peak Power Spectral Density (E.I.R.P.) ..... 214
  - 10.1. Test Limit ..... 214
  - 10.2. Test Procedure ..... 215
  - 10.3. Test Setup Layout ..... 215
  - 10.4. Test Result and Data ..... 217
- 11. Contention Based Protocol ..... 230
  - 11.1. Test Limit ..... 230
  - 11.2. Test Procedure ..... 230
  - 11.3. Test Setup Layout ..... 230
  - 11.4. Test Result and Data ..... 231





# 1. Summary of Test Procedure and Test Results

## 1.1. Applicable Standards

ANSI C63.10:2013

FCC Rules and Regulations Part 15 Subpart E §15.407

KDB 789033

The following reference test guidance is not within the scope of accreditation of TAF.

KDB 987594 D01

KDB 987594 D02

FCC KDB 662911 D01 v02r01

FCC KDB 412172 D01 v01r01

FCC Rule	Description of Test	Result	Remark
15.203	Antenna Requirement	PASS	-
15.207(a)	AC Power Line Conducted Emission	PASS	-
15.407(b) 15.209	Undesirable Emission	PASS	-
15.407(a)	26 dB & Occupied Bandwidth	PASS	-
15.407(a)	Maximum Equivalent Isotropically Radiated Power (E.I.R.P.)	PASS	-
15.407(a)	Peak Power Spectral Density (E.I.R.P.)	PASS	-
15.407(d)	Contention-Based Protocol	PASS	-

\*The lab has reduced the uncertainty risk factor from test equipment, environment and staff technicians which according to the standard on contract. Therefore, the test result will only be determined by standard requirement, measurement uncertainty evaluation is not considered.



## 2. Test Configuration of Equipment under Test

### 2.1. Feature of Equipment under Test

Operation Frequency Range	2.4GHz:802.11b/g/n(Turbo QAM)/ax: 2400-2483.5MHz 5GHz:802.11a/n/ac/ax: 5150-5250MHz, 5250-5350MHz, 5470-5725MHz, 5725-5850MHz 6GHz:802.11ax: 5955MHz~6425MHz, 6425MHz~6525MHz 6525MHz~6875MHz, 6875MHz~7125MHz
Center Frequency Range	2.4GHz:802.11b/g/n(Turbo QAM)/ax: 2412MHz-2462MHz 5GHz :802.11a/n/ac/ax: 5180-5250MHz, 5260-5320MHz, 5500-5720MHz, 5745-5825MHz 6GHz: 802.11ax: 5955MHz~6415MHz, 6435MHz~6515MHz 6535MHz~6855MHz, 6875MHz~7115MHz
Modulation Type	2.4GHz: 802.11b: CCK, DQPSK, DBPSK 802.11g/n: BPSK, QPSK, 16QAM, 64QAM, 256QAM(Turbo QAM) 802.11ax: BPSK, QPSK, 16QAM, 64QAM, 256QAM, 1024QAM 5GHz: 802.11a/n: BPSK, QPSK, 16QAM, 64QAM 802.11ac: BPSK, QPSK, 16QAM, 64QAM, 256QAM 802.11ax: BPSK, QPSK, 16QAM, 64QAM, 256QAM, 1024QAM 6GHz: 802.11ax: BPSK, QPSK, 16QAM, 64QAM, 256QAM, 1024QAM
Modulation Technology	DSSS, OFDM, OFDMA
Data Rate	2.4GHz: 802.11b: 1, 2, 5.5, 11Mbps 802.11g: 6, 9, 12, 18, 24, 36, 48, 54Mbps 802.11n: MCS0 – MCS15, HT20/40 MCS0 – MCS9, VHT20/40(Turbo QAM) 802.11ax: MCS0 – MCS11, HE20/40 5GHz: 802.11a: 6, 9, 12, 18, 24, 36, 48, 54Mbps 802.11n: MCS0 – MCS15, HT20/40 802.11ac: MCS0 – MCS9, VHT20/40/80/160 802.11ax: MCS0 – MCS11, HE20/40/80/160 6GHz: 802.11ax: MCS0 – MCS11, HE20/40/80/160
Antenna Type	PCB Antenna
Antenna Gain	2400-2490MHz: ANT A: 1.40 dBi, ANT B: 1.70 dBi 5150-5200MHz: ANT A: 3.00 dBi, ANT B: 3.50 dBi 5300-5400MHz: ANT A: 2.90 dBi, ANT B: 2.80 dBi 5500-5700MHz: ANT A: 2.40 dBi, ANT B: 2.10 dBi 5700-5850MHz: ANT A: 1.20 dBi, ANT B: 1.50 dBi 5925~6400MHz: ANT A: 3.30 dBi, ANT B: 3.20 dBi 6400~6500MHz: ANT A: 3.30 dBi, ANT B: 3.30 dBi 6500~6800MHz: ANT A: 3.90 dBi, ANT B: 3.40 dBi 6900~7125MHz: ANT A: 4.00 dBi, ANT B: 3.50 dBi
USB cradle	Brand: msi, Model: GUAXE54C

Note:

1. WLAN 2.4G 802.11n Support TurboQAM.
2. EUT support TPC Function.
3. EUT support Client Mode without radar detection.
4. EUT support Indoor Client.
5. For more details, please refer to the User's manual of the EUT.



## 2.2. Carrier Frequency of Channels

Frequency Range (MHz)	IEEE Std. 802.11	Ch. Frequency (MHz)	Channel Number
5925 ~ 7125	802.11ax(HE20)	5955 ~ 7115	1~233
5925 ~ 7125	802.11ax(HE40)	5965 ~ 7085	3~227
5925 ~ 7125	802.11ax(HE80)	5985 ~ 7025	7~215
5925 ~ 7125	802.11ax(HE160)	6025 ~ 6985	15~207

The EUT incorporates a MIMO function.

Modulation Type	TX CONFIGURATION
802.11ax HE20	2TX
802.11ax HE40	2TX
802.11ax HE80	2TX
802.11ax HE160	2TX



### 2.3. Test Mode and Test Software

- a. During testing, the interface cables and equipment positions were varied according to ANSI C63.10.
- b. The complete test system included remote workstation and EUT for RF test. The remote workstation included Notebook.
- c. An executive program, "RTL8852C\_USB\_MP\_Package\_ALPHA ver. v2.0.24" under Windows OS system was executed to transmit and receive data via WLAN.
- d. The following test modes were performed for the test:

Conducted Emissions from the AC mains power ports	
Test Mode	Operating Description
1	802.11ax HE20 (7.3Mbps) , From System (120V/60Hz)
2	802.11ax HE40 (14.6Mbps) , From System (120V/60Hz)
3	802.11ax HE80 (30.6Mbps) , From System (120V/60Hz)
4	802.11ax HE160 (61.3Mbps) , From System (120V/60Hz)
caused "Test Mode 4" generated the worst case, it was reported as the final data.	
Radiation Emissions (Below 1GHz)	
Test Mode	Operating Description
1	802.11ax HE20 (7.3Mbps) , From System (120V/60Hz)
2	802.11ax HE40 (14.6Mbps) , From System (120V/60Hz)
3	802.11ax HE80 (30.6Mbps) , From System (120V/60Hz)
4	802.11ax HE160 (61.3Mbps) , From System (120V/60Hz)
caused "Test Mode 4" generated the worst case, it was reported as the final data.	
Radiation Emissions (1GHz ~ 40GHz)	
Test Mode	Operating Description
1	802.11ax HE20 (7.3Mbps) , From System (120V/60Hz)
2	802.11ax HE40 (14.6Mbps) , From System (120V/60Hz)
3	802.11ax HE80 (30.6Mbps) , From System (120V/60Hz)
4	802.11ax HE160 (61.3Mbps) , From System (120V/60Hz)
caused "Test Mode 1~4" generated the worst case, they were reported as the final data.	

Note:

- 1. There are two kinds of test voltage: AC 120V / 60Hz and AC 240V / 60Hz.  
 For AC Power Line Conducted Emission, AC 120V / 60Hz is worst case.  
 For Radiated Spurious Emission(Below 1GHz), AC 120V / 60Hz is worst case.  
 For Radiated Spurious Emission(1GHz ~ 40GHz), AC 120V / 60Hz is worst case.
- 2. There are evaluation tests with and without USB cradle, with USB cradle is worst case.





### 2.4. Description of Test System

RF Conducted				
Equipment	Brand	Model	Length/Type	Power cord/Length/Type
Notebook	lenovo	S1GL2W	N/A	Adapter / 1.8m / NS
Radiated Emissions				
Equipment	Brand	Model	Length/Type	Power cord/Length/Type
Notebook	lenovo	S1GL2W	N/A	Adapter / 1.8m / NS
AC Power Line Conducted Emission				
Equipment	Brand	Model	Length/Type	Power cord/Length/Type
Notebook	ASUS	P2430U	N/A	Adapter / 1.8m / NS
CBP				
Equipment	Brand	Model	Length/Type	Power cord/Length/Type
Notebook	Lenovo	S2292L	N/A	Adapter / 1.8m / NS
RJ45 Cable	TE CONNECTIVITY	CAT5E	1.2m / NS	N/A
Notebook	DELL	Latitude 9420	N/A	Adapter / 1.8m / NS
AP	NETGEAR	RAXE500	N/A	Adapter / 1.5m / NS

**2.5. General Information of Test**

☒ Test Site	CerpPASS Technology Corporation Test Laboratory Address: No.10, Ln. 2, Lianfu St., Luzhu Dist., Taoyuan City 33848, Taiwan (R.O.C.) Tel: +886-3-3226-888 Fax: +886-3-3226-881	
	FCC	TW1439, TW1079
	IC	4934E-1, 4934E-2
Frequency Range Investigated	Conducted: from 150kHz to 30 MHz Radiation: from 30 MHz to 40,000MHz	
Test Distance	The test distance of radiated emission from antenna to EUT is 3 M.	

Test Item	Test Site	Test period	Environmental Conditions	Tested By
RF Conducted	RFCON01-NK	2023/8/8~2023/9/16	24.4~26.7°C / 42~52%	Leon Huang
RF Conducted	RFCON01-NK	2023/09/28	26.2°C / 46%	Leon Huang
Radiated Emissions	3M02-NK	2023/7/29~2023/8/31	22~26°C / 43~66%	Leon Huang
AC Power Line Conducted Emission	CON02-NK	2023/07/24	26°C / 59%	Leon Huang
CBP	RFDFS01-NK	2023/9/18~2023/9/20	24.9~26.7°C / 47~49%	Dian Chen



## 2.6. Measurement Uncertainty

ISO/IEC 17025 requires that an estimate of the measurement uncertainties associated with the emissions test results be included in the report. The measurement uncertainties given below are based on a 95% confidence level (based on a coverage factor (k=2))

Measurement Item	Uncertainty
AC Power Line Conduction(150K~30MHz)	±3.28dB
Radiated Spurious Emission(9KHz~30MHz)	±3.5dB
Radiated Spurious Emission(30MHz~1GHz)	±5.1dB
Radiated Spurious Emission(1GHz~40GHz)	±5.2dB
6dB Bandwidth	±5.4%
26dB Bandwidth	±4.4%
Occupied Bandwidth	±4.5%
Peak Output Power(Conducted Power Meter)	±1.1dB
Power Spectral Density	±2.0dB
Duty Cycle	±3.5%
Frequency Stability	±0.23KHz



### 3. Test Equipment and Ancillaries Used for Tests

Test Item	Radiated Emissions				
Test Site	Semi Anechoic Room(3M02-NK)				
Instrument	Manufacturer	Model No	Serial No	Calibration Date	Valid Date
Bilog Antenna	Schwarzbeck	VULB9168	275	2022/11/18	2023/11/17
Active Loop Antenna	Schwarzbeck	FMZB 1513	414	2023/02/03	2024/02/02
Horn Antenna	EMCO	3115	31589	2023/03/23	2024/03/22
Horn Antenna	EMCO	3116	31970	2023/03/03	2024/03/02
EMI Receiver	ROHDE & SCHWARZ	ESCI	101423	2023/07/05	2024/07/04
Spectrum Analyzer	ROHDE & SCHWARZ	FSP 40	100047	2023/02/24	2024/02/23
Preamplifier	Agilent	8449B	3008A01954	2023/03/08	2024/03/07
Preamplifier	EMC INSTRUMENTS	EMC184045	980065	2022/11/11	2023/11/10
Preamplifier	EM Electronics corp.	EM330	60658	2022/10/04	2023/10/03
Cable-6m(9k~300M)	NA	EMC5D-BM-BM-6	130606	2023/03/13	2024/03/12
Cable-3in1(30M-1G)	HARBOUR INDUSTRIES	LL142	CCE1315	2023/02/25	2024/02/24
Cable-0.5m(1G-40G)	HUBER SUHNER	SUCOFLEX 104	805443/4	2023/03/07	2024/03/06
Cable-3m(1G-40G)	HUBER SUHNER	SUCOFLEX 104	805796/4	2023/03/07	2024/03/06
Cable-8m(1G-26.5G)	WOKEN	WCBA-WCA203SM	CCE1374	2023/03/07	2024/03/06
Cable-0.5m(30M-40G)	HUBER SUHNER	SUCOFLEX 102	28420/2	2023/03/07	2024/03/06
Cable-3m(10M-40G)	HUBER SUHNER	SF102	804619/2	2022/10/11	2023/10/10
E3	AUDIX	v8.2014-8-6	RK-000529	NA	NA
Notch Filter	Warison	WFIL-N5925-7125F-04	WRQ4BFWC4M1	2023/03/13	2024/03/12

Test Item	RF Conducted				
Test Site	RFCON01-NK				
Instrument	Manufacturer	Model No	Serial No	Calibration Date	Valid Date
CAX Signal Analyzer	KEYSIGHT	N9000B	MY57100339	2022/11/29	2023/11/28
Power Meter	Anritsu	ML2495A	1224005	2023/03/07	2024/03/06
Power Sensor	Anritsu	MA2411B	1207295	2023/03/07	2024/03/06
Attenuator	KEYSIGHT	8491B	MY39250703	2023/03/08	2024/03/07



<b>Test Item</b>	AC Power Line Conducted Emission				
<b>Test Site</b>	CON02-NK				
<b>Instrument</b>	<b>Manufacturer</b>	<b>Model No</b>	<b>Serial No</b>	<b>Calibration Date</b>	<b>Valid Date</b>
EMI Receiver	ROHDE & SCHWARZ	ESCI	101423	2023/07/05	2024/07/04
TWO-LINE V-NETWORK	ROHDE & SCHWARZ	ENV216	102185	2022/08/24	2023/08/23
Cable-4m(9k-3G)	EMEC	RG-223	18274M	2022/07/27	2023/07/26
E3	AUDIX	v8.2014-8-6	RK-000536	NA	NA

<b>Test Item</b>	CBP				
<b>Test Site</b>	RFDFS01-NK				
<b>Instrument</b>	<b>Manufacturer</b>	<b>Model No</b>	<b>Serial No</b>	<b>Calibration Date</b>	<b>Valid Date</b>
CAX Signal Analyzer	KEYSIGHT	N9000B	MY57100339	2022/11/29	2023/11/28
MXG-B RF Vector Signal Generator + Frequency Extender	KEYSIGHT	N5182B+N5182BX07	MY53051383+ MY59362519	2023/02/22	2024/02/21
Control BOX	World-pallas	AD222	L4490A	NA	NA
IOT0047A	KEYSIGHT	v22.7.25.15	NA	NA	NA



### 4. Antenna Requirements

#### 4.1. Standard Applicable

For intentional device, according to FCC 47 CFR Section 15.203, an intentional radiator shall be designed to ensure that no antenna other than that furnished by the responsible party shall be used with the device.

And according to FCC 47 CFR Section 15.407 (a), if transmitting antennas of directional gain greater than 6dBi are used, the power shall be reduced by the amount in dB that the directional gain of the antenna exceeds 6dBi.

#### 4.2. Antenna Construction and Directional Gain

Antenna Type	PCB Antenna
Antenna Gain	5925~6400MHz: ANT A: 3.30 dBi, ANT B: 3.20 dBi 6400~6500MHz: ANT A: 3.30 dBi, ANT B: 3.30 dBi 6500~6800MHz: ANT A: 3.90 dBi, ANT B: 3.40 dBi 6900~7125MHz: ANT A: 4.00 dBi, ANT B: 3.50 dBi

5925~6400MHz
For Power directional gain= $G_{ant}= 3.30$ (dBi) For PSD directional gain = $10 \log[(10^{G1/20} + 10^{G2/20} + \dots + 10^{GN/20})^2 / N_{ANT}] = 6.26$ (dBi)
6400~6500MHz
For Power directional gain= $G_{ant}= 3.30$ (dBi) For PSD directional gain = $10 \log[(10^{G1/20} + 10^{G2/20} + \dots + 10^{GN/20})^2 / N_{ANT}] = 6.31$ (dBi)
6500~6800MHz
For Power directional gain= $G_{ant}= 3.90$ (dBi) For PSD directional gain = $10 \log[(10^{G1/20} + 10^{G2/20} + \dots + 10^{GN/20})^2 / N_{ANT}] = 6.66$ (dBi)
6900~7125MHz:
For Power directional gain= $G_{ant}= 4.00$ (dBi) For PSD directional gain = $10 \log[(10^{G1/20} + 10^{G2/20} + \dots + 10^{GN/20})^2 / N_{ANT}] = 6.76$ (dBi)

\*MIMO type: Cyclic Delay Diversity (CDD) mode.



## 5. Test of AC Power Line Conducted Emission

### 5.1. Test Limit

Conducted Emissions were measured from 150 kHz to 30 MHz with a bandwidth of 9 KHz, according to the methods defined in ANSI C63.10-2013. The EUT was placed on a nonmetallic stand in a shielded room 0.8 meters above the ground plane. The interface cables and equipment positioning were varied within limits of reasonable applications to determine the position produced maximum conducted emissions.

Frequency (MHz)	Quasi Peak (dB $\mu$ V)	Average (dB $\mu$ V)
0.15 – 0.5	66-56*	56-46*
0.5 – 5.0	56	46
5.0 – 30.0	60	50

\*Decreases with the logarithm of the frequency.

### 5.2. Test Procedures

- The EUT was placed 0.4 meter from the conducting wall of the shielding room was kept at least 80 centimeters from any other grounded conducting surface.
- Connect EUT to the power mains through a line impedance stabilization network (LISN).
- All the support units are connecting to the other LISN.
- The LISN provides 50 ohm coupling impedance for the measuring instrument.
- The FCC states that a 50 ohm, 50 micro-Henry LISN should be used.
- Both sides of AC line were checked for maximum conducted interference.
- The frequency range from 150 kHz to 30 MHz was searched.
- Set the test-receiver system to Peak Detect Function and Specified Bandwidth with Maximum Hold Mode.



### 5.3. Typical Test Setup

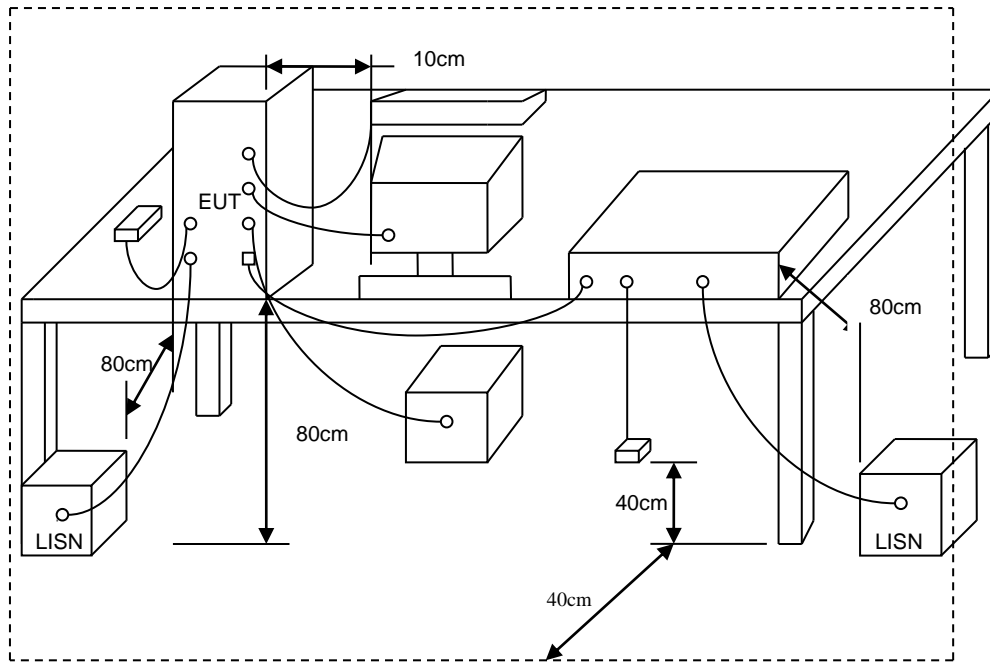





5.4. Test Result and Data

Power	:	From System (AC120V /60Hz)	Pol/Phase	:	LINE
Test Mode	:	Mode 4, CH111		:	

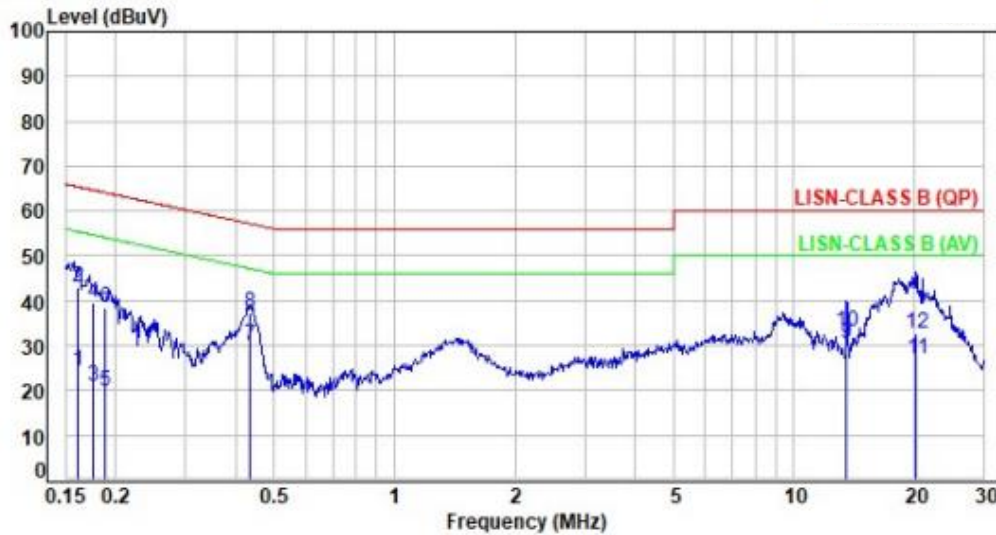

No.	Frequency (MHz)	Factor (dB)	Reading (dBuV)	Level (dBuV)	Limit (dBuV)	Margin (dB)	Detector	P/F
1	0.16	9.62	14.70	24.32	55.38	-31.06	Average	P
2	0.16	9.62	33.25	42.87	65.38	-22.51	QP	P
3	0.18	9.61	11.36	20.97	54.69	-33.72	Average	P
4	0.18	9.61	29.97	39.58	64.69	-25.11	QP	P
5	0.19	9.61	10.31	19.92	54.14	-34.22	Average	P
6	0.19	9.61	28.82	38.43	64.14	-25.71	QP	P
7	0.44	9.63	20.40	30.03	47.14	-17.11	Average	P
8	0.44	9.63	27.63	37.26	57.14	-19.88	QP	P
9	13.56	9.88	20.61	30.49	50.00	-19.51	Average	P
10	13.56	9.88	23.29	33.17	60.00	-26.83	QP	P
11	20.28	9.93	17.02	26.95	50.00	-23.05	Average	P
12	20.28	9.93	22.66	32.59	60.00	-27.41	QP	P

Note: Level=Reading+Factor  
 Margin=Level-Limit  
 Factor=(LISN or ISN or Current Probe)Factor + Cable Loss



Power	: From System (AC120V /60Hz)	Pol/Phase	: NEUTRAL
Test Mode	: Mode 4, CH111		

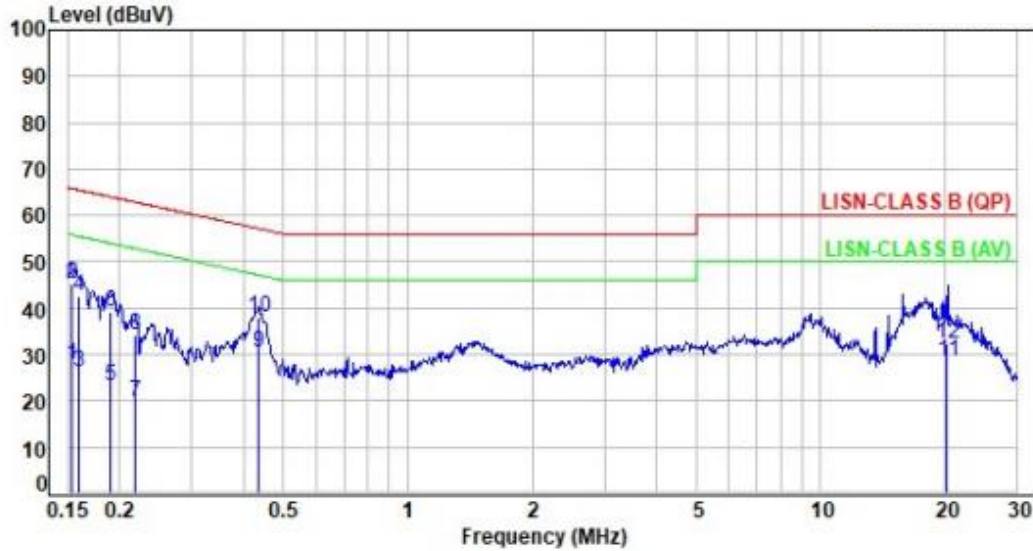

No.	Frequency (MHz)	Factor (dB)	Reading (dBuV)	Level (dBuV)	Limit (dBuV)	Margin (dB)	Detector	P/F
1	0.15	9.63	18.32	27.95	55.85	-27.90	Average	P
2	0.15	9.63	35.52	45.15	65.85	-20.70	QP	P
3	0.16	9.63	16.77	26.40	55.52	-29.12	Average	P
4	0.16	9.63	33.09	42.72	65.52	-22.80	QP	P
5	0.19	9.62	13.57	23.19	54.05	-30.86	Average	P
6	0.19	9.62	29.71	39.33	64.05	-24.72	QP	P
7	0.22	9.62	9.99	19.61	52.86	-33.25	Average	P
8	0.22	9.62	24.64	34.26	62.86	-28.60	QP	P
9	0.43	9.63	20.87	30.50	47.18	-16.68	Average	P
10	0.43	9.63	28.47	38.10	57.18	-19.08	QP	P
11	20.28	9.95	18.68	28.63	50.00	-21.37	Average	P
12	20.28	9.95	22.52	32.47	60.00	-27.53	QP	P

Note: Level=Reading+Factor  
 Margin=Level-Limit  
 Factor=(LISN or ISN or Current Probe)Factor + Cable Loss



### 6. Test of Undesirable Emission (Radiated)

#### 6.1. Test Limit

##### Un-restricted band emissions above 1GHz Limit

Frequency	Limit
Any outside the 5.945 – 7.125 GHz emission	e.i.r.p. -27 dBm [68.2 dBuV/m@3m] Note : -27 dBm EIRP OOBE is measured RMS which is a deviation from the current 15E rules for 5 GHz bands. In addition, 15.35(b) applies where the peak emissions must be limited to no more than 20 dB above the average limit.
5.945 – 7.125 GHz	Emission MASK Limit Power spectral density must be suppressed by 20 dB at 1 MHz outside of channel edge, by 28 dB at one channel bandwidth from the channel center, and by 40 dB at one- and one-half times the channel bandwidth away from channel center. At frequencies between one megahertz outside an unlicensed device's channel edge and one channel bandwidth from the center of the channel, the limits must be linearly interpolated between 20 dB and 28 dB suppression, and at frequencies between one and one- and one-half times an unlicensed device's channel bandwidth, the limits must be linearly interpolated between 28 dB and 40 dB suppression. Emissions removed from the channel center by more than one and one-half times the channel bandwidth must be suppressed by at least 40 dB.

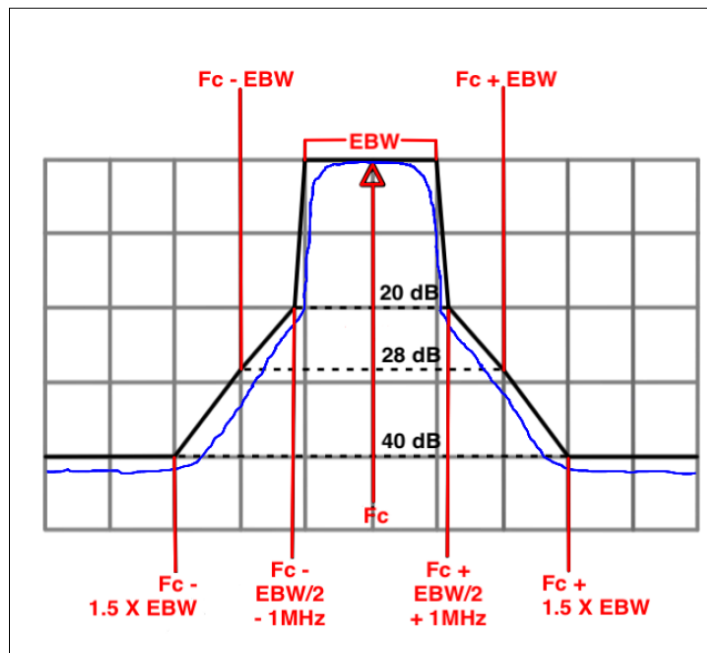



## 6.2. Test Procedures

- a. The EUT was placed on a rotatable table top 0.8 meter above ground.
- b. The EUT was set 3 meters from the interference receiving antenna which was mounted on the top of a variable height antenna tower.
- c. The table was rotated 360 degrees to determine the position of the highest radiation.
- d. The antenna is a broadband antenna and its height is varied between one meter and four meters above ground to find the maximum value of the field strength both horizontal polarization and vertical polarization of the antenna are set to make the measurement.
- e. For each suspected emission the EUT was arranged to its worst case and then tune the antenna tower (from 1 M to 4 M) and turn table (from 0 degree to 360 degrees) to find the maximum reading.
- f. Set the test-receiver system to Peak or CISPR quasi-peak Detect Function and specified bandwidth with Maximum Hold Mode.
- g. If the emission level of the EUT in peak mode was 3 dB lower than the limit specified, then testing will be stopped and peak values of EUT will be reported, otherwise, the emissions which do not have 3 dB margin will be repeated one by one using the quasi-peak method and reported.
- h. For testing above 1GHz, the emission level of the EUT in peak mode was 20dB lower than average limit (that means the emission level in peak mode also complies with the limit in average mode), then testing will be stopped and peak values of EUT will be reported, otherwise, the emissions will be measured in average mode again and reported.
- i. "Cone of radiation" has been considered to be 3dB bandwidth of the measurement antenna.

Note:

- 1.The supporting fixture shall permit orientation of the EUT in each of three orthogonal axis positions such that emissions from the EUT are maximized.  
(Y-AXIS is the worst.)
- 2.Due to the test software function limit the operation band setting(200dBuV/m). There's no corresponding limitation in the actual test item.



### 6.3. Typical Test Setup

Below 30MHz test setup

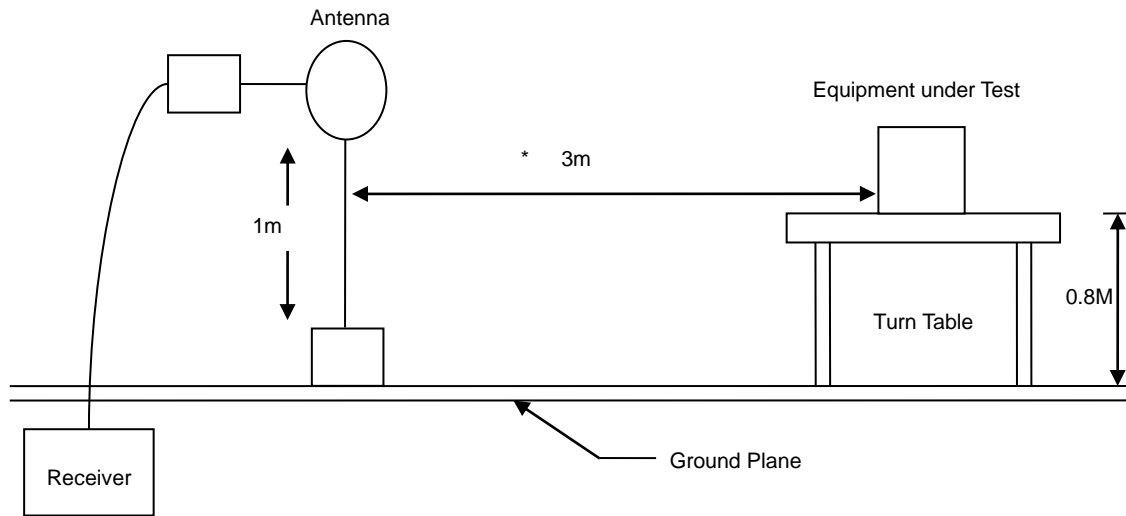

30MHz- 1GHz Test Setup

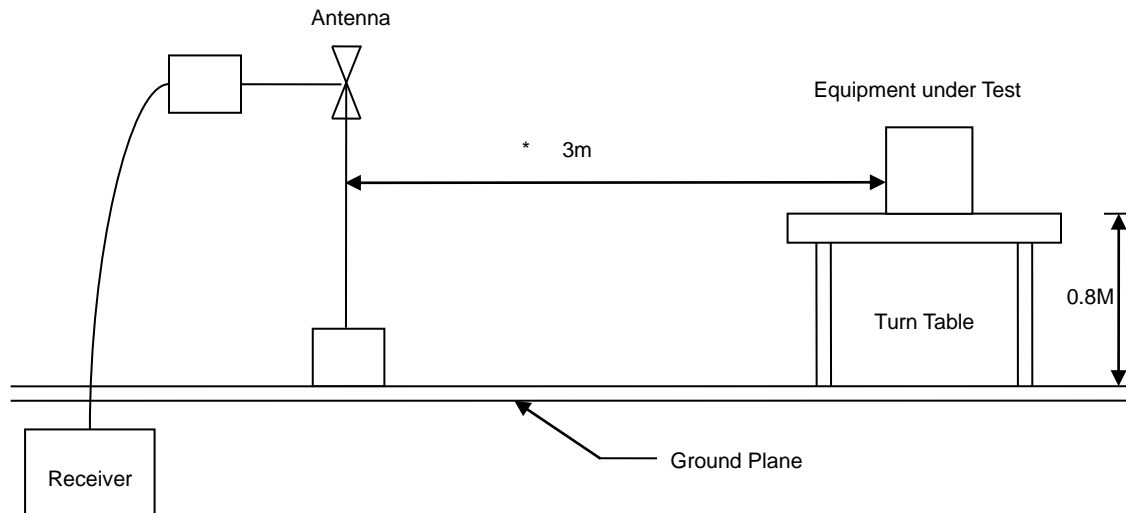

Above 1GHz Test Setup

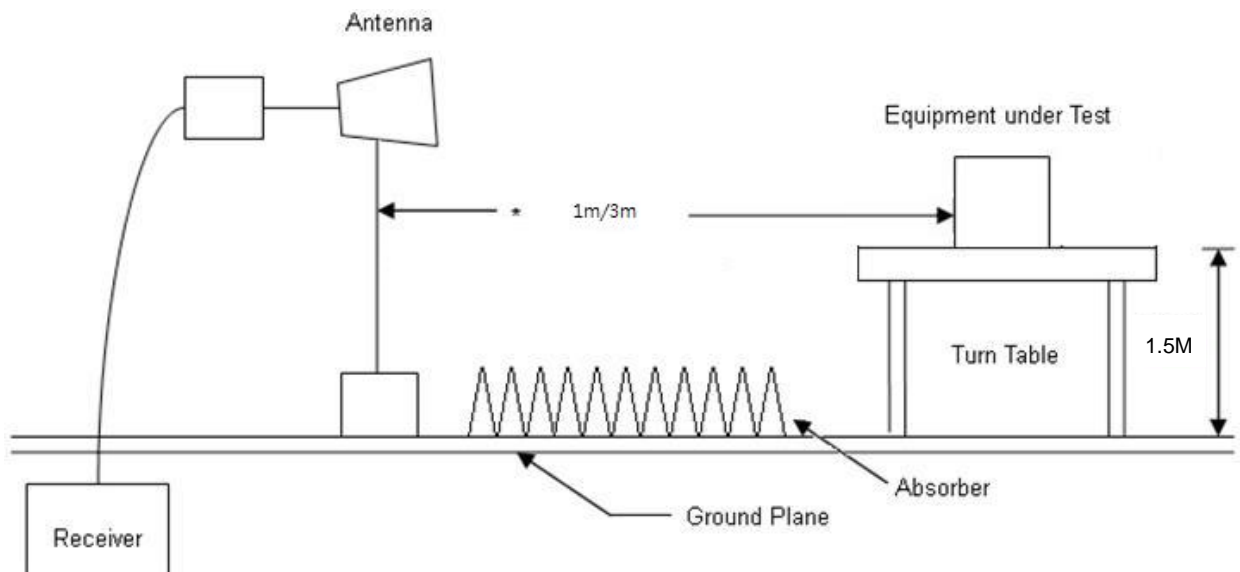



### 6.4. Test Result and Data (9kHz ~ 30MHz)

The 9kHz - 30MHz spurious emission is under limit 20dB more.

### 6.5. Test Result and Data (30MHz ~ 1GHz)

Power	:	From System (AC120V /60Hz)	Pol/Phase	:	VERTICAL
Test Mode	:	Mode 4, CH111		:	

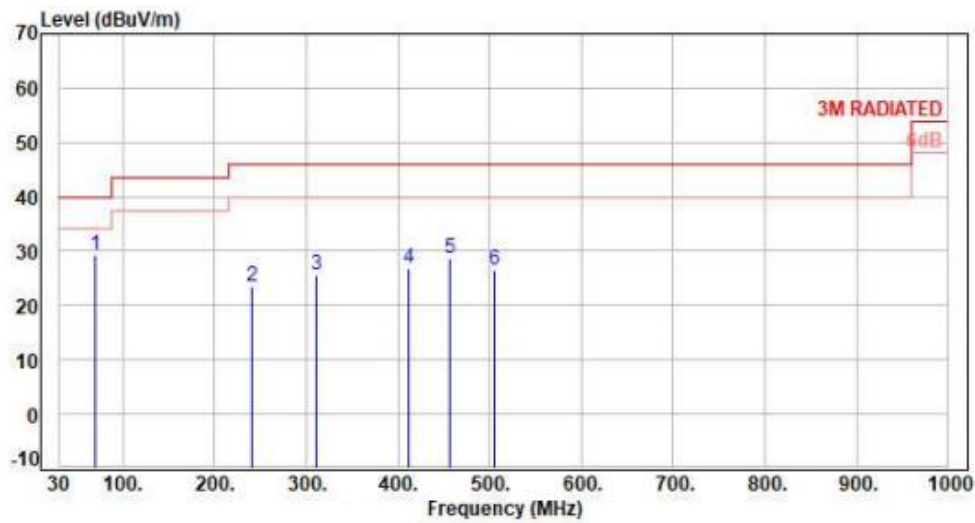

No.	Frequency (MHz)	Factor (dB)	Reading (dBuV)	Level (dBuV/m)	Limit (dBuV/m)	Margin (dB)	Detector	Height (cm)	Azimuth (deg)	P/F
1	70.74	-13.45	42.71	29.26	40.00	-10.74	Peak	100	360	P
2	241.46	-12.41	35.91	23.50	46.00	-22.50	Peak	100	360	P
3	311.30	-9.74	35.18	25.44	46.00	-20.56	Peak	100	360	P
4	412.18	-7.26	34.10	26.84	46.00	-19.16	Peak	100	360	P
5	456.80	-5.85	34.38	28.53	46.00	-17.47	Peak	100	360	P
6	505.30	-4.84	31.43	26.59	46.00	-19.41	Peak	100	360	P

Note: Level=Reading+Factor  
Margin=Level-Limit  
Factor=Antenna Factor + cable loss - Amplifier Factor



Power	:	From System (AC120V /60Hz)	Pol/Phase	:	HORIZONTAL
Test Mode	:	Mode 4, CH111		:	

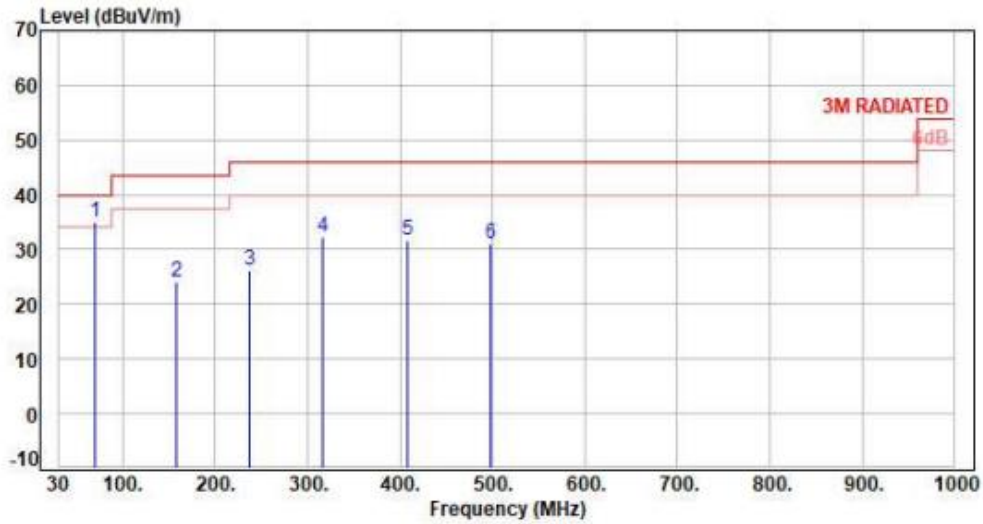

No.	Frequency (MHz)	Factor (dB)	Reading (dBuV)	Level (dBuV/m)	Limit (dBuV/m)	Margin (dB)	Detector	Height (cm)	Azimuth (deg)	P/F
1	70.74	-13.45	48.45	35.00	40.00	-5.00	Peak	400	360	P
2	158.04	-10.77	34.85	24.08	43.50	-19.42	Peak	400	360	P
3	237.58	-12.89	38.95	26.06	46.00	-19.94	Peak	400	360	P
4	317.12	-9.48	41.66	32.18	46.00	-13.82	Peak	400	360	P
5	408.30	-7.39	39.17	31.78	46.00	-14.22	Peak	400	360	P
6	497.54	-5.22	36.26	31.04	46.00	-14.96	Peak	400	360	P

Note: Level=Reading+Factor  
 Margin=Level-Limit  
 Factor=Antenna Factor + cable loss - Amplifier Factor



6.6. Test Result and Data (1GHz ~ 40GHz)

Power	:	From System (AC120V /60Hz)	Pol/Phase	:	VERTICAL
Test Mode	:	Mode 1, Band 5, CH01		:	

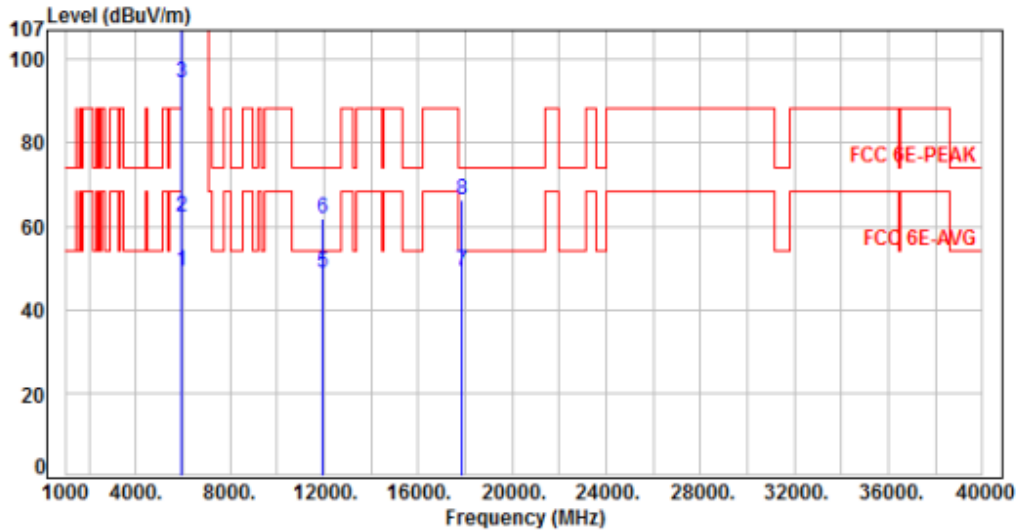

No.	Frequency (MHz)	Factor (dB)	Reading (dBuV)	Level (dBuV/m)	Limit (dBuV/m)	Margin (dB)	Detector	Height (cm)	Azimuth (deg)	P/F
1	5925.00	7.66	41.43	49.09	68.20	-19.11	Average	104	146	P
2	5925.00	7.66	54.52	62.18	88.20	-26.02	Peak	104	146	P
3	5955.00	7.68	86.88	94.56	200.00	-105.44	Average	104	146	P
4	5955.00	7.68	99.16	106.84	200.00	-93.16	Peak	104	146	P
5	11910.00	18.06	30.77	48.83	54.00	-5.17	Average	100	267	P
6	11910.00	18.06	43.60	61.66	74.00	-12.34	Peak	100	267	P
7	17865.00	27.77	21.55	49.32	54.00	-4.68	Average	100	314	P
8	17865.00	27.77	38.34	66.11	74.00	-7.89	Peak	100	314	P

Note: Level=Reading+Factor  
 Margin=Level-Limit  
 Factor=Antenna Factor + cable loss - Amplifier Factor





Power	: From System (AC120V /60Hz)	Pol/Phase	: HORIZONTAL
Test Mode	: Mode 1, Band 5, CH01		:

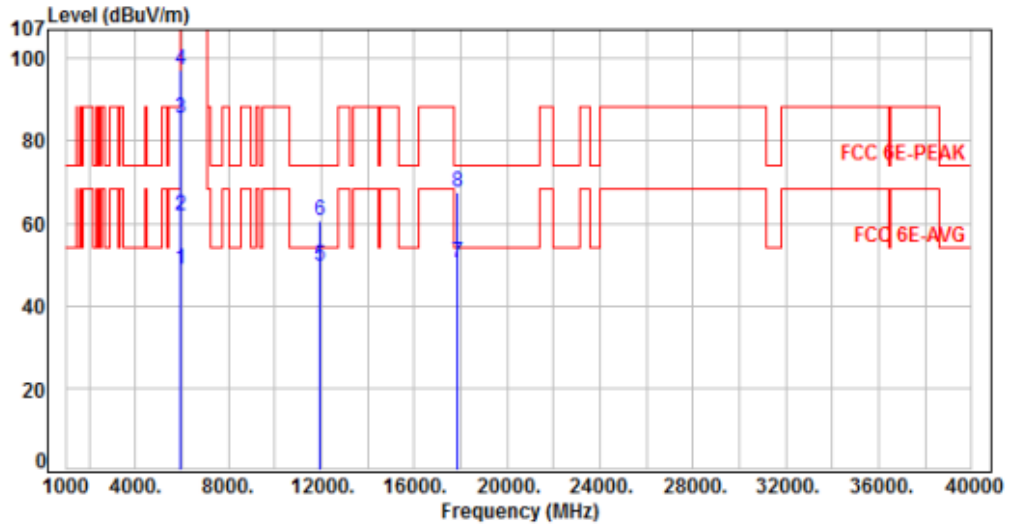

No.	Frequency (MHz)	Factor (dB)	Reading (dBUV)	Level (dBUV/m)	Limit (dBUV/m)	Margin (dB)	Detector	Height (cm)	Azimuth (deg)	P/F
1	5925.00	7.66	41.32	48.98	68.20	-19.22	Average	205	80	P
2	5925.00	7.66	54.26	61.92	88.20	-26.28	Peak	205	80	P
3	5955.00	7.68	77.58	85.26	200.00	-114.74	Average	205	80	P
4	5955.00	7.68	89.71	97.39	200.00	-102.61	Peak	205	80	P
5	11910.00	18.06	31.67	49.73	54.00	-4.27	Average	100	138	P
6	11910.00	18.06	42.68	60.74	74.00	-13.26	Peak	100	138	P
7	17865.00	27.77	22.61	50.38	54.00	-3.62	Average	100	213	P
8	17865.00	27.77	39.57	67.34	74.00	-6.66	Peak	100	213	P

Note: Level=Reading+Factor  
 Margin=Level-Limit  
 Factor=Antenna Factor + cable loss - Amplifier Factor



Power	:	From System (AC120V /60Hz)	Pol/Phase	:	VERTICAL
Test Mode	:	Mode 1, Band 5, CH45		:	

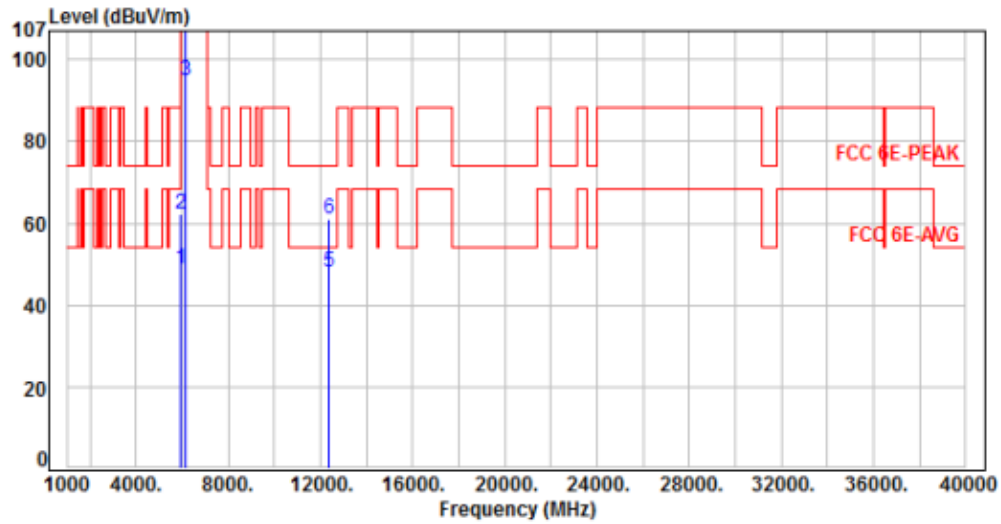

No.	Frequency (MHz)	Factor (dB)	Reading (dBuV)	Level (dBuV/m)	Limit (dBuV/m)	Margin (dB)	Detector	Height (cm)	Azimuth (deg)	P/F
1	5925.00	7.66	41.35	49.01	68.20	-19.19	Average	115	132	P
2	5925.00	7.66	54.42	62.08	88.20	-26.12	Peak	115	132	P
3	6175.00	8.35	86.59	94.94	200.00	-105.06	Average	115	132	P
4	6175.00	8.35	99.02	107.37	200.00	-92.63	Peak	115	132	P
5	12350.00	17.76	30.25	48.01	54.00	-5.99	Average	100	225	P
6	12350.00	17.76	43.11	60.87	74.00	-13.13	Peak	100	225	P

Note: Level=Reading+Factor  
Margin=Level-Limit  
Factor=Antenna Factor + cable loss - Amplifier Factor



Power	:	From System (AC120V /60Hz)	Pol/Phase	:	HORIZONTAL
Test Mode	:	Mode 1, Band 5, CH45		:	

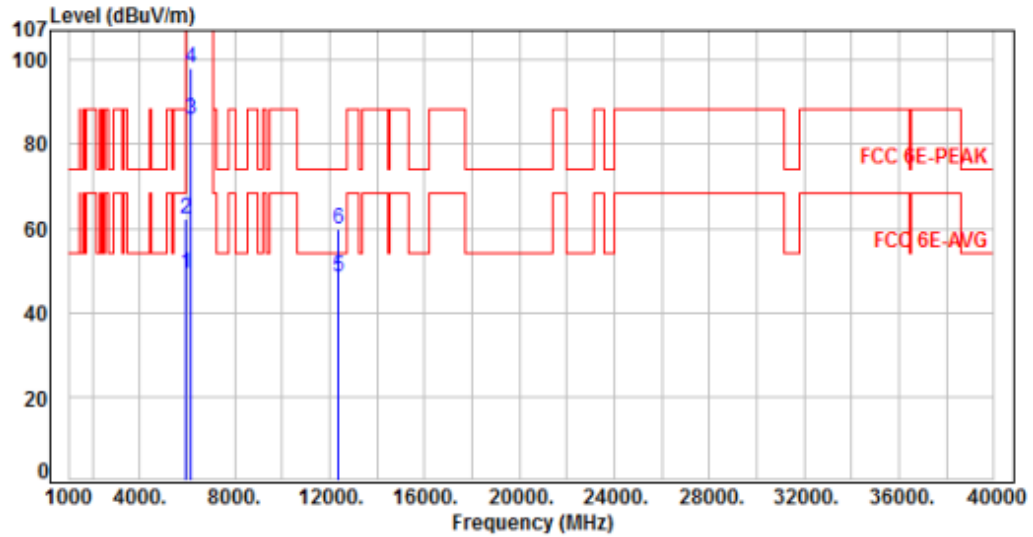

No.	Frequency (MHz)	Factor (dB)	Reading (dBuV)	Level (dBuV/m)	Limit (dBuV/m)	Margin (dB)	Detector	Height (cm)	Azimuth (deg)	P/F
1	5925.00	7.66	41.43	49.09	68.20	-19.11	Average	226	70	P
2	5925.00	7.66	54.51	62.17	88.20	-26.03	Peak	226	70	P
3	6175.00	8.35	77.40	85.75	200.00	-114.25	Average	226	70	P
4	6175.00	8.35	89.65	98.00	200.00	-102.00	Peak	226	70	P
5	12350.00	17.76	30.69	48.45	54.00	-5.55	Average	100	138	P
6	12350.00	17.76	41.93	59.69	74.00	-14.31	Peak	100	138	P

Note: Level=Reading+Factor  
 Margin=Level-Limit  
 Factor=Antenna Factor + cable loss - Amplifier Factor



Power	:	From System (AC120V /60Hz)	Pol/Phase	:	VERTICAL
Test Mode	:	Mode 1, Band 5, CH93		:	

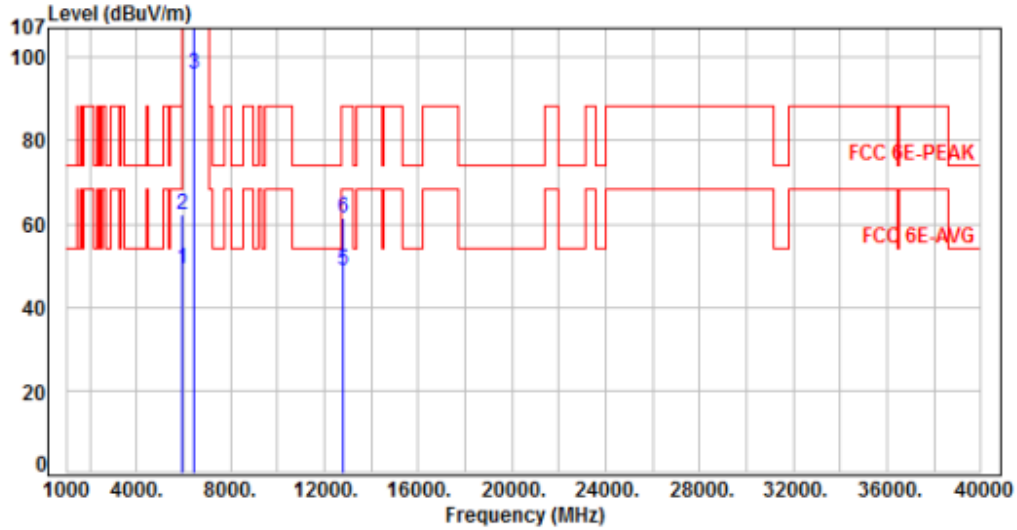

No.	Frequency (MHz)	Factor (dB)	Reading (dBuV)	Level (dBuV/m)	Limit (dBuV/m)	Margin (dB)	Detector	Height (cm)	Azimuth (deg)	P/F
1	5925.00	7.66	41.45	49.11	68.20	-19.09	Average	259	140	P
2	5925.00	7.66	54.70	62.36	88.20	-25.84	Peak	259	140	P
3	6415.00	8.34	87.65	95.99	200.00	-104.01	Average	259	140	P
4	6415.00	8.34	100.05	108.39	200.00	-91.61	Peak	259	140	P
5	12830.00	18.92	29.71	48.63	68.20	-19.57	Average	100	195	P
6	12830.00	18.92	42.36	61.28	88.20	-26.92	Peak	100	195	P

Note: Level=Reading+Factor  
 Margin=Level-Limit  
 Factor=Antenna Factor + cable loss - Amplifier Factor



Power	:	From System (AC120V /60Hz)	Pol/Phase	:	HORIZONTAL
Test Mode	:	Mode 1, Band 5, CH93		:	

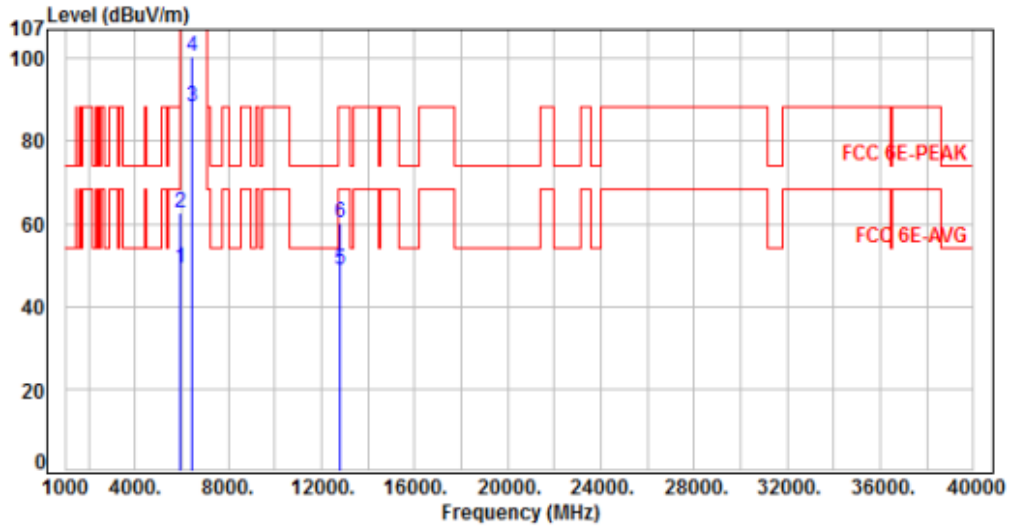

No.	Frequency (MHz)	Factor (dB)	Reading (dBuV)	Level (dBuV/m)	Limit (dBuV/m)	Margin (dB)	Detector	Height (cm)	Azimuth (deg)	P/F
1	5925.00	7.66	41.47	49.13	68.20	-19.07	Average	105	60	P
2	5925.00	7.66	54.99	62.65	88.20	-25.55	Peak	105	60	P
3	6415.00	8.34	79.98	88.32	200.00	-111.68	Average	105	60	P
4	6415.00	8.34	92.25	100.59	200.00	-99.41	Peak	105	60	P
5	12830.00	18.92	29.72	48.64	68.20	-19.56	Average	100	224	P
6	12830.00	18.92	41.18	60.10	88.20	-28.10	Peak	100	224	P

Note: Level=Reading+Factor  
 Margin=Level-Limit  
 Factor=Antenna Factor + cable loss - Amplifier Factor



Power	:	From System (AC120V /60Hz)	Pol/Phase	:	VERTICAL
Test Mode	:	Mode 2, Band 5, CH03		:	

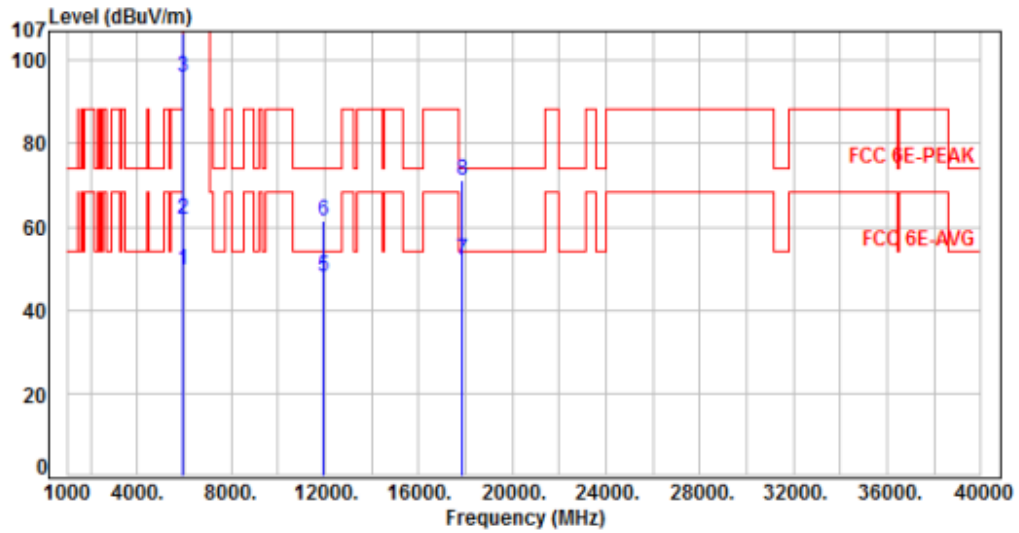

No.	Frequency (MHz)	Factor (dB)	Reading (dBuV)	Level (dBuV/m)	Limit (dBuV/m)	Margin (dB)	Detector	Height (cm)	Azimuth (deg)	P/F
1	5925.00	7.66	41.93	49.59	68.20	-18.61	Average	129	134	P
2	5925.00	7.66	54.30	61.96	88.20	-26.24	Peak	129	134	P
3	5965.00	7.71	88.31	96.02	200.00	-103.98	Average	129	134	P
4	5965.00	7.71	99.07	106.78	200.00	-93.22	Peak	129	134	P
5	11930.00	18.05	29.82	47.87	54.00	-6.13	Average	100	243	P
6	11930.00	18.05	43.42	61.47	74.00	-12.53	Peak	100	243	P
7	17895.00	27.89	24.28	52.17	54.00	-1.83	Average	100	163	P
8	17895.00	27.89	43.30	71.19	74.00	-2.81	Peak	100	163	P

Note: Level=Reading+Factor  
Margin=Level-Limit  
Factor=Antenna Factor + cable loss - Amplifier Factor



Power	:	From System (AC120V /60Hz)	Pol/Phase	:	HORIZONTAL
Test Mode	:	Mode 2, Band 5, CH03		:	

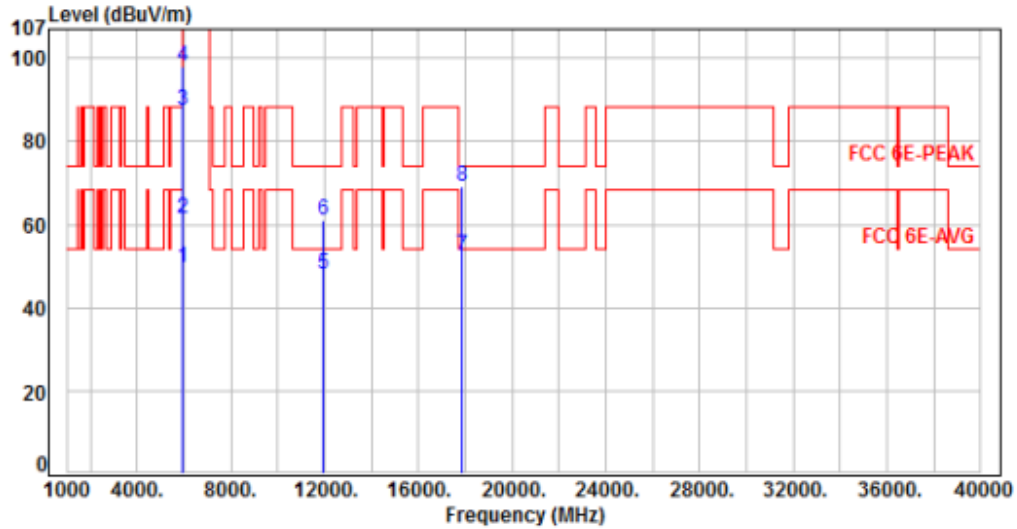

No.	Frequency (MHz)	Factor (dB)	Reading (dBuV)	Level (dBuV/m)	Limit (dBuV/m)	Margin (dB)	Detector	Height (cm)	Azimuth (deg)	P/F
1	5925.00	7.66	41.89	49.55	68.20	-18.65	Average	207	79	P
2	5925.00	7.66	53.83	61.49	88.20	-26.71	Peak	207	79	P
3	5965.00	7.71	79.60	87.31	200.00	-112.69	Average	207	79	P
4	5965.00	7.71	90.30	98.01	200.00	-101.99	Peak	207	79	P
5	11930.00	18.05	29.94	47.99	54.00	-6.01	Average	100	196	P
6	11930.00	18.05	43.00	61.05	74.00	-12.95	Peak	100	196	P
7	17895.00	27.89	24.69	52.58	54.00	-1.42	Average	100	147	P
8	17895.00	27.89	41.25	69.14	74.00	-4.86	Peak	100	147	P

Note: Level=Reading+Factor  
 Margin=Level-Limit  
 Factor=Antenna Factor + cable loss - Amplifier Factor



Power	:	From System (AC120V /60Hz)	Pol/Phase	:	VERTICAL
Test Mode	:	Mode 2, Band 5, CH43		:	

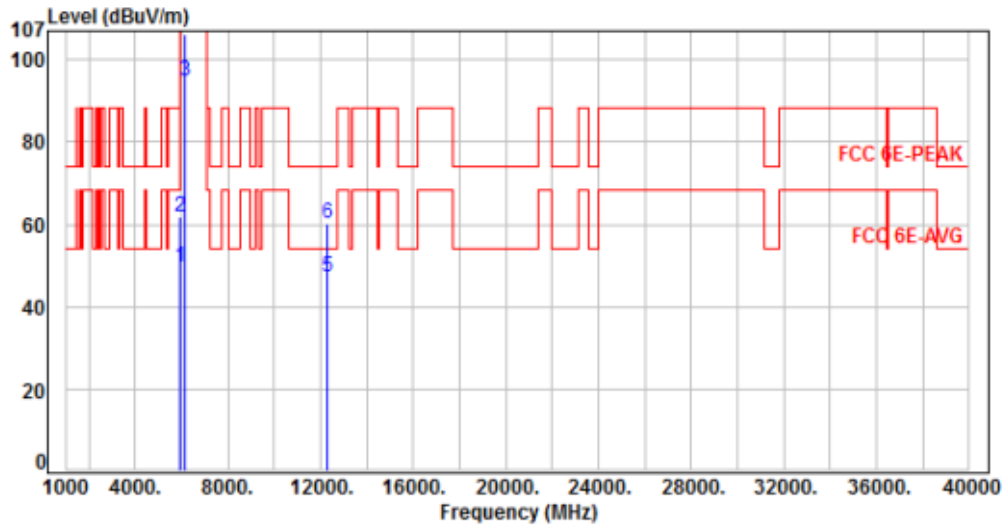

No.	Frequency (MHz)	Factor (dB)	Reading (dBuV)	Level (dBuV/m)	Limit (dBuV/m)	Margin (dB)	Detector	Height (cm)	Azimuth (deg)	P/F
1	5925.00	7.66	41.94	49.60	68.20	-18.60	Average	100	146	P
2	5925.00	7.66	54.11	61.77	88.20	-26.43	Peak	100	146	P
3	6165.00	8.34	86.59	94.93	200.00	-105.07	Average	100	146	P
4	6165.00	8.34	97.97	106.31	200.00	-93.69	Peak	100	146	P
5	12330.00	17.71	29.45	47.16	54.00	-6.84	Average	100	224	P
6	12330.00	17.71	42.69	60.40	74.00	-13.60	Peak	100	224	P

Note: Level=Reading+Factor  
 Margin=Level-Limit  
 Factor=Antenna Factor + cable loss - Amplifier Factor





Power	: From System (AC120V /60Hz)	Pol/Phase	: HORIZONTAL
Test Mode	: Mode 2, Band 5, CH43		:

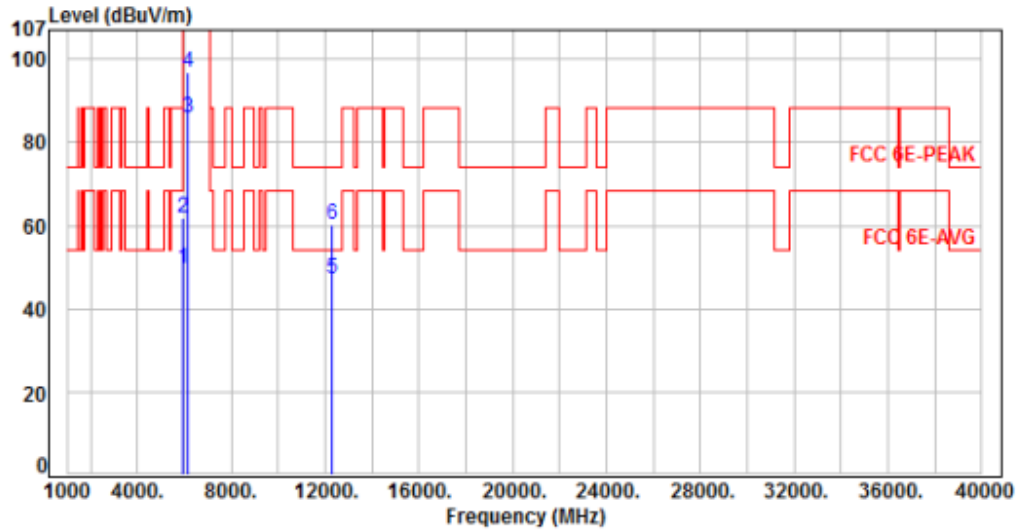

No.	Frequency (MHz)	Factor (dB)	Reading (dBUV)	Level (dBUV/m)	Limit (dBUV/m)	Margin (dB)	Detector	Height (cm)	Azimuth (deg)	P/F
1	5925.00	7.66	41.89	49.55	68.20	-18.65	Average	100	71	P
2	5925.00	7.66	54.23	61.89	88.20	-26.31	Peak	100	71	P
3	6165.00	8.34	77.48	85.82	200.00	-114.18	Average	100	71	P
4	6165.00	8.34	88.37	96.71	200.00	-103.29	Peak	100	71	P
5	12330.00	17.71	29.68	47.39	54.00	-6.61	Average	100	166	P
6	12330.00	17.71	42.50	60.21	74.00	-13.79	Peak	100	166	P

Note: Level=Reading+Factor  
 Margin=Level-Limit  
 Factor=Antenna Factor + cable loss - Amplifier Factor



Power	:	From System (AC120V /60Hz)	Pol/Phase	:	VERTICAL
Test Mode	:	Mode 2, Band 5, CH91		:	

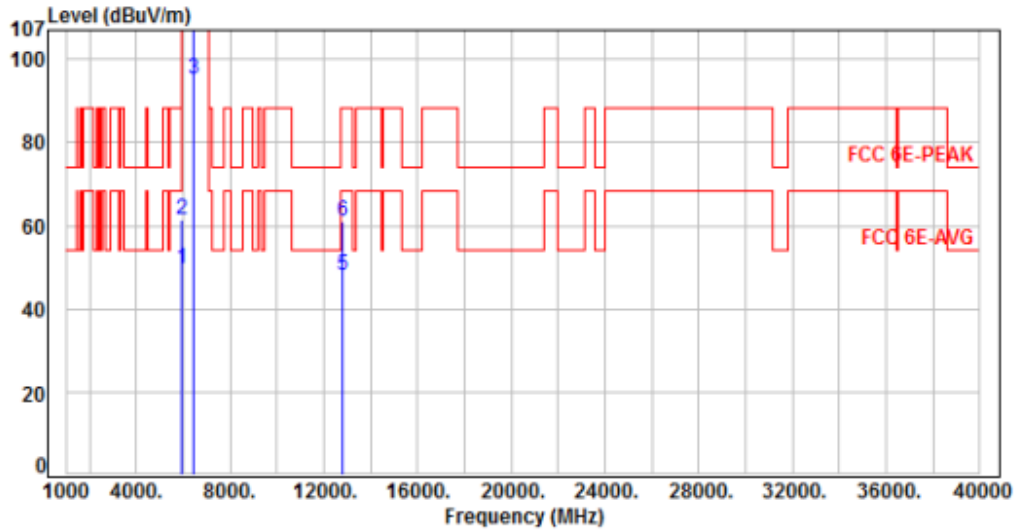

No.	Frequency (MHz)	Factor (dB)	Reading (dBuV)	Level (dBuV/m)	Limit (dBuV/m)	Margin (dB)	Detector	Height (cm)	Azimuth (deg)	P/F
1	5925.00	7.66	42.02	49.68	68.20	-18.52	Average	100	138	P
2	5925.00	7.66	53.93	61.59	88.20	-26.61	Peak	100	138	P
3	6405.00	8.35	86.86	95.21	200.00	-104.79	Average	100	138	P
4	6405.00	8.35	99.02	107.37	200.00	-92.63	Peak	100	138	P
5	12810.00	18.88	29.04	47.92	68.20	-20.28	Average	100	317	P
6	12810.00	18.88	42.09	60.97	88.20	-27.23	Peak	100	317	P

Note: Level=Reading+Factor  
 Margin=Level-Limit  
 Factor=Antenna Factor + cable loss - Amplifier Factor



Power	:	From System (AC120V /60Hz)	Pol/Phase	:	HORIZONTAL
Test Mode	:	Mode 2, Band 5, CH91		:	

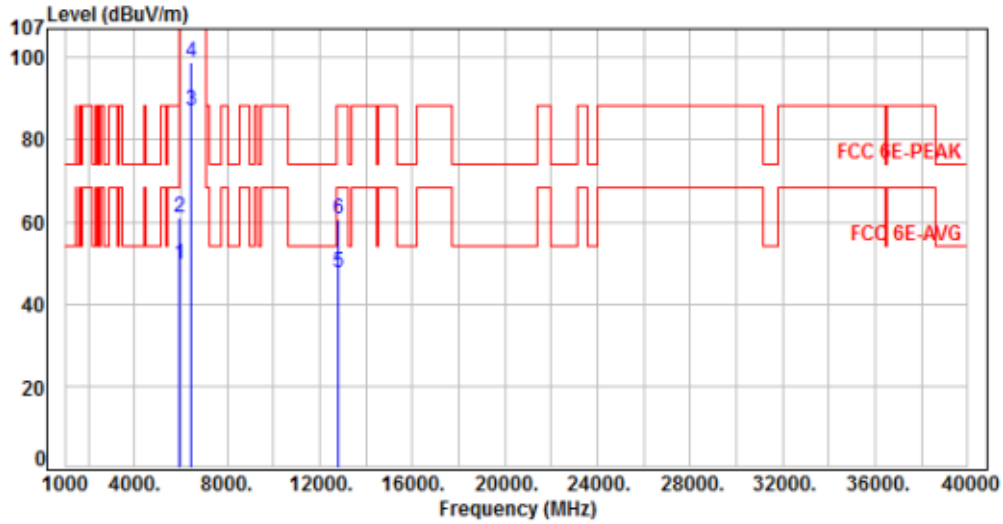

No.	Frequency (MHz)	Factor (dB)	Reading (dBuV)	Level (dBuV/m)	Limit (dBuV/m)	Margin (dB)	Detector	Height (cm)	Azimuth (deg)	P/F
1	5925.00	7.66	41.82	49.48	68.20	-18.72	Average	100	60	P
2	5925.00	7.66	53.45	61.11	88.20	-27.09	Peak	100	60	P
3	6405.00	8.35	78.81	87.16	200.00	-112.84	Average	100	60	P
4	6405.00	8.35	90.57	98.92	200.00	-101.08	Peak	100	60	P
5	12810.00	18.88	28.87	47.75	68.20	-20.45	Average	100	213	P
6	12810.00	18.88	41.90	60.78	88.20	-27.42	Peak	100	213	P

Note: Level=Reading+Factor  
 Margin=Level-Limit  
 Factor=Antenna Factor + cable loss - Amplifier Factor



Power	: From System (AC120V /60Hz)	Pol/Phase	: VERTICAL
Test Mode	: Mode 3, Band 5, CH07		

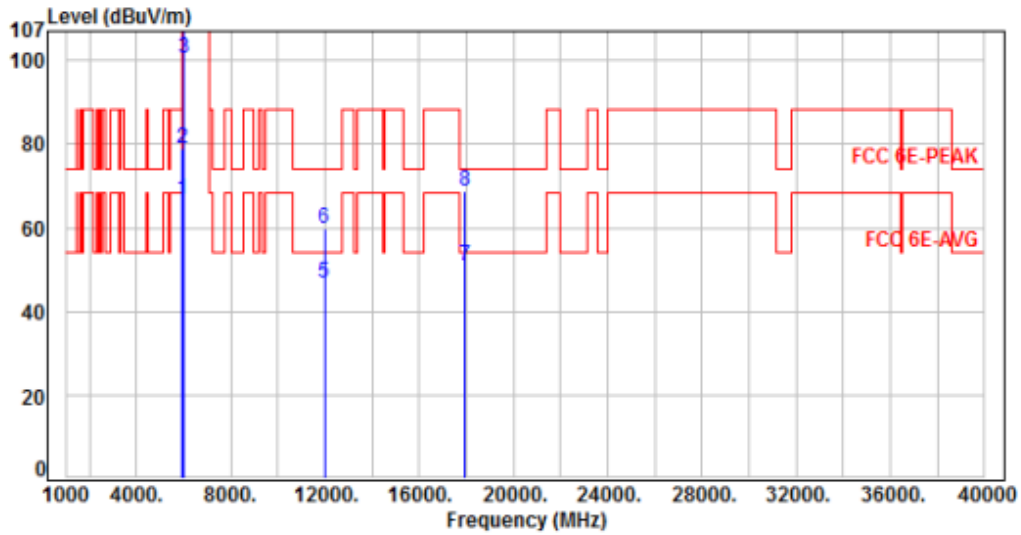

No.	Frequency (MHz)	Factor (dB)	Reading (dBuV)	Level (dBuV/m)	Limit (dBuV/m)	Margin (dB)	Detector	Height (cm)	Azimuth (deg)	P/F
1	5925.00	7.66	59.08	66.74	68.20	-1.46	Average	100	147	P
2	5925.00	7.66	71.32	78.98	88.20	-9.22	Peak	100	147	P
3	5985.00	7.75	92.62	100.37	200.00	-99.63	Average	100	147	P
4	5985.00	7.75	103.48	111.23	200.00	-88.77	Peak	100	147	P
5	11970.00	18.02	28.84	46.86	54.00	-7.14	Average	100	314	P
6	11970.00	18.02	41.90	59.92	74.00	-14.08	Peak	100	314	P
7	17955.00	28.04	22.63	50.67	54.00	-3.33	Average	100	142	P
8	17955.00	28.04	40.87	68.91	74.00	-5.09	Peak	100	142	P

Note: Level=Reading+Factor  
 Margin=Level-Limit  
 Factor=Antenna Factor + cable loss - Amplifier Factor



Power	:	From System (AC120V /60Hz)	Pol/Phase	:	HORIZONTAL
Test Mode	:	Mode 3, Band 5, CH07		:	

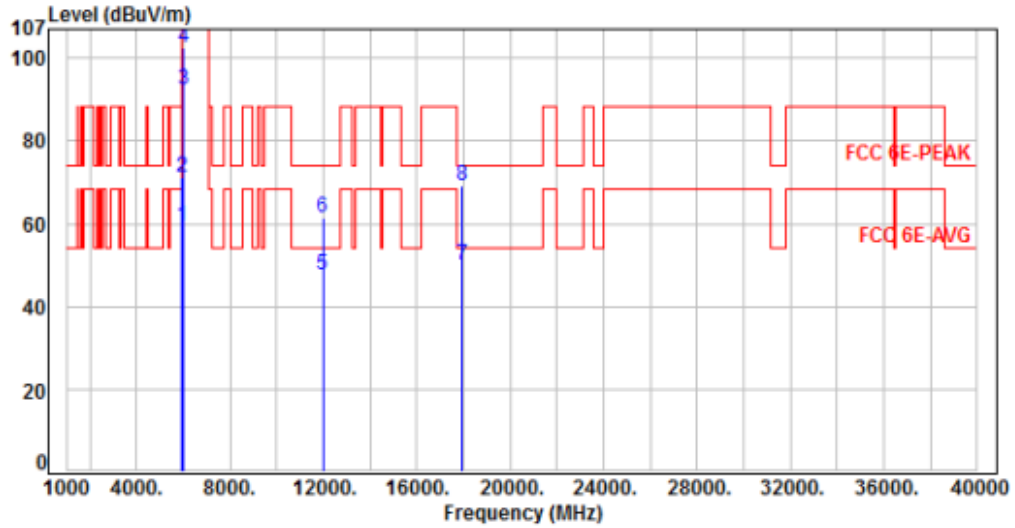

No.	Frequency (MHz)	Factor (dB)	Reading (dBuV)	Level (dBuV/m)	Limit (dBuV/m)	Margin (dB)	Detector	Height (cm)	Azimuth (deg)	P/F
1	5925.00	7.66	51.55	59.21	68.20	-8.99	Average	208	196	P
2	5925.00	7.66	63.39	71.05	88.20	-17.15	Peak	208	196	P
3	5985.00	7.75	84.72	92.47	200.00	-107.53	Average	208	196	P
4	5985.00	7.75	94.81	102.56	200.00	-97.44	Peak	208	196	P
5	11970.00	18.02	29.65	47.67	54.00	-6.33	Average	100	157	P
6	11970.00	18.02	43.32	61.34	74.00	-12.66	Peak	100	157	P
7	17955.00	28.04	21.96	50.00	54.00	-4.00	Average	100	185	P
8	17955.00	28.04	40.95	68.99	74.00	-5.01	Peak	100	185	P

Note: Level=Reading+Factor  
 Margin=Level-Limit  
 Factor=Antenna Factor + cable loss - Amplifier Factor



Power	:	From System (AC120V /60Hz)	Pol/Phase	:	VERTICAL
Test Mode	:	Mode 3, Band 5, CH39		:	

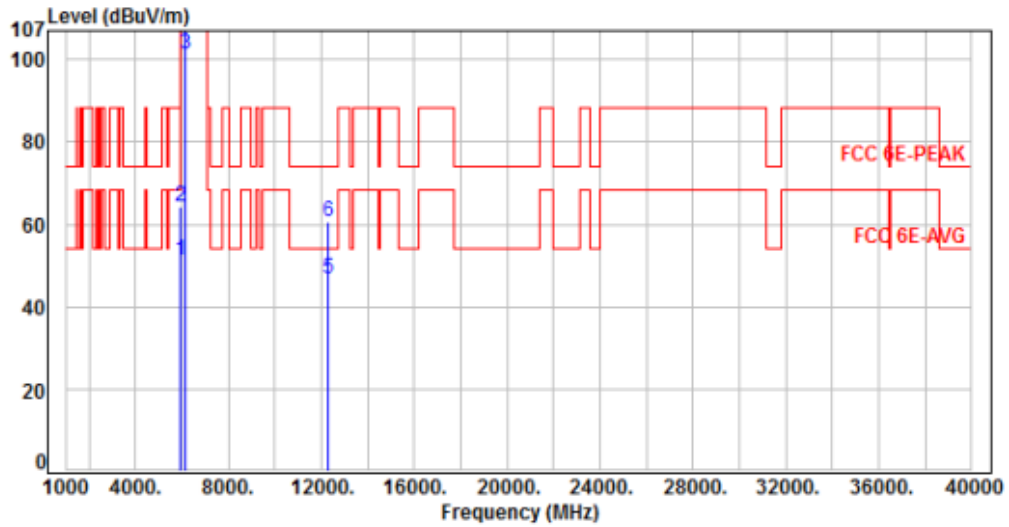

No.	Frequency (MHz)	Factor (dB)	Reading (dBuV)	Level (dBuV/m)	Limit (dBuV/m)	Margin (dB)	Detector	Height (cm)	Azimuth (deg)	P/F
1	5925.00	7.66	43.77	51.43	68.20	-16.77	Average	100	146	P
2	5925.00	7.66	56.53	64.19	88.20	-24.01	Peak	100	146	P
3	6145.00	8.31	92.85	101.16	200.00	-98.84	Average	100	146	P
4	6145.00	8.31	103.78	112.09	200.00	-87.91	Peak	100	146	P
5	12290.00	17.62	29.33	46.95	54.00	-7.05	Average	100	94	P
6	12290.00	17.62	42.93	60.55	74.00	-13.45	Peak	100	94	P

Note: Level=Reading+Factor

Margin=Level-Limit

Factor=Antenna Factor + cable loss - Amplifier Factor



Power	:	From System (AC120V /60Hz)	Pol/Phase	:	HORIZONTAL
Test Mode	:	Mode 3, Band 5, CH39		:	

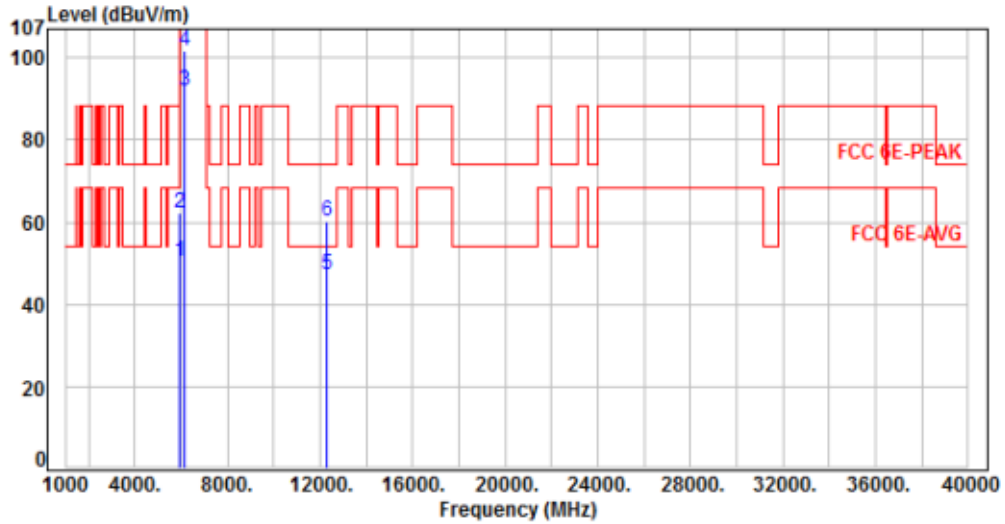

No.	Frequency (MHz)	Factor (dB)	Reading (dBuV)	Level (dBuV/m)	Limit (dBuV/m)	Margin (dB)	Detector	Height (cm)	Azimuth (deg)	P/F
1	5925.00	7.66	42.71	50.37	68.20	-17.83	Average	100	60	P
2	5925.00	7.66	54.55	62.21	88.20	-25.99	Peak	100	60	P
3	6145.00	8.31	83.66	91.97	200.00	-108.03	Average	100	60	P
4	6145.00	8.31	93.51	101.82	200.00	-98.18	Peak	100	60	P
5	12290.00	17.62	29.70	47.32	54.00	-6.68	Average	100	167	P
6	12290.00	17.62	42.69	60.31	74.00	-13.69	Peak	100	167	P

Note: Level=Reading+Factor  
 Margin=Level-Limit  
 Factor=Antenna Factor + cable loss - Amplifier Factor



Power	: From System (AC120V /60Hz)	Pol/Phase	: VERTICAL
Test Mode	: Mode 3, Band 5, CH87		:

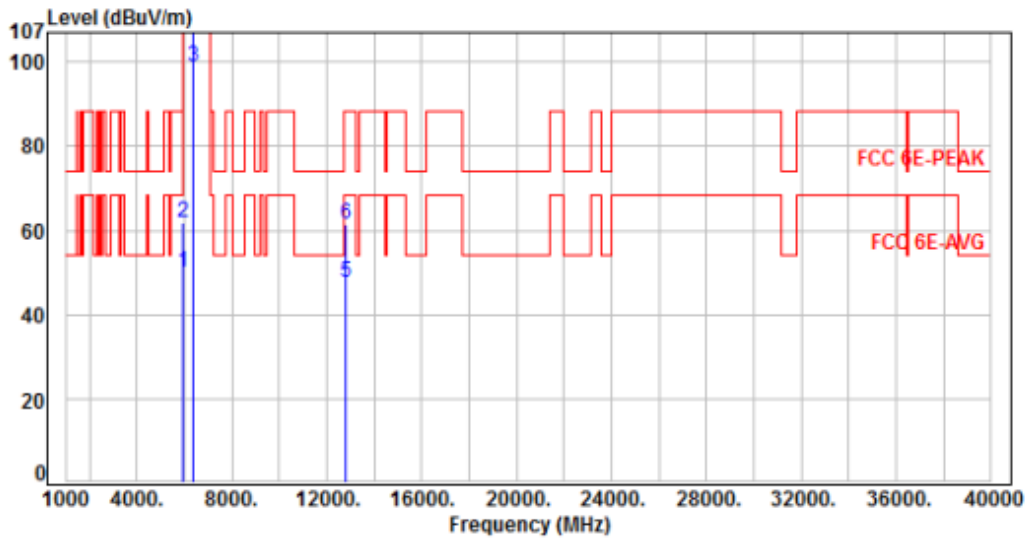

No.	Frequency (MHz)	Factor (dB)	Reading (dBuV)	Level (dBuV/m)	Limit (dBuV/m)	Margin (dB)	Detector	Height (cm)	Azimuth (deg)	P/F
1	5925.00	7.66	42.46	50.12	68.20	-18.08	Average	100	146	P
2	5925.00	7.66	54.02	61.68	88.20	-26.52	Peak	100	146	P
3	6385.00	8.34	90.35	98.69	200.00	-101.31	Average	100	146	P
4	6385.00	8.34	100.98	109.32	200.00	-90.68	Peak	100	146	P
5	12770.00	18.73	28.95	47.68	68.20	-20.52	Average	100	196	P
6	12770.00	18.73	42.58	61.31	88.20	-26.89	Peak	100	196	P

Note: Level=Reading+Factor  
Margin=Level-Limit  
Factor=Antenna Factor + cable loss - Amplifier Factor





Power	: From System (AC120V /60Hz)	Pol/Phase	: HORIZONTAL
Test Mode	: Mode 3, Band 5, CH87		:

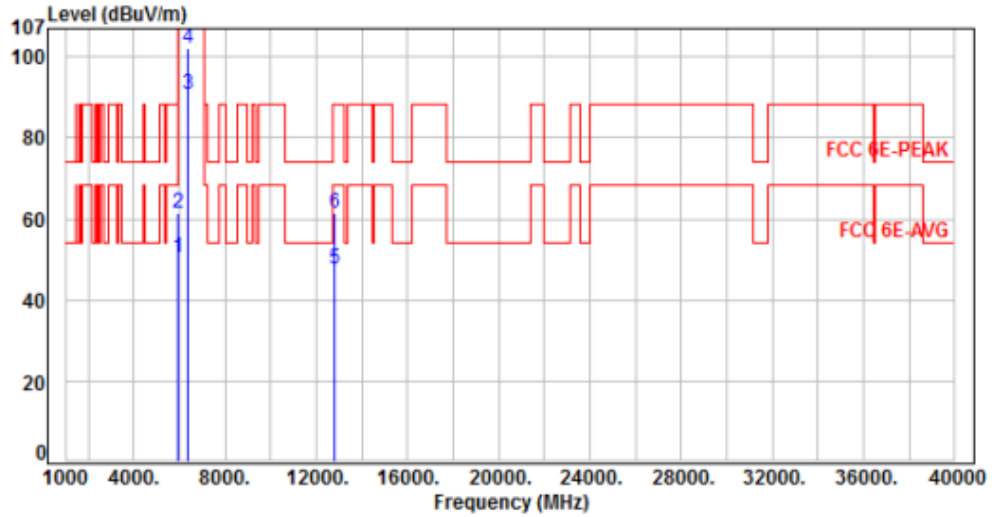

No.	Frequency (MHz)	Factor (dB)	Reading (dBuV)	Level (dBuV/m)	Limit (dBuV/m)	Margin (dB)	Detector	Height (cm)	Azimuth (deg)	P/F
1	5925.00	7.66	42.70	50.36	68.20	-17.84	Average	100	52	P
2	5925.00	7.66	53.75	61.41	88.20	-26.79	Peak	100	52	P
3	6385.00	8.34	82.53	90.87	200.00	-109.13	Average	100	52	P
4	6385.00	8.34	93.58	101.92	200.00	-98.08	Peak	100	52	P
5	12770.00	18.73	28.96	47.69	68.20	-20.51	Average	100	199	P
6	12770.00	18.73	42.69	61.42	88.20	-26.78	Peak	100	199	P

Note: Level=Reading+Factor  
 Margin=Level-Limit  
 Factor=Antenna Factor + cable loss - Amplifier Factor



Power	: From System (AC120V /60Hz)	Pol/Phase	: VERTICAL
Test Mode	: Mode 4, Band 5, CH15		:

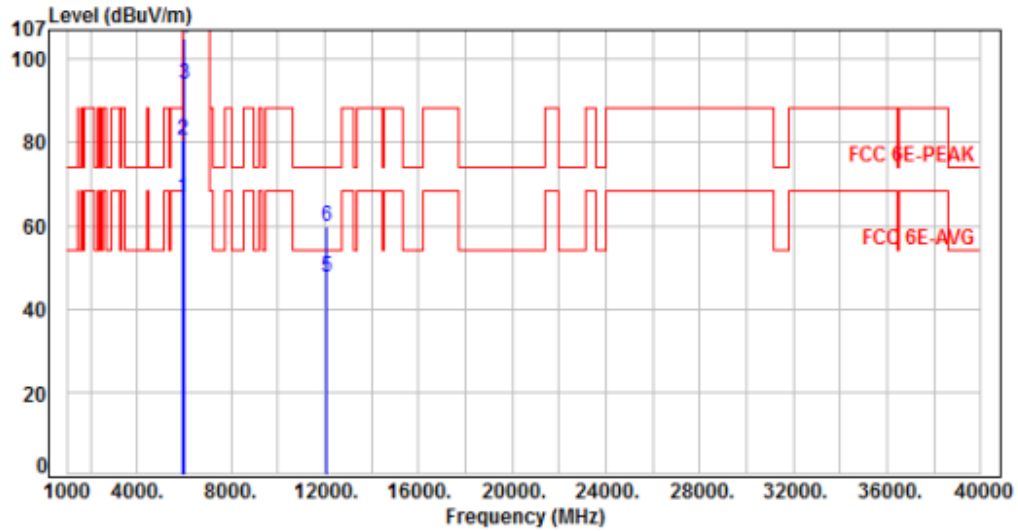

No.	Frequency (MHz)	Factor (dB)	Reading (dBuV)	Level (dBuV/m)	Limit (dBuV/m)	Margin (dB)	Detector	Height (cm)	Azimuth (deg)	P/F
1	5925.00	7.66	59.07	66.73	68.20	-1.47	Average	100	149	P
2	5925.00	7.66	72.99	80.65	88.20	-7.55	Peak	100	149	P
3	6025.00	7.91	86.09	94.00	200.00	-106.00	Average	100	149	P
4	6025.00	7.91	97.17	105.08	200.00	-94.92	Peak	100	149	P
5	12050.00	17.81	29.68	47.49	54.00	-6.51	Average	100	196	P
6	12050.00	17.81	42.18	59.99	74.00	-14.01	Peak	100	196	P

Note: Level=Reading+Factor  
 Margin=Level-Limit  
 Factor=Antenna Factor + cable loss - Amplifier Factor



Power	:	From System (AC120V /60Hz)	Pol/Phase	:	HORIZONTAL
Test Mode	:	Mode 4, Band 5, CH15		:	

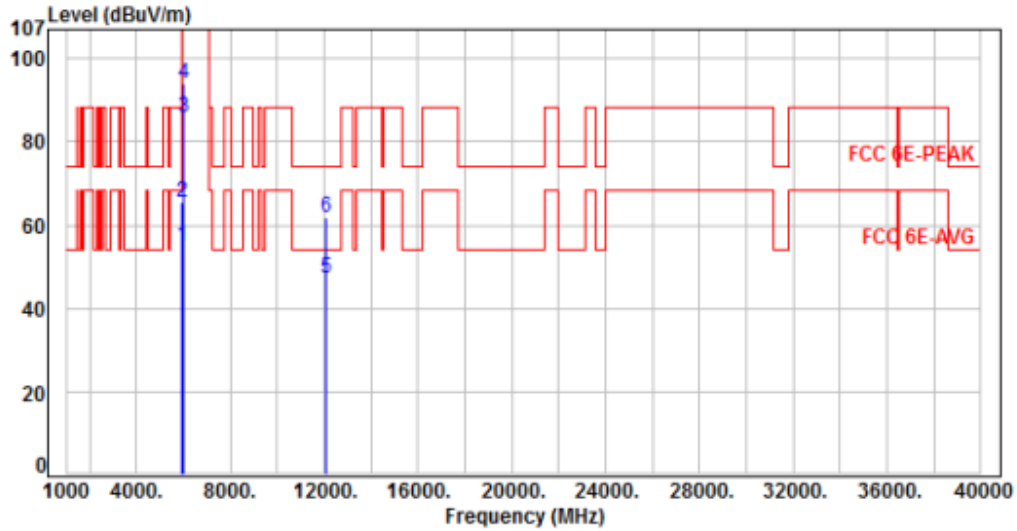

No.	Frequency (MHz)	Factor (dB)	Reading (dBuV)	Level (dBuV/m)	Limit (dBuV/m)	Margin (dB)	Detector	Height (cm)	Azimuth (deg)	P/F
1	5925.00	7.66	47.36	55.02	68.20	-13.18	Average	100	56	P
2	5925.00	7.66	57.94	65.60	88.20	-22.60	Peak	100	56	P
3	6025.00	7.91	77.75	85.66	200.00	-114.34	Average	100	56	P
4	6025.00	7.91	86.21	94.12	200.00	-105.88	Peak	100	56	P
5	12050.00	17.81	29.41	47.22	54.00	-6.78	Average	100	184	P
6	12050.00	17.81	43.95	61.76	74.00	-12.24	Peak	100	184	P

Note: Level=Reading+Factor  
Margin=Level-Limit  
Factor=Antenna Factor + cable loss - Amplifier Factor



Power	:	From System (AC120V /60Hz)	Pol/Phase	:	VERTICAL
Test Mode	:	Mode 4, Band 5, CH47		:	

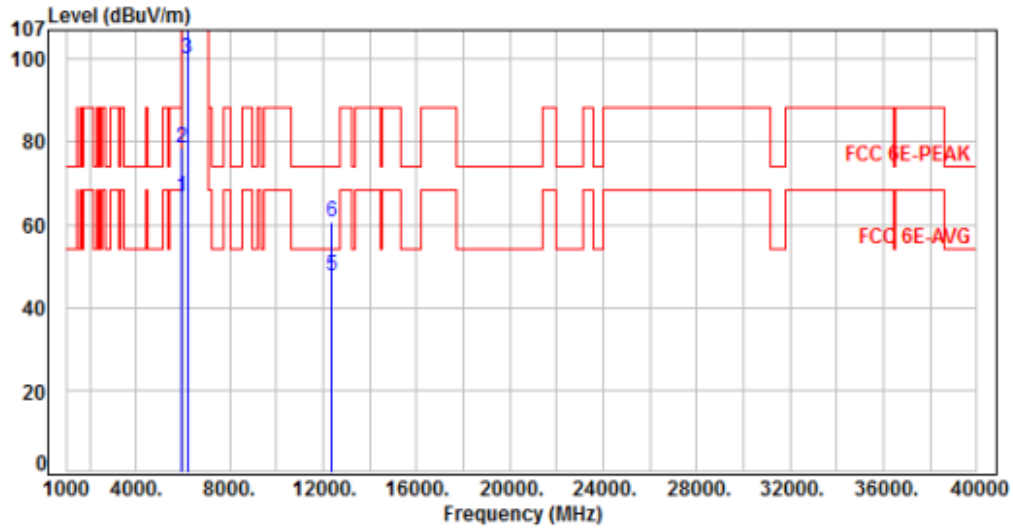

No.	Frequency (MHz)	Factor (dB)	Reading (dBuV)	Level (dBuV/m)	Limit (dBuV/m)	Margin (dB)	Detector	Height (cm)	Azimuth (deg)	P/F
1	5925.00	7.66	59.04	66.70	68.20	-1.50	Average	100	145	P
2	5925.00	7.66	70.96	78.62	88.20	-9.58	Peak	100	145	P
3	6185.00	8.36	91.55	99.91	200.00	-100.09	Average	100	145	P
4	6185.00	8.36	101.84	110.20	200.00	-89.80	Peak	100	145	P
5	12370.00	17.74	29.69	47.43	54.00	-6.57	Average	100	176	P
6	12370.00	17.74	42.96	60.70	74.00	-13.30	Peak	100	176	P

Note: Level=Reading+Factor  
 Margin=Level-Limit  
 Factor=Antenna Factor + cable loss - Amplifier Factor



Power	:	From System (AC120V /60Hz)	Pol/Phase	:	HORIZONTAL
Test Mode	:	Mode 4, Band 5, CH47		:	

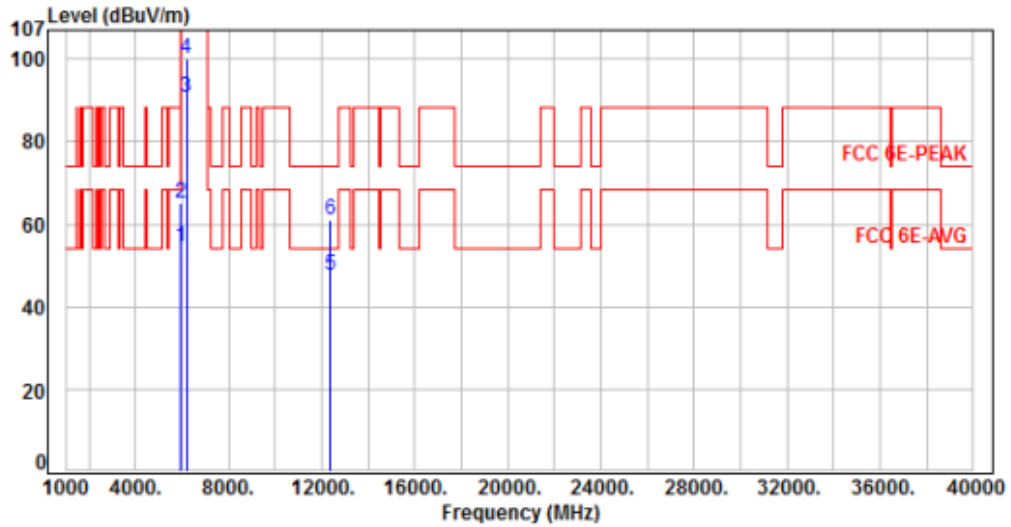

No.	Frequency (MHz)	Factor (dB)	Reading (dBuV)	Level (dBuV/m)	Limit (dBuV/m)	Margin (dB)	Detector	Height (cm)	Azimuth (deg)	P/F
1	5925.00	7.66	47.03	54.69	68.20	-13.51	Average	100	60	P
2	5925.00	7.66	57.47	65.13	88.20	-23.07	Peak	100	60	P
3	6185.00	8.36	82.30	90.66	200.00	-109.34	Average	100	60	P
4	6185.00	8.36	91.59	99.95	200.00	-100.05	Peak	100	60	P
5	12370.00	17.74	29.68	47.42	54.00	-6.58	Average	100	122	P
6	12370.00	17.74	43.09	60.83	74.00	-13.17	Peak	100	122	P

Note: Level=Reading+Factor  
Margin=Level-Limit  
Factor=Antenna Factor + cable loss - Amplifier Factor



Power	:	From System (AC120V /60Hz)	Pol/Phase	:	VERTICAL
Test Mode	:	Mode 4, Band 5, CH79		:	

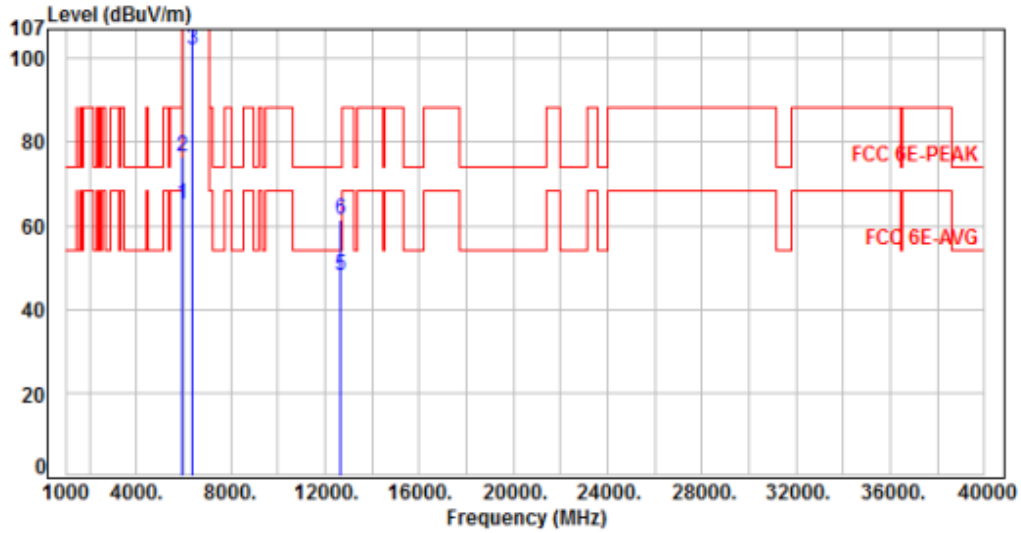

No.	Frequency (MHz)	Factor (dB)	Reading (dBuV)	Level (dBuV/m)	Limit (dBuV/m)	Margin (dB)	Detector	Height (cm)	Azimuth (deg)	P/F
1	5925.00	7.66	57.32	64.98	68.20	-3.22	Average	100	147	P
2	5925.00	7.66	68.94	76.60	88.20	-11.60	Peak	100	147	P
3	6345.00	8.31	93.95	102.26	200.00	-97.74	Average	100	147	P
4	6345.00	8.31	104.02	112.33	200.00	-87.67	Peak	100	147	P
5	12690.00	18.27	29.69	47.96	54.00	-6.04	Average	100	173	P
6	12690.00	18.27	42.96	61.23	74.00	-12.77	Peak	100	173	P

Note: Level=Reading+Factor

Margin=Level-Limit

Factor=Antenna Factor + cable loss - Amplifier Factor



Power	:	From System (AC120V /60Hz)	Pol/Phase	:	HORIZONTAL
Test Mode	:	Mode 4, Band 5, CH79		:	

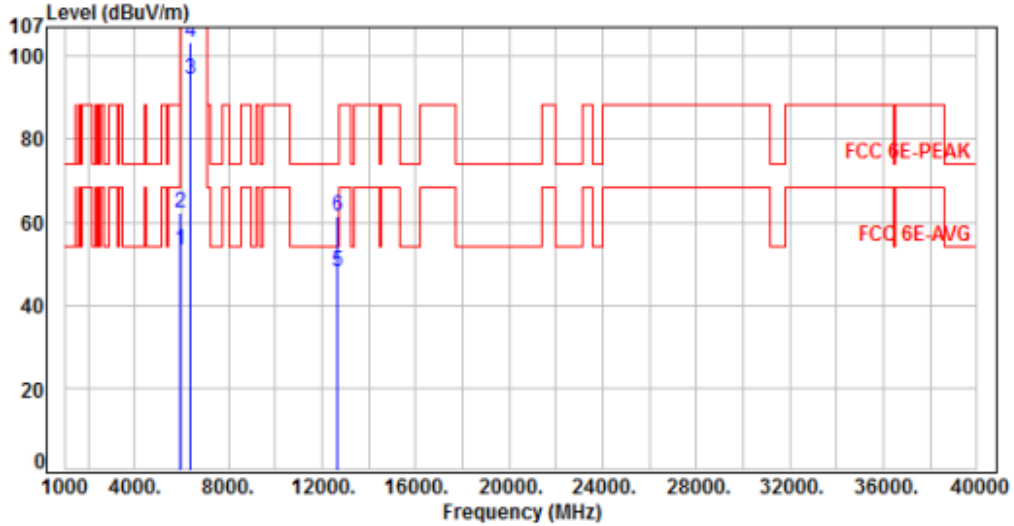

No.	Frequency (MHz)	Factor (dB)	Reading (dBuV)	Level (dBuV/m)	Limit (dBuV/m)	Margin (dB)	Detector	Height (cm)	Azimuth (deg)	P/F
1	5925.00	7.66	45.52	53.18	68.20	-15.02	Average	100	49	P
2	5925.00	7.66	54.75	62.41	88.20	-25.79	Peak	100	49	P
3	6345.00	8.31	85.96	94.27	200.00	-105.73	Average	100	49	P
4	6345.00	8.31	95.16	103.47	200.00	-96.53	Peak	100	49	P
5	12690.00	18.27	29.67	47.94	54.00	-6.06	Average	100	241	P
6	12690.00	18.27	43.08	61.35	74.00	-12.65	Peak	100	241	P

Note: Level=Reading+Factor  
 Margin=Level-Limit  
 Factor=Antenna Factor + cable loss - Amplifier Factor



Power	:	From System (AC120V /60Hz)	Pol/Phase	:	VERTICAL
Test Mode	:	Mode 1, Band 6, CH97		:	

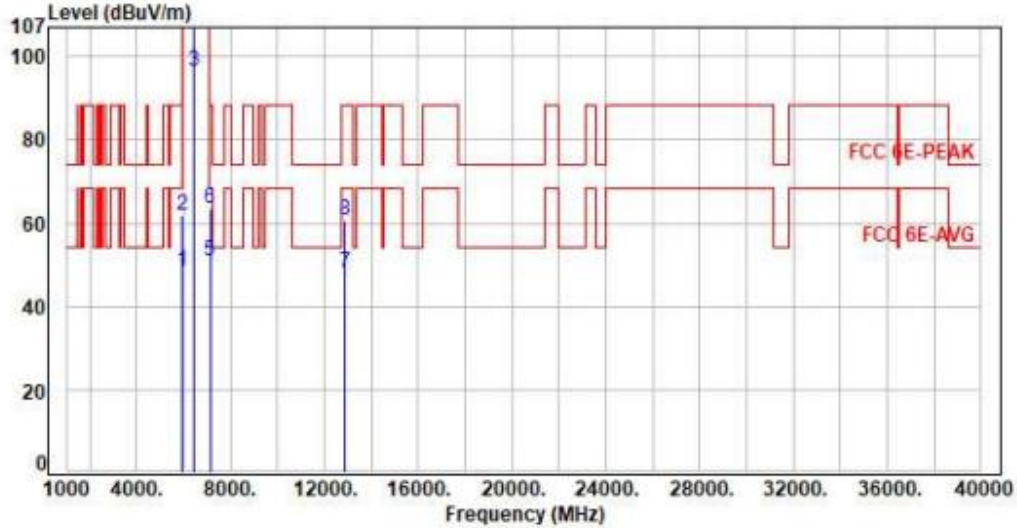

No.	Frequency (MHz)	Factor (dB)	Reading (dBuV)	Level (dBuV/m)	Limit (dBuV/m)	Margin (dB)	Detector	Height (cm)	Azimuth (deg)	P/F
1	5925.00	7.66	40.68	48.34	68.20	-19.86	Average	100	136	P
2	5925.00	7.66	54.35	62.01	88.20	-26.19	Peak	100	136	P
3	6435.00	8.32	88.08	96.40	200.00	-103.60	Average	100	136	P
4	6435.00	8.32	100.36	108.68	200.00	-91.32	Peak	100	136	P
5	7125.00	10.05	40.95	51.00	68.20	-17.20	Average	100	136	P
6	7125.00	10.05	53.33	63.38	88.20	-24.82	Peak	100	136	P
7	12870.00	19.02	28.95	47.97	68.20	-20.23	Average	100	266	P
8	12870.00	19.02	41.62	60.64	88.20	-27.56	Peak	100	266	P

Note: Level=Reading+Factor  
 Margin=Level-Limit  
 Factor=Antenna Factor + cable loss - Amplifier Factor





Power	: From System (AC120V /60Hz)	Pol/Phase	: HORIZONTAL
Test Mode	: Mode 1, Band 6, CH97		:

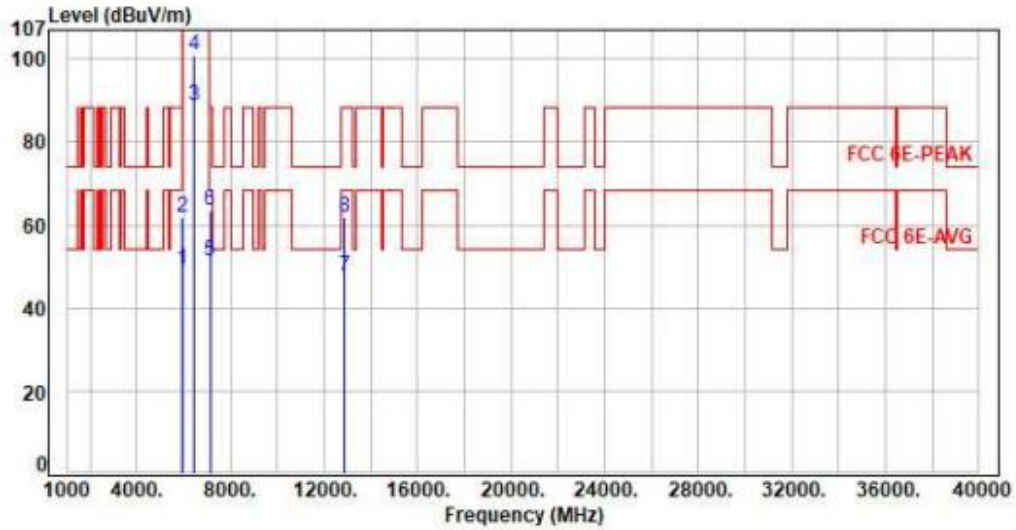

No.	Frequency (MHz)	Factor (dB)	Reading (dBuV)	Level (dBuV/m)	Limit (dBuV/m)	Margin (dB)	Detector	Height (cm)	Azimuth (deg)	P/F
1	5925.00	7.66	41.61	49.27	68.20	-18.93	Average	100	53	P
2	5925.00	7.66	54.16	61.82	88.20	-26.38	Peak	100	53	P
3	6435.00	8.32	80.55	88.87	200.00	-111.13	Average	100	53	P
4	6435.00	8.32	92.64	100.96	200.00	-99.04	Peak	100	53	P
5	7125.00	10.05	41.30	51.35	68.20	-16.85	Average	100	53	P
6	7125.00	10.05	53.48	63.53	88.20	-24.67	Peak	100	53	P
7	12870.00	19.02	28.59	47.61	68.20	-20.59	Average	100	354	P
8	12870.00	19.02	42.63	61.65	88.20	-26.55	Peak	100	354	P

Note: Level=Reading+Factor  
 Margin=Level-Limit  
 Factor=Antenna Factor + cable loss - Amplifier Factor



Power	: From System (AC120V /60Hz)	Pol/Phase	: VERTICAL
Test Mode	: Mode 1, Band 6, CH105		:

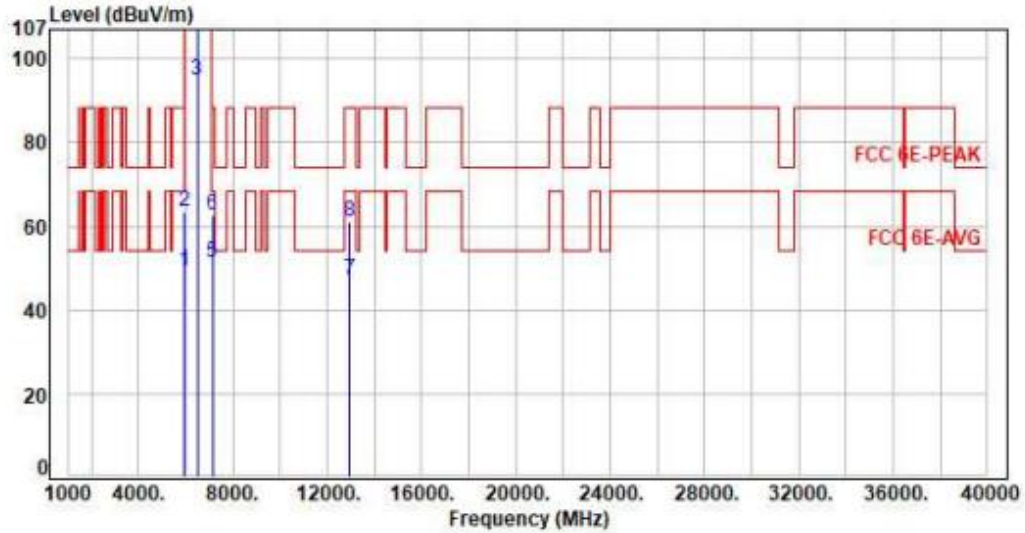

No.	Frequency (MHz)	Factor (dB)	Reading (dBuV)	Level (dBuV/m)	Limit (dBuV/m)	Margin (dB)	Detector	Height (cm)	Azimuth (deg)	P/F
1	5925.00	7.66	41.72	49.38	68.20	-18.82	Average	100	134	P
2	5925.00	7.66	55.72	63.38	88.20	-24.82	Peak	100	134	P
3	6475.00	8.33	86.65	94.98	200.00	-105.02	Average	100	134	P
4	6475.00	8.33	99.03	107.36	200.00	-92.64	Peak	100	134	P
5	7125.00	10.05	41.24	51.29	68.20	-16.91	Average	100	134	P
6	7125.00	10.05	52.81	62.86	88.20	-25.34	Peak	100	134	P
7	12950.00	19.39	27.72	47.11	68.20	-21.09	Average	100	167	P
8	12950.00	19.39	41.65	61.04	88.20	-27.16	Peak	100	167	P

Note: Level=Reading+Factor  
 Margin=Level-Limit  
 Factor=Antenna Factor + cable loss - Amplifier Factor



Power	: From System (AC120V /60Hz)	Pol/Phase	: HORIZONTAL
Test Mode	: Mode 1, Band 6, CH105		:

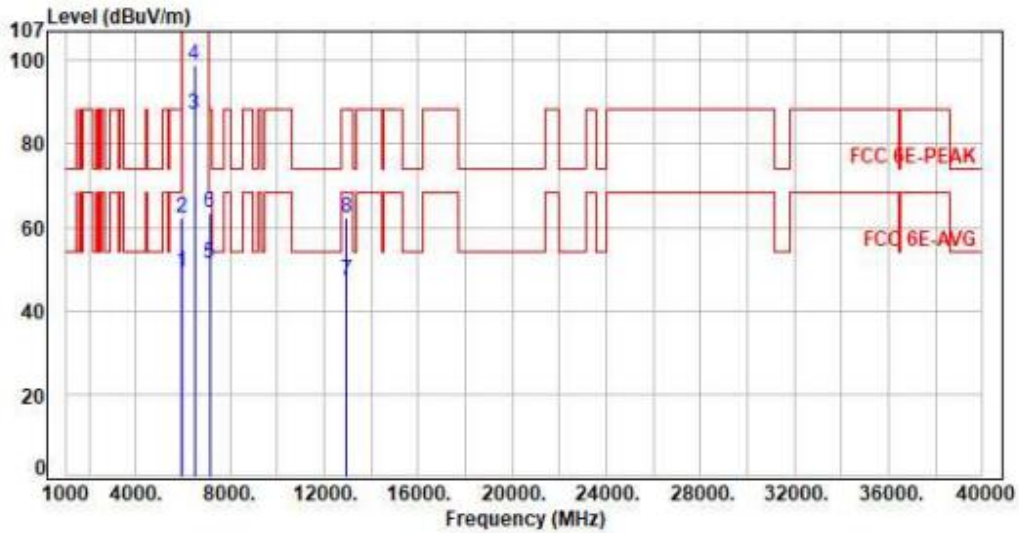

No.	Frequency (MHz)	Factor (dB)	Reading (dBUV)	Level (dBUV/m)	Limit (dBUV/m)	Margin (dB)	Detector	Height (cm)	Azimuth (deg)	P/F
1	5925.00	7.66	41.75	49.41	68.20	-18.79	Average	100	53	P
2	5925.00	7.66	54.57	62.23	88.20	-25.97	Peak	100	53	P
3	6475.00	8.33	78.58	86.91	200.00	-113.09	Average	100	53	P
4	6475.00	8.33	90.34	98.67	200.00	-101.33	Peak	100	53	P
5	7125.00	10.05	41.21	51.26	68.20	-16.94	Average	100	53	P
6	7125.00	10.05	53.27	63.32	88.20	-24.88	Peak	100	53	P
7	12950.00	19.39	27.70	47.09	68.20	-21.11	Average	100	195	P
8	12950.00	19.39	42.66	62.05	88.20	-26.15	Peak	100	195	P

Note: Level=Reading+Factor  
 Margin=Level-Limit  
 Factor=Antenna Factor + cable loss - Amplifier Factor



Power	: From System (AC120V /60Hz)	Pol/Phase	: VERTICAL
Test Mode	: Mode 1, Band 6, CH113		:

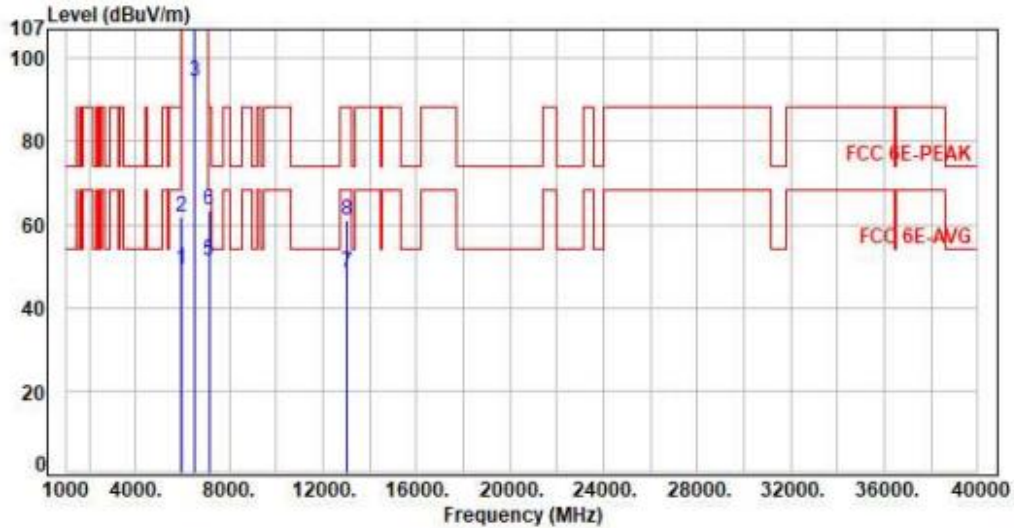

No.	Frequency (MHz)	Factor (dB)	Reading (dBuV)	Level (dBuV/m)	Limit (dBuV/m)	Margin (dB)	Detector	Height (cm)	Azimuth (deg)	P/F
1	5925.00	7.66	41.70	49.36	68.20	-18.84	Average	100	135	P
2	5925.00	7.66	53.99	61.65	88.20	-26.55	Peak	100	135	P
3	6515.00	8.42	86.16	94.58	200.00	-105.42	Average	100	135	P
4	6515.00	8.42	98.52	106.94	200.00	-93.06	Peak	100	135	P
5	7125.00	10.05	41.24	51.29	68.20	-16.91	Average	100	135	P
6	7125.00	10.05	53.53	63.58	88.20	-24.62	Peak	100	135	P
7	13030.00	19.86	28.54	48.40	68.20	-19.80	Average	100	226	P
8	13030.00	19.86	41.16	61.02	88.20	-27.18	Peak	100	226	P

Note: Level=Reading+Factor  
 Margin=Level-Limit  
 Factor=Antenna Factor + cable loss - Amplifier Factor



Power	:	From System (AC120V /60Hz)	Pol/Phase	:	HORIZONTAL
Test Mode	:	Mode 1, Band 6, CH113		:	

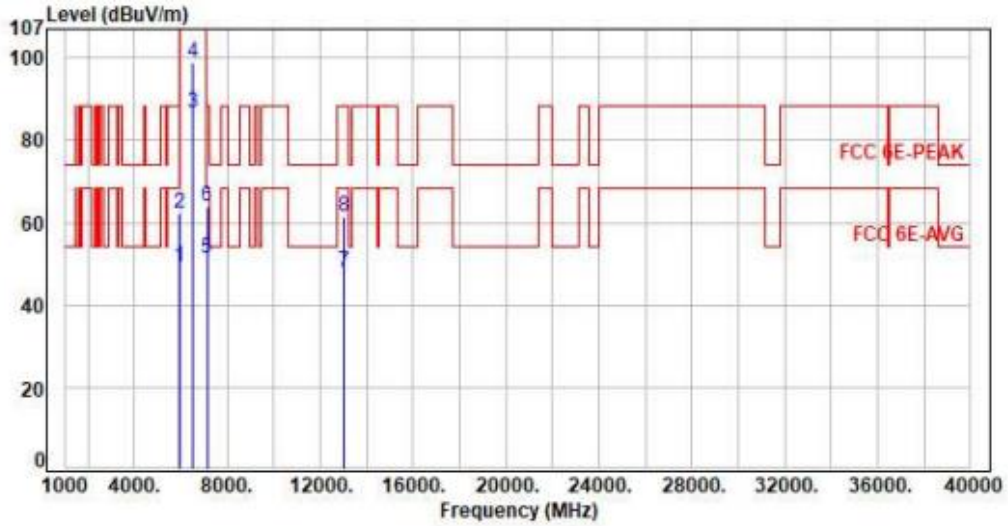

No.	Frequency (MHz)	Factor (dB)	Reading (dBuV)	Level (dBuV/m)	Limit (dBuV/m)	Margin (dB)	Detector	Height (cm)	Azimuth (deg)	P/F
1	5925.00	7.66	41.62	49.28	68.20	-18.92	Average	100	55	P
2	5925.00	7.66	54.59	62.25	88.20	-25.95	Peak	100	55	P
3	6515.00	8.42	78.11	86.53	200.00	-113.47	Average	100	55	P
4	6515.00	8.42	90.44	98.86	200.00	-101.14	Peak	100	55	P
5	7125.00	10.05	41.34	51.39	68.20	-16.81	Average	100	55	P
6	7125.00	10.05	53.73	63.78	88.20	-24.42	Peak	100	55	P
7	13030.00	19.86	28.10	47.96	68.20	-20.24	Average	100	318	P
8	13030.00	19.86	41.39	61.25	88.20	-26.95	Peak	100	318	P

Note: Level=Reading+Factor  
 Margin=Level-Limit  
 Factor=Antenna Factor + cable loss - Amplifier Factor



Power	: From System (AC120V /60Hz)	Pol/Phase	: VERTICAL
Test Mode	: Mode 2, Band 6, CH99		:

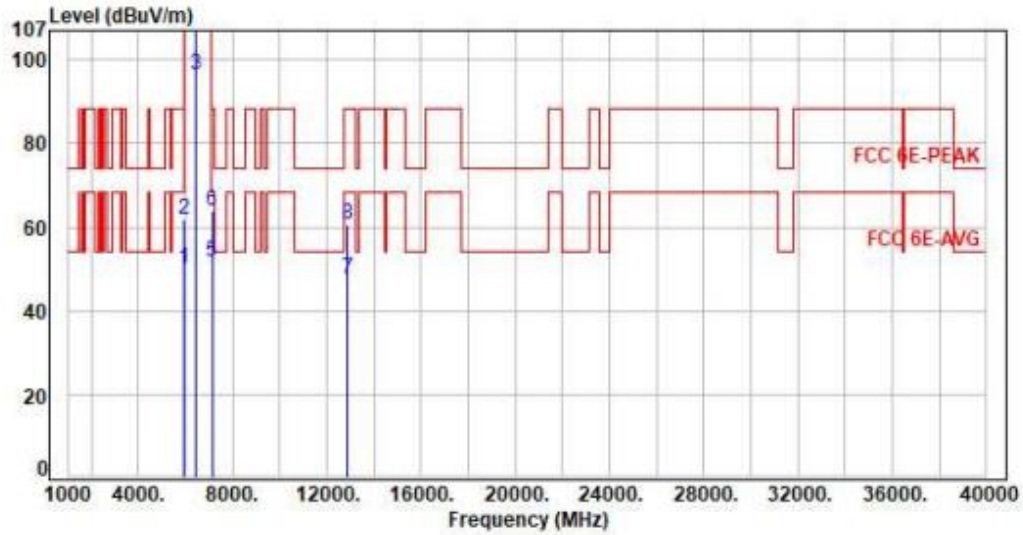

No.	Frequency (MHz)	Factor (dB)	Reading (dBUV)	Level (dBUV/m)	Limit (dBUV/m)	Margin (dB)	Detector	Height (cm)	Azimuth (deg)	P/F
1	5925.00	7.66	42.31	49.97	68.20	-18.23	Average	100	128	P
2	5925.00	7.66	54.34	62.00	88.20	-26.20	Peak	100	128	P
3	6445.00	8.31	88.09	96.40	200.00	-103.60	Average	100	128	P
4	6445.00	8.31	99.30	107.61	200.00	-92.39	Peak	100	128	P
5	7125.00	10.05	41.62	51.67	68.20	-16.53	Average	100	128	P
6	7125.00	10.05	53.72	63.77	88.20	-24.43	Peak	100	128	P
7	12890.00	19.05	28.62	47.67	68.20	-20.53	Average	100	174	P
8	12890.00	19.05	41.42	60.47	88.20	-27.73	Peak	100	174	P

Note: Level=Reading+Factor  
 Margin=Level-Limit  
 Factor=Antenna Factor + cable loss - Amplifier Factor



Power	:	From System (AC120V /60Hz)	Pol/Phase	:	HORIZONTAL
Test Mode	:	Mode 2, Band 6, CH99		:	

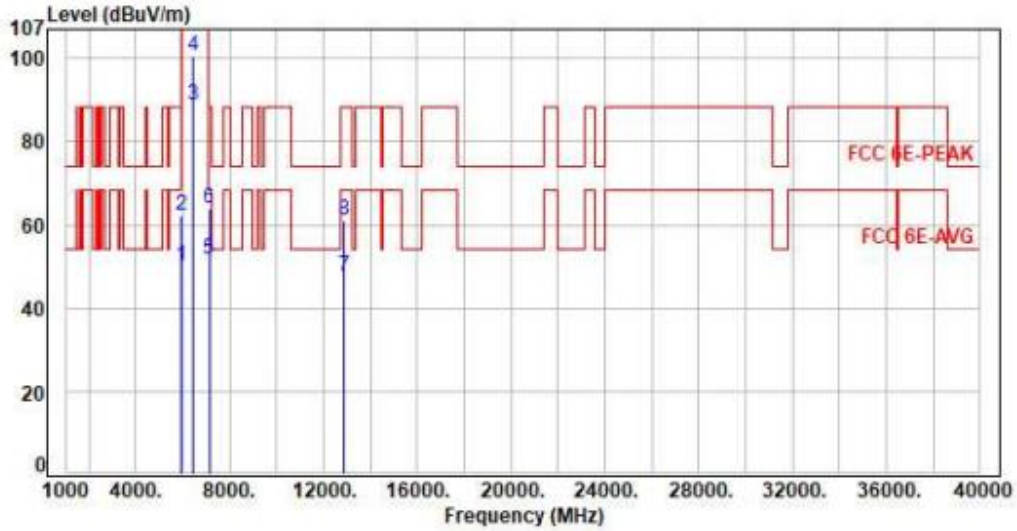

No.	Frequency (MHz)	Factor (dB)	Reading (dBuV)	Level (dBuV/m)	Limit (dBuV/m)	Margin (dB)	Detector	Height (cm)	Azimuth (deg)	P/F
1	5925.00	7.66	42.23	49.89	68.20	-18.31	Average	100	52	P
2	5925.00	7.66	54.62	62.28	88.20	-25.92	Peak	100	52	P
3	6445.00	8.31	80.54	88.85	200.00	-111.15	Average	100	52	P
4	6445.00	8.31	92.01	100.32	200.00	-99.68	Peak	100	52	P
5	7125.00	10.05	41.76	51.81	68.20	-16.39	Average	100	52	P
6	7125.00	10.05	53.76	63.81	88.20	-24.39	Peak	100	52	P
7	12890.00	19.05	28.50	47.55	68.20	-20.65	Average	100	248	P
8	12890.00	19.05	42.10	61.15	88.20	-27.05	Peak	100	248	P

Note: Level=Reading+Factor  
 Margin=Level-Limit  
 Factor=Antenna Factor + cable loss - Amplifier Factor



Power	:	From System (AC120V /60Hz)	Pol/Phase	:	VERTICAL
Test Mode	:	Mode 2, Band 6, CH107		:	

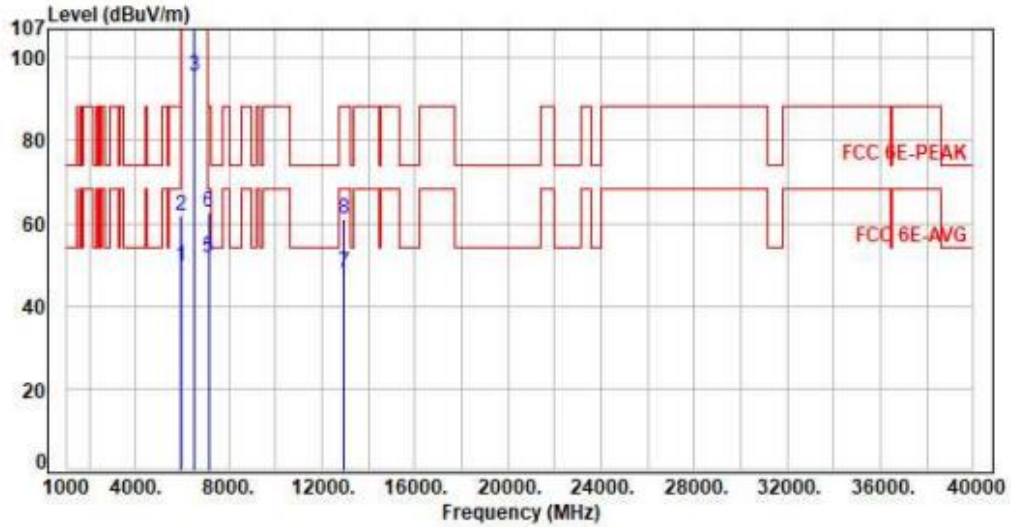

No.	Frequency (MHz)	Factor (dB)	Reading (dBuV)	Level (dBuV/m)	Limit (dBuV/m)	Margin (dB)	Detector	Height (cm)	Azimuth (deg)	P/F
1	5925.00	7.66	42.10	49.76	68.20	-18.44	Average	100	131	P
2	5925.00	7.66	54.35	62.01	88.20	-26.19	Peak	100	131	P
3	6485.00	8.34	87.09	95.43	200.00	-104.57	Average	100	131	P
4	6485.00	8.34	98.95	107.29	200.00	-92.71	Peak	100	131	P
5	7125.00	10.05	41.78	51.83	68.20	-16.37	Average	100	131	P
6	7125.00	10.05	52.76	62.81	88.20	-25.39	Peak	100	131	P
7	12970.00	19.47	28.68	48.15	68.20	-20.05	Average	100	299	P
8	12970.00	19.47	41.36	60.83	88.20	-27.37	Peak	100	299	P

Note: Level=Reading+Factor  
 Margin=Level-Limit  
 Factor=Antenna Factor + cable loss - Amplifier Factor





Power	:	From System (AC120V /60Hz)	Pol/Phase	:	HORIZONTAL
Test Mode	:	Mode 2, Band 6, CH107		:	

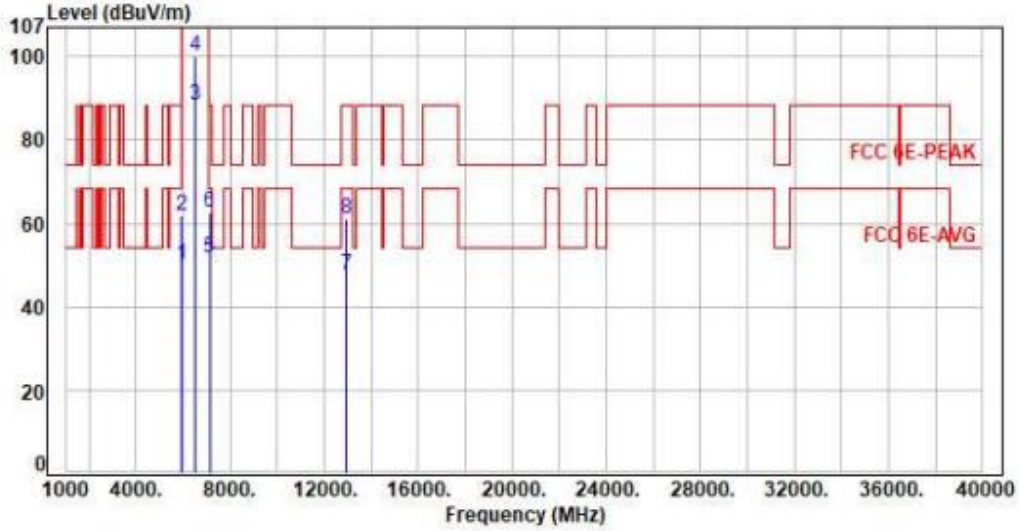

No.	Frequency (MHz)	Factor (dB)	Reading (dBuV)	Level (dBuV/m)	Limit (dBuV/m)	Margin (dB)	Detector	Height (cm)	Azimuth (deg)	P/F
1	5925.00	7.66	42.39	50.05	68.20	-18.15	Average	100	55	P
2	5925.00	7.66	54.26	61.92	88.20	-26.28	Peak	100	55	P
3	6485.00	8.34	79.80	88.14	200.00	-111.86	Average	100	55	P
4	6485.00	8.34	91.87	100.21	200.00	-99.79	Peak	100	55	P
5	7125.00	10.05	41.56	51.61	68.20	-16.59	Average	100	55	P
6	7125.00	10.05	52.64	62.69	88.20	-25.51	Peak	100	55	P
7	12970.00	19.47	28.19	47.66	68.20	-20.54	Average	100	311	P
8	12970.00	19.47	41.62	61.09	88.20	-27.11	Peak	100	311	P

Note: Level=Reading+Factor  
 Margin=Level-Limit  
 Factor=Antenna Factor + cable loss - Amplifier Factor



Power	:	From System (AC120V /60Hz)	Pol/Phase	:	VERTICAL
Test Mode	:	Mode 3, Band 6, CH103		:	

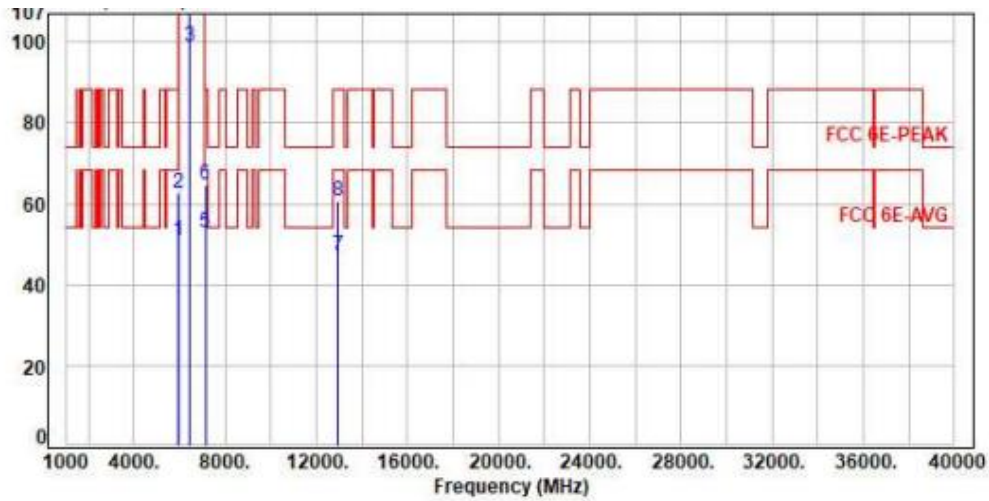

No.	Frequency (MHz)	Factor (dB)	Reading (dBuV)	Level (dBuV/m)	Limit (dBuV/m)	Margin (dB)	Detector	Height (cm)	Azimuth (deg)	P/F
1	5925.00	7.66	43.18	50.84	68.20	-17.36	Average	100	130	P
2	5925.00	7.66	54.98	62.64	88.20	-25.56	Peak	100	130	P
3	6465.00	8.32	90.44	98.76	200.00	-101.24	Average	100	130	P
4	6465.00	8.32	101.27	109.59	200.00	-90.41	Peak	100	130	P
5	7125.00	10.05	42.75	52.80	68.20	-15.40	Average	100	130	P
6	7125.00	10.05	54.56	64.61	88.20	-23.59	Peak	100	130	P
7	12930.00	19.27	27.98	47.25	68.20	-20.95	Average	100	263	P
8	12930.00	19.27	41.42	60.69	88.20	-27.51	Peak	100	263	P

Note: Level=Reading+Factor  
 Margin=Level-Limit  
 Factor=Antenna Factor + cable loss - Amplifier Factor



Power	:	From System (AC120V /60Hz)	Pol/Phase	:	HORIZONTAL
Test Mode	:	Mode 3, Band 6, CH103		:	

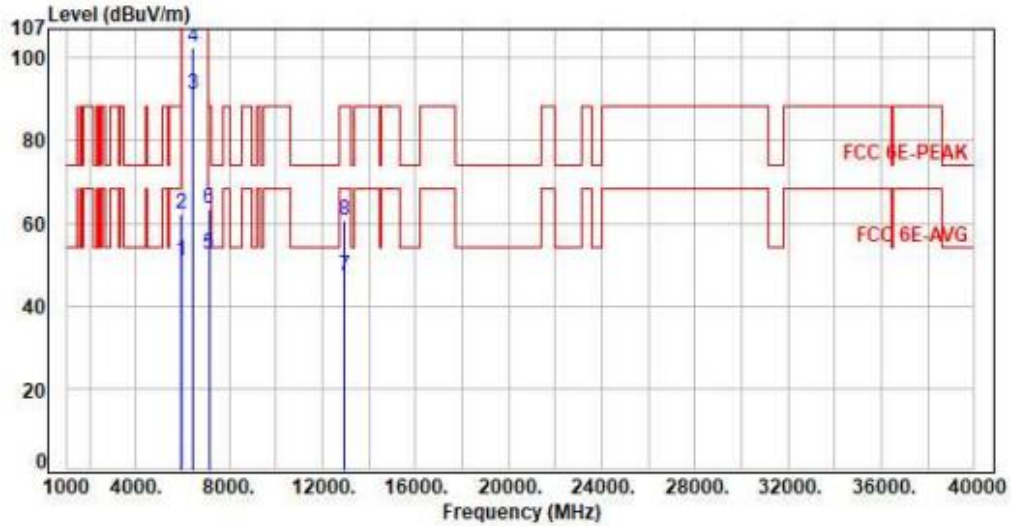

No.	Frequency (MHz)	Factor (dB)	Reading (dBuV)	Level (dBuV/m)	Limit (dBuV/m)	Margin (dB)	Detector	Height (cm)	Azimuth (deg)	P/F
1	5925.00	7.66	43.22	50.88	68.20	-17.32	Average	100	59	P
2	5925.00	7.66	54.60	62.26	88.20	-25.94	Peak	100	59	P
3	6465.00	8.32	83.00	91.32	200.00	-108.68	Average	100	59	P
4	6465.00	8.32	94.06	102.38	200.00	-97.62	Peak	100	59	P
5	7125.00	10.05	42.48	52.53	68.20	-15.67	Average	100	59	P
6	7125.00	10.05	53.39	63.44	88.20	-24.76	Peak	100	59	P
7	12930.00	19.27	27.94	47.21	68.20	-20.99	Average	100	224	P
8	12930.00	19.27	41.46	60.73	88.20	-27.47	Peak	100	224	P

Note: Level=Reading+Factor  
 Margin=Level-Limit  
 Factor=Antenna Factor + cable loss - Amplifier Factor



Power	: From System (AC120V /60Hz)	Pol/Phase	: VERTICAL
Test Mode	: Mode 2, Band 6 Straddle Channel, CH115		:

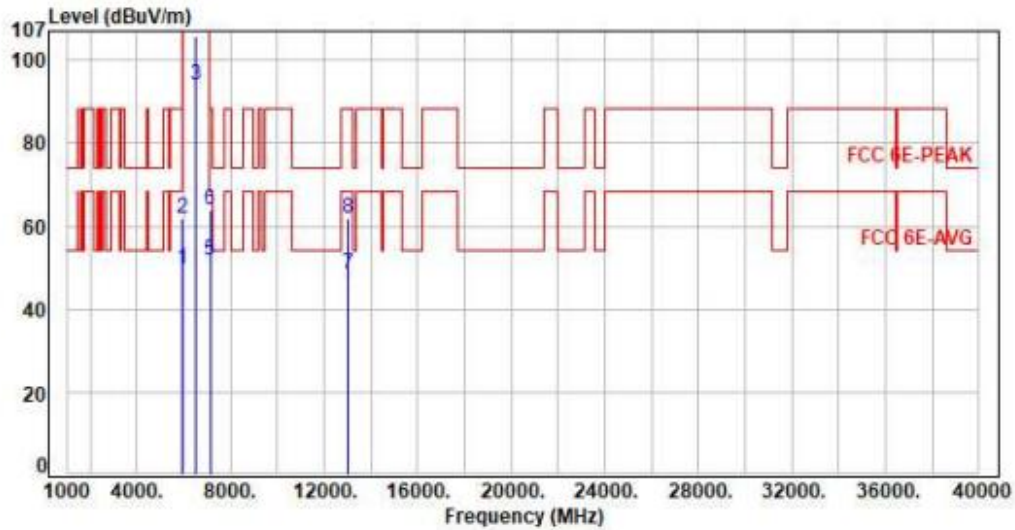

No.	Frequency (MHz)	Factor (dB)	Reading (dBuV)	Level (dBuV/m)	Limit (dBuV/m)	Margin (dB)	Detector	Height (cm)	Azimuth (deg)	P/F
1	5925.00	7.66	41.79	49.45	68.20	-18.75	Average	100	135	P
2	5925.00	7.66	54.12	61.78	88.20	-26.42	Peak	100	135	P
3	6525.00	8.45	85.48	93.93	200.00	-106.07	Average	100	135	P
4	6525.00	8.45	97.27	105.72	200.00	-94.28	Peak	100	135	P
5	7125.00	10.05	41.44	51.49	68.20	-16.71	Average	100	135	P
6	7125.00	10.05	53.78	63.83	88.20	-24.37	Peak	100	135	P
7	13050.00	20.02	28.46	48.48	68.20	-19.72	Average	100	172	P
8	13050.00	20.02	41.63	61.65	88.20	-26.55	Peak	100	172	P

Note: Level=Reading+Factor  
 Margin=Level-Limit  
 Factor=Antenna Factor + cable loss - Amplifier Factor



Power	:	From System (AC120V /60Hz)	Pol/Phase	:	HORIZONTAL
Test Mode	:	Mode 2, Band 6 Straddle Channel, CH115		:	

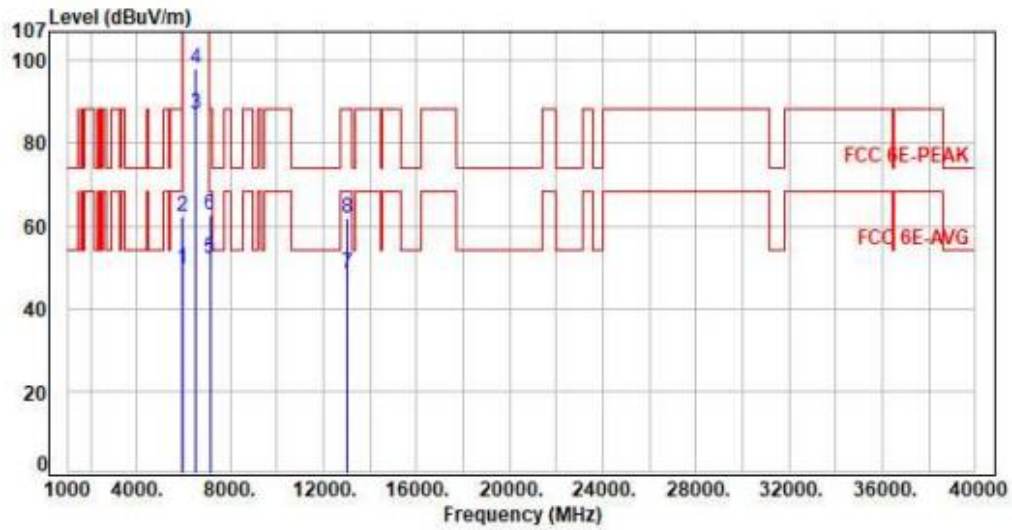

No.	Frequency (MHz)	Factor (dB)	Reading (dBuV)	Level (dBuV/m)	Limit (dBuV/m)	Margin (dB)	Detector	Height (cm)	Azimuth (deg)	P/F
1	5925.00	7.66	41.87	49.53	68.20	-18.67	Average	100	54	P
2	5925.00	7.66	54.41	62.07	88.20	-26.13	Peak	100	54	P
3	6525.00	8.45	78.45	86.90	200.00	-113.10	Average	100	54	P
4	6525.00	8.45	89.47	97.92	200.00	-102.08	Peak	100	54	P
5	7125.00	10.05	41.91	51.96	68.20	-16.24	Average	100	54	P
6	7125.00	10.05	52.78	62.83	88.20	-25.37	Peak	100	54	P
7	13050.00	20.02	28.40	48.42	68.20	-19.78	Average	100	256	P
8	13050.00	20.02	41.63	61.65	88.20	-26.55	Peak	100	256	P

Note: Level=Reading+Factor  
 Margin=Level-Limit  
 Factor=Antenna Factor + cable loss - Amplifier Factor



Power	: From System (AC120V /60Hz)	Pol/Phase	: VERTICAL
Test Mode	: Mode 3, Band 6 Straddle Channel, CH119		:

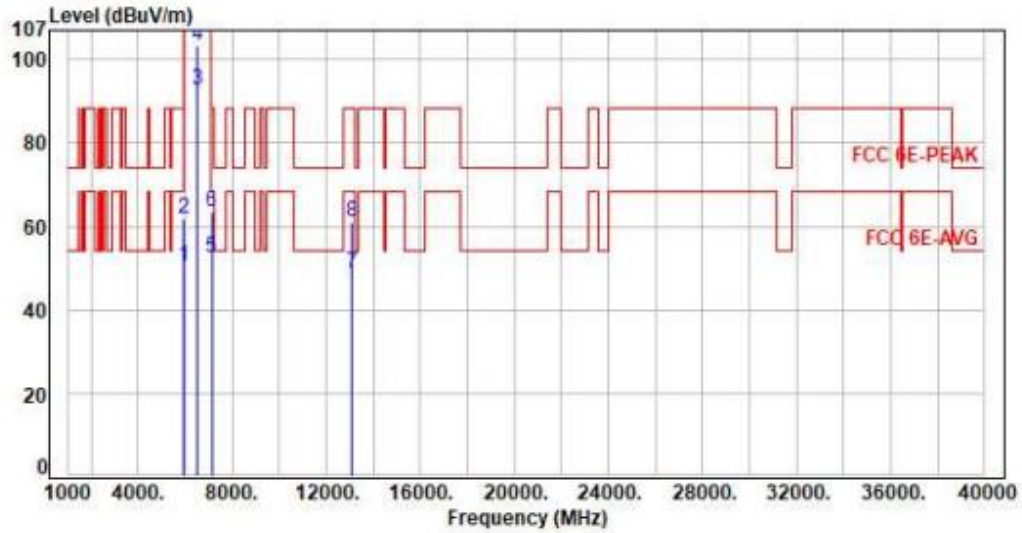

No.	Frequency (MHz)	Factor (dB)	Reading (dBuV)	Level (dBuV/m)	Limit (dBuV/m)	Margin (dB)	Detector	Height (cm)	Azimuth (deg)	P/F
1	5925.00	7.66	42.77	50.43	68.20	-17.77	Average	100	128	P
2	5925.00	7.66	54.20	61.86	88.20	-26.34	Peak	100	128	P
3	6545.00	8.55	84.33	92.88	200.00	-107.12	Average	100	128	P
4	6545.00	8.55	94.97	103.52	200.00	-96.48	Peak	100	128	P
5	7125.00	10.05	42.51	52.56	68.20	-15.64	Average	100	128	P
6	7125.00	10.05	53.49	63.54	88.20	-24.66	Peak	100	128	P
7	13090.00	20.20	28.54	48.74	68.20	-19.46	Average	100	176	P
8	13090.00	20.20	40.88	61.08	88.20	-27.12	Peak	100	176	P

Note: Level=Reading+Factor  
 Margin=Level-Limit  
 Factor=Antenna Factor + cable loss - Amplifier Factor



Power	:	From System (AC120V /60Hz)	Pol/Phase	:	HORIZONTAL
Test Mode	:	Mode 3, Band 6 Straddle Channel, CH119		:	

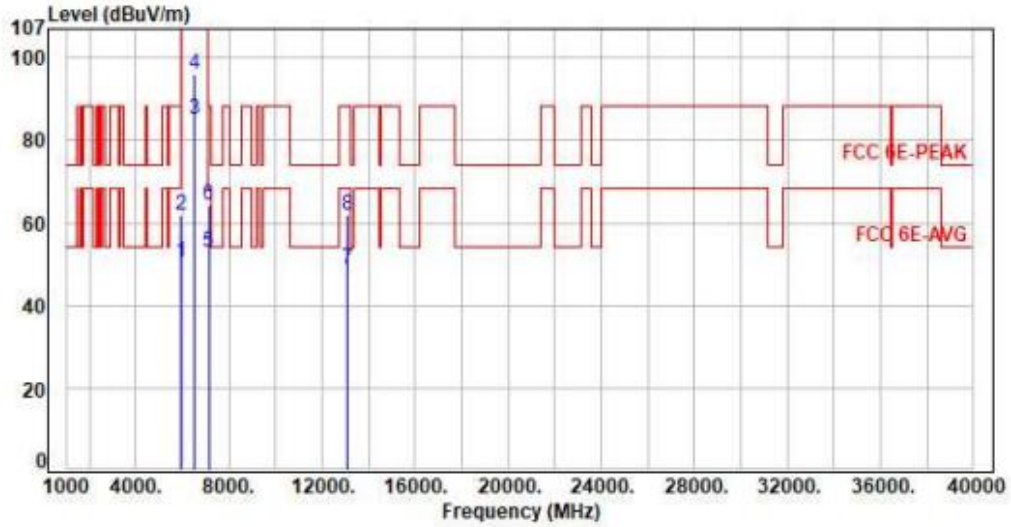

No.	Frequency (MHz)	Factor (dB)	Reading (dBuV)	Level (dBuV/m)	Limit (dBuV/m)	Margin (dB)	Detector	Height (cm)	Azimuth (deg)	P/F
1	5925.00	7.66	42.84	50.50	68.20	-17.70	Average	100	60	P
2	5925.00	7.66	54.09	61.75	88.20	-26.45	Peak	100	60	P
3	6545.00	8.55	76.54	85.09	200.00	-114.91	Average	100	60	P
4	6545.00	8.55	87.45	96.00	200.00	-104.00	Peak	100	60	P
5	7125.00	10.05	42.64	52.69	68.20	-15.51	Average	100	60	P
6	7125.00	10.05	54.04	64.09	88.20	-24.11	Peak	100	60	P
7	13090.00	20.20	28.63	48.83	68.20	-19.37	Average	100	225	P
8	13090.00	20.20	41.80	62.00	88.20	-26.20	Peak	100	225	P

Note: Level=Reading+Factor  
 Margin=Level-Limit  
 Factor=Antenna Factor + cable loss - Amplifier Factor



Power	: From System (AC120V /60Hz)	Pol/Phase	: VERTICAL
Test Mode	: Mode 4, Band 6 Straddle Channel, CH111		:

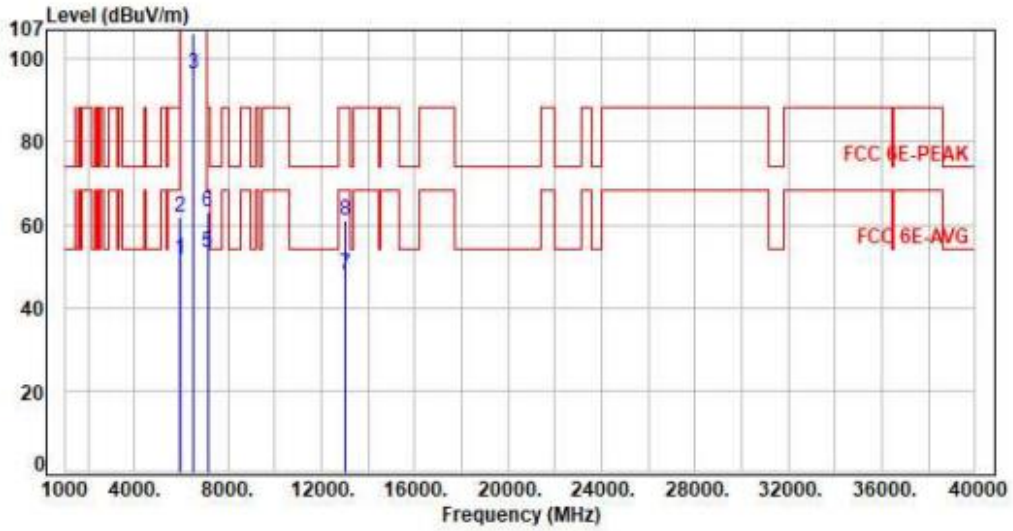

No.	Frequency (MHz)	Factor (dB)	Reading (dBuV)	Level (dBuV/m)	Limit (dBuV/m)	Margin (dB)	Detector	Height (cm)	Azimuth (deg)	P/F
1	5925.00	7.66	43.91	51.57	68.20	-16.63	Average	100	138	P
2	5925.00	7.66	54.35	62.01	88.20	-26.19	Peak	100	138	P
3	6505.00	8.37	87.89	96.26	200.00	-103.74	Average	100	138	P
4	6505.00	8.37	97.98	106.35	200.00	-93.65	Peak	100	138	P
5	7125.00	10.05	43.36	53.41	68.20	-14.79	Average	100	138	P
6	7125.00	10.05	53.16	63.21	88.20	-24.99	Peak	100	138	P
7	13010.00	19.69	28.14	47.83	68.20	-20.37	Average	100	227	P
8	13010.00	19.69	41.33	61.02	88.20	-27.18	Peak	100	227	P

Note: Level=Reading+Factor  
 Margin=Level-Limit  
 Factor=Antenna Factor + cable loss - Amplifier Factor





Power	: From System (AC120V /60Hz)	Pol/Phase	: HORIZONTAL
Test Mode	: Mode 4, Band 6 Straddle Channel, CH111		:

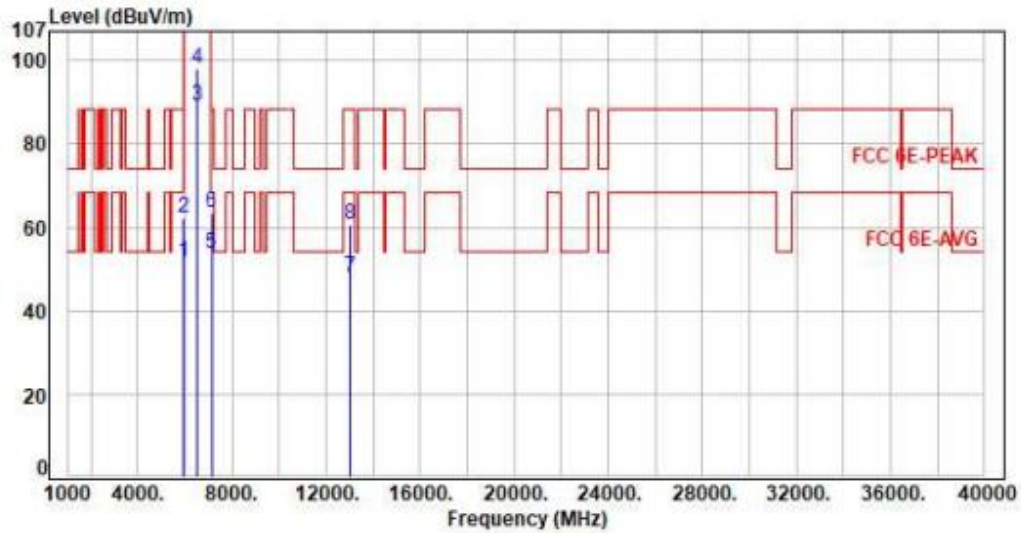

No.	Frequency (MHz)	Factor (dB)	Reading (dBuV)	Level (dBuV/m)	Limit (dBuV/m)	Margin (dB)	Detector	Height (cm)	Azimuth (deg)	P/F
1	5925.00	7.66	44.00	51.66	68.20	-16.54	Average	100	55	P
2	5925.00	7.66	54.58	62.24	88.20	-25.96	Peak	100	55	P
3	6505.00	8.37	80.77	89.14	200.00	-110.86	Average	100	55	P
4	6505.00	8.37	89.84	98.21	200.00	-101.79	Peak	100	55	P
5	7125.00	10.05	43.63	53.68	68.20	-14.52	Average	100	55	P
6	7125.00	10.05	53.57	63.62	88.20	-24.58	Peak	100	55	P
7	13010.00	19.69	28.39	48.08	68.20	-20.12	Average	100	225	P
8	13010.00	19.69	40.86	60.55	88.20	-27.65	Peak	100	225	P

Note: Level=Reading+Factor  
 Margin=Level-Limit  
 Factor=Antenna Factor + cable loss - Amplifier Factor



Power	:	From System (AC120V /60Hz)	Pol/Phase	:	VERTICAL
Test Mode	:	Mode 1, Band 7, CH117		:	

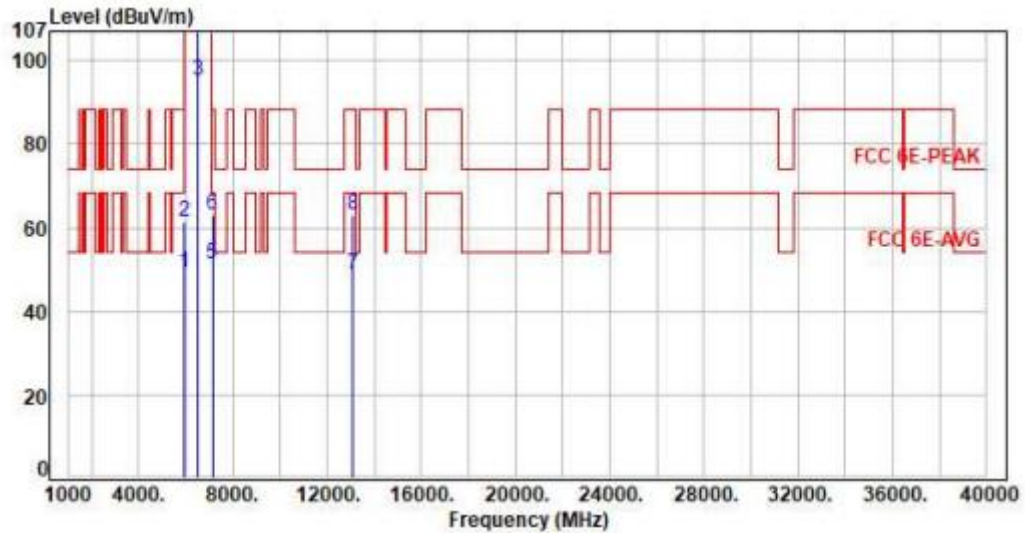

No.	Frequency (MHz)	Factor (dB)	Reading (dBuV)	Level (dBuV/m)	Limit (dBuV/m)	Margin (dB)	Detector	Height (cm)	Azimuth (deg)	P/F
1	5925.00	7.66	41.61	49.27	68.20	-18.93	Average	100	134	P
2	5925.00	7.66	53.87	61.53	88.20	-26.67	Peak	100	134	P
3	6535.00	8.50	86.79	95.29	200.00	-104.71	Average	100	134	P
4	6535.00	8.50	98.97	107.47	200.00	-92.53	Peak	100	134	P
5	7125.00	10.05	41.32	51.37	68.20	-16.83	Average	100	134	P
6	7125.00	10.05	52.97	63.02	88.20	-25.18	Peak	100	134	P
7	13070.00	20.11	28.69	48.80	68.20	-19.40	Average	100	175	P
8	13070.00	20.11	42.95	63.06	88.20	-25.14	Peak	100	175	P

Note: Level=Reading+Factor  
 Margin=Level-Limit  
 Factor=Antenna Factor + cable loss - Amplifier Factor



Power	:	From System (AC120V /60Hz)	Pol/Phase	:	HORIZONTAL
Test Mode	:	Mode 1, Band 7, CH117		:	

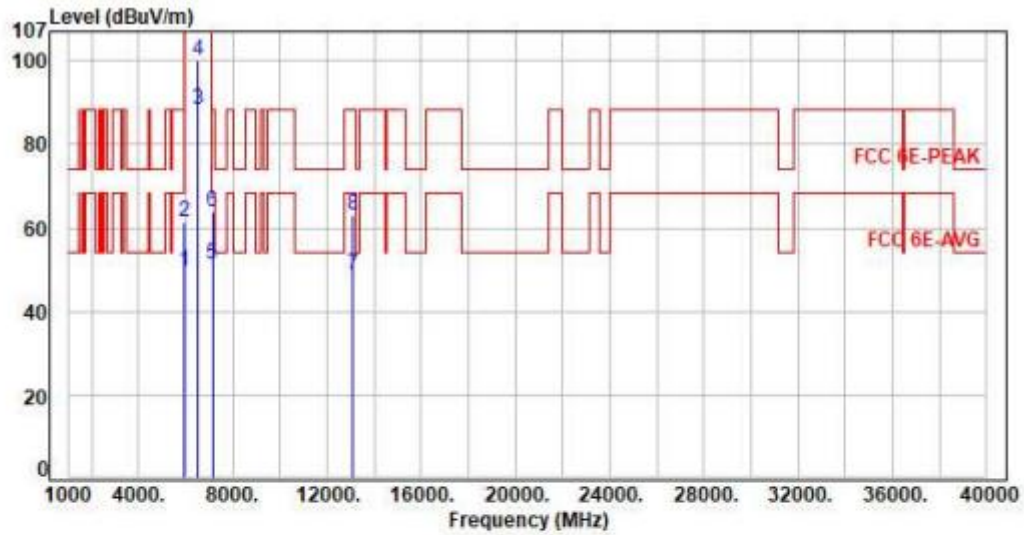

No.	Frequency (MHz)	Factor (dB)	Reading (dBuV)	Level (dBuV/m)	Limit (dBuV/m)	Margin (dB)	Detector	Height (cm)	Azimuth (deg)	P/F
1	5925.00	7.66	41.78	49.44	68.20	-18.76	Average	100	55	P
2	5925.00	7.66	53.97	61.63	88.20	-26.57	Peak	100	55	P
3	6535.00	8.50	79.58	88.08	200.00	-111.92	Average	100	55	P
4	6535.00	8.50	91.76	100.26	200.00	-99.74	Peak	100	55	P
5	7125.00	10.05	41.38	51.43	68.20	-16.77	Average	100	55	P
6	7125.00	10.05	53.71	63.76	88.20	-24.44	Peak	100	55	P
7	13070.00	20.11	28.51	48.62	68.20	-19.58	Average	100	117	P
8	13070.00	20.11	42.82	62.93	88.20	-25.27	Peak	100	117	P

Note: Level=Reading+Factor  
 Margin=Level-Limit  
 Factor=Antenna Factor + cable loss - Amplifier Factor



Power	: From System (AC120V /60Hz)	Pol/Phase	: VERTICAL
Test Mode	: Mode 1, Band 7, CH149		:

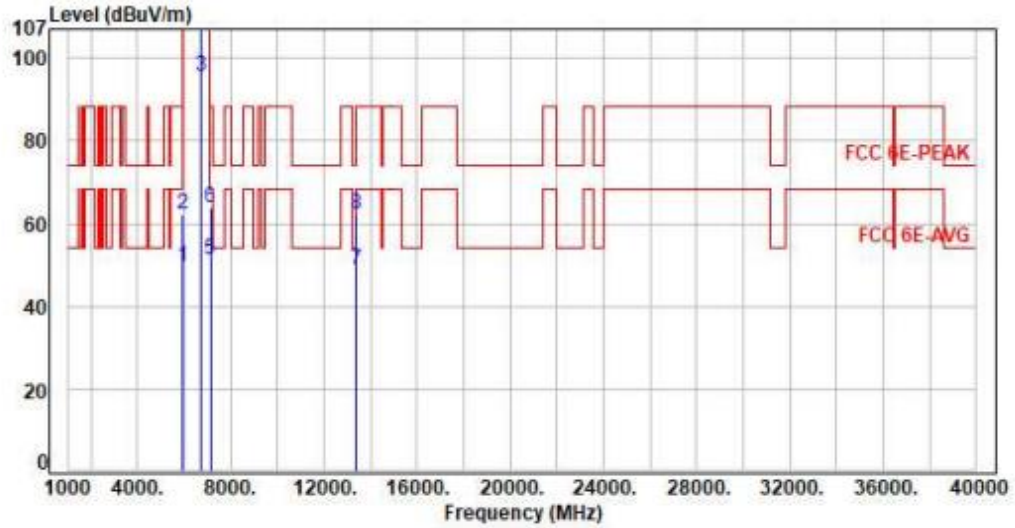

No.	Frequency (MHz)	Factor (dB)	Reading (dBuV)	Level (dBuV/m)	Limit (dBuV/m)	Margin (dB)	Detector	Height (cm)	Azimuth (deg)	P/F
1	5925.00	7.66	41.82	49.48	68.20	-18.72	Average	100	124	P
2	5925.00	7.66	54.52	62.18	88.20	-26.02	Peak	100	124	P
3	6695.00	9.20	86.34	95.54	200.00	-104.46	Average	100	124	P
4	6695.00	9.20	97.99	107.19	200.00	-92.81	Peak	100	124	P
5	7125.00	10.05	41.36	51.41	68.20	-16.79	Average	100	124	P
6	7125.00	10.05	53.83	63.88	88.20	-24.32	Peak	100	124	P
7	13390.00	21.54	27.41	48.95	54.00	-5.05	Average	100	164	P
8	13390.00	21.54	40.67	62.21	74.00	-11.79	Peak	100	164	P

Note: Level=Reading+Factor

Margin=Level-Limit

Factor=Antenna Factor + cable loss - Amplifier Factor



Power	:	From System (AC120V /60Hz)	Pol/Phase	:	HORIZONTAL
Test Mode	:	Mode 1, Band 7, CH149		:	

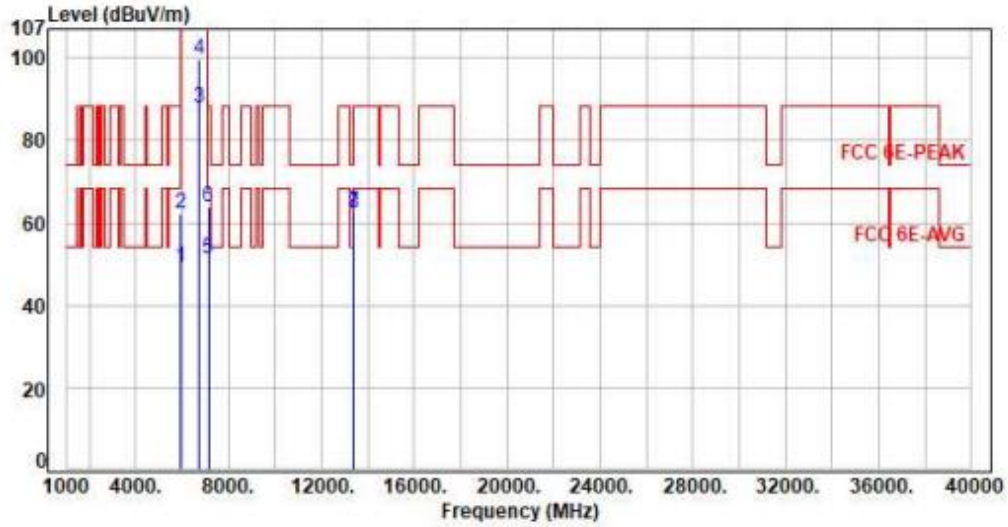

No.	Frequency (MHz)	Factor (dB)	Reading (dBUV)	Level (dBUV/m)	Limit (dBUV/m)	Margin (dB)	Detector	Height (cm)	Azimuth (deg)	P/F
1	5925.00	7.66	41.74	49.40	68.20	-18.80	Average	100	47	P
2	5925.00	7.66	54.67	62.33	88.20	-25.87	Peak	100	47	P
3	6695.00	9.20	78.63	87.83	200.00	-112.17	Average	100	47	P
4	6695.00	9.20	90.42	99.62	200.00	-100.38	Peak	100	47	P
5	7125.00	10.05	41.39	51.44	68.20	-16.76	Average	100	47	P
6	7125.00	10.05	53.71	63.76	88.20	-24.44	Peak	100	47	P
7	13390.00	21.54	40.91	62.45	54.00	8.45	Average	100	166	F
8	13390.00	21.54	40.67	62.21	74.00	-11.79	Peak	100	166	P

Note: Level=Reading+Factor  
 Margin=Level-Limit  
 Factor=Antenna Factor + cable loss - Amplifier Factor



Power	:	From System (AC120V /60Hz)	Pol/Phase	:	VERTICAL
Test Mode	:	Mode 1, Band 7, CH181		:	

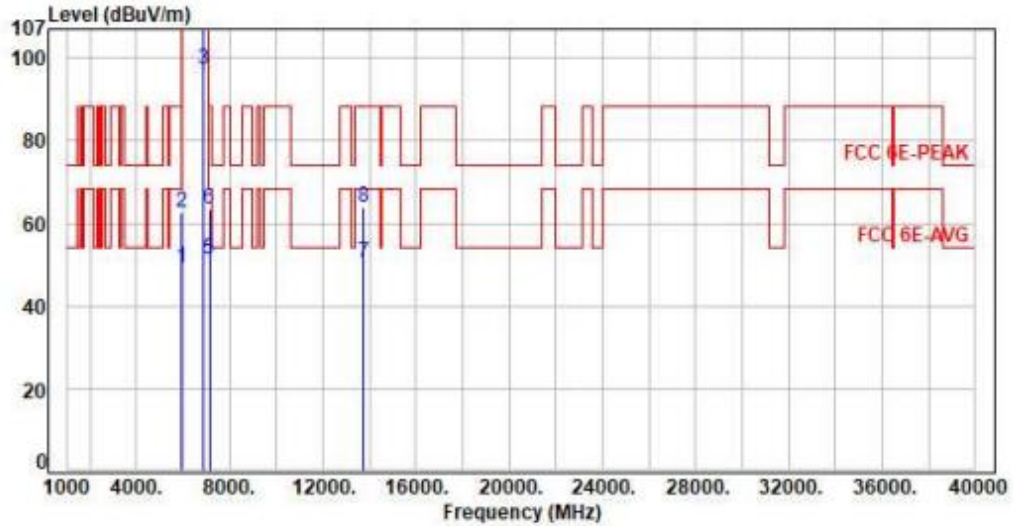

No.	Frequency (MHz)	Factor (dB)	Reading (dBuV)	Level (dBuV/m)	Limit (dBuV/m)	Margin (dB)	Detector	Height (cm)	Azimuth (deg)	P/F
1	5925.00	7.66	41.70	49.36	68.20	-18.84	Average	100	145	P
2	5925.00	7.66	55.18	62.84	88.20	-25.36	Peak	100	145	P
3	6855.00	9.50	87.57	97.07	200.00	-102.93	Average	100	145	P
4	6855.00	9.50	99.80	109.30	200.00	-90.70	Peak	100	145	P
5	7125.00	10.05	41.40	51.45	68.20	-16.75	Average	100	145	P
6	7125.00	10.05	53.62	63.67	88.20	-24.53	Peak	100	145	P
7	13710.00	22.48	28.02	50.50	68.20	-17.70	Average	100	163	P
8	13710.00	22.48	41.48	63.96	88.20	-24.24	Peak	100	163	P

Note: Level=Reading+Factor  
 Margin=Level-Limit  
 Factor=Antenna Factor + cable loss - Amplifier Factor



Power	:	From System (AC120V /60Hz)	Pol/Phase	:	HORIZONTAL
Test Mode	:	Mode 1, Band 7, CH181		:	

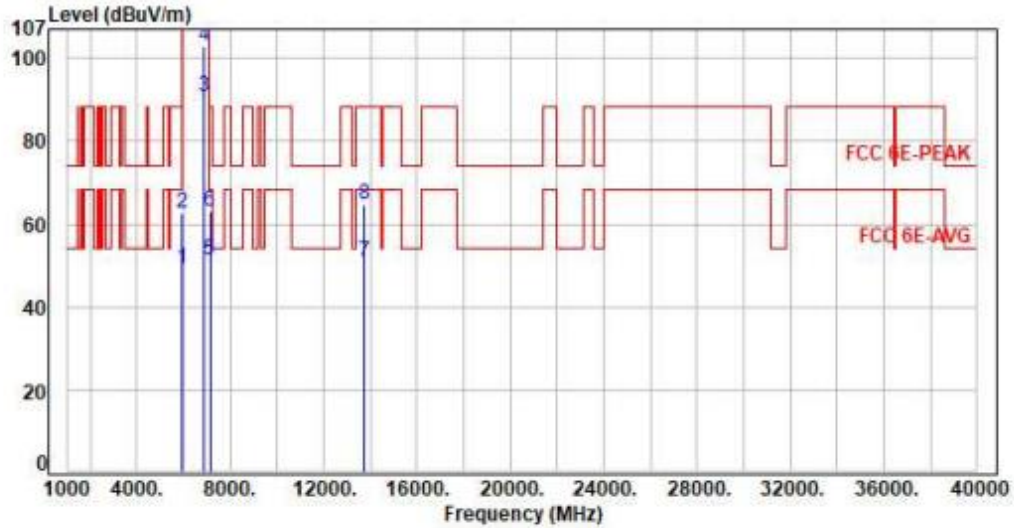

No.	Frequency (MHz)	Factor (dB)	Reading (dBuV)	Level (dBuV/m)	Limit (dBuV/m)	Margin (dB)	Detector	Height (cm)	Azimuth (deg)	P/F
1	5925.00	7.66	41.73	49.39	68.20	-18.81	Average	100	49	P
2	5925.00	7.66	54.82	62.48	88.20	-25.72	Peak	100	49	P
3	6855.00	9.50	81.42	90.92	200.00	-109.08	Average	100	49	P
4	6855.00	9.50	93.61	103.11	200.00	-96.89	Peak	100	49	P
5	7125.00	10.05	41.23	51.28	68.20	-16.92	Average	100	49	P
6	7125.00	10.05	53.18	63.23	88.20	-24.97	Peak	100	49	P
7	13710.00	22.48	28.23	50.71	68.20	-17.49	Average	100	145	P
8	13710.00	22.48	42.34	64.82	88.20	-23.38	Peak	100	145	P

Note: Level=Reading+Factor  
 Margin=Level-Limit  
 Factor=Antenna Factor + cable loss - Amplifier Factor



Power	:	From System (AC120V /60Hz)	Pol/Phase	:	VERTICAL
Test Mode	:	Mode 2, Band 7, CH123		:	

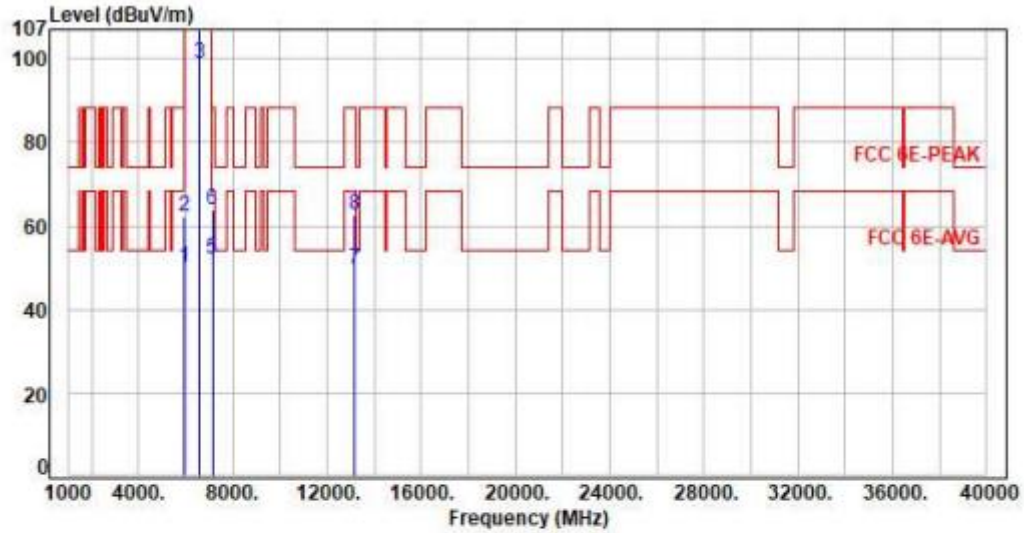

No.	Frequency (MHz)	Factor (dB)	Reading (dBuV)	Level (dBuV/m)	Limit (dBuV/m)	Margin (dB)	Detector	Height (cm)	Azimuth (deg)	P/F
1	5925.00	7.66	42.49	50.15	68.20	-18.05	Average	100	133	P
2	5925.00	7.66	54.48	62.14	88.20	-26.06	Peak	100	133	P
3	6565.00	8.67	90.15	98.82	200.00	-101.18	Average	100	133	P
4	6565.00	8.67	102.31	110.98	200.00	-89.02	Peak	100	133	P
5	7125.00	10.05	41.93	51.98	68.20	-16.22	Average	100	133	P
6	7125.00	10.05	53.85	63.90	88.20	-24.30	Peak	100	133	P
7	13130.00	20.32	29.15	49.47	68.20	-18.73	Average	100	224	P
8	13130.00	20.32	42.49	62.81	88.20	-25.39	Peak	100	224	P

Note: Level=Reading+Factor  
 Margin=Level-Limit  
 Factor=Antenna Factor + cable loss - Amplifier Factor





Power	:	From System (AC120V /60Hz)	Pol/Phase	:	HORIZONTAL
Test Mode	:	Mode 2, Band 7, CH123		:	

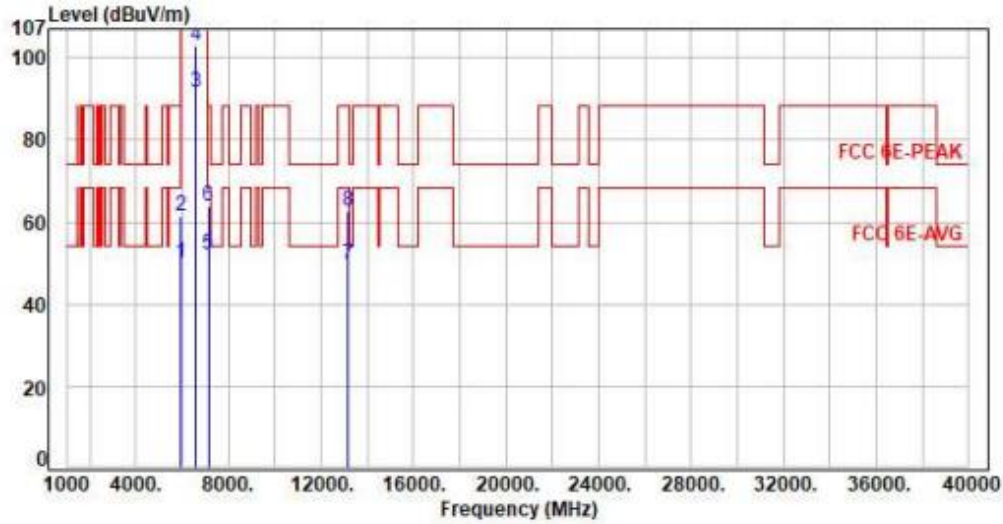

No.	Frequency (MHz)	Factor (dB)	Reading (dBUV)	Level (dBUV/m)	Limit (dBUV/m)	Margin (dB)	Detector	Height (cm)	Azimuth (deg)	P/F
1	5925.00	7.66	42.56	50.22	68.20	-17.98	Average	100	53	P
2	5925.00	7.66	53.90	61.56	88.20	-26.64	Peak	100	53	P
3	6565.00	8.67	82.73	91.40	200.00	-108.60	Average	100	53	P
4	6565.00	8.67	94.16	102.83	200.00	-97.17	Peak	100	53	P
5	7125.00	10.05	41.96	52.01	68.20	-16.19	Average	100	53	P
6	7125.00	10.05	53.96	64.01	88.20	-24.19	Peak	100	53	P
7	13130.00	20.32	29.21	49.53	68.20	-18.67	Average	100	286	P
8	13130.00	20.32	42.22	62.54	88.20	-25.66	Peak	100	286	P

Note: Level=Reading+Factor  
 Margin=Level-Limit  
 Factor=Antenna Factor + cable loss - Amplifier Factor



Power	:	From System (AC120V /60Hz)	Pol/Phase	:	VERTICAL
Test Mode	:	Mode 2, Band 7, CH147		:	

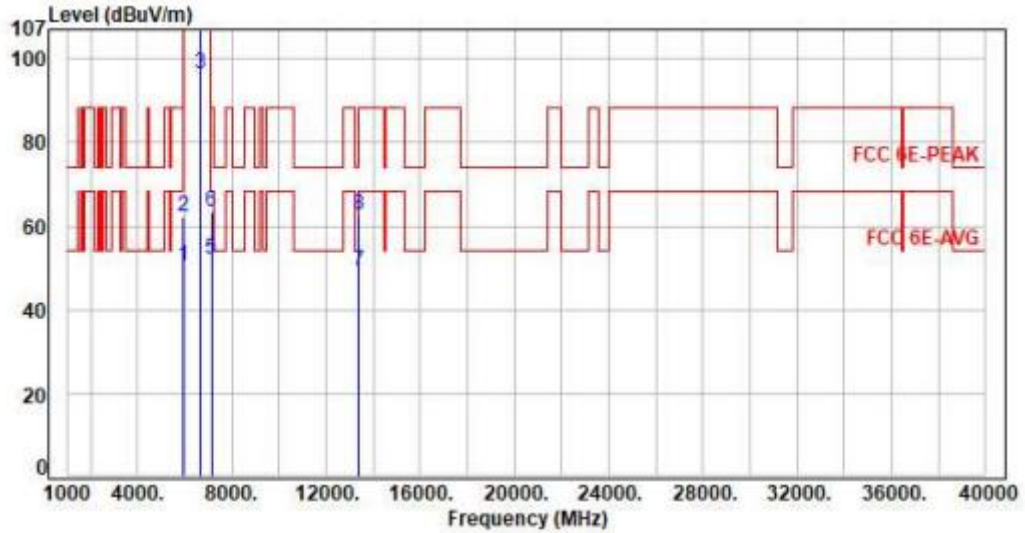

No.	Frequency (MHz)	Factor (dB)	Reading (dBuV)	Level (dBuV/m)	Limit (dBuV/m)	Margin (dB)	Detector	Height (cm)	Azimuth (deg)	P/F
1	5925.00	7.66	42.65	50.31	68.20	-17.89	Average	100	122	P
2	5925.00	7.66	54.60	62.26	88.20	-25.94	Peak	100	122	P
3	6685.00	9.16	87.33	96.49	200.00	-103.51	Average	100	122	P
4	6685.00	9.16	98.15	107.31	200.00	-92.69	Peak	100	122	P
5	7125.00	10.05	42.08	52.13	68.20	-16.07	Average	100	122	P
6	7125.00	10.05	53.47	63.52	88.20	-24.68	Peak	100	122	P
7	13370.00	21.44	27.85	49.29	54.00	-4.71	Average	100	264	P
8	13370.00	21.44	41.36	62.80	74.00	-11.20	Peak	100	264	P

Note: Level=Reading+Factor  
 Margin=Level-Limit  
 Factor=Antenna Factor + cable loss - Amplifier Factor



Power	: From System (AC120V /60Hz)	Pol/Phase	: HORIZONTAL
Test Mode	: Mode 2, Band 7, CH147		:

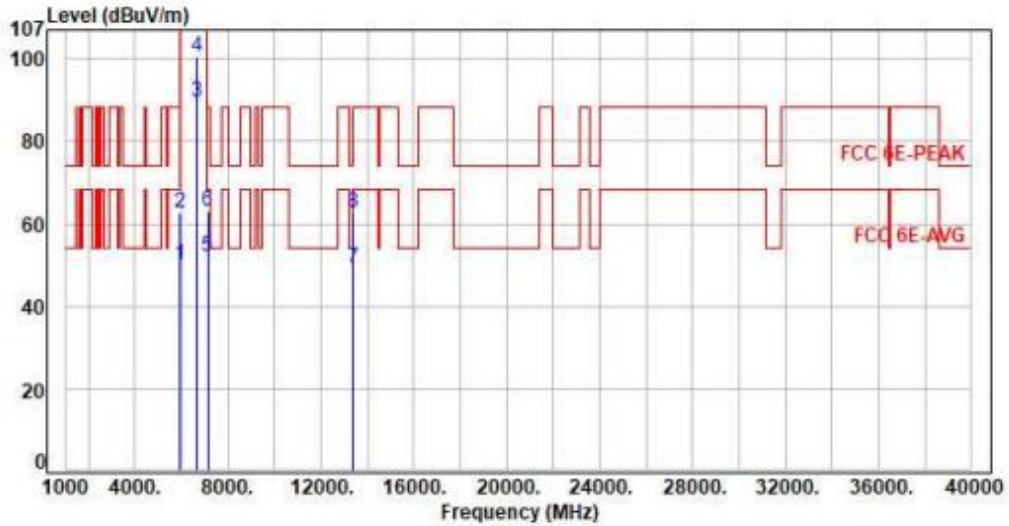

No.	Frequency (MHz)	Factor (dB)	Reading (dBUV)	Level (dBUV/m)	Limit (dBUV/m)	Margin (dB)	Detector	Height (cm)	Azimuth (deg)	P/F
1	5925.00	7.66	42.56	50.22	68.20	-17.98	Average	100	53	P
2	5925.00	7.66	54.99	62.65	88.20	-25.55	Peak	100	53	P
3	6685.00	9.16	80.23	89.39	200.00	-110.61	Average	100	53	P
4	6685.00	9.16	91.50	100.66	200.00	-99.34	Peak	100	53	P
5	7125.00	10.05	42.07	52.12	68.20	-16.08	Average	100	53	P
6	7125.00	10.05	52.93	62.98	88.20	-25.22	Peak	100	53	P
7	13370.00	21.44	27.67	49.11	54.00	-4.89	Average	100	178	P
8	13370.00	21.44	41.07	62.51	74.00	-11.49	Peak	100	178	P

Note: Level=Reading+Factor  
 Margin=Level-Limit  
 Factor=Antenna Factor + cable loss - Amplifier Factor



Power	:	From System (AC120V /60Hz)	Pol/Phase	:	VERTICAL
Test Mode	:	Mode 2, Band 7, CH179		:	

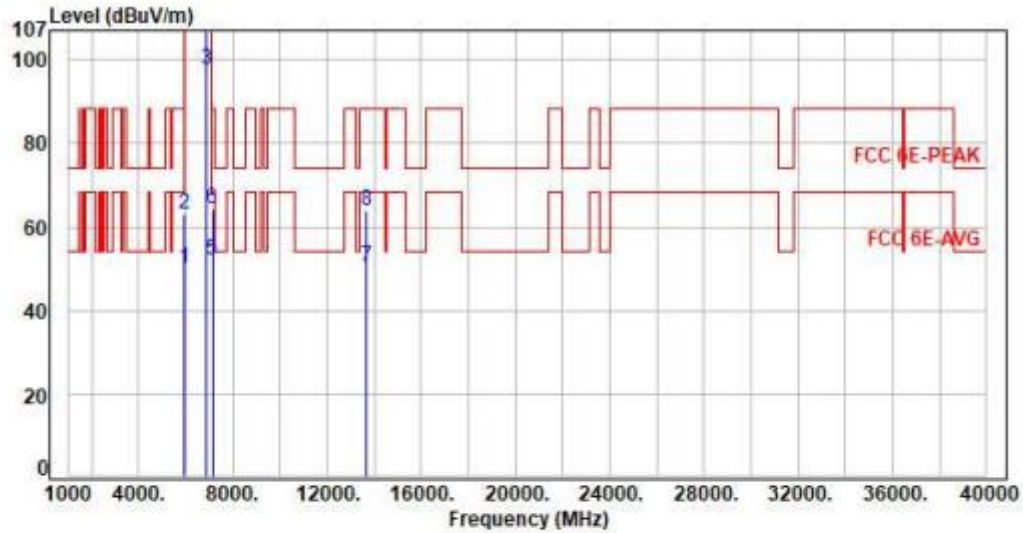

No.	Frequency (MHz)	Factor (dB)	Reading (dBuV)	Level (dBuV/m)	Limit (dBuV/m)	Margin (dB)	Detector	Height (cm)	Azimuth (deg)	P/F
1	5925.00	7.66	42.49	50.15	68.20	-18.05	Average	100	118	P
2	5925.00	7.66	55.21	62.87	88.20	-25.33	Peak	100	118	P
3	6845.00	9.48	88.32	97.80	200.00	-102.20	Average	100	118	P
4	6845.00	9.48	99.66	109.14	200.00	-90.86	Peak	100	118	P
5	7125.00	10.05	41.98	52.03	68.20	-16.17	Average	100	118	P
6	7125.00	10.05	54.26	64.31	88.20	-23.89	Peak	100	118	P
7	13690.00	22.40	28.08	50.48	68.20	-17.72	Average	100	294	P
8	13690.00	22.40	41.47	63.87	88.20	-24.33	Peak	100	294	P

Note: Level=Reading+Factor  
 Margin=Level-Limit  
 Factor=Antenna Factor + cable loss - Amplifier Factor



Power	:	From System (AC120V /60Hz)	Pol/Phase	:	HORIZONTAL
Test Mode	:	Mode 2, Band 7, CH179		:	

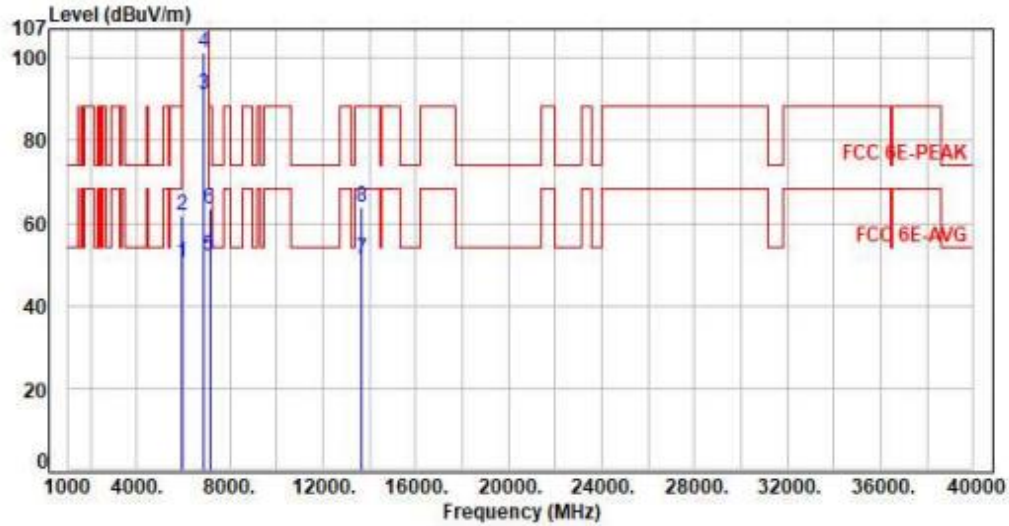

No.	Frequency (MHz)	Factor (dB)	Reading (dBuV)	Level (dBuV/m)	Limit (dBuV/m)	Margin (dB)	Detector	Height (cm)	Azimuth (deg)	P/F
1	5925.00	7.66	42.70	50.36	68.20	-17.84	Average	100	45	P
2	5925.00	7.66	54.07	61.73	88.20	-26.47	Peak	100	45	P
3	6845.00	9.48	81.82	91.30	200.00	-108.70	Average	100	45	P
4	6845.00	9.48	91.80	101.28	200.00	-98.72	Peak	100	45	P
5	7125.00	10.05	41.96	52.01	68.20	-16.19	Average	100	45	P
6	7125.00	10.05	53.57	63.62	88.20	-24.58	Peak	100	45	P
7	13690.00	22.40	28.69	51.09	68.20	-17.11	Average	100	143	P
8	13690.00	22.40	41.28	63.68	88.20	-24.52	Peak	100	143	P

Note: Level=Reading+Factor  
 Margin=Level-Limit  
 Factor=Antenna Factor + cable loss - Amplifier Factor



Power	:	From System (AC120V /60Hz)	Pol/Phase	:	VERTICAL
Test Mode	:	Mode 3, Band 7, CH135		:	

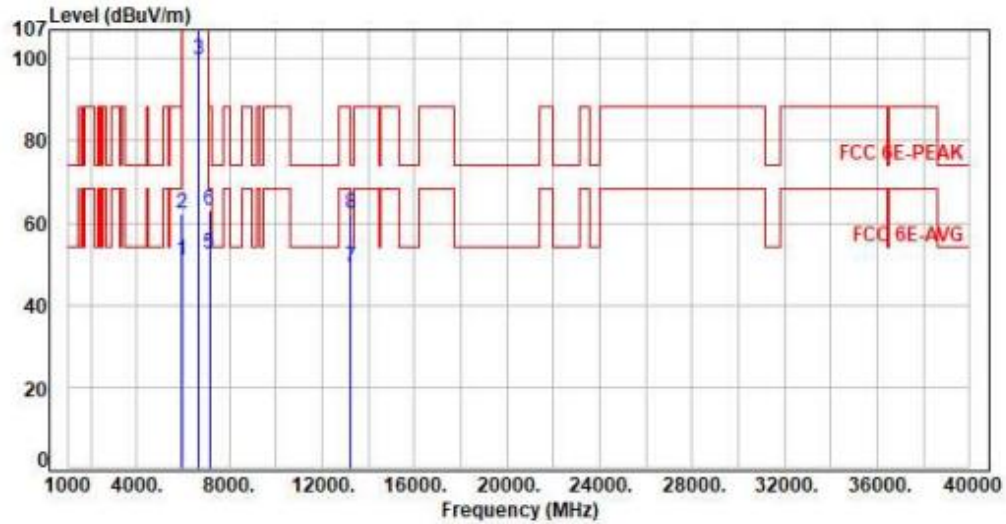

No.	Frequency (MHz)	Factor (dB)	Reading (dBuV)	Level (dBuV/m)	Limit (dBuV/m)	Margin (dB)	Detector	Height (cm)	Azimuth (deg)	P/F
1	5925.00	7.66	43.12	50.78	68.20	-17.42	Average	100	121	P
2	5925.00	7.66	54.39	62.05	88.20	-26.15	Peak	100	121	P
3	6625.00	8.94	90.88	99.82	200.00	-100.18	Average	100	121	P
4	6625.00	8.94	101.18	110.12	200.00	-89.88	Peak	100	121	P
5	7125.00	10.05	42.56	52.61	68.20	-15.59	Average	100	121	P
6	7125.00	10.05	52.86	62.91	88.20	-25.29	Peak	100	121	P
7	13250.00	21.00	28.04	49.04	54.00	-4.96	Average	100	255	P
8	13250.00	21.00	41.07	62.07	74.00	-11.93	Peak	100	255	P

Note: Level=Reading+Factor  
 Margin=Level-Limit  
 Factor=Antenna Factor + cable loss - Amplifier Factor



Power	:	From System (AC120V /60Hz)	Pol/Phase	:	HORIZONTAL
Test Mode	:	Mode 3, Band 7, CH135		:	

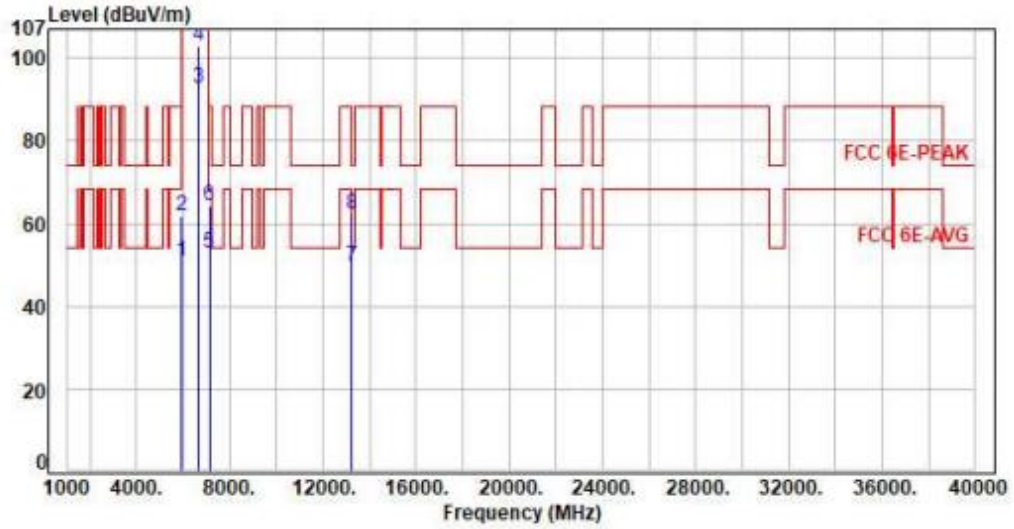

No.	Frequency (MHz)	Factor (dB)	Reading (dBUV)	Level (dBUV/m)	Limit (dBUV/m)	Margin (dB)	Detector	Height (cm)	Azimuth (deg)	P/F
1	5925.00	7.66	43.26	50.92	68.20	-17.28	Average	100	49	P
2	5925.00	7.66	54.27	61.93	88.20	-26.27	Peak	100	49	P
3	6625.00	8.94	83.67	92.61	200.00	-107.39	Average	100	49	P
4	6625.00	8.94	93.99	102.93	200.00	-97.07	Peak	100	49	P
5	7125.00	10.05	42.66	52.71	68.20	-15.49	Average	100	49	P
6	7125.00	10.05	54.08	64.13	88.20	-24.07	Peak	100	49	P
7	13250.00	21.00	28.67	49.67	54.00	-4.33	Average	100	264	P
8	13250.00	21.00	41.21	62.21	74.00	-11.79	Peak	100	264	P

Note: Level=Reading+Factor  
 Margin=Level-Limit  
 Factor=Antenna Factor + cable loss - Amplifier Factor



Power	:	From System (AC120V /60Hz)	Pol/Phase	:	VERTICAL
Test Mode	:	Mode 3, Band 7, CH167		:	

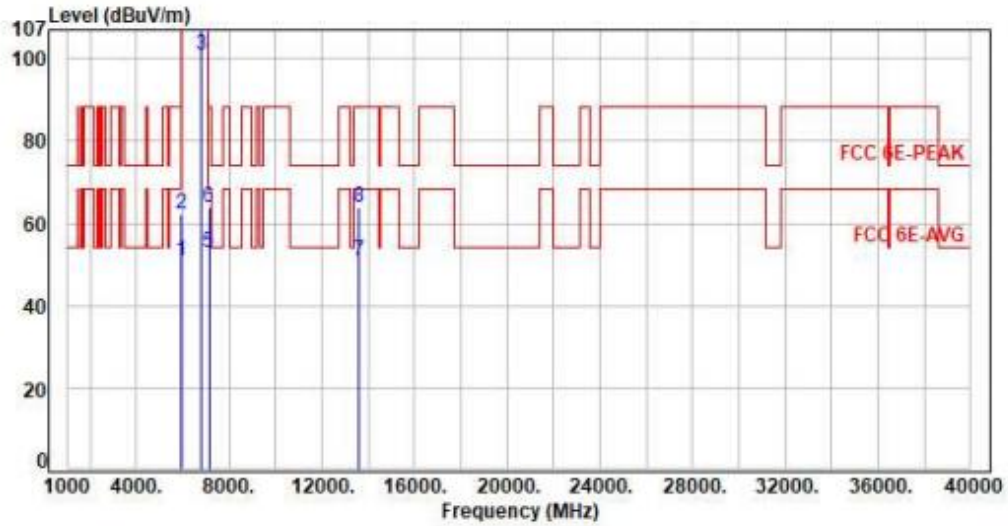

No.	Frequency (MHz)	Factor (dB)	Reading (dBuV)	Level (dBuV/m)	Limit (dBuV/m)	Margin (dB)	Detector	Height (cm)	Azimuth (deg)	P/F
1	5925.00	7.66	43.14	50.80	68.20	-17.40	Average	100	121	P
2	5925.00	7.66	54.78	62.44	88.20	-25.76	Peak	100	121	P
3	6785.00	9.46	91.33	100.79	200.00	-99.21	Average	100	121	P
4	6785.00	9.46	101.82	111.28	200.00	-88.72	Peak	100	121	P
5	7125.00	10.05	42.67	52.72	68.20	-15.48	Average	100	121	P
6	7125.00	10.05	53.70	63.75	88.20	-24.45	Peak	100	121	P
7	13570.00	22.06	28.74	50.80	68.20	-17.40	Average	100	161	P
8	13570.00	22.06	41.70	63.76	88.20	-24.44	Peak	100	161	P

Note: Level=Reading+Factor  
 Margin=Level-Limit  
 Factor=Antenna Factor + cable loss - Amplifier Factor





Power	:	From System (AC120V /60Hz)	Pol/Phase	:	HORIZONTAL
Test Mode	:	Mode 3, Band 7, CH167		:	

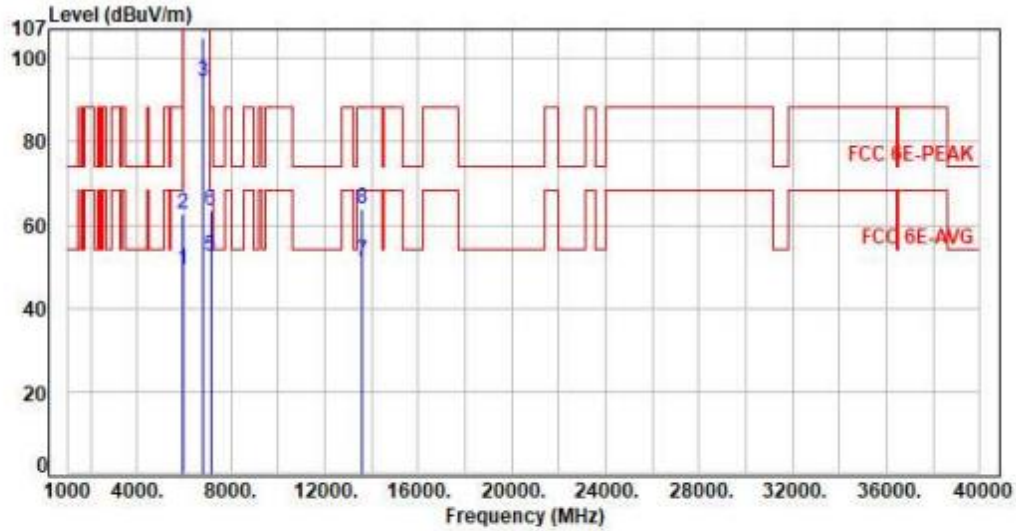

No.	Frequency (MHz)	Factor (dB)	Reading (dBUV)	Level (dBUV/m)	Limit (dBUV/m)	Margin (dB)	Detector	Height (cm)	Azimuth (deg)	P/F
1	5925.00	7.66	41.75	49.41	68.20	-18.79	Average	100	44	P
2	5925.00	7.66	54.93	62.59	88.20	-25.61	Peak	100	44	P
3	6785.00	9.46	84.79	94.25	200.00	-105.75	Average	100	44	P
4	6785.00	9.46	95.44	104.90	200.00	-95.10	Peak	100	44	P
5	7125.00	10.05	42.38	52.43	68.20	-15.77	Average	100	44	P
6	7125.00	10.05	53.46	63.51	88.20	-24.69	Peak	100	44	P
7	13570.00	22.06	29.21	51.27	68.20	-16.93	Average	100	135	P
8	13570.00	22.06	41.97	64.03	88.20	-24.17	Peak	100	135	P

Note: Level=Reading+Factor  
 Margin=Level-Limit  
 Factor=Antenna Factor + cable loss - Amplifier Factor



Power	:	From System (AC120V /60Hz)	Pol/Phase	:	VERTICAL
Test Mode	:	Mode 4, Band 7, CH143		:	

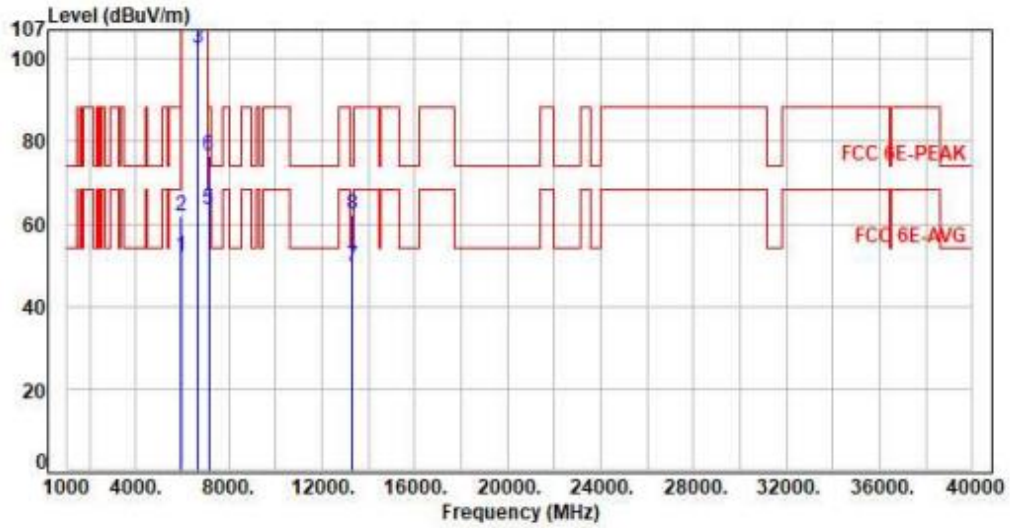

No.	Frequency (MHz)	Factor (dB)	Reading (dBUV)	Level (dBUV/m)	Limit (dBUV/m)	Margin (dB)	Detector	Height (cm)	Azimuth (deg)	P/F
1	5925.00	7.66	44.61	52.27	68.20	-15.93	Average	100	121	P
2	5925.00	7.66	54.17	61.83	88.20	-26.37	Peak	100	121	P
3	6665.00	9.08	93.32	102.40	200.00	-97.60	Average	100	121	P
4	6665.00	9.08	102.84	111.92	200.00	-88.08	Peak	100	121	P
5	7125.00	10.05	53.55	63.60	68.20	-4.60	Average	100	121	P
6	7125.00	10.05	66.57	76.62	88.20	-11.58	Peak	100	121	P
7	13330.00	21.30	28.34	49.64	54.00	-4.36	Average	100	215	P
8	13330.00	21.30	40.79	62.09	74.00	-11.91	Peak	100	215	P

Note: Level=Reading+Factor  
 Margin=Level-Limit  
 Factor=Antenna Factor + cable loss - Amplifier Factor



Power	:	From System (AC120V /60Hz)	Pol/Phase	:	HORIZONTAL
Test Mode	:	Mode 4, Band 7, CH143		:	

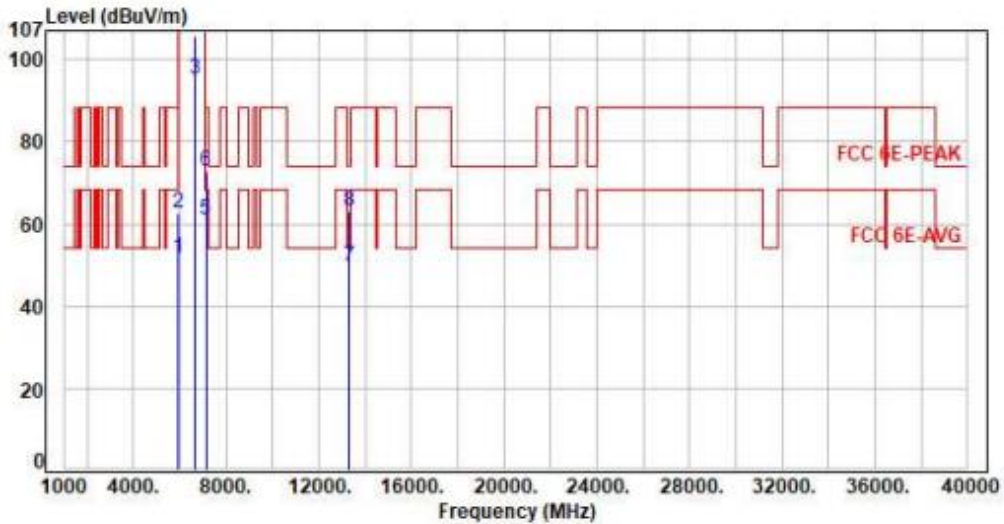

No.	Frequency (MHz)	Factor (dB)	Reading (dBuV)	Level (dBuV/m)	Limit (dBuV/m)	Margin (dB)	Detector	Height (cm)	Azimuth (deg)	P/F
1	5925.00	7.66	44.13	51.79	68.20	-16.41	Average	100	55	P
2	5925.00	7.66	54.93	62.59	88.20	-25.61	Peak	100	55	P
3	6665.00	9.08	86.18	95.26	200.00	-104.74	Average	100	55	P
4	6665.00	9.08	96.74	105.82	200.00	-94.18	Peak	100	55	P
5	7125.00	10.05	50.87	60.92	68.20	-7.28	Average	100	55	P
6	7125.00	10.05	62.90	72.95	88.20	-15.25	Peak	100	55	P
7	13330.00	21.30	28.46	49.76	54.00	-4.24	Average	100	224	P
8	13330.00	21.30	41.65	62.95	74.00	-11.05	Peak	100	224	P

Note: Level=Reading+Factor  
 Margin=Level-Limit  
 Factor=Antenna Factor + cable loss - Amplifier Factor



Power	: From System (AC120V /60Hz)	Pol/Phase	: VERTICAL
Test Mode	: Mode 1, Band 7 Straddle Channel, CH185		:

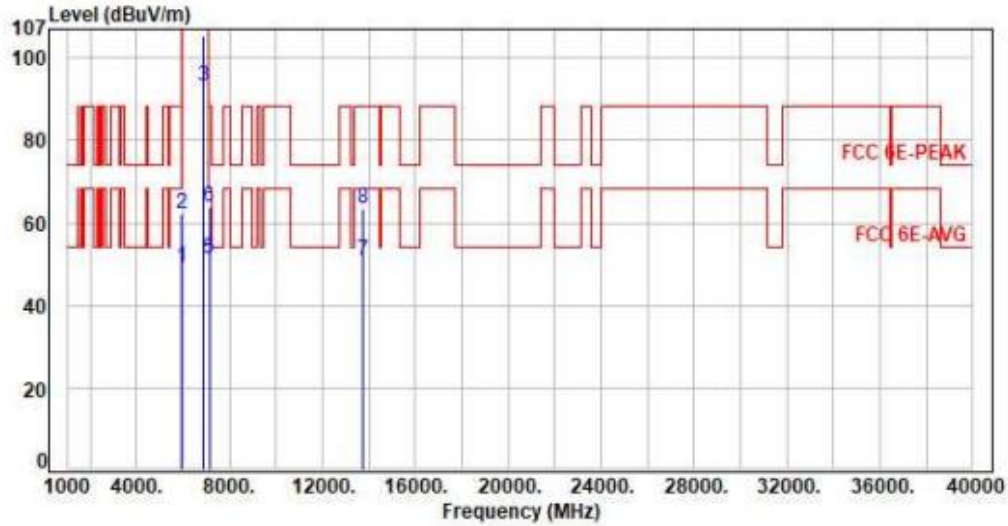

No.	Frequency (MHz)	Factor (dB)	Reading (dBuV)	Level (dBuV/m)	Limit (dBuV/m)	Margin (dB)	Detector	Height (cm)	Azimuth (deg)	P/F
1	5925.00	7.66	41.69	49.35	68.20	-18.85	Average	100	121	P
2	5925.00	7.66	54.62	62.28	88.20	-25.92	Peak	100	121	P
3	6875.00	9.55	83.43	92.98	200.00	-107.02	Average	100	121	P
4	6875.00	9.55	95.84	105.39	200.00	-94.61	Peak	100	121	P
5	7125.00	10.05	41.12	51.17	68.20	-17.03	Average	100	121	P
6	7125.00	10.05	53.96	64.01	88.20	-24.19	Peak	100	121	P
7	13750.00	22.65	28.20	50.85	68.20	-17.35	Average	100	163	P
8	13750.00	22.65	40.86	63.51	88.20	-24.69	Peak	100	163	P

Note: Level=Reading+Factor  
 Margin=Level-Limit  
 Factor=Antenna Factor + cable loss - Amplifier Factor



Power	: From System (AC120V /60Hz)	Pol/Phase	: HORIZONTAL
Test Mode	: Mode 1, Band 7 Straddle Channel, CH185		:

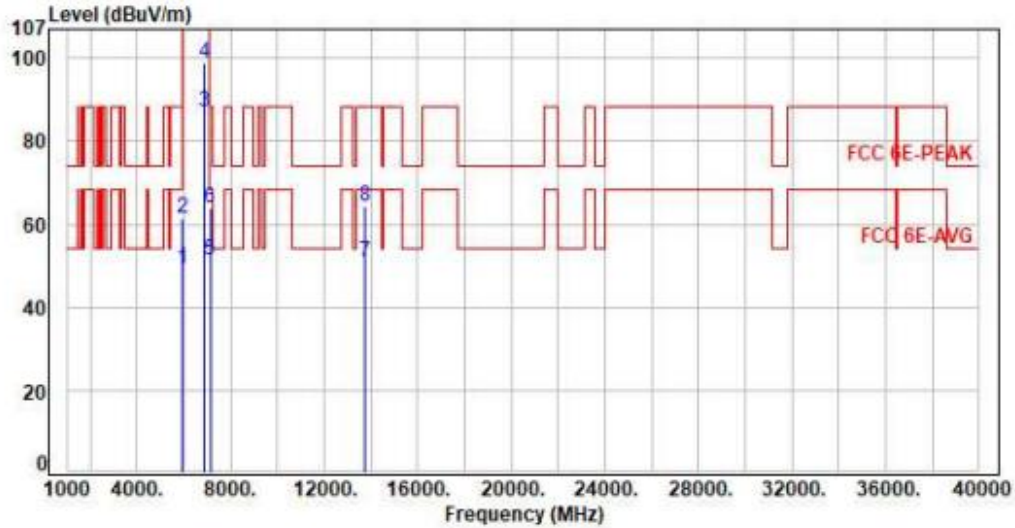

No.	Frequency (MHz)	Factor (dB)	Reading (dBuV)	Level (dBuV/m)	Limit (dBuV/m)	Margin (dB)	Detector	Height (cm)	Azimuth (deg)	P/F
1	5925.00	7.66	41.42	49.08	68.20	-19.12	Average	100	45	P
2	5925.00	7.66	53.93	61.59	88.20	-26.61	Peak	100	45	P
3	6875.00	9.55	77.50	87.05	200.00	-112.95	Average	100	45	P
4	6875.00	9.55	89.34	98.89	200.00	-101.11	Peak	100	45	P
5	7125.00	10.05	41.25	51.30	68.20	-16.90	Average	100	45	P
6	7125.00	10.05	53.87	63.92	88.20	-24.28	Peak	100	45	P
7	13750.00	22.65	28.22	50.87	68.20	-17.33	Average	100	231	P
8	13750.00	22.65	41.76	64.41	88.20	-23.79	Peak	100	231	P

Note: Level=Reading+Factor  
 Margin=Level-Limit  
 Factor=Antenna Factor + cable loss - Amplifier Factor



Power	: From System (AC120V /60Hz)	Pol/Phase	: VERTICAL
Test Mode	: Mode 2, Band 7 Straddle Channel, CH187		:

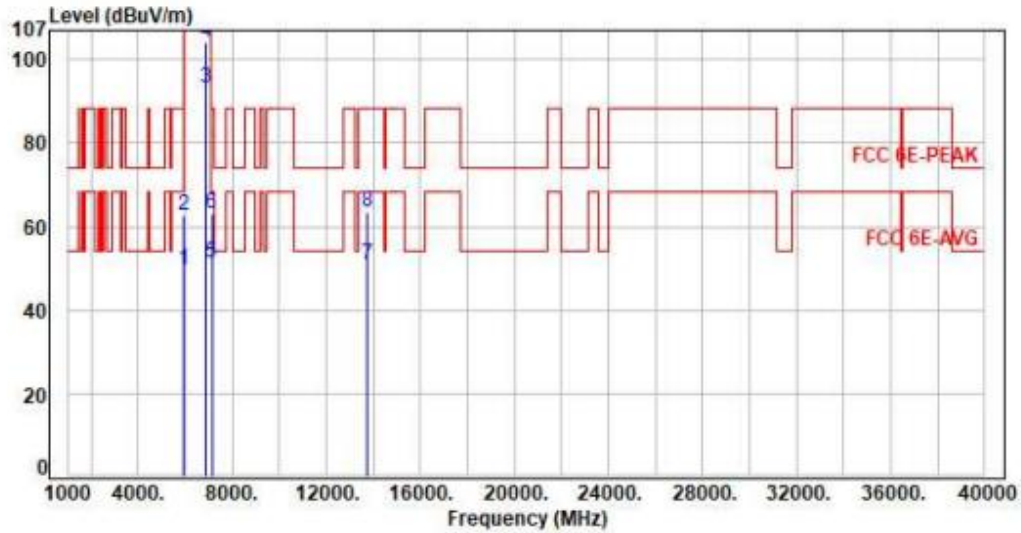

No.	Frequency (MHz)	Factor (dB)	Reading (dBuV)	Level (dBuV/m)	Limit (dBuV/m)	Margin (dB)	Detector	Height (cm)	Azimuth (deg)	P/F
1	5925.00	7.66	41.97	49.63	68.20	-18.57	Average	100	116	P
2	5925.00	7.66	54.83	62.49	88.20	-25.71	Peak	100	116	P
3	6885.00	9.56	83.71	93.27	200.00	-106.73	Average	100	116	P
4	6885.00	9.56	94.68	104.24	200.00	-95.76	Peak	100	116	P
5	7125.00	10.05	41.38	51.43	68.20	-16.77	Average	100	116	P
6	7125.00	10.05	53.04	63.09	88.20	-25.11	Peak	100	116	P
7	13770.00	22.69	28.02	50.71	68.20	-17.49	Average	100	322	P
8	13770.00	22.69	40.94	63.63	88.20	-24.57	Peak	100	322	P

Note: Level=Reading+Factor  
 Margin=Level-Limit  
 Factor=Antenna Factor + cable loss - Amplifier Factor



Power	: From System (AC120V /60Hz)	Pol/Phase	: HORIZONTAL
Test Mode	: Mode 2, Band 7 Straddle Channel, CH187		:

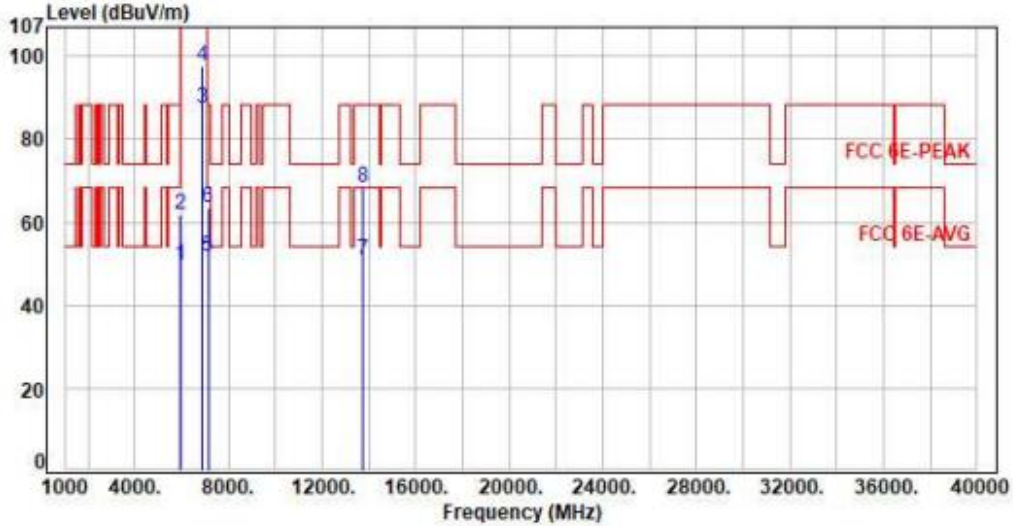

No.	Frequency (MHz)	Factor (dB)	Reading (dBuV)	Level (dBuV/m)	Limit (dBuV/m)	Margin (dB)	Detector	Height (cm)	Azimuth (deg)	P/F
1	5925.00	7.66	41.85	49.51	68.20	-18.69	Average	100	52	P
2	5925.00	7.66	53.99	61.65	88.20	-26.55	Peak	100	52	P
3	6885.00	9.56	77.73	87.29	200.00	-112.71	Average	100	52	P
4	6885.00	9.56	87.90	97.46	200.00	-102.54	Peak	100	52	P
5	7125.00	10.05	41.63	51.68	68.20	-16.52	Average	100	52	P
6	7125.00	10.05	53.32	63.37	88.20	-24.83	Peak	100	52	P
7	13770.00	22.69	28.19	50.88	68.20	-17.32	Average	100	193	P
8	13770.00	22.69	45.69	68.38	88.20	-19.82	Peak	100	193	P

Note: Level=Reading+Factor  
 Margin=Level-Limit  
 Factor=Antenna Factor + cable loss - Amplifier Factor



Power	: From System (AC120V /60Hz)	Pol/Phase	: VERTICAL
Test Mode	: Mode 3, Band 7 Straddle Channel, CH183		:

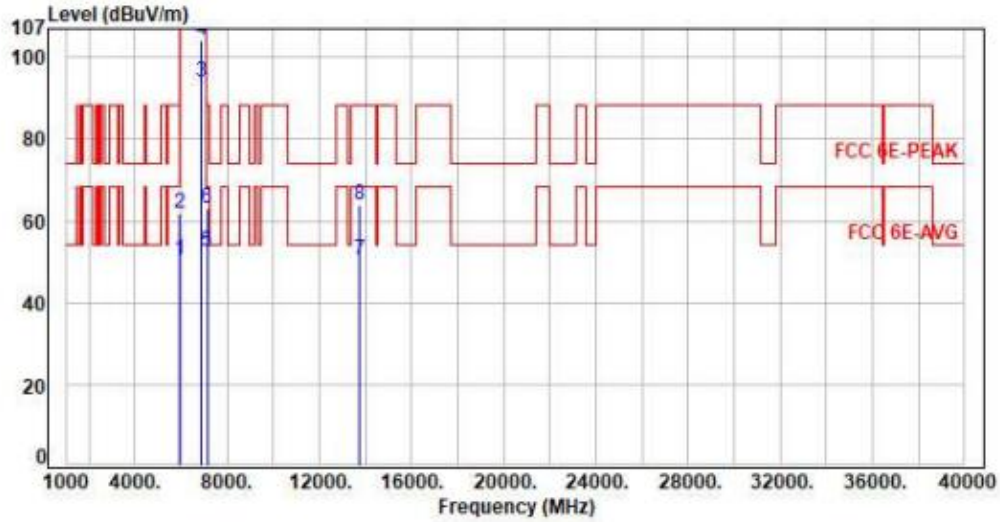

No.	Frequency (MHz)	Factor (dB)	Reading (dBuV)	Level (dBuV/m)	Limit (dBuV/m)	Margin (dB)	Detector	Height (cm)	Azimuth (deg)	P/F
1	5925.00	7.66	42.73	50.39	68.20	-17.81	Average	100	120	P
2	5925.00	7.66	54.09	61.75	88.20	-26.45	Peak	100	120	P
3	6865.00	9.52	84.54	94.06	200.00	-105.94	Average	100	120	P
4	6865.00	9.52	94.66	104.18	200.00	-95.82	Peak	100	120	P
5	7125.00	10.05	42.31	52.36	68.20	-15.84	Average	100	120	P
6	7125.00	10.05	53.07	63.12	88.20	-25.08	Peak	100	120	P
7	13730.00	22.57	28.06	50.63	68.20	-17.57	Average	100	211	P
8	13730.00	22.57	41.36	63.93	88.20	-24.27	Peak	100	211	P

Note: Level=Reading+Factor  
 Margin=Level-Limit  
 Factor=Antenna Factor + cable loss - Amplifier Factor





Power	: From System (AC120V /60Hz)	Pol/Phase	: HORIZONTAL
Test Mode	: Mode 3, Band 7 Straddle Channel, CH183		:

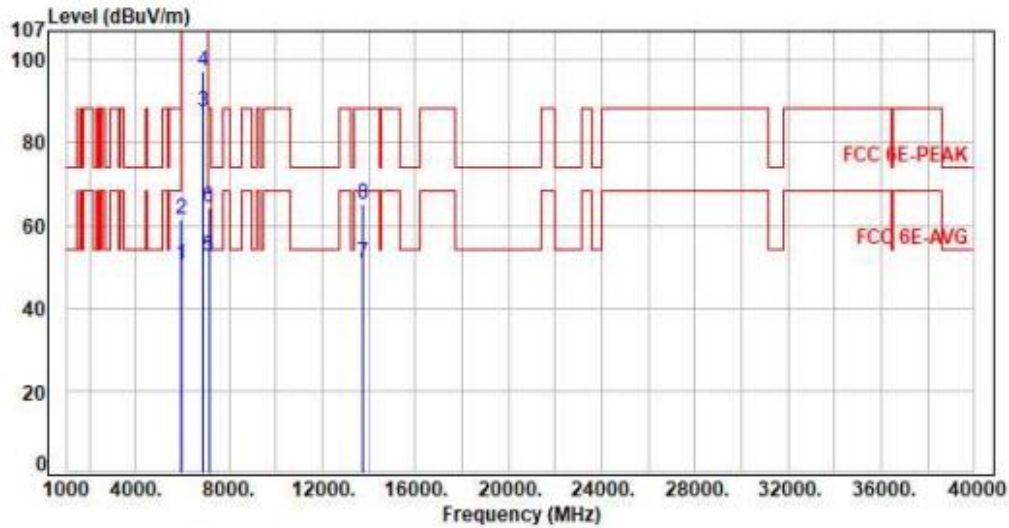

No.	Frequency (MHz)	Factor (dB)	Reading (dBuV)	Level (dBuV/m)	Limit (dBuV/m)	Margin (dB)	Detector	Height (cm)	Azimuth (deg)	P/F
1	5925.00	7.66	42.85	50.51	68.20	-17.69	Average	100	50	P
2	5925.00	7.66	53.76	61.42	88.20	-26.78	Peak	100	50	P
3	6865.00	9.52	77.84	87.36	200.00	-112.64	Average	100	50	P
4	6865.00	9.52	87.88	97.40	200.00	-102.60	Peak	100	50	P
5	7125.00	10.05	42.39	52.44	68.20	-15.76	Average	100	50	P
6	7125.00	10.05	54.04	64.09	88.20	-24.11	Peak	100	50	P
7	13730.00	22.57	28.11	50.68	68.20	-17.52	Average	100	109	P
8	13730.00	22.57	42.66	65.23	88.20	-22.97	Peak	100	109	P

Note: Level=Reading+Factor  
 Margin=Level-Limit  
 Factor=Antenna Factor + cable loss - Amplifier Factor



Power	:	From System (AC120V /60Hz)	Pol/Phase	:	VERTICAL
Test Mode	:	Mode 4, Band 7 Straddle Channel, CH175		:	

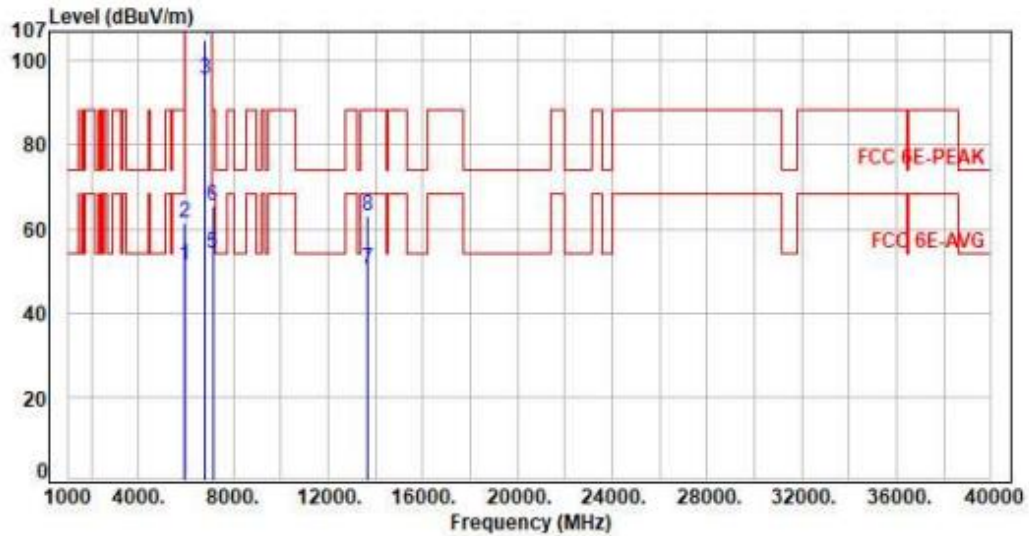

No.	Frequency (MHz)	Factor (dB)	Reading (dBuV)	Level (dBuV/m)	Limit (dBuV/m)	Margin (dB)	Detector	Height (cm)	Azimuth (deg)	P/F
1	5925.00	7.66	43.60	51.26	68.20	-16.94	Average	100	148	P
2	5925.00	7.66	53.69	61.35	88.20	-26.85	Peak	100	148	P
3	6825.00	9.47	86.19	95.66	200.00	-104.34	Average	100	148	P
4	6825.00	9.47	95.52	104.99	200.00	-95.01	Peak	100	148	P
5	7125.00	10.05	44.05	54.10	68.20	-14.10	Average	100	148	P
6	7125.00	10.05	55.57	65.62	88.20	-22.58	Peak	100	148	P
7	13650.00	22.24	28.21	50.45	68.20	-17.75	Average	100	269	P
8	13650.00	22.24	40.75	62.99	88.20	-25.21	Peak	100	269	P

Note: Level=Reading+Factor  
 Margin=Level-Limit  
 Factor=Antenna Factor + cable loss - Amplifier Factor



Power	:	From System (AC120V /60Hz)	Pol/Phase	:	HORIZONTAL
Test Mode	:	Mode 4, Band 7 Straddle Channel, CH175		:	

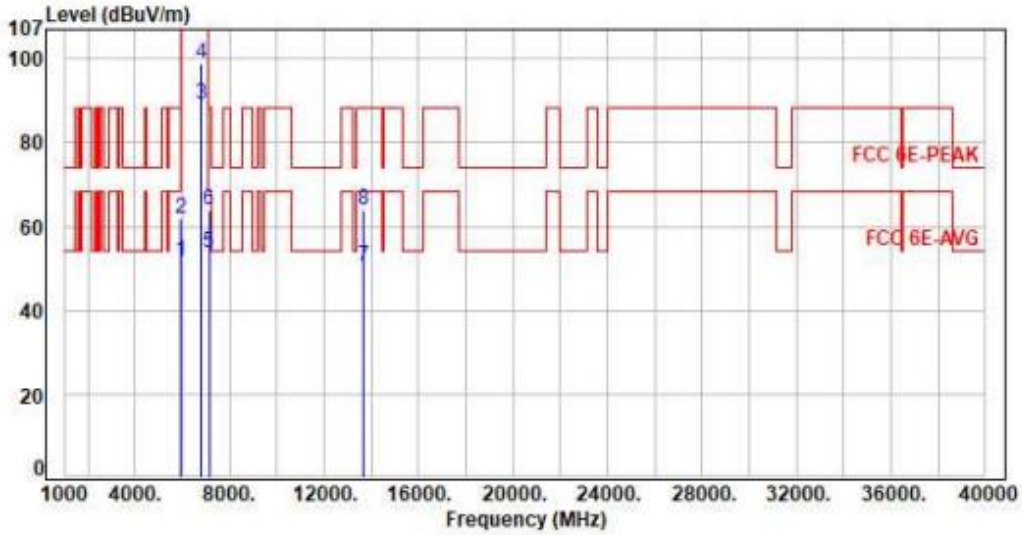

No.	Frequency (MHz)	Factor (dB)	Reading (dBuV)	Level (dBuV/m)	Limit (dBuV/m)	Margin (dB)	Detector	Height (cm)	Azimuth (deg)	P/F
1	5925.00	7.66	43.99	51.65	68.20	-16.55	Average	100	49	P
2	5925.00	7.66	54.34	62.00	88.20	-26.20	Peak	100	49	P
3	6825.00	9.47	79.44	88.91	200.00	-111.09	Average	100	49	P
4	6825.00	9.47	89.20	98.67	200.00	-101.33	Peak	100	49	P
5	7125.00	10.05	43.73	53.78	68.20	-14.42	Average	100	49	P
6	7125.00	10.05	53.86	63.91	88.20	-24.29	Peak	100	49	P
7	13650.00	22.24	28.05	50.29	68.20	-17.91	Average	100	153	P
8	13650.00	22.24	41.69	63.93	88.20	-24.27	Peak	100	153	P

Note: Level=Reading+Factor  
 Margin=Level-Limit  
 Factor=Antenna Factor + cable loss - Amplifier Factor



Power	:	From System (AC120V /60Hz)	Pol/Phase	:	VERTICAL
Test Mode	:	Mode 1, Band 8, CH209		:	

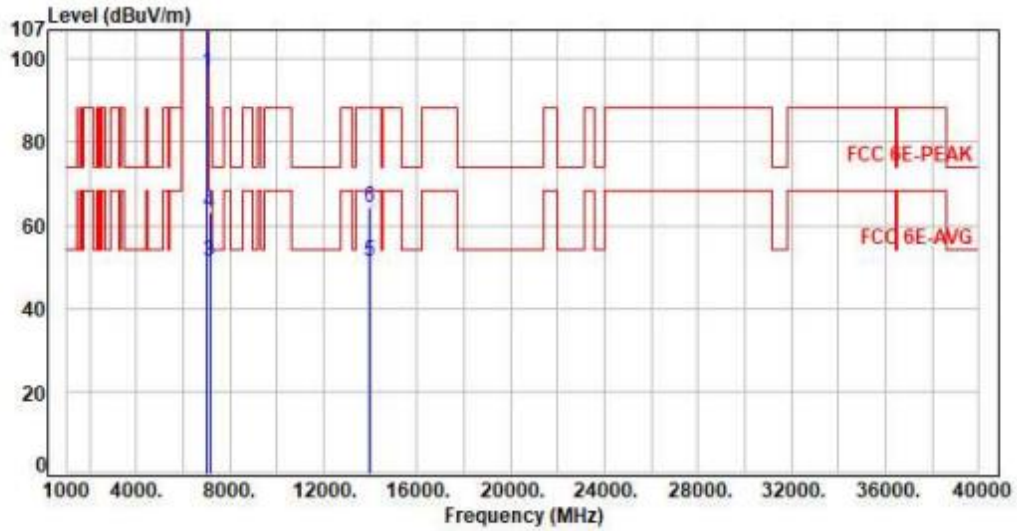

No.	Frequency (MHz)	Factor (dB)	Reading (dBuV)	Level (dBuV/m)	Limit (dBuV/m)	Margin (dB)	Detector	Height (cm)	Azimuth (deg)	P/F
1	6995.00	9.64	87.35	96.99	200.00	-103.01	Average	100	145	P
2	6995.00	9.64	99.34	108.98	200.00	-91.02	Peak	100	145	P
3	7125.00	10.05	41.04	51.09	68.20	-17.11	Average	100	145	P
4	7125.00	10.05	53.02	63.07	88.20	-25.13	Peak	100	145	P
5	13990.00	23.24	28.11	51.35	68.20	-16.85	Average	100	223	P
6	13990.00	23.24	41.18	64.42	88.20	-23.78	Peak	100	223	P

Note: Level=Reading+Factor  
 Margin=Level-Limit  
 Factor=Antenna Factor + cable loss - Amplifier Factor



Power	:	From System (AC120V /60Hz)	Pol/Phase	:	HORIZONTAL
Test Mode	:	Mode 1, Band 8, CH209		:	

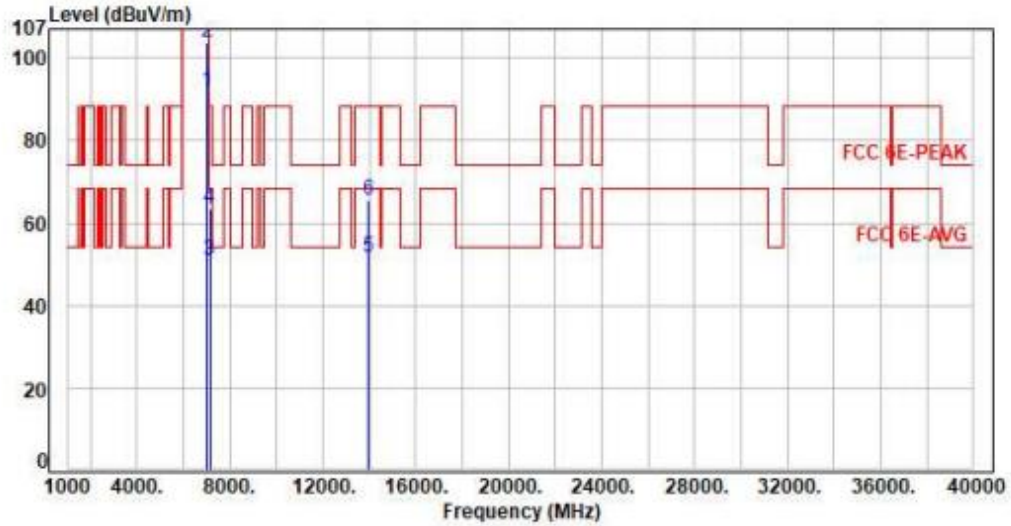

No.	Frequency (MHz)	Factor (dB)	Reading (dBuV)	Level (dBuV/m)	Limit (dBuV/m)	Margin (dB)	Detector	Height (cm)	Azimuth (deg)	P/F
1	6995.00	9.64	82.31	91.95	200.00	-108.05	Average	100	46	P
2	6995.00	9.64	94.11	103.75	200.00	-96.25	Peak	100	46	P
3	7125.00	10.05	40.74	50.79	68.20	-17.41	Average	100	46	P
4	7125.00	10.05	53.48	63.53	88.20	-24.67	Peak	100	46	P
5	13990.00	23.24	28.44	51.68	68.20	-16.52	Average	100	315	P
6	13990.00	23.24	42.44	65.68	88.20	-22.52	Peak	100	315	P

Note: Level=Reading+Factor  
 Margin=Level-Limit  
 Factor=Antenna Factor + cable loss - Amplifier Factor



Power	:	From System (AC120V /60Hz)	Pol/Phase	:	VERTICAL
Test Mode	:	Mode 1, Band 8, CH233		:	

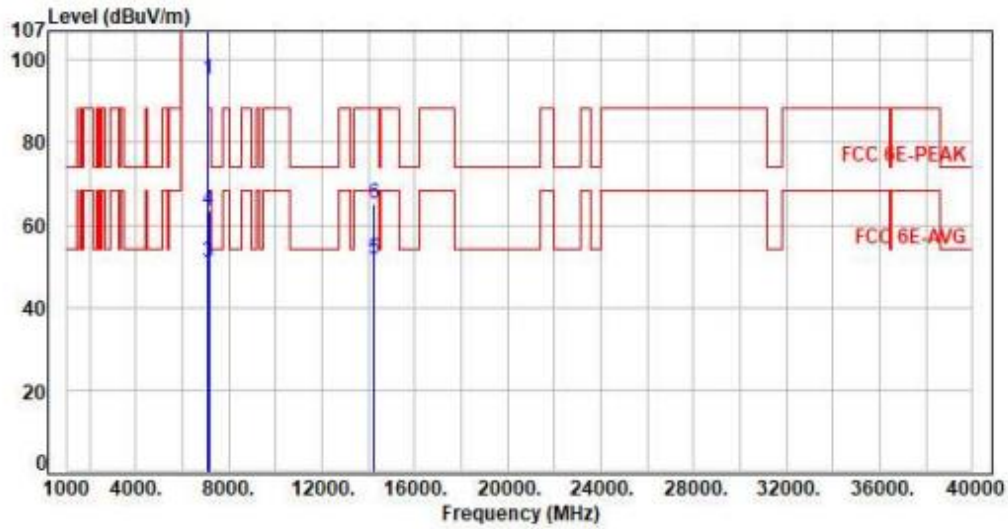

No.	Frequency (MHz)	Factor (dB)	Reading (dBuV)	Level (dBuV/m)	Limit (dBuV/m)	Margin (dB)	Detector	Height (cm)	Azimuth (deg)	P/F
1	7115.00	10.02	85.02	95.04	200.00	-104.96	Average	132	116	P
2	7115.00	10.02	96.83	106.85	200.00	-93.15	Peak	132	116	P
3	7125.00	10.05	40.90	50.95	68.20	-17.25	Average	132	116	P
4	7125.00	10.05	53.40	63.45	88.20	-24.75	Peak	132	116	P
5	14230.00	23.94	27.88	51.82	68.20	-16.38	Average	100	138	P
6	14230.00	23.94	41.23	65.17	88.20	-23.03	Peak	100	138	P

Note: Level=Reading+Factor  
 Margin=Level-Limit  
 Factor=Antenna Factor + cable loss - Amplifier Factor



Power	:	From System (AC120V /60Hz)	Pol/Phase	:	HORIZONTAL
Test Mode	:	Mode 1, Band 8, CH233		:	

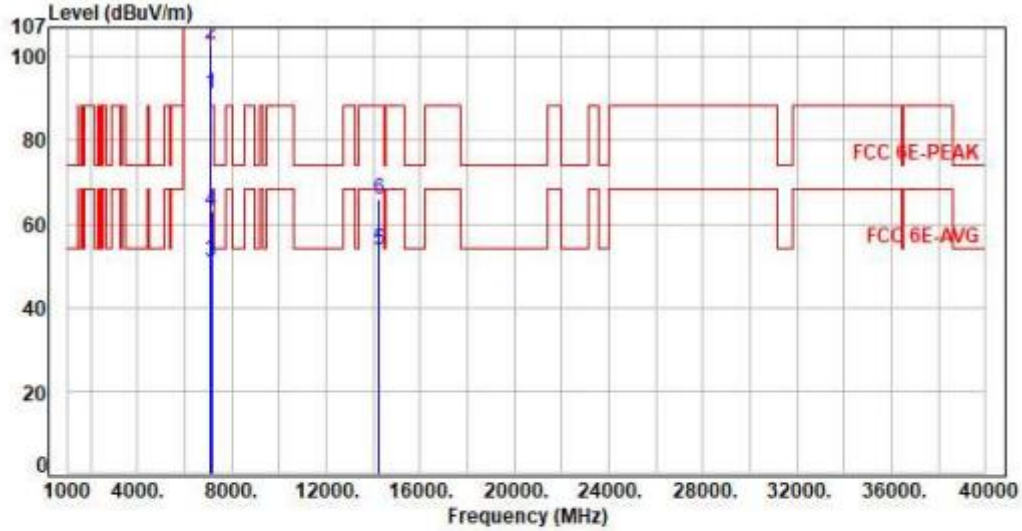

No.	Frequency (MHz)	Factor (dB)	Reading (dBuV)	Level (dBuV/m)	Limit (dBuV/m)	Margin (dB)	Detector	Height (cm)	Azimuth (deg)	P/F
1	7115.00	10.02	80.97	90.99	200.00	-109.01	Average	100	40	P
2	7115.00	10.02	93.01	103.03	200.00	-96.97	Peak	100	40	P
3	7125.00	10.05	40.86	50.91	68.20	-17.29	Average	100	40	P
4	7125.00	10.05	53.20	63.25	88.20	-24.95	Peak	100	40	P
5	14230.00	23.94	29.66	53.60	68.20	-14.60	Average	100	245	P
6	14230.00	23.94	41.92	65.86	88.20	-22.34	Peak	100	245	P

Note: Level=Reading+Factor  
 Margin=Level-Limit  
 Factor=Antenna Factor + cable loss - Amplifier Factor



Power	:	From System (AC120V /60Hz)	Pol/Phase	:	VERTICAL
Test Mode	:	Mode 2, Band 8, CH203		:	

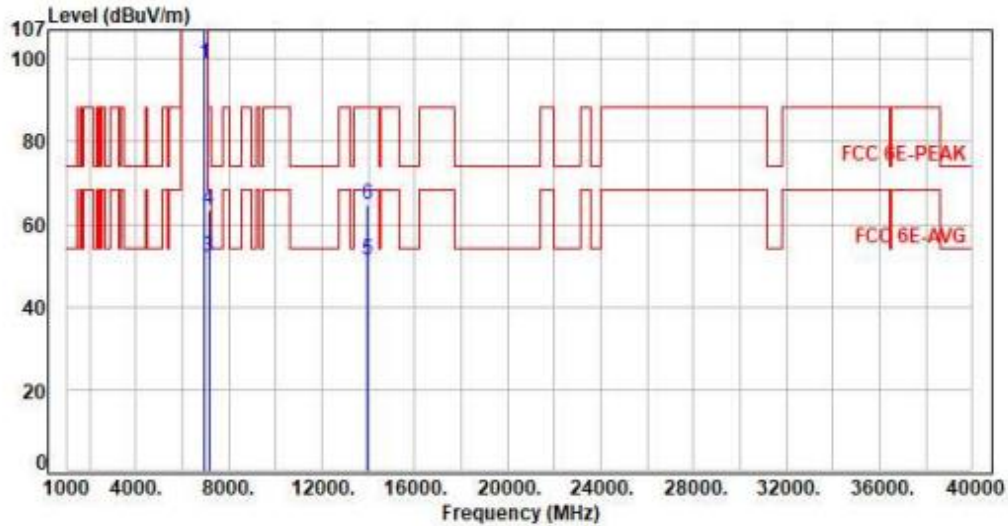

No.	Frequency (MHz)	Factor (dB)	Reading (dBuV)	Level (dBuV/m)	Limit (dBuV/m)	Margin (dB)	Detector	Height (cm)	Azimuth (deg)	P/F
1	6965.00	9.63	89.11	98.74	200.00	-101.26	Average	100	145	P
2	6965.00	9.63	101.08	110.71	200.00	-89.29	Peak	100	145	P
3	7125.00	10.05	41.07	51.92	68.20	-16.28	Average	100	145	P
4	7125.00	10.05	53.23	63.28	88.20	-24.92	Peak	100	145	P
5	13930.00	23.04	28.36	51.40	68.20	-16.80	Average	100	172	P
6	13930.00	23.04	41.82	64.86	88.20	-23.34	Peak	100	172	P

Note: Level=Reading+Factor  
 Margin=Level-Limit  
 Factor=Antenna Factor + cable loss - Amplifier Factor





Power	:	From System (AC120V /60Hz)	Pol/Phase	:	HORIZONTAL
Test Mode	:	Mode 2, Band 8, CH203		:	

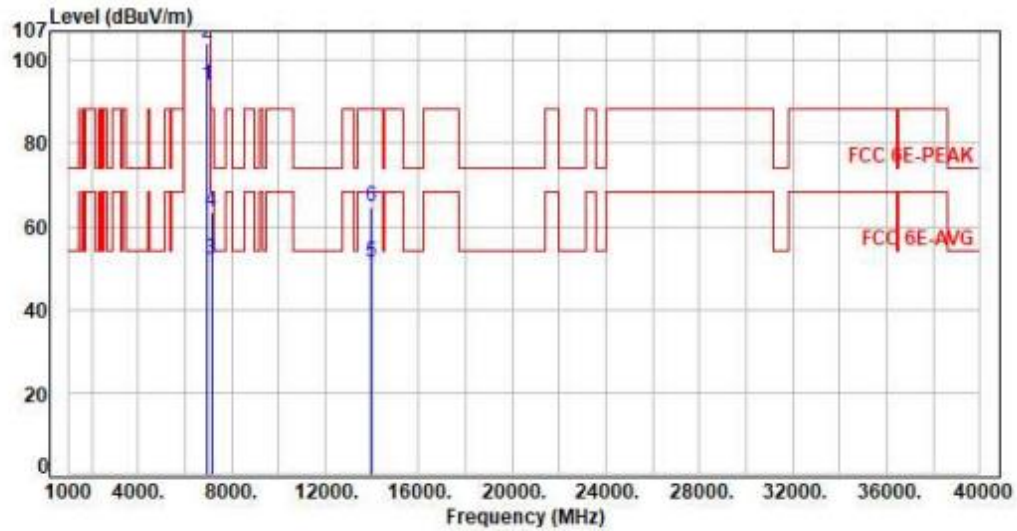

No.	Frequency (MHz)	Factor (dB)	Reading (dBuV)	Level (dBuV/m)	Limit (dBuV/m)	Margin (dB)	Detector	Height (cm)	Azimuth (deg)	P/F
1	6965.00	9.63	84.21	93.84	200.00	-106.16	Average	100	48	P
2	6965.00	9.63	94.71	104.34	200.00	-95.66	Peak	100	48	P
3	7125.00	10.05	42.05	52.10	68.20	-16.10	Average	100	48	P
4	7125.00	10.05	53.43	63.48	88.20	-24.72	Peak	100	48	P
5	13930.00	23.04	28.37	51.41	68.20	-16.79	Average	100	233	P
6	13930.00	23.04	41.54	64.58	88.20	-23.62	Peak	100	233	P

Note: Level=Reading+Factor  
 Margin=Level-Limit  
 Factor=Antenna Factor + cable loss - Amplifier Factor



Power	:	From System (AC120V /60Hz)	Pol/Phase	:	VERTICAL
Test Mode	:	Mode 2, Band 8, CH227		:	

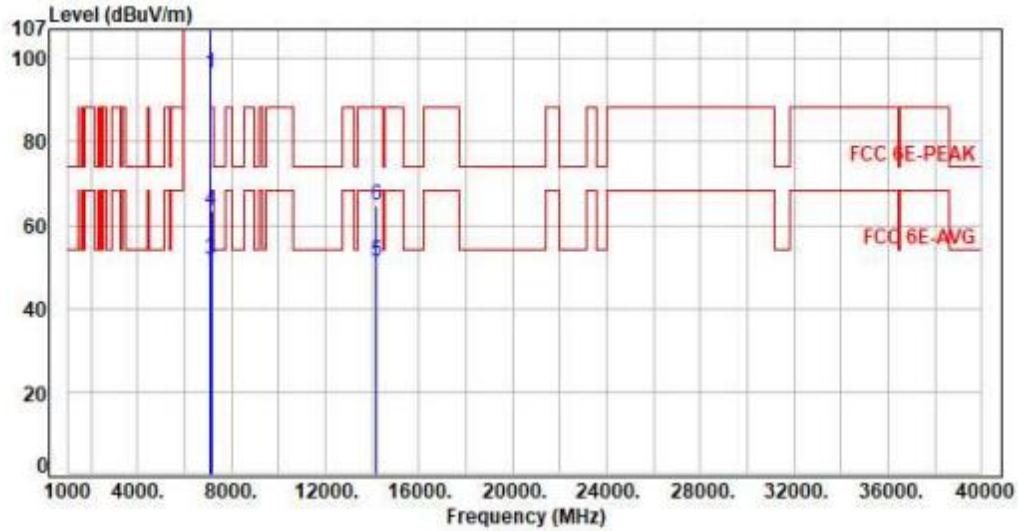

No.	Frequency (MHz)	Factor (dB)	Reading (dBuV)	Level (dBuV/m)	Limit (dBuV/m)	Margin (dB)	Detector	Height (cm)	Azimuth (deg)	P/F
1	7085.00	9.91	86.60	96.51	200.00	-103.49	Average	100	144	P
2	7085.00	9.91	97.53	107.44	200.00	-92.56	Peak	100	144	P
3	7125.00	10.05	41.66	51.71	68.20	-16.49	Average	100	144	P
4	7125.00	10.05	53.52	63.57	88.20	-24.63	Peak	100	144	P
5	14170.00	23.72	27.50	51.22	68.20	-16.98	Average	100	138	P
6	14170.00	23.72	41.02	64.74	88.20	-23.46	Peak	100	138	P

Note: Level=Reading+Factor  
Margin=Level-Limit  
Factor=Antenna Factor + cable loss - Amplifier Factor



Power	:	From System (AC120V /60Hz)	Pol/Phase	:	HORIZONTAL
Test Mode	:	Mode 2, Band 8, CH227		:	

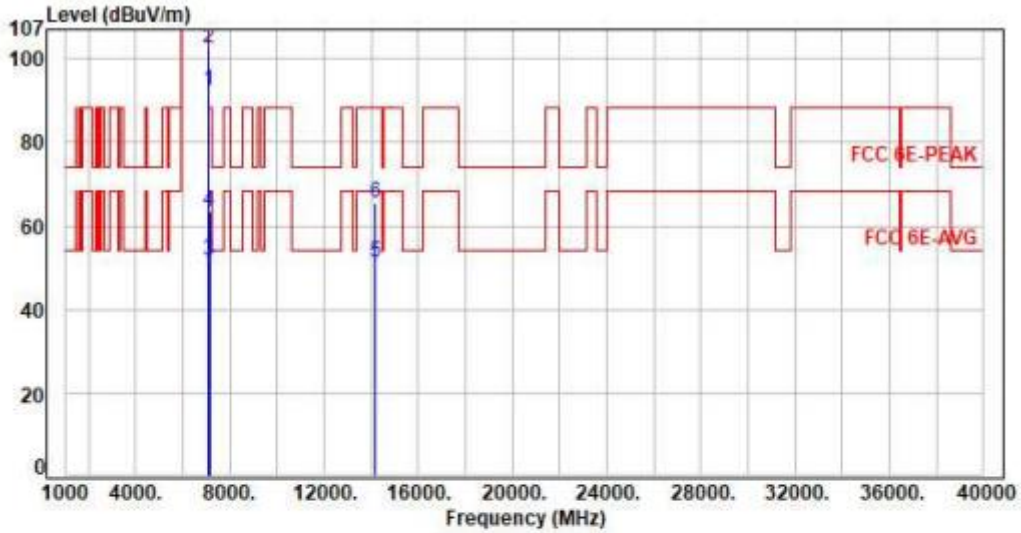

No.	Frequency (MHz)	Factor (dB)	Reading (dBuV)	Level (dBuV/m)	Limit (dBuV/m)	Margin (dB)	Detector	Height (cm)	Azimuth (deg)	P/F
1	7085.00	9.91	82.60	92.51	200.00	-107.49	Average	100	45	P
2	7085.00	9.91	92.62	102.53	200.00	-97.47	Peak	100	45	P
3	7125.00	10.05	41.61	51.66	68.20	-16.54	Average	100	45	P
4	7125.00	10.05	53.28	63.33	88.20	-24.87	Peak	100	45	P
5	14170.00	23.72	27.54	51.26	68.20	-16.94	Average	100	122	P
6	14170.00	23.72	41.68	65.40	88.20	-22.80	Peak	100	122	P

Note: Level=Reading+Factor  
 Margin=Level-Limit  
 Factor=Antenna Factor + cable loss - Amplifier Factor



Power	:	From System (AC120V /60Hz)	Pol/Phase	:	VERTICAL
Test Mode	:	Mode 3, Band 8, CH199		:	

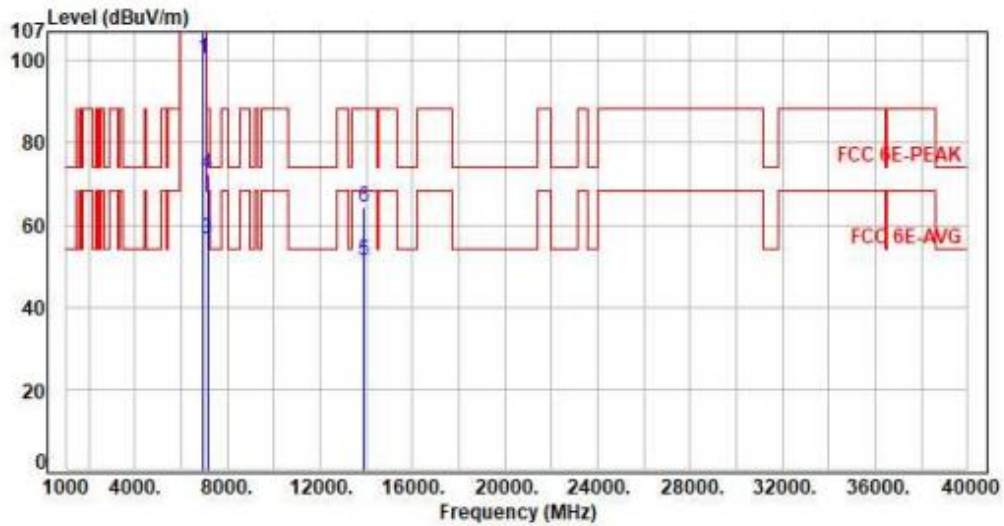

No.	Frequency (MHz)	Factor (dB)	Reading (dBuV)	Level (dBuV/m)	Limit (dBuV/m)	Margin (dB)	Detector	Height (cm)	Azimuth (deg)	P/F
1	6945.00	9.62	90.75	100.37	200.00	-99.63	Average	100	151	P
2	6945.00	9.62	101.07	110.69	200.00	-89.31	Peak	100	151	P
3	7125.00	10.05	46.53	56.58	68.20	-11.62	Average	100	151	P
4	7125.00	10.05	62.26	72.31	88.20	-15.89	Peak	100	151	P
5	13890.00	22.95	28.17	51.12	68.20	-17.08	Average	100	266	P
6	13890.00	22.95	41.33	64.28	88.20	-23.92	Peak	100	266	P

Note: Level=Reading+Factor  
 Margin=Level-Limit  
 Factor=Antenna Factor + cable loss - Amplifier Factor