



規格承認書
Specification for Approval

客 戶：訊舟
Customer
品 名：DIPOLE ANT 黑 + I-PEX LOW LOSS CABLE/黑 + CORE / MSI (驊陞)
Part name
料 號：ARY121-0307-004-00
Part No.
客戶料號：1680-00000721-50U
Customer Part No.
Rev.(版本): 02
規 格：5G 3.69dBi ANT=195.5mm / L=103mm

| 客戶承認印 CUSTOMER APPROVED BY | | |
|----------------------------|-------|------------|
| APPROVAL | CHIEF | SUPERVISOR |
| | | |
| Approval No. | | |
| Model | | |
| Part No. | | |

| CHIEF | SALES | R&D | DESIGN |
|---|-------|------------------|--------|
| ROX | Grant | ROX | REASON |
| Date: 2022/06/22 | | Date: 2022/06/22 | |
| 驊陞科技股份有限公司 WIESON TECHNOLOGIES CO., LTD. | | | |

表格編號：324012 版本：第四版

RoHS Compliant

| REV | DATE | DESCRIPTION | NAME |
|-----|----------|-------------|------|
| A1 | 22.03.31 | PROPOSAL | LIEF |
| A2 | 22.06.20 | △ADD CORE | LIEF |

A
B
C
D
E

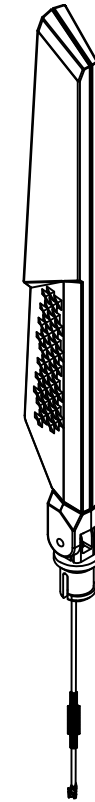
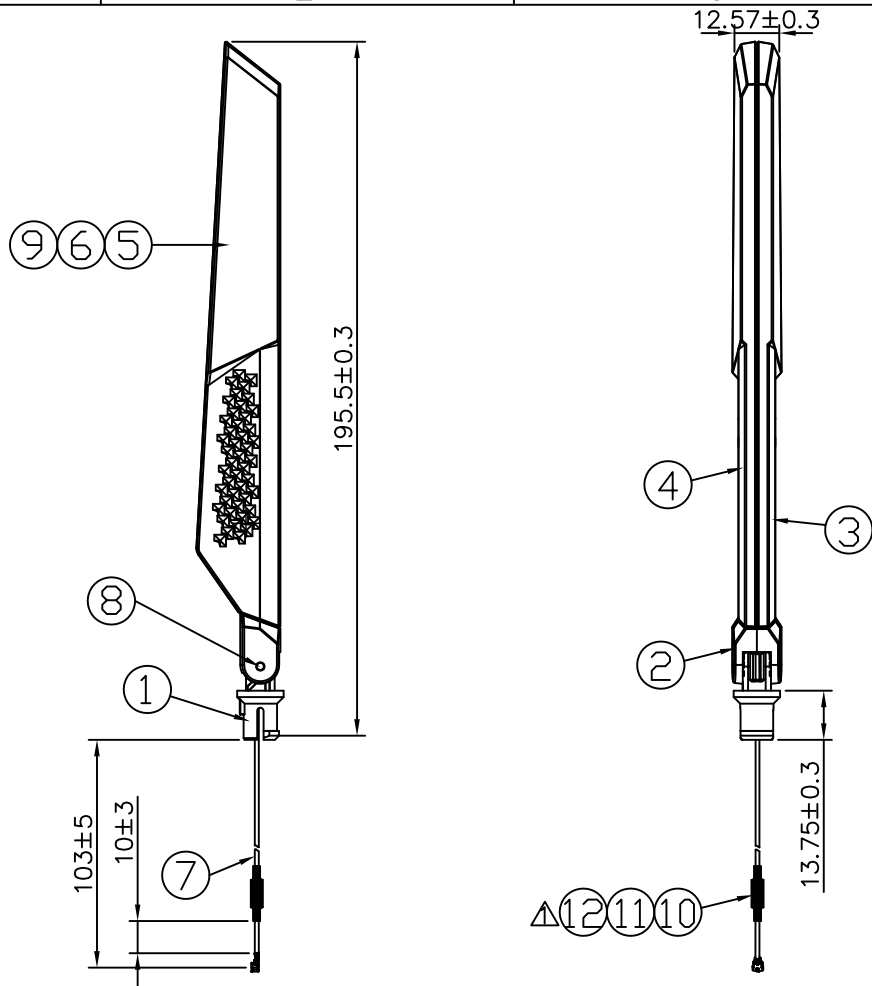

| | | | |
|-----|------------------|---|-----|
| ⑫ | HEAT SHRINK TUBE | COLOR : Blue , OD4*L20mm | 1 |
| ⑪ | HEAT SHRINK TUBE | COLOR : Black , OD1.6*L5mm | 2 |
| ⑩ | CORE | Magnetic Core OD4.0*ID2.0*L10mm | 1 |
| ⑨ | HEAT SHRINK TUBE | COLOR : Black | 1 |
| ⑧ | Fixed Pin | Fixed Pin , Black Coating | 2 |
| ⑦ | CABLE | OD:1.37 , Black LOW LOSS COAXIAL CABLE WITH MHF I Plug For 1.37mm Cable | 1 |
| ⑥ | COPPER TUBE-2 | BRASS | 1 |
| ⑤ | COPPER TUBE-1 | BRASS | 1 |
| ④ | COVER-2 | COVER , Black | 1 |
| ③ | COVER-1 | COVER , Black | 1 |
| ② | BASE-2 | BASE, Black | 1 |
| ① | BASE-1 | BASE, Black | 1 |
| NO. | ITEM | DESCRIPTION | QTY |

Note: △
 1.Frequency: 5.15~5.85GHz:
 Peak Gain: 3.69dBi(MAX) , V.S.W.R.: <2 (with case)
 2.Efficiency: >60%(with case)
 3.Impedance: 50ohm

| | | |
|-------------------------------------|--------------------|--------------|
| | PART NO.: | |
| | ARY121-0307-004-00 | |
| TITLE: WiFi Single 5G Antenna(Ant4) | | |
| DRAWN BY | LIEF(WST) | DRAWING NO. |
| CHECKED BY | | DRAWING SIZE |
| APPROVED BY | | UNIT |
| | | mm |
| NO. | DESCRIPTION | QTY |
| 1 | WSC | PAGE |
| | | 1 OF 1 |



WIESON TECHNOLOGIES CO.,LTD

BILL OF MATERIAL

| Cust. | 訊舟 | TITLE | RF ANTENNA | | | | |
|----------|---|------------|--------------------|--------|-----|----------|--------|
| Cust.P/N | | WIESON P/N | ARY121-0307-004-00 | | | | |
| NO. | DESCRIPTION | SUPPLIER | SUPPLIER PART NO. | UL NO. | AVL | QUANTITY | REMARK |
| 1 | BASE1, Black | / | BASE1 | / | | PCS | |
| 2 | BASE2 Black | / | BASE2 | / | | PCS | |
| 3 | COVER1, Black | / | COVER1 | / | | PCS | |
| 4 | COVER2, Black | / | COVER2 | | | PCS | |
| 5 | COPPER TUBE-1 BRASS | | COPPER TUBE | | | PCS | |
| 6 | COPPER TUBE-2BRASS | | COPPER TUBE | | | PCS | |
| 7 | OD:1.37 , Black LOW LOSS COAXIAL CABLE WITH MHF I Plug For 1.37mm Cable | | CABLE | | | MM | |
| 8 | Fixed Pin , Black Coating | | FIXED PIN | | | PCS | |
| 9 | HEAT SHRINK TUBE COLOR : Black | | TUBE | | | MM | |
| 10 | Magnetic Core OD4.0*ID2.0*L10mm | | CORE | | | PCS | |
| 11 | TUBE COLOR : Black , OD1.6*L5mm | | TUBE | | | MM | |
| 12 | TUBE COLOR : Black , OD4*L20mm | | TUBE | | | MM | |

APPROVED BY: ROX

CHECKD BY: JOSN

DESIGNED BY: REASON



| ITEM | INDEX | PAGE |
|------|------------------------------|------|
| 1. | THE SPECIFICATION LIST | 1 |
| 2. | BOM..... | 2 |
| 3. | TEST REPORT..... | 3-12 |
| 4. | WIESON ISO APPROVAL..... | 13 |

WIESON



| | | | | Approvals | |
|-----|----------|-------------|-----------|-------------|----------------|
| Rev | Date | Description | Edited by | Prepared : | REASON |
| 01 | 22.04.18 | ISSUE | WAH | Checked : | JOSN |
| 02 | 22.06.22 | UPDATE | | Approved : | ROX |
| | | | | Issued No : | 02 |
| | | | | Sheet : | 1 OF 13 |
| | | | | | |
| | | | | | |



EDIMAX BR6893MGL
ARY121-0307-004-00(Ant4)
5GHz(Peak Gain:3.69dBi)



Engineer : Wade
Report date : 2022/06/13



Antenna Specification

| Ant4 | Specification |
|-----------------------|------------------|
| Frequency(GHz) | 5.15-5.85 |
| Bandwidth | 700MHz (Min.) |
| Return Loss | 10 dB (Min) |
| Polarization | Linear |
| Azimuth Bandwidth | Omni-directional |
| Peak Gain | 3.69 dBi (Max) |
| Impedance | 50Ω |
| Material | Copper tube |
| Maximum Power | 1W |
| V.S.W.R | 2 : 1 |
| Radiation | Omni directional |
| Efficiency | >60% (Typical) |
| Connector | MHF I |
| Cable type | OD:1.37 |
| Operating Temperature | -10~60°C |
| Storage temp | -10~70°C |

Return Loss

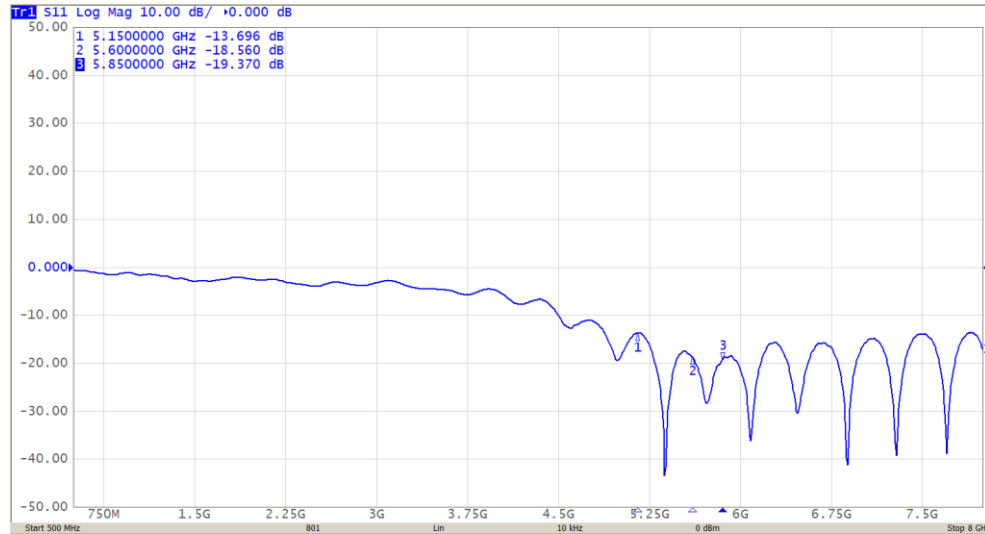

| | | | |
|-----------|-------|-------|-------|
| Freq(MHz) | 5150 | 5600 | 5850 |
| S11(dB) | -13.6 | -18.5 | -19.3 |

Chamber measurement photo

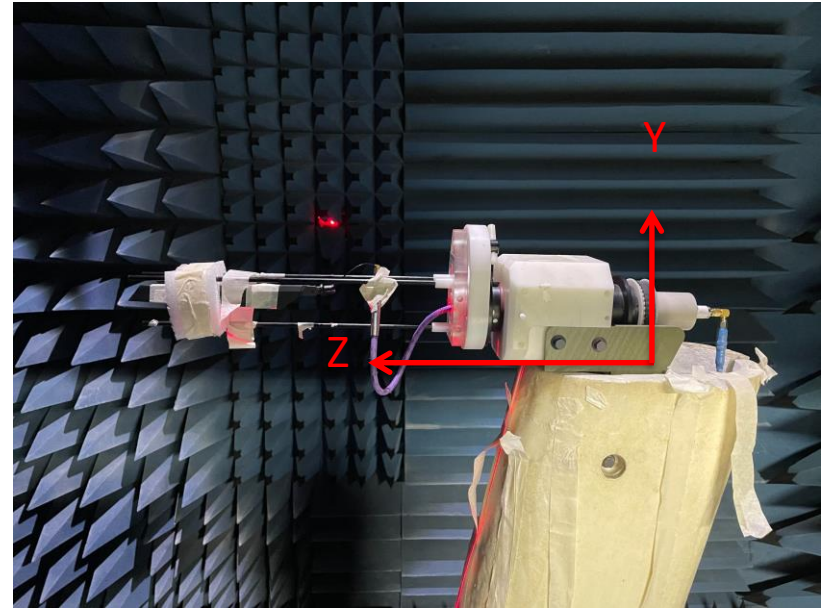

3D Gain Total

| Freq(MHz) | Peak Gain(dBi) | 3D-avg Gain(dBi) | Efficiency(%) |
|-----------|----------------|------------------|---------------|
| 5150 | 2.87 | 2.98 | 69 |
| 5250 | 3.03 | 3.04 | 73 |
| 5350 | 3.68 | 3.71 | 79 |
| 5470 | 3.69 | 3.7 | 82 |
| 5600 | 3.04 | 3.04 | 81 |
| 5725 | 2.39 | 2.42 | 75 |
| 5785 | 2.32 | 2.38 | 72 |
| 5850 | 2.88 | 2.99 | 84 |

Antenna Pattern Wieson

Frequency: 5150MHz

ZX-plane

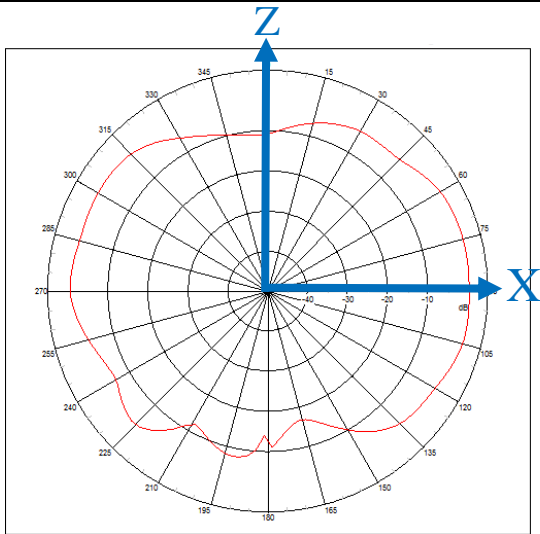

YZ-plane

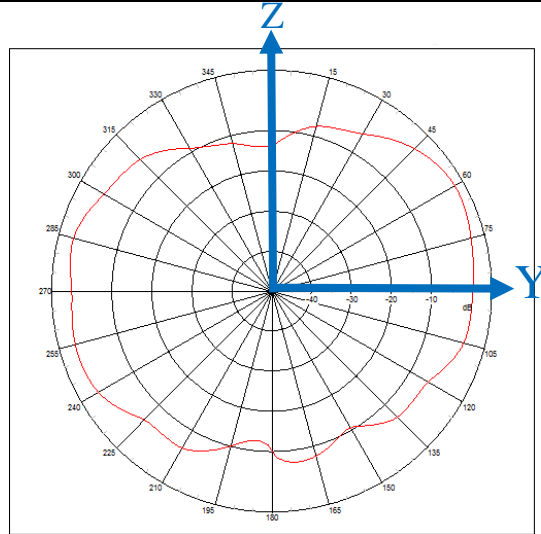

XY-plane

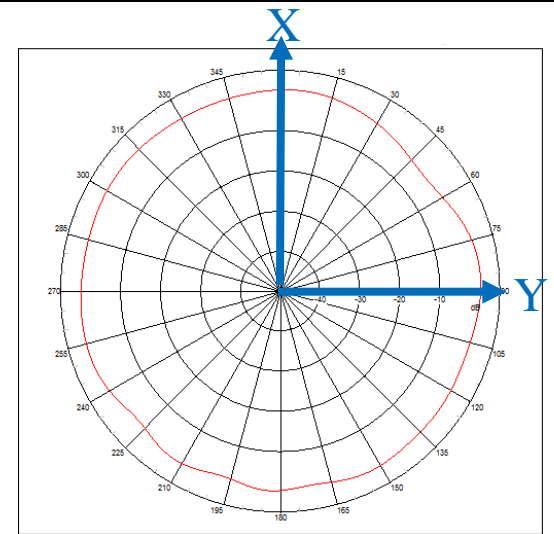

Antenna Pattern Wieson

Frequency: 5600MHz

ZX-plane

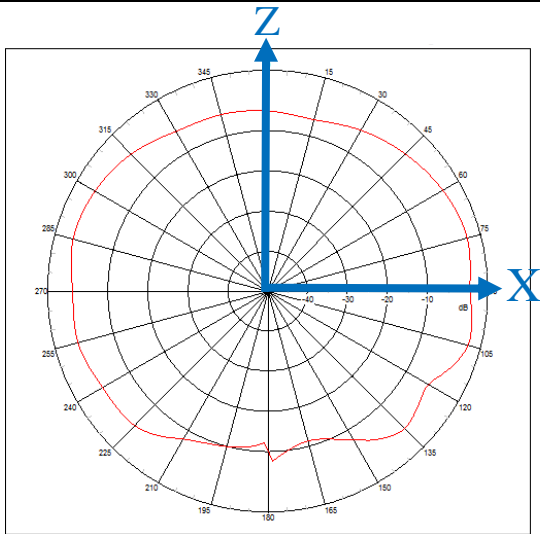

YZ-plane

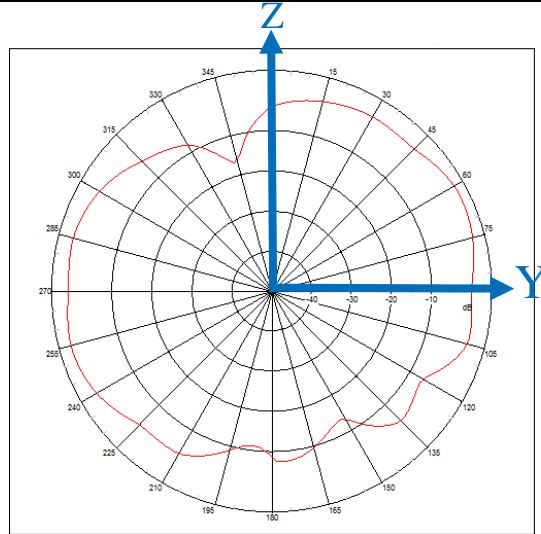

XY-plane

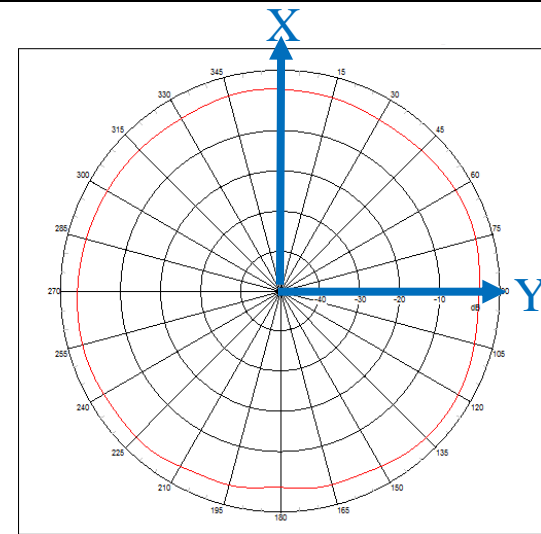

Antenna Pattern Wieson

Frequency: 5850MHz

ZX-plane

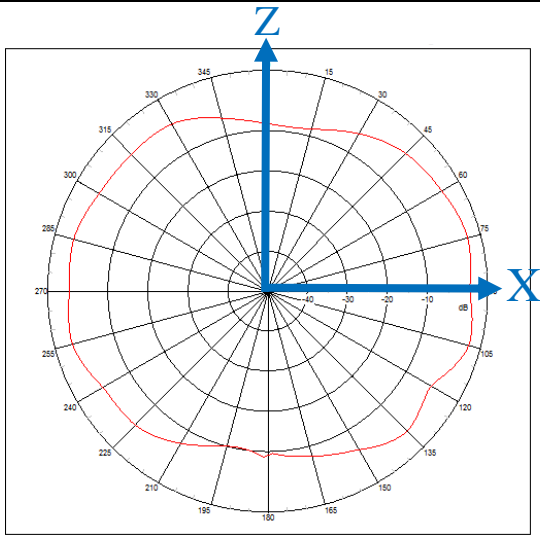

YZ-plane

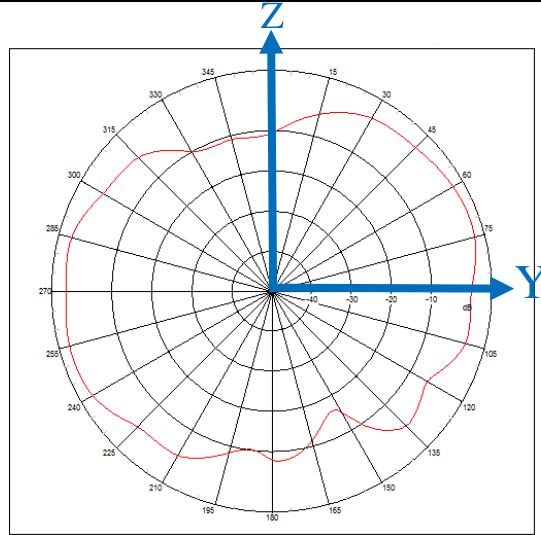

XY-plane

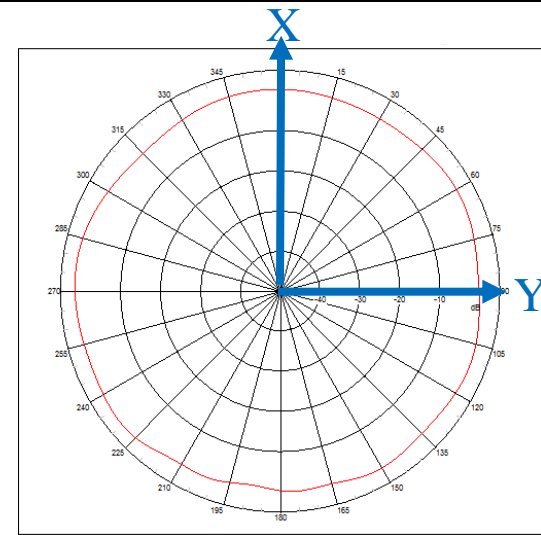



創造完美連結

MAKING THE PERFECT CONNECTION

www.wieson.com

N° 2016/70254.3

AFNOR Certification certifies that the management system implemented by:
AFNOR Certification certifie que le système de management mis en place par :

WIESON TECHNOLOGIES (DONG GUAN) CO., LTD.
东莞骅国电子有限公司

Unified Social Credit Code / Code Crédit Social Unifié / 统一社会信用代码 : 914419006181620014

for the following activities:
pour les activités suivantes :

DESIGN, MANUFACTURING AND SALES OF ELECTRONIC AND AUTOMOTIVE CONNECTORS, CABLES,
WIRE HARNESSSES, RF (RADIO FREQUENCY) AND ANTENNA PRODUCTS, PLASTIC INJECTION,
STAMPING PARTS, PLASTIC & HARDWARE MOLDS
电子和车用连接器、连接线、线束、无线射频天线产品、注塑成型部件、
冲压部件, 塑胶五金模具的设计、生产和销售

has been assessed and found to meet the requirements of:
a été évalué et jugé conforme aux exigences requises par :

ISO 9001 : 2015

and is developed on the following locations:
et est déployé sur les sites suivants :

XINBAOWEI INDUSTRIAL BUILDING, HUANGANG INDUSTRIAL ZONE, HOUIE TOWN,
DONGGUAN CITY, GUANGDONG PROVINCE, CHINA
中国广东省东莞市厚街镇环岗工业区新保威工业城

This certificate is valid from (year/month/day)
Ce certificat est valable à compter du (année/mois/jour)

2021-01-18

Until
Jusqu'au

2024-01-17



Signature Fournisseur



Scan this QR code to
check the validity of the
certificate.

Julien NIZRI
Managing Director of AFNOR Certification
Directeur Général d'AFNOR Certification

The electronic certificate only, available at www.afnor.org, attests in real-time that the company is certified. Seul le certificat électronique, consultable sur www.afnor.org, fait foi en temps réel de la certification de l'organisme. 管理系统COFRAC认可号码: n°4-0001. COFRAC accreditation n°4-0001. Management Systems Certification. Scope available on www.cofrac.fr. Accréditation COFRAC n°4-0001. Certification de Systèmes de management. Portée disponible sur www.cofrac.fr. 本证书信息可在国家认监委网站 WWW.CNCA.GOV.CN 查询. The certificate information is available on www.cnca.gov.cn. L'information relative au certificat est disponible sur le site www.cnca.gov.cn. The certified organization shall regularly approve any surveillance audit and be found to conform with the requirements of the standard for the certificate to be maintained. L'entreprise certifiée doit autoriser les audits de surveillance prévus et être jugée conforme aux exigences du référentiel pour que le certificat soit maintenu. 获证组织必须定期接受监督审核并经审核合格此证书方继续有效. AFAQ is a registered trademark. AFAQ est une marque déposée. CERTIF 1493-6- 07/2020