



規格承認書
Specification for Approval

客戶：訊舟
Customer
品名：DIPOLE ANT 黑 + I-PEX LOW LOSS CABLE/黑 + CORE / MSI (驊陞)
Part name
料號：ARY121-0307-005-00
Part No.
客戶料號：1680-00000722-50U
Customer Part No.
Rev.(版本): 02
規格：5G 3.72dBi ANT=195.5mm / L=83mm

客戶承認印 CUSTOMER APPROVED BY		
APPROVAL	CHIEF	SUPERVISOR
Approval No.		
Model		
Part No.		

CHIEF	SALES	R&D	DESIGN
ROX	Grant	ROX	REASON
Date: 2022/06/22		Date: 2022/06/22	
驊陞科技股份有限公司 WIESON TECHNOLOGIES CO., LTD.			

RoHS Compliant

REV	DATE	DESCRIPTION	NAME
A1	22.03.31	PROPOSAL	LIEF
A2	22.06.20	△ADD CORE	LIEF

A
B
C
D
E

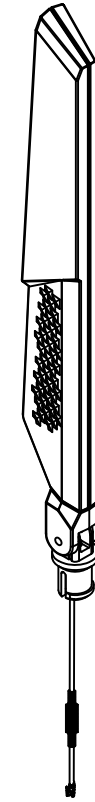
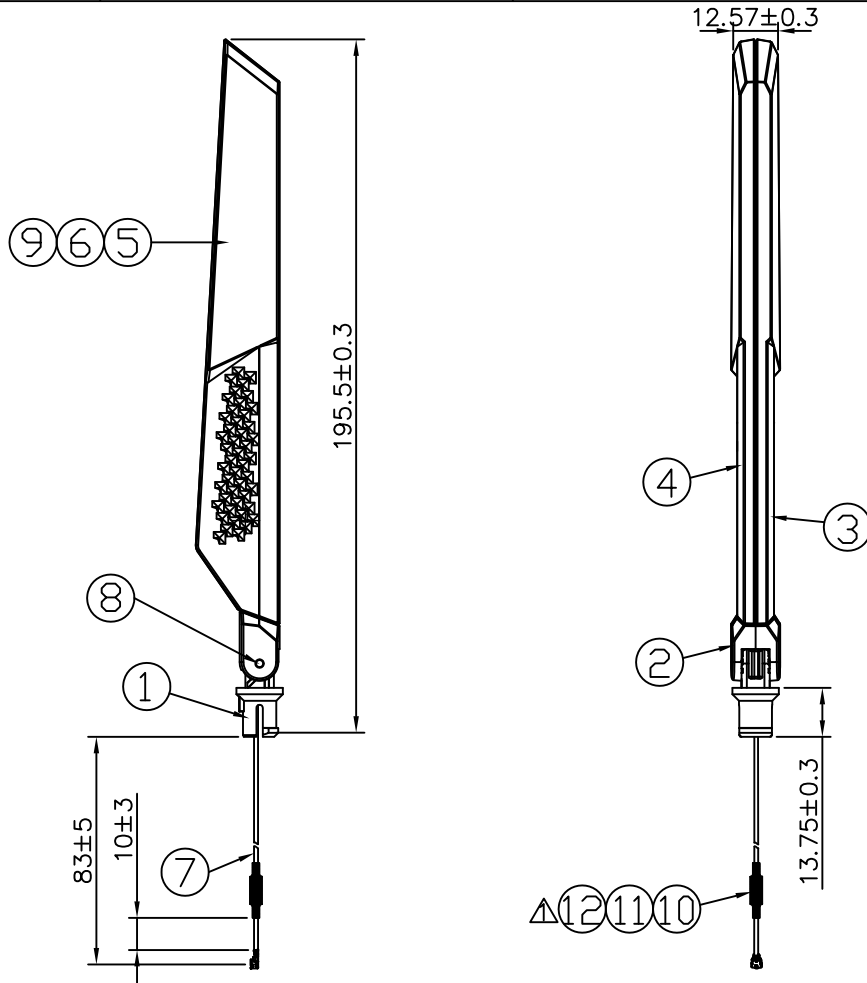

Note: △
 1.Frequency: 5.15~5.85GHz;
 Peak Gain: 3.72dBi(MAX) , v.S.W.R.: <2 (with case)
 2.Efficiency: >60%(with case)
 3.Impedance: 50ohm

⑫	HEAT SHRINK TUBE	COLOR : Black , OD4*L20mm	1
⑪	HEAT SHRINK TUBE	COLOR : Black , OD1.6*L5mm	2
⑩	CORE	Magnetic Core OD4.0*ID2.0*L10mm	1
⑨	HEAT SHRINK TUBE	COLOR : Black	1
⑧	Fixed Pin	Fixed Pin , Black Coating	2
⑦	CABLE	OD:1.37 , Black LOW LOSS COAXIAL CABLE WITH MHF I Plug For 1.37mm Cable	1
⑥	COPPER TUBE-2	BRASS	1
⑤	COPPER TUBE-1	BRASS	1
④	COVER-2	COVER , Black	1
③	COVER-1	COVER , Black	1
②	BASE-2	BASE, Black	1
①	BASE-1	BASE, Black	1
NO.	ITEM	DESCRIPTION	QTY

WIESON TECHNOLOGIES CO., LTD	PART NO.: ARY121-0307-005-00		
	TITLE: WiFi Single 5G Antenna(Ant5)		
DRAWN BY	LIEF(WST)	DRAWING NO.	
CHECKED BY		DRAWING SIZE	A4
APPROVED BY		UNIT	mm
SORTING NO.	WSC	PAGE	1 OF 1



ITEM	INDEX	PAGE
1.	THE SPECIFICATION LIST	1
2.	BOM.....	2
3.	TEST REPORT.....	3-12
4.	WIESON ISO APPROVAL.....	13

WIESON



				Approvals	
Rev	Date	Description	Edited by	Prepared :	REASON
01	22.04.18	ISSUE	WAH	Checked :	JOSN
02	22.06.22	UPDATE		Approved :	ROX
				Issued No :	02
				Sheet :	1 OF 13



WIESON TECHNOLOGIES CO.,LTD

BILL OF MATERIAL

Cust.	訊舟	TITLE	RF ANTENNA				
Cust.P/N		WIESON P/N	ARY121-0307-005-00				
NO.	DESCRIPTION	SUPPLIER	SUPPLIER PART NO.	UL NO.	AVL	QUANTITY	REMARK
1	BASE1, Black	/	BASE1	/		PCS	
2	BASE2 Black	/	BASE2	/		PCS	
3	COVER1, Black	/	COVER1	/		PCS	
4	COVER2, Black	/	COVER2			PCS	
5	COPPER TUBE-1 BRASS		COPPER TUBE			PCS	
6	COPPER TUBE-2BRASS		COPPER TUBE			PCS	
7	OD:1.37 , Black LOW LOSS COAXIAL CABLE WITH MHF I Plug For 1.37mm Cable		CABLE			MM	
8	Fixed Pin , Black Coating		FIXED PIN			PCS	
9	HEAT SHRINK TUBE COLOR : Black		TUBE			MM	
10	Magnetic Core OD4.0*ID2.0*L10mm		CORE			PCS	
11	TUBE COLOR : Black , OD1.6*L5mm		TUBE			MM	
12	TUBE COLOR : Black , OD4*L20mm		TUBE			MM	

APPROVED BY: ROX

CHECKD BY: JOSN

DESIGNED BY: REASON



EDIMAX BR6893MGL
ARY121-0307-005-00(Ant5)
5GHz(Peak Gain:3.72dBi)



Engineer : Wade
Report date : 2022/06/13



Antenna Specification

Ant5	Specification
Frequency(GHz)	5.15-5.85
Bandwidth	700MHz (Min.)
Return Loss	10 dB (Min)
Polarization	Linear
Azimuth Bandwidth	Omni-directional
Peak Gain	3.72 dBi (Max)
Impedance	50Ω
Material	Copper tube
Maximum Power	1W
V.S.W.R	2 : 1
Radiation	Omni directional
Efficiency	>60% (Typical)
Connector	MHF I
Cable type	OD:1.37
Operating Temperature	-10~60°C
Storage temp	-10~70°C

Return Loss

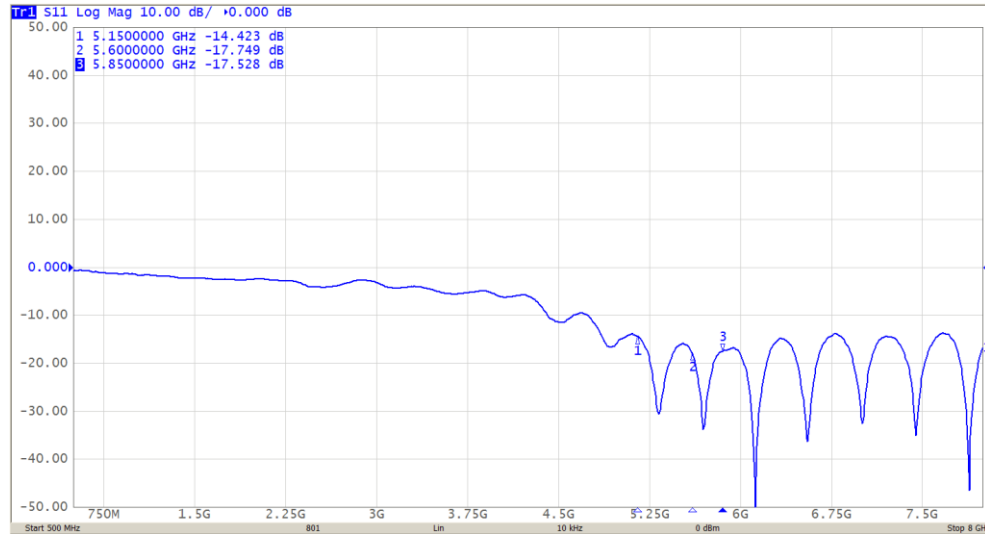

Freq(MHz)	5150	5600	5850
S11(dB)	-14.4	-17.7	-17.5

Chamber measurement photo

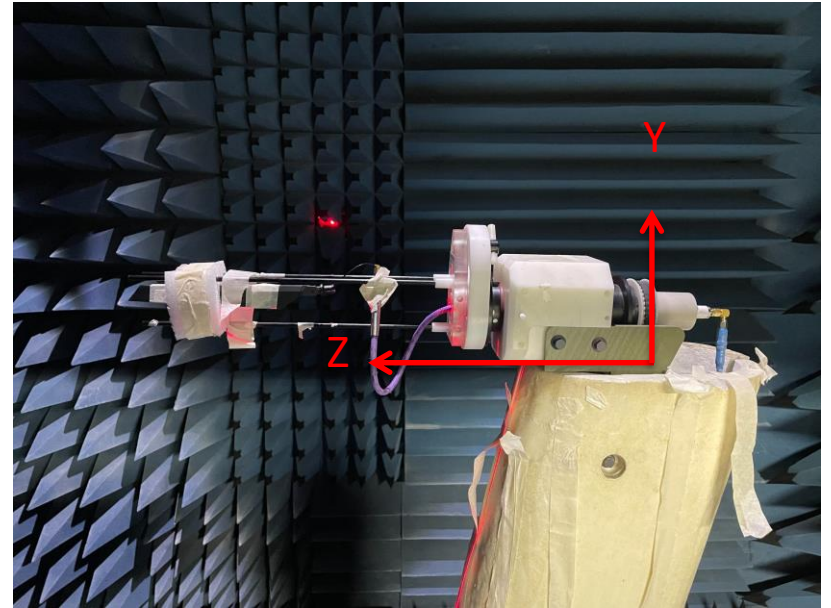

3D Gain Total

Freq(MHz)	Peak Gain(dBi)	3D-avg Gain(dBi)	Efficiency(%)
5150	2.97	-1.57	70
5250	2.94	-1.31	74
5350	2.71	-0.99	80
5470	2.55	-0.95	80
5600	2.53	-0.9	81
5725	2.89	-1.21	76
5785	2.91	-1.49	71
5850	3.72	-0.73	85

Antenna Pattern Wieson

Frequency: 5150MHz

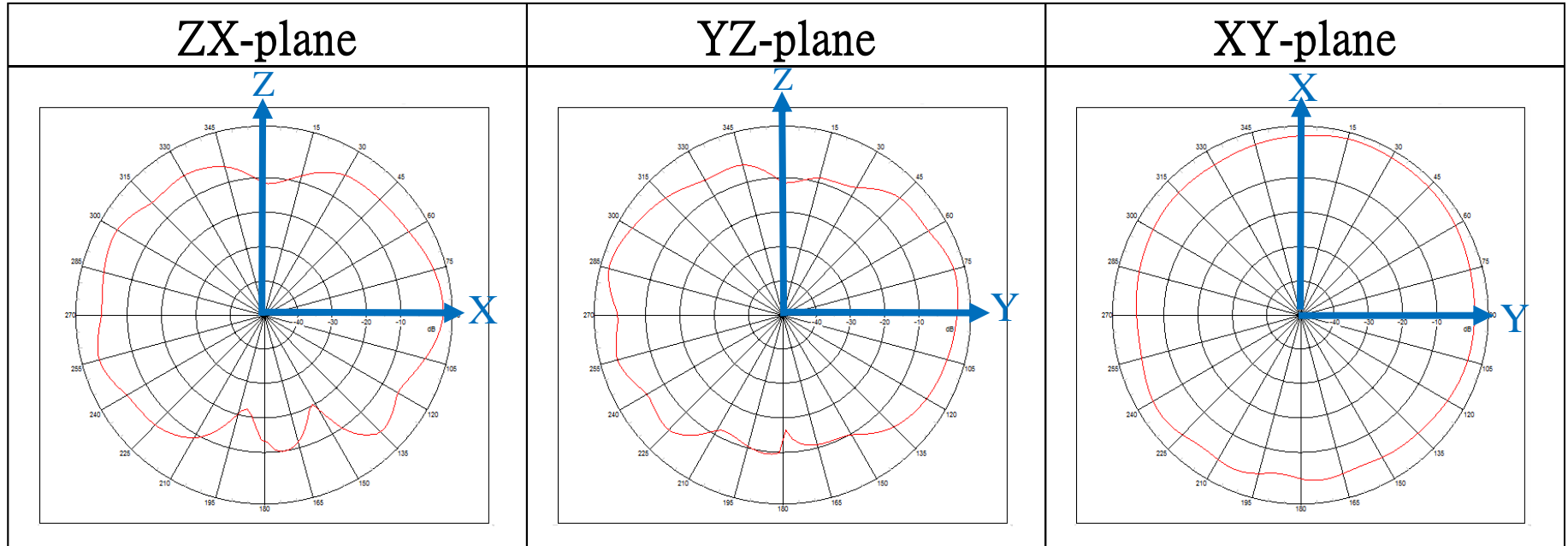

Antenna Pattern Wieson

Frequency: 5600MHz

ZX-plane

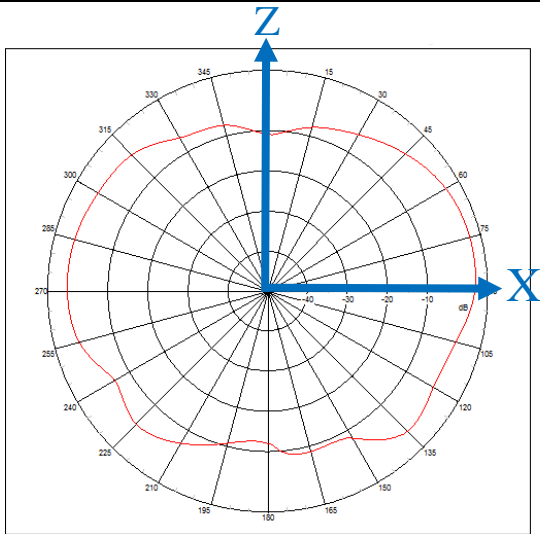

YZ-plane

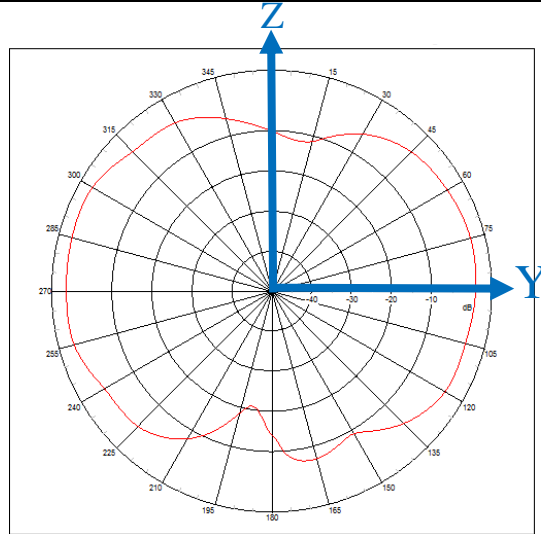

XY-plane

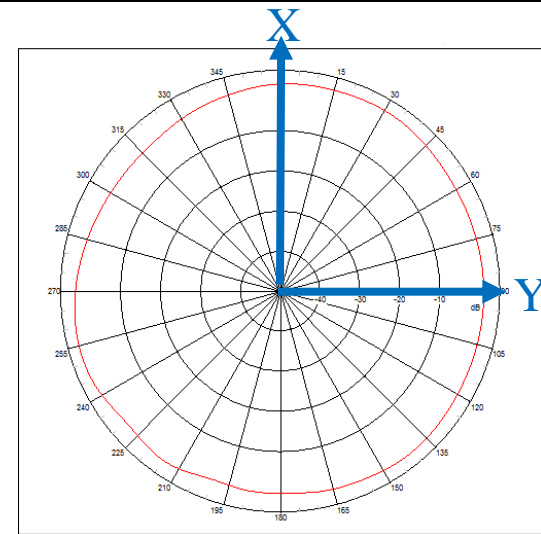

Antenna Pattern Wieson

Frequency: 5850MHz

ZX-plane

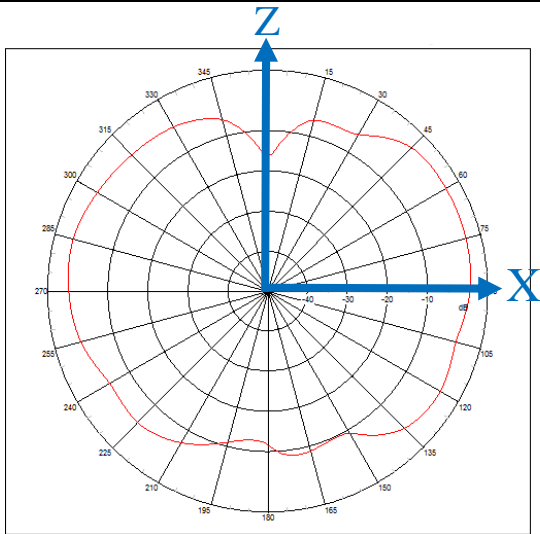

YZ-plane

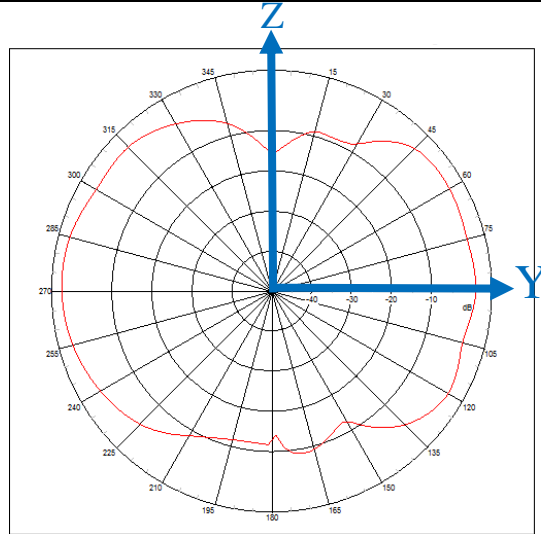

XY-plane

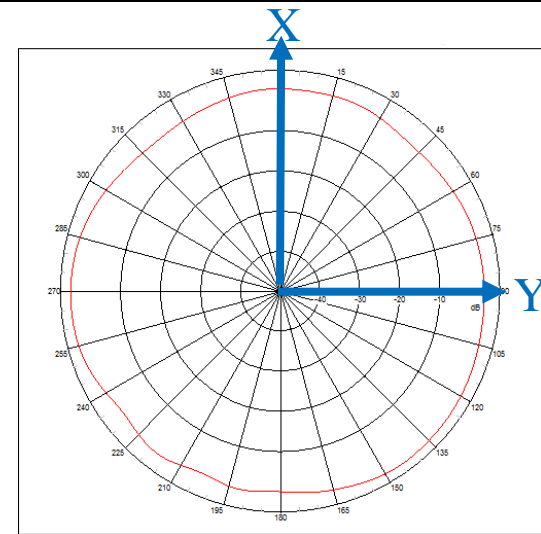



創造完美連結

MAKING THE PERFECT CONNECTION

www.wieson.com

N° 2016/70254.3

AFNOR Certification certifies that the management system implemented by:
AFNOR Certification certifie que le système de management mis en place par :

WIESON TECHNOLOGIES (DONG GUAN) CO., LTD.
东莞骅国电子有限公司

Unified Social Credit Code / Code Crédit Social Unifié / 统一社会信用代码 : 914419006181620014

for the following activities:
pour les activités suivantes :

DESIGN, MANUFACTURING AND SALES OF ELECTRONIC AND AUTOMOTIVE CONNECTORS, CABLES,
WIRE HARNESSSES, RF (RADIO FREQUENCY) AND ANTENNA PRODUCTS, PLASTIC INJECTION,
STAMPING PARTS, PLASTIC & HARDWARE MOLDS
电子和车用连接器、连接线、线束、无线射频天线产品、注塑成型部件、
冲压部件, 塑胶五金模具的设计、生产和销售

has been assessed and found to meet the requirements of:
a été évalué et jugé conforme aux exigences requises par :

ISO 9001 : 2015

and is developed on the following locations:
et est déployé sur les sites suivants :

XINBAOWEI INDUSTRIAL BUILDING, HUANGANG INDUSTRIAL ZONE, HOUIE TOWN,
DONGGUAN CITY, GUANGDONG PROVINCE, CHINA
中国广东省东莞市厚街镇环岗工业区新保威工业城

This certificate is valid from (year/month/day)
Ce certificat est valable à compter du (année/mois/jour)

2021-01-18

Until
Jusqu'au

2024-01-17



SignatureFournisseur



Scan this QR code to check the validity of the certificate.

Julien NIZRI
Managing Director of AFNOR Certification
Directeur Général d'AFNOR Certification

The electronic certificate only, available at www.afnor.org, attests in real-time that the company is certified. Seul le certificat électronique, consultable sur www.afnor.org, fait foi en temps réel de la certification de l'organisme. 管理系统COFRAC认可号码: n°4-0001. COFRAC accreditation n°4-0001. Management Systems Certification. Scope available on www.cofrac.fr. Accreditation COFRAC n°4-0001. Certification de Systèmes de management. Portée disponible sur www.cofrac.fr. 本证书信息可在国家认监委网站 WWW.CNCA.GOV.CN查询. The certificate information is available on www.cnca.gov.cn. L'information relative au certificat est disponible sur le site www.cnca.gov.cn. The certified organization shall regularly approve any surveillance audit and be found to conform with the requirements of the standard for the certificate to be maintained. L'entreprise certifiée doit autoriser les audits de surveillance prévus et être jugée conforme aux exigences du référentiel pour que le certificat soit maintenu. 获证组织必须定期接受监督审核并经审核合格此证书方继续有效. AFAQ is a registered trademark. AFAQ est une marque déposée. CERTIF 1493-6- 07/2020