

Multi-Antenna Systems Directional Gain measurement

Report No.: RFBGSN-WTW-P22060933-4

FCC ID: I4L-GRAX66

Test Model: GRAX66

Received Date: Jun. 27, 2022

Test Date: Jul 11 ~ Aug. 24, 2022

Issued Date: Oct. 07, 2022

Applicant and Manufacturer: Micro-Star International Co., Ltd.

Address: No.69, Lide St., Zhonghe Dist., New Taipei City 235, Taiwan (R.O.C.)

Issued By: Bureau Veritas Consumer Products Services (H.K.) Ltd., Taoyuan Branch
Lin Kou Laboratories

Lab Address: No. 47-2, 14th Ling, Chia Pau Vil., Lin Kou Dist., New Taipei City, Taiwan

Test Location: No. 19, Hwa Ya 2nd Rd., Wen Hwa Vil., Kwei Shan Dist., Taoyuan City
33383, Taiwan

**FCC Registration /
Designation Number:** 788550 / TW0003



This report is governed by, and incorporates by reference, the Conditions of Testing as posted at the date of issuance of this report at <http://www.bureauveritas.com/home/about-us/our-business/cps/about-us/terms-conditions/> and is intended for your exclusive use. Any copying or replication of this report to or for any other person or entity, or use of our name or trademark, is permitted only with our prior written permission. This report sets forth our findings solely with respect to the test samples identified herein. The results set forth in this report are not indicative or representative of the quality or characteristics of the lot from which a test sample was taken or any similar or identical product unless specifically and expressly noted. Our report includes all of the tests requested by you and the results thereof based upon the information that you provided to us. Measurement uncertainty is only provided upon request for accredited tests. Statements of conformity are based on simple acceptance criteria without taking measurement uncertainty into account, unless otherwise requested in writing. You have 60 days from date of issuance of this report to notify us of any material error or omission caused by our negligence or if you require measurement uncertainty; provided, however, that such notice shall be in writing and shall specifically address the issue you wish to raise. A failure to raise such issue within the prescribed time shall constitute your unqualified acceptance of the completeness of this report, the tests conducted and the correctness of the report contents.

Table of Contents

1	EUT Antenna System Description	3
1.1	Antenna Information	3
1.2	Antenna Location	3
1.3	EUT Operation mode	4
2	Conducted Power Measurement	6
2.1	Test Setup	6
2.2	Test Instruments	6
2.3	Test Procedure	6
2.4	Test Results of RF Conducted Power (2.4GHz and 5GHz bands)	6
3	3D Antenna Pattern Measurement and Directional gain calculation (Measurement Method and Measurement Environment)	8
3.1	Test Location	8
3.2	Test Procedure	8
3.3	Test Setup Diagram @ Fully Anechoic Chamber (Dimension: 12m(L)*7m(W)*7m(H))	8
3.4	Test Setup Diagram for EUT	9
3.5	Test Instruments	10
3.6	Test Procedure	11
3.7	Test Results (Measurement Quantity) of EIRP Measurement & Directional Gain Calculation	12
3.8	3D EIRP Pattern and 3-dB Beam-width Test Plots	14
	Appendix - Information of the Testing Laboratories	26

1 EUT Antenna System Description

1.1 Antenna Information

Antenna	Ant. 0	Ant. 1	Ant. 2	Ant. 3
Transmitter Chain	Chain 0	Chain 1	Chain 2	Chain 3
Frequency Band	Gain (dBi)			
2400~2483.5MHz (2.4G)	2.05	2.07	-	-
5150~5250MHz (5G)	4.54	4.59	-	-
5250~5350MHz (5G)	4.60	4.65	-	-
5470~5725MHz (5G)	3.02	3.69	2.89	3.02
5725~5850MHz (5G)	3.01	2.88	3.72	3.27

1.2 Antenna Location

Please refer to report BGSN-WTW-P22060933 (EUT photo) Page 1

1.3 EUT Operation mode

Band	Modulation Mode	CDD mode	Beamforming mode
2.4GHz	802.11b	Nss1	Not Support
	802.11g	Nss1	Not Support
	802.11n(HT20)	Nss1 / Nss2	Not Support
	802.11n(HT40)	Nss1 / Nss2	Not Support
	802.11n(VHT20)	Nss1 / Nss2	Nss1 / Nss2
	802.11n(VHT40)	Nss1 / Nss2	Nss1 / Nss2
	802.11ax(HE20)	Nss1 / Nss2	Nss1(Note) / Nss2
	802.11ax(HE40)	Nss1 / Nss2	Nss1 / Nss2
5GHz	802.11a	Nss1	Not Support
	802.11n(HT20)	Nss1 / Nss2 / Nss3 / Nss4	Not Support
	802.11n(HT40)	Nss1 / Nss2 / Nss3 / Nss4	Not Support
	802.11ac(VHT20)	Nss1 / Nss2 / Nss3 / Nss4	Nss1 / Nss2 / Nss3 / Nss4
	802.11ac(VHT40)	Nss1 / Nss2 / Nss3 / Nss4	Nss1 / Nss2 / Nss3 / Nss4
	802.11ac(VHT80)	Nss1 / Nss2 / Nss3 / Nss4	Nss1 / Nss2 / Nss3 / Nss4
	802.11ac(VHT160)	Nss1 / Nss2 / Nss3 / Nss4	Nss1 / Nss2 / Nss3 / Nss4
	802.11ax(HE20)	Nss1 / Nss2 / Nss3 / Nss4	Nss1(Note) / Nss2 / Nss3 / Nss4
	802.11ax(HE40)	Nss1 / Nss2 / Nss3 / Nss4	Nss1 / Nss2 / Nss3 / Nss4
	802.11ax(HE80)	Nss1 / Nss2 / Nss3 / Nss4	Nss1 / Nss2 / Nss3 / Nss4
	802.11ax(HE160)	Nss1 / Nss2 / Nss3 / Nss4	Nss1 / Nss2 / Nss3 / Nss4

Note: The 802.11ax (HE20) of beamforming mode for both 2.4 GHz and 5 GHz bands is the worst case for final testing.

Band	Modulation Mode	Ant 0	Ant 1	Ant 2	Ant 3
2.4GHz	802.11b	TX/RX	TX/RX	--	--
	802.11g	TX/RX	TX/RX	--	--
	802.11n(HT20)	TX/RX	TX/RX	--	--
	802.11n(HT40)	TX/RX	TX/RX	--	--
	802.11n(VHT20)	TX/RX	TX/RX	--	--
	802.11n(VHT40)	TX/RX	TX/RX	--	--
	802.11ax(HE20)	TX/RX	TX/RX	--	--
	802.11ax(HE40)	TX/RX	TX/RX	--	--
5G Band 1/2	802.11a	TX/RX	TX/RX	--	--
	802.11n(HT20)	TX/RX	TX/RX	--	--
	802.11n(HT40)	TX/RX	TX/RX	--	--
	802.11ac(VHT20)	TX/RX	TX/RX	--	--
	802.11ac(VHT40)	TX/RX	TX/RX	--	--
	802.11ac(VHT80)	TX/RX	TX/RX	--	--
	802.11ac(VHT160)	TX/RX	TX/RX	--	--
	802.11ax(HE20)	TX/RX	TX/RX	--	--
	802.11ax(HE40)	TX/RX	TX/RX	--	--
	802.11ax(HE80)	TX/RX	TX/RX	--	--
	802.11ax(HE160)	TX/RX	TX/RX	--	--
5G Band 3/4	802.11a	TX/RX	TX/RX	TX/RX	TX/RX
	802.11n(HT20)	TX/RX	TX/RX	TX/RX	TX/RX
	802.11n(HT40)	TX/RX	TX/RX	TX/RX	TX/RX
	802.11ac(VHT20)	TX/RX	TX/RX	TX/RX	TX/RX
	802.11ac(VHT40)	TX/RX	TX/RX	TX/RX	TX/RX
	802.11ac(VHT80)	TX/RX	TX/RX	TX/RX	TX/RX
	802.11ac(VHT160)	TX/RX	TX/RX	TX/RX	TX/RX
	802.11ax(HE20)	TX/RX	TX/RX	TX/RX	TX/RX
	802.11ax(HE40)	TX/RX	TX/RX	TX/RX	TX/RX
	802.11ax(HE80)	TX/RX	TX/RX	TX/RX	TX/RX
	802.11ax(HE160)	TX/RX	TX/RX	TX/RX	TX/RX

2 Conducted Power Measurement

2.1 Test Setup

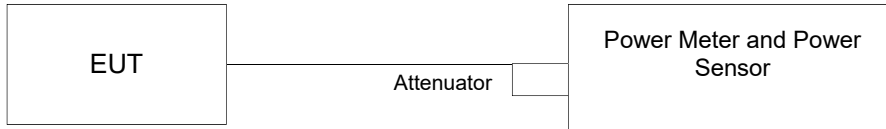

2.2 Test Instruments

Description & Manufacturer	Model No.	Serial No.
Peak Power Analyzer KEYSIGHT	8990B	MY51000485
Wideband Power Sensor KEYSIGHT	N1923A	MY58020002

2.3 Test Procedure

Method PM is used to perform output power measurement, trigger and gating function of wide band power meter is enabled to measure max output power of TX on burst and set the detector to average. Duty factor is not added to measured value.

2.4 Test Results of RF Conducted Power (2.4GHz and 5GHz bands)

802.11 ax HE20 of Beamforming Mode / Nss=1

Channel	Frequency (MHz)	Ant 0		Ant 1		Ant 2		Ant 3		Total Conducted Power (dBm)
		Chain0		Chain1		Chain2		Chain3		
		(dBm)	(mW)	(dBm)	(mW)	(dBm)	(mW)	(dBm)	(mW)	
6	2437	26.44	440.55	26.17	414.00	--	--	--	--	29.32
36	5180	23.78	238.78	23.41	219.28	--	--	--	--	26.61
64	5320	20.82	120.78	20.70	117.49	--	--	--	--	23.77
100	5500	15.58	36.14	15.85	38.46	15.72	37.33	15.80	38.02	21.76
157	5785	22.92	195.88	23.06	202.30	23.00	199.53	22.79	190.11	28.96

Note: Total Conducted Power = Chain0 + Chain 1 + Chain 2 + Chain 3
 = Chain 0(mW) + Chain 1(mW) + Chain 2(mW) + Chain 3(mW) = Total Conducted Power(mW)
 Total Conducted Power (dBm) = 10 * log (Total conducted power (mW)).

802.11 ax HE20 of Beamforming Mode / Nss=2

Channel	Frequency (MHz)	Ant 0		Ant 1		Ant 2		Ant 3		Total Conducted Power (dBm)
		Chain0		Chain1		Chain2		Chain3		
		(dBm)	(mW)	(dBm)	(mW)	(dBm)	(mW)	(dBm)	(mW)	
6	2437	26.7	467.74	26.45	441.57	--	--	--	--	29.59
36	5180	22.18	165.20	21.87	153.82	--	--	--	--	25.04
64	5320	20.85	121.62	20.72	118.03	--	--	--	--	23.80
100	5500	16.93	49.32	17.26	53.21	17.14	51.76	17.20	52.48	23.15
157	5785	24.22	264.24	23.38	217.77	23.20	208.93	23.43	220.29	29.60

Note: Total Conducted Power = Chain0 + Chain 1 + Chain 2 + Chain 3
 = Chain 0(mW) + Chain 1(mW) + Chain 2(mW) + Chain 3(mW) = Total Conducted Power(mW)
 Total Conducted Power (dBm) = 10 * log (Total conducted power (mW)).

802.11 ax HE20 of Beamforming Mode / Nss=4

Channel	Frequency (MHz)	Ant 0		Ant 1		Ant 2		Ant 3		Total Conducted Power (dBm)
		Chain0		Chain1		Chain2		Chain3		
		(dBm)	(mW)	(dBm)	(mW)	(dBm)	(mW)	(dBm)	(mW)	
100	5500	16.43	43.95	16.82	48.08	16.59	45.60	16.70	46.77	22.66
157	5785	23.76	237.68	23.86	243.22	23.79	239.33	23.58	228.03	29.77

Note: Total Conducted Power = Chain0 + Chain 1 + Chain 2 + Chain 3
 = Chain 0(mW) + Chain 1(mW) + Chain 2(mW) + Chain 3(mW) = Total Conducted Power(mW)
 Total Conducted Power (dBm) = 10 * log (Total conducted power (mW)).

3 3D Antenna Pattern Measurement and Directional gain calculation (Measurement Method and Measurement Environment)

Measurement the EIRP and compare the total conducted power values to calculation the directional gain.

3.1 Test Location

3D Antenna a Pattern Measurement in Fully Anechoic Chamber

3.2 Test Procedure

KDB 662911 D03 MIMO Antenna Gain Measurement v01

ANSI 63.10:2013 – clause 13

KDB 412172 D01 Determining ERP and EIRP v01r01

3.3 Test Setup Diagram @ Fully Anechoic Chamber (Dimension: 12m(L)*7m(W)*7m(H))

The EIRP Pattern measurement is using the conical circle cut test system (refer to Figure 1). The EUT is positioned on center of turntable, for Free Space only in fully anechoic chamber. Data (channel power level) is recorded using the spectrum analyzer for both theta and phi polarizations at each position.

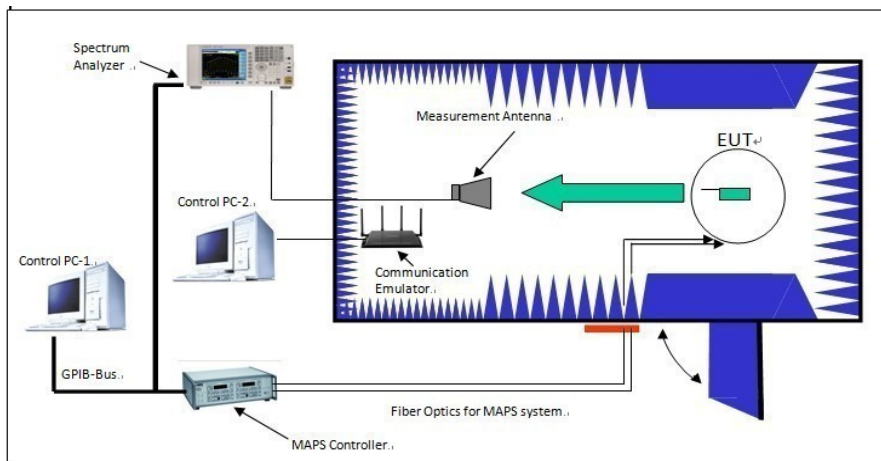

Figure 1. Conical circle cut test system.

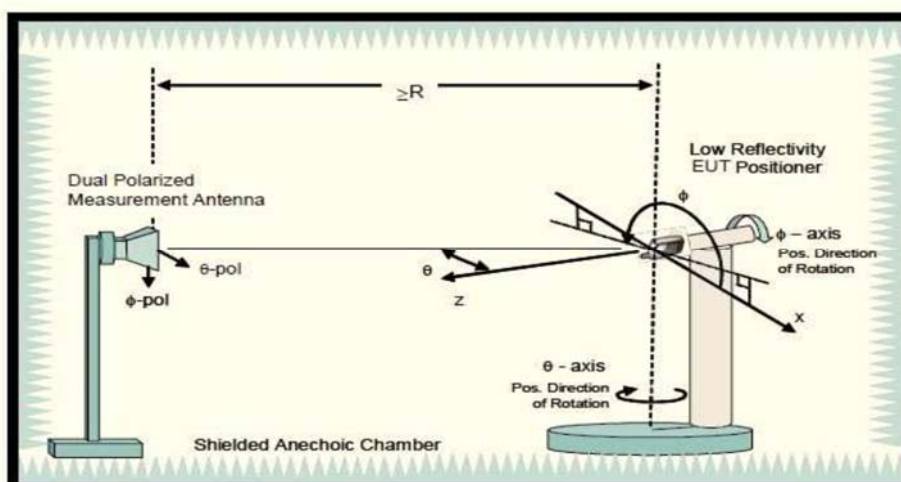

Figure 2. Configuration of Conical circle cut test system.

3.4 Test Setup Diagram for EUT

Please refer to report BGSN-WTW-P22060933_Tsup Page 6, 7.

3.5 Test Instruments

Description & Manufacturer	Model No.	Serial No.
PXA Signal Analyzer KEYSIGHT	N9030B	MY57140488
BILOG Antenna SCHWARZBECK	VULB 9168	9168-158
HORN Antenna ETS	3117	00034128
HORN Antenna SCHWARZBECK	BBHA 9170	BBHA9170243
Preamplifier Agilent	8449B	3008A01963
Preamplifier Agilent	8447D	2944A10627
RF signal cable HUBER+SUHNER	SUCOFLEX 104	Cable-RF1-03 (223650/4)
RF signal cable WOKEN	8D-FB	Cable-RF1-01
RF signal cable INFINET	CA3501-3501-G.90 (3m) & CA3501-3501-F.90 (2m)	INF090 (3m)*2 & TCF427S (2m)*1
Software ADT	ADT_Radiated_ V7.6.15.9.5	NA
Antenna Tower Max-Full	MFA-440H	9707
Turn Table ADT	NA	SN40303
Controller Max-Full	MF-7802	MF7802093
Temperature & Humidity chamber TERCHY	MHU-225AU	920842
Splitters/Combiners Mini-Circuits	ZN2PD-9G	NA
26GHz ~ 40GHz Amplifier EMC	EMC184045B	980175
Absorber 30 MHz ~ 40GHz	TDK / IP-045C	NA

TYPICAL ABSORPTION CHARACTERISTICS (VERTICAL INCIDENCE)

Unit: dB

Material name	30MHz	50MHz	100MHz	500MHz	1GHz	5GHz	18GHz	40GHz
IP-045C	18	18	15	20	20	30	40	40

- NOTE:
1. The calibration interval of the above test instruments is 12 / 24 months and the calibrations are traceable to NML/ROC and NIST/USA.
 2. The test was performed in HwaYa RF Chamber 1.
 3. The horn antenna and preamplifier (model: 8449B) are used only for the measurement of emission frequency above 1 GHz if tested.

3.6 Test Procedure

- a. Connect EUT to Spectrum Analyzer and record the power setting of EUT and the measured conducted power / conducted power spectral density.
- b. Fasten EUT on the Positioner on center of turntable, for Free Space only.
- c. Configuration EUT transmitting packages (SW: iperf) to the communication emulator in Beamforming mode. Please refer to figure 2 for detail configuration.
- d. Make sure the transmit signal stable and duty cycle greater than or equal to 98% at the maximum RF power level.
- e. Setup the channel power function and power spectral density function by spectrum analyzer.
- f. Read the channel power level and power spectral density level on spectrum analyzer and record in following positions.
 1. The EUT is then stepped between -90 to 90 degrees along the theta axis in 15-degree increments. At each theta position, the phi axis is stepped from 0 to 360 degrees or from 360 to 0 degrees in 15-degree increments.
 2. Data (channel power level / power spectral density level) is recorded using the spectrum analyzer for both theta and phi polarizations at each position.
 3. Set Phi and Theta Positioners to Boresight Phi and Theta angular position of maximum channel power level / power spectral density level.
 4. Fix the Phi angular in Step f.3, the EUT is then stepped between 0 to 360 degrees along the theta axis in 1-degree increments for E-Plane and H-Plane.
 5. Data (channel power level / power spectral density level) is recorded using the spectrum analyzer for both E-Plane and H-Plane at each position, then calculate and indicate the 3-dB beamwidth.
 6. When the 3-dB beamwidth in Step f.5 is less than 15 degree, repeat Step f.1 and Step f.2 with the 1/5/10-degree increments which is less than and close to 3-dB beamwidth.
- g. According to section 2.3 of KDB 412172 D01 Determining ERP and EIRP v01r01, the substitution horn antenna is substituted for EUT at the same position and signals generator export the CW signal to the substitution antenna via a TX cable. Rotated the Turn Table and moved receiving antenna to find the maximum radiation power. Adjust output power level of S.G to get a Value of spectrum reading equal to "Raw Value". Record the power level of S.G.

$$\text{EIRP} = P_{\text{SigGen}} + G_T - L_C$$

where:

P_{SigGen} = power setting of the signal generator that produces the same received power reading as the DUT, in dBm, dBW or psd;

G_T = gain of the substitute antenna, in dBd (ERP) or dBi (EIRP);

L_C = signal loss in the cable connecting the signal generator to the substitute antenna, in dB

- h. Directional Antenna Gain (dBi) = Max EIRP (dBm) – Total Conducted Power (dBm)

3.7 Test Results (Measurement Quantity) of EIRP Measurement & Directional Gain Calculation

Tested By	Tank Wu
-----------	---------

EIRP (802.11 ax HE20 of Beamforming Mode / Nss=1)

Mode	Channel	Frequency (MHz)	Polarization	Θ (degree)	Φ (degree)	Raw Value (dBm)	C.F. (dB)	Max EIRP (dBm)
BF (Nss=1)	6	2437	Ver.	75	165	-10.35	43.91	33.56
	36	5180	Ver.	0	150	-18.09	50.38	32.29
	64	5320	Ver.	60	120	-21.04	50.50	29.46
	100	5500	Ver.	-15	180	-20.62	49.97	29.35
	157	5785	Ver.	0	330	-13.91	49.86	35.95

Note: Max EIRP (dBm) = Raw Value(dBm) + Correction Factor(dB)
 Correction Factor(dB) = Antenna Gain(dBi) + Cable Loss(dB) + Free Space Loss(dB)
 Peak EIRP measurement values please refer to test plots in Section 3.8.

Directional Gain Calculation (802.11 ax HE20 of Beamforming Mode / Nss=1)

Mode	Channel	Frequency (MHz)	Max EIRP (dBm)	Total Conducted Power (dBm)	Directional Ant. Gain (dBi)
BF (Nss=1)	6	2437	33.56	29.32	4.24
	36	5180	32.29	26.61	5.68
	64	5320	29.46	23.77	5.69
	100	5500	29.35	21.76	7.59
	157	5785	35.95	28.96	6.99

Note: Directional Antenna Gain (dBi) = Max EIRP – Total Conducted Power

EIRP (802.11 ax HE20 of Beamforming Mode / Nss=2)

Mode	Channel	Frequency (MHz)	Polarization	Θ (degree)	Φ (degree)	Raw Value (dBm)	C.F. (dB)	Max EIRP (dBm)
BF (Nss=2)	6	2437	Ver.	75	150	-12.35	43.91	31.56
	36	5180	Ver.	15	150	-22.13	50.38	28.25
	64	5320	Ver.	60	120	-23.16	50.50	27.34
	100	5500	Ver.	-15	180	-21.26	49.97	28.71
	157	5785	Ver.	0	330	-15.35	49.86	34.51

Note: Max EIRP (dBm) = Raw Value(dBm) + Correction Factor(dB)
 Correction Factor(dB) = Antenna Gain(dBi) + Cable Loss(dB) + Free Space Loss(dB)
 Peak EIRP measurement values please refer to test plots in Section 3.8.

Directional Gain Calculation (802.11 ax HE20 of Beamforming Mode / Nss=2)

Mode	Channel	Frequency (MHz)	Max EIRP (dBm)	Total Conducted Power (dBm)	Directional Ant. Gain (dBi)
BF (Nss=2)	6	2437	31.56	29.59	1.97
	36	5180	28.25	25.04	3.21
	64	5320	27.34	23.80	3.54
	100	5500	28.71	23.15	5.56
	157	5785	34.51	29.60	4.91

Note: Directional Antenna Gain (dBi) = Max EIRP – Total Conducted Power

EIRP (802.11 ax HE20 of Beamforming Mode / Nss=4)

Mode	Channel	Frequency (MHz)	Polarization	Θ (degree)	Φ (degree)	Raw Value (dBm)	C.F. (dB)	Max EIRP (dBm)
BF (Nss=4)	100	5500	Ver.	-15	180	-24.84	49.97	25.13
	157	5785	Ver.	0	330	-17.76	49.86	32.10

Note: Max EIRP (dBm) = Raw Value(dBm) + Correction Factor(dB)
 Correction Factor(dB) = Antenna Gain(dBi) + Cable Loss(dB) + Free Space Loss(dB)
 Peak EIRP measurement values please refer to test plots in Section 3.8.

Directional Gain Calculation (802.11 ax HE20 of Beamforming Mode / Nss=4)

Mode	Channel	Frequency (MHz)	Max EIRP (dBm)	Total Conducted Power (dBm)	Directional Ant. Gain (dBi)
BF (Nss=4)	100	5500	25.13	22.66	2.47
	157	5785	32.10	29.77	2.33

Note: Directional Antenna Gain (dBi) = Max EIRP – Total Conducted Power

3.8 3D EIRP Pattern and 3-dB Beam-width Test Plots

2.4GHz and 5GHz bands

2.4GHz HE20 CH6 BF On Nss1

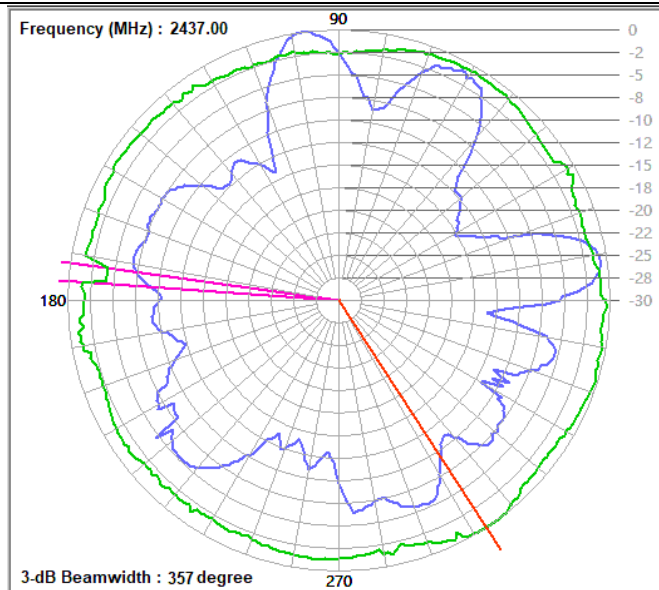
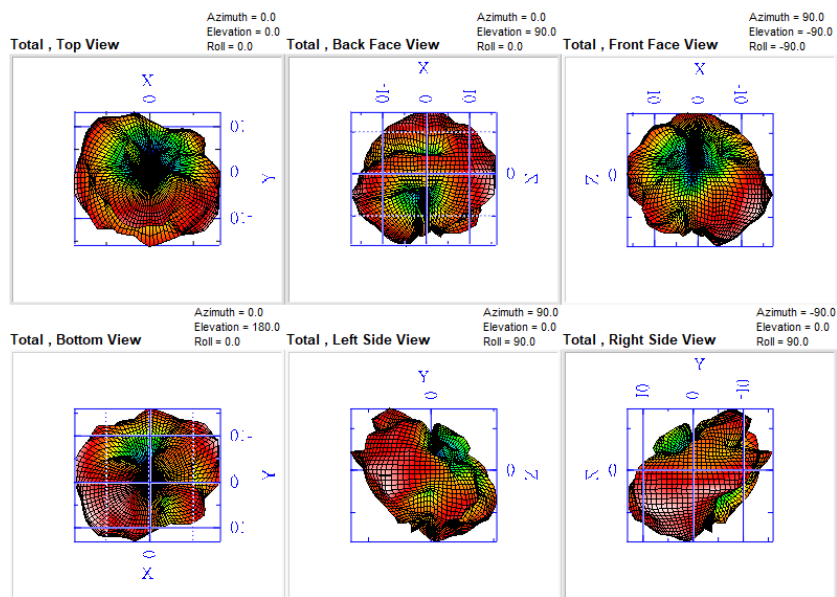
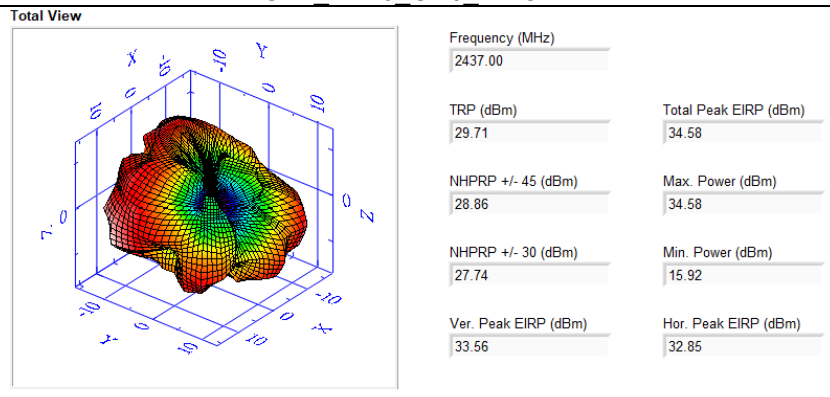

Frequency (MHz) : 2437.00 Polarity 1 : Horizontal Max. Gain 1 (dB) : 14.56 Beamwidth 1 : 16
 Polarity 2 : Vertical Max. Gain 2 (dB) : 28.18 Beamwidth 2 : 357
 (at the 3 dB down)

802.11ax HE20 CH36 BF On Nss1

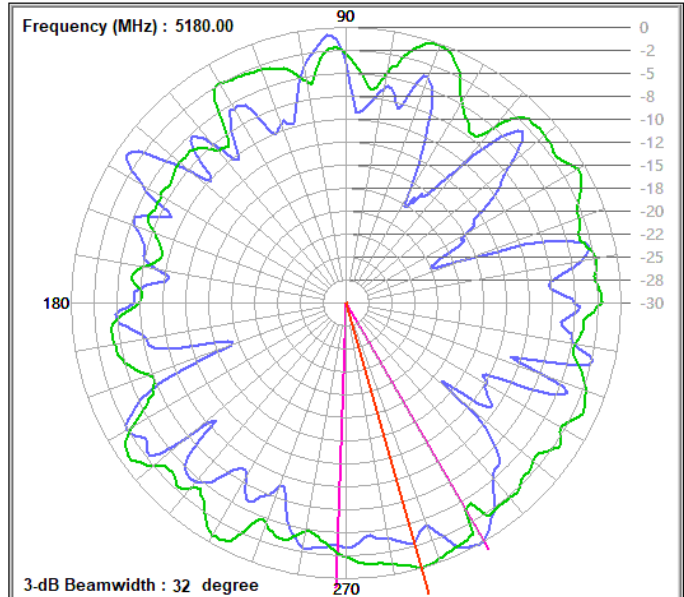
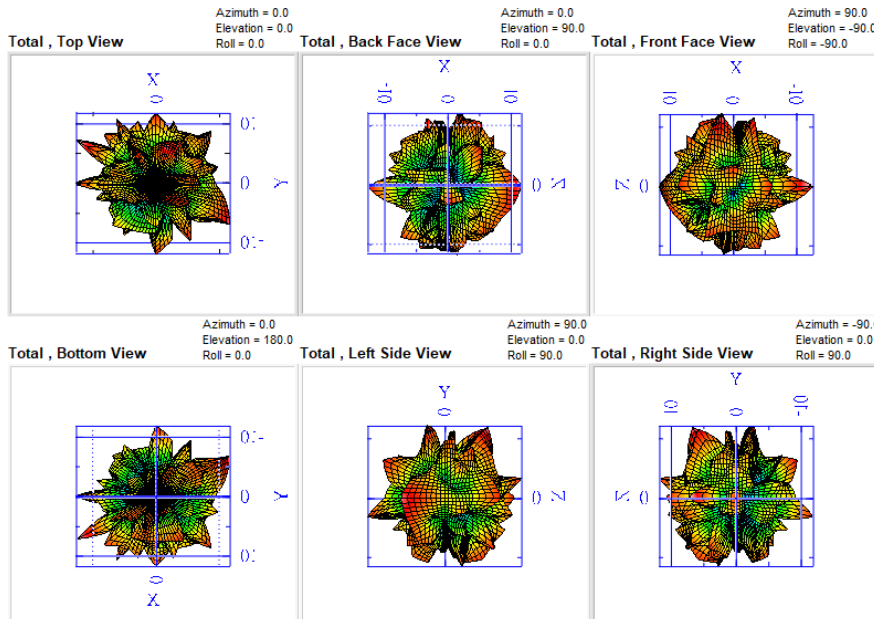
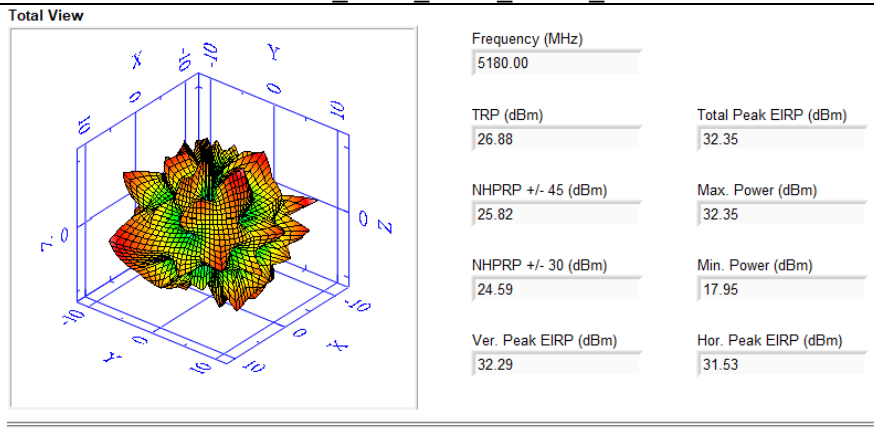

Frequency (MHz) : 5180.00 Polarity 1 : Horizontal Max. Gain 1 (dB) : 17.88 Beamwidth 1 : 16
 Polarity 2 : Vertical Max. Gain 2 (dB) : 26.07 Beamwidth 2 : 32
 (at the 3 dB down)

802.11ax HE20 CH64 BF On Nss1

Total View

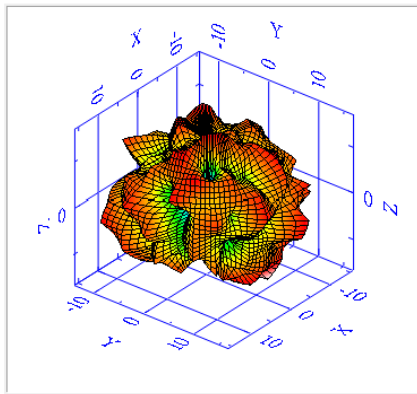

Frequency (MHz)	5320.00	
TRP (dBm)	23.77	Total Peak EIRP (dBm) 29.71
NHPRP +/- 45 (dBm)	22.61	Max. Power (dBm) 29.71
NHPRP +/- 30 (dBm)	21.36	Min. Power (dBm) 10.26
Ver. Peak EIRP (dBm)	29.46	Hor. Peak EIRP (dBm) 27.21

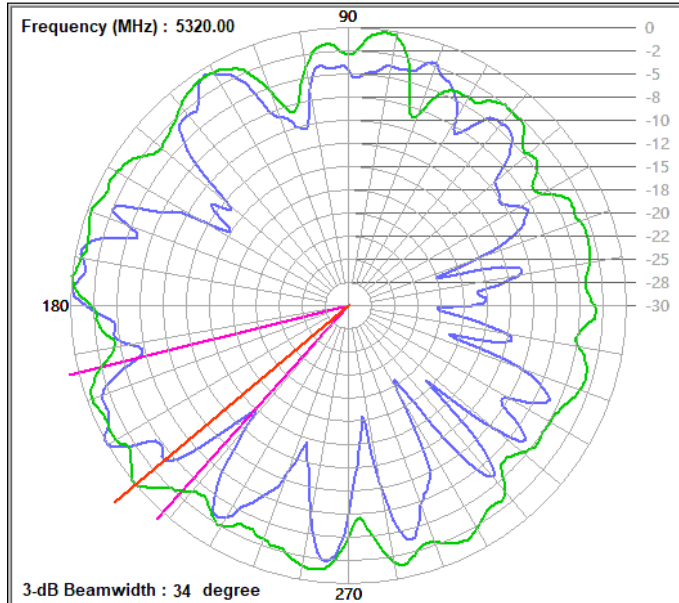
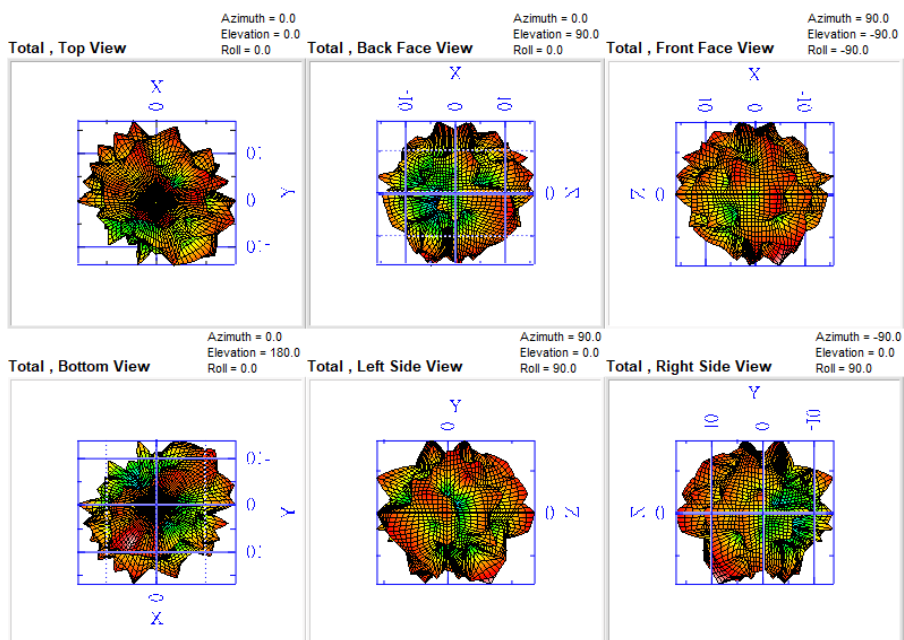

Frequency (MHz) : 5320.00 Polarity 1 : Horizontal Max. Gain 1 (dB) : 19.35 Beamwidth 1 : 16
 Polarity 2 : Vertical Max. Gain 2 (dB) : 25.24 Beamwidth 2 : 34
 (at the 3 dB down)

802.11ax HE20 CH100 BF On Nss1

Total View

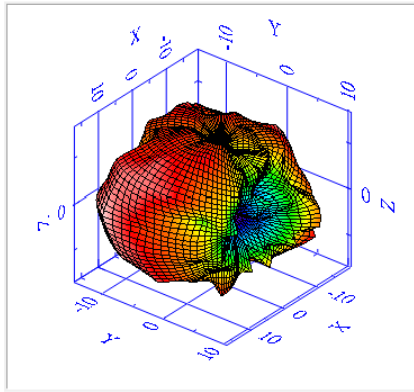

Frequency (MHz)	5500.00	
TRP (dBm)	24.37	Total Peak EIRP (dBm) 29.37
NHPRP +/- 45 (dBm)	23.3	Max. Power (dBm) 29.37
NHPRP +/- 30 (dBm)	22.06	Min. Power (dBm) 9.29
Ver. Peak EIRP (dBm)	29.35	Hor. Peak EIRP (dBm) 26.62

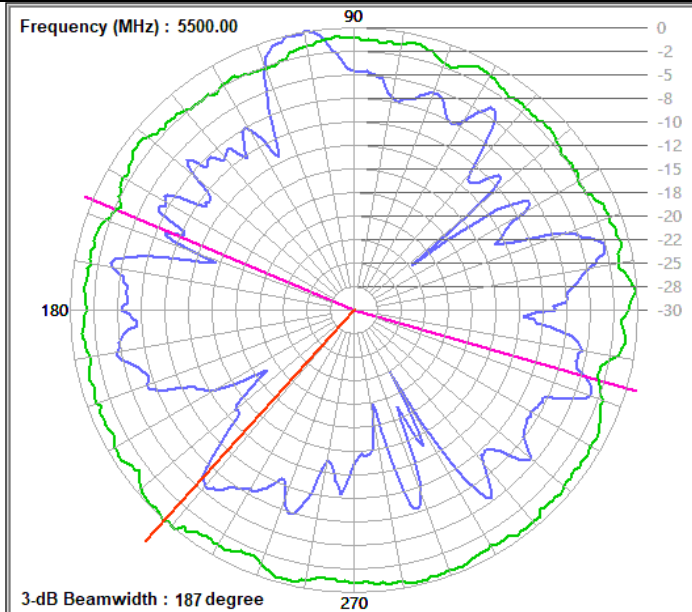
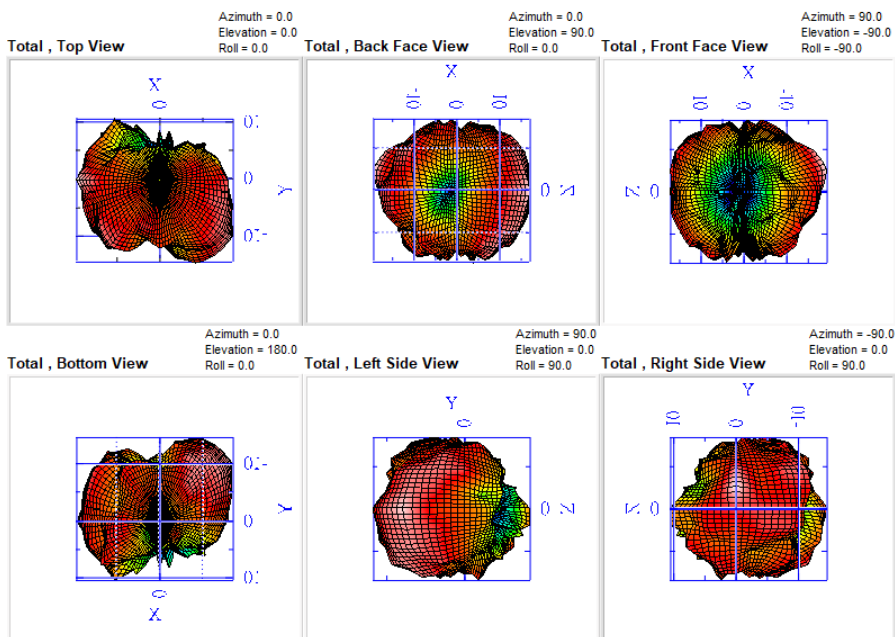

Frequency (MHz) : 5500.00 Polarity 1 : Horizontal Max. Gain 1 (dB) : 12.59 Beamwidth 1 : 17
 Polarity 2 : Vertical Max. Gain 2 (dB) : 26.00 Beamwidth 2 : 187
 (at the 3 dB down)

802.11ax HE20 CH157 BF On Nss1

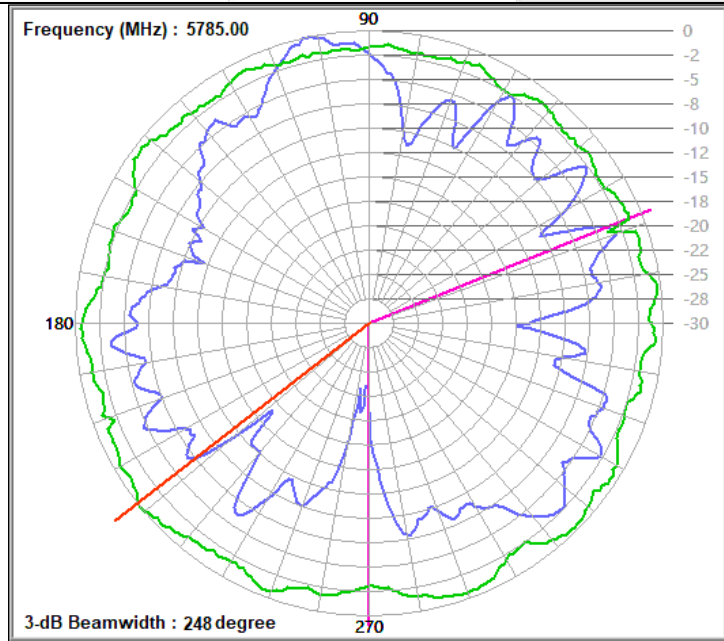
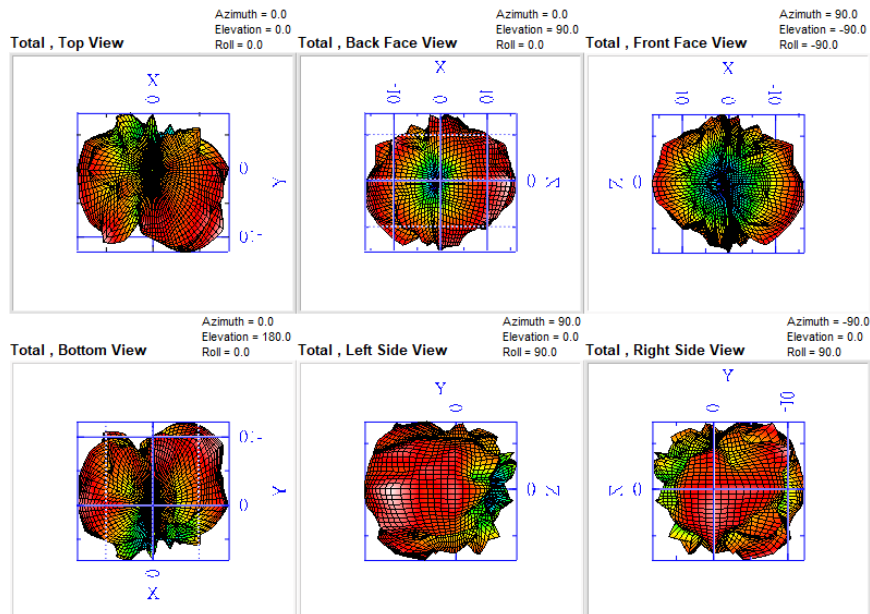
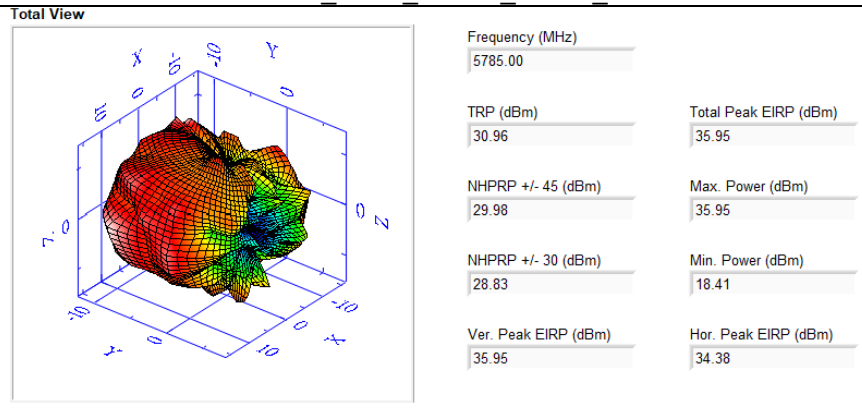

Frequency (MHz) : 5785.00 Polarity 1 : Horizontal Max. Gain 1 (dB) : 25.07 Beamwidth 1 : 24

 Polarity 2 : Vertical Max. Gain 2 (dB) : 35.85 Beamwidth 2 : 248

(at the 3 dB down)

2.4GHz HE20 CH6 BF On Nss2

Total View

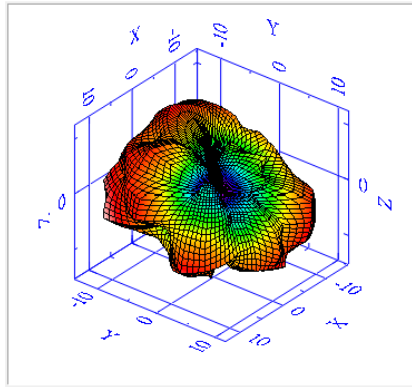

Frequency (MHz)	2437.00	
TRP (dBm)	27.17	Total Peak EIRP (dBm)
		31.85
NHPRP +/- 45 (dBm)	26.33	Max. Power (dBm)
		31.85
NHPRP +/- 30 (dBm)	25.24	Min. Power (dBm)
		15.75
Ver. Peak EIRP (dBm)	31.56	Hor. Peak EIRP (dBm)
		30.16

Total , Top View

Azimuth = 0.0
Elevation = 0.0
Roll = 0.0

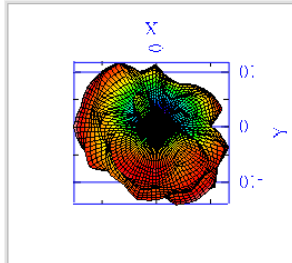

Total , Back Face View

Azimuth = 0.0
Elevation = 90.0
Roll = 0.0

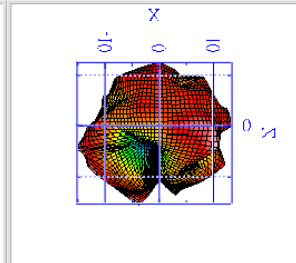

Total , Front Face View

Azimuth = 90.0
Elevation = -90.0
Roll = 0.0

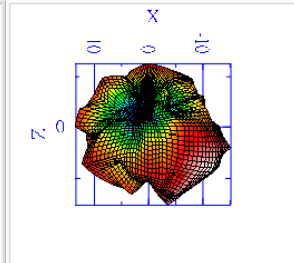

Total , Bottom View

Azimuth = 0.0
Elevation = 180.0
Roll = 0.0

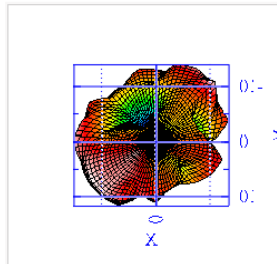

Total , Left Side View

Azimuth = 90.0
Elevation = 0.0
Roll = 90.0

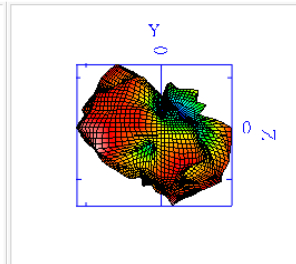

Total , Right Side View

Azimuth = -90.0
Elevation = 0.0
Roll = 90.0

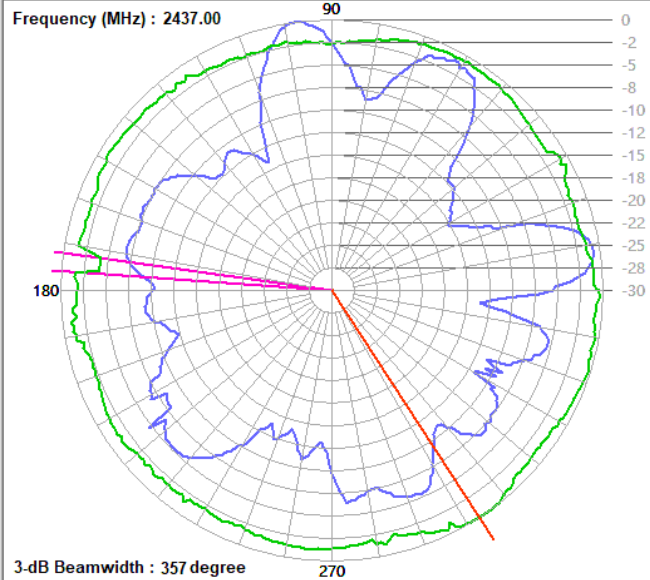
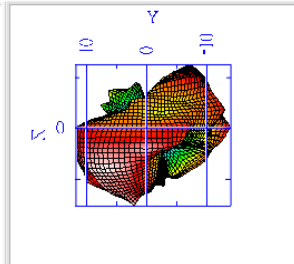

Frequency (MHz) : 2437.00 Polarity 1 : Horizontal Max. Gain 1 (dB) : 14.56 Beamwidth 1 : 16
 Polarity 2 : Vertical Max. Gain 2 (dB) : 28.18 Beamwidth 2 : 357
 (at the 3 dB down)

802.11ax HE20 CH36 BF On Nss2

Total View

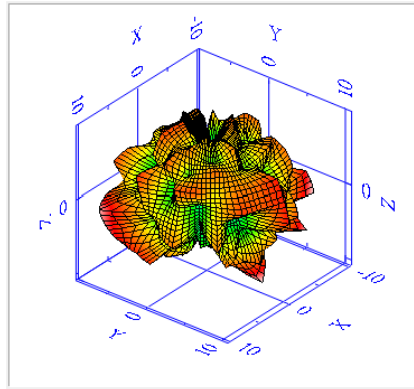

Frequency (MHz)	5180.00	
TRP (dBm)	23.72	Total Peak EIRP (dBm) 28.36
NHPRP +/- 45 (dBm)	22.72	Max. Power (dBm) 28.36
NHPRP +/- 30 (dBm)	21.61	Min. Power (dBm) 15.91
Ver. Peak EIRP (dBm)	28.25	Hor. Peak EIRP (dBm) 25.93

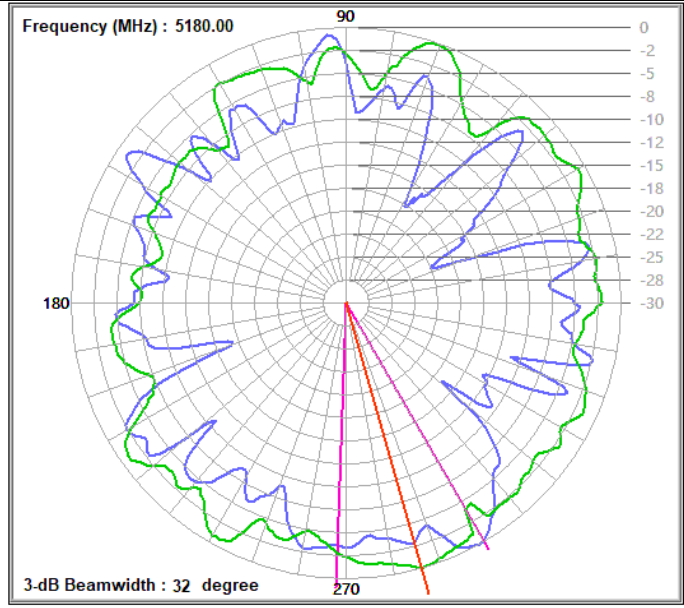
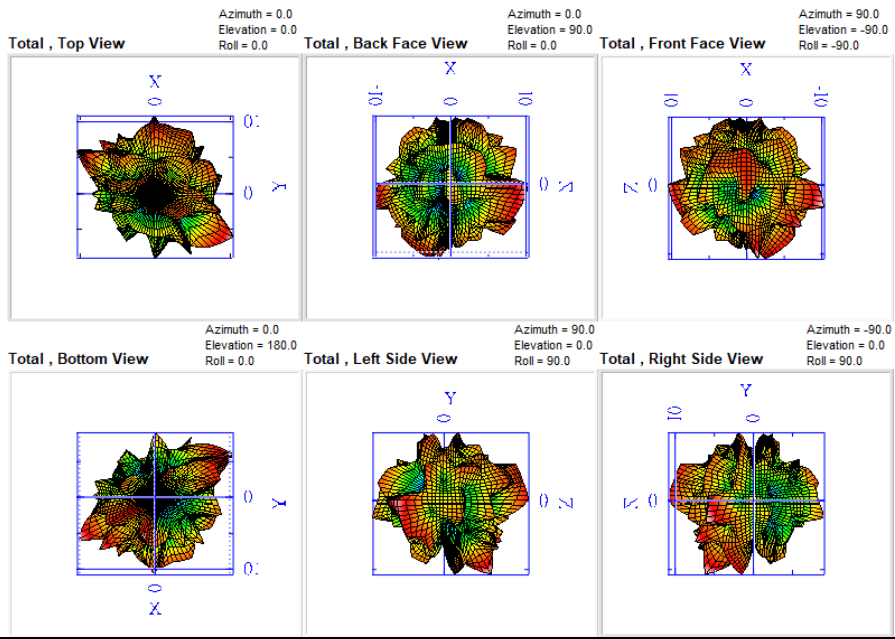

Frequency (MHz) : 5180.00 Polarity 1 : Horizontal Max. Gain 1 (dB) : 17.88 Beamwidth 1 : 16
 Polarity 2 : Vertical Max. Gain 2 (dB) : 26.07 Beamwidth 2 : 32
 (at the 3 dB down)

802.11ax HE20 CH64 BF On Nss2

Total View

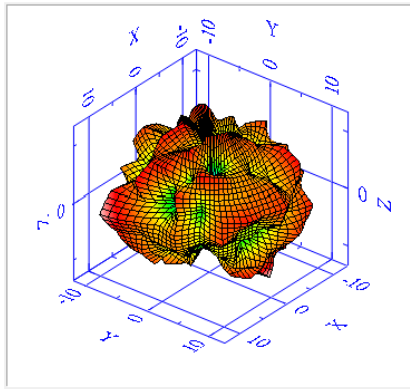

Frequency (MHz)	5320.00	
TRP (dBm)	22.7	Total Peak EIRP (dBm)
		27.58
NHPRP +/- 45 (dBm)	21.68	Max. Power (dBm)
		27.58
NHPRP +/- 30 (dBm)	20.49	Min. Power (dBm)
		11.88
Ver. Peak EIRP (dBm)	27.34	Hor. Peak EIRP (dBm)
		25.03

Total , Top View

Azimuth = 0.0
Elevation = 0.0
Roll = 0.0

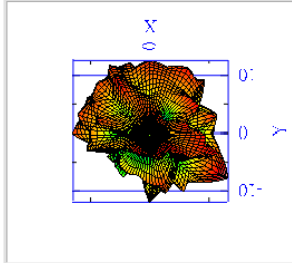

Total , Back Face View

Azimuth = 0.0
Elevation = 90.0
Roll = 0.0

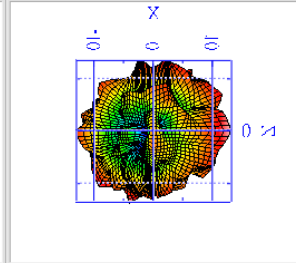

Total , Front Face View

Azimuth = 90.0
Elevation = -90.0
Roll = -90.0

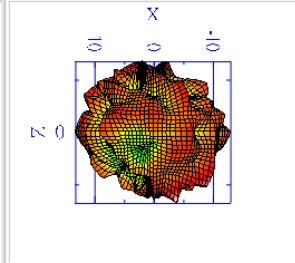

Total , Bottom View

Azimuth = 0.0
Elevation = 180.0
Roll = 0.0

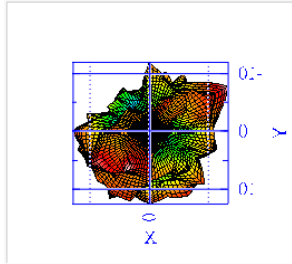

Total , Left Side View

Azimuth = 90.0
Elevation = 0.0
Roll = 90.0

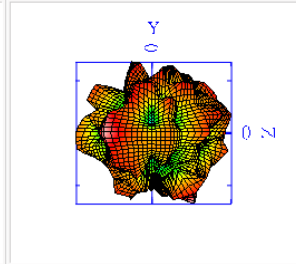

Total , Right Side View

Azimuth = -90.0
Elevation = 0.0
Roll = 90.0

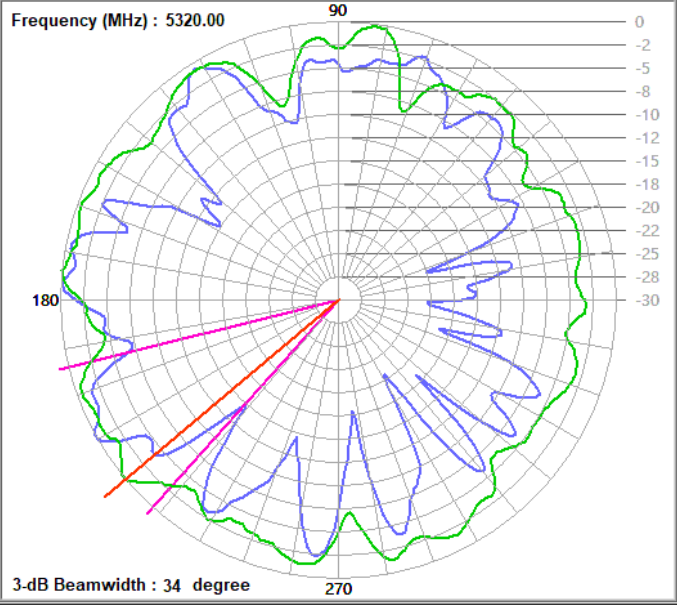
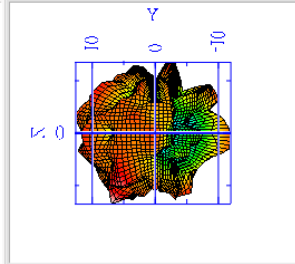

Frequency (MHz) : 5320.00 Polarity 1 : Horizontal Max. Gain 1 (dB) : 19.35 Beamwidth 1 : 16
 Polarity 2 : Vertical Max. Gain 2 (dB) : 25.24 Beamwidth 2 : 34
 (at the 3 dB down)

802.11ax HE20 CH100 BF On Nss2

Total View

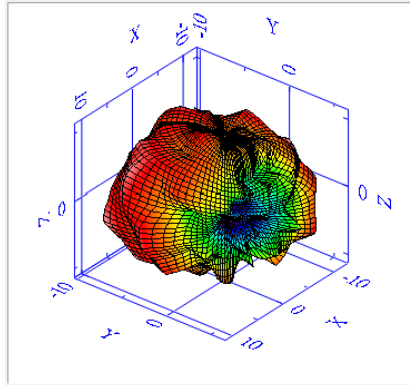

Frequency (MHz)	5500.00
TRP (dBm)	24.94
NHPRP +/- 45 (dBm)	23.81
NHPRP +/- 30 (dBm)	22.35
Ver. Peak EIRP (dBm)	28.71
Total Peak EIRP (dBm)	28.91
Max. Power (dBm)	28.91
Min. Power (dBm)	15.73
Hor. Peak EIRP (dBm)	27.52

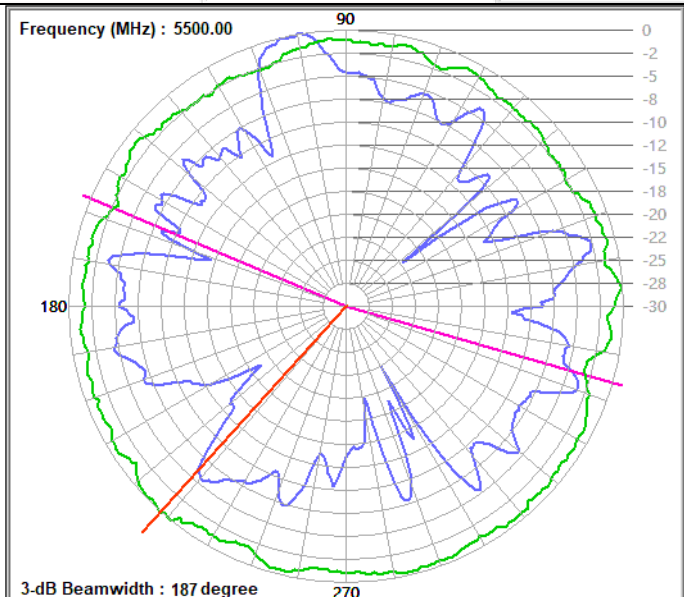
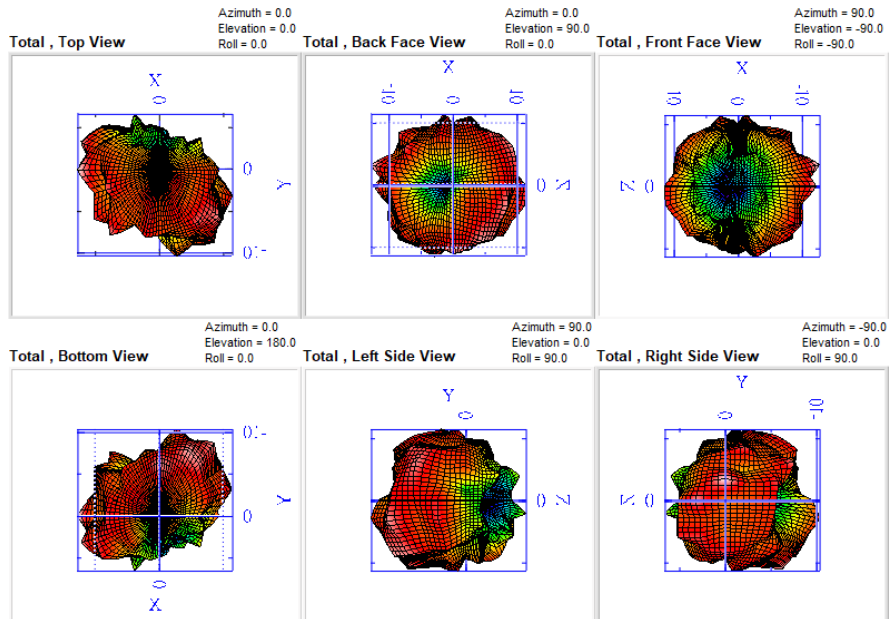

Frequency (MHz) : 5500.00 Polarity 1 : Horizontal Max. Gain 1 (dB) : 12.59 Beamwidth 1 : 17
 Polarity 2 : Vertical Max. Gain 2 (dB) : 26.00 Beamwidth 2 : 187
 (at the 3 dB down)

802.11ax HE20 CH157 BF On Nss2

Total View

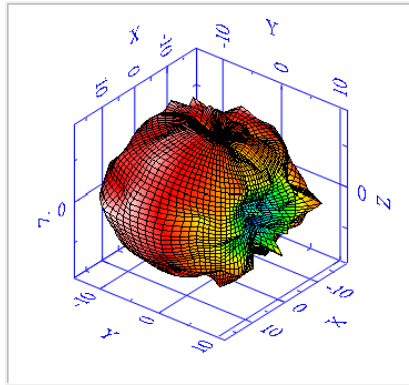

Frequency (MHz)	5785.00
TRP (dBm)	30.3
NHPRP +/- 45 (dBm)	29.05
NHPRP +/- 30 (dBm)	27.64
Ver. Peak EIRP (dBm)	34.51
Total Peak EIRP (dBm)	34.55
Max. Power (dBm)	34.55
Min. Power (dBm)	14.47
Hor. Peak EIRP (dBm)	34.1

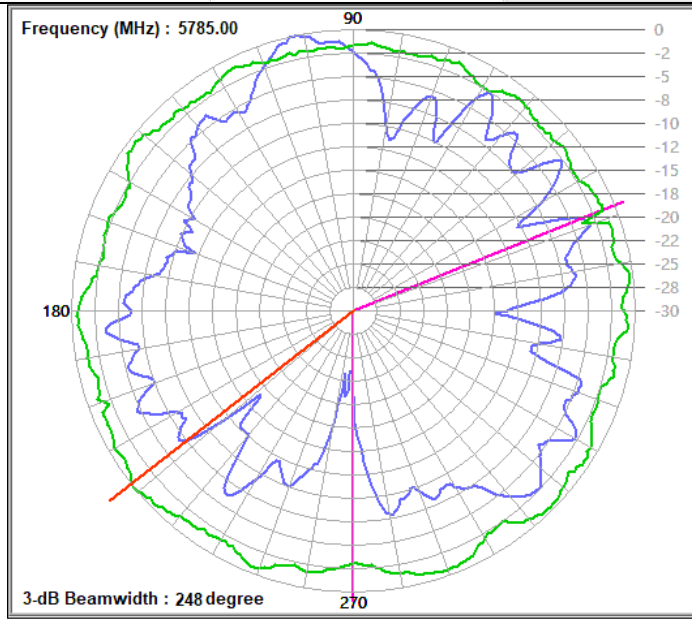
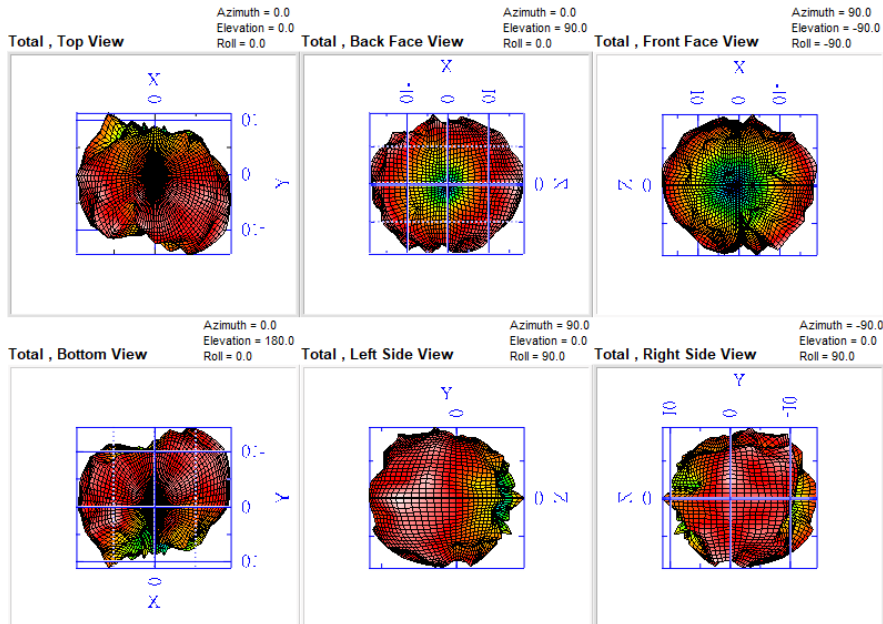

Frequency (MHz) : 5785.00 Polarity 1 : Horizontal Max. Gain 1 (dB) : 25.07 Beamwidth 1 : 24
 Polarity 2 : Vertical Max. Gain 2 (dB) : 35.85 Beamwidth 2 : 248
 (at the 3 dB down)

802.11ax HE20 CH100 BF On Nss4

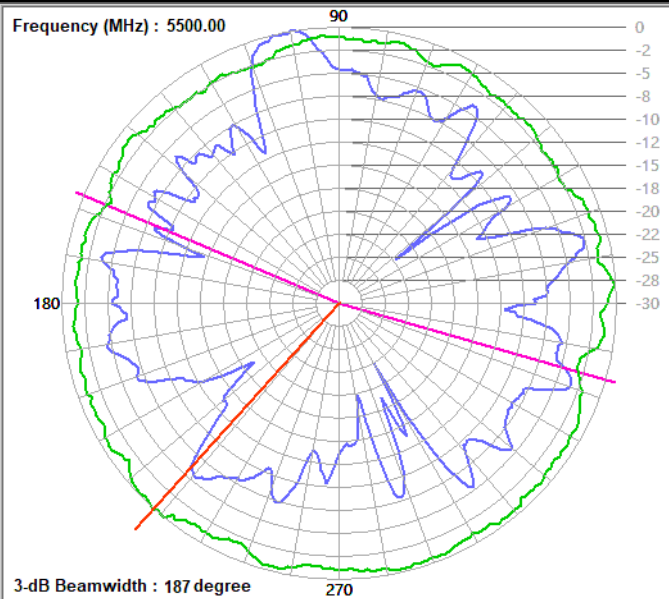
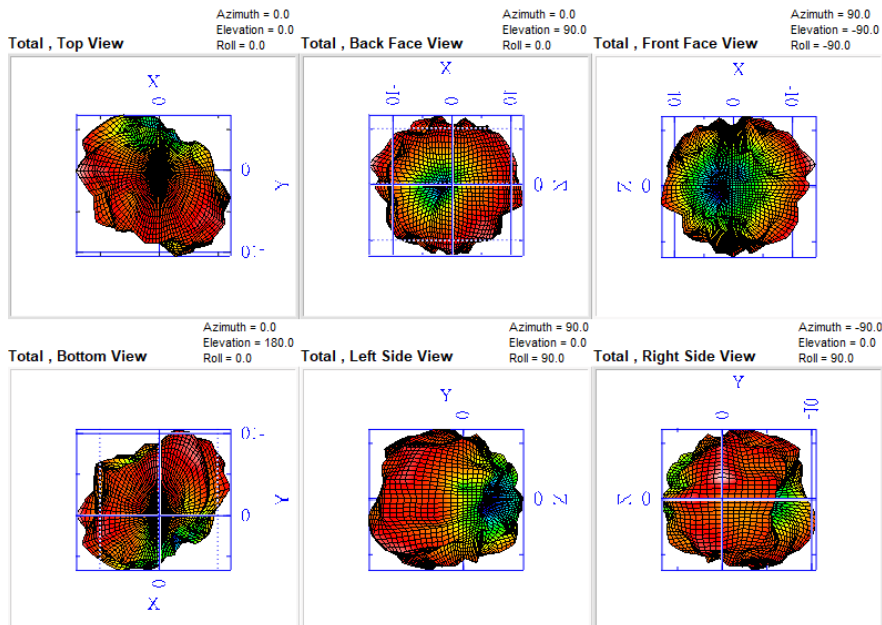
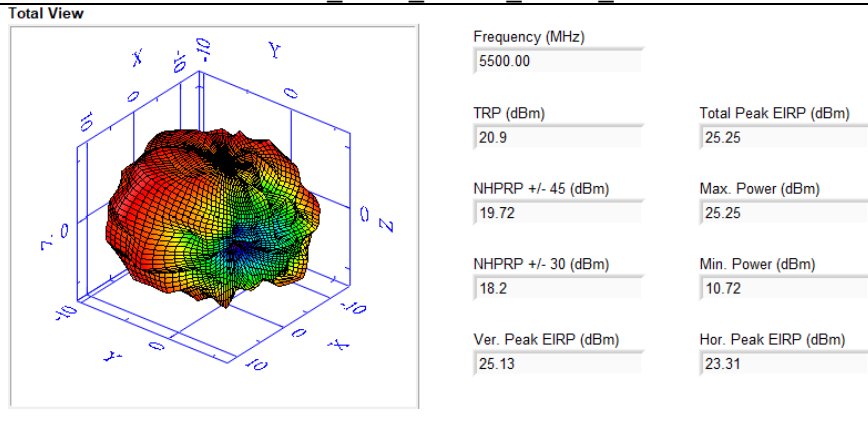

Frequency (MHz) : 5500.00 Polarity 1 : Horizontal Max. Gain 1 (dB) : 12.59 Beamwidth 1 : 17

Polarity 2 : Vertical Max. Gain 2 (dB) : 26.00 Beamwidth 2 : 187

(at the 3 dB down)

802.11ax HE20 CH157 BF On Nss4

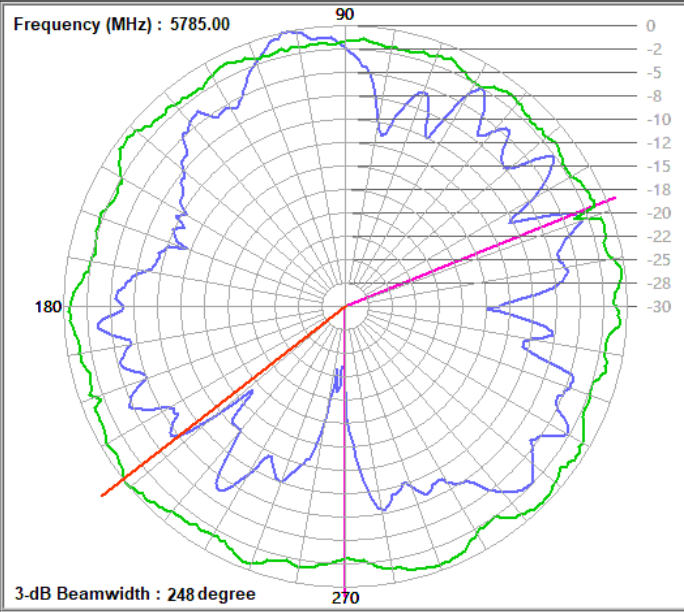
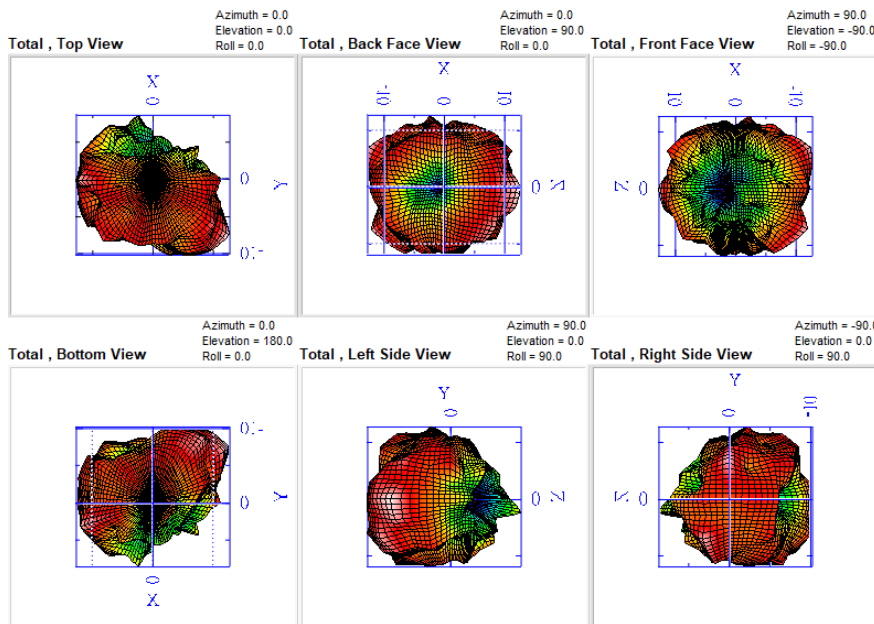
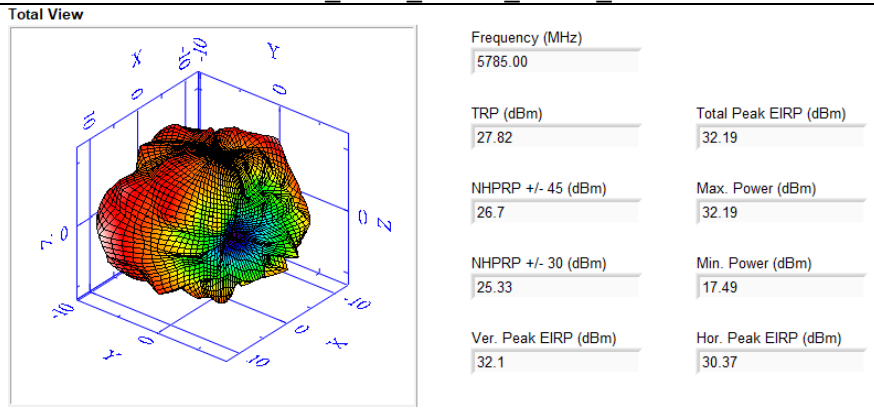

Frequency (MHz) : 5785.00 Polarity 1 : Horizontal Max. Gain 1 (dB) : 25.07 Beamwidth 1 : 24
 Polarity 2 : Vertical Max. Gain 2 (dB) : 35.85 Beamwidth 2 : 248
 (at the 3 dB down)

Appendix - Information of the Testing Laboratories

We, Bureau Veritas Consumer Products Services (H.K.) Ltd., Taoyuan Branch, were founded in 1988 to provide our best service in EMC, Radio, Telecom and Safety consultation. Our laboratories are FCC recognized accredited test firms and accredited and approved according to ISO/IEC 17025.

If you have any comments, please feel free to contact us at the following:

Lin Kou EMC/RF Lab
Tel: 886-2-26052180
Fax: 886-2-26051924

Hsin Chu EMC/RF/Telecom Lab
Tel: 886-3-6668565
Fax: 886-3-6668323

Hwa Ya EMC/RF/Safety Lab
Tel: 886-3-3183232
Fax: 886-3-3270892

Email: service.adt@tw.bureauveritas.com

Web Site: www.bureauveritas-adt.com

The address and road map of all our labs can be found in our web site also.

--- END ---