



## Test Report

Product Name : Wireless 11g CardBus

Model No.: CB54G, MS-6819

FCC ID.: I4L-CB54GMS6819

Applicant : MICRO-STAR INT'L Co., LTD

Address : No 69, Li-De st., Jung-He City, Taipei Hsien, Taiwan, R.O.C

Date of Receipt : Jun 12, 2003

Date of Test : July 02, 2003

Report No. : 036L126FI

The test results relate only to the samples tested.

The test report shall not be reproduced except in full without the written approval of Quietek Corporation.

This report must not be used to claim product endorsement by NVLAP any agency of the U.S. Government

# Test Report Certification

Test Date : July 02, 2003

Report No. : 036L126FI



Accredited by NIST (NVLAP)  
NVLAP Lab Code: 200533-0

Product Name : Wireless 11g CardBus

Applicant : MICRO-STAR INT'L Co., LTD

Address : No 69, Li-De st., Jung-He City, Taipei Hsien, Taiwan, R.O.C

Manufacturer : MICRO-STAR

Model No. : CB54G, MS-6819

Rated Voltage : AC 120V/60Hz

Trade Name : MICRO-STAR

Measurement Standard : FCC Part 15 Subpart C Paragraph 15.247

Measurement Procedure : ANSI C63.4: 1992

Test Result : Complied



Test results relate only to the samples tested.

The test report shall not be reproduced except in full without the written approval of Quietek Corporation.

This report must not be used to claim product endorsement by NVLAP any agency of the U.S. Government

Documented By : Miko Wu  
( Miko Wu )

Tested By : Tom Hsieh  
( Tom Hsieh )

Approved By : Gene Chang  
( Gene Chang )

# TABLE OF CONTENTS

Description	Page
<b>1. GENERAL INFORMATION .....</b>	<b>4</b>
1.1. EUT Description.....	4
1.2. Operational Description .....	5
1.3. Tested System Details.....	6
1.4. Configuration of tested System .....	7
1.5. EUT Exercise Software .....	7
1.6. Test Facility .....	8
<b>2. Conducted Emission.....</b>	<b>9</b>
2.1. Test Equipment.....	9
2.2. Test Setup .....	9
2.3. Limits .....	9
2.4. Test Procedure .....	10
2.5. Test Result of Conducted Emission.....	11
<b>3. Peak Power Output .....</b>	<b>13</b>
3.1. Test Equipment.....	13
3.2. Test Setup .....	13
3.3. Limits .....	13
3.4. Test Result of Peak Power Output.....	14
<b>4. Radiated Emission.....</b>	<b>15</b>
4.1. Test Equipment.....	15
4.2. Test Setup .....	15
4.3. Limits .....	16
4.4. Test Procedure .....	17
4.5. Test Result of Radiated Emission.....	18
<b>5. Band Edge .....</b>	<b>24</b>
5.1. Test Equipment.....	24
5.2. Test Setup .....	24
5.3. Limits .....	25
5.4. Test Procedure .....	25
5.5. Test Result of Band Edge .....	26
<b>6. Occupied Bandwidth.....</b>	<b>28</b>
6.1. Test Equipment.....	28
6.2. Test Setup .....	28
6.3. Limits .....	28
6.4. Test Result of Occupied Bandwidth .....	29
<b>7. Power Density .....</b>	<b>32</b>
7.1. Test Equipment.....	32
7.2. Test Setup .....	32
7.3. Limits .....	32
7.4. Test Result of Power Density .....	33
<b>8. EMI Reduction Method During Compliance Testing .....</b>	<b>36</b>

Attachment 1: EUT Test Photographs  
 Attachment 2: EUT Detailed Photographs

## 1. GENERAL INFORMATION

### 1.1. EUT Description

Product Name	Wireless 11g CardBus
Trade Name	MICRO-STAR
Model No.	CB54G, MS-6819

Frequency of Each Channel:

Channel	Frequency	Channel	Frequency	Channel	Frequency
Channel 1:	2412 MHz	Channel 5:	2432 MHz	Channel 9:	2452 MHz
Channel 2:	2417 MHz	Channel 6:	2437 MHz	Channel 10:	2457 MHz
Channel 3:	2422 MHz	Channel 7:	2442 MHz	Channel 11:	2462 MHz
Channel 4:	2427 MHz	Channel 8:	2447 MHz		

Note:

1. This device is a 2.4GHz Wireless 11g CardBus included a 2.4GHz receiving function.
2. These tests were conducted on a sample of the equipment for the purpose of demonstrating compliance with Part 15 Subpart B for 2.4GHz Receiver.
3. Quietek has verified the construction and function in typical operation. All the test modes were carried out with the EUT in normal operation, which was shown in this test report and defined as:

Test Mode:            Mode 1: Normal operation

## 1.2. Operational Description

EUT is a Wireless 11g CardBus with 11 channels. This device provided four kinds of transmitting speed 1, 2, 5.5 and 11Mbps. The device of RF carrier is DQPSK, DB PSK and CCK (IEEE 802.11b) or eight kinds of transmitting speed 6, 9, 12, 18, 24, 36, 48 and 54Mbps. The device of RF carrier is OFDM (IEEE 802.11g).

The device adapts direct sequence spread spectrum modulation. The Connector antenna was scolded on PCB provides diversity function to improve the receiving function.

This Wireless 11g CardBus, compliant with IEEE 802.11b and IEEE 802.11g, is a high-efficiency Wireless LAN adapter. It allows your computer to connect to a wireless network and to share resources, such as files or printers without being bound to the network wires. Operation in 2.4GHz Direct Sequence Spread Spectrum (DSSS) radio transmission, the Wireless 11g CardBus Wired Equivalent Protection (WEP) algorithm is used. In addition, its standard compliance ensures that it can communicate with any IEEE 802.11b and IEEE 802.11g network.

### 1.3. Tested System Details

The types for all equipment, plus descriptions of all cables used in the tested system (including inserted cards) are:

	Product	Manufacturer	Model No.	Serial No.	Power Cord
(1)	LCD Monitor	View Sonic	VLCDS23303-1	AOT021710465	Non-Shielded , 1.8m
(2)	USB Keyboard	BTC	5200U	N/A	N/A
(3)	USB Mouse	ASUS	MOUSE	N/A	N/A
(4)	Microphone & Earphone	TOKTO	SX-MI	N/A	N/A
(5)	USB 2.0 HDD	NEW MOTION	USB/FIREWIRE	102212	Power by PC
(6)	IEEE-1394 HDD	SKYMASTER	DEM-1351	N/A	Non-Shielded 1.8m
(7)	W/LAN Card	LEMEL	LM-WLC030	1231Q048877	N/A
(8)	Notebook PC	ASUS	S1300	26NP018680	Non-Shielded 1.8m
(9)	Notebook PC	ASUS	S1300	24NP035390	Non-Shielded 1.8m

	Signal Cable Type	Signal Cable Description
A.	VGA Cable	Shielded, 1.8m, with two ferrite cores bonded.
B.	USB Keyboard Cable	Shielded, 1.8m
C.	USB Mouse Cable	Shielded, 1.8m
D.	Microphone & Earphone Cable	Non-shielded, 1.8m
E.	USB 2.0 Cable	Shielded, 1.2m
F.	IEEE 1394 Cable	Shielded, 1.2m
G.	Telecom Cable	Non-shielded, 3m
H.	LAN Cable	Non-shielded, 3m

### 1.4. Configuration of tested System

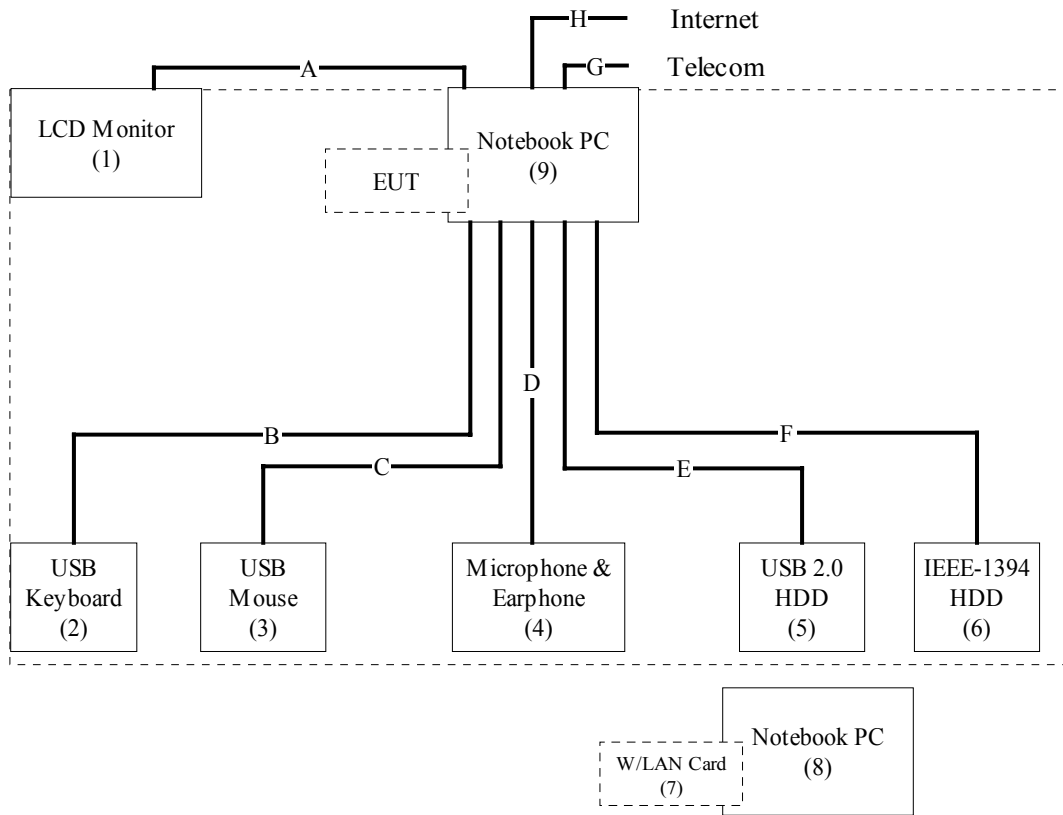

### 1.5. EUT Exercise Software

- 1.4.1 Setup the EUT and simulators as shown on 1.3.
- 1.4.2 Turn on the power of all equipment.
- 1.4.3 Notebook PC reads data from disk.
- 1.4.4 Data will be receiving through EUT.
- 1.4.5 The receive status will be shown on the monitor.
- 1.4.6 Repeat the above procedure 1.4.3 to 1.4.5

**1.6. Test Facility**

Ambient conditions in the laboratory:

Items	Required (IEC 68-1)	Actual
Temperature (°C)	15-35	20-35
Humidity (%RH)	25-75	50-65
Barometric pressure (mbar)	860-1060	950-1000

Site Description: June 22, 2001 File on  
 Federal Communications Commission  
 FCC Engineering Laboratory  
 7435 Oakland Mills Road  
 Columbia, MD 21046  
 Reference 31040/SIT1300F2



**0914**  
**ILAC MRA**

July 03, 2001 Accreditation on NVLAP  
 NVLAP Lab Code: 200533-0



Site Name: Quietek Corporation

Site Address: No. 5-22, Ruei-Shu Valley, Ruei-Ping Tsuen,  
 Lin-Kou Shiang, Taipei,  
 Taiwan, R.O.C.



TEL: 886-2-8601-3788 / FAX : 886-2-8601-3789

E-Mail : [service@quietek.com](mailto:service@quietek.com)



## 2. Conducted Emission

### 2.1. Test Equipment

The following test equipment are used during the conducted emission test:

Item	Instrument	Manufacturer	Type No./Serial No	Last Cal.	Remark
1	Test Receiver	R & S	ESCS 30/825442/17	May, 2003	
2	L.I.S.N.	R & S	ESH3-Z5/825016/6	May, 2003	EUT
3	L.I.S.N.	Kyoritsu	KNW-407/8-1420-3	May, 2003	Peripherals
4	Pulse Limiter	R & S	ESH3-Z2	May, 2003	
5	No.4 Shielded Room			N/A	

Note: All equipment upon which need to calibrated are with calibration period of 1 year.

### 2.2. Test Setup

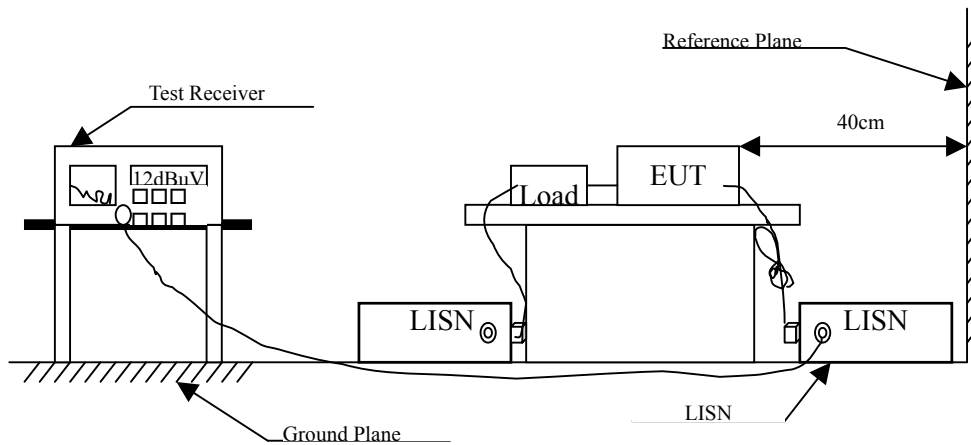

### 2.3. Limits

FCC Part 15 Subpart C Paragraph 15.207 (dBuV) Limit		
Frequency MHz	Limits	
	uV	dBuV
0.15 - 0.50	66-56 <sup>(註)</sup>	56-46 <sup>(註)</sup>
0.50-5.0	56	46
5.0 - 30	60	50

## 2.4. Test Procedure

The EUT and simulators are connected to the main power through a line impedance stabilization network (L.I.S.N.). This provides a 50 ohm /50uH coupling impedance for the measuring equipment. The peripheral devices are also connected to the main power through a LISN that provides a 50ohm/50uH coupling impedance with 50ohm termination. (Please refers to the block diagram of the test setup and photographs.)

Both sides of A.C. line are checked for maximum conducted interference. In order to find the maximum emission, the relative positions of equipment and all of the interface cables must be changed according to ANSI C63.4:1992 on conducted measurement.

Conducted emissions were investigated over the frequency range from 0.15MHz to 30MHz using a receiver bandwidth of 9kHz.

## 2.5. Test Result of Conducted Emission

Product : Wireless 11g CardBus  
 Test Item : Conducted Emission Test  
 Power Line : Line 1  
 Test Mode : Mode 1: Normal operation

Frequency MHz	Cable Loss dB	LISN Factor dB	Reading Level dBuV	Emission Level dBuV	Limits dBuV
=====					
Quasi-Peak					
0.162	0.21	0.10	39.87	40.18	65.38
0.216	0.21	0.10	34.49	34.80	62.95
* 0.267	0.21	0.10	36.39	36.70	61.20
0.377	0.21	0.10	31.17	31.48	58.35
1.021	0.21	0.10	28.64	28.95	56.00
5.216	0.29	0.17	29.51	29.97	60.00
Average					
0.162	0.21	0.10	36.00	36.31	55.38
0.216	0.21	0.10	31.39	31.70	52.95
* 0.267	0.21	0.10	35.39	35.70	51.20
0.377	0.21	0.10	30.89	31.20	48.35
1.021	0.21	0.10	28.30	28.61	46.00
5.216	0.29	0.17	24.90	25.36	50.00

Note:

1. All Reading Levels are Quasi-Peak value.
2. “ \* ”, means this data is the worst emission level.
3. Emission Level = Reading Level + LISN Factor + Cable Loss.

Product : Wireless 11g CardBus  
 Test Item : Conducted Emission Test  
 Power Line : Line 2  
 Test Mode : Mode 1: Normal operation

Frequency MHz	Cable Loss dB	LISN Factor dB	Reading Level dBuV	Emission Level dBuV	Limits dBuV
=====					
Quasi-Peak					
0.162	0.21	0.10	39.93	40.24	65.38
0.216	0.21	0.10	35.09	35.40	62.96
* 0.267	0.21	0.10	36.23	36.54	61.20
0.377	0.21	0.10	31.21	31.52	58.35
1.021	0.21	0.10	28.24	28.55	56.00
9.361	0.33	0.20	27.34	27.87	60.00
Average					
0.162	0.21	0.10	35.10	35.41	55.38
0.216	0.21	0.10	31.40	31.71	52.96
* 0.267	0.21	0.10	35.40	35.71	51.20
0.377	0.21	0.10	31.10	31.41	48.35
1.021	0.21	0.10	27.90	28.21	46.00
9.361	0.33	0.20	23.20	23.73	50.00

Note:

1. All Reading Levels are Quasi-Peak value.
2. “ \* ”, means this data is the worst emission level.
3. Emission Level = Reading Level + LISN Factor + Cable Loss.

### 3. Peak Power Output

#### 3.1. Test Equipment

The following test equipments are used during the radiated emission tests:

	Equipment	Manufacturer	Model No./Serial No.	Last Cal.
X	Spectrum Analyzer	Advantest	R3272 / 72421194	May, 2003

Note: 1. All equipment upon which need to calibrated are with calibration period of 1 year.  
 2. Mark "X" test instruments are used to measure the final test results.

#### 3.2. Test Setup

##### Conduction Power Measurement

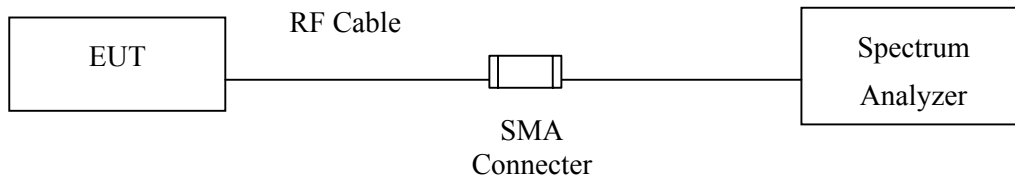

#### 3.3. Limits

The maximum peak power shall be less 1 Watt.

### 3.4. Test Result of Peak Power Output

Product : Wireless 11g CardBus  
 Test Item : Peak Power Output Data  
 Test Site : No.3OATS  
 Test Mode : Normal Operation

**Data Speed: 54Mbps**

Channel No.	Frequency (MHz)	Measurement	Required Limit	Result
1	2412.0	6.43 dBm	1 Watt= 30 dBm	Pass
6	2437.0	5.53 dBm	1 Watt= 30 dBm	Pass
11	2462.0	9.33 dBm	1 Watt= 30 dBm	Pass

(Channel 1)

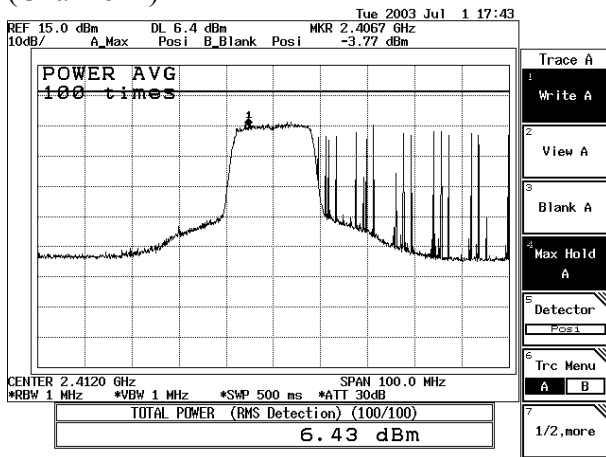

(Channel 6)

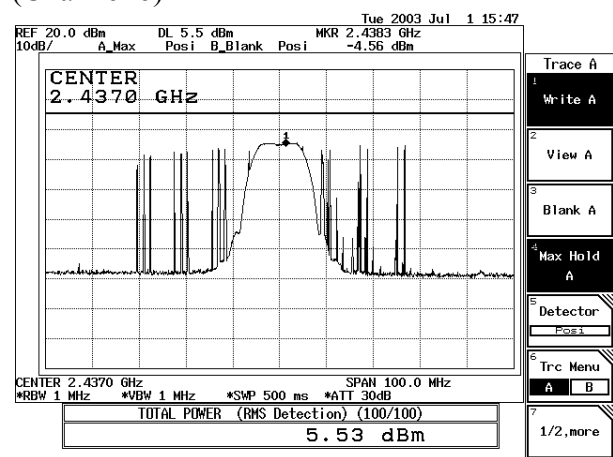

(Channel 11)

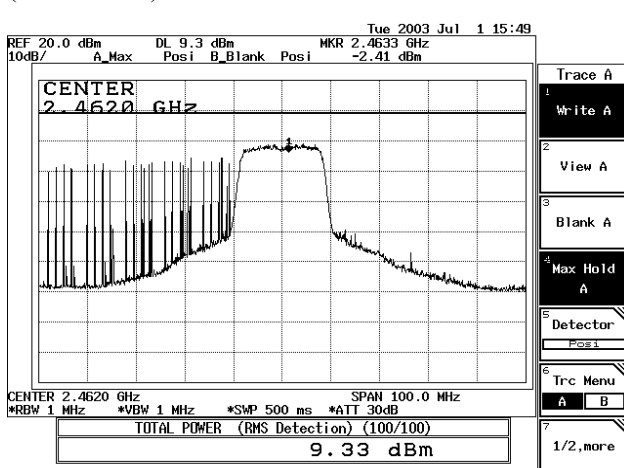

## 4. Radiated Emission

### 4.1. Test Equipment

The following test equipment are used during the radiated emission test:

Test Site	Equipment	Manufacturer	Model No./Serial No.	Last Cal.
<input type="checkbox"/> Site # 1	Test Receiver	R & S	ESVS 10 / 834468/003	July, 2003
	Spectrum Analyzer	Advantest	R3162/ 00803480	May, 2003
	Pre-Amplifier	Advantest	BB525C/ 3307A01812	May, 2003
	Bilog Antenna	SCHAFFNER	CBL6112B / 2697	Nov., 2002
<input type="checkbox"/> Site # 2	Test Receiver	R & S	ESCS 30 / 836858 / 022	Nov., 2002
	Spectrum Analyzer	Advantest	R3162 / 100803466	May, 2003
	Pre-Amplifier	Advantest	BB525C/3307A01814	May, 2003
	Bilog Antenna	SCHAFFNER	CBL6112B / 2705	Oct., 2002
	Horn Antenna	ETS	3115 / 0005-6160	July, 2003
	Pre-Amplifier	QTK	QTK-AMP-01/ 0001	July, 2003
<input checked="" type="checkbox"/> Site # 3	Test Receiver	R & S	ESI 26 / 838786 / 004	May, 2003
	Spectrum Analyzer	Advantest	R3162 / 100803480	May, 2003
	Pre-Amplifier	QTK	QTK-AMP-03 / 0003	May, 2003
	Bilog Antenna	SCHAFFNER	CBL6112B / 2697	May, 2003
	Horn Antenna	ETS	3115 / 0005-6160	July, 2003
	Pre-Amplifier	QTK	QTK-AMP-01 / 0001	July, 2003

- Note:
1. All equipments that need to calibrate are with calibration period of 1 year.
  2. Mark "X" test instruments are used to measure the final test results.

### 4.2. Test Setup

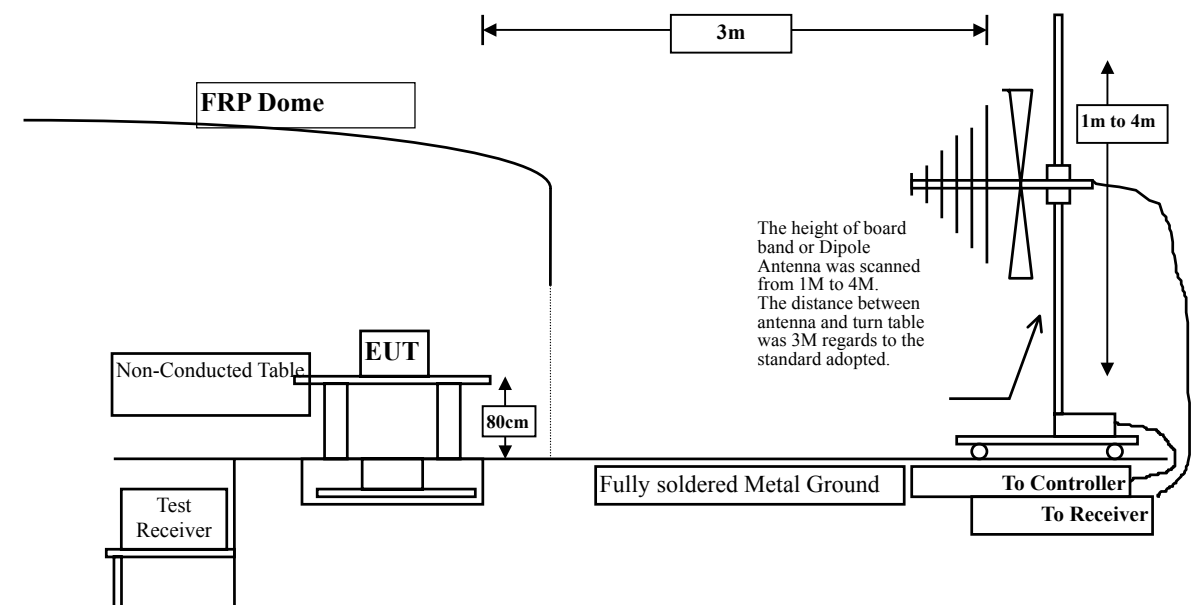

### 4.3. Limits

#### ➤ General Radiated Emission Limits

Emissions radiated outside of the specified frequency bands, except for harmonics, shall be attenuated by at least 20dB below the level of the fundamental or to the general radiated emission limits in paragraph 15.209, whichever is the lesser attenuation.

<b>FCC Part 15 Subpart C Paragraph 15.209(a) Limits</b>		
Frequency MHz	uV/m @3m	dBuV/m@3m
30-88	100	40
88-216	150	43.5
216-960	200	46
Above 960	500	54

- Remarks :
1. RF Voltage (dBuV) = 20 log RF Voltage (uV)
  2. In the Above Table, the tighter limit applies at the band edges.
  3. Distance refers to the distance in meters between the measuring instrument antenna and the closed point of any part of the device or system.



#### 4.4. Test Procedure

The EUT and its simulators are placed on a turn table which is 0.8 meter above ground. The turn table can rotate 360 degrees to determine the position of the maximum emission level. The EUT was positioned such that the distance from antenna to the EUT was 3 meters.

The antenna can move up and down between 1 meter and 4 meters to find out the maximum emission level.

Both horizontal and vertical polarization of the antenna are set on measurement. In order to find the maximum emission, all of the interface cables must be manipulated according to ANSI C63.4:1992 on radiated measurement.

The additional latch filter below 1GHz was used to measure the level of harmonics radiated emission during field strength of harmonics measurement.

The bandwidth below 1GHz setting on the field strength meter (R&S Test Receiver ESCS 30 )is 120 kHz, above 1GHz are 1 MHz.

The frequency range from 30MHz to 10th harmonics is checked.

**4.5. Test Result of Radiated Emission**

Product : Wireless 11g CardBus  
 Test Item : Harmonic Radiated Emission Data  
 Test Site : No.3OATS  
 Test Mode : Mode 1: Normal operation(Channel 1)

Frequency	Cable	Probe	PreAMP	Reading	Emission	Margin	Peak	Average
MHz	Loss	Factor		Level	Level		Limit	Limit
	dB	dB/m	dB	dBuV	dBuV/m	dB	dBuV/m	dBuV/m

**Horizontal**

**Peak Detector**

4824.500	4.23	33.64	19.89	33.34	51.33	22.67	74.00	54.00
7236.600	5.63	36.77	21.44	30.68	51.64	22.36	74.00	54.00
9647.400	7.00	38.24	19.69	26.18	51.73	22.27	74.00	54.00
12060.30	8.40	39.03	19.21	23.73	51.95	22.05	74.00	54.00
14471.30	9.77	40.51	21.77	23.54	52.05	21.95	74.00	54.00
16884.50	11.17	41.87	22.21	21.32	52.14	21.86	74.00	54.00
19295.00	11.80	37.96	20.18	22.68	52.27	21.73	74.00	54.00
21708.30	11.80	37.40	19.37	22.51	52.34	21.66	74.00	54.00
24119.30	11.80	39.23	19.37	20.79	52.45	21.55	74.00	54.00

**Average**

--

**Vertical**

**Peak Detector**

4823.300	4.23	33.64	19.89	32.02	50.01	23.99	74.00	54.00
7236.600	5.63	36.77	21.44	29.21	50.17	23.83	74.00	54.00
9647.400	7.00	38.24	19.69	25.70	51.25	22.75	74.00	54.00
12060.20	8.40	39.03	19.21	23.26	51.48	22.52	74.00	54.00
14472.80	9.77	40.51	21.77	23.05	51.56	22.44	74.00	54.00
16884.00	11.17	41.87	22.21	21.00	51.82	22.18	74.00	54.00
19295.90	11.80	37.96	20.18	22.37	51.96	22.04	74.00	54.00
21708.90	11.80	37.40	19.37	22.48	52.31	21.69	74.00	54.00
24120.00	11.80	39.23	19.37	21.01	52.67	21.33	74.00	54.00

**Average**

--

Note:

1. All Readings below 1GHz are Quasi-Peak, above are average value.
2. Receiver setting (Peak Detector) : RBW:1MHz; VBW:1MHz; Span:100MHz °
3. Receiver setting (AVG Detector) : RBW:1MHz; VBW:30Hz; Span:20MHz °
4. Emission Level = Reading Level + Probe Factor + Cable Loss- PreAMP.
5. The average measurement was not performed when the peak measured data under the limit of average detection. If the readings given are average, peak measurement should also be supplied.

Product : Wireless 11g CardBus  
 Test Item : Harmonic Radiated Emission Data  
 Test Site : No.3 OATS  
 Test Mode : Mode 1: Normal operation(Channel 6)

Frequency	Cable Loss	Probe Factor	PreAMP	Reading Level	Emission Level	Margin	Peak Limit	Average Limit
MHz	dB	dB/m	dB	dBuV	dBuV/m	dB	dBuV/m	dBuV/m

**Horizontal Peak Detector**

4874.200	4.26	33.77	19.87	30.97	49.14	24.86	74.00	54.00
7311.300	5.67	36.98	21.50	29.10	50.24	23.76	74.00	54.00
9747.900	7.06	38.34	19.48	24.67	50.59	23.41	74.00	54.00
12184.90	8.47	39.07	19.22	22.75	51.07	22.93	74.00	54.00
14621.70	9.87	40.02	21.89	23.41	51.41	22.59	74.00	54.00
17059.19	11.25	42.89	22.35	20.04	51.84	22.16	74.00	54.00
19496.90	11.80	37.97	19.37	21.72	52.12	21.88	74.00	54.00
21932.30	11.80	37.34	19.37	22.47	52.24	21.76	74.00	54.00
24370.60	11.80	39.37	19.37	20.87	52.67	21.33	74.00	54.00

**Average**

--

**Vertical Peak Detector**

4874.600	4.26	33.77	19.87	32.04	50.21	23.79	74.00	54.00
7311.600	5.67	36.98	21.50	29.20	50.34	23.66	74.00	54.00
9748.800	7.07	38.35	19.43	25.14	51.14	22.86	74.00	54.00
12185.80	8.47	39.07	19.22	22.91	51.23	22.77	74.00	54.00
14621.00	9.87	40.02	21.89	23.35	51.35	22.65	74.00	54.00
17059.50	11.25	42.89	22.35	20.34	52.14	21.86	74.00	54.00
19495.40	11.80	37.97	19.37	21.89	52.29	21.71	74.00	54.00
21933.60	11.80	37.34	19.37	22.87	52.64	21.36	74.00	54.00
24369.74	11.80	39.37	19.37	20.99	52.79	21.21	74.00	54.00

**Average**

--

Note:

1. All Readings below 1GHz are Quasi-Peak, above are average value.
2. Receiver setting (Peak Detector) : RBW:1MHz; VBW:1MHz; Span:100MHz °
3. Receiver setting (AVG Detector) : RBW:1MHz; VBW:30Hz; Span:20MHz °
4. Emission Level = Reading Level + Probe Factor + Cable Loss- PreAMP.
5. The average measurement was not performed when the peak measured data under the limit of average detection. If the readings given are average, peak measurement should also be supplied.

Product : Wireless 11g CardBus  
 Test Item : Harmonic Radiated Emission Data  
 Test Site : No.3 OATS  
 Test Mode : Mode 1: Normal operation(Channel 11)

Frequency	Cable Loss	Probe Factor	PreAMP	Reading Level	Emission Level	Margin	Peak Limit	Average Limit
MHz	dB	dB/m	dB	dBuV	dBuV/m	dB	dBuV/m	dBuV/m

**Horizontal Peak Detector**

4923.900	4.29	33.82	19.85	31.88	50.14	23.86	74.00	54.00
7387.100	5.72	37.14	21.56	29.17	50.47	23.53	74.00	54.00
9847.300	7.13	38.47	19.22	24.52	50.91	23.09	74.00	54.00
12310.60	8.53	39.12	19.23	22.81	51.24	22.76	74.00	54.00
14771.40	9.95	39.53	21.96	24.09	51.61	22.39	74.00	54.00
17234.50	11.35	43.99	22.19	18.70	51.85	22.15	74.00	54.00
19695.30	11.80	37.97	19.37	21.66	52.06	21.94	74.00	54.00
22158.50	11.80	37.40	19.37	22.62	52.45	21.55	74.00	54.00
24620.80	11.80	39.50	19.37	20.88	52.81	21.19	74.00	54.00

**Average**

--

**Vertical Peak Detector**

4923.100	4.29	33.82	19.85	31.88	50.14	23.86	74.00	54.00
7386.600	5.72	37.14	21.56	28.94	50.24	23.76	74.00	54.00
9847.400	7.13	38.47	19.22	23.97	50.36	23.64	74.00	54.00
12309.70	8.53	39.12	19.23	21.76	50.19	23.81	74.00	54.00
14772.50	9.95	39.53	21.96	23.17	50.69	23.31	74.00	54.00
17232.40	11.35	43.99	22.19	18.22	51.37	22.63	74.00	54.00
19696.30	11.80	37.97	19.37	20.85	51.25	22.75	74.00	54.00
22156.80	11.80	37.40	19.37	21.51	51.34	22.66	74.00	54.00
24620.19	11.80	39.50	19.37	20.26	52.19	21.81	74.00	54.00

**Average**

--

**Note:**

1. All Readings below 1GHz are Quasi-Peak, above are average value.
2. Receiver setting (Peak Detector) : RBW:1MHz; VBW:1MHz; Span:100MHz ◦
3. Receiver setting (AVG Detector) : RBW:1MHz; VBW:30Hz; Span:20MHz ◦
4. Emission Level = Reading Level + Probe Factor + Cable Loss- PreAMP.
5. The average measurement was not performed when the peak measured data under the limit of average detection. If the readings given are average, peak measurement should also be supplied.

Product : Wireless 11g CardBus  
 Test Item : General Radiated Emission Data  
 Test Site : No.3 OATS  
 Test Mode : Mode 1: Normal operation (Channel 1)

Freq.	Cable Loss	Probe Factor	PreAMP	Reading Level	Measurement Vertical	Margin	Limit
MHz	dB	dB/m	dB	dBuV	dBuV/m	dB	dBuV/m
<b>Horizontal:</b>							
201.360	1.75	8.54	0.00	20.33	30.62	12.88	43.50
456.850	3.07	16.48	0.00	13.65	33.21	12.79	46.00
* 582.910	3.72	18.17	0.00	12.81	34.70	11.30	46.00
601.350	3.81	17.75	0.00	11.12	32.68	13.32	46.00
626.500	3.95	18.51	0.00	10.04	32.50	13.50	46.00
683.860	4.24	18.58	0.00	10.43	33.26	12.74	46.00
<b>Vertical:</b>							
412.250	2.84	17.59	0.00	11.86	32.29	13.71	46.00
601.550	3.81	19.64	0.00	7.67	31.13	14.87	46.00
622.640	3.92	19.08	0.00	7.20	30.20	15.80	46.00
702.310	4.33	18.32	0.00	8.16	30.81	15.19	46.00
* 846.780	5.08	18.89	0.00	11.14	35.12	10.88	46.00
977.720	5.76	19.94	0.00	5.55	31.25	22.75	54.00

Note:

1. All Readings below 1GHz are Quasi-Peak, above are average value.
2. “ \* ”, means this data is the worst emission level.
3. Emission Level = Reading Level + Probe Factor + Cable Loss.

Product : Wireless 11g CardBus  
 Test Item : General Radiated Emission Data  
 Test Site : No.3 OATS  
 Test Mode : Mode 1: Normal operation (Channel 6)

Freq.	Cable Loss	Probe Factor	PreAMP	Reading Level	Measurement Vertical	Margin	Limit
MHz	dB	dB/m	dB	dBuV	dBuV/m	dB	dBuV/m
<b>Horizontal:</b>							
* 195.170	1.72	8.05	0.00	22.77	32.54	10.96	43.50
455.800	3.06	16.66	0.00	11.97	31.70	14.30	46.00
589.700	3.75	17.83	0.00	10.35	31.93	14.07	46.00
630.130	3.96	18.63	0.00	9.57	32.15	13.85	46.00
650.600	4.06	18.64	0.00	7.40	30.10	15.90	46.00
911.630	5.42	19.55	0.00	5.12	30.09	15.91	46.00
<b>Vertical:</b>							
* 465.250	3.11	16.42	0.00	14.66	34.20	11.80	46.00
618.820	3.90	19.27	0.00	11.03	34.20	11.80	46.00
630.600	3.97	18.65	0.00	7.71	30.33	15.67	46.00
806.340	4.87	19.19	0.00	8.90	32.96	13.04	46.00
846.840	5.08	18.89	0.00	7.17	31.15	14.85	46.00
912.230	5.42	21.25	0.00	4.61	31.28	14.72	46.00

Note:

1. All Readings below 1GHz are Quasi-Peak, above are average value.
2. “ \* ”, means this data is the worst emission level.
3. Emission Level = Reading Level + Probe Factor + Cable Loss.

Product : Wireless 11g CardBus  
 Test Item : General Radiated Emission Data  
 Test Site : No.3 OATS  
 Test Mode : Mode 1: Normal operation (Channel 11)

Freq.	Cable Loss	Probe Factor	PreAMP	Reading Level	Measurement Vertical	Margin	Limit
MHz	dB	dB/m	dB	dBuV	dBuV/m	dB	dBuV/m
<b>Horizontal:</b>							
342.600	2.48	12.97	0.00	16.79	32.25	13.75	46.00
521.230	3.40	16.52	0.00	14.69	34.60	11.40	46.00
596.140	3.78	17.81	0.00	12.37	33.97	12.03	46.00
618.800	3.90	18.77	0.00	7.58	30.25	15.75	46.00
* 782.690	4.75	18.96	0.00	12.63	36.34	9.66	46.00
973.220	5.72	20.49	0.00	5.57	31.78	22.22	54.00
<b>Vertical:</b>							
264.210	2.07	13.04	0.00	18.05	33.16	12.84	46.00
597.310	3.79	19.42	0.00	9.32	32.54	13.46	46.00
630.230	3.96	18.53	0.00	7.46	29.95	16.05	46.00
712.310	4.38	18.98	0.00	9.05	32.41	13.59	46.00
* 857.140	5.13	19.15	0.00	9.37	33.65	12.35	46.00
965.230	5.69	20.15	0.00	5.41	31.25	22.75	54.00

Note:

1. All Readings below 1GHz are Quasi-Peak, above are average value.
2. “ \* ”, means this data is the worst emission level.
3. Emission Level = Reading Level + Probe Factor + Cable Loss.

## 5. Band Edge

### 5.1. Test Equipment

The following test equipments are used during the band edge tests:

Equipment	Manufacturer	Model No./Serial No.	Last Cal.
X Spectrum Analyzer	Advantest	R3272 / 72421194	May, 2003
X Test Receiver	R & S	ESCS 30 / 825442/14	May, 2003
X Spectrum Analyzer	Advantest	R3261C / 71720140	May, 2003
X Pre-Amplifier	HP	8447D/3307A01812	May, 2003
X Bilog Antenna	Chase	CBL6112B / 12452	Sep., 2002
X Horn Antenna	EM	EM6917 / 103325	May, 2003

- Note: 1. All equipments that need to calibrate are with calibration period of 1 year.  
 2. Mark "X" test instruments are used to measure the final test results.

### 5.2. Test Setup

#### RF Conducted Measurement:

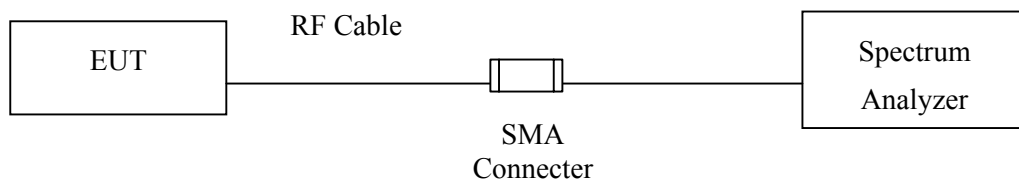

#### RF Radiated Measurement:

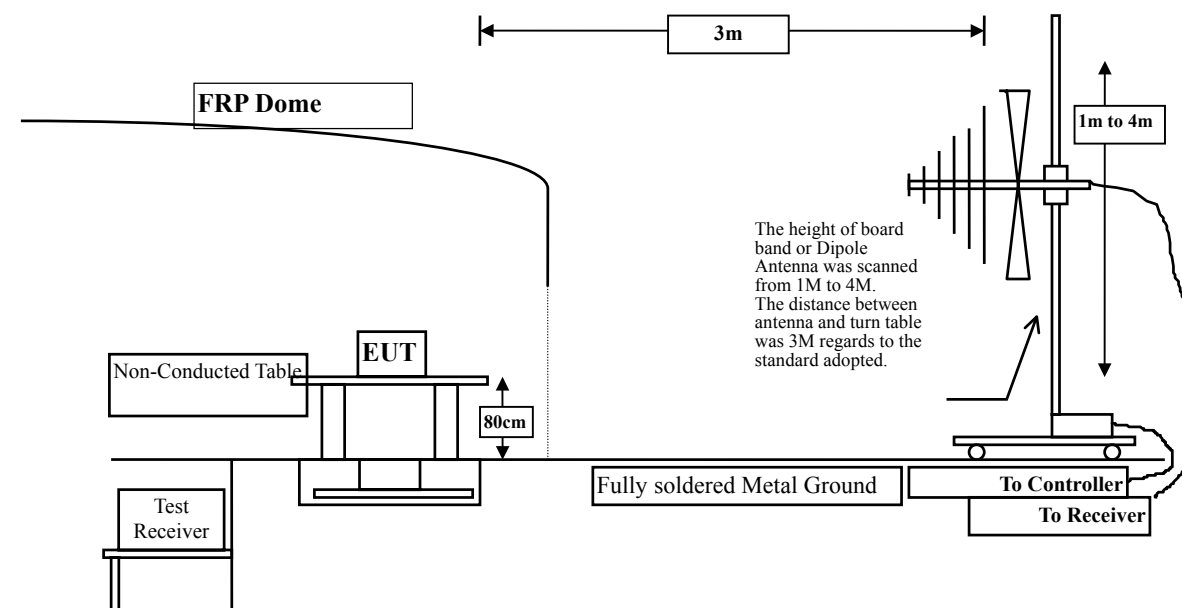



### 5.3. Limits

In any 100 kHz bandwidth outside the frequency band in which the spread spectrum intentional radiator is operating, the radio frequency power that is produced by the intentional radiator shall be at least 20 dB below that in the 100 kHz bandwidth within the band that contains the highest level of the desired power, based on either an RF conducted or a radiated measurement. Attenuation below the general limits specified in Section 15.209(a) is not required. In addition, radiated emissions which fall in the restricted bands, as defined in Section 15.205(a), must also comply with the radiated emission limits specified in Section 15.209(a) (see Section 15.205(c)).

### 5.4. Test Procedure

The EUT and its simulators are placed on a turn table which is 0.8 meter above ground. The turn table can rotate 360 degrees to determine the position of the maximum emission level. The EUT was positioned such that the distance from antenna to the EUT was 3 meters.

The antenna can move up and down between 1 meter and 4 meters to find out the maximum emission level.

Both horizontal and vertical polarization of the antenna are set on measurement. In order to find the maximum emission, all of the interface cables must be manipulated according to ANSI C63.4:1992 on radiated measurement.

The bandwidth below 1GHz setting on the field strength meter (R&S Test Receiver ESCS 30 )is 120 kHz, above 1GHz are 1 MHz.

### 5.5. Test Result of Band Edge

Product : Wireless 11g CardBus  
 Test Item : Band Edge Data  
 Test Site : No.3 OATS  
 Test Mode : Mode1: Normal Operation (54Mbps)

**RF Radiated Measurement:**

Channel No.	Frequency (MHz)	Required Limit (dBc)	Result
1 (Horizontal)	<2400	>20	Pass
1 (Vertical)	<2400	>20	Pass

**Figure Channel 1:** (Horizontal)

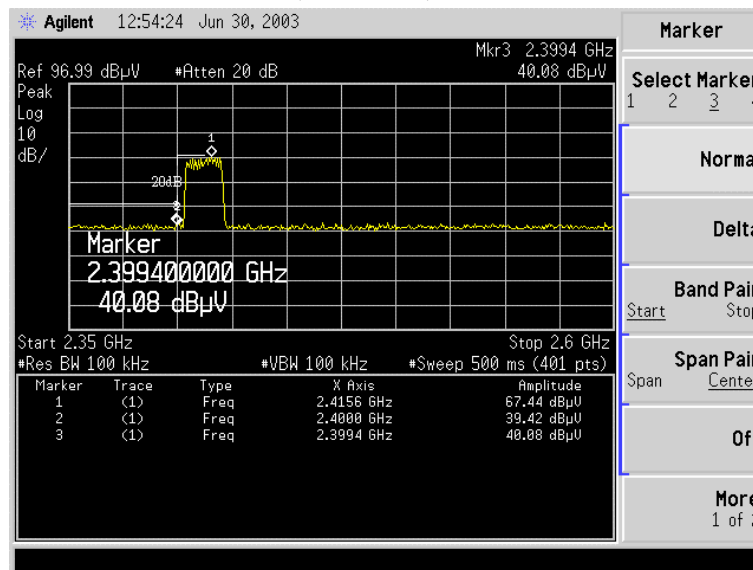

**Figure Channel 1:** (Vertical)

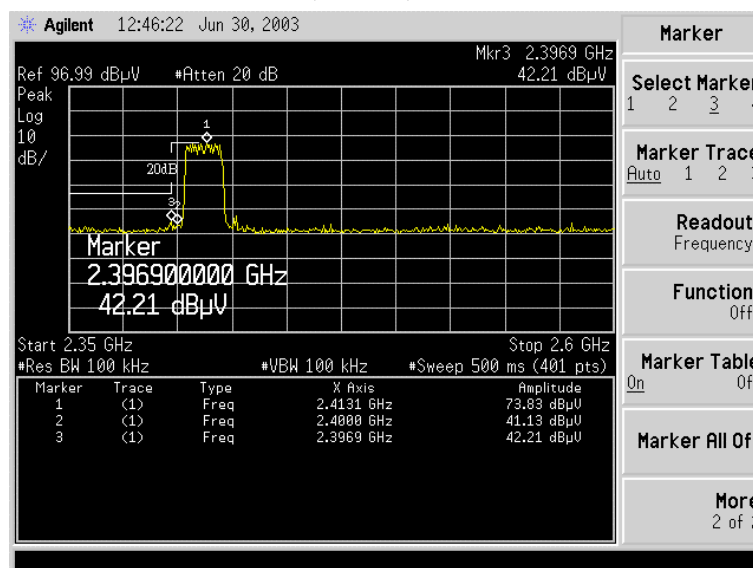

Product : Wireless 11g CardBus  
 Test Item : Band Edge Data  
 Test Site : No.3 OATS  
 Test Mode : Mode 1: Normal operation (54Mbps)

**Figure Channel 11:**

**RF Radiated Measurement (Horizontal):**

Channel No.	Frequency (MHz)	Reading Level (dBuV)	Emission Level (dBuV/m)	Peak Limit (dBuV/m)	Average Limit (dBuV/m)	Result
11(Peak)	2489.4	56.02	67.82	74.00	54.00	Pass
11(Average)	2489.4	31.68	43.48	74.00	54.00	Pass

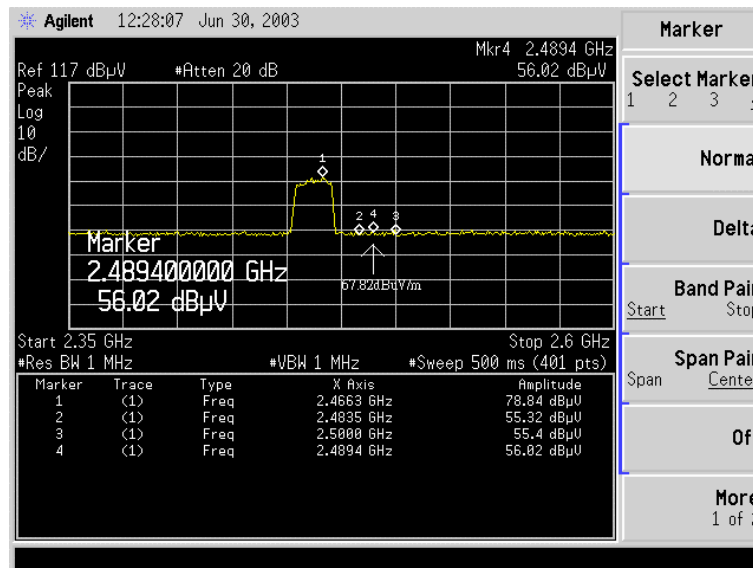

**RF Radiated Measurement (Vertical):**

Channel No.	Frequency (MHz)	Reading Level (dBuV)	Emission Level (dBuV/m)	Peak Limit (dBuV/m)	Average Limit (dBuV/m)	Result
11(Peak)	2488.8	55.77	67.57	74.00	54.00	Pass
11(Average)	2488.8	31.94	43.74	74.00	54.00	Pass

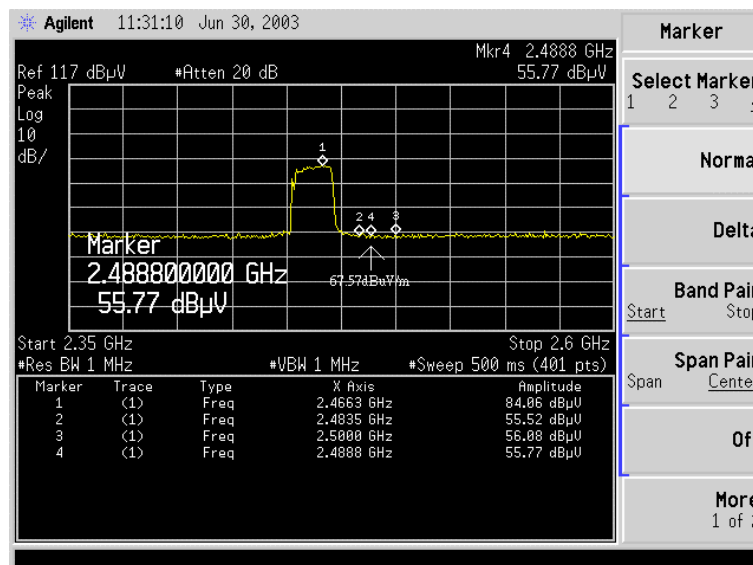

## 6. Occupied Bandwidth

### 6.1. Test Equipment

The following test equipments are used during the radiated emission tests:

	Equipment	Manufacturer	Model No./Serial No.	Last Cal.
X	Spectrum Analyzer	Advantest	R3272 / 72421194	May, 2003

Note: 1. All equipment upon which need to calibrated are with calibration period of 1 year.  
 2. Mark "X" test instruments are used to measure the final test results.

### 6.2. Test Setup

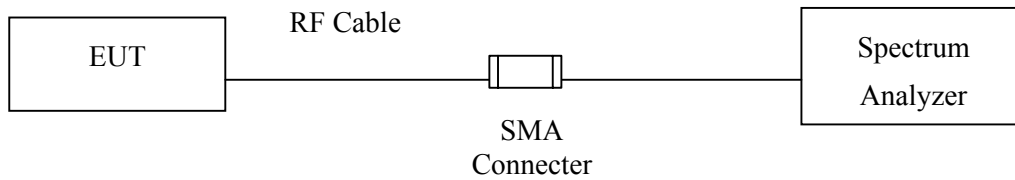

### 6.3. Limits

The minimum bandwidth shall be at least 500kHz.

### 6.4. Test Result of Occupied Bandwidth

Product : Wireless 11g CardBus  
 Test Item : Occupied Bandwidth Data  
 Test Site : No.3 OATS  
 Test Mode : Channel 1

Channel No.	Frequency (MHz)	Measurement Level (kHz)	Required Limit (kHz)	Result
1 (54Mbps)	2410.4	16600	>500	Pass

Figure Channel 1: 54Mbps

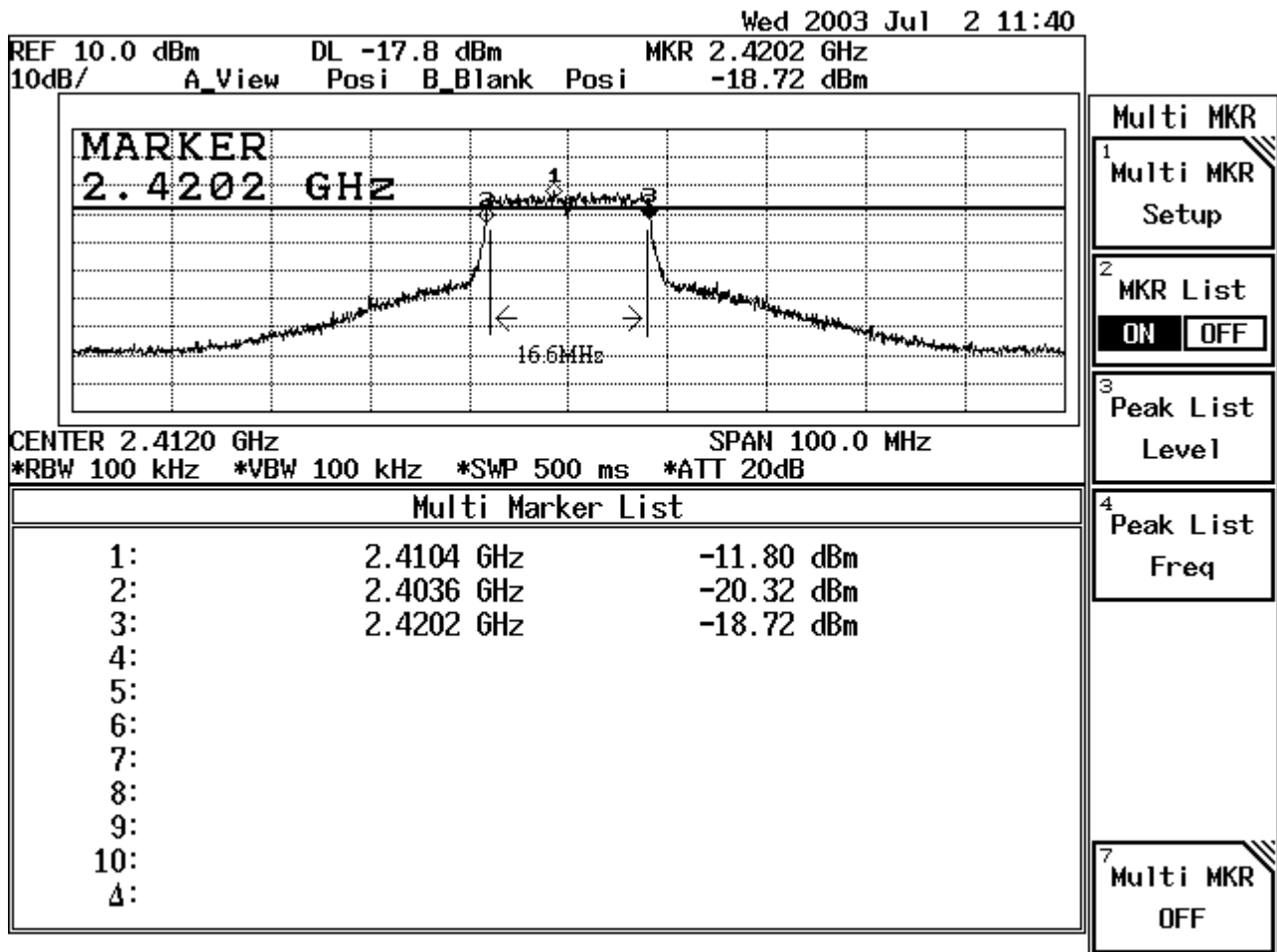

Product : Wireless 11g CardBus  
 Test Item : Occupied Bandwidth Data  
 Test Site : No.3 OATS  
 Test Mode : Channel 6

Channel No.	Frequency (MHz)	Measurement Level (kHz)	Required Limit (kHz)	Result
6 (54Mbps)	2439.4	16600	>500	Pass

Figure Channel 6: 54Mbps

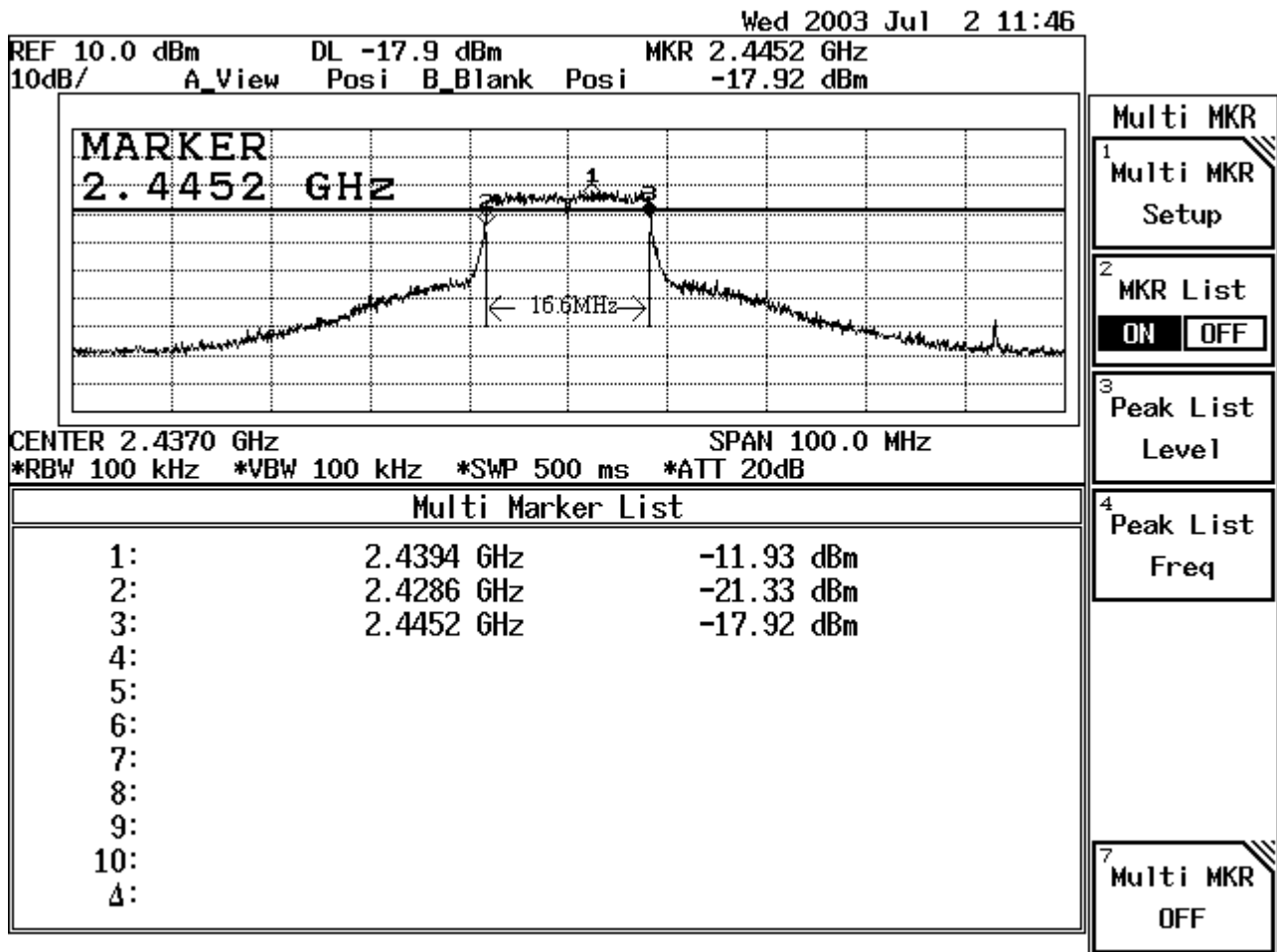

Product : Wireless 11g CardBus  
 Test Item : Occupied Bandwidth Data  
 Test Site : No.3 OATS  
 Test Mode : Channel 11

Channel No.	Frequency (MHz)	Measurement Level (kHz)	Required Limit (kHz)	Result
11 (54Mbps)	2464.4	16700	>500	Pass

Figure Channel 11: 54Mbps

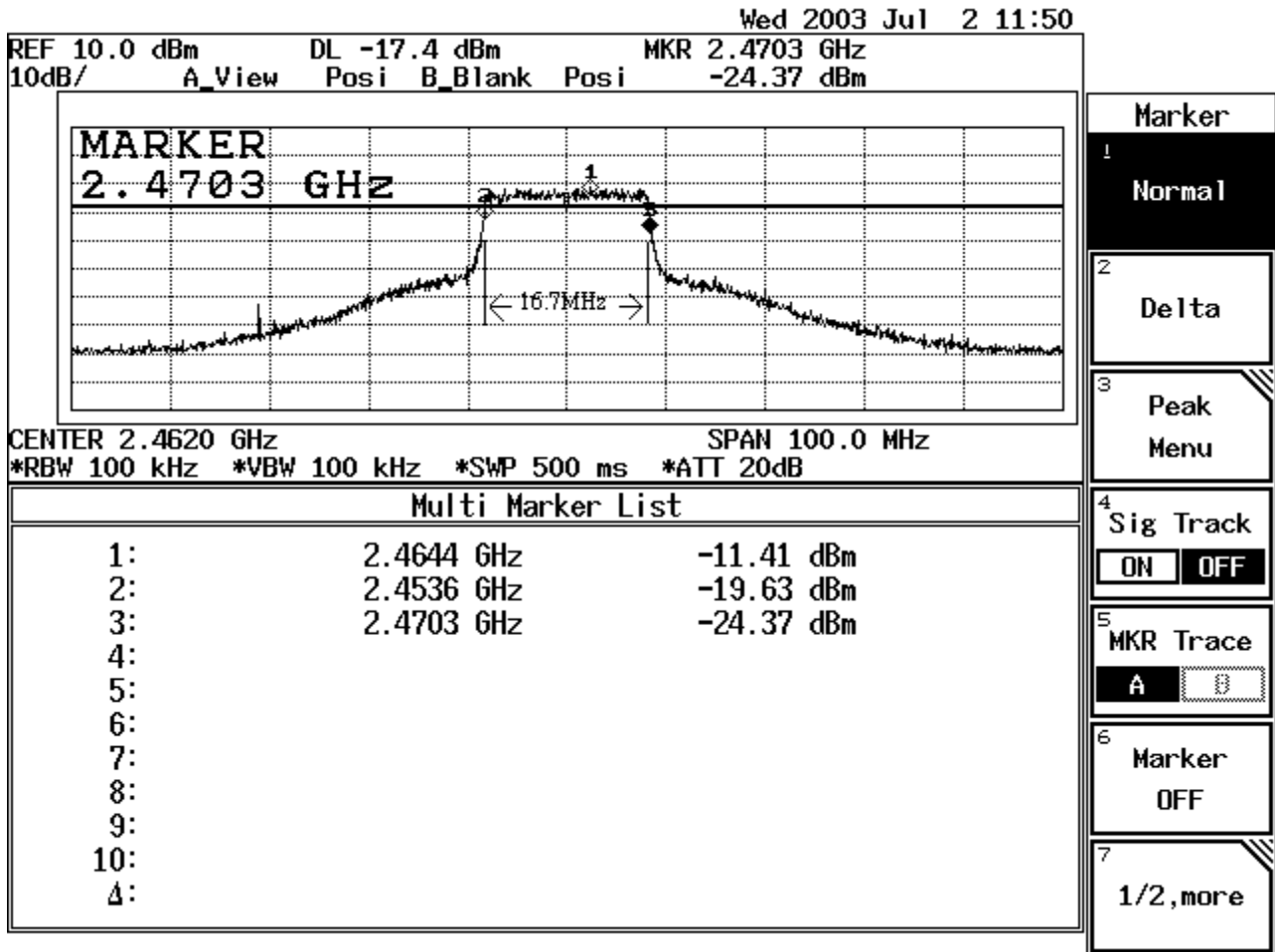

**7. Power Density**

**7.1. Test Equipment**

The following test equipments are used during the radiated emission tests:

	Equipment	Manufacturer	Model No./Serial No.	Last Cal.
X	Spectrum Analyzer	Advantest	R3272 / 72421194	May, 2003

Note: 1. All equipment upon which need to calibrated are with calibration period of 1 year.  
 2. Mark "X" test instruments are used to measure the final test results.

**7.2. Test Setup**

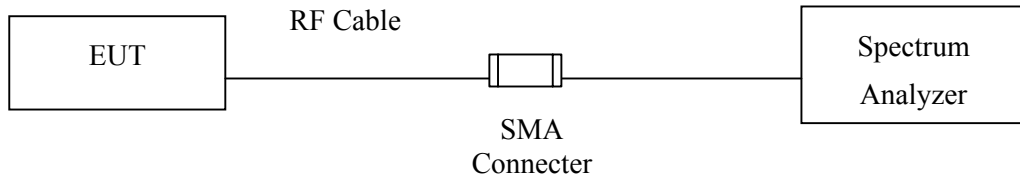

**7.3. Limits**

The transmitted power density averaged over any 1 second interval shall not be greater +8dBm in any 3kHz bandwidth.



### 7.4. Test Result of Power Density

Product : Wireless 11g CardBus  
 Test Item : Power Density Data  
 Test Site : No.3 OATS  
 Test Mode : Channel 1

Channel No.	Frequency (MHz)	Measure Level (dBm)	Limit (dBm)	Result
1 (54Mbps)	2413.215	-27.66	< 8dBm	Pass

Figure Channel 1: 54Mbps

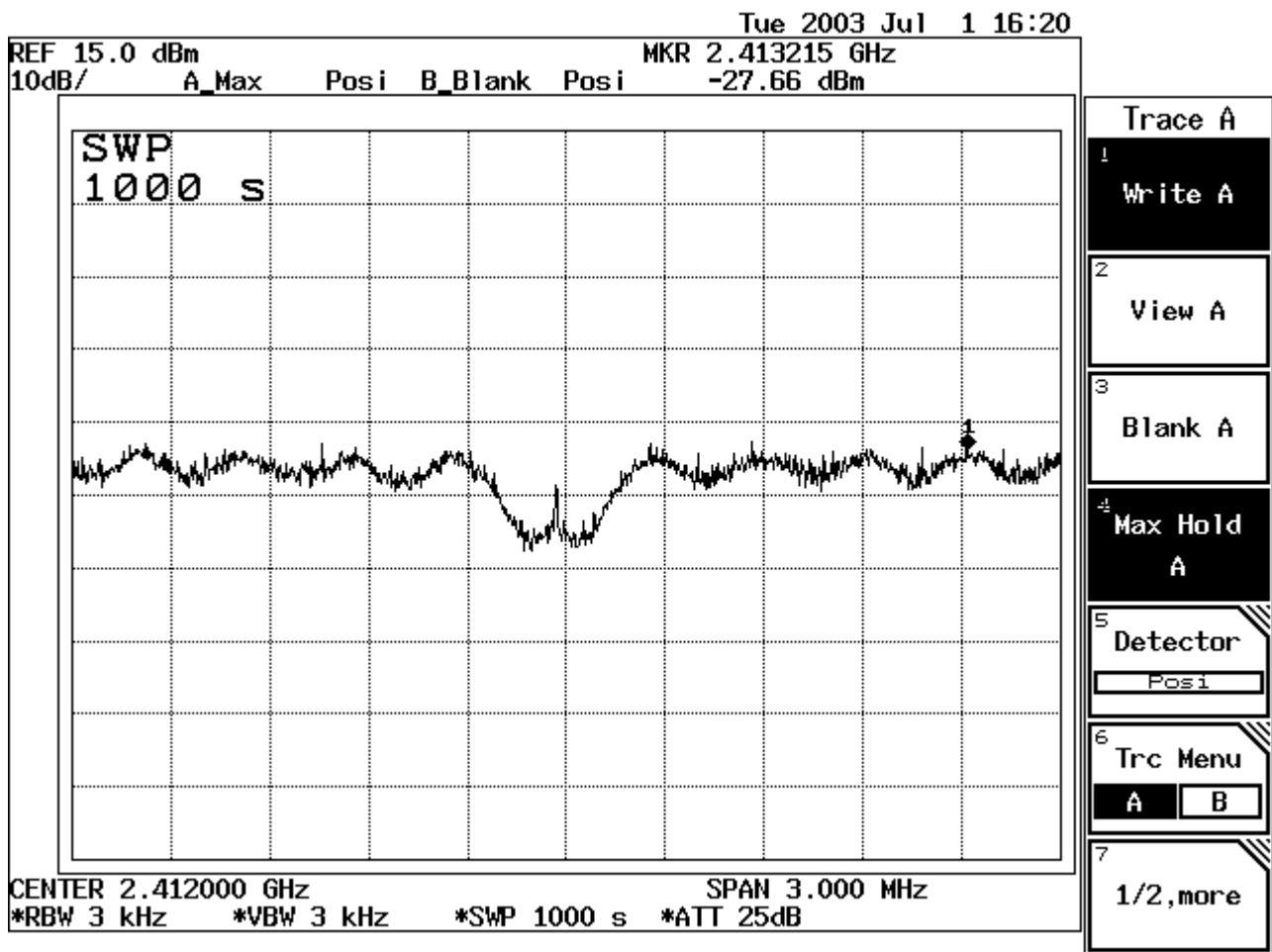

Product : Wireless 11g CardBus  
 Test Item : Power Density Data  
 Test Site : No.3OATS  
 Test Mode : Channel 6

Channel No.	Frequency (MHz)	Measurement Level (dBm)	Required Limit (dBm)	Result
6 (54Mbps)	2435.959	-26.24	< 8dBm	Pass

Figure Channel 6: 54Mbps

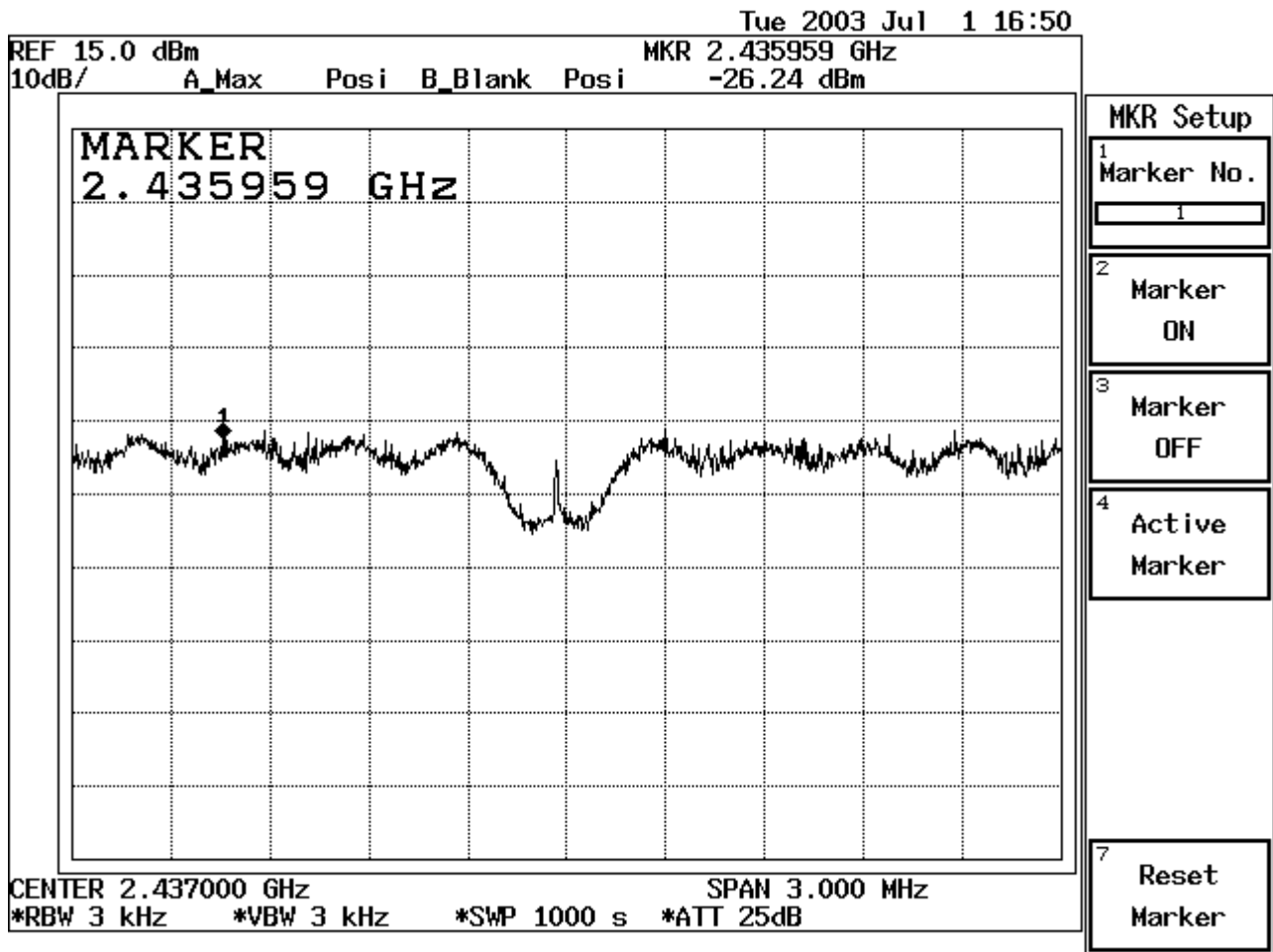

Product : Wireless 11g CardBus  
 Test Item : Density Data  
 Test Site : No.3 OATS  
 Test Mode : Channel 11

Channel No.	Frequency (MHz)	Measurement Level (dBm)	Required Limit (dBm)	Result
11 (54Mbps)	2462.969	-24.38	< 8dBm	Pass

Figure Channel 11: 54Mbps

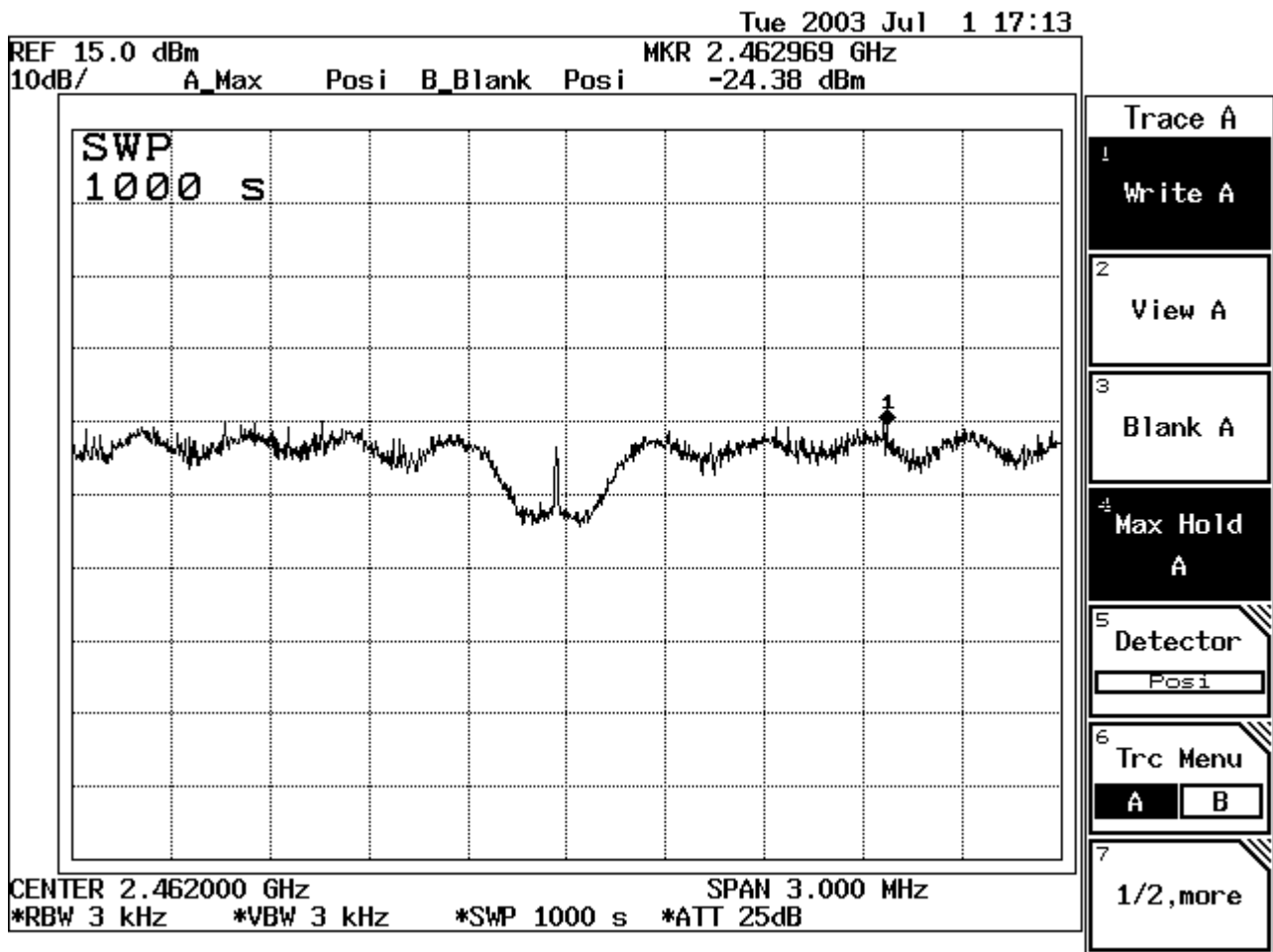

## 8. EMI Reduction Method During Compliance Testing

No modification was made during testing.

## Attachment 1: EUT Test Photographs

**Attachment 1: EUT Test Setup Photographs**

Front View of Conducted Test



Back View of Conducted Test



Front View of Radiated Test



Back View of Radiated Test



Front View of Radiated Test (Horn)





## Attachment 2: EUT Detailed Photographs

**Attachment 2 : EUT Detailed Photographs**

(1) EUT Photo



(2) EUT Photo



(3) EUT Photo



(4) EUT Photo

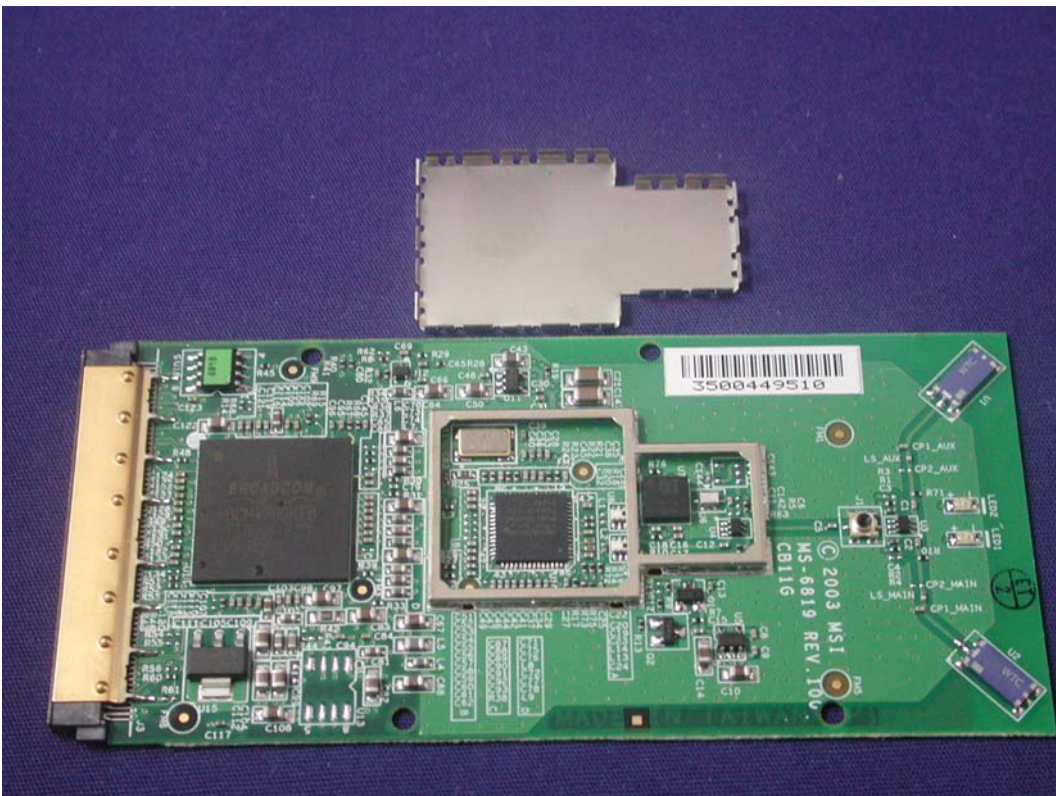



(5) EUT Photo

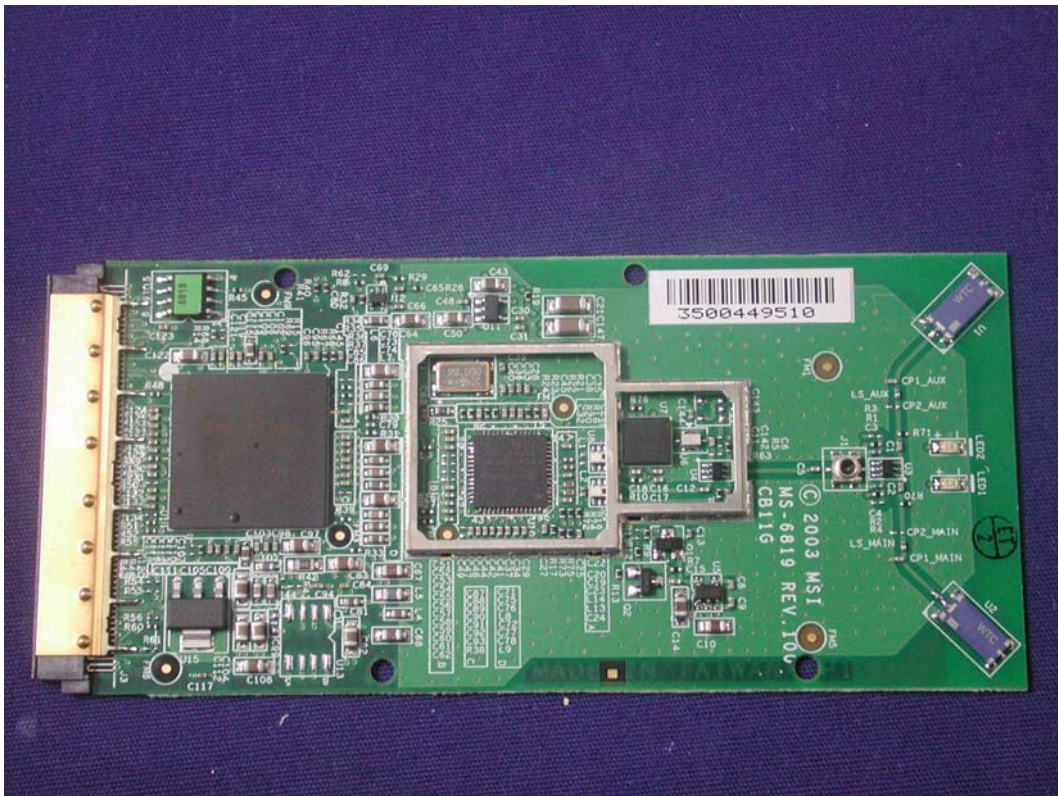

(6) EUT Photo

