



## Test Report

Product Name : Notebook  
Model No : MS-1351, X320  
FCC ID : I4L-13-EM7306896

Applicant : MICRO-STAR INT'L Co., LTD.  
Address : No. 69, Li-De St., Jung-He City, Taipei  
Hsien, Taiwan, R.O.C.

Date of Receipt : 2009/03/24  
Issued Date : 2009/05/06  
Report No. : 093353R-HPUSP07V01-A  
Report Version : V1.0

The test results relate only to the samples tested.  
The test report shall not be reproduced except in full without the written approval of Quietek Corporation.  
This report must not be used to claim product endorsement by NVLAP any agency of the U.S. Government

# Test Report Certification

Issued Date : 2009/05/06

Report No.: 093353R-HPUSP07V01-A



Accredited by NIST (NVLAP)  
NVLAP Lab Code: 200533-0

Product Name : Notebook

Applicant : MICRO-STAR INT'L Co., LTD.

Address : No. 69, Li-De St., Jung-He City, Taipei Hsien, Taiwan, R.O.C.

Manufacturer : MICRO-STAR INT'L Co., LTD.

Trade Name : MSI

Model No. : MS-1351, X320

Rated Voltage : AC 120V/60Hz

EUT Voltage : AC 120V/60Hz

Measurement Standard : FCC CFR Title 47 Part 2 22 24

Measurement Reference : TIA/EIA 603-C

Test Result : Complied

Test results relate only to the samples tested.

The test report shall not be reproduced except in full without the written approval of Quietek Corporation.

This report must not be used to claim product endorsement by NVLAP any agency of the U.S. Government

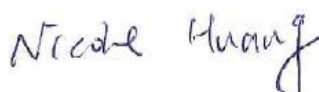
Documented By :   
 \_\_\_\_\_  
 (Engineering Adm. Assistant /  
 Nicole Huang)

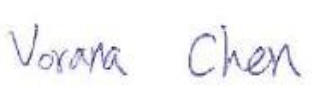
Tested By :   
 \_\_\_\_\_  
 (Engineer / Vorana Chen)

Approved By :   
 \_\_\_\_\_  
 (Manager / Vincent Lin)

## TABLE OF CONTENTS

Description	Page
1. GENERAL INFORMATION .....	4
1.1. EUT Description .....	4
1.2. Antenna List.....	5
1.3. Operational Description.....	5
1.4. Configuration of tested System .....	6
1.5. EUT Setup Procedures .....	6
1.6. Test Facility .....	7
1.7. Type of Emission .....	8
1.8. Applied DC Voltages and Currents .....	8
2. Peak Power Output .....	9
2.1. Test Equipment.....	9
2.2. Test Setup .....	9
2.3. Limits .....	10
2.4. Test Procedure .....	10
2.5. Test Specification .....	10
2.6. Test Result of Peak Power Output .....	11
3. Occupied Bandwidth .....	23
3.1. Test Equipment.....	23
3.2. Test Setup .....	23
3.3. Test Procedure .....	23
3.4. Test Specification .....	24
3.5. Test Result of Occupied Bandwidth .....	25
4. Spurious Emission At Antenna Terminals (+/-1MHz).....	41
4.1. Test Equipment.....	41
4.2. Setup .....	41
4.3. Limits .....	42
4.4. Test Procedure .....	42
4.5. Test Specification .....	42
4.6. Test Result of Spurious Emission At Antenna Terminals (+/-1MHz).....	43
5. Spurious Emission .....	51
5.1. Test Equipment.....	51
5.2. Test Setup .....	52
5.3. Limits .....	52
5.4. Test Procedure .....	53
5.5. Test Specification .....	53
5.6. Test Result of Spurious Emission .....	54
6. Frequency Stability Under Temperature & Voltage Variations .....	86
6.1. Test Equipment .....	86
6.2. Test Setup .....	86
6.3. Limits.....	86
6.4. Test Procedure .....	87
6.5. Test Specification .....	87
6.6. Test Result of Frequency Stability Under Temperature Variations .....	88
7. EMI Reduction Method During Compliance Testing .....	96
 Attachment 1: EUT Test Photographs	
Attachment 2: EUT Detailed Photographs	

## 1. GENERAL INFORMATION

### 1.1. EUT Description

Product Name	Notebook
Model No.	MS-1351, X320
Trade Name	MSI
FCC ID.	I4L-13-EM7306896
Antenna Type	PIFA
TX Frequency	824MHz~849MHz(GSM 850/WCDMA Band V) 1850MHz ~ 1910MHz(PCS 1900/WCDMA Band II)
Rx Frequency	869MHz~894MHz(GSM 850/WCDMA Band V) 1930MHz ~ 1990MHz(PCS 1900/WCDMA Band II)
Function	GPRS/EGPRS/WCDMA/HSDPA

Component	
Power Adapter	MFR: DELTA, M/N: ADP-40MH BD AC Input: 100V-240V / 50-60Hz, 1.2A DC Output: 20V, 2.0A Cable Out: Non-Shielded 1.9m, 1 ferrite core bonded Cable In: Non-Shielded 1.8m

## 1.2. Antenna List

No.	Antenna Type	Part No.	Peak Gain
1	PIFA	S79-1800J00-J51	3.20 dBi
2	PIFA	S79-1800G10-J36	1.76 dBi

Note: 1. Regarding to the operation frequency, the lowest, middle and highest frequency are selected to perform the test.

2. Only the higher gain antenna Ant 1 was tested and recorded in this report.

## 1.3. Operational Description

The information contained within this report is intended to show verification of compliance of the 850/1900MHz Notebook to the requirements of 47CFR2, 22 and 24.

The EUT provide all functions described as above. The EUT is tested with maximum rated TX power via the Base Station simulator.

Quietek has verified the construction and function in typical operation. All the test modes were carried out with the EUT in normal operation, which was shown in this test report and defined as:

Test Mode	GSM 850 GPRS
	GSM 850 EGPRS
	PCS 1900 GPRS
	PCS 1900 EGPRS
	WCDMA BAND V
	WCDMA BAND V HSDPA
	WCDMA BAND II
	WCDMA BAND II HSDPA

### 1.4. Configuration of tested System

(a) Configuration of Radiated measurement

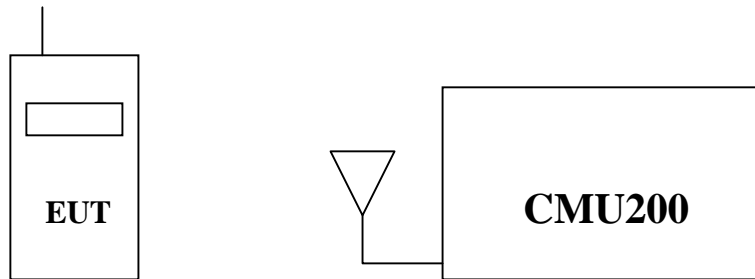

(b) Configuration of Conducted measurement

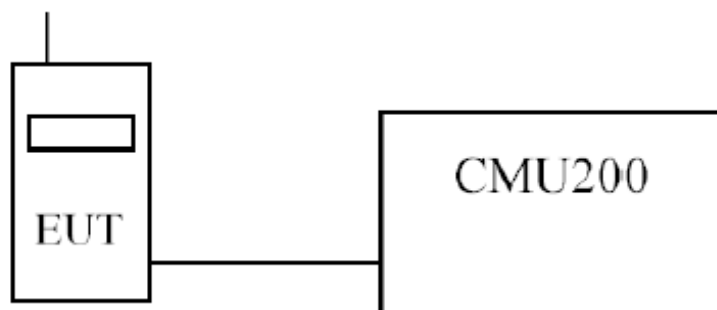

### 1.5. EUT Setup Procedures

- (1) Setup the EUT and simulators as shown on 1.3
- (2) Turn on the power of all equipments.
- (3) The EUT was set to communicate with CMU200.
- (4) Repeat the above procedure (3).

**1.6. Test Facility**

Ambient conditions in the laboratory:

Items	Required (IEC 68-1)	Actual
Temperature (°C)	15-35	23
Humidity (%RH)	25-75	52
Barometric pressure (mbar)	860-1060	982

Site Description: File on  
 Federal Communications Commission  
 FCC Engineering Laboratory  
 7435 Oakland Mills Road  
 Columbia, MD 21046  
 FCC Registration Number :92195



July 03, 2001 Accreditation on NVLAP  
 NVLAP Lab Code: 200533-0



Site Name: Quietek Corporation

Linkou Testing Laboratory:  
 No. 5, Ruei-Shu Valley, Ruei-Ping Tsuen,  
 Lin-Kou Shiang, Taipei,  
 Taiwan, R.O.C.  
 TEL : 886-2-8601-3788 / FAX : 886-2-8601-3789  
 E-Mail : [service@quietek.com](mailto:service@quietek.com)

FCC Accreditation Number: TW1014



## 1.7. Type of Emission

GSM/GPRS/EGPRS: 300KG7W  
WCDMA/HSDPA: 4M20F9W

## 1.8. Applied DC Voltages and Currents

According to FCC 2.1033 (c) (8).

The voltages and currents in the final RF stage is:

Voltage	2.85V
Current	150mA according to FCC 2.1033 (c) (8)



## 2. Peak Power Output

### 2.1. Test Equipment

The following test equipments are used during the radiated emission test:

Test Site	Equipment	Manufacturer	Model No./Serial No.	Last Cal.
☒OATS 3	Test Receiver	R & S	ESCS 30 / 100122	Feb., 2009
	Universal Radio Communication Tester	R & S	CMU200 / 104846	Apr., 2009
	Spectrum Analyzer	Agilent	N9020A/ MY48010570	Apr., 2009
	Pre-Amplifier	QTK	QTK-AMP-03 / 0003	N/A
	Bilog Antenna	SCHAFFNER	CBL6112B / 2697	May., 2009
	Horn Antenna	ETS	3115 / 0005-6160	Jul., 2008
	Pre-Amplifier	QTK	QTK-AMP-01 / 0001	Jul., 2008

Note: All equipments that need to be calibrated are with calibration period of 1 year.

### 2.2. Test Setup

#### Radiated Power Measurement

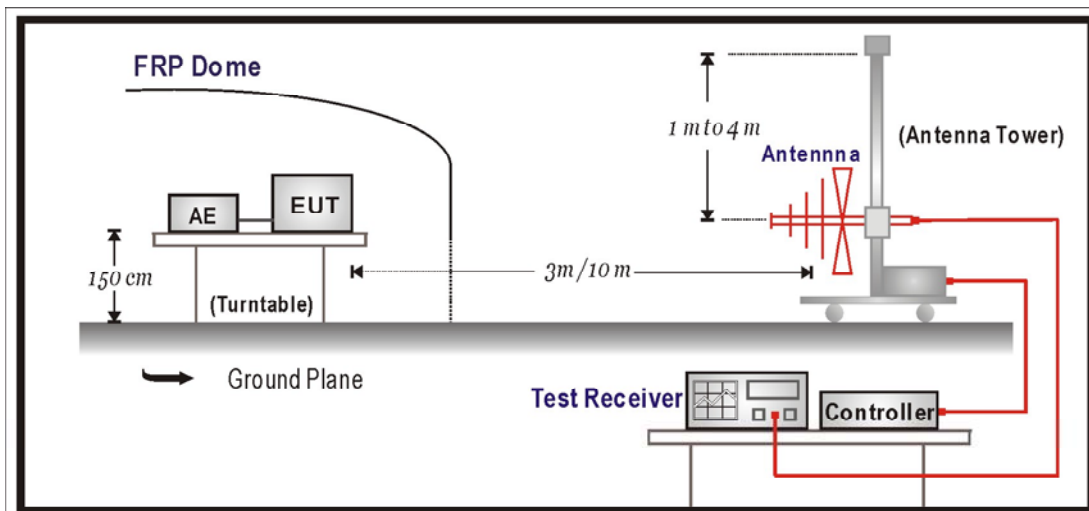

### Conducted Power Measurement

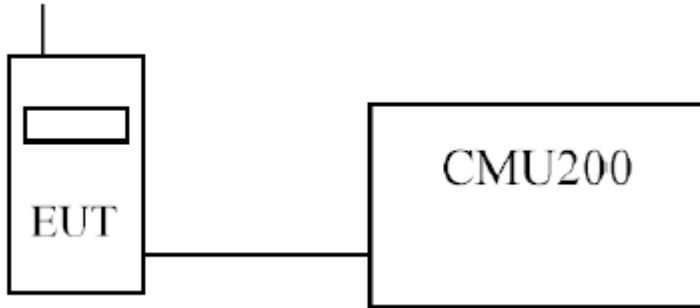

### 2.3. Limits

Cellular Band 850	<7W
PCS Band 1900	<2W or +33dBm

### 2.4. Test Procedure

#### ➤RF Out Power (Radiated)

The Spectrum Analyzer was tuned to the test frequency. The device was put into Transmit mode then rotated through 360 degrees until the highest power level was observed in both horizontal and vertical polarization. The device was then replaced with a substitution antenna, which input signal was adjusted until the received level matched that of the previously detected emission.

The EUT is tested with maximum rated TX power via the Base Station simulator.

#### ➤RF Out Power (Conducted)

The EUT is tested with maximum rated TX power via the Base Station simulator, and the output power was measured at the antenna terminals of the EUT.

### 2.5. Test Specification

According to Part 2.1046, 22.913,24.232.

## 2.6. Test Result of Peak Power Output

Product	Notebook		
Test Mode	RF Output Power (Conducted)		
Date of Test	2009/04/01	Test Site	CTR

GPRS 850				
Frequency (MHz)	Output Power (dBm)	Path Loss (dB)	Result (dBm)	Result (W)
824.2	31.17	0.4	31.57	1.44
836.4	31.19	0.4	31.59	1.44
848.8	30.99	0.4	31.39	1.38
EGPRS 850				
Frequency (MHz)	Output Power (dBm)	Path Loss (dB)	Result (dBm)	Result (W)
824.2	25.21	0.4	25.61	0.36
836.4	25.23	0.4	25.63	0.37
848.8	25.04	0.4	25.44	0.35

GPRS 1900				
Frequency (MHz)	Output Power (dBm)	Path Loss (dB)	Result (dBm)	Result (W)
1850.2	28.05	0.6	28.65	0.73
1880	28.13	0.6	28.73	0.75
1909.8	28.10	0.6	28.70	0.74
EGPRS 1900				
Frequency (MHz)	Output Power (dBm)	Path Loss (dB)	Result (dBm)	Result (W)
1850.2	24.10	0.6	24.70	0.30
1880	24.22	0.6	24.82	0.30
1909.8	24.21	0.6	24.81	0.30

WCDMA V				
Frequency (MHz)	Output Power (dBm)	Path Loss (dB)	Result (dBm)	Result (W)
826.4	20.69	0.4	21.09	0.13
836.6	20.81	0.4	21.21	0.13
846.6	20.77	0.4	21.17	0.13

WCDMA V HSDPA								
Frequency (MHz)	Set 1		Set 2		Set 3		Set 4	
	Power (dBm)	Power (Watts)	Power (dBm)	Power (Watts)	Power (dBm)	Power (Watts)	Power (dBm)	Power (Watts)
826.4	21.01	0.13	20.81	0.12	20.47	0.11	20.47	0.11
836.6	21.10	0.13	20.84	0.12	20.64	0.12	20.52	0.11
846.6	21.06	0.13	20.80	0.12	20.61	0.12	20.45	0.11
$\beta_c$	2		12		15		15	
$\beta_d$	15		15		8		4	
$\Delta_{ACK}, \Delta_{NACK}, \Delta_{CQI}$	8		8		8		8	
Cable loss: 0.4dB for 850MHz ; 0.6dB for 1900MHz								

All HSDPA testing was done in Set1 configuration.

WCDMA II				
Frequency (MHz)	Output Power (dBm)	Path Loss (dB)	Result (dBm)	Result (W)
1852.4	21.33	0.6	21.93	0.16
1880	21.35	0.6	21.95	0.16
1907.6	21.26	0.6	21.86	0.15

WCDMA II HSDPA								
Frequency (MHz)	Set 1		Set 2		Set 3		Set 4	
	Power (dBm)	Power (Watts)	Power (dBm)	Power (Watts)	Power (dBm)	Power (Watts)	Power (dBm)	Power (Watts)
1852.4	21.83	0.15	21.65	0.15	21.57	0.14	21.45	0.14
1880	21.86	0.15	21.68	0.15	21.70	0.15	21.47	0.14
1907.6	21.58	0.14	21.16	0.13	21.10	0.13	21.09	0.13
$\beta_c$	2		12		15		15	
$\beta_d$	15		15		8		4	
$\Delta_{ACK}, \Delta_{NACK}, \Delta_{CQI}$	8		8		8		8	
Cable loss: 0.4dB for 850MHz ; 0.6dB for 1900MHz								

All HSDPA testing was done in Set1 configuration.

Product	Notebook		
Test Mode	RF Output Power (Radiated)		
Date of Test	2009/04/01	Test Site	OATS 3
Test Condition	GSM 850 GPRS		

**Maximum Power-GSM 850 GPRS**

Frequency (MHz)	Reading Level (dBm)	Substitution Level (dBm)	Substitution Antenna Gain (dBd)	Cable Loss (dB)	Result ERP (dBm)	Result ERP (W)
824.2	18.471	21.35	4.45	0.51	25.29	0.34
836.4	17.654	20.51	4.45	0.51	24.45	0.28
848.8	16.731	19.58	4.45	0.51	23.52	0.22

## Note:

1. The EUT meets the requirements of FCC CFR 47: Part 22, Section 22.913(a) for Effective Radiated Power.
2. Receiver setting (Peak Detector) : RBW:3MHz; VBW:3MHz
3. Result ERP = Substitution Level + Substitution Antenna Gain - Cable Loss

Product	Notebook		
Test Mode	RF Output Power (Radiated)		
Date of Test	2009/04/01	Test Site	OATS 3
Test Condition	GSM 850 EGPRS		

**Maximum Power-GSM 850 EGPRS**

Frequency (MHz)	Reading Level (dBm)	Substitution Level (dBm)	Substitution Antenna Gain (dBd)	Cable Loss (dB)	Result ERP (dBm)	Result ERP (W)
824.2	12.900	15.74	4.45	0.51	19.68	0.09
836.4	11.65	14.49	4.45	0.51	18.43	0.07
848.8	10.956	13.80	4.45	0.51	17.74	0.06

## Note:

1. The EUT meets the requirements of FCC CFR 47: Part 22, Section 22.913(a) for Effective Radiated Power.
2. Receiver setting (Peak Detector) : RBW:3MHz; VBW:3MHz
3. Result ERP = Substitution Level + Substitution Antenna Gain - Cable Loss



Product	Notebook		
Test Mode	RF Output Power (Radiated)		
Date of Test	2009/04/01	Test Site	OATS 3
Test Condition	PCS 1900 GPRS		

**Maximum Power-PCS 1900 GPRS**

Frequency (MHz)	Reading Level (dBm)	Substitution Level (dBm)	Substitution Antenna Gain (dBi)	Cable Loss (dB)	Result EIRP (dBm)	Result EIRP (W)
1850.2	-13.748	16.130	10.4	1.02	25.510	0.36
1880.0	-12.871	17.379	10.4	1.02	26.759	0.47
1909.8	-13.951	16.541	10.4	1.02	25.921	0.39

## Note:

1. The EUT meets the requirements of FCC CFR 47: Part 24, Section 24.232(b) for Effective Isotropically Radiated Power.
2. Receiver setting (Peak Detector) : RBW:3MHz; VBW:3MHz
3. Result EIRP = Substitution Level + Substitution Antenna Gain - Cable Loss

Product	Notebook		
Test Mode	RF Output Power (Radiated)		
Date of Test	2009/04/01	Test Site	OATS 3
Test Condition	PCS 1900 EGPRS		

**Maximum Power-PCS 1900 EGPRS**

Frequency (MHz)	Reading Level (dBm)	Substitution Level (dBm)	Substitution Antenna Gain (dBi)	Cable Loss (dB)	Result EIRP (dBm)	Result EIRP (W)
1850.2	-17.681	12.197	10.4	1.02	21.577	0.14
1880.0	-17.281	12.969	10.4	1.02	22.349	0.17
1909.8	-17.936	12.556	10.4	1.02	21.936	0.16

## Note:

1. The EUT meets the requirements of FCC CFR 47: Part 24, Section 24.232(b) for Effective Isotropically Radiated Power.
2. Receiver setting (Peak Detector) : RBW:3MHz; VBW:3MHz
3. Result EIRP = Substitution Level + Substitution Antenna Gain - Cable Loss

Product	Notebook		
Test Mode	RF Output Power (Radiated)		
Date of Test	2009/04/01	Test Site	OATS 3
Test Condition	WCDMA BAND V		

**Maximum Power- WCDMA BAND V**

Frequency (MHz)	Reading Level (dBm)	Substitution Level (dBm)	Substitution Antenna Gain (dBd)	Cable Loss (dB)	Result ERP (dBm)	Result ERP (W)
826.4	11.921	14.76	4.45	0.51	18.70	0.07
836.6	12.023	14.86	4.45	0.51	18.80	0.08
846.6	10.477	13.33	4.45	0.51	17.27	0.05

## Note:

1. The EUT meets the requirements of FCC CFR 47: Part 22, Section 22.913(a) for Effective Radiated Power.
2. Receiver setting (Peak Detector) : RBW:5MHz; VBW:5MHz
3. Result ERP = Substitution Level + Substitution Antenna Gain - Cable Loss

Product	Notebook		
Test Mode	RF Output Power (Radiated)		
Date of Test	2009/04/01	Test Site	OATS 3
Test Condition	WCDMA BAND V HSDPA		

**Maximum Power- WCDMA BAND V HSDPA**

Frequency (MHz)	Reading Level (dBm)	Substitution Level (dBm)	Substitution Antenna Gain (dBd)	Cable Loss (dB)	Result ERP (dBm)	Result ERP (W)
826.4	11.846	14.68	4.45	0.51	18.62	0.07
836.6	11.701	14.54	4.45	0.51	18.48	0.07
846.6	10.622	13.47	4.45	0.51	17.41	0.06

## Note:

1. The EUT meets the requirements of FCC CFR 47: Part 22, Section 22.913(a) for Effective Radiated Power.
2. Receiver setting (Peak Detector) : RBW:5MHz; VBW:5MHz
3. Result ERP = Substitution Level + Substitution Antenna Gain - Cable Loss

Product	Notebook		
Test Mode	RF Output Power (Radiated)		
Date of Test	2009/04/01	Test Site	OATS 3
Test Condition	WCDMA BAND II		

**Maximum Power- WCDMA BAND II**

Frequency (MHz)	Reading Level (dBm)	Substitution Level (dBm)	Substitution Antenna Gain (dBi)	Cable Loss (dB)	Result EIRP (dBm)	Result EIRP (W)
1852.4	-16.906	12.999	10.4	1.02	22.379	0.17
1880	-16.237	14.013	10.4	1.02	23.393	0.22
1907.6	-17.712	12.782	10.4	1.02	22.162	0.16

## Note:

1. The EUT meets the requirements of FCC CFR 47: Part 24, Section 24.232(b) for Effective Isotropically Radiated Power.
2. Receiver setting (Peak Detector) : RBW:5MHz; VBW:5MHz
3. Result EIRP = Substitution Level + Substitution Antenna Gain - Cable Loss

Product	Notebook		
Test Mode	RF Output Power (Radiated)		
Date of Test	2009/04/01	Test Site	OATS 3
Test Condition	WCDMA BAND II HSDPA		

**Maximum Power- WCDMA BAND II HSDPA**

Frequency (MHz)	Reading Level (dBm)	Substitution Level (dBm)	Substitution Antenna Gain (dBi)	Cable Loss (dB)	Result EIRP (dBm)	Result EIRP (W)
1852.4	-16.930	12.975	10.4	1.02	22.355	0.17
1880	-16.412	13.838	10.4	1.02	23.218	0.21
1907.6	-17.847	12.647	10.4	1.02	22.027	0.16

## Note:

1. The EUT meets the requirements of FCC CFR 47: Part 24, Section 24.232(b) for Effective Isotropically Radiated Power.
2. Receiver setting (Peak Detector) : RBW:5MHz; VBW:5MHz
3. Result EIRP = Substitution Level + Substitution Antenna Gain - Cable Loss

### 3. Occupied Bandwidth

#### 3.1. Test Equipment

The following test equipments are used during the occupied bandwidth tests:

Equipment	Manufacturer	Model No./Serial No.	Last Cal.
Spectrum Analyzer (9K-26.5GHz)	Agilent	N9020A/MY48010570	Apr., 2009
Universal Radio Communication Tester	R & S	CMU200 / 104846	Apr., 2009
Directional coupler	Agilent	87300C / MY44300353	Aug., 2008
Directional coupler	Agilent	778D-012/ 50550	Aug., 2008

Note: All equipments upon which need to be calibrated are with calibration period of 1 year.

#### 3.2. Test Setup

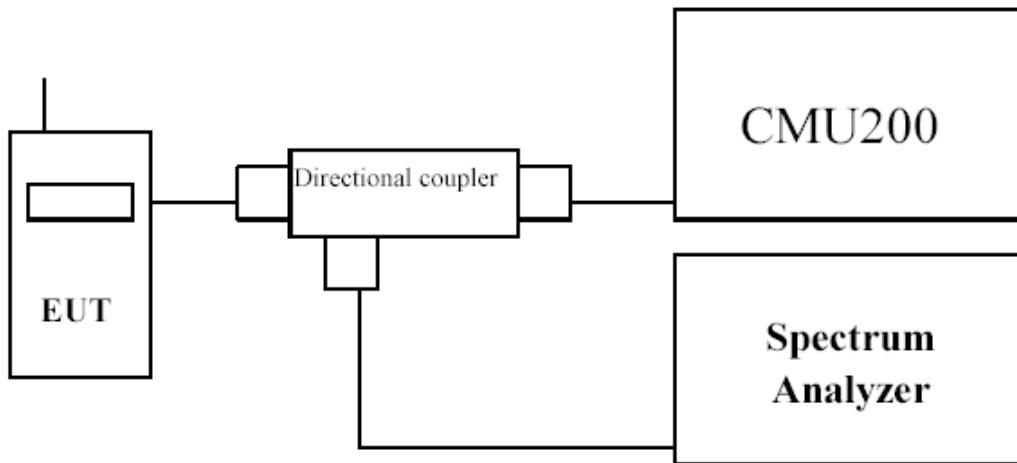

#### 3.3. Test Procedure

The EUT is tested with maximum rated TX power via the Base Station simulator, and the occupied bandwidth was measured at the antenna terminals of the EUT.

The Resolution BW of the analyzer is set to 1 % of the emission bandwidth. The EUT's occupied bandwidth is measured as the width of the signal between two points, one below the carrier center frequency and one above the carrier frequency, outside of which all emissions are attenuated at least 26 dB below the transmitter power.

The plots below show the resultant display from the Spectrum Analyzer.

### **3.4. Test Specification**

According to Part 2.1049, 22.917(b), 24.238(b).



### 3.5. Test Result of Occupied Bandwidth

Product	Notebook		
Test Mode	Occupied Bandwidth		
Date of Test	2009/03/28	Test Site	CTR
Test Condition	GSM 850 GPRS		

GSM 850 GPRS - Packet Switched (GSM Mode CH 128)

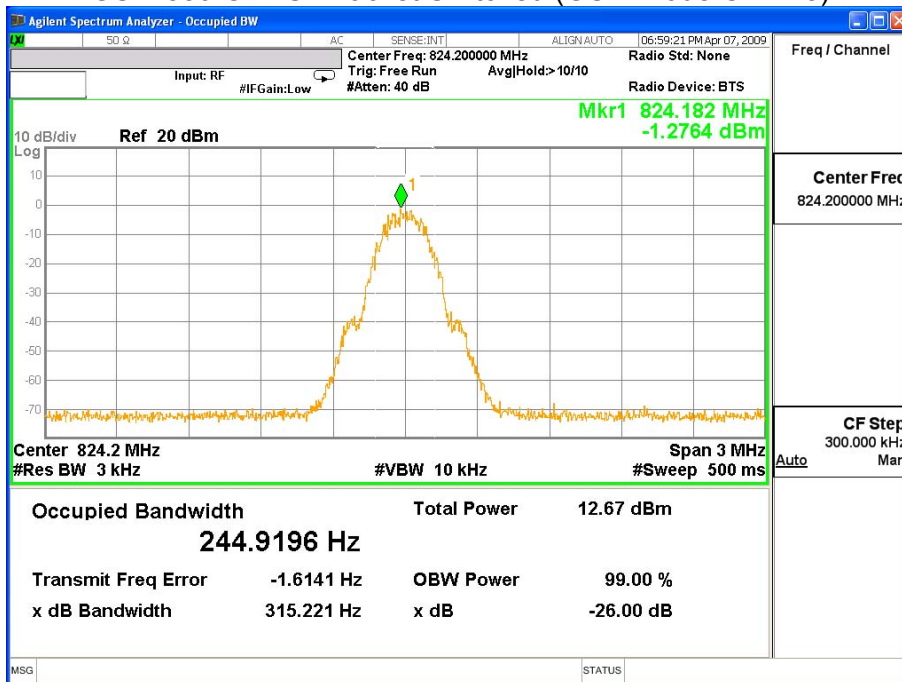

GSM 850 GPRS - Packet Switched (GSM Mode CH189)

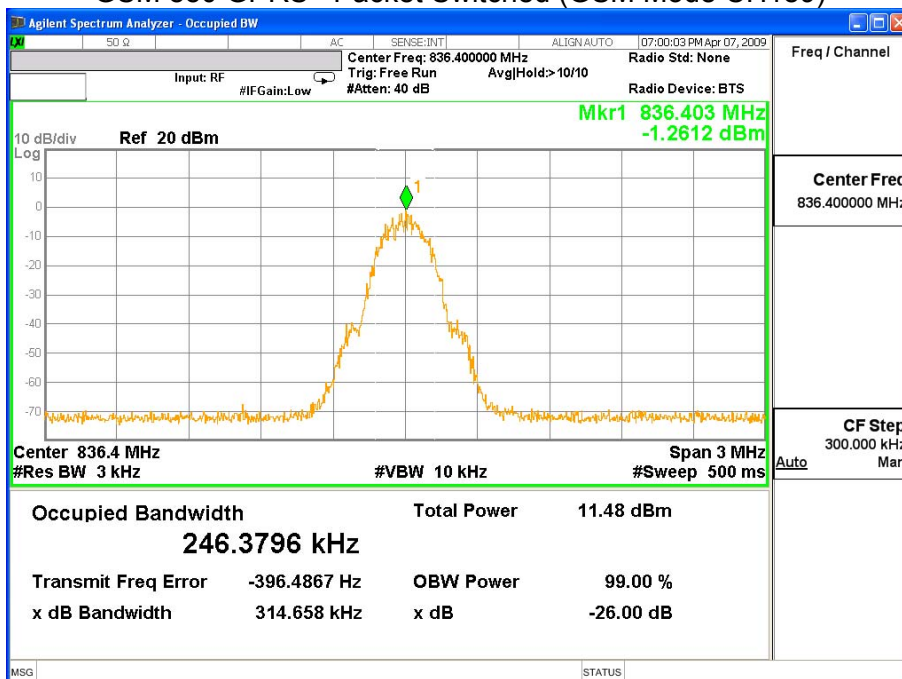

Product	Notebook		
Test Mode	Occupied Bandwidth		
Date of Test	2009/03/28	Test Site	CTR
Test Condition	GSM 850 GPRS		

GSM 850 GPRS - Packet Switched (GSM Mode CH 251)

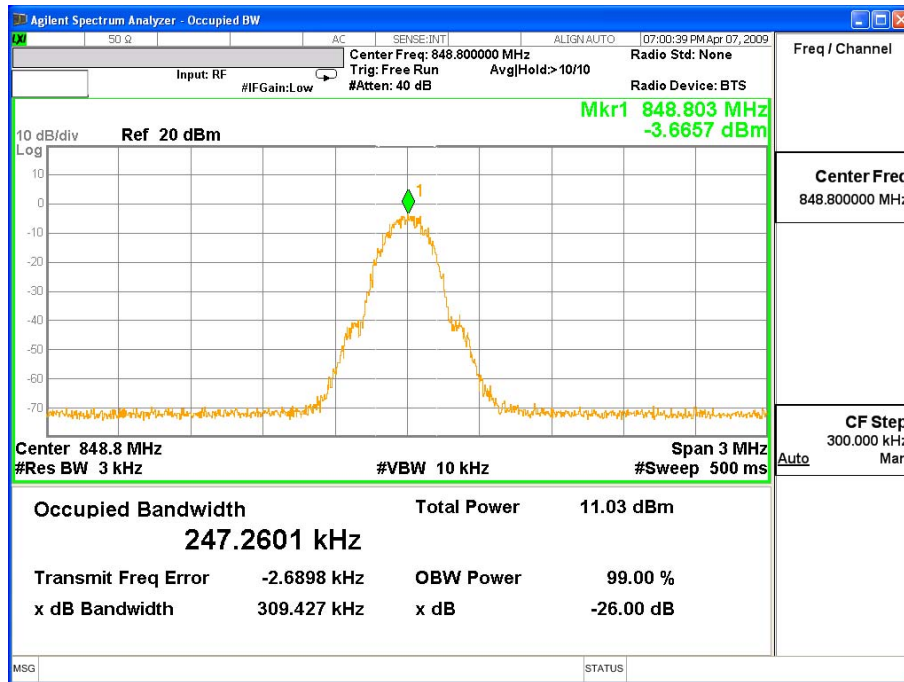

Product	Notebook		
Test Mode	Occupied Bandwidth		
Date of Test	2009/03/28	Test Site	CTR
Test Condition	GSM 850 EGPRS		

GSM 850 EGPRS - Packet Switched (GSM Mode CH 128)

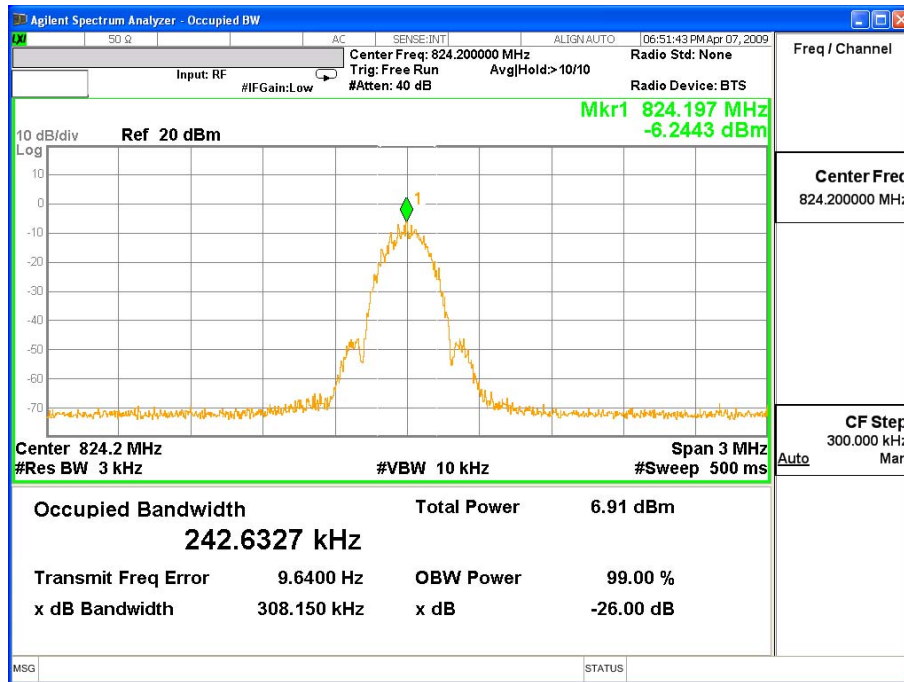

GSM 850 EGPRS - Packet Switched (GSM Mode CH189)

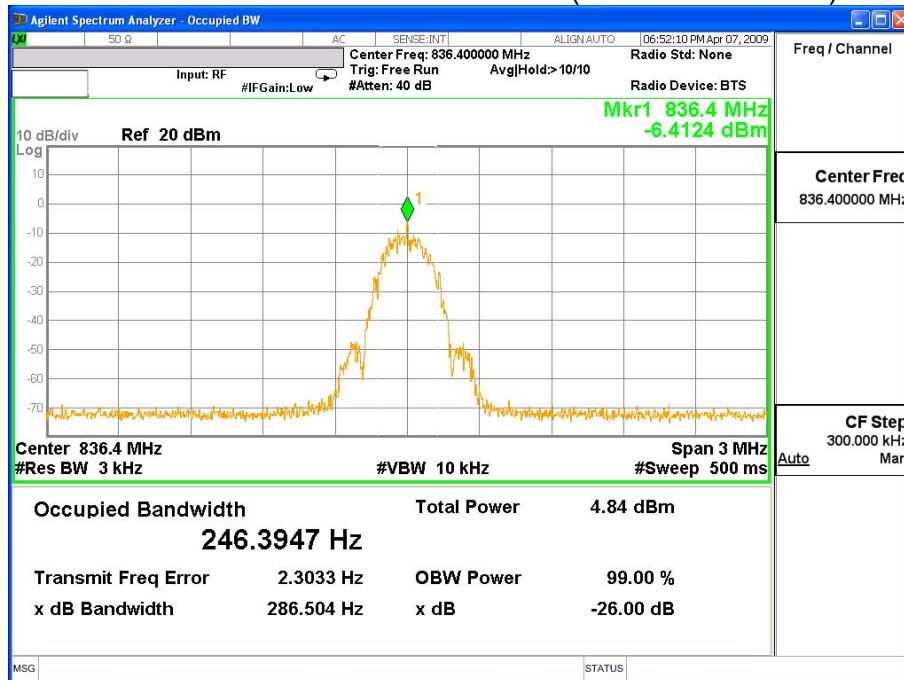

Product	Notebook		
Test Mode	Occupied Bandwidth		
Date of Test	2009/03/28	Test Site	CTR
Test Condition	GSM 850 EGPRS		

GSM 850 EGPRS - Packet Switched (GSM Mode CH 251)

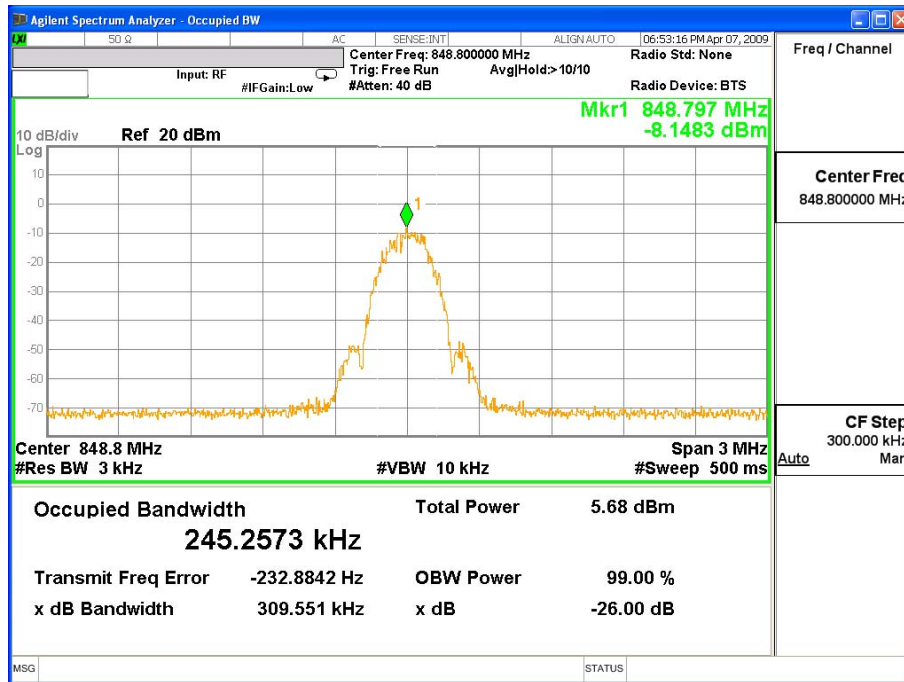

Product	Notebook		
Test Mode	Occupied Bandwidth		
Date of Test	2009/03/28	Test Site	CTR
Test Condition	PCS1900 GPRS		

PCS1900 GPRS - Packet Switched (PCS Mode CH 512)

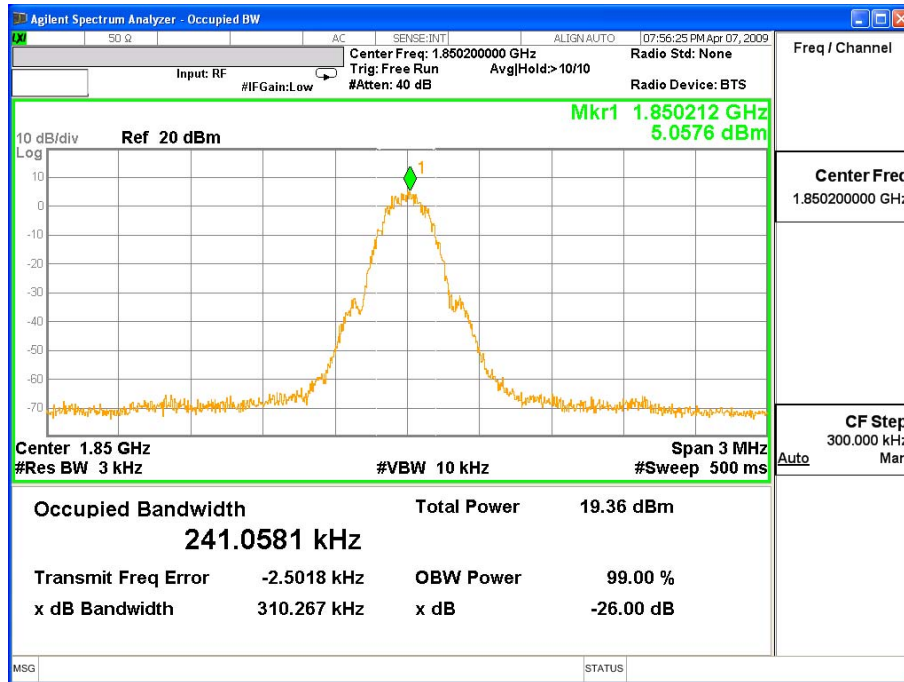

PCS1900 GPRS - Packet Switched (PCS Mode CH661)

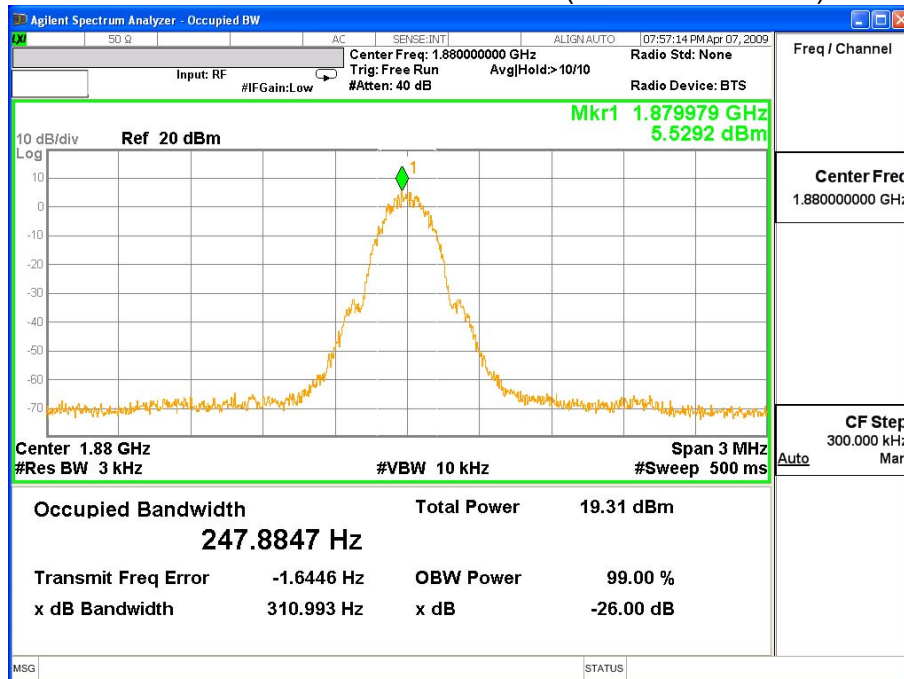

Product	Notebook		
Test Mode	Occupied Bandwidth		
Date of Test	2009/03/28	Test Site	CTR
Test Condition	PCS1900 GPRS		

PCS1900 GPRS - Packet Switched (PCS Mode CH 810)

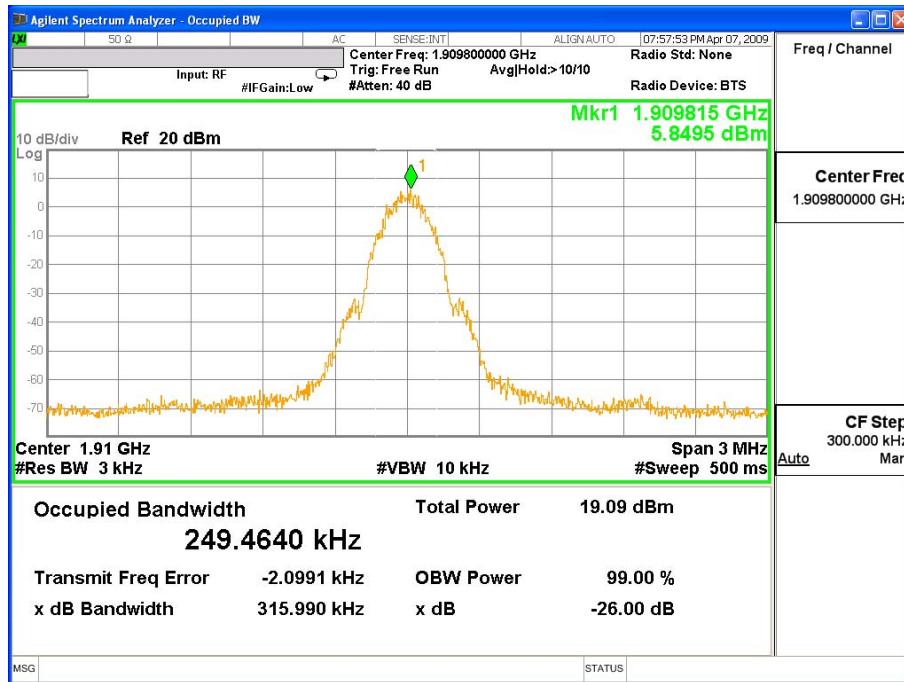

Product	Notebook		
Test Mode	Occupied Bandwidth		
Date of Test	2009/03/28	Test Site	CTR
Test Condition	PCS1900 EGPRS		

PCS1900 EGPRS - Packet Switched (PCS Mode CH 512)

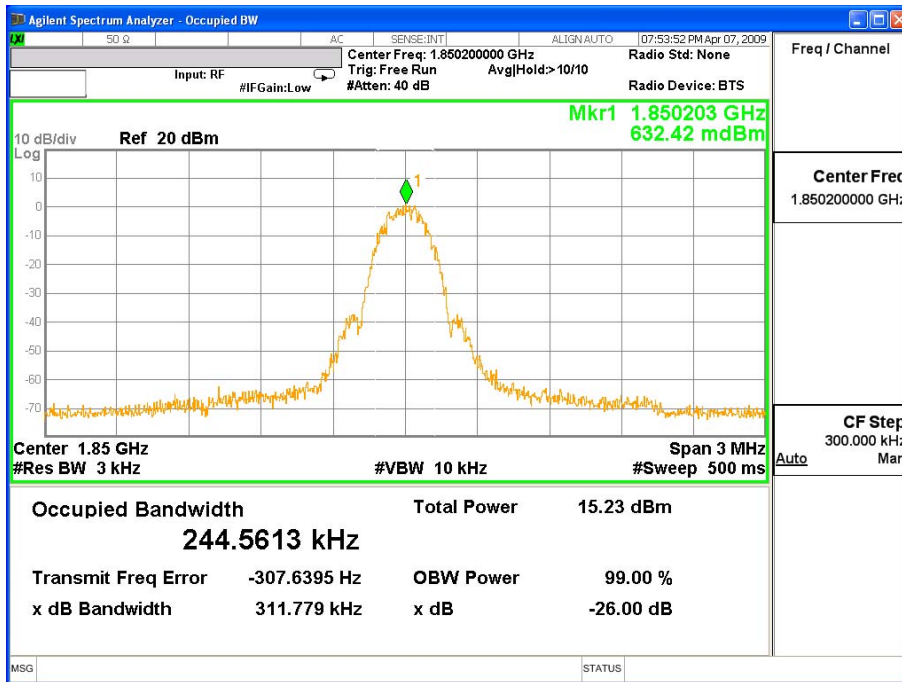

PCS1900 EGPRS - Packet Switched (PCS Mode CH661)

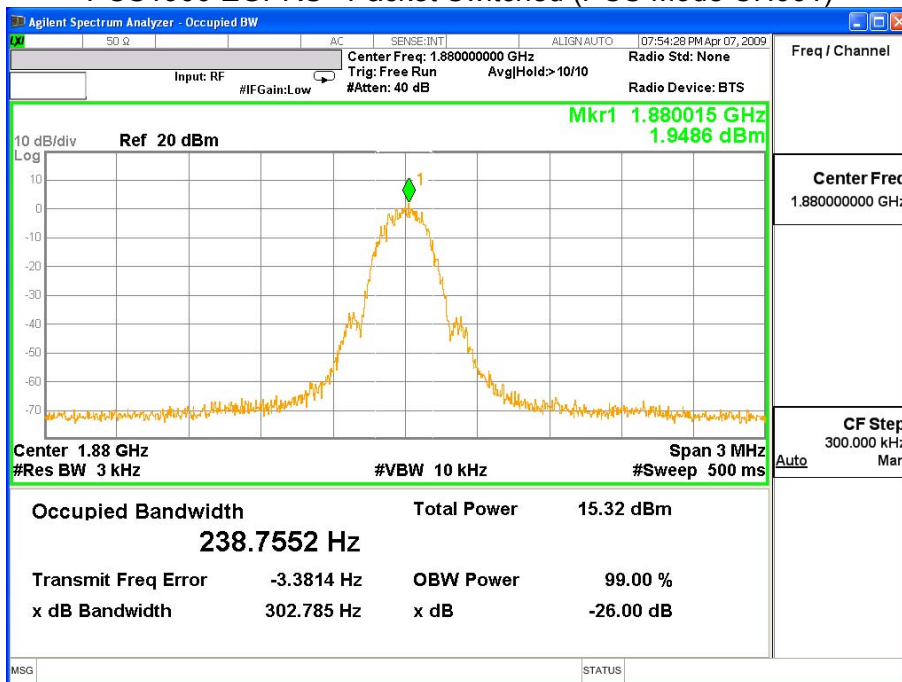

Product	Notebook		
Test Mode	Occupied Bandwidth		
Date of Test	2009/03/28	Test Site	CTR
Test Condition	PCS1900 EGPRS		

PCS1900 EGPRS - Packet Switched (PCS Mode CH 810)

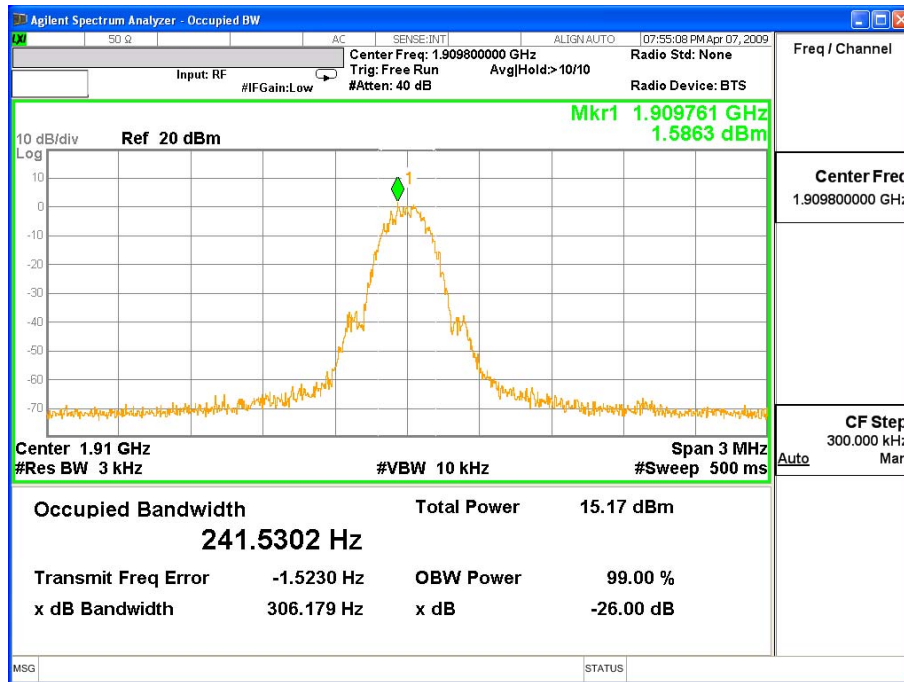



Product	Notebook		
Test Mode	Occupied Bandwidth		
Date of Test	2009/03/28	Test Site	CTR
Test Condition	WCDMA BAND V		

WCDMA BAND V (WCDMA Mode CH 4132)

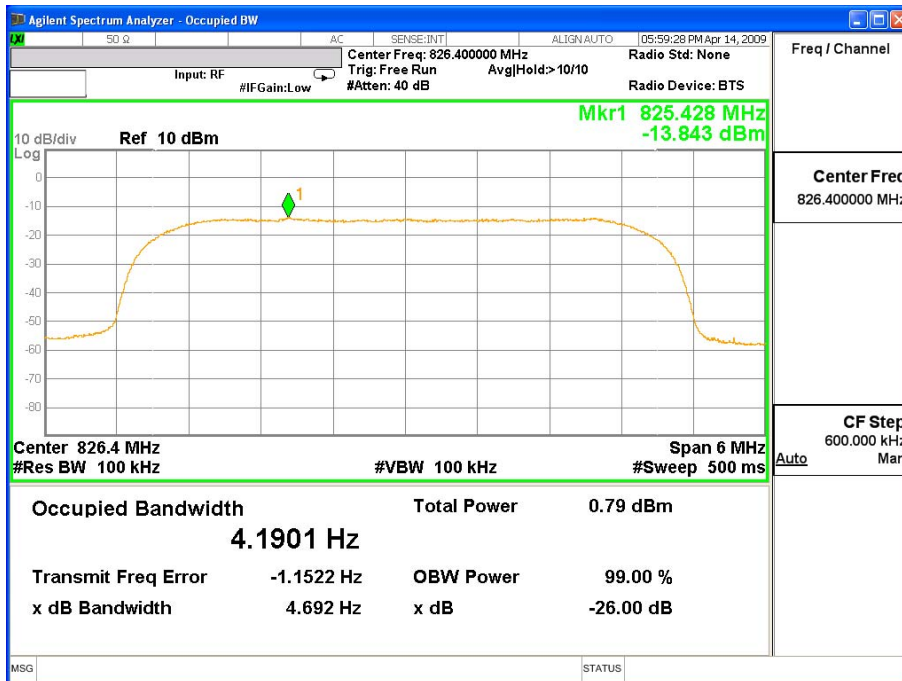

WCDMA BAND V (WCDMA Mode CH 4183)

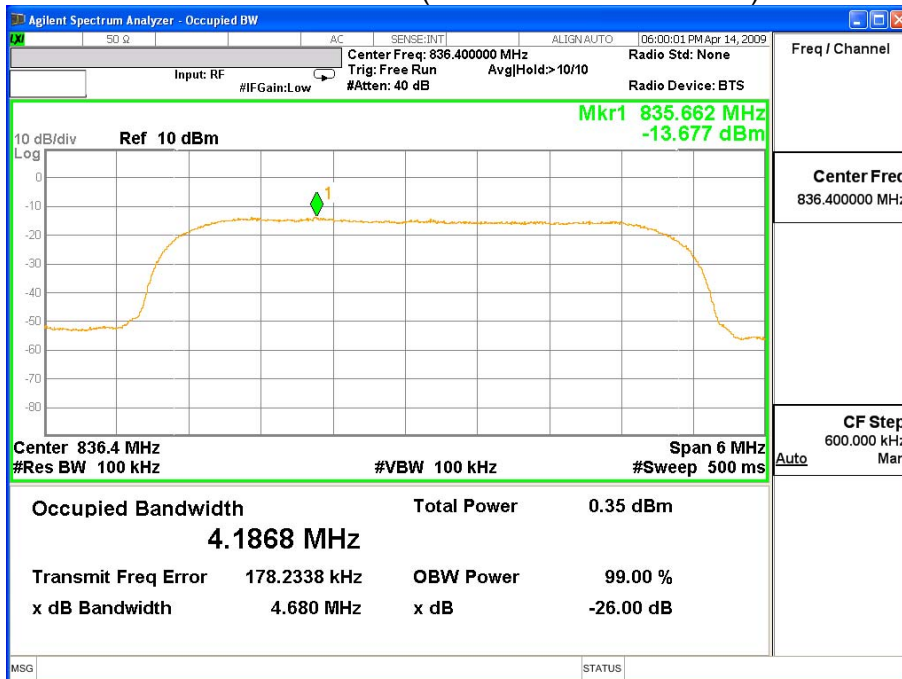

Product	Notebook		
Test Mode	Occupied Bandwidth		
Date of Test	2009/03/28	Test Site	CTR
Test Condition	WCDMA BAND V		

WCDMA BAND V (WCDMA Mode CH 4233)

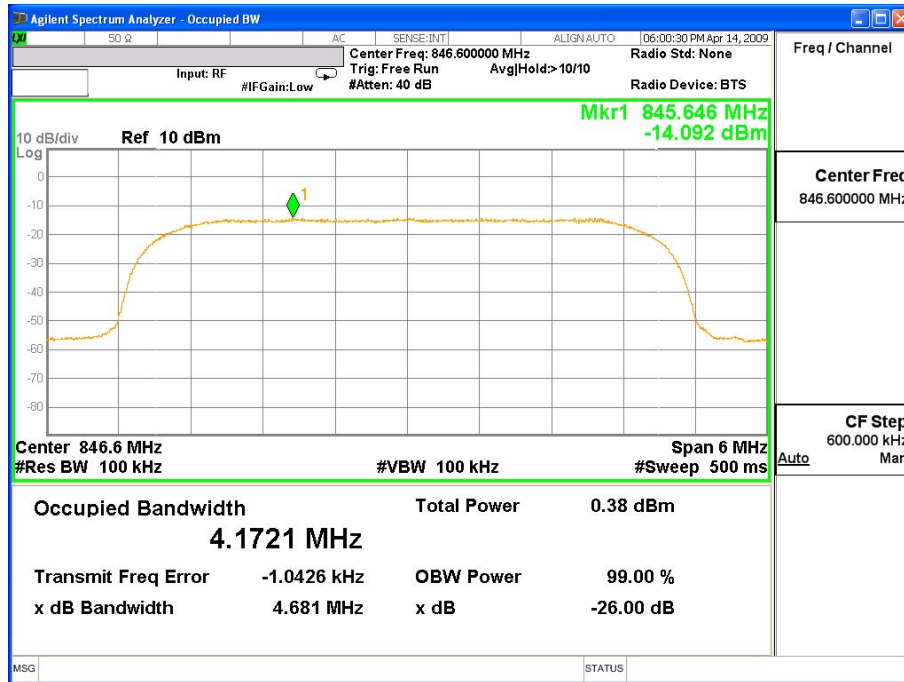

Product	Notebook		
Test Mode	Occupied Bandwidth		
Date of Test	2009/03/28	Test Site	CTR
Test Condition	WCDMA BAND V HSDPA		

WCDMA BAND V HSDPA - Packet Switched (HSDPA Mode CH 4132)

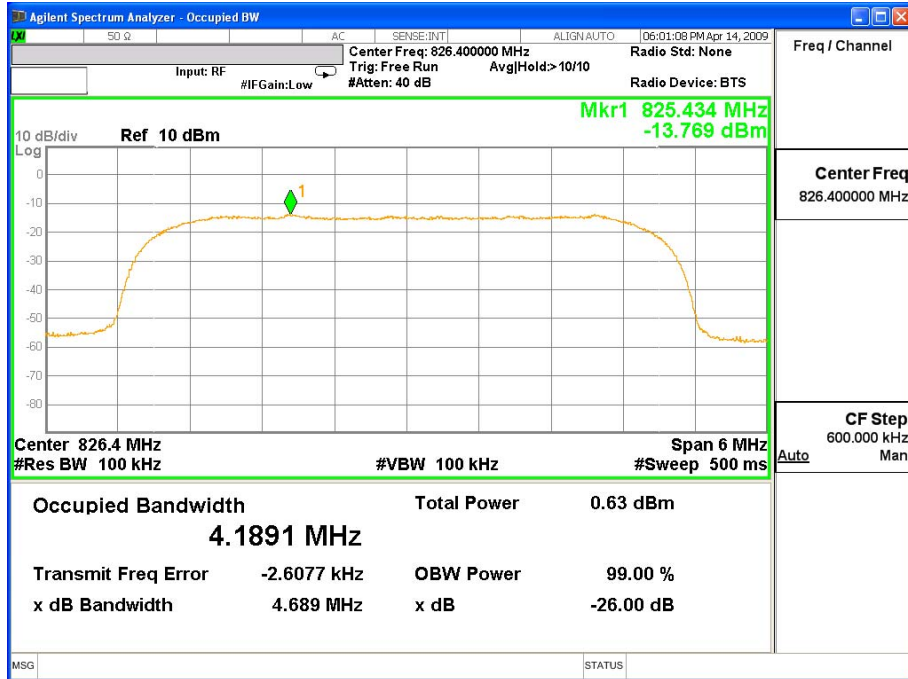

WCDMA BAND V HSDPA - Packet Switched (HSDPA Mode CH 4183)

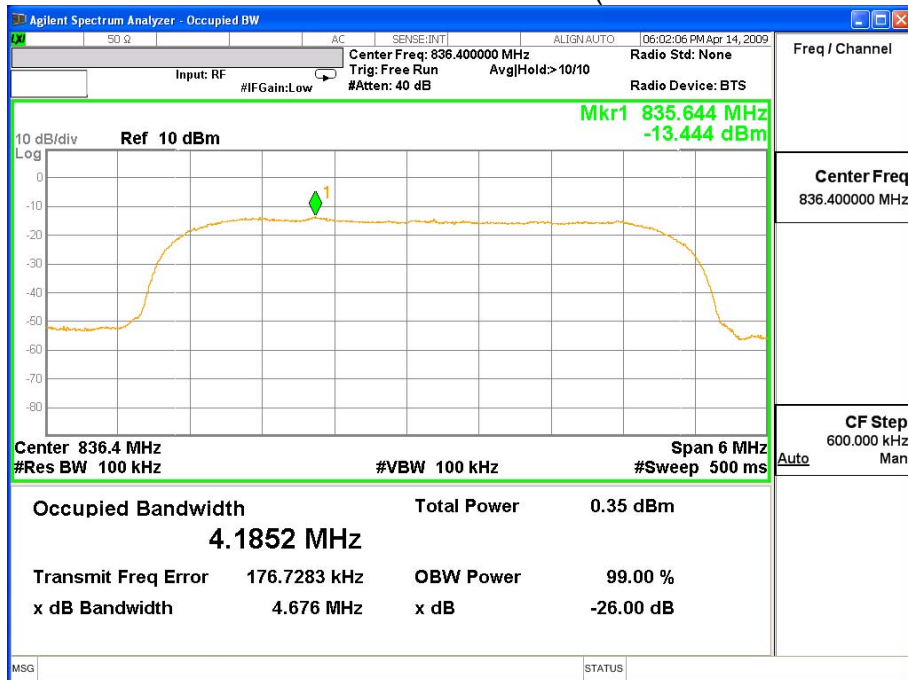

Product	Notebook		
Test Mode	Occupied Bandwidth		
Date of Test	2009/03/28	Test Site	CTR
Test Condition	WCDMA BAND V HSDPA		

WCDMA BAND V HSDPA - Packet Switched (HSDPA Mode CH 4233)

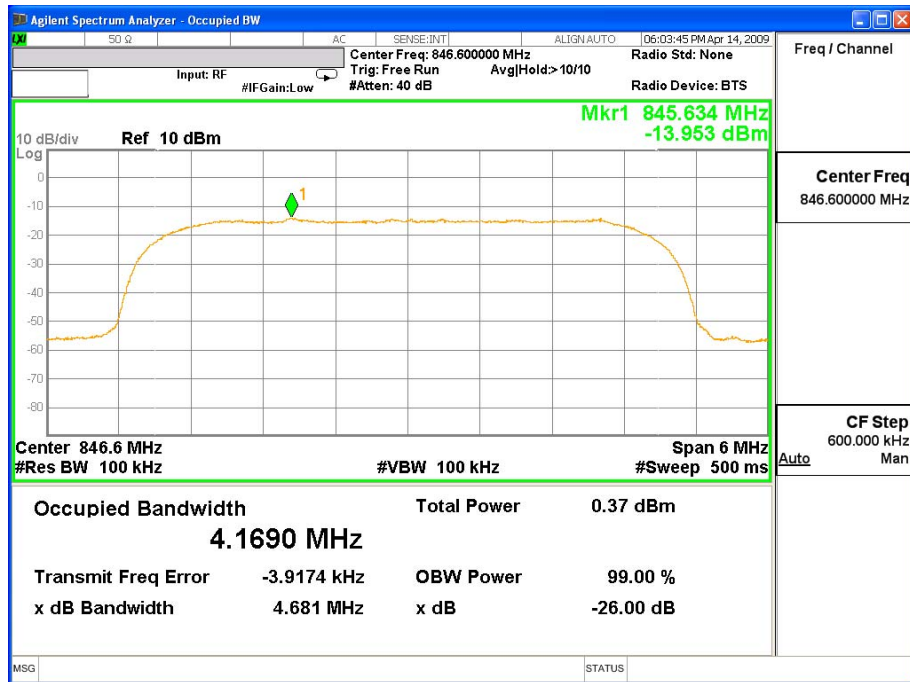

Product	Notebook		
Test Mode	Occupied Bandwidth		
Date of Test	2009/03/28	Test Site	CTR
Test Condition	WCDMA BAND II		

WCDMA BAND II (WCDMA Mode CH 9262)

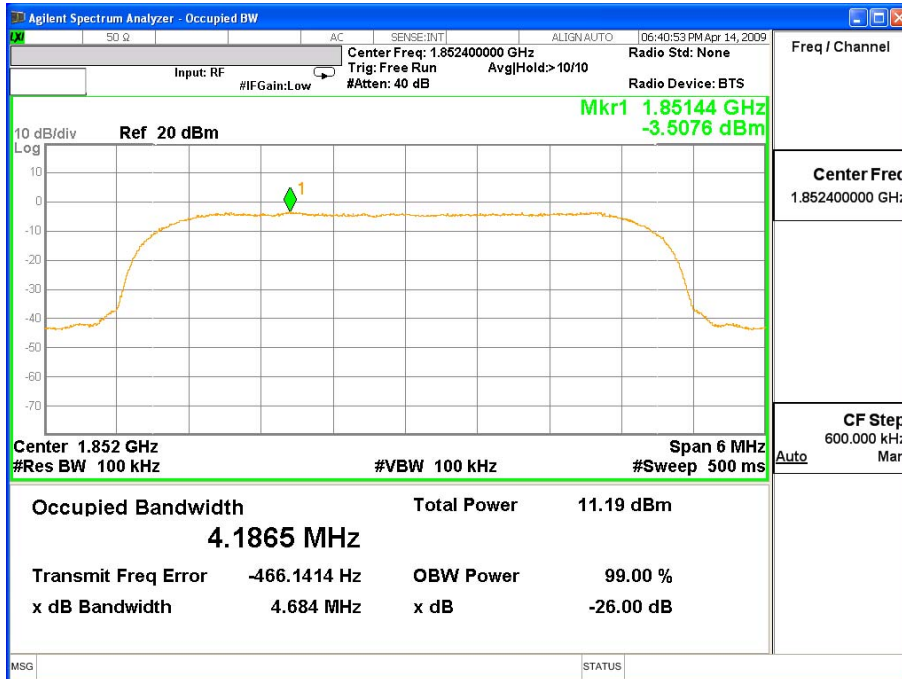

WCDMA BAND II (WCDMA Mode CH 9400)

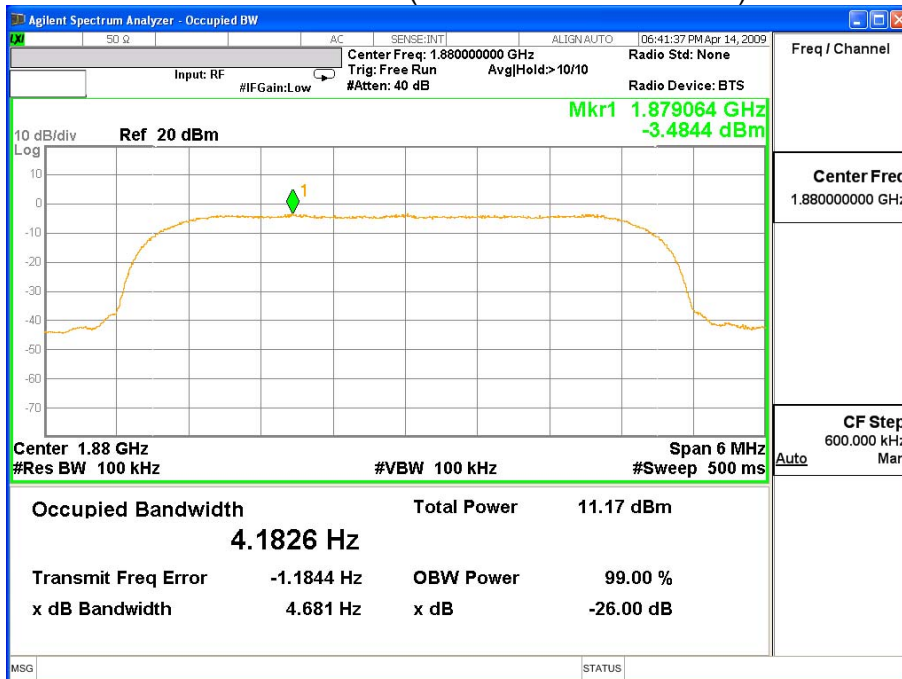

Product	Notebook		
Test Mode	Occupied Bandwidth		
Date of Test	2009/03/28	Test Site	CTR
Test Condition	WCDMA BAND II		

WCDMA BAND II (WCDMA Mode CH 9538)

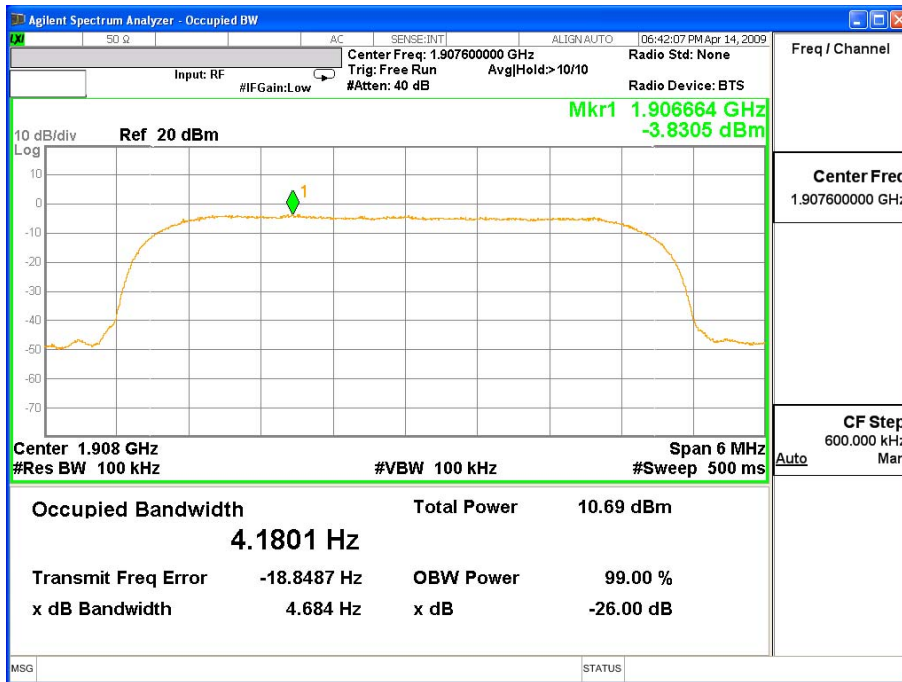

Product	Notebook		
Test Mode	Occupied Bandwidth		
Date of Test	2009/03/28	Test Site	CTR
Test Condition	WCDMA BAND II HSDPA		

WCDMA BAND II HSDPA - Packet Switched (HSDPA Mode CH 9262)

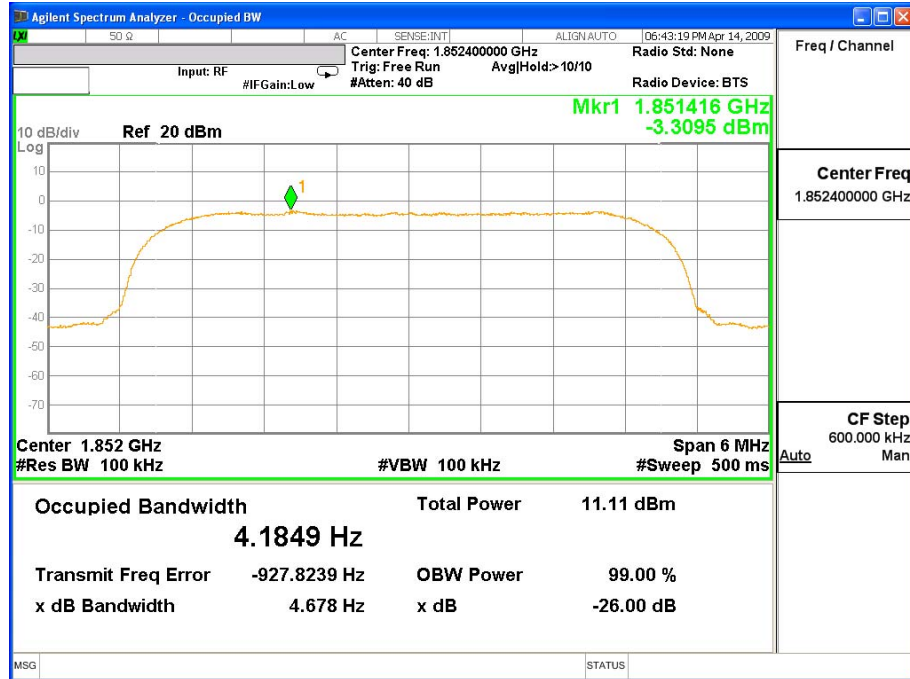

WCDMA BAND II HSDPA - Packet Switched (HSDPA Mode CH 9400)

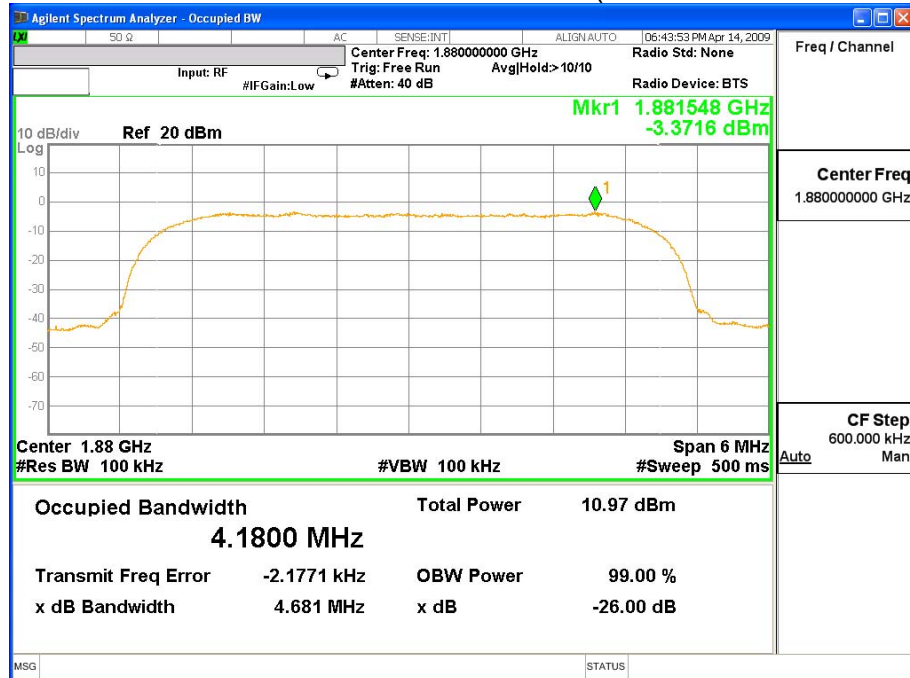

Product	Notebook		
Test Mode	Occupied Bandwidth		
Date of Test	2009/03/28	Test Site	CTR
Test Condition	WCDMA BAND II HSDPA		

WCDMA BAND II HSDPA - Packet Switched (HSDPA Mode CH 9538)

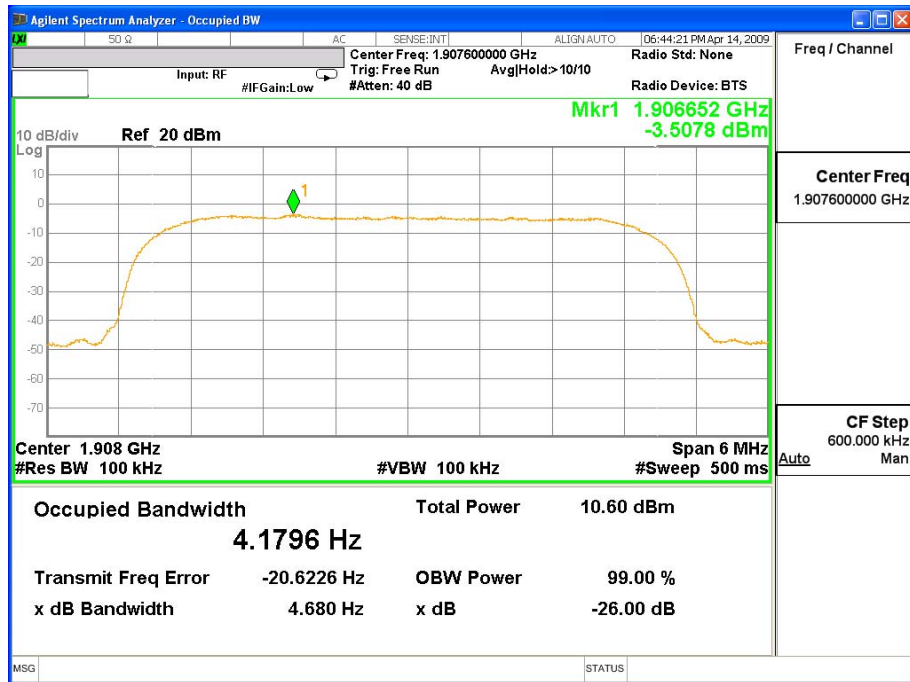



**4. Spurious Emission At Antenna Terminals (+/-1MHz)**

**4.1. Test Equipment**

The following test equipments are used during the spurious emission test

Equipment	Manufacturer	Model No./Serial No.	Last Cal.
Spectrum Analyzer (9K-26.5GHz)	Agilent	N9020A/MY48010570	Apr., 2009
Universal Radio Communication Tester	R & S	CMU200 / 104846	Apr., 2009
Directional coupler	Agilent	87300C / MY44300353	Aug., 2008
Directional coupler	Agilent	778D-012/ 50550	Aug., 2008

Note: All equipments upon which need to be calibrated are with calibration period of 1 year.

**4.2. Setup**

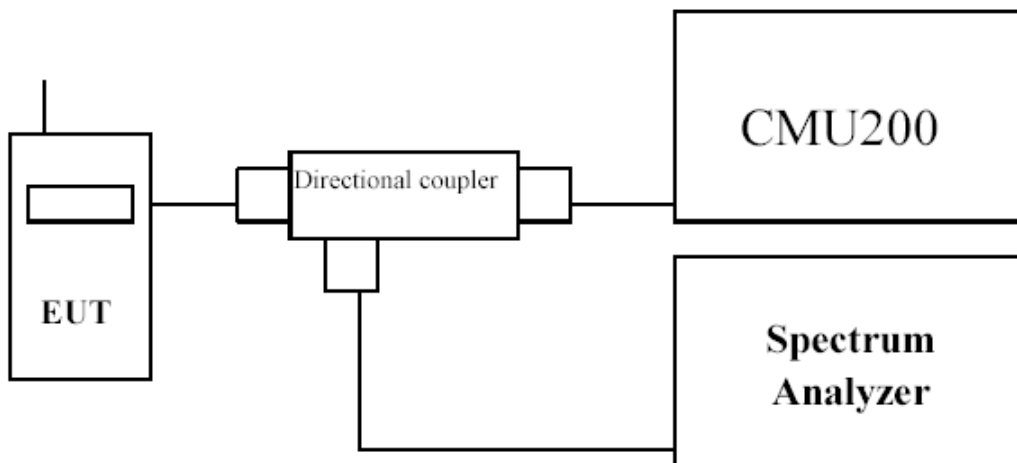

### 4.3. Limits

Cellular Band Transmitter limits for narrowband spurious emission

<b>Lower Block Edge Test Frequencies</b>	<b>Upper Block Edge Test Frequencies</b>
Block A Channel : 128 Frequency : 824.2 MHz	Block B Channel : 251 Frequency : 848.8 MHz

PCS Band Transmitter limits for narrowband spurious emission

<b>Lower Block Edge Test Channels/Frequencies</b>	<b>Upper Block Edge Test Channels/Frequencies</b>
Block A Channel : 512 Frequency : 1850.2 MHz	Block C Channel : 810 Frequency : 1909.8 MHz

### 4.4. Test Procedure

In accordance with Part 22.917 and 24.238, at least 1% of the emission bandwidth was used for the resolution and video bandwidths up to 1MHz away from the Block Edge. At greater than 1MHz, the resolution and video bandwidth were increased to 1MHz.

The reference power and path losses of all channels used for testing in each frequency block were measured.

### 4.5. Test Specification

According to Part 2.1049, 22.917,24.238.