



Test report No:
1962179R-RF-US-P06V01

TEST REPORT

FCC Rules & Regulations 47 CFR Chapter I - Part 15

| | |
|---|--|
| Product Name | WiFi Plug US |
| Trademark | KylaS |
| Model and /or type reference | KWFP-220-WF |
| FCC ID | I38KWFP220WF |
| Applicant's name / address | Aztech Technologies Pte Ltd 31 Ubi Road 1, Aztech Building Singapore 408694 |
| Test method requested, standard | FCC CFR Title 47 Part 15 Subpart C Section 15.247 ANSI C63.10: 2013 KDB558074 D01v05r02 |
| Verdict Summary | IN COMPLIANCE |
| Documented By | Kathy Feng/Project Assistant  |
| Tested by (name / position & signature) | Frank He/ Technical Supervisor  |
| Approved by (name / position & signature) | Jack Zhang/ Supervisor  |
| Date of issue | 2019-07-26 |
| Report template No | 1962179R-RF-US-P06V01 |

INDEX

| | page |
|---|-------------|
| Competences and Guarantees..... | 4 |
| General conditions..... | 4 |
| Environmental conditions..... | 4 |
| Possible test case verdicts..... | 5 |
| Abbreviations..... | 5 |
| Document History..... | 6 |
| Remarks and Comments..... | 6 |
| Used Equipment..... | 7 |
| Uncertainty..... | 9 |
| 1 General Information..... | 10 |
| 1.1 General Description of the Item(s)..... | 10 |
| 1.2 Antenna Information..... | 11 |
| 1.3 Test date..... | 12 |
| 1.4 Data Rate..... | 12 |
| 1.5 Channel List..... | 14 |
| 2.1 Operating mode(s) used for tests..... | 15 |
| 2.2 Support / Auxiliary equipment / unit / Test software for the EUT..... | 15 |
| 2.3 Test Configuration / Block diagram used for tests..... | 16 |
| 2.4 Testing process..... | 17 |
| 3.1 Standards..... | 18 |
| 3.2 Overview of results..... | 18 |
| 3.3 Test Facility..... | 19 |
| 4.1 AC Power Line Conducted Emission..... | 20 |
| 4.1.1 Limit..... | 20 |
| 4.1.2 Test Setup..... | 20 |
| 4.1.3 Test Procedure..... | 20 |
| 4.1.4 Test Data..... | 21 |
| 4.2 Emissions in restricted frequency bands..... | 24 |
| 4.2.1 Limit..... | 24 |
| 4.2.2 Test Setup..... | 26 |
| 4.2.3 Test Procedure..... | 27 |
| 4.2.4 Test Data..... | 28 |
| 4.3 Emissions in non-restricted frequency band..... | 48 |
| 4.3.1 Limit..... | 48 |

| | | |
|-------|--|----|
| 4.3.2 | Test Setup..... | 48 |
| 4.3.3 | Test Procedure..... | 48 |
| 4.3.4 | Test Data..... | 49 |
| 4.4 | Duty cycle..... | 50 |
| 4.4.1 | Limit..... | 50 |
| 4.4.2 | Test Setup..... | 50 |
| 4.4.3 | Test Procedure..... | 50 |
| 4.4.4 | Test Data..... | 51 |
| 4.5 | Radiated Emission Band Edge..... | 52 |
| 4.5.1 | Limit..... | 52 |
| 4.5.2 | Test Setup..... | 52 |
| 4.5.3 | Test Procedure..... | 53 |
| 4.5.4 | Test Data..... | 54 |
| 4.6 | DTS Bandwidth..... | 78 |
| 4.6.1 | Limit..... | 78 |
| 4.6.2 | Test Setup..... | 78 |
| 4.6.3 | Test Procedure..... | 78 |
| 4.6.4 | Test Data..... | 79 |
| 4.7 | Fundamental emission output power..... | 80 |
| 4.7.1 | Limit..... | 80 |
| 4.7.2 | Test Setup..... | 80 |
| 4.7.3 | Test Procedure..... | 81 |
| 4.7.4 | Test Data..... | 82 |
| 4.8 | Power Density..... | 83 |
| 4.8.1 | Limit..... | 83 |
| 4.8.2 | Test Setup..... | 83 |
| 4.8.3 | Test Procedure..... | 83 |
| 4.8.4 | Test Data..... | 84 |
| 4.9 | Antenna Requirement..... | 85 |
| 4.9.1 | Limit..... | 85 |
| 4.9.2 | Antenna Connector Construction..... | 85 |
| 4.10 | Test setup photo and EUT Photo..... | 86 |

COMPETENCES AND GUARANTEES

DEKRA is a testing laboratory competent to carry out the tests described in this report.

In order to assure the traceability to other national and international laboratories, DEKRA has a calibration and maintenance program for its measurement equipment.

DEKRA guarantees the reliability of the data presented in this report, which is the result of the measurements and the tests performed to the item under test on the date and under the conditions stated in the report and it is based on the knowledge and technical facilities available at DEKRA at the time of performance of the test.

DEKRA is liable to the client for the maintenance of the confidentiality of all information related to the item under test and the results of the test.

The results presented in this Test Report apply only to the particular item under test established in this document.

IMPORTANT: No parts of this report may be reproduced or quoted out of context, in any form or by any means, except in full, without the previous written permission of DEKRA.

GENERAL CONDITIONS

1. This report is only referred to the item that has undergone the test.
2. This report does not constitute or imply on its own an approval of the product by the Certification Bodies or Competent Authorities.
3. This document is only valid if complete; no partial reproduction can be made without previous written permission of DEKRA.
4. This test report cannot be used partially or in full for publicity and/or promotional purposes without previous written permission of DEKRA.

ENVIRONMENTAL CONDITIONS

The climatic conditions during the tests are within the limits specified by the manufacturer for the operation of the EUT and the test equipment. The climatic conditions during the tests were within the following limits:

| | |
|-----------------------|---------------|
| Ambient temperature | 15 °C - 35 °C |
| Relative Humidity air | 30% - 60% |

If explicitly required in the basic standard or applied product / product family standard the climatic values are recorded and documented separately in this test report.

POSSIBLE TEST CASE VERDICTS

| | |
|---|-----------------|
| Test case does not apply to test object | N/A |
| Test object does meet requirement | P (Pass) / PASS |
| Test object does not meet requirement | F (Fail) / FAIL |
| Not measured | N/M |

ABBREVIATIONS

For the purposes of the present document, the following abbreviations apply:

| | |
|-------|-------------------------------|
| EUT | : Equipment Under Test |
| QP | : Quasi-Peak |
| CAV | : CISPR Average |
| AV | : Average |
| CDN | : Coupling Decoupling Network |
| SAC | : Semi-Anechoic Chamber |
| OATS | : Open Area Test Site |
| BW | : Bandwidth |
| AM | : Amplitude Modulation |
| PM | : Pulse Modulation |
| HCP | : Horizontal Coupling Plane |
| VCP | : Vertical Coupling Plane |
| U_N | : Nominal voltage |
| T_x | : Transmitter |
| R_x | : Receiver |
| N/A | : Not Applicable |
| N/M | : Not Measured |

DOCUMENT HISTORY

| Report No. | Version | Description | Issued Date |
|-----------------------|---------|--------------------------|-------------|
| 1962179R-RF-US-P06V01 | | Initial issue of report. | 2019-07-26 |
| | | | |
| | | | |
| | | | |
| | | | |
| | | | |
| | | | |
| | | | |
| | | | |

REMARKS AND COMMENTS

1. The equipment under test (EUT) does meet the essential requirements of the stated standard(s)/test(s).
2. These test results on a sample of the device are for the purpose of demonstrating Compliance with Part 15 Subpart C Paragraph 15.247.
3. The test results presented in this report relate only to the object tested..
4. This report shall not be reproduced, except in full, without the written approval of the Issuing CB Testing laboratory.
5. The measurement result is considered in conformance with the requirement if it is within the prescribed limit, It is not necessary to account the uncertainty associated with the measurement result, unless the specification, standard or customer have special requirements.
6. This report is not used for social proof in China (or Mainland China) market.

USED EQUIPMENT

AC Power Line Conducted Emission / TR1(Chamber details)

| Instrument | Manufacturer | Model No. | Serial No. | Cal. Date | Next Cal. Date |
|----------------------------|--------------|-----------|------------|------------|----------------|
| EMI Test Receiver | R&S | ESCI | 100906 | 2019.03.04 | 2020.03.04 |
| Two-Line V-Network | R&S | ENV216 | 101190 | 2019.06.09 | 2020.06.09 |
| Two-Line V-Network | R&S | ENV216 | 101044 | 2019.06.15 | 2020.06.15 |
| Current Probe | R&S | EZ-17 | 100678 | 2019.03.07 | 2020.03.07 |
| 50ohm Termination | SHX | TF2 | 07081402 | 2018.09.08 | 2019.09.08 |
| 50ohm Termination | SHX | TF2 | 07081403 | 2018.09.08 | 2019.09.08 |
| 50ohm Coaxial Switch | Anritsu | MP59B | 6200464462 | N/A | N/A |
| Temperature/Humidity Meter | RTS | RTS-8S | TR1-TH | 2019.01.09 | 2020.01.09 |
| Coaxial Cable | Suhner | RG 223 | TR1-C1 | 2018.09.11 | 2019.09.11 |
| Coaxial Cable | Suhner | RG 223 | TR1-C2 | 2018.09.11 | 2019.09.11 |
| Dekra test software | | | | | |

RF conducted test / TR8(Chamber details)

| Instrument | Manufacturer | Model No. | Serial No. | Cal. Date | Next Cal. Date |
|---------------------------|--------------|-----------|------------|------------|----------------|
| Spectrum Analyzer | Agilent | N9010A | MY48030494 | 2019.02.04 | 2020.02.03 |
| EXA Spectrum Analyzer | Keysight | N9010A | MY55370495 | 2019.04.09 | 2020.04.08 |
| MXA Signal Analyzer | Keysight | N9020A | MY56060147 | 2019.04.09 | 2020.04.08 |
| Wideband Peak Power Meter | Anritsu | ML2495A | 0905006 | 2018.10.14 | 2019.10.13 |
| Power Sensor | Anritsu | MA2411B | 0846014 | 2018.10.14 | 2019.10.13 |
| Dekra test software | | | | | |

Radiated Emission(30MHz-1GHz) / AC2(Chamber details)

| Instrument | Manufacturer | Model No. | Serial No. | Cal. Date | Next Cal. Date |
|----------------------------|--------------|-----------|------------|------------|----------------|
| EMI Test Receiver | R&S | ESCI | 100573 | 2019.03.04 | 2020.03.04 |
| Bilog Antenna | Teseq GmbH | CBL6112D | 27611 | 2019.06.09 | 2020.06.09 |
| Temperature/Humidity Meter | RTS | RTS-8S | AC2-TH | 2019.01.09 | 2020.01.09 |
| Coaxial Cable | Huber+Suhner | RG 214 | AC2-C | 2019.02.28 | 2020.02.28 |
| Dekra test software | | | | | |

Radiated Emission / AC5(1GHz-40GHz)(Chamber details)

| Instrument | Manufacturer | Model No. | Serial No. | Cal. Date | Next Cal. Date |
|-------------------------------|--------------|-----------------|-------------|------------|----------------|
| Spectrum Analyzer | Agilent | E4446A | MY45300103 | 2019.01.04 | 2020.01.03 |
| Preamplifier | Miteq | NSP1800-25 | 1364185 | 2019.05.06 | 2020.05.05 |
| Preamplifier | QuieTek | AP-040G | CHM-0906001 | 2019.05.06 | 2020.05.05 |
| DRG Horn | ETS-Lindgren | 3117 | 00123988 | 2019.01.22 | 2020.01.21 |
| Temperature/Humidity Meter | Zhichen | ZC1-2 | AC5-TH | 2019.01.04 | 2020.01.03 |
| Coaxial Cable | Huber+Suhner | SUCOFLEX 106 | AC5-C1 | 2019.03.02 | 2020.03.01 |
| Coaxial Cable | Huber+Suhner | SUCOFLEX 106 | AC5-C2 | 2019.03.02 | 2020.03.01 |
| Coaxial Cable | Huber+Suhner | SUCOFLEX 102 | AC5-C3 | 2019.03.02 | 2020.03.01 |
| Dekra test software | | | | | |

UNCERTAINTY

Uncertainties have been calculated according to the DEKRA internal document. The reported expanded uncertainties are based on a standard uncertainty multiplied by a coverage factor of $k=2$, providing a level of confidence of approximately 95%

| Test item | Uncertainty |
|----------------------------------|----------------------|
| AC Power Line Conducted Emission | $\pm 2.02\text{dB}$ |
| Peak Power Output | $\pm 1.27\text{ dB}$ |
| Radiated Emission(30MHz~1GHz) | $\pm 3.80\text{ dB}$ |
| Radiated Emission(1GHz~26.5GHz) | $\pm 3.90\text{ dB}$ |
| RF antenna conducted test | $\pm 1.27\text{dB}$ |
| Radiated Emission Band Edge | $\pm 3.9\text{ dB}$ |
| DTS Bandwidth | $\pm 1\text{kHz}$ |
| Occupied Bandwidth | $\pm 1\text{kHz}$ |
| Power Density | $\pm 1.27\text{dB}$ |

1 GENERAL INFORMATION

1.1 General Description of the Item(s)

| | |
|----------------------------|---|
| Model / Type number.....: | KWFP-220-WF |
| Trademark.....: | KylaS |
| Manufacturer.....: | Aztech Technologies Pte Ltd |
| Manufacturer Address.....: | 31 Ubi Road 1, Aztech Building Singapore 408694 |

| | |
|------------------------------------|--|
| Wireless specification.....: | WIFI |
| Operating frequency range(s).....: | 2400~2483.5MHz |
| Type of modulation.....: | DSSS: BPSK,QPSK,CCK OFDM: BPSK, QPSK, 16QAM, 64QAM |
| Number of channel.....: | 802.11b/g/n(20MHz): 11 |
| Device category.....: | <input type="checkbox"/> Fixed point-to-point |
| | <input type="checkbox"/> Emit multiple directional beams, simultaneously or sequentially |
| | <input checked="" type="checkbox"/> Other cases |

| | | |
|--------------------------|-------------------------------------|---|
| Rated power supply.....: | Voltage and Frequency | |
| | <input type="checkbox"/> | AC: 220 - 240 V, 50/60 Hz |
| | <input type="checkbox"/> | AC: 100 - 240 V, 50/60 Hz |
| | <input type="checkbox"/> | DC: 12 V, 24 V, 12 / 24 V |
| | <input checked="" type="checkbox"/> | Rated voltage: 100-120Vac 60Hz Rated input: 1100W(Max. Load) |
| Mounting position.....: | <input type="checkbox"/> | Table top equipment |
| | <input type="checkbox"/> | Wall/Ceiling mounted equipment |
| | <input type="checkbox"/> | Floor standing equipment |
| | <input type="checkbox"/> | Hand-held equipment |
| | <input checked="" type="checkbox"/> | Other: |

1.2 Antenna Information

| | | | |
|------------------------------------|-------------------------------------|--------------|---|
| Antenna model / type number..... : | N/A | | |
| Antenna serial number..... : | N/A | | |
| Antenna Delivery | <input checked="" type="checkbox"/> | 1TX + 1RX | |
| | <input type="checkbox"/> | 2TX + 2RX | |
| | <input type="checkbox"/> | Others:..... | |
| Antenna technology..... : | <input checked="" type="checkbox"/> | SISO | |
| | <input type="checkbox"/> | MIMO | <input type="checkbox"/> Basic |
| | | | <input type="checkbox"/> CDD |
| | | | <input type="checkbox"/> Sectorized |
| | | | <input type="checkbox"/> Beam-forming |
| Antenna Type..... : | <input type="checkbox"/> | External | <input type="checkbox"/> Dipole |
| | | | <input type="checkbox"/> Sectorized |
| | | | <input type="checkbox"/> PIFA |
| | <input checked="" type="checkbox"/> | Internal | <input checked="" type="checkbox"/> PCB |
| | | | <input type="checkbox"/> Others..... |
| Antenna Gain..... : | 2dBi | | |
| Directional Gain..... : | For Power: N/A | | |
| | For PSD: N/A | | |

1.3 Test date

| | |
|----------------------|--|
| Test Location | No. 99, Hongye Road, Suzhou Industrial Park Suzhou, 215006, P.R. China |
| Date(receive sample) | Jun. 28, 2019 |
| Date (start test) | Jun. 28, 2019 |
| Date (finish test) | Jul. 26, 2019 |

1.4 Data Rate

IEEE 802.11b

| Modulation | Data Rate(Mb/s) |
|------------|-----------------|
| DSSS | 1 |
| DSSS | 2 |
| CCK | 5.5 |
| CCK | 11 |

Table 1 –TX Antenna number = 1

IEEE 802.11g

| Modulation | R | Data Rate(Mb/s) |
|------------|-----|-----------------|
| BPSK | 1/2 | 6 |
| BPSK | 3/4 | 9 |
| QPSK | 1/2 | 12 |
| QPSK | 3/4 | 18 |
| 16-QAM | 1/2 | 24 |
| 16-QAM | 3/4 | 36 |
| 64-QAM | 2/3 | 48 |
| 64-QAM | 3/4 | 54 |

Table 1 – MCS parameters for TX Antenna number = 1

IEEE 802.11n

| Spatial streames | MCS Index | Modulation | R | Data Rate(Mb/s) | | | |
|------------------|-----------|------------|-----|-----------------|-------|----------|-------|
| | | | | 800ns GI | | 400ns GI | |
| | | | | 20MHz | 40MHz | 20MHz | 40MHz |
| 1 | 0 | BPSK | 1/2 | 6.5 | 13.5 | 7.2 | 15.0 |
| 1 | 1 | QPSK | 1/2 | 13.0 | 27.0 | 14.4 | 30.0 |
| 1 | 2 | QPSK | 3/4 | 19.5 | 40.5 | 21.7 | 45.0 |
| 1 | 3 | 16-QAM | 1/2 | 26.0 | 54.0 | 28.9 | 60.0 |
| 1 | 4 | 16-QAM | 3/4 | 39.0 | 81.0 | 43.3 | 90.0 |
| 1 | 5 | 64-QAM | 2/3 | 52.0 | 108.0 | 57.8 | 120.0 |
| 1 | 6 | 64-QAM | 3/4 | 58.5 | 121.5 | 65.0 | 135.0 |
| 1 | 7 | 64-QAM | 5/6 | 65.0 | 135.0 | 72.2 | 150.0 |

Note 1: Support of 400ns GI is optional on transmit and receive.

Table 1 – MCS parameters for TX Antenna number = 1

1.5 Channel List

IEEE 802.11b/g & IEEE 802.11n(20MHz)

| Working Frequency of Each Channel | | | | | | | |
|-----------------------------------|-----------|---------|-----------|---------|-----------|---------|-----------|
| Channel | Frequency | Channel | Frequency | Channel | Frequency | Channel | Frequency |
| 001 | 2412 MHz | 002 | 2417 MHz | 003 | 2422 MHz | 004 | 2427 MHz |
| 005 | 2432 MHz | 006 | 2437 MHz | 007 | 2442 MHz | 008 | 2447 MHz |
| 009 | 2452 MHz | 010 | 2457 MHz | 011 | 2462 MHz | - | - |

2 DESCRIPTION OF TEST SETUP

2.1 Operating mode(s) used for tests

During the tests the following operating mode(s) has(have) been used.

| | |
|-----------|------------------------------------|
| Test Mode | Mode 1: Transmit by 802.11b |
| | Mode 2: Transmit by 802.11g |
| | Mode 3: Transmit by 802.11n(20MHz) |

2.2 Support / Auxiliary equipment / unit / Test software for the EUT

The EUT has been tested with the following auxiliary equipment / unit / software:

| Auxiliary equipment | Type / Version | Manufacturer | Supplied by |
|----------------------------------|----------------|--------------|-------------|
| Notebook | Think pad x220 | Lenovo | Adapter |
| | | | |
| unit / software | Type / Version | Manufacturer | Supplied by |
| | | | |
| | | | |
| software | Type / Version | Manufacturer | Supplied by |
| | | | |
| <u>Supplemental information:</u> | | | |

2.3 Test Configuration / Block diagram used for tests

The following test setup / configuration / block diagram has been used during the tests:

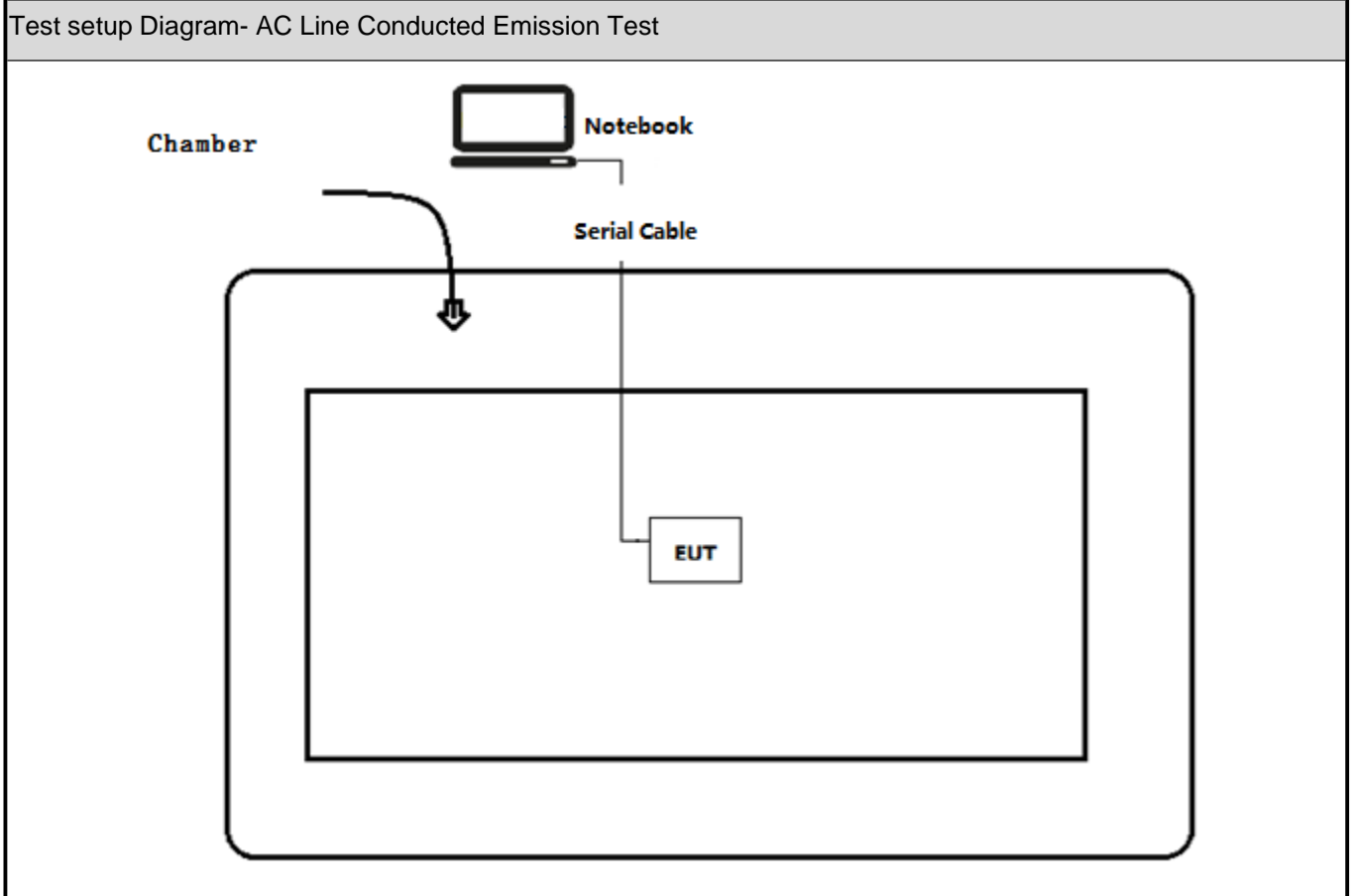
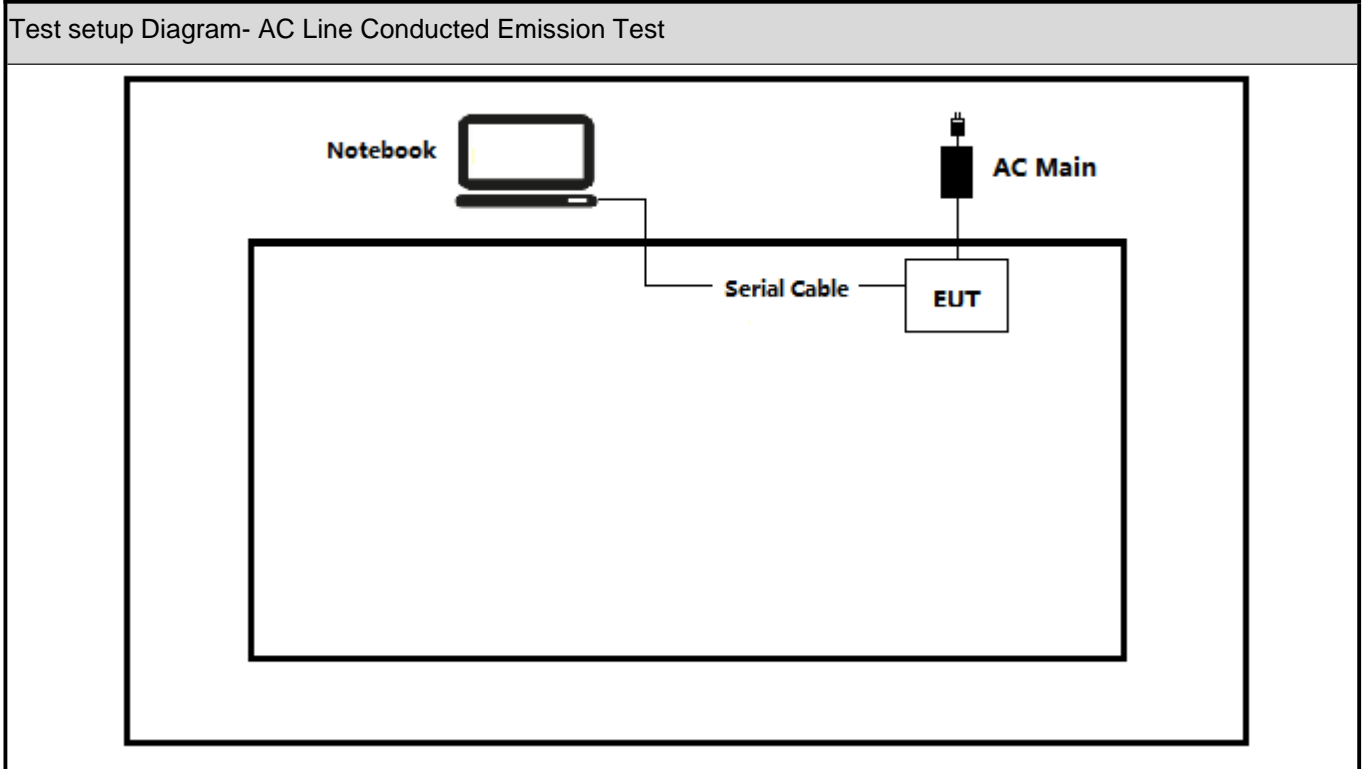

Test setup Diagram- Conducted test

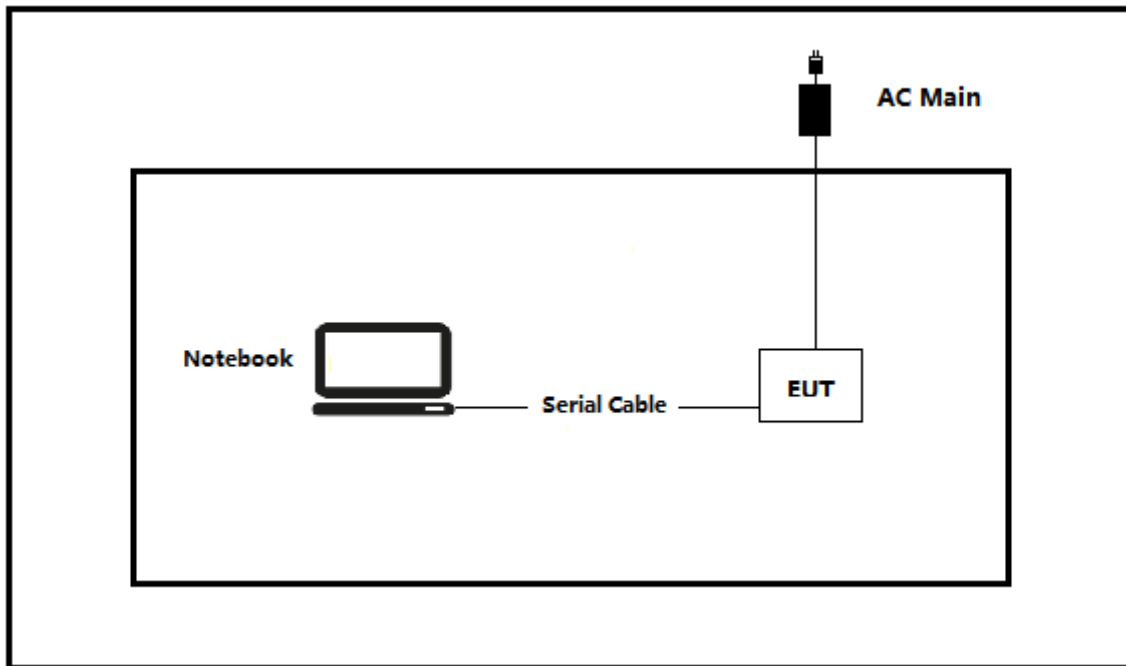

2.4 Testing process

| | |
|---|---|
| 1 | Setup the EUT as shown in Section 2.4. |
| 2 | Input the commands. |
| 3 | Configure the test mode, the test channel, and the data rate. |
| 4 | Start the continuous Transmitter. |
| 5 | Verify that the EUT works properly. |

3 VERDICT SUMMARY SECTION

This chapter presents an overview of standards and results. Refer to the next chapters for details of measured test results and applied test levels.

3.1 Standards

| Standard | Year | Description |
|---|------|---|
| FCC CFR Title 47 Part 15 Subpart C Section 15.247 | 2019 | Operation within the bands 902 – 928 MHz, 2400 – 2483.5 MHz, and 5725 – 5850 MHz. |
| ANSI C63.10 | 2013 | American National Standard of Procedures for Compliance Testing of Unlicensed Wireless Devices |
| KDB 558074 D01V05r02 | 2019 | Guidance for performing compliance measurements on Digital Transmission System (DTS) operating under section 15.247 |

3.2 Overview of results

| Requirement – Test case | Basic standard(s) | Verdict | Remark |
|---|---------------------------|---------|--------|
| AC Power Line Conducted Emission | FCC 15.207 | PASS | --- |
| Emissions in restricted frequency bands | FCC 15.247(b)(3) | PASS | --- |
| Duty cycle | ANSI C63.10:2013 | N/A | |
| Emissions in non-restricted frequency bands | FCC 15.247(d), FCC 15.209 | PASS | --- |
| Radiated Emission Band Edge | FCC 15.247(d) | PASS | --- |
| Fundamental emission output power | FCC 15.247(d), FCC 15.209 | PASS | --- |
| DTS Bandwidth | FCC 15.247(a)(2) | PASS | --- |
| Power Spectral Density | FCC 15.247(e) | PASS | --- |
| Antenna Requirement | FCC 15.203 | PASS | --- |
| <u>Supplementary information:</u> | | | |

3.3 Test Facility

| | | |
|---------------|----------|---------------------------------------|
| USA | : | FCC Designation Number: CN1199 |
| Canada | : | CAB identifier Number: CN0040 |

4 TEST RESULTS

| | |
|---|----------------------|
| 4.1 AC Power Line Conducted Emission | VERDICT: PASS |
|---|----------------------|

| 4.1.1 Limit | | |
|-----------------------|--|---------------------------------|
| Standard | FCC Part 15 Subpart C Paragraph 15.207 | |
| Frequency range [MHz] | Limit: QP [dB(μV) ¹⁾ | Limit: AV [dB(μV) ¹⁾ |
| 0,15 - 0,50 | 66 - 56 ²⁾ | 56 - 46 ²⁾ |
| 0,50 - 5,0 | 56 | 46 |
| 5,0 - 30 | 60 | 50 |

¹⁾ At the transition frequency, the lower limit applies.
²⁾ The limit decreases linearly with the logarithm of the frequency.

NOTE 1: The exclusion band for transmitters shall be considered for transmitters operating at frequencies below 30 MHz.

NOTE 2: Where the AC output port is directly connected (or via a circuit breaker) to the AC power input port of the EUT the AC power output port need not to be tested.

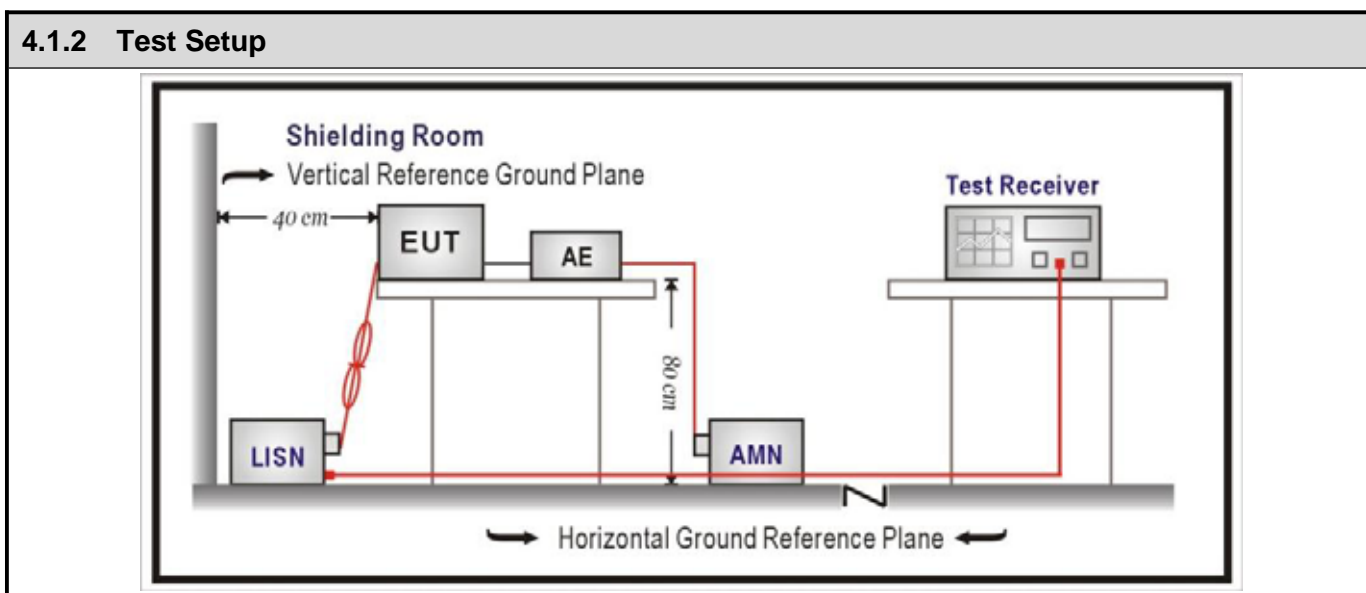

| 4.1.3 Test Procedure | | | |
|-------------------------------------|------------------|---------|---|
| | References Rule | Chapter | Item |
| <input checked="" type="checkbox"/> | ANSI C63.10-2013 | 6.2 | Standard test method for ac power-line conducted emissions from unlicensed wireless devices |

4.1.4 Test Data

| | |
|--|---------------------|
| Site: TR1 | Time: 2019/07/13 |
| Limit: FCC_Part15.107_CE_AC Power_ClassC | Margin: 0 |
| Probe: ENV216_101190(0.009-30MHz) | Polarity: Line |
| EUT: WiFi Plug US | Power: AC 120V/60Hz |
| Note: Mode 1 | |

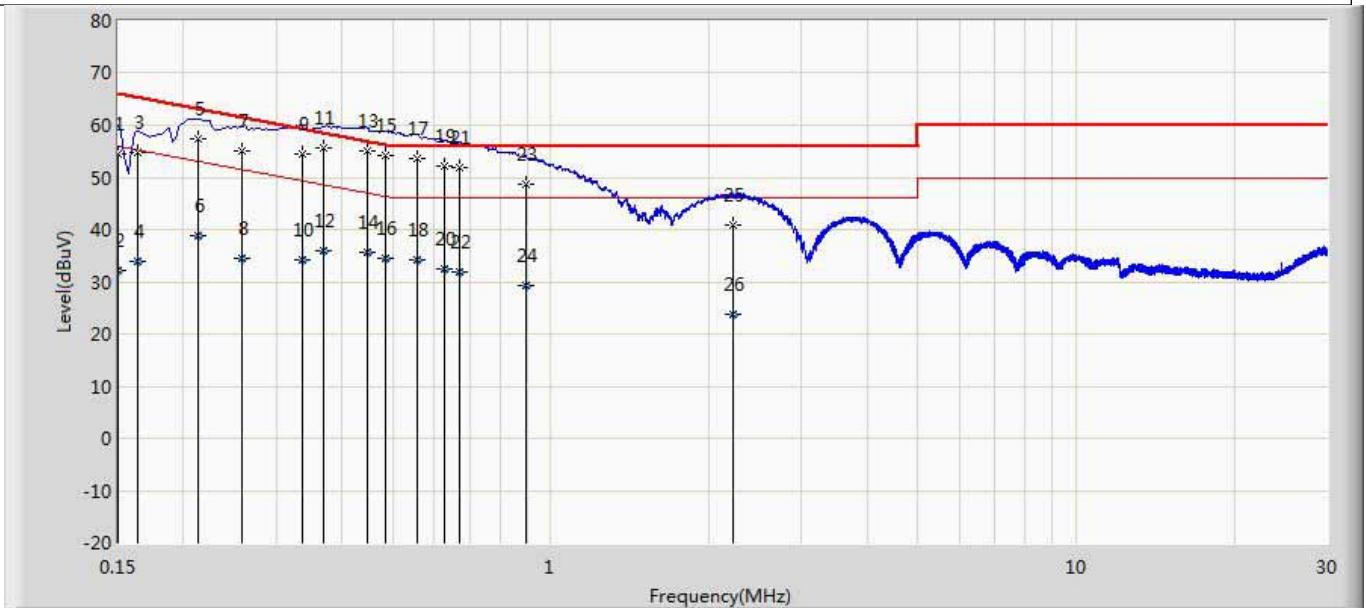

| No | Mark | Frequency (MHz) | Measure Level (dBuV) | Reading Level (dBuV) | Over Limit (dB) | Limit (dBuV) | Probe (dB) | Cable (dB) | Amp (dB) | Type |
|----|------|-----------------|----------------------|----------------------|-----------------|--------------|------------|------------|----------|------|
| 1 | | 0.150 | 54.589 | 44.950 | -11.411 | 66.000 | 9.610 | 0.029 | 0.000 | QP |
| 2 | | 0.150 | 32.084 | 22.445 | -23.916 | 56.000 | 9.610 | 0.029 | 0.000 | AV |
| 3 | | 0.164 | 54.719 | 45.084 | -10.565 | 65.284 | 9.607 | 0.029 | 0.000 | QP |
| 4 | | 0.164 | 33.884 | 24.248 | -21.401 | 55.284 | 9.607 | 0.029 | 0.000 | AV |
| 5 | | 0.213 | 57.281 | 47.651 | -5.807 | 63.088 | 9.600 | 0.029 | 0.000 | QP |
| 6 | | 0.213 | 38.797 | 29.168 | -14.290 | 53.088 | 9.600 | 0.029 | 0.000 | AV |
| 7 | | 0.258 | 55.180 | 45.548 | -6.316 | 61.496 | 9.600 | 0.032 | 0.000 | QP |
| 8 | | 0.258 | 34.493 | 24.861 | -17.002 | 51.496 | 9.600 | 0.032 | 0.000 | AV |
| 9 | | 0.337 | 54.606 | 44.971 | -4.677 | 59.283 | 9.600 | 0.035 | 0.000 | QP |
| 10 | | 0.337 | 34.283 | 24.648 | -15.000 | 49.283 | 9.600 | 0.035 | 0.000 | AV |
| 11 | | 0.370 | 55.665 | 46.029 | -2.824 | 58.490 | 9.600 | 0.037 | 0.000 | QP |
| 12 | | 0.370 | 36.054 | 26.418 | -12.435 | 48.490 | 9.600 | 0.037 | 0.000 | AV |
| 13 | * | 0.447 | 55.047 | 45.406 | -1.884 | 56.931 | 9.600 | 0.041 | 0.000 | QP |
| 14 | | 0.447 | 35.673 | 26.033 | -11.257 | 46.931 | 9.600 | 0.041 | 0.000 | AV |
| 15 | | 0.485 | 54.251 | 44.609 | -1.998 | 56.249 | 9.600 | 0.042 | 0.000 | QP |
| 16 | | 0.485 | 34.623 | 24.981 | -11.626 | 46.249 | 9.600 | 0.042 | 0.000 | AV |
| 17 | | 0.555 | 53.642 | 43.997 | -2.358 | 56.000 | 9.600 | 0.045 | 0.000 | QP |
| 18 | | 0.555 | 34.165 | 24.521 | -11.835 | 46.000 | 9.600 | 0.045 | 0.000 | AV |
| 19 | | 0.629 | 52.104 | 42.456 | -3.896 | 56.000 | 9.600 | 0.048 | 0.000 | QP |
| 20 | | 0.629 | 32.338 | 22.690 | -13.662 | 46.000 | 9.600 | 0.048 | 0.000 | AV |
| 21 | | 0.672 | 51.858 | 42.209 | -4.142 | 56.000 | 9.600 | 0.049 | 0.000 | QP |
| 22 | | 0.672 | 31.956 | 22.307 | -14.044 | 46.000 | 9.600 | 0.049 | 0.000 | AV |
| 23 | | 0.897 | 48.581 | 38.918 | -7.419 | 56.000 | 9.607 | 0.056 | 0.000 | QP |
| 24 | | 0.897 | 29.317 | 19.655 | -16.683 | 46.000 | 9.607 | 0.056 | 0.000 | AV |

| | | | | | | | | | | |
|----|--|-------|--------|--------|---------|--------|-------|-------|-------|----|
| 25 | | 2.220 | 40.821 | 31.115 | -15.179 | 56.000 | 9.614 | 0.093 | 0.000 | QP |
| 26 | | 2.220 | 23.665 | 13.958 | -22.335 | 46.000 | 9.614 | 0.093 | 0.000 | AV |

| | |
|--|---------------------|
| Site: TR1 | Time: 2019/07/13 |
| Limit: FCC_Part15.107_CE_AC Power_ClassC | Margin: 0 |
| Probe: ENV216_101190(0.009-30MHz) | Polarity: Neutral |
| EUT: WiFi Plug US | Power: AC 120V/60Hz |
| Note: Mode 1 | |

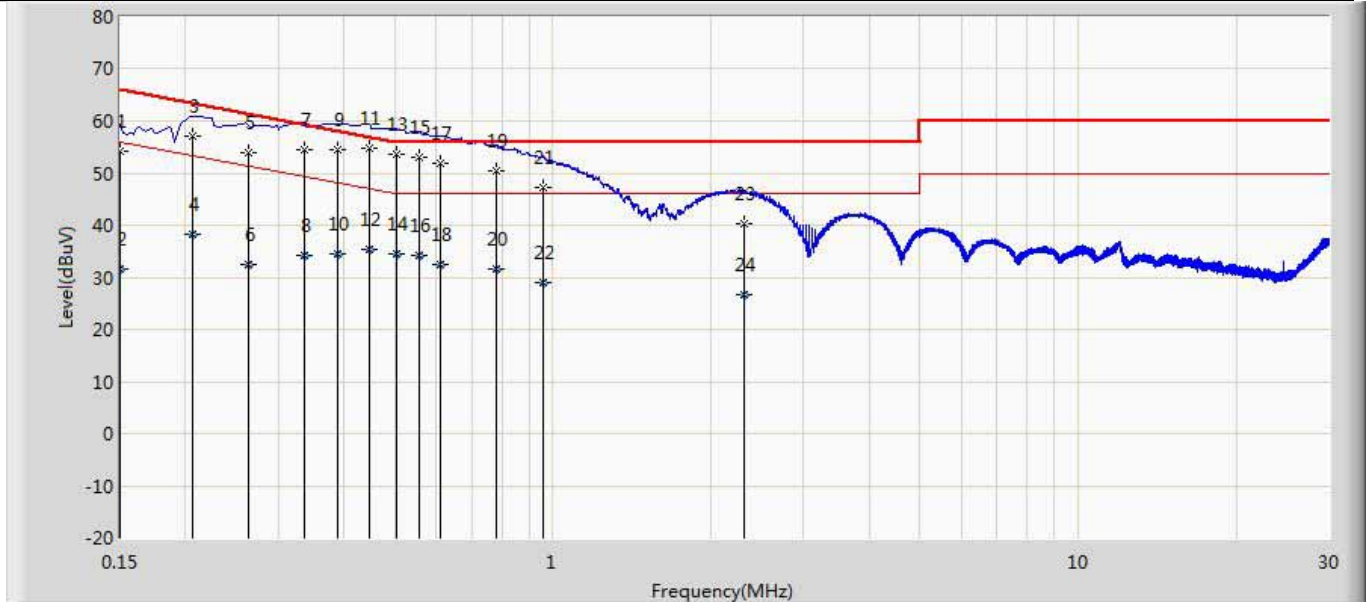

| No | Mark | Frequency (MHz) | Measure Level (dBuV) | Reading Level (dBuV) | Over Limit (dB) | Limit (dBuV) | Probe (dB) | Cable (dB) | Amp (dB) | Type |
|----|------|-----------------|----------------------|----------------------|-----------------|--------------|------------|------------|----------|------|
| 1 | | 0.150 | 54.231 | 44.608 | -11.769 | 66.000 | 9.594 | 0.029 | 0.000 | QP |
| 2 | | 0.150 | 31.591 | 21.968 | -24.409 | 56.000 | 9.594 | 0.029 | 0.000 | AV |
| 3 | | 0.206 | 56.996 | 47.368 | -6.359 | 63.355 | 9.599 | 0.029 | 0.000 | QP |
| 4 | | 0.206 | 38.257 | 28.630 | -15.097 | 53.355 | 9.599 | 0.029 | 0.000 | AV |
| 5 | | 0.263 | 54.023 | 44.394 | -7.329 | 61.352 | 9.598 | 0.032 | 0.000 | QP |
| 6 | | 0.263 | 32.430 | 22.800 | -18.922 | 51.352 | 9.598 | 0.032 | 0.000 | AV |
| 7 | | 0.337 | 54.546 | 44.916 | -4.737 | 59.283 | 9.595 | 0.035 | 0.000 | QP |
| 8 | | 0.337 | 34.163 | 24.533 | -15.120 | 49.283 | 9.595 | 0.035 | 0.000 | AV |
| 9 | | 0.389 | 54.499 | 44.868 | -3.597 | 58.096 | 9.593 | 0.038 | 0.000 | QP |
| 10 | | 0.389 | 34.476 | 24.844 | -13.620 | 48.096 | 9.593 | 0.038 | 0.000 | AV |
| 11 | * | 0.447 | 54.778 | 45.145 | -2.153 | 56.931 | 9.591 | 0.041 | 0.000 | QP |
| 12 | | 0.447 | 35.447 | 25.815 | -11.484 | 46.931 | 9.591 | 0.041 | 0.000 | AV |
| 13 | | 0.503 | 53.695 | 44.060 | -2.305 | 56.000 | 9.590 | 0.044 | 0.000 | QP |
| 14 | | 0.503 | 34.499 | 24.864 | -11.501 | 46.000 | 9.590 | 0.044 | 0.000 | AV |
| 15 | | 0.555 | 52.974 | 43.340 | -3.026 | 56.000 | 9.590 | 0.045 | 0.000 | QP |
| 16 | | 0.555 | 34.166 | 24.532 | -11.834 | 46.000 | 9.590 | 0.045 | 0.000 | AV |
| 17 | | 0.609 | 51.983 | 42.346 | -4.017 | 56.000 | 9.590 | 0.047 | 0.000 | QP |
| 18 | | 0.609 | 32.586 | 22.949 | -13.414 | 46.000 | 9.590 | 0.047 | 0.000 | AV |
| 19 | | 0.782 | 50.488 | 40.846 | -5.512 | 56.000 | 9.590 | 0.052 | 0.000 | QP |
| 20 | | 0.782 | 31.515 | 21.873 | -14.485 | 46.000 | 9.590 | 0.052 | 0.000 | AV |
| 21 | | 0.958 | 47.154 | 37.505 | -8.846 | 56.000 | 9.590 | 0.059 | 0.000 | QP |
| 22 | | 0.958 | 28.967 | 19.318 | -17.033 | 46.000 | 9.590 | 0.059 | 0.000 | AV |
| 23 | | 2.317 | 40.362 | 30.653 | -15.638 | 56.000 | 9.614 | 0.095 | 0.000 | QP |
| 24 | | 2.317 | 26.628 | 16.919 | -19.372 | 46.000 | 9.614 | 0.095 | 0.000 | AV |

| | |
|--------|---|
| Remark | 1. " * ", means this data is the worst emission level. 2. Measurement Level = Reading Level + Factor(Probe+Cable-Amp). |
|--------|---|

| | |
|--|----------------------|
| 4.2 Emissions in restricted frequency bands | VERDICT: PASS |
|--|----------------------|

| 4.2.1 Limit | | | |
|-------------------------------|-----------------------|--|--------------------|
| Standard | | FCC Part 15 Subpart C Paragraph 15.207 | |
| Restricted Bands of operation | | | |
| Frequency (MHz) | Frequency (MHz) | Frequency (MHz) | Frequency (GHz) |
| 0.090 – 0.110 | 16.42 – 16.423 | 399.9 – 410 | 4.5 – 5.15 |
| 0.495 – 0.505 | 16.69475 – 16.69525 | 608 – 614 | 5.35 – 5.46 |
| 2.1735 – 2.1905 | 16.80425 – 16.80475 | 960 – 1240 | 7.25 – 7.75 |
| 4.125 – 4.128 | 25.5 – 25.67 | 1300 – 1427 | 8.025 – 8.5 |
| 4.17725 – 4.17775 | 37.5 – 38.25 | 1435 – 1626.5 | 9.0 – 9.2 |
| 4.20725 – 4.20775 | 73 – 74.6 | 1645.5 – 1646.5 | 9.3 – 9.5 |
| 6.215 – 6.218 | 74.8 – 75.2 | 1660 – 1710 | 10.6 – 12.7 |
| 6.26775 – 6.26825 | 108 – 121.94 | 1718.8 – 1722.2 | 13.25 – 13.4 |
| 6.31175 – 6.31225 | 123 – 138 | 2200 – 2300 | 14.47 – 14.5 |
| 8.291 – 8.294 | 149.9 – 150.05 | 2310 – 2390 | 15.35 – 16.2 |
| 8.362 – 8.366 | 156.52475 – 156.52525 | 2483.5 – 2500 | 17.7 – 21.4 |
| 8.37625 – 8.38675 | 156.7 – 156.9 | 2690 – 2900 | 22.01 – 23.12 |
| 8.81425 – 8.81475 | 162.0125 – 167.17 | 3260 – 3267 | 23.6 – 24.0 |
| 12.29 – 12.293 | 167.72 – 173.2 | 3332 – 3339 | 31.2 – 31.8 |
| 12.51975 – 12.52025 | 240 – 285 | 3345.8 – 3358 | 36.43 – 36.5 |
| 12.57675 – 12.57725 | 322 – 335.4 | 3600 – 4400 | |
| 13.36 – 13.41 | | | |

| Restricted Band Emissions Limit | | | |
|---------------------------------|-----------------------------|-------------------------------|--------------------------|
| Frequency (MHz) | Field strength (μ V/m) | Field strength (dB μ V/m) | Measurement distance (m) |
| 0.009 - 0.49 | 2400/F(kHz) | 48.5 – 13.8 | 300 _(Note 1) |
| 0.49 - 1.705 | 24000/F(kHz) | 33.8 - 23 | 30 _(Note 1) |
| 1.705 - 30 | 30 | 29.5 | 30 _(Note 1) |
| 30 - 88 | 100 | 40 | 3 _(Note 2) |
| 88 - 216 | 150 | 43.5 | 3 _(Note 2) |
| 216 - 960 | 200 | 46 | 3 _(Note 2) |
| Above 960 | 500 | 54 | 3 _(Note 2) |

Note 1: At frequencies below 30 MHz, measurements may be performed at a distance closer than that specified in the regulations; however, an attempt should be made to avoid making measurements in the near field. Pending the development of an appropriate measurement procedure for measurements performed below 30 MHz, when performing measurements at a closer distance than specified, the results shall be extrapolated to the specified distance by either making measurements at a minimum of two distances on at least one radial to determine the proper extrapolation factor or by using the square of an inverse linear distance extrapolation factor (40 dB/decade).

Note 2: At frequencies at or above 30 MHz, measurements may be performed at a distance other than what is specified provided: measurements are not made in the near field except where it can be shown that near field measurements are appropriate due to the characteristics of the device; and it can be demonstrated that the signal levels needed to be measured at the distance employed can be detected by the measurement equipment. Measurements shall not be performed at a distance greater than 30 meters unless it can be further demonstrated that measurements at a distance of 30 meters or less are impractical. When performing measurements at a distance other than that specified, the results shall be extrapolated to the specified distance using an extrapolation factor of 20 dB/decade (inverse linear-distance for field strength measurements; inverse-linear-distance-squared for power density measurements).

4.2.2 Test Setup

Below 30MHz Test Setup:

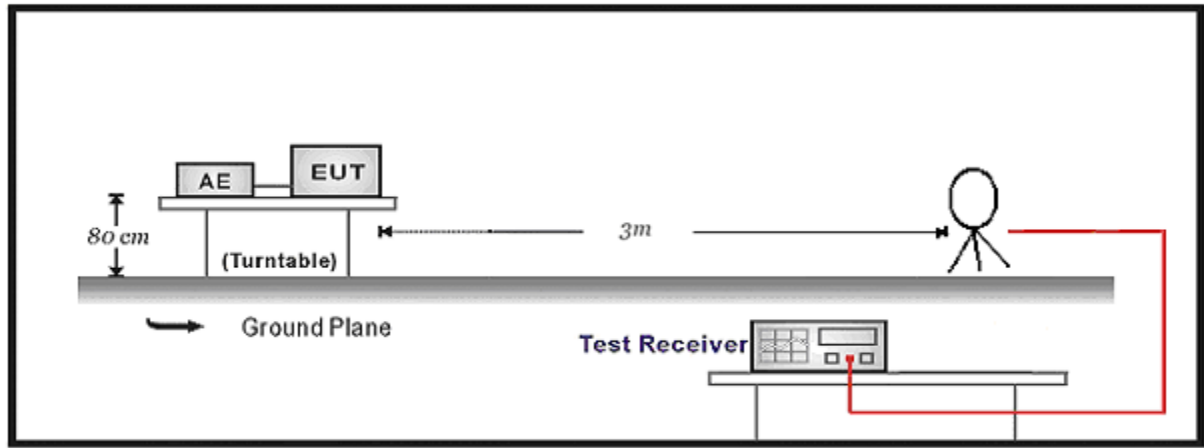

30MHz-1GHz Test Setup:

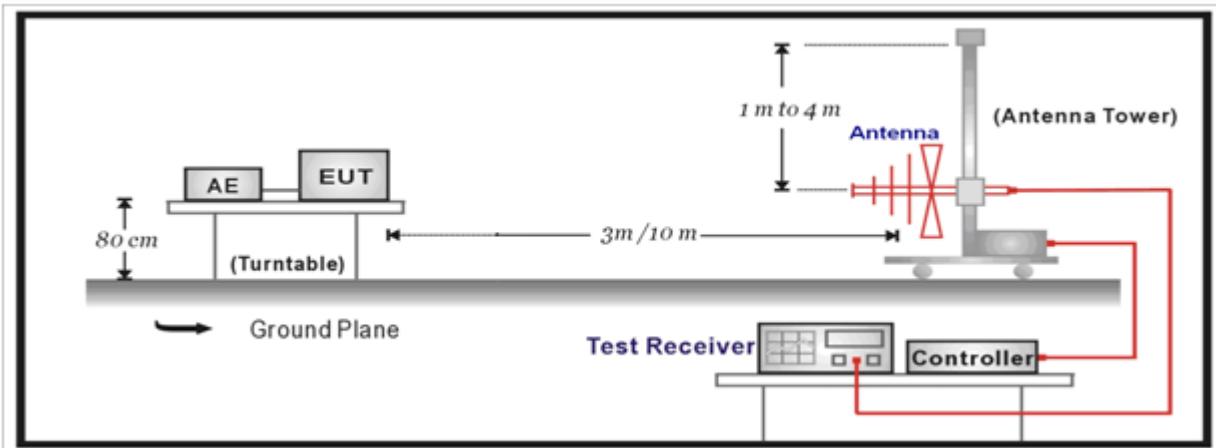

Above 1GHz Test Setup:

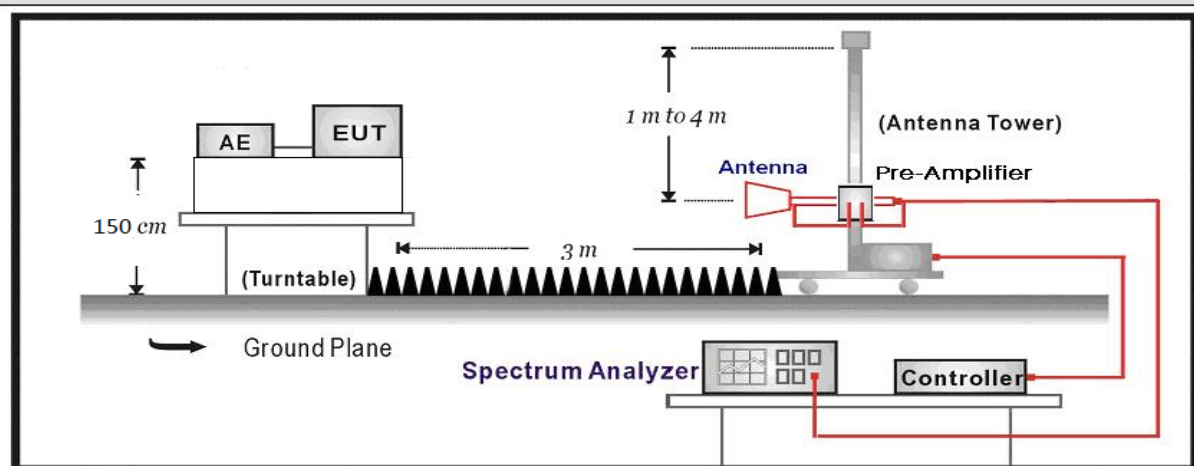

| 4.2.3 Test Procedure | | | |
|-------------------------------------|---|-------------|--|
| | References Rule | Chapter | Description |
| <input checked="" type="checkbox"/> | ANSI C63.10 | 11.12 | Emissions in restricted frequency bands |
| | <input checked="" type="checkbox"/> ANSI C63.10 | 11.12.1 | Radiated emission measurements |
| | <input checked="" type="checkbox"/> ANSI C63.10 | 11.12.2.7 | Radiated spurious emission test |
| | <input checked="" type="checkbox"/> ANSI C63.10 | 6.4 | Radiated emissions from unlicensed wireless devices below 30 MHz |
| | <input checked="" type="checkbox"/> ANSI C63.10 | 6.5 | Radiated emissions from unlicensed wireless devices in the frequency range of 30 MHz to 1000 MHz |
| | <input checked="" type="checkbox"/> ANSI C63.10 | 6.6 | Radiated emissions from unlicensed wireless devices above 1 GHz |
| | <input type="checkbox"/> ANSI C63.10 | 11.12.2 | Antenna-port conducted measurements |
| | <input type="checkbox"/> ANSI C63.10 | 11.12.2.3 | Quasi-peak measurement procedure |
| | <input type="checkbox"/> ANSI C63.10 | 11.12.2.4 | Peak power measurement procedure |
| | <input type="checkbox"/> ANSI C63.10 | 11.12.2.5 | Average power measurement procedures |
| | <input type="checkbox"/> ANSI C63.10 | 11.12.2.5.1 | Trace averaging with continuous EUT transmission at full power |
| | <input type="checkbox"/> ANSI C63.10 | 11.12.2.5.2 | Trace averaging across ON and OFF times of the EUT transmissions followed by duty cycle correction |
| | <input type="checkbox"/> ANSI C63.10 | 11.12.2.5.3 | Reduced VBW averaging across ON and OFF times of the EUT transmissions with max hold |

4.2.4 Test Data

| | |
|---|--------------------------|
| Engineer: Yingfei Wang | |
| Site: AC5 | Time: 2019/07/18 - 11:18 |
| Limit: FCC_Part15.209_RE(3m) | Margin: 0 |
| Probe: Horn_3117_00167055(1-18GHz) | Polarity: Vertical |
| EUT: WiFi Plug US | Power: AC 120V/60Hz |
| Note: Mode 1:Transmit at 2412MHz by 802.11b | |

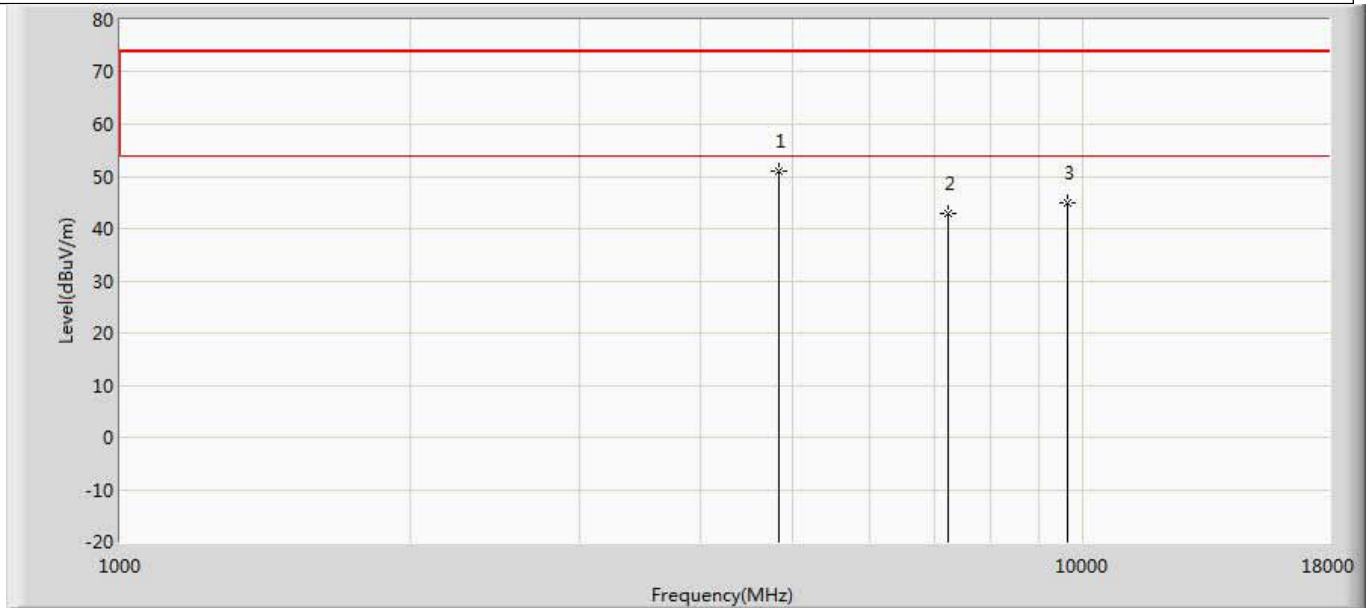

| No | Mark | Frequency (MHz) | Measure Level (dBuV/m) | Reading Level (dBuV) | Over Limit (dB) | Limit (dBuV/m) | Factor (dB) | Type |
|----|------|-----------------|------------------------|----------------------|-----------------|----------------|-------------|------|
| 1 | * | 4825.000 | 50.925 | 46.445 | -23.075 | 74.000 | 4.480 | PK |
| 2 | | 7236.000 | 42.832 | 35.142 | -31.168 | 74.000 | 7.689 | PK |
| 3 | | 9648.000 | 44.828 | 35.268 | -29.172 | 74.000 | 9.560 | PK |

| | |
|---|--------------------------|
| Engineer: Yingfei Wang | |
| Site: AC5 | Time: 2019/07/18 - 11:18 |
| Limit: FCC_Part15.209_RE(3m) | Margin: 0 |
| Probe: Horn_3117_00167055(1-18GHz) | Polarity: Horizontal |
| EUT: WiFi Plug US | Power: AC 120V/60Hz |
| Note: Mode 1:Transmit at 2412MHz by 802.11b | |

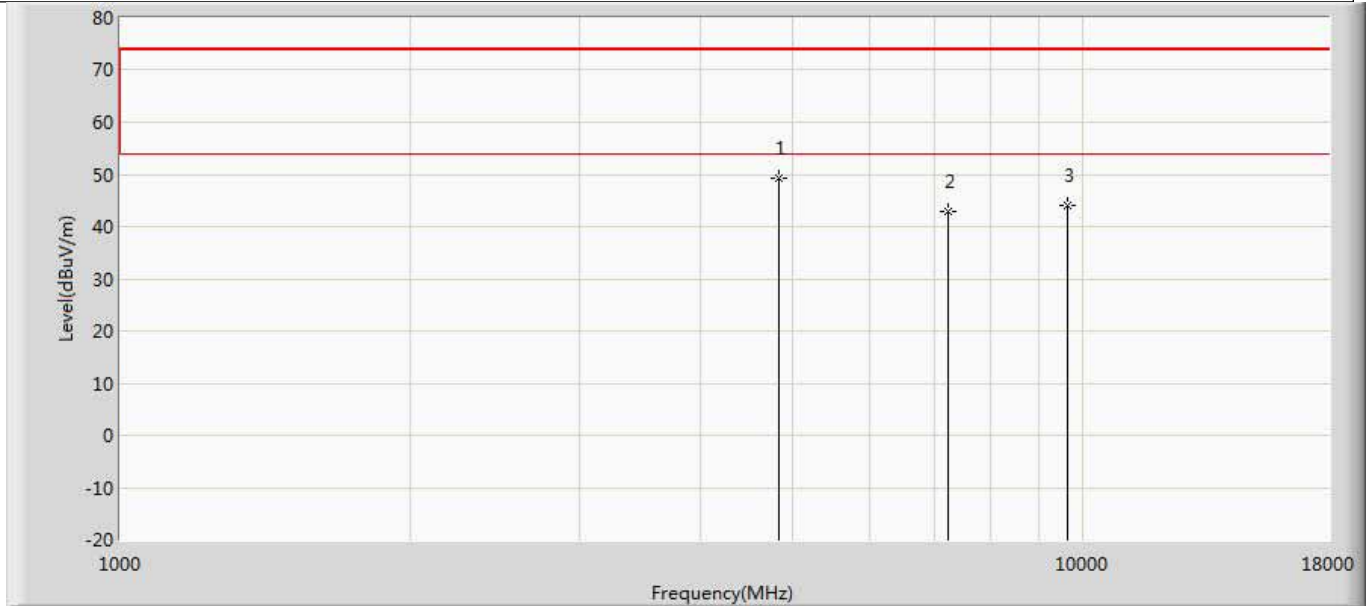

| No | Mark | Frequency (MHz) | Measure Level (dBuV/m) | Reading Level (dBuV) | Over Limit (dB) | Limit (dBuV/m) | Factor (dB) | Type |
|----|------|-----------------|------------------------|----------------------|-----------------|----------------|-------------|------|
| 1 | * | 4825.000 | 49.195 | 44.715 | -24.805 | 74.000 | 4.480 | PK |
| 2 | | 7236.000 | 42.968 | 35.278 | -31.032 | 74.000 | 7.689 | PK |
| 3 | | 9648.000 | 43.998 | 34.438 | -30.002 | 74.000 | 9.560 | PK |

| | |
|---|--------------------------|
| Engineer: Yingfei Wang | |
| Site: AC5 | Time: 2019/07/18 - 11:19 |
| Limit: FCC_Part15.209_RE(3m) | Margin: 0 |
| Probe: Horn_3117_00167055(1-18GHz) | Polarity: Vertical |
| EUT: WiFi Plug US | Power: AC 120V/60Hz |
| Note: Mode 1:Transmit at 2437MHz by 802.11b | |

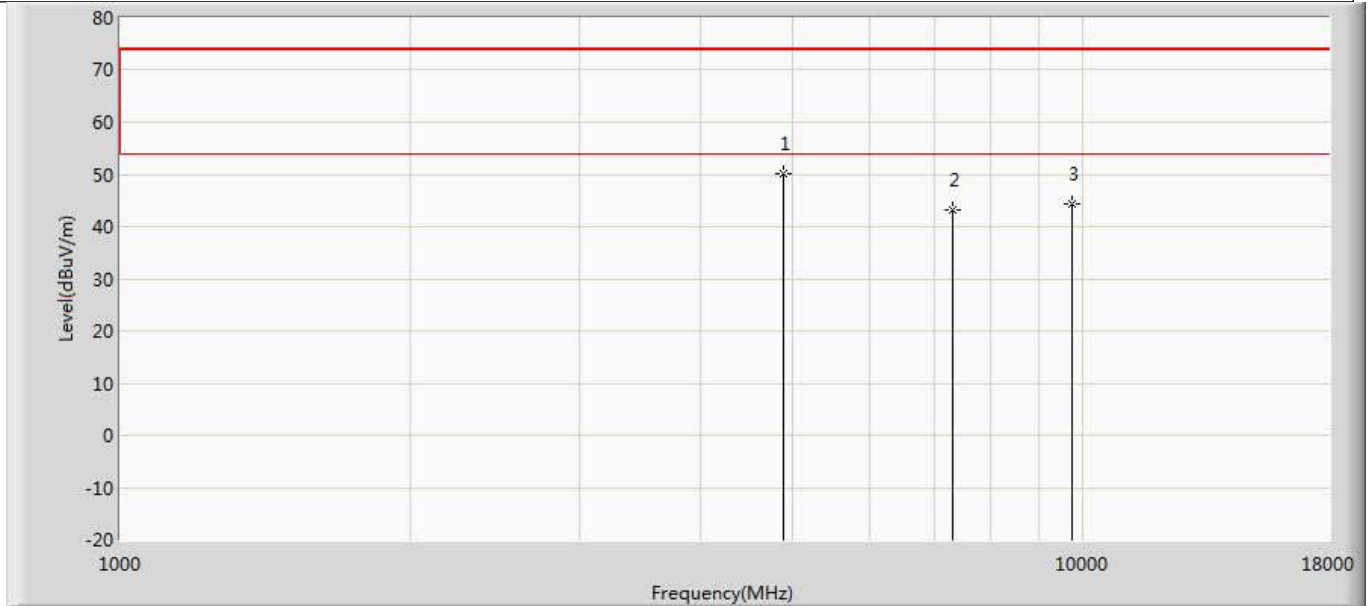

| No | Mark | Frequency (MHz) | Measure Level (dBuV/m) | Reading Level (dBuV) | Over Limit (dB) | Limit (dBuV/m) | Factor (dB) | Type |
|----|------|-----------------|------------------------|----------------------|-----------------|----------------|-------------|------|
| 1 | * | 4876.000 | 50.028 | 45.161 | -23.972 | 74.000 | 4.867 | PK |
| 2 | | 7311.000 | 43.063 | 35.485 | -30.937 | 74.000 | 7.578 | PK |
| 3 | | 9748.000 | 44.262 | 34.608 | -29.738 | 74.000 | 9.654 | PK |

| | |
|---|--------------------------|
| Engineer: Yingfei Wang | |
| Site: AC5 | Time: 2019/07/18 - 11:19 |
| Limit: FCC_Part15.209_RE(3m) | Margin: 0 |
| Probe: Horn_3117_00167055(1-18GHz) | Polarity: Horizontal |
| EUT: WiFi Plug US | Power: AC 120V/60Hz |
| Note: Mode 1:Transmit at 2437MHz by 802.11b | |

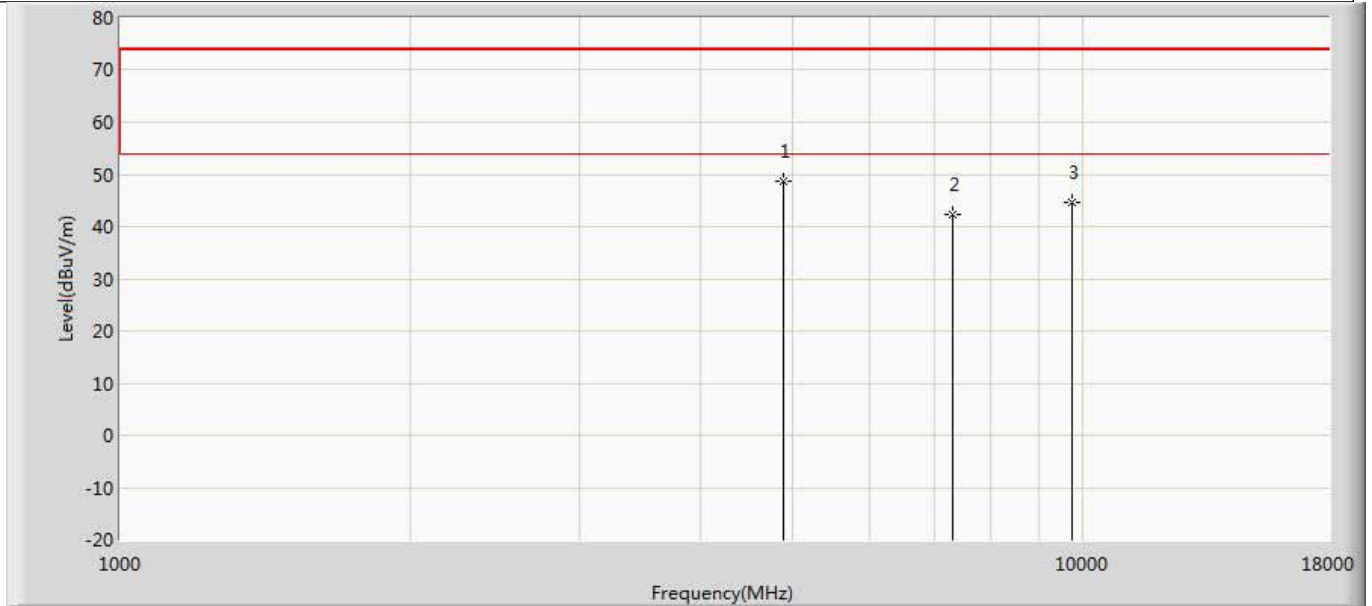

| No | Mark | Frequency (MHz) | Measure Level (dBuV/m) | Reading Level (dBuV) | Over Limit (dB) | Limit (dBuV/m) | Factor (dB) | Type |
|----|------|-----------------|------------------------|----------------------|-----------------|----------------|-------------|------|
| 1 | * | 4876.000 | 48.697 | 43.830 | -25.303 | 74.000 | 4.867 | PK |
| 2 | | 7311.000 | 42.321 | 34.743 | -31.679 | 74.000 | 7.578 | PK |
| 3 | | 9748.000 | 44.604 | 34.950 | -29.396 | 74.000 | 9.654 | PK |

| | |
|---|--------------------------|
| Engineer: Yingfei Wang | |
| Site: AC5 | Time: 2019/07/18 - 11:19 |
| Limit: FCC_Part15.209_RE(3m) | Margin: 0 |
| Probe: Horn_3117_00167055(1-18GHz) | Polarity: Vertical |
| EUT: WiFi Plug US | Power: AC 120V/60Hz |
| Note: Mode 1:Transmit at 2462MHz by 802.11b | |

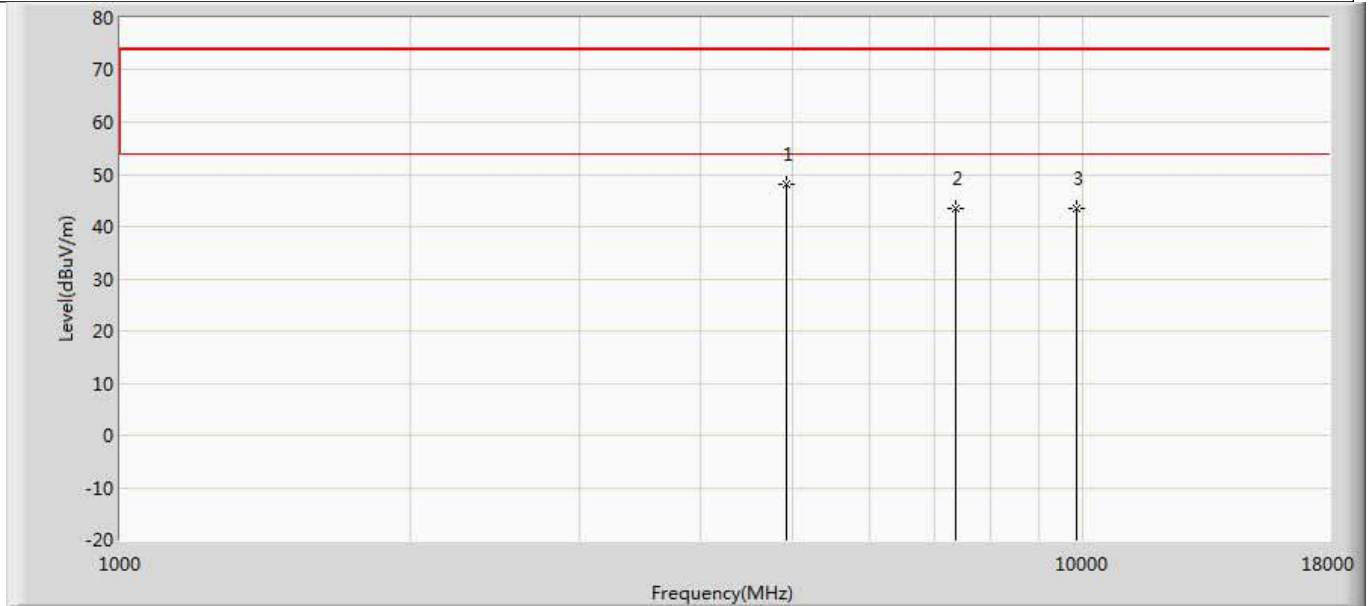

| No | Mark | Frequency (MHz) | Measure Level (dBuV/m) | Reading Level (dBuV) | Over Limit (dB) | Limit (dBuV/m) | Factor (dB) | Type |
|----|------|-----------------|------------------------|----------------------|-----------------|----------------|-------------|------|
| 1 | * | 4927.000 | 48.031 | 43.330 | -25.969 | 74.000 | 4.701 | PK |
| 2 | | 7386.000 | 43.609 | 35.828 | -30.391 | 74.000 | 7.781 | PK |
| 3 | | 9848.000 | 43.450 | 33.782 | -30.550 | 74.000 | 9.668 | PK |

| | |
|---|--------------------------|
| Engineer: Yingfei Wang | |
| Site: AC5 | Time: 2019/07/18 - 11:19 |
| Limit: FCC_Part15.209_RE(3m) | Margin: 0 |
| Probe: Horn_3117_00167055(1-18GHz) | Polarity: Horizontal |
| EUT: WiFi Plug US | Power: AC 120V/60Hz |
| Note: Mode 1:Transmit at 2462MHz by 802.11b | |

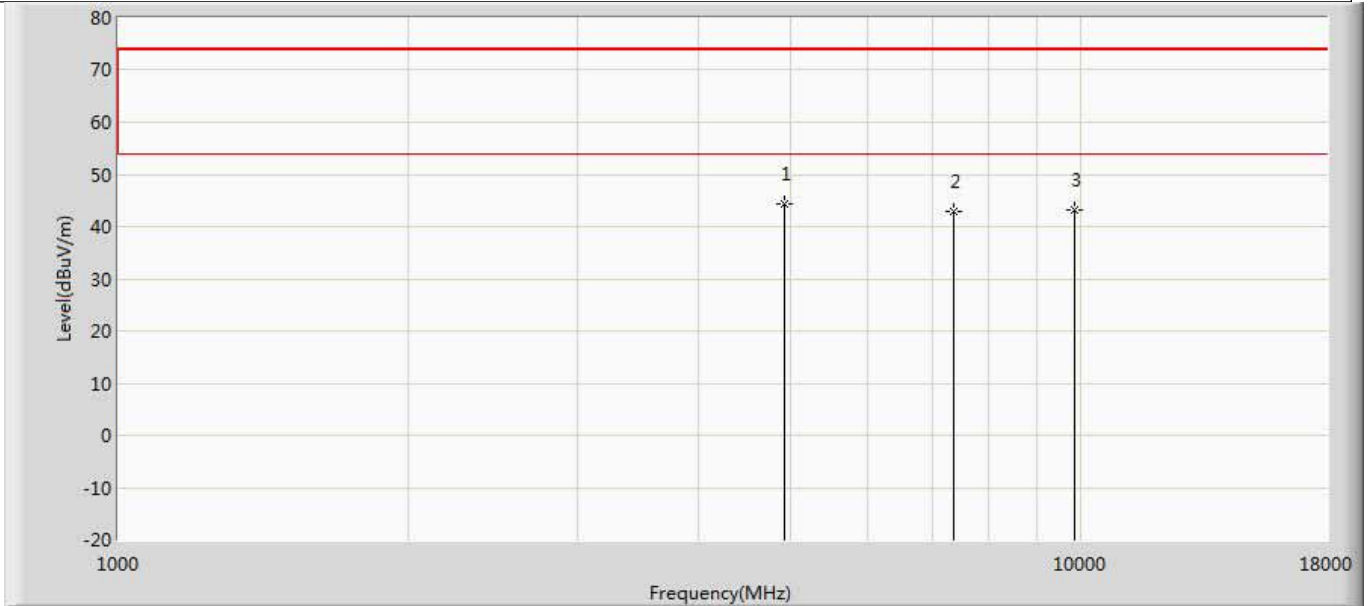

| No | Mark | Frequency (MHz) | Measure Level (dBuV/m) | Reading Level (dBuV) | Over Limit (dB) | Limit (dBuV/m) | Factor (dB) | Type |
|----|------|-----------------|------------------------|----------------------|-----------------|----------------|-------------|------|
| 1 | * | 4927.000 | 44.463 | 39.762 | -29.537 | 74.000 | 4.701 | PK |
| 2 | | 7386.000 | 43.028 | 35.247 | -30.972 | 74.000 | 7.781 | PK |
| 3 | | 9848.000 | 43.239 | 33.571 | -30.761 | 74.000 | 9.668 | PK |

| | |
|---|--------------------------|
| Engineer: Yingfei Wang | |
| Site: AC5 | Time: 2019/07/18 - 11:19 |
| Limit: FCC_Part15.209_RE(3m) | Margin: 0 |
| Probe: Horn_3117_00167055(1-18GHz) | Polarity: Vertical |
| EUT: WiFi Plug US | Power: AC 120V/60Hz |
| Note: Mode 2:Transmit at 2412MHz by 802.11g | |

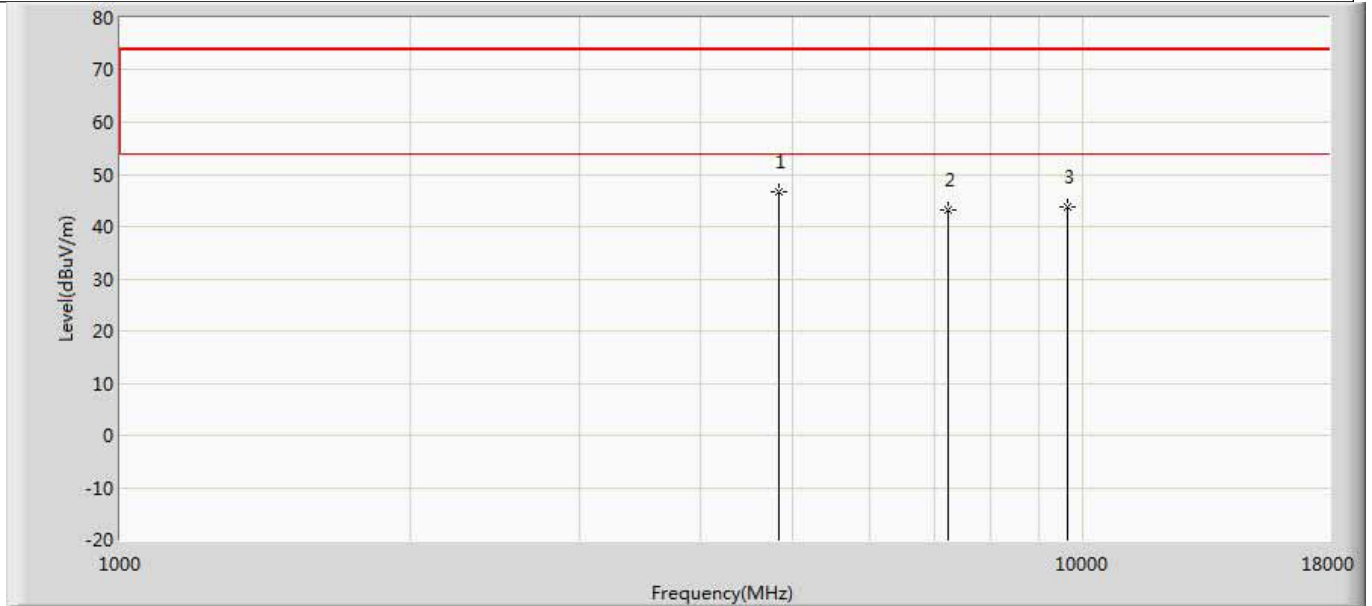

| No | Mark | Frequency (MHz) | Measure Level (dBuV/m) | Reading Level (dBuV) | Over Limit (dB) | Limit (dBuV/m) | Factor (dB) | Type |
|----|------|-----------------|------------------------|----------------------|-----------------|----------------|-------------|------|
| 1 | * | 4825.000 | 46.678 | 42.198 | -27.322 | 74.000 | 4.480 | PK |
| 2 | | 7236.000 | 43.269 | 35.579 | -30.731 | 74.000 | 7.689 | PK |
| 3 | | 9648.000 | 43.879 | 34.319 | -30.121 | 74.000 | 9.560 | PK |

| | |
|---|--------------------------|
| Engineer: Yingfei Wang | |
| Site: AC5 | Time: 2019/07/18 - 11:20 |
| Limit: FCC_Part15.209_RE(3m) | Margin: 0 |
| Probe: Horn_3117_00167055(1-18GHz) | Polarity: Horizontal |
| EUT: WiFi Plug US | Power: AC 120V/60Hz |
| Note: Mode 2:Transmit at 2412MHz by 802.11g | |

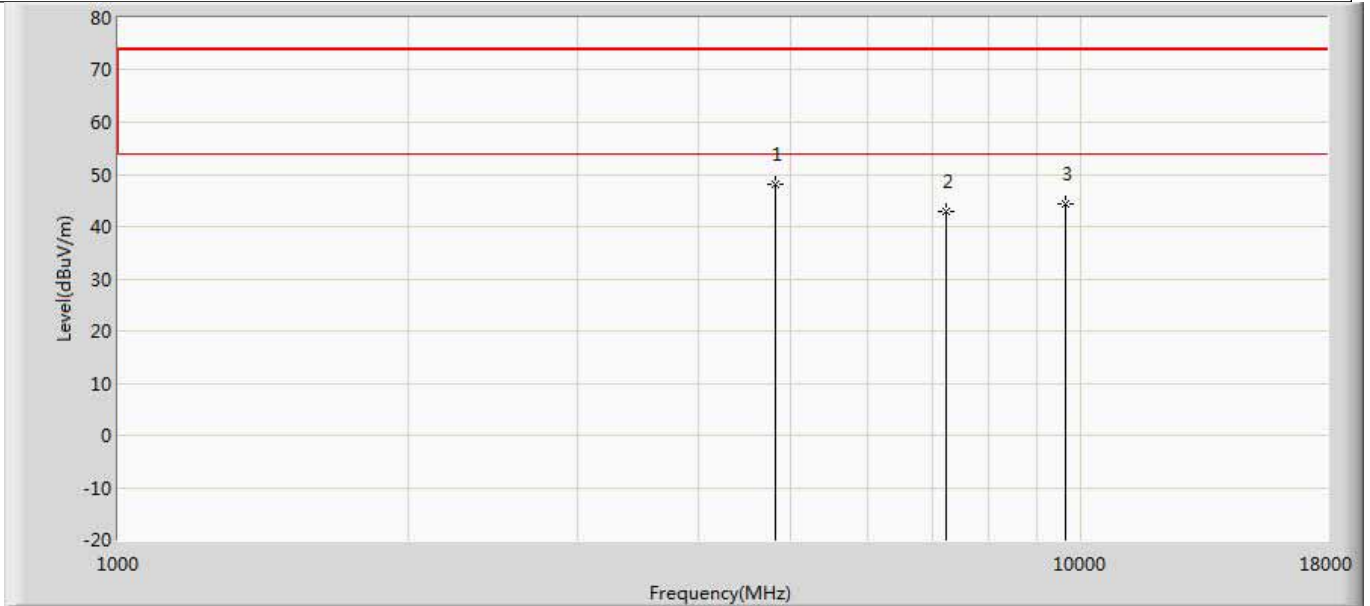

| No | Mark | Frequency (MHz) | Measure Level (dBuV/m) | Reading Level (dBuV) | Over Limit (dB) | Limit (dBuV/m) | Factor (dB) | Type |
|----|------|-----------------|------------------------|----------------------|-----------------|----------------|-------------|------|
| 1 | * | 4816.500 | 47.996 | 43.502 | -26.004 | 74.000 | 4.495 | PK |
| 2 | | 7236.000 | 42.841 | 35.151 | -31.159 | 74.000 | 7.689 | PK |
| 3 | | 9648.000 | 44.216 | 34.656 | -29.784 | 74.000 | 9.560 | PK |

| | |
|---|--------------------------|
| Engineer: Yingfei Wang | |
| Site: AC5 | Time: 2019/07/18 - 11:20 |
| Limit: FCC_Part15.209_RE(3m) | Margin: 0 |
| Probe: Horn_3117_00167055(1-18GHz) | Polarity: Vertical |
| EUT: WiFi Plug US | Power: AC 120V/60Hz |
| Note: Mode 2:Transmit at 2437MHz by 802.11g | |

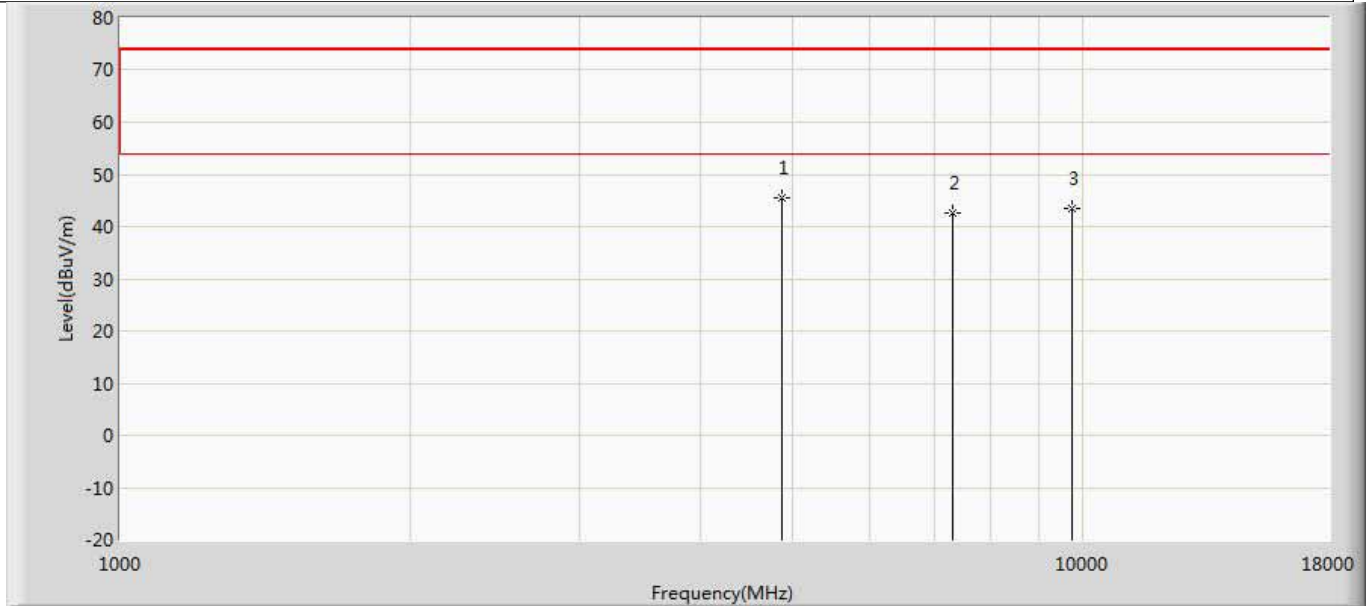

| No | Mark | Frequency (MHz) | Measure Level (dBuV/m) | Reading Level (dBuV) | Over Limit (dB) | Limit (dBuV/m) | Factor (dB) | Type |
|----|------|-----------------|------------------------|----------------------|-----------------|----------------|-------------|------|
| 1 | * | 4867.500 | 45.545 | 40.773 | -28.455 | 74.000 | 4.772 | PK |
| 2 | | 7311.000 | 42.584 | 35.006 | -31.416 | 74.000 | 7.578 | PK |
| 3 | | 9748.000 | 43.547 | 33.893 | -30.453 | 74.000 | 9.654 | PK |

| | |
|---|--------------------------|
| Engineer: Yingfei Wang | |
| Site: AC5 | Time: 2019/07/18 - 11:20 |
| Limit: FCC_Part15.209_RE(3m) | Margin: 0 |
| Probe: Horn_3117_00167055(1-18GHz) | Polarity: Horizontal |
| EUT: WiFi Plug US | Power: AC 120V/60Hz |
| Note: Mode 2:Transmit at 2437MHz by 802.11g | |

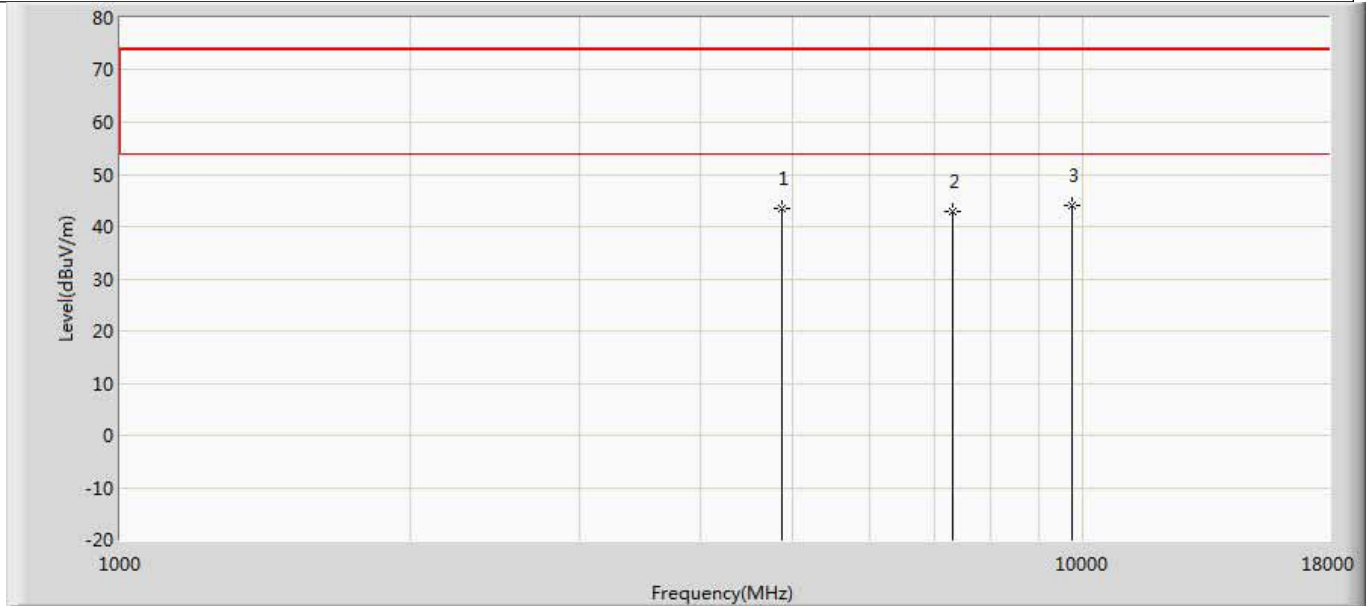

| No | Mark | Frequency (MHz) | Measure Level (dBuV/m) | Reading Level (dBuV) | Over Limit (dB) | Limit (dBuV/m) | Factor (dB) | Type |
|----|------|-----------------|------------------------|----------------------|-----------------|----------------|-------------|------|
| 1 | | 4874.000 | 43.434 | 38.589 | -30.566 | 74.000 | 4.844 | PK |
| 2 | | 7311.000 | 42.952 | 35.374 | -31.048 | 74.000 | 7.578 | PK |
| 3 | * | 9748.000 | 43.946 | 34.292 | -30.054 | 74.000 | 9.654 | PK |

| | |
|---|--------------------------|
| Engineer: Yingfei Wang | |
| Site: AC5 | Time: 2019/07/18 - 11:20 |
| Limit: FCC_Part15.209_RE(3m) | Margin: 0 |
| Probe: Horn_3117_00167055(1-18GHz) | Polarity: Vertical |
| EUT: WiFi Plug US | Power: AC 120V/60Hz |
| Note: Mode 2:Transmit at 2462MHz by 802.11g | |

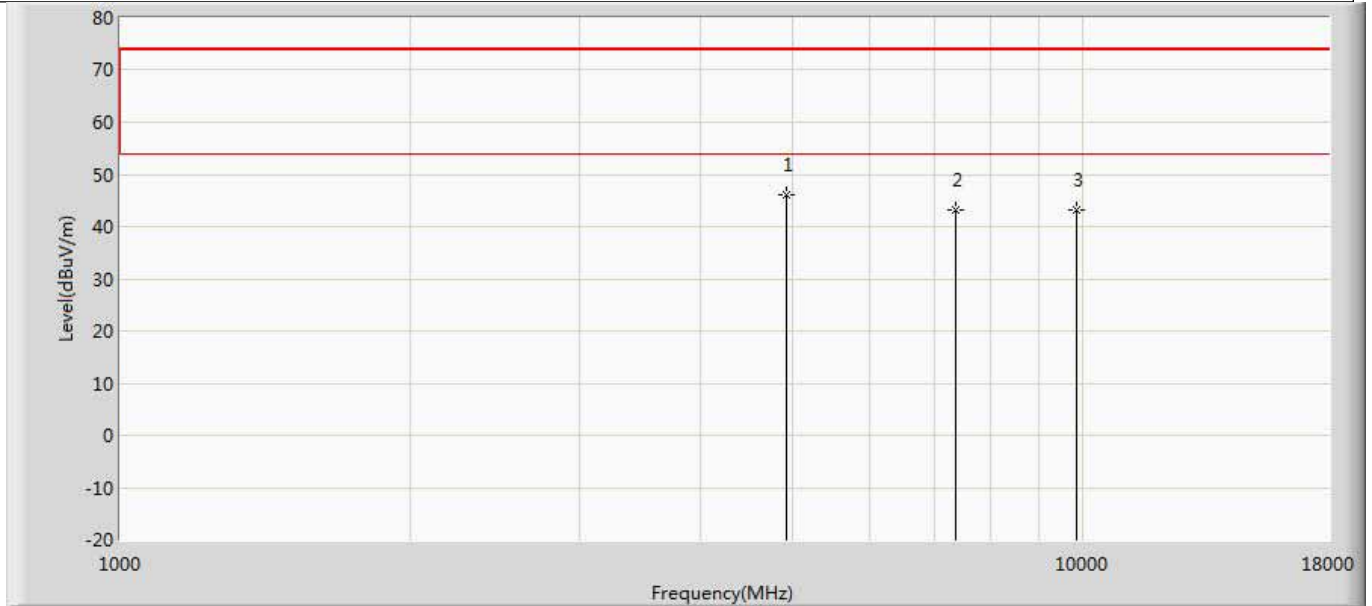

| No | Mark | Frequency (MHz) | Measure Level (dBuV/m) | Reading Level (dBuV) | Over Limit (dB) | Limit (dBuV/m) | Factor (dB) | Type |
|----|------|-----------------|------------------------|----------------------|-----------------|----------------|-------------|------|
| 1 | * | 4918.500 | 46.217 | 41.463 | -27.783 | 74.000 | 4.754 | PK |
| 2 | | 7386.000 | 43.325 | 35.544 | -30.675 | 74.000 | 7.781 | PK |
| 3 | | 9848.000 | 43.157 | 33.489 | -30.843 | 74.000 | 9.668 | PK |

| | |
|---|--------------------------|
| Engineer: Yingfei Wang | |
| Site: AC5 | Time: 2019/07/18 - 11:20 |
| Limit: FCC_Part15.209_RE(3m) | Margin: 0 |
| Probe: Horn_3117_00167055(1-18GHz) | Polarity: Horizontal |
| EUT: WiFi Plug US | Power: AC 120V/60Hz |
| Note: Mode 2:Transmit at 2462MHz by 802.11g | |

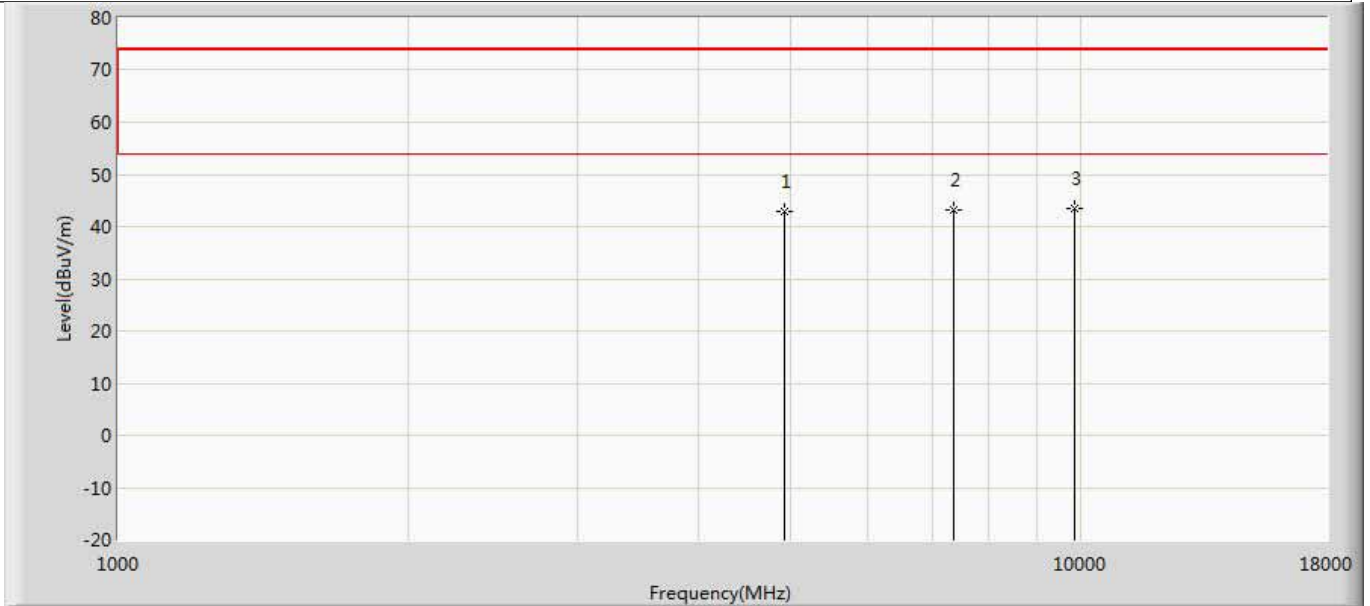

| No | Mark | Frequency (MHz) | Measure Level (dBuV/m) | Reading Level (dBuV) | Over Limit (dB) | Limit (dBuV/m) | Factor (dB) | Type |
|----|------|-----------------|------------------------|----------------------|-----------------|----------------|-------------|------|
| 1 | | 4924.000 | 42.774 | 38.054 | -31.226 | 74.000 | 4.719 | PK |
| 2 | | 7386.000 | 43.255 | 35.474 | -30.745 | 74.000 | 7.781 | PK |
| 3 | * | 9848.000 | 43.354 | 33.686 | -30.646 | 74.000 | 9.668 | PK |

| | |
|---|--------------------------|
| Engineer: Yingfei Wang | |
| Site: AC5 | Time: 2019/07/18 - 11:20 |
| Limit: FCC_Part15.209_RE(3m) | Margin: 0 |
| Probe: Horn_3117_00167055(1-18GHz) | Polarity: Vertical |
| EUT: WiFi Plug US | Power: AC 120V/60Hz |
| Note: Mode 3:Transmit at 2412MHz by 802.11n20 | |

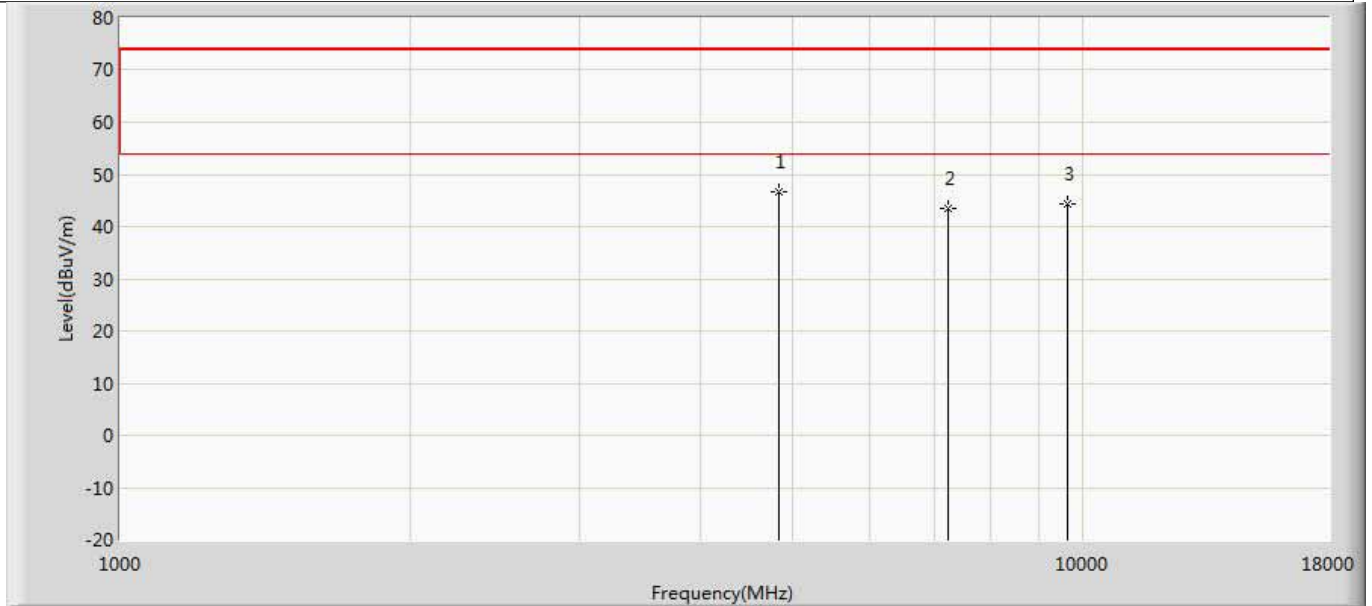

| No | Mark | Frequency (MHz) | Measure Level (dBuV/m) | Reading Level (dBuV) | Over Limit (dB) | Limit (dBuV/m) | Factor (dB) | Type |
|----|------|-----------------|------------------------|----------------------|-----------------|----------------|-------------|------|
| 1 | * | 4825.000 | 46.768 | 42.288 | -27.232 | 74.000 | 4.480 | PK |
| 2 | | 7236.000 | 43.473 | 35.783 | -30.527 | 74.000 | 7.689 | PK |
| 3 | | 9648.000 | 44.274 | 34.714 | -29.726 | 74.000 | 9.560 | PK |

| | |
|---|--------------------------|
| Engineer: Yingfei Wang | |
| Site: AC5 | Time: 2019/07/18 - 11:20 |
| Limit: FCC_Part15.209_RE(3m) | Margin: 0 |
| Probe: Horn_3117_00167055(1-18GHz) | Polarity: Horizontal |
| EUT: WiFi Plug US | Power: AC 120V/60Hz |
| Note: Mode 3:Transmit at 2412MHz by 802.11n20 | |

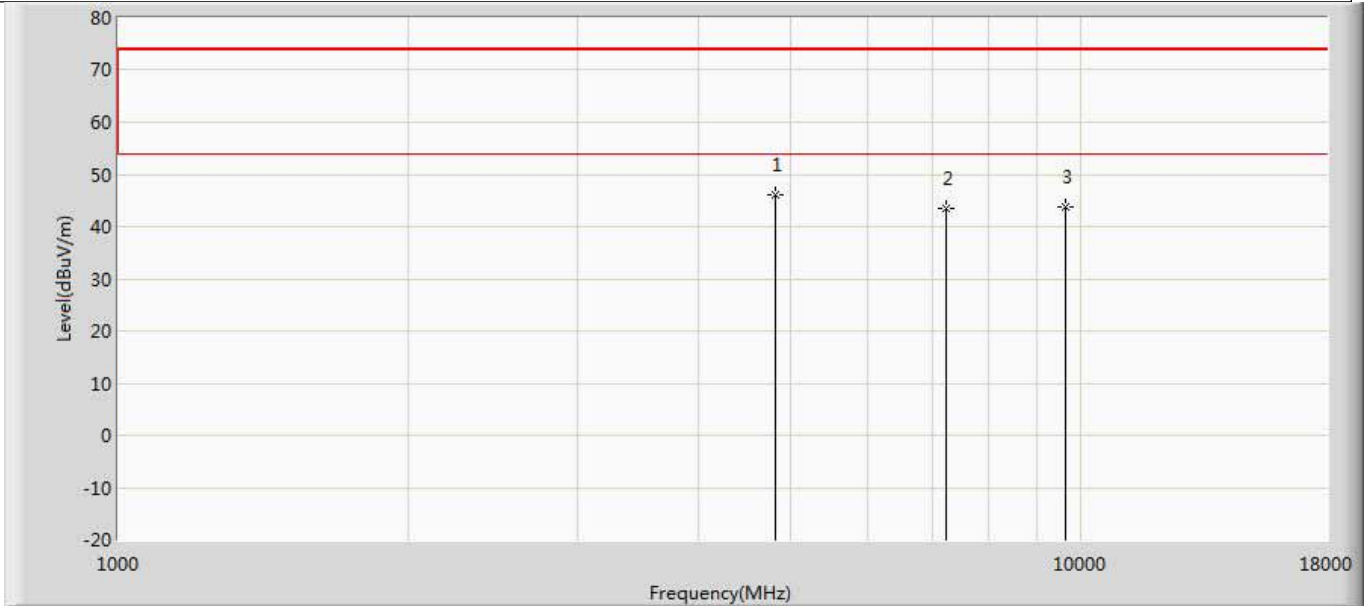

| No | Mark | Frequency (MHz) | Measure Level (dBuV/m) | Reading Level (dBuV) | Over Limit (dB) | Limit (dBuV/m) | Factor (dB) | Type |
|----|------|-----------------|------------------------|----------------------|-----------------|----------------|-------------|------|
| 1 | * | 4816.500 | 46.163 | 41.669 | -27.837 | 74.000 | 4.495 | PK |
| 2 | | 7236.000 | 43.399 | 35.709 | -30.601 | 74.000 | 7.689 | PK |
| 3 | | 9648.000 | 43.787 | 34.227 | -30.213 | 74.000 | 9.560 | PK |

| | |
|---|--------------------------|
| Engineer: Yingfei Wang | |
| Site: AC5 | Time: 2019/07/18 - 11:21 |
| Limit: FCC_Part15.209_RE(3m) | Margin: 0 |
| Probe: Horn_3117_00167055(1-18GHz) | Polarity: Vertical |
| EUT: WiFi Plug US | Power: AC 120V/60Hz |
| Note: Mode 3:Transmit at 2437MHz by 802.11n20 | |

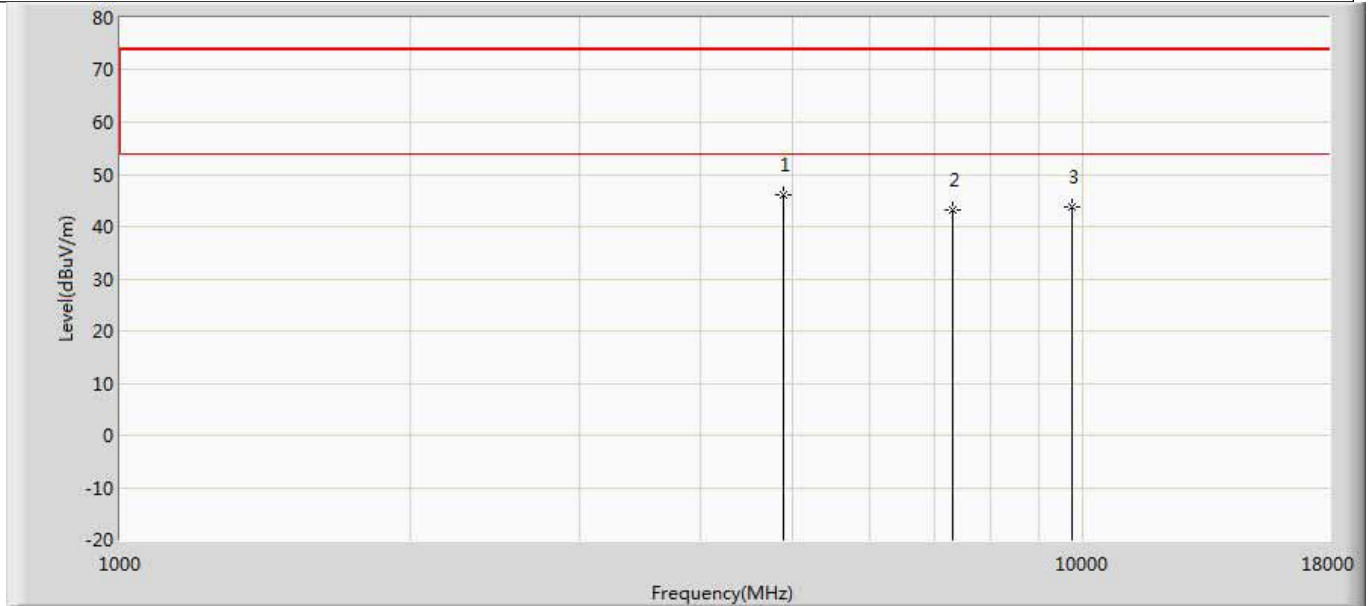

| No | Mark | Frequency (MHz) | Measure Level (dBuV/m) | Reading Level (dBuV) | Over Limit (dB) | Limit (dBuV/m) | Factor (dB) | Type |
|----|------|-----------------|------------------------|----------------------|-----------------|----------------|-------------|------|
| 1 | * | 4884.500 | 46.220 | 41.525 | -27.780 | 74.000 | 4.696 | PK |
| 2 | | 7311.000 | 43.310 | 35.732 | -30.690 | 74.000 | 7.578 | PK |
| 3 | | 9748.000 | 43.722 | 34.068 | -30.278 | 74.000 | 9.654 | PK |

| | |
|---|--------------------------|
| Engineer: Yingfei Wang | |
| Site: AC5 | Time: 2019/07/18 - 11:21 |
| Limit: FCC_Part15.209_RE(3m) | Margin: 0 |
| Probe: Horn_3117_00167055(1-18GHz) | Polarity: Horizontal |
| EUT: WiFi Plug US | Power: AC 120V/60Hz |
| Note: Mode 3:Transmit at 2437MHz by 802.11n20 | |

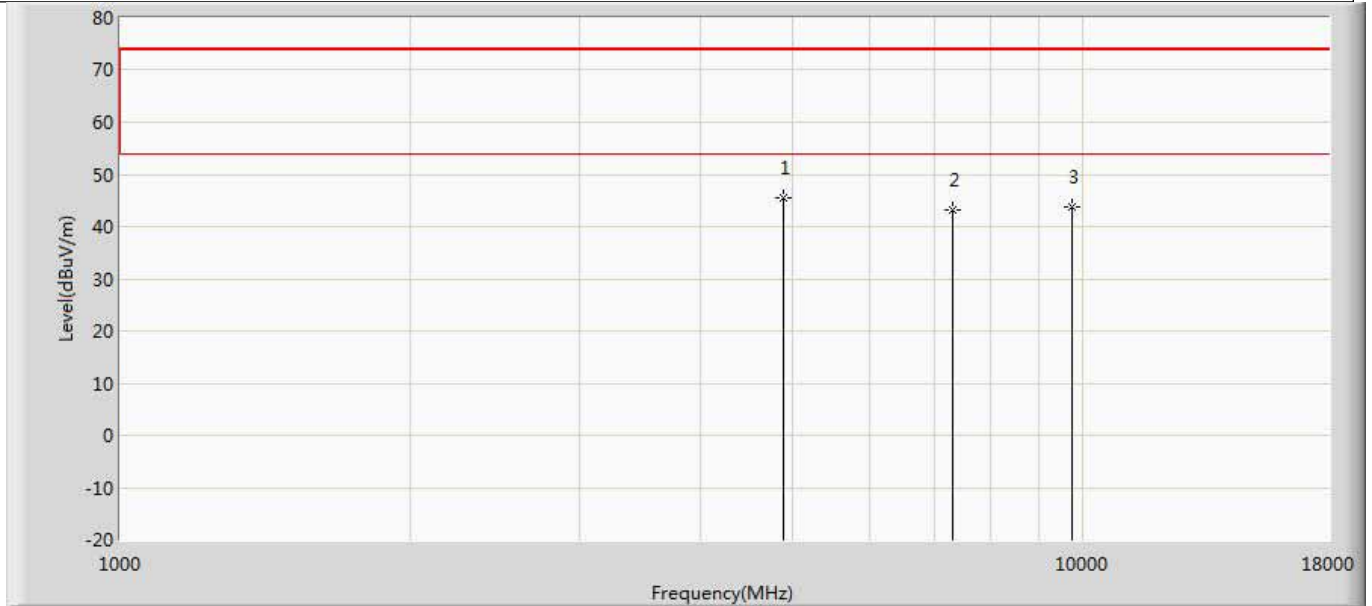

| No | Mark | Frequency (MHz) | Measure Level (dBuV/m) | Reading Level (dBuV) | Over Limit (dB) | Limit (dBuV/m) | Factor (dB) | Type |
|----|------|-----------------|------------------------|----------------------|-----------------|----------------|-------------|------|
| 1 | * | 4876.000 | 45.457 | 40.590 | -28.543 | 74.000 | 4.867 | PK |
| 2 | | 7311.000 | 43.097 | 35.519 | -30.903 | 74.000 | 7.578 | PK |
| 3 | | 9748.000 | 43.797 | 34.143 | -30.203 | 74.000 | 9.654 | PK |

| | |
|---|--------------------------|
| Engineer: Yingfei Wang | |
| Site: AC5 | Time: 2019/07/18 - 11:21 |
| Limit: FCC_Part15.209_RE(3m) | Margin: 0 |
| Probe: Horn_3117_00167055(1-18GHz) | Polarity: Vertical |
| EUT: WiFi Plug US | Power: AC 120V/60Hz |
| Note: Mode 3:Transmit at 2462MHz by 802.11n20 | |

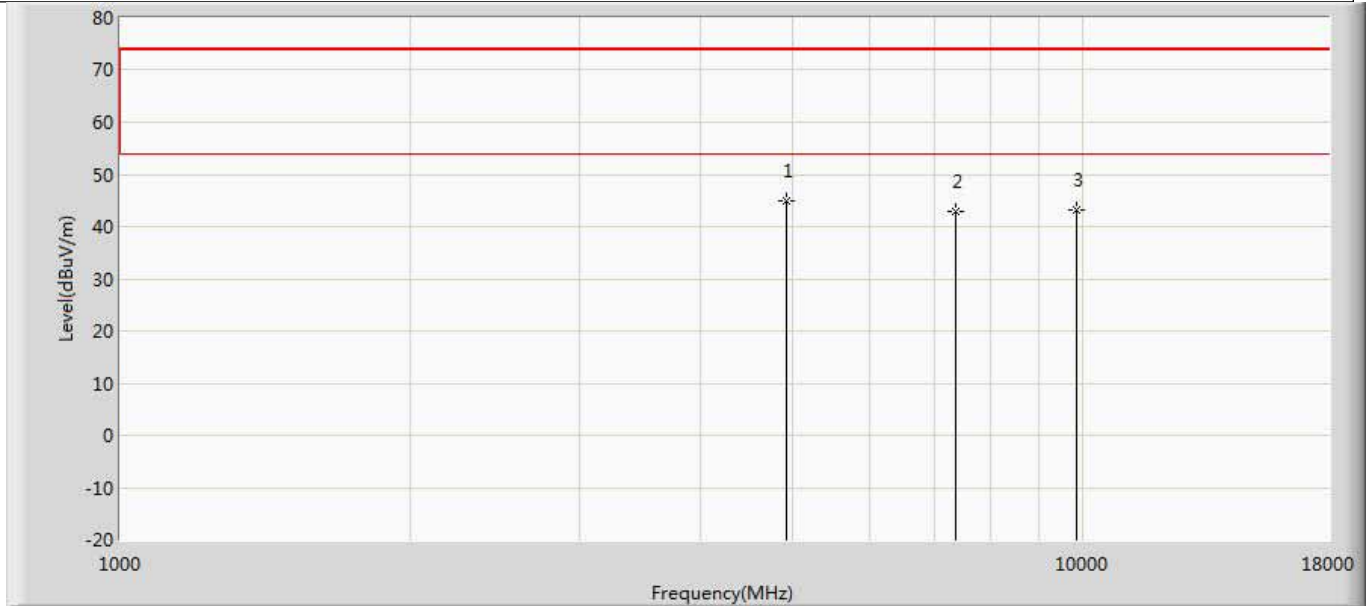

| No | Mark | Frequency (MHz) | Measure Level (dBuV/m) | Reading Level (dBuV) | Over Limit (dB) | Limit (dBuV/m) | Factor (dB) | Type |
|----|------|-----------------|------------------------|----------------------|-----------------|----------------|-------------|------|
| 1 | * | 4918.500 | 45.010 | 40.256 | -28.990 | 74.000 | 4.754 | PK |
| 2 | | 7386.000 | 43.024 | 35.243 | -30.976 | 74.000 | 7.781 | PK |
| 3 | | 9848.000 | 43.151 | 33.483 | -30.849 | 74.000 | 9.668 | PK |

| | |
|---|--------------------------|
| Engineer: Yingfei Wang | |
| Site: AC5 | Time: 2019/07/18 - 11:23 |
| Limit: FCC_Part15.209_RE(3m) | Margin: 0 |
| Probe: Horn_3117_00167055(1-18GHz) | Polarity: Horizontal |
| EUT: WiFi Plug US | Power: AC 120V/60Hz |
| Note: Mode 3:Transmit at 2462MHz by 802.11n20 | |

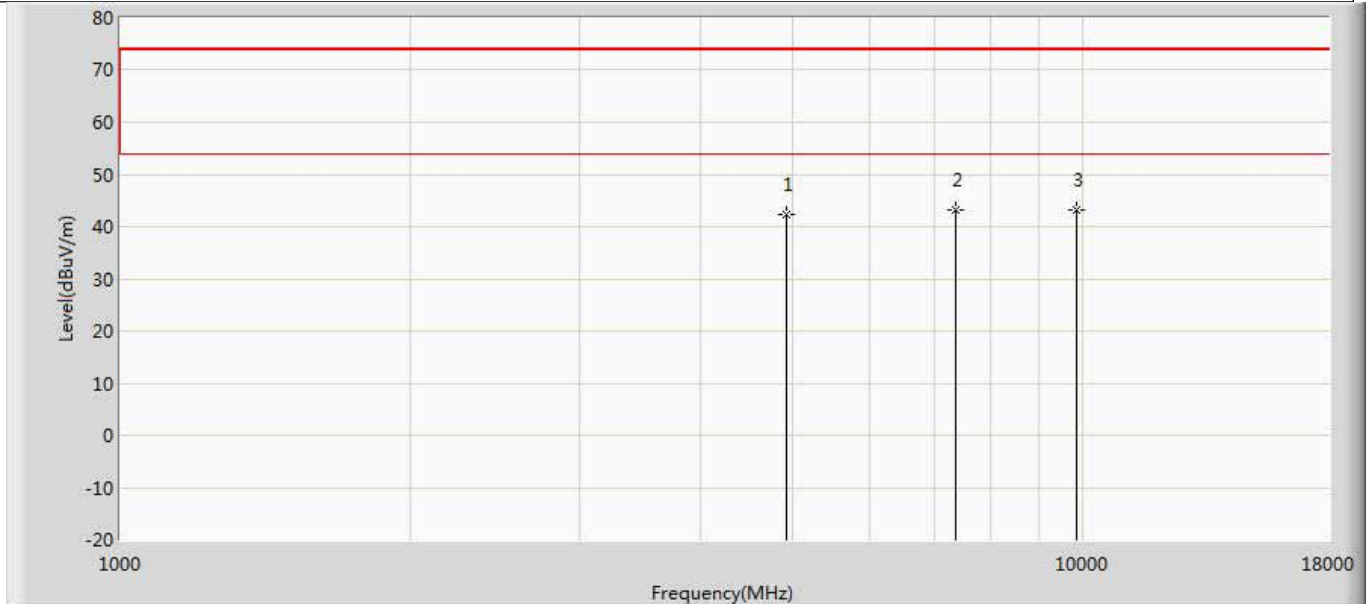

| No | Mark | Frequency (MHz) | Measure Level (dBuV/m) | Reading Level (dBuV) | Over Limit (dB) | Limit (dBuV/m) | Factor (dB) | Type |
|----|------|-----------------|------------------------|----------------------|-----------------|----------------|-------------|------|
| 1 | | 4924.000 | 42.232 | 37.512 | -31.768 | 74.000 | 4.719 | PK |
| 2 | * | 7386.000 | 43.285 | 35.504 | -30.715 | 74.000 | 7.781 | PK |
| 3 | | 9848.000 | 43.140 | 33.472 | -30.860 | 74.000 | 9.668 | PK |

| | |
|--------|--|
| Remark | <p>1. " * ", means this data is the worst emission level.</p> <p>2. Measurement Level = Reading Level + Factor(Probe+Cable-Amp).</p> <p>3. The test frequency range, 9kHz~30MHz, 18GHz~25GHz, both of the worst case are at least 6dB below the limits, therefore no data appear in the report.</p> <p>4. This limit applies for using average detector, if the test result on peak is lower than average limit, then average measurement needn't be performed.</p> <p>5. The complete raw data please refer to Appendix RSE, Shown in the report is the worst data.</p> |
|--------|--|

The worst case of Radiated Emission below 1GHz:

| | |
|------------------------------|----------------------|
| Engineer: Glory | |
| Site: AC2 | Time: 2019/07/10 |
| Limit: FCC_Part15.209_RE(3m) | Margin: 0 |
| Probe: AC2_3M(30-1000M) | Polarity: Horizontal |
| EUT: WiFi Plug US | Power: AC 120V/60Hz |
| Note: Mode 1 | |

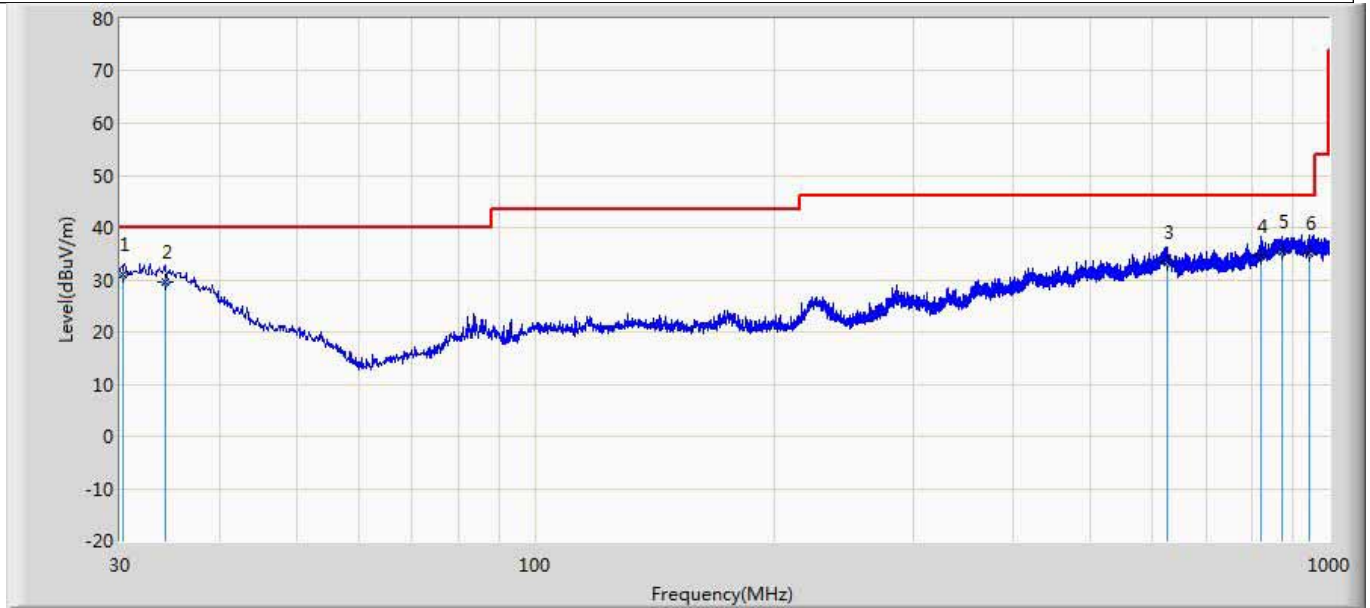

| No | Mark | Frequency (MHz) | Measure Level (dBuV/m) | Reading Level (dBuV) | Over Limit (dB) | Limit (dBuV/m) | Probe (dB/m) | Cable (dB) | Amp (dB) | Ant Pos (cm) | Table Pos (deg) | Type |
|----|------|-----------------|------------------------|----------------------|-----------------|----------------|--------------|------------|----------|--------------|-----------------|------|
| 1 | * | 30.286 | 30.909 | 3.254 | -9.091 | 40.000 | 21.032 | 6.623 | 0.000 | 300 | 316 | QP |
| 2 | | 34.215 | 29.469 | 2.114 | -10.531 | 40.000 | 20.692 | 6.663 | 0.000 | 400 | 58 | QP |
| 3 | | 625.335 | 33.456 | 2.774 | -12.544 | 46.000 | 22.111 | 8.570 | 0.000 | 100 | 348 | QP |
| 4 | | 821.596 | 34.439 | 3.020 | -11.561 | 46.000 | 22.358 | 9.061 | 0.000 | 300 | 182 | QP |
| 5 | | 871.862 | 35.414 | 2.581 | -10.586 | 46.000 | 23.651 | 9.182 | 0.000 | 400 | 306 | QP |
| 6 | | 946.558 | 35.015 | 2.152 | -10.985 | 46.000 | 23.521 | 9.343 | 0.000 | 200 | 240 | QP |

Note:

1. " * ", means this data is the worst emission level.
2. Measurement Level = Reading Level + Factor(Probe+Cable-Amp).

| | |
|------------------------------|---------------------|
| Engineer: Glory | |
| Site: AC2 | Time: 2019/07/10 |
| Limit: FCC_Part15.209_RE(3m) | Margin: 0 |
| Probe: AC2_3M(30-1000M) | Polarity: Vertical |
| EUT: WiFi Plug US | Power: AC 120V/60Hz |
| Note: Mode 1 | |

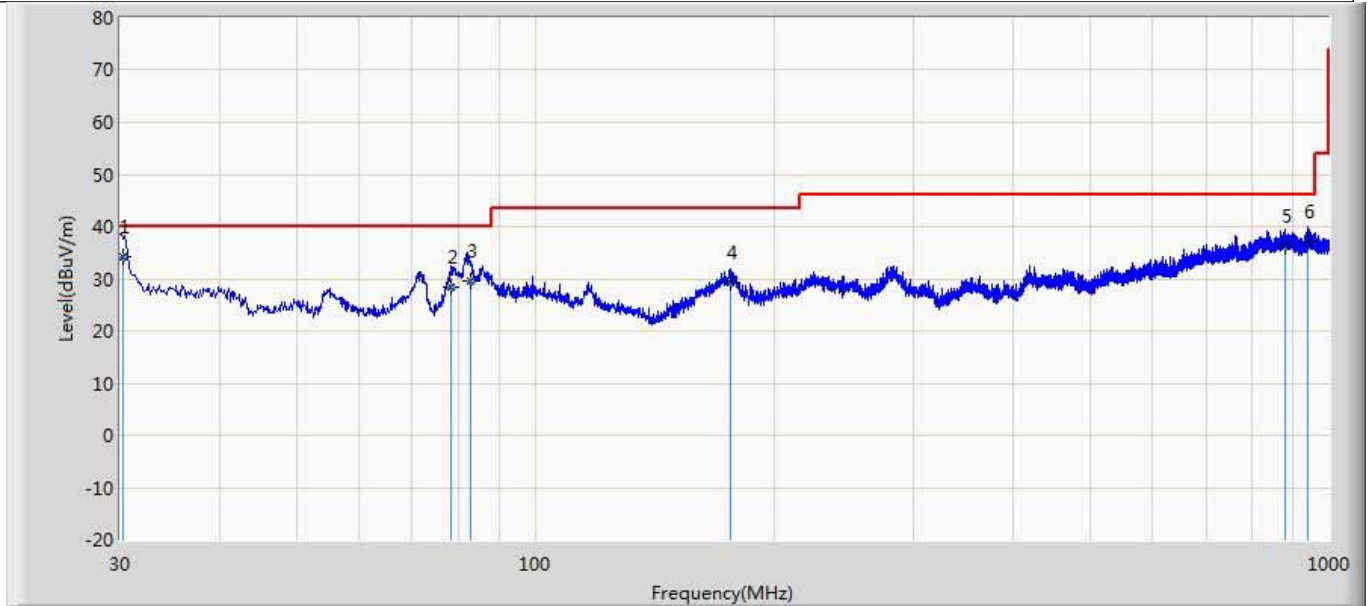

| No | Mark | Frequency (MHz) | Measure Level (dBuV/m) | Reading Level (dBuV) | Over Limit (dB) | Limit (dBuV/m) | Probe (dB/m) | Cable (dB) | Amp (dB) | Ant Pos (cm) | Table Pos (deg) | Type |
|----|------|-----------------|------------------------|----------------------|-----------------|----------------|--------------|------------|----------|--------------|-----------------|------|
| 1 | * | 30.218 | 34.307 | 10.000 | -5.693 | 40.000 | 17.685 | 6.622 | 0.000 | 100 | 345 | QP |
| 2 | | 78.457 | 28.363 | 13.684 | -11.637 | 40.000 | 8.024 | 6.655 | 0.000 | 100 | 342 | QP |
| 3 | | 82.870 | 29.448 | 13.700 | -10.552 | 40.000 | 9.073 | 6.675 | 0.000 | 100 | 317 | QP |
| 4 | | 176.054 | 29.212 | 10.857 | -14.288 | 43.500 | 11.066 | 7.289 | 0.000 | 200 | 178 | QP |
| 5 | | 879.047 | 36.274 | 2.845 | -9.726 | 46.000 | 24.230 | 9.200 | 0.000 | 100 | 105 | QP |
| 6 | | 942.521 | 37.072 | 3.257 | -8.928 | 46.000 | 24.481 | 9.334 | 0.000 | 100 | 360 | QP |

Note:

1. " * ", means this data is the worst emission level.
2. Measurement Level = Reading Level + Factor(Probe+Cable-Amp).

| | |
|---|----------------------|
| 4.3 Emissions in non-restricted frequency band | VERDICT: PASS |
|---|----------------------|

| 4.3.1 Limit | |
|---|---|
| Standard | FCC Part 15 Subpart C Paragraph 15.247(d) |
| RF Output power (Detection methods) | Limit(dB) |
| RF Output power(Average detector) | 30dBc(Note1) |
| RF Output power(PK detector) | 20dBc(Note2) |
| <p>Note 1: If maximum conducted (average) output power was used to demonstrate compliance as described in 9.2 then the peak power in any 100 kHz bandwidth outside of the authorized frequency band shall be attenuated by at least 30 dB relative to the maximum in-band peak PSD level in 100 kHz (i.e., 30 dBc).</p> <p>Note 2: If the maximum peak conducted output power procedure was used, then the peak output power measured in any 100 kHz bandwidth outside of the authorized frequency band shall be attenuated by at least 20 dB relative to the maximum in-band peak PSD level in 100 kHz (i.e., 20 dBc).</p> | |

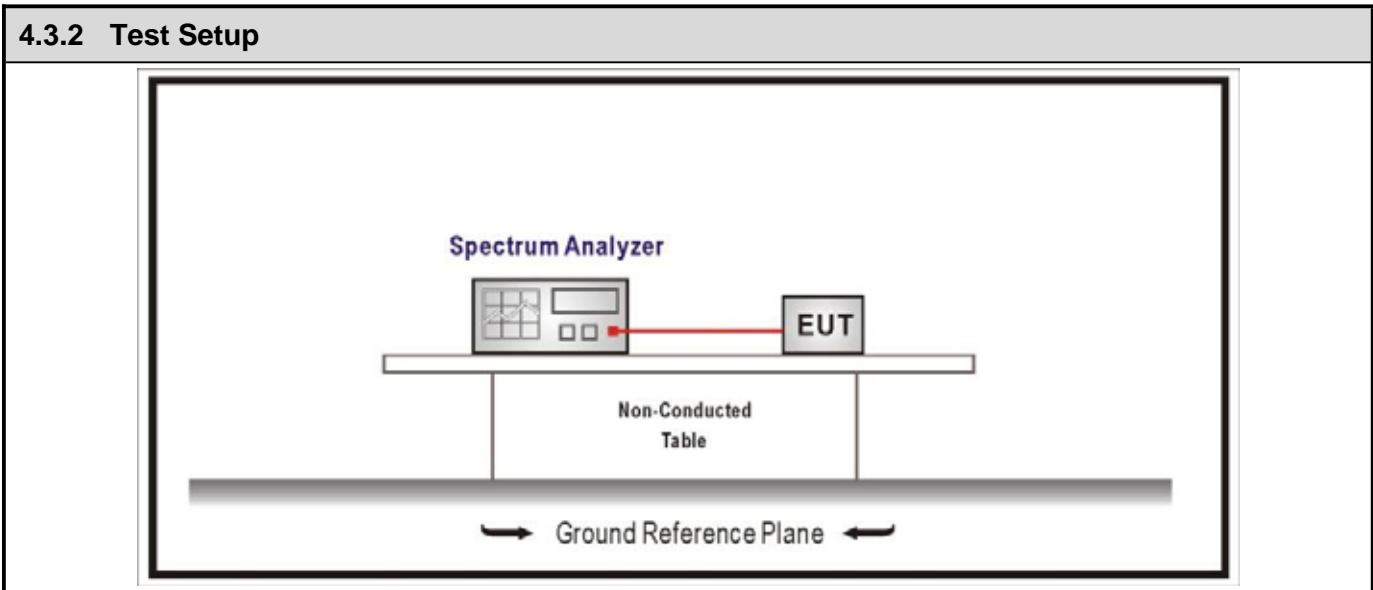

| 4.3.3 Test Procedure | | | |
|---|-------------|---|-----------------------------|
| References Rule | Chapter | Description | |
| <input checked="" type="checkbox"/> ANSI C63.10 | 11.11 | Emissions in non-restricted frequency bands | |
| <input checked="" type="checkbox"/> | ANSI C63.10 | 11.11.1 | General |
| <input checked="" type="checkbox"/> | ANSI C63.10 | 11.11.2 | Reference level measurement |
| <input checked="" type="checkbox"/> | ANSI C63.10 | 11.11.3 | Emission level measurement |

4.3.4 Test Data

| Mode | Channel | Test Frequency (MHz) | Maximum In-Band PSD[a] (dBm/100kHz) | Frequency (MHz) | Out-Band PSD[b] (dBm/100kHz) | [a]-[b] (dB) | Limit (dB) | Result |
|------|---------|----------------------|-------------------------------------|-----------------|------------------------------|--------------|------------|--------|
| 1 | 1 | 2412 | 5.379 | 2398.51 | -50.437 | 55.816 | 20 | Pass |
| | 11 | 2462 | 9.409 | 2500 | -52.745 | 62.154 | 20 | Pass |
| 2 | 1 | 2412 | 1.858 | 2400 | -42.006 | 43.864 | 20 | Pass |
| | 11 | 2462 | 6.441 | 2500 | -50.493 | 56.934 | 20 | Pass |
| 3 | 1 | 2412 | 2.231 | 2400 | -37.528 | 39.759 | 20 | Pass |
| | 11 | 2462 | 6.820 | 2500 | -50.492 | 57.312 | 20 | Pass |

Note: The worst case of emissions in non-restricted frequency bands as below:

Mode 3 CH01(2412MHz)



| | |
|-----------------------|----------------------|
| 4.4 Duty cycle | VERDICT: PASS |
|-----------------------|----------------------|

| |
|--------------------|
| 4.4.1 Limit |
| N/A |

| |
|-------------------------|
| 4.4.2 Test Setup |
|-------------------------|

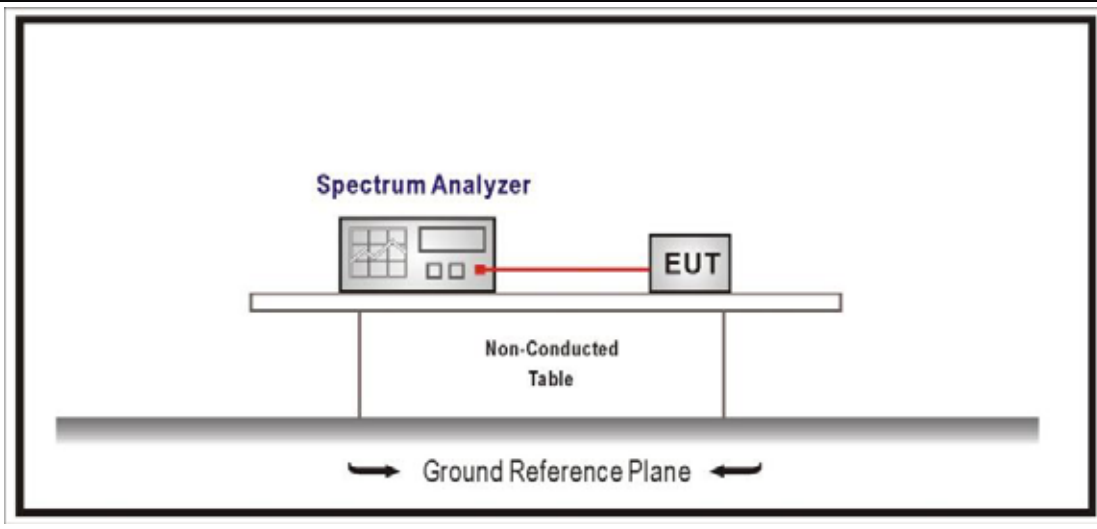

| |
|-----------------------------|
| 4.4.3 Test Procedure |
|-----------------------------|

| | References Rule | Chapter | Description |
|-------------------------------------|-----------------|---------|--|
| <input checked="" type="checkbox"/> | ANSI C63.10 | 11.6 | Duty cycle (D), transmission duration (T), and maximum power control level |

4.4.4 Test Data

| Test Mode | Tx On (ms) | Tx Off (ms) | VBW | Tx On + Tx Off (ms) | Duty Cycle |
|-----------|------------|-------------|------|---------------------|------------|
| 1 | 4.176 | 0.552 | 240k | 4.728 | 88.32% |
| 2 | 0.680 | 0.114 | 1.5k | 0.794 | 85.64% |
| 3 | 0.638 | 0.118 | 1.6k | 0.756 | 84.39% |

Note 1: T means the minimum transmission duration over which the transmitter is on and is transmitting at its maximum power control level for the tested mode of operation.

Note 2: According to KDB 558074, when test for Radiated Emission Band Edge and Radiated Emission, for average detector set: VBW 1/T will be used.

802.11b



802.11g

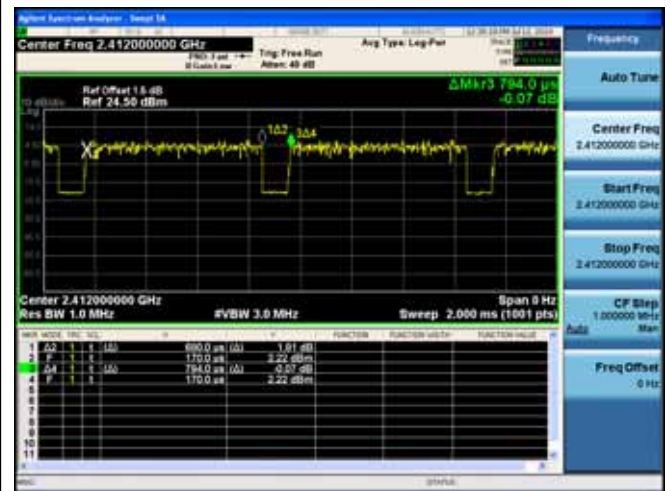

802.11n(20MHz)

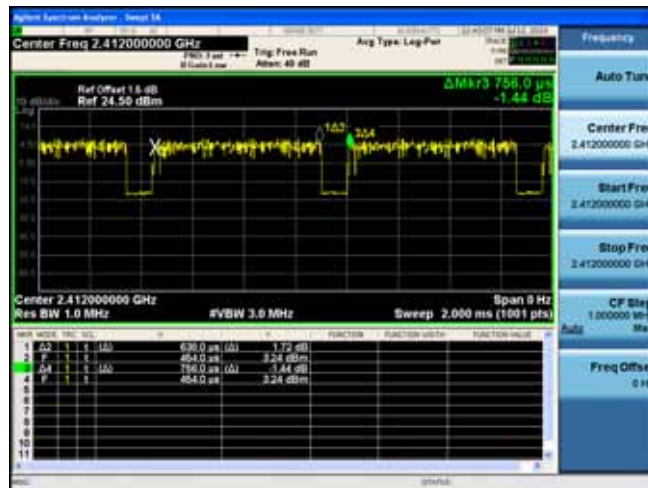

| | |
|--|----------------------|
| 4.5 Radiated Emission Band Edge | VERDICT: PASS |
|--|----------------------|

4.5.1 Limit

Standard FCC Part 15 Subpart C Paragraph 15.247(d) , 15.209

| Frequency bands (MHz) | Detector | Limit (dB μ V/m) | RBW (MHz) | Distance (m) |
|-----------------------|----------|----------------------|-----------|--------------|
| 2310-2390 | PK | 74 | 1 | 3 |
| 2483.5-2500 | AV | 54 | 1 | 3 |

Note: The field strength of emissions appearing within these frequency bands shall not exceed the limits.

4.5.2 Test Setup

Above 1GHz Test Setup:

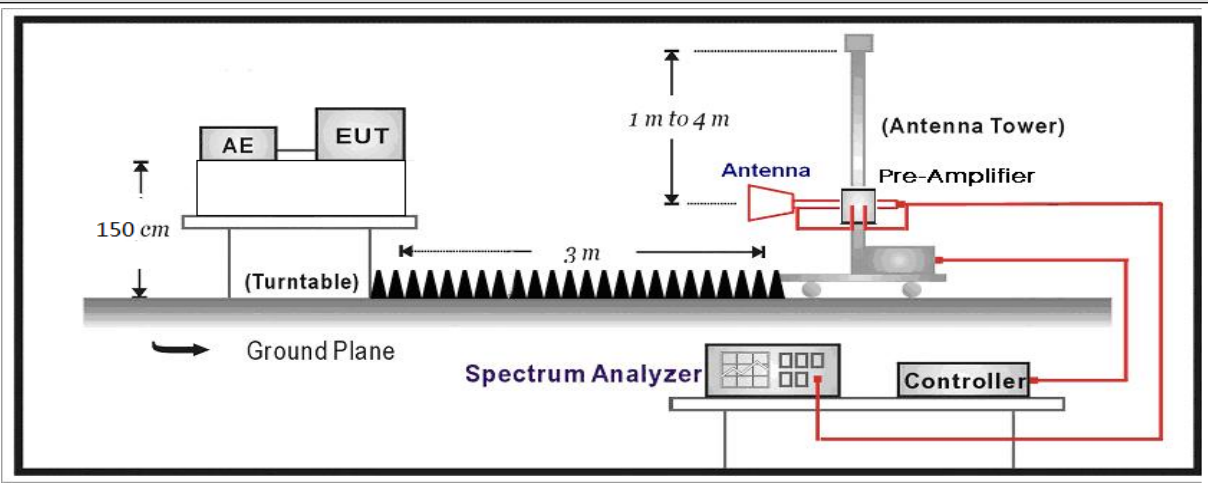

| 4.5.3 Test Procedure | | | |
|-------------------------------------|---|-------------|--|
| | References Rule | Chapter | Description |
| <input checked="" type="checkbox"/> | ANSI C63.10 | 6.10 | Band-edge testing |
| | <input checked="" type="checkbox"/> ANSI C63.10 | 6.10.5 | Restricted-band band-edge measurements |
| | <input type="checkbox"/> ANSI C63.10 | 6.10.6 | Marker-delta method |
| <input checked="" type="checkbox"/> | ANSI C63.10 | 11.12 | Emissions in restricted frequency bands |
| | <input checked="" type="checkbox"/> ANSI C63.10 | 11.12.1 | Radiated emission measurements |
| | <input checked="" type="checkbox"/> ANSI C63.10 | 11.12.2.7 | Radiated spurious emission test |
| <input type="checkbox"/> | ANSI C63.10 | 6.4 | Radiated emissions from unlicensed wireless devices below 30 MHz |
| <input type="checkbox"/> | ANSI C63.10 | 6.5 | Radiated emissions from unlicensed wireless devices in the frequency range of 30 MHz to 1000 MHz |
| <input checked="" type="checkbox"/> | ANSI C63.10 | 6.6 | Radiated emissions from unlicensed wireless devices above 1 GHz |
| | <input type="checkbox"/> ANSI C63.10 | 11.12.2 | Antenna-port conducted measurements |
| | <input type="checkbox"/> ANSI C63.10 | 11.12.2.3 | Quasi-peak measurement procedure |
| | <input type="checkbox"/> ANSI C63.10 | 11.12.2.4 | Peak power measurement procedure |
| | <input type="checkbox"/> ANSI C63.10 | 11.12.2.5 | Average power measurement procedures |
| | <input type="checkbox"/> ANSI C63.10 | 11.12.2.5.1 | Trace averaging with continuous EUT transmission at full power |
| | <input type="checkbox"/> ANSI C63.10 | 11.12.2.5.2 | Trace averaging across ON and OFF times of the EUT transmissions followed by duty cycle correction |
| | <input type="checkbox"/> ANSI C63.10 | 11.12.2.5.3 | Reduced VBW averaging across ON and OFF times of the EUT transmissions with max hold |

4.5.4 Test Data

| | |
|---|--------------------------|
| Engineer: Yingfei Wang | |
| Site: AC5 | Time: 2019/07/13 - 14:18 |
| Limit: FCC_Part15.209_RE(3m) | Margin: 0 |
| Probe: Horn_3117_00167055(1-18GHz) | Polarity: Vertical |
| EUT: WiFi Plug US | Power: AC 120V/60Hz |
| Note: Mode 1:Transmit at 2412MHz by 802.11b | |

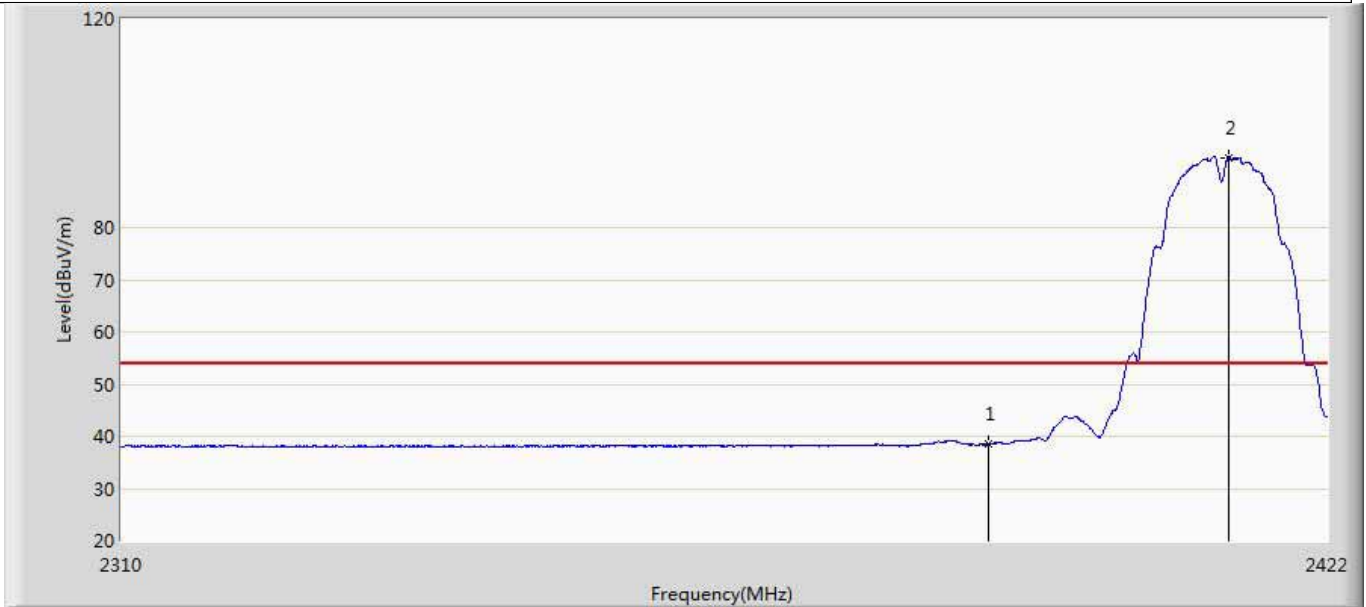

| No | Mark | Frequency (MHz) | Measure Level (dBuV/m) | Reading Level (dBuV) | Over Limit (dB) | Limit (dBuV/m) | Factor (dB) | Type |
|----|------|-----------------|------------------------|----------------------|-----------------|----------------|-------------|------|
| 1 | | 2390.000 | 38.473 | 2.791 | -15.527 | 54.000 | 35.682 | AV |
| 2 | * | 2412.648 | 93.450 | 57.706 | N/A | N/A | 35.744 | AV |

| | |
|---|--------------------------|
| Engineer: Yingfei Wang | |
| Site: AC5 | Time: 2019/07/13 - 14:27 |
| Limit: FCC_Part15.209_RE(3m) | Margin: 0 |
| Probe: Horn_3117_00167055(1-18GHz) | Polarity: Vertical |
| EUT: WiFi Plug US | Power: AC 120V/60Hz |
| Note: Mode 1:Transmit at 2412MHz by 802.11b | |

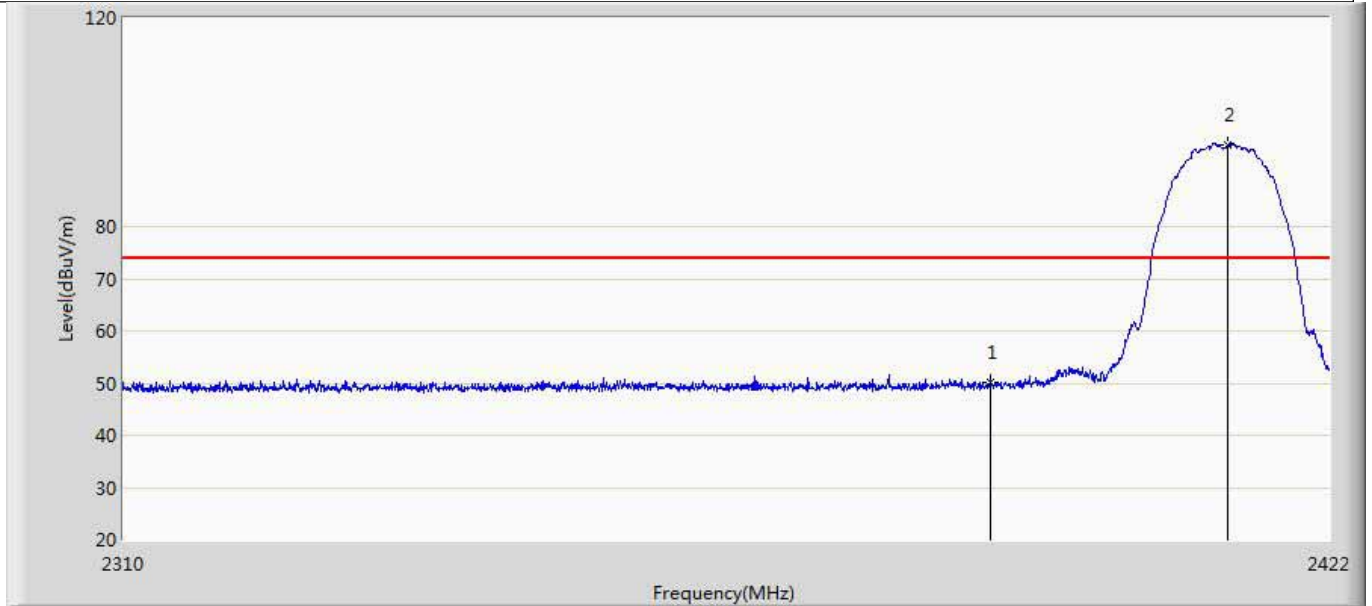

| No | Mark | Frequency (MHz) | Measure Level (dBuV/m) | Reading Level (dBuV) | Over Limit (dB) | Limit (dBuV/m) | Factor (dB) | Type |
|----|------|-----------------|------------------------|----------------------|-----------------|----------------|-------------|------|
| 1 | | 2390.000 | 50.137 | 14.455 | -23.863 | 74.000 | 35.682 | PK |
| 2 | * | 2412.424 | 95.608 | 59.865 | N/A | N/A | 35.743 | PK |

| | |
|---|--------------------------|
| Engineer: Yingfei Wang | |
| Site: AC5 | Time: 2019/07/13 - 14:30 |
| Limit: FCC_Part15.209_RE(3m) | Margin: 0 |
| Probe: Horn_3117_00167055(1-18GHz) | Polarity: Horizontal |
| EUT: WiFi Plug US | Power: AC 120V/60Hz |
| Note: Mode 1:Transmit at 2412MHz by 802.11b | |

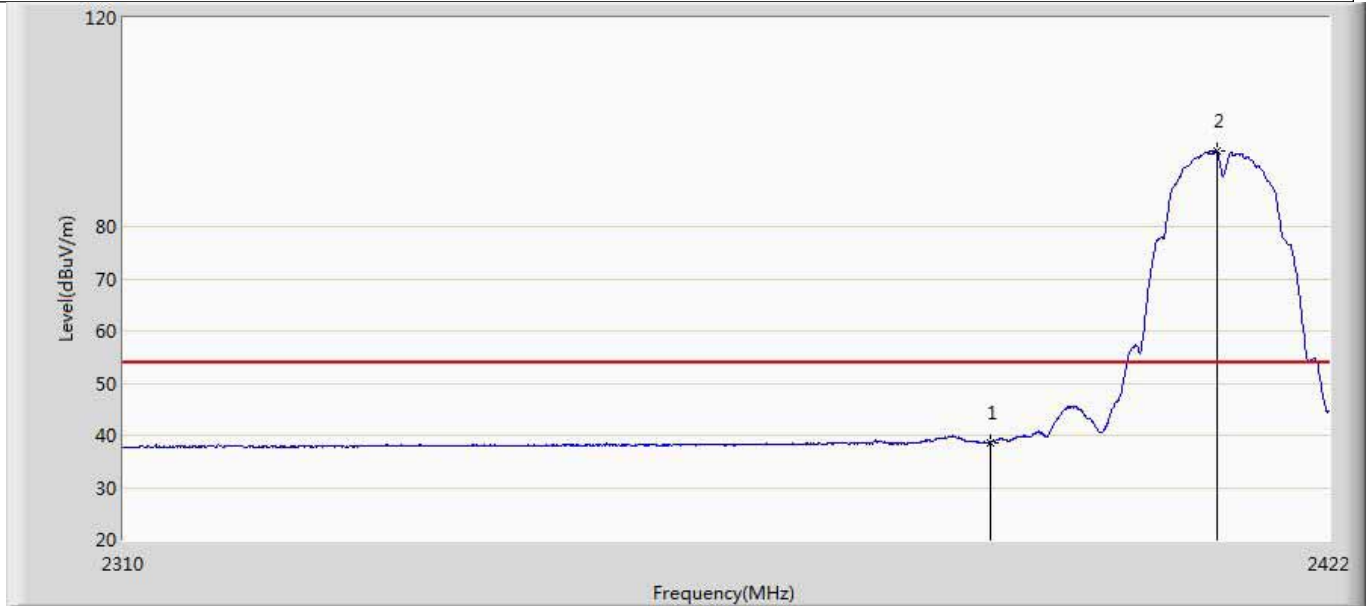

| No | Mark | Frequency (MHz) | Measure Level (dBuV/m) | Reading Level (dBuV) | Over Limit (dB) | Limit (dBuV/m) | Factor (dB) | Type |
|----|------|-----------------|------------------------|----------------------|-----------------|----------------|-------------|------|
| 1 | | 2390.000 | 38.613 | 2.931 | -15.387 | 54.000 | 35.682 | AV |
| 2 | * | 2411.360 | 94.419 | 58.680 | N/A | N/A | 35.738 | AV |

| | |
|---|--------------------------|
| Engineer: Yingfei Wang | |
| Site: AC5 | Time: 2019/07/13 - 14:32 |
| Limit: FCC_Part15.209_RE(3m) | Margin: 0 |
| Probe: Horn_3117_00167055(1-18GHz) | Polarity: Horizontal |
| EUT: WiFi Plug US | Power: AC 120V/60Hz |
| Note: Mode 1:Transmit at 2412MHz by 802.11b | |

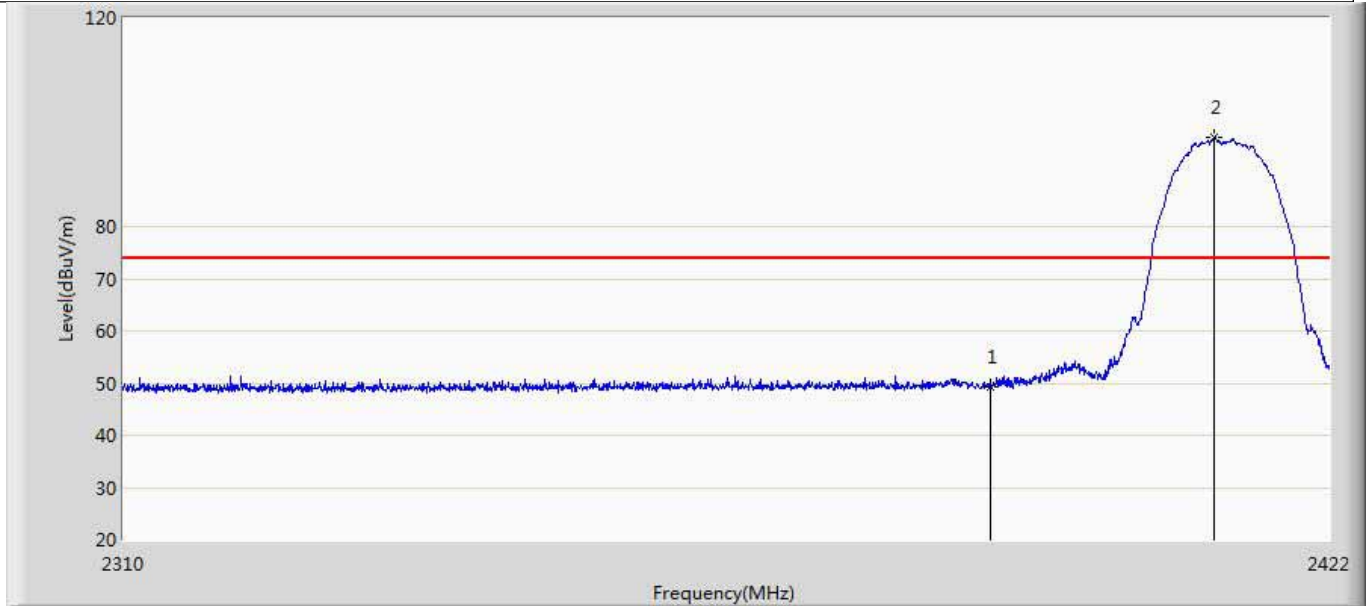

| No | Mark | Frequency (MHz) | Measure Level (dBuV/m) | Reading Level (dBuV) | Over Limit (dB) | Limit (dBuV/m) | Factor (dB) | Type |
|----|------|-----------------|------------------------|----------------------|-----------------|----------------|-------------|------|
| 1 | | 2390.000 | 49.296 | 13.614 | -24.704 | 74.000 | 35.682 | PK |
| 2 | * | 2411.080 | 96.986 | 61.248 | N/A | N/A | 35.737 | PK |

| | |
|---|--------------------------|
| Engineer: Yingfei Wang | |
| Site: AC5 | Time: 2019/07/13 - 15:52 |
| Limit: FCC_Part15.209_RE(3m) | Margin: 0 |
| Probe: Horn_3117_00167055(1-18GHz) | Polarity: Vertical |
| EUT: WiFi Plug US | Power: AC 120V/60Hz |
| Note: Mode 1:Transmit at 2462MHz by 802.11b | |

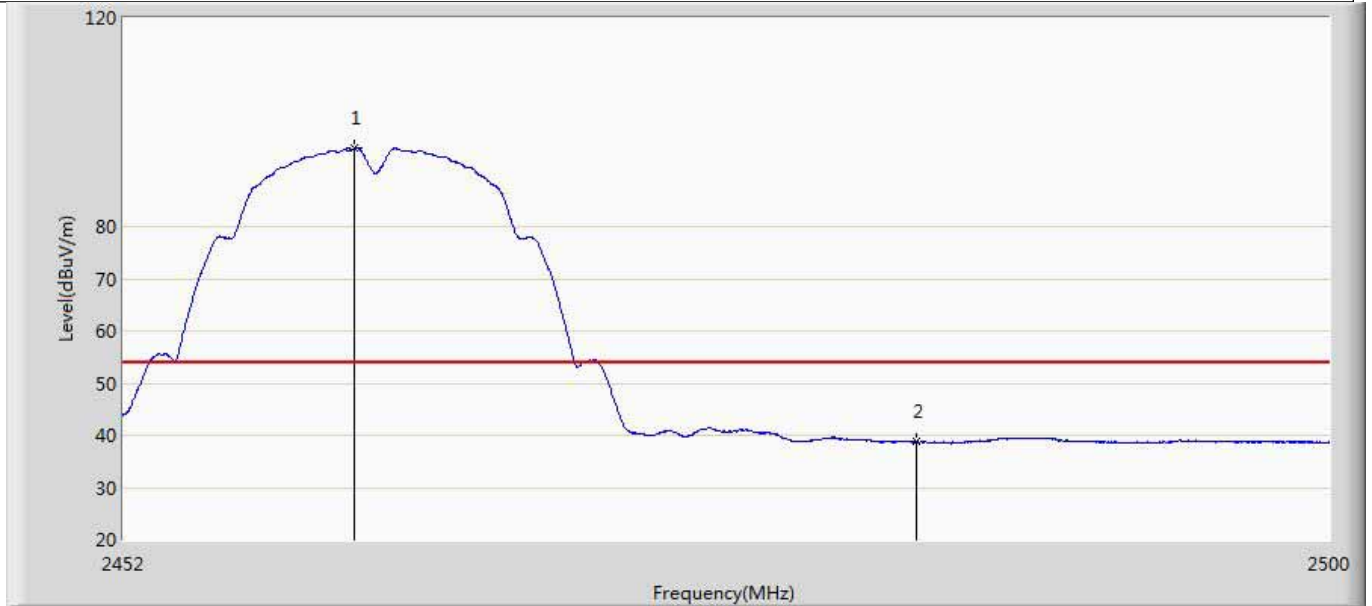

| No | Mark | Frequency (MHz) | Measure Level (dBuV/m) | Reading Level (dBuV) | Over Limit (dB) | Limit (dBuV/m) | Factor (dB) | Type |
|----|------|-----------------|------------------------|----------------------|-----------------|----------------|-------------|------|
| 1 | * | 2461.144 | 94.955 | 59.080 | N/A | N/A | 35.875 | AV |
| 2 | | 2483.500 | 38.770 | 2.878 | -15.230 | 54.000 | 35.891 | AV |

| | |
|---|--------------------------|
| Engineer: Yingfei Wang | |
| Site: AC5 | Time: 2019/07/13 - 15:58 |
| Limit: FCC_Part15.209_RE(3m) | Margin: 0 |
| Probe: Horn_3117_00167055(1-18GHz) | Polarity: Vertical |
| EUT: WiFi Plug US | Power: AC 120V/60Hz |
| Note: Mode 1:Transmit at 2462MHz by 802.11b | |

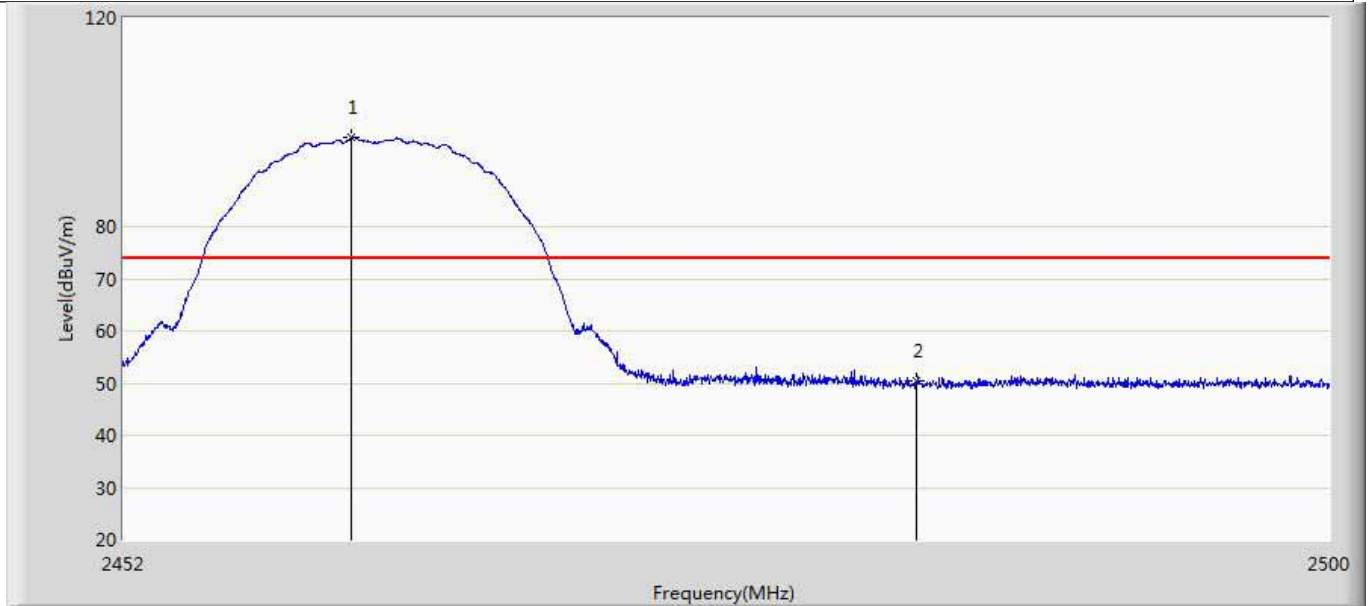

| No | Mark | Frequency (MHz) | Measure Level (dBuV/m) | Reading Level (dBuV) | Over Limit (dB) | Limit (dBuV/m) | Factor (dB) | Type |
|----|------|-----------------|------------------------|----------------------|-----------------|----------------|-------------|------|
| 1 | * | 2461.000 | 96.957 | 61.083 | N/A | N/A | 35.874 | PK |
| 2 | | 2483.500 | 50.308 | 14.416 | -23.692 | 74.000 | 35.891 | PK |

| | |
|---|--------------------------|
| Engineer: Yingfei Wang | |
| Site: AC5 | Time: 2019/07/13 - 16:00 |
| Limit: FCC_Part15.209_RE(3m) | Margin: 0 |
| Probe: Horn_3117_00167055(1-18GHz) | Polarity: Horizontal |
| EUT: WiFi Plug US | Power: AC 120V/60Hz |
| Note: Mode 1:Transmit at 2462MHz by 802.11b | |

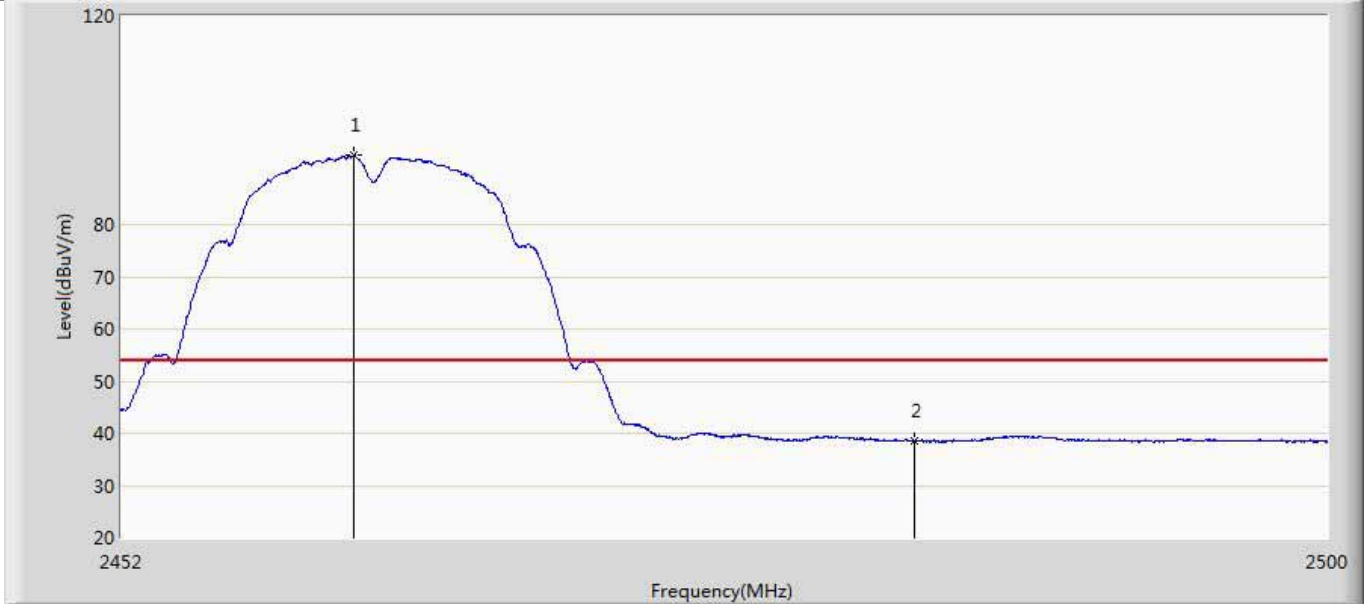

| No | Mark | Frequency (MHz) | Measure Level (dBuV/m) | Reading Level (dBuV) | Over Limit (dB) | Limit (dBuV/m) | Factor (dB) | Type |
|----|------|-----------------|------------------------|----------------------|-----------------|----------------|-------------|------|
| 1 | * | 2461.216 | 93.192 | 57.317 | N/A | N/A | 35.875 | AV |
| 2 | | 2483.500 | 38.601 | 2.709 | -15.399 | 54.000 | 35.891 | AV |

| | |
|---|--------------------------|
| Engineer: Yingfei Wang | |
| Site: AC5 | Time: 2019/07/13 - 16:11 |
| Limit: FCC_Part15.209_RE(3m) | Margin: 0 |
| Probe: Horn_3117_00167055(1-18GHz) | Polarity: Horizontal |
| EUT: WiFi Plug US | Power: AC 120V/60Hz |
| Note: Mode 1:Transmit at 2462MHz by 802.11b | |

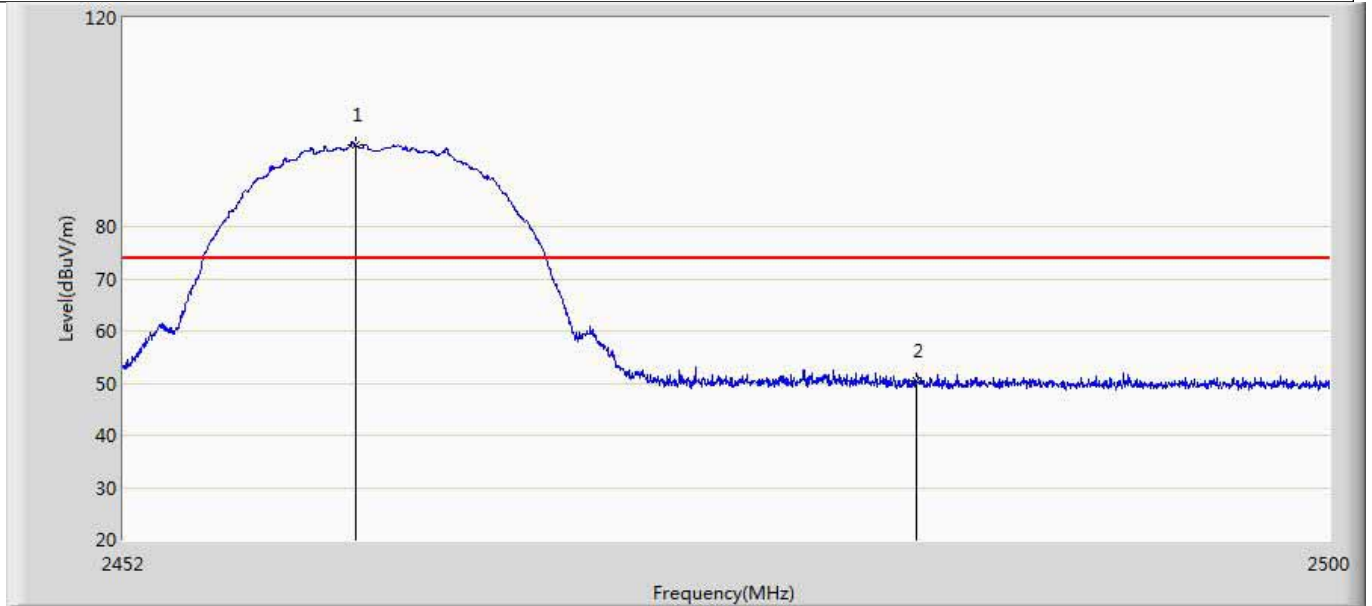

| No | Mark | Frequency (MHz) | Measure Level (dBuV/m) | Reading Level (dBuV) | Over Limit (dB) | Limit (dBuV/m) | Factor (dB) | Type |
|----|------|-----------------|------------------------|----------------------|-----------------|----------------|-------------|------|
| 1 | * | 2461.168 | 95.606 | 59.731 | N/A | N/A | 35.875 | PK |
| 2 | | 2483.500 | 50.544 | 14.652 | -23.456 | 74.000 | 35.891 | PK |

| | |
|---|--------------------------|
| Engineer: Yingfei Wang | |
| Site: AC5 | Time: 2019/07/13 - 16:20 |
| Limit: FCC_Part15.209_RE(3m) | Margin: 0 |
| Probe: Horn_3117_00167055(1-18GHz) | Polarity: Vertical |
| EUT: WiFi Plug US | Power: AC 120V/60Hz |
| Note: Mode 2:Transmit at 2412MHz by 802.11g | |

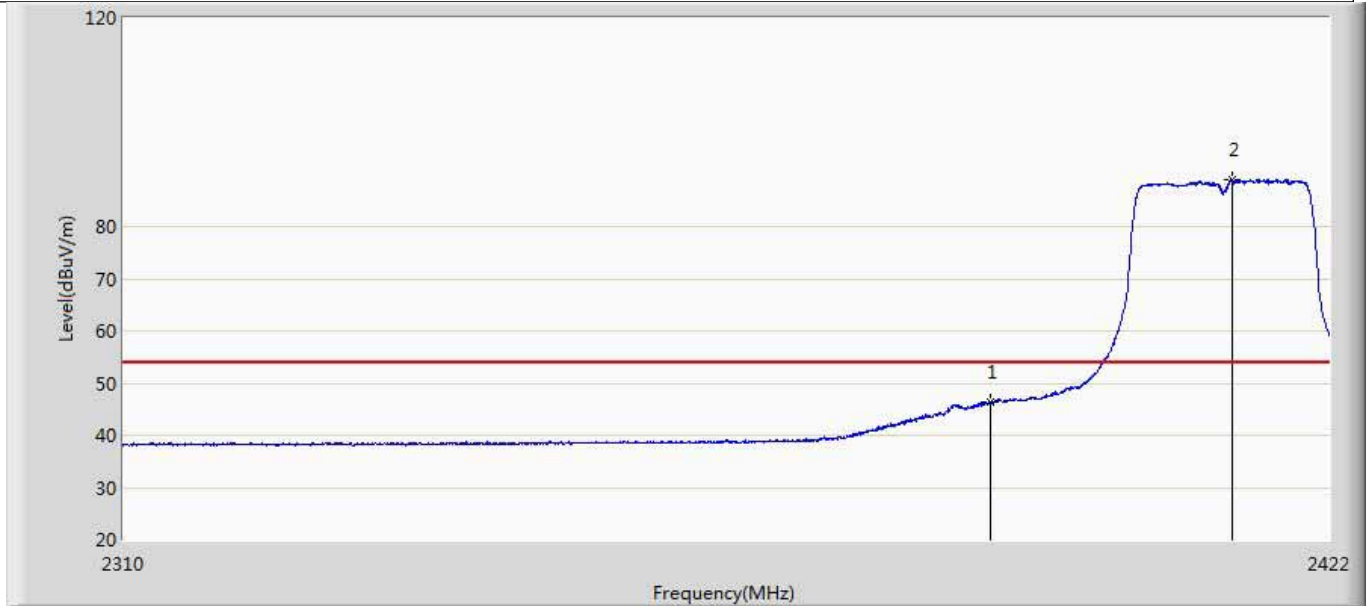

| No | Mark | Frequency (MHz) | Measure Level (dBuV/m) | Reading Level (dBuV) | Over Limit (dB) | Limit (dBuV/m) | Factor (dB) | Type |
|----|------|-----------------|------------------------|----------------------|-----------------|----------------|-------------|------|
| 1 | | 2390.000 | 46.420 | 10.738 | -7.580 | 54.000 | 35.682 | AV |
| 2 | * | 2412.816 | 88.929 | 53.184 | N/A | N/A | 35.745 | AV |

| | |
|---|--------------------------|
| Engineer: Yingfei Wang | |
| Site: AC5 | Time: 2019/07/13 - 16:27 |
| Limit: FCC_Part15.209_RE(3m) | Margin: 0 |
| Probe: Horn_3117_00167055(1-18GHz) | Polarity: Vertical |
| EUT: WiFi Plug US | Power: AC 120V/60Hz |
| Note: Mode 2:Transmit at 2412MHz by 802.11g | |

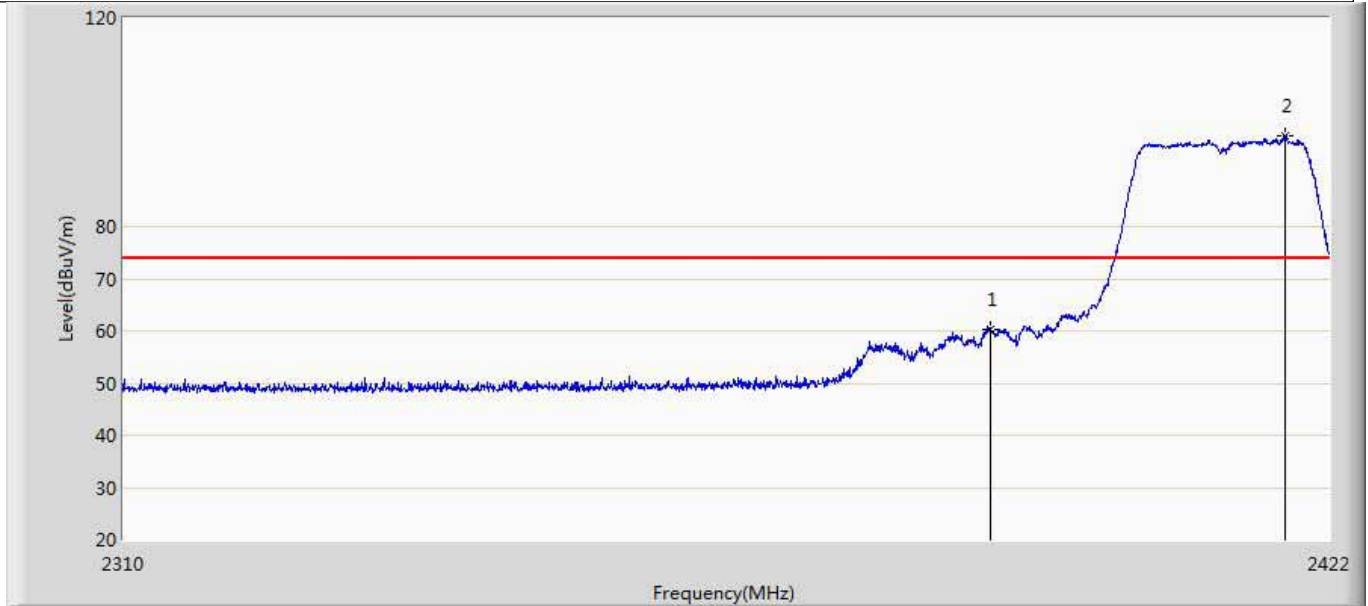

| No | Mark | Frequency (MHz) | Measure Level (dBuV/m) | Reading Level (dBuV) | Over Limit (dB) | Limit (dBuV/m) | Factor (dB) | Type |
|----|------|-----------------|------------------------|----------------------|-----------------|----------------|-------------|------|
| 1 | | 2390.000 | 60.354 | 24.672 | -13.646 | 74.000 | 35.682 | PK |
| 2 | * | 2417.800 | 97.465 | 61.699 | N/A | N/A | 35.765 | PK |

| | |
|---|--------------------------|
| Engineer: Yingfei Wang | |
| Site: AC5 | Time: 2019/07/13 - 16:30 |
| Limit: FCC_Part15.209_RE(3m) | Margin: 0 |
| Probe: Horn_3117_00167055(1-18GHz) | Polarity: Horizontal |
| EUT: WiFi Plug US | Power: AC 120V/60Hz |
| Note: Mode 2:Transmit at 2412MHz by 802.11g | |

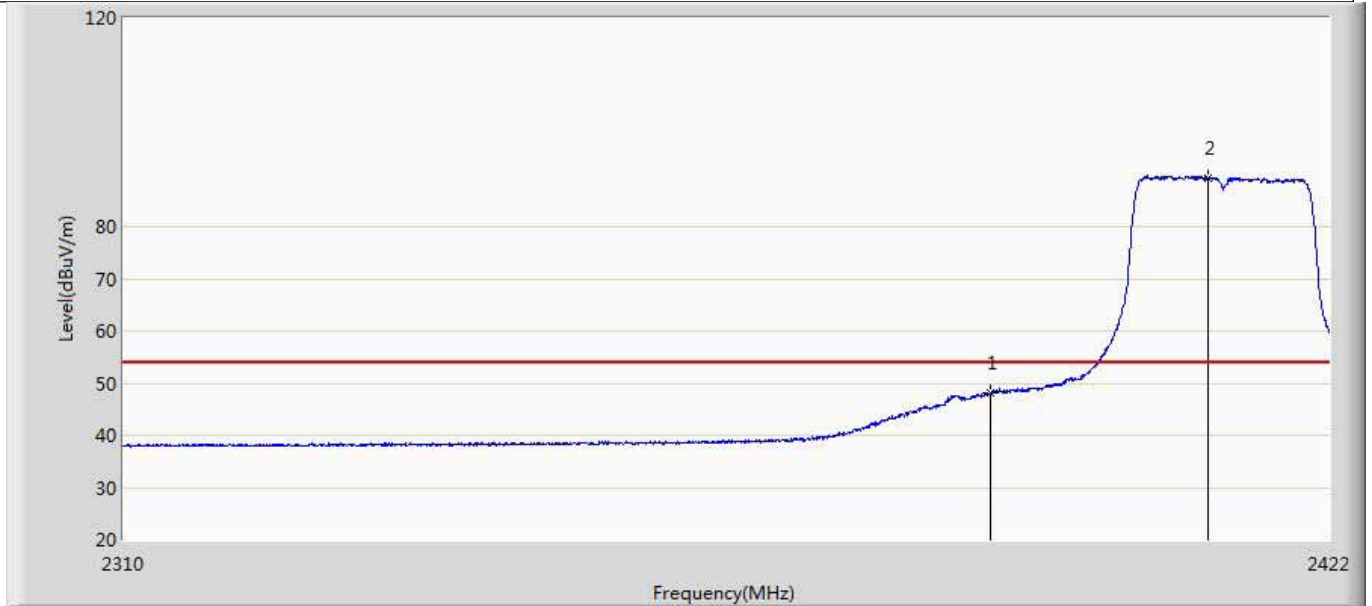

| No | Mark | Frequency (MHz) | Measure Level (dBuV/m) | Reading Level (dBuV) | Over Limit (dB) | Limit (dBuV/m) | Factor (dB) | Type |
|----|------|-----------------|------------------------|----------------------|-----------------|----------------|-------------|------|
| 1 | | 2390.000 | 48.058 | 12.376 | -5.942 | 54.000 | 35.682 | AV |
| 2 | * | 2410.520 | 89.411 | 53.675 | N/A | N/A | 35.735 | AV |

| | |
|---|--------------------------|
| Engineer: Yingfei Wang | |
| Site: AC5 | Time: 2019/07/13 - 16:32 |
| Limit: FCC_Part15.209_RE(3m) | Margin: 0 |
| Probe: Horn_3117_00167055(1-18GHz) | Polarity: Horizontal |
| EUT: WiFi Plug US | Power: AC 120V/60Hz |
| Note: Mode 2:Transmit at 2412MHz by 802.11g | |

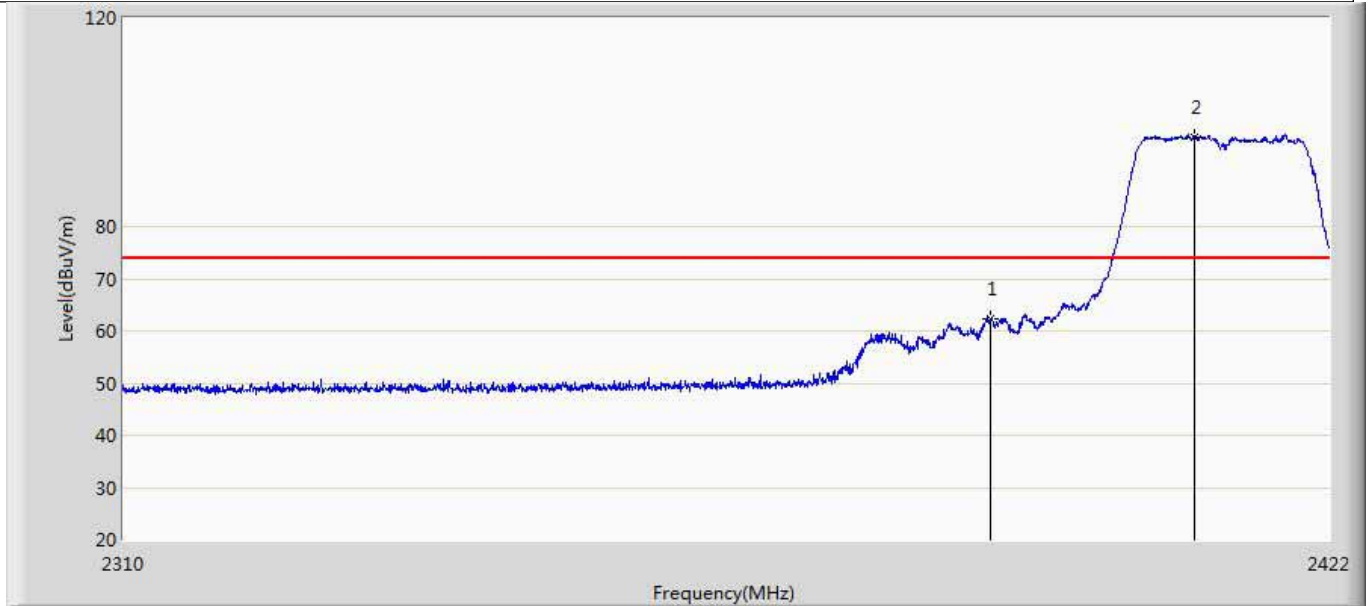

| No | Mark | Frequency (MHz) | Measure Level (dBuV/m) | Reading Level (dBuV) | Over Limit (dB) | Limit (dBuV/m) | Factor (dB) | Type |
|----|------|-----------------|------------------------|----------------------|-----------------|----------------|-------------|------|
| 1 | | 2390.000 | 62.240 | 26.558 | -11.760 | 74.000 | 35.682 | PK |
| 2 | * | 2409.232 | 97.143 | 61.411 | N/A | N/A | 35.732 | PK |

| | |
|---|--------------------------|
| Engineer: Yingfei Wang | |
| Site: AC5 | Time: 2019/07/13 - 16:36 |
| Limit: FCC_Part15.209_RE(3m) | Margin: 0 |
| Probe: Horn_3117_00167055(1-18GHz) | Polarity: Vertical |
| EUT: WiFi Plug US | Power: AC 120V/60Hz |
| Note: Mode 2:Transmit at 2462MHz by 802.11g | |

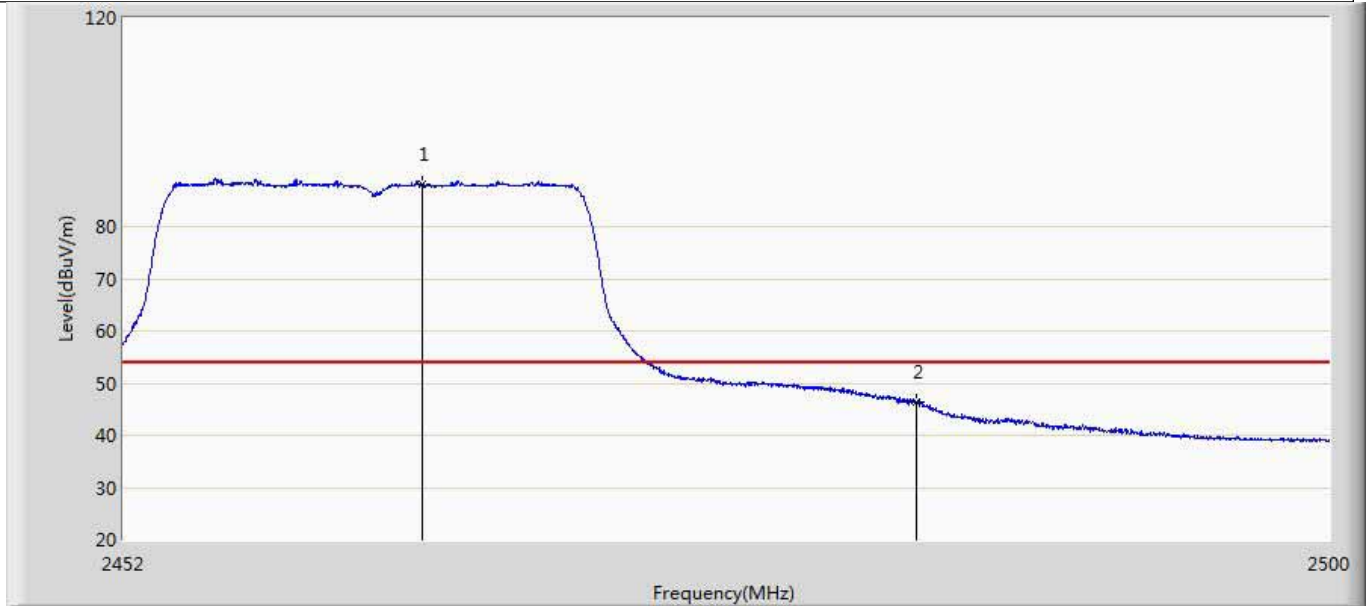

| No | Mark | Frequency (MHz) | Measure Level (dBuV/m) | Reading Level (dBuV) | Over Limit (dB) | Limit (dBuV/m) | Factor (dB) | Type |
|----|------|-----------------|------------------------|----------------------|-----------------|----------------|-------------|------|
| 1 | * | 2463.832 | 88.017 | 52.141 | N/A | N/A | 35.876 | AV |
| 2 | | 2483.500 | 46.262 | 10.370 | -7.738 | 54.000 | 35.891 | AV |

| | |
|---|--------------------------|
| Engineer: Yingfei Wang | |
| Site: AC5 | Time: 2019/07/13 - 16:39 |
| Limit: FCC_Part15.209_RE(3m) | Margin: 0 |
| Probe: Horn_3117_00167055(1-18GHz) | Polarity: Vertical |
| EUT: WiFi Plug US | Power: AC 120V/60Hz |
| Note: Mode 2:Transmit at 2462MHz by 802.11g | |

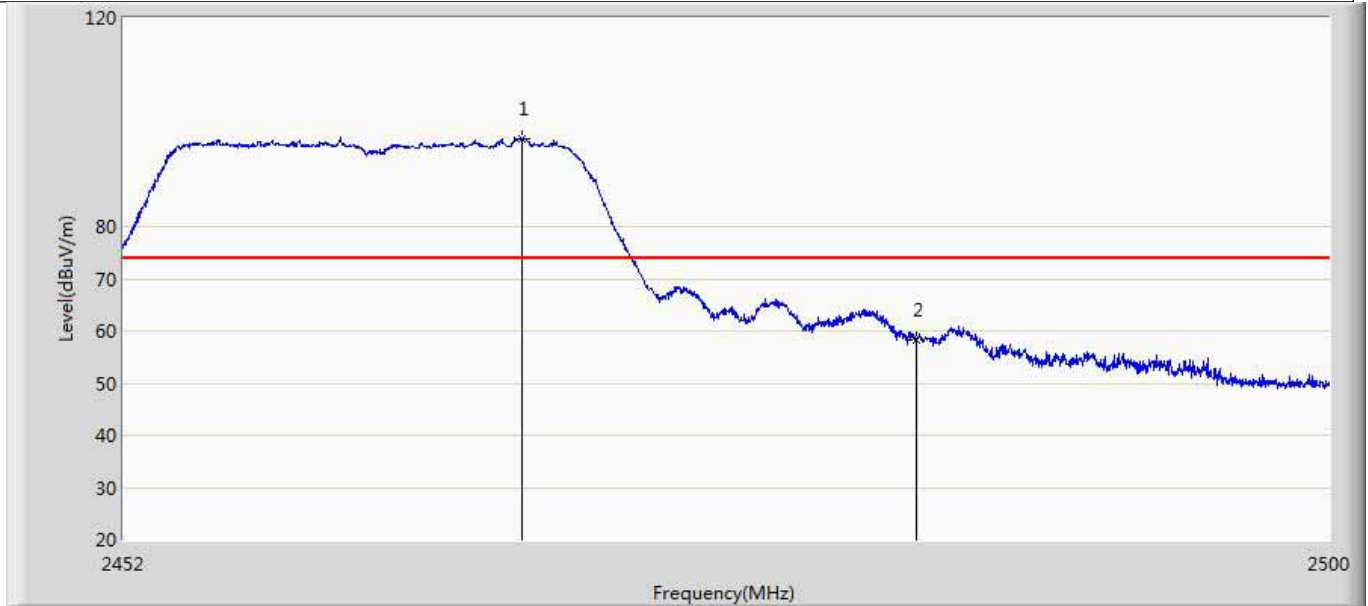

| No | Mark | Frequency (MHz) | Measure Level (dBuV/m) | Reading Level (dBuV) | Over Limit (dB) | Limit (dBuV/m) | Factor (dB) | Type |
|----|------|-----------------|------------------------|----------------------|-----------------|----------------|-------------|------|
| 1 | * | 2467.792 | 96.923 | 61.051 | N/A | N/A | 35.872 | PK |
| 2 | | 2483.500 | 58.403 | 22.511 | -15.597 | 74.000 | 35.891 | PK |

| | |
|---|--------------------------|
| Engineer: Yingfei Wang | |
| Site: AC5 | Time: 2019/07/13 - 16:41 |
| Limit: FCC_Part15.209_RE(3m) | Margin: 0 |
| Probe: Horn_3117_00167055(1-18GHz) | Polarity: Horizontal |
| EUT: WiFi Plug US | Power: AC 120V/60Hz |
| Note: Mode 2:Transmit at 2462MHz by 802.11g | |

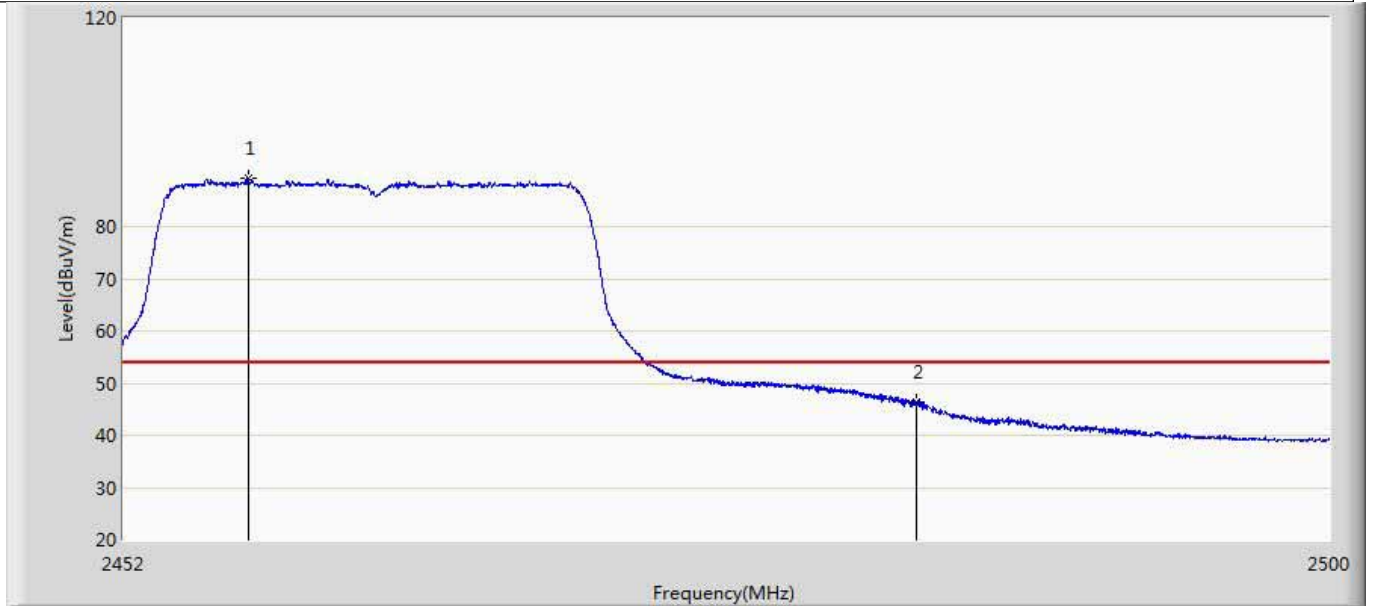

| No | Mark | Frequency (MHz) | Measure Level (dBuV/m) | Reading Level (dBuV) | Over Limit (dB) | Limit (dBuV/m) | Factor (dB) | Type |
|----|------|-----------------|------------------------|----------------------|-----------------|----------------|-------------|------|
| 1 | * | 2456.920 | 89.135 | 53.279 | N/A | N/A | 35.856 | AV |
| 2 | | 2483.500 | 46.313 | 10.421 | -7.687 | 54.000 | 35.891 | AV |

| | |
|---|--------------------------|
| Engineer: Yingfei Wang | |
| Site: AC5 | Time: 2019/07/13 - 16:44 |
| Limit: FCC_Part15.209_RE(3m) | Margin: 0 |
| Probe: Horn_3117_00167055(1-18GHz) | Polarity: Horizontal |
| EUT: WiFi Plug US | Power: AC 120V/60Hz |
| Note: Mode 2:Transmit at 2462MHz by 802.11g | |

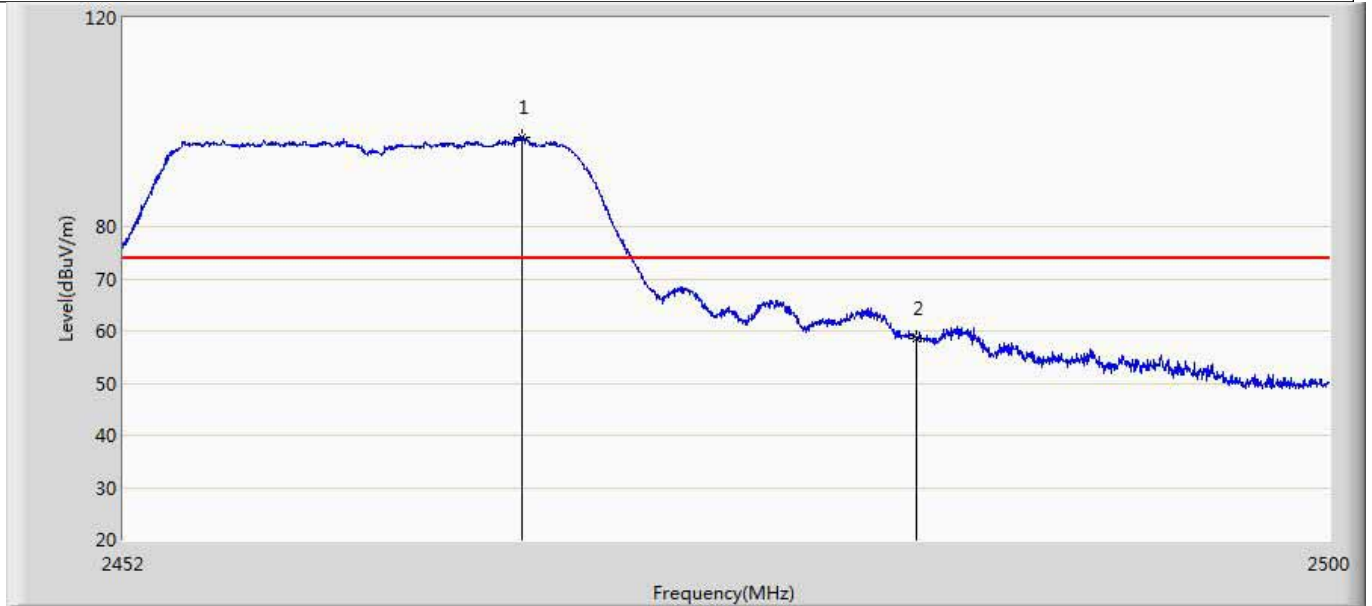

| No | Mark | Frequency (MHz) | Measure Level (dBuV/m) | Reading Level (dBuV) | Over Limit (dB) | Limit (dBuV/m) | Factor (dB) | Type |
|----|------|-----------------|------------------------|----------------------|-----------------|----------------|-------------|------|
| 1 | * | 2467.792 | 97.245 | 61.373 | N/A | N/A | 35.872 | PK |
| 2 | | 2483.500 | 58.610 | 22.718 | -15.390 | 74.000 | 35.891 | PK |

| | |
|---|--------------------------|
| Engineer: Yingfei Wang | |
| Site: AC5 | Time: 2019/07/13 - 16:51 |
| Limit: FCC_Part15.209_RE(3m) | Margin: 0 |
| Probe: Horn_3117_00167055(1-18GHz) | Polarity: Vertical |
| EUT: WiFi Plug US | Power: AC 120V/60Hz |
| Note: Mode 3:Transmit at 2412MHz by 802.11n20 | |

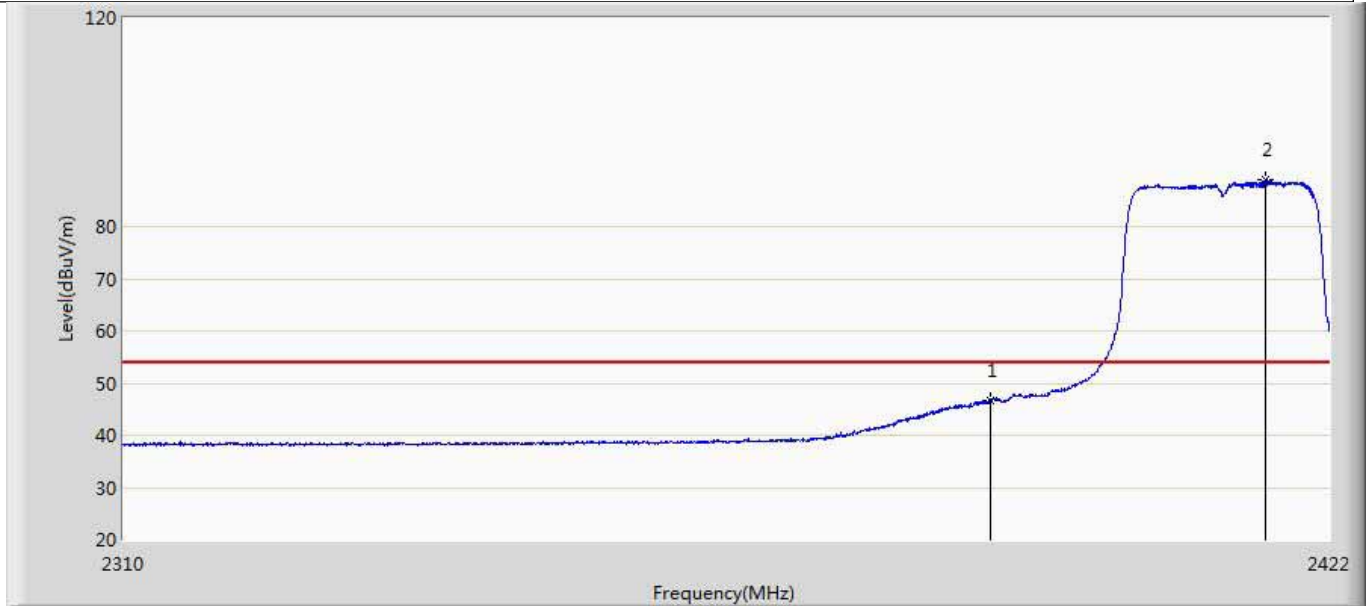

| No | Mark | Frequency (MHz) | Measure Level (dBuV/m) | Reading Level (dBuV) | Over Limit (dB) | Limit (dBuV/m) | Factor (dB) | Type |
|----|------|-----------------|------------------------|----------------------|-----------------|----------------|-------------|------|
| 1 | | 2390.000 | 46.680 | 10.998 | -7.320 | 54.000 | 35.682 | AV |
| 2 | * | 2416.008 | 88.848 | 53.090 | N/A | N/A | 35.758 | AV |

| | |
|---|--------------------------|
| Engineer: Yingfei Wang | |
| Site: AC5 | Time: 2019/07/13 - 16:52 |
| Limit: FCC_Part15.209_RE(3m) | Margin: 0 |
| Probe: Horn_3117_00167055(1-18GHz) | Polarity: Vertical |
| EUT: WiFi Plug US | Power: AC 120V/60Hz |
| Note: Mode 3:Transmit at 2412MHz by 802.11n20 | |

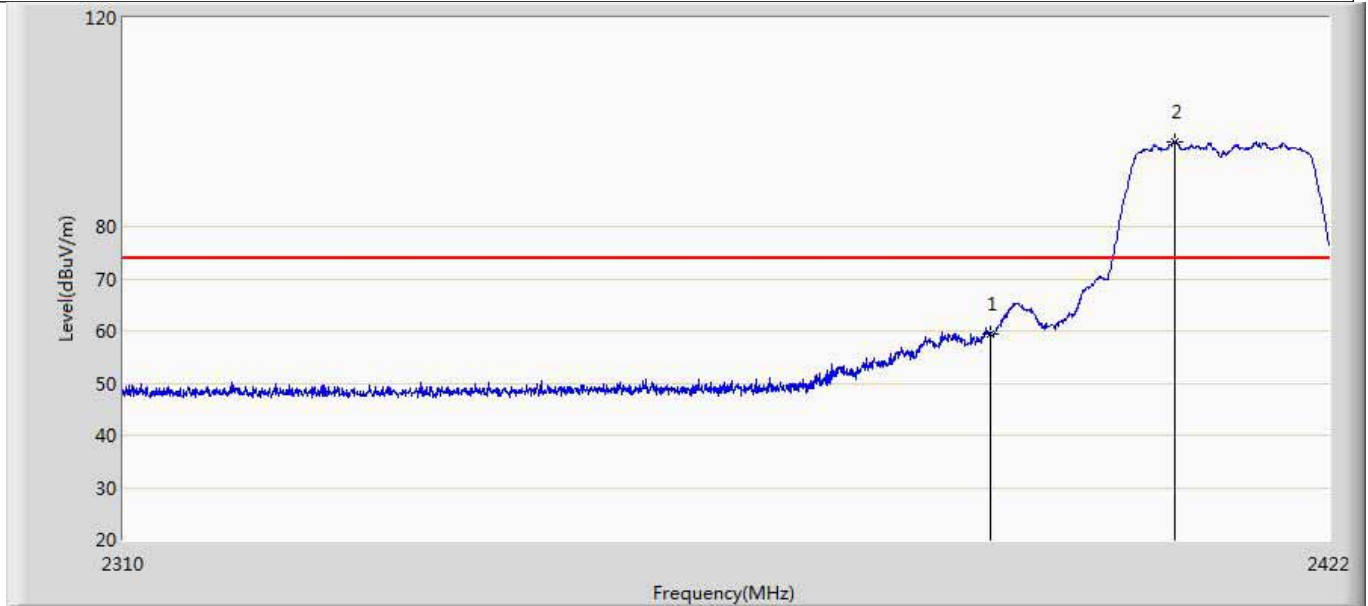

| No | Mark | Frequency (MHz) | Measure Level (dBuV/m) | Reading Level (dBuV) | Over Limit (dB) | Limit (dBuV/m) | Factor (dB) | Type |
|----|------|-----------------|------------------------|----------------------|-----------------|----------------|-------------|------|
| 1 | | 2390.000 | 59.370 | 23.688 | -14.630 | 74.000 | 35.682 | PK |
| 2 | * | 2407.328 | 96.288 | 60.561 | N/A | N/A | 35.728 | PK |

| | |
|---|--------------------------|
| Engineer: Yingfei Wang | |
| Site: AC5 | Time: 2019/07/13 - 17:12 |
| Limit: FCC_Part15.209_RE(3m) | Margin: 0 |
| Probe: Horn_3117_00167055(1-18GHz) | Polarity: Horizontal |
| EUT: WiFi Plug US | Power: AC 120V/60Hz |
| Note: Mode 3:Transmit at 2412MHz by 802.11n20 | |

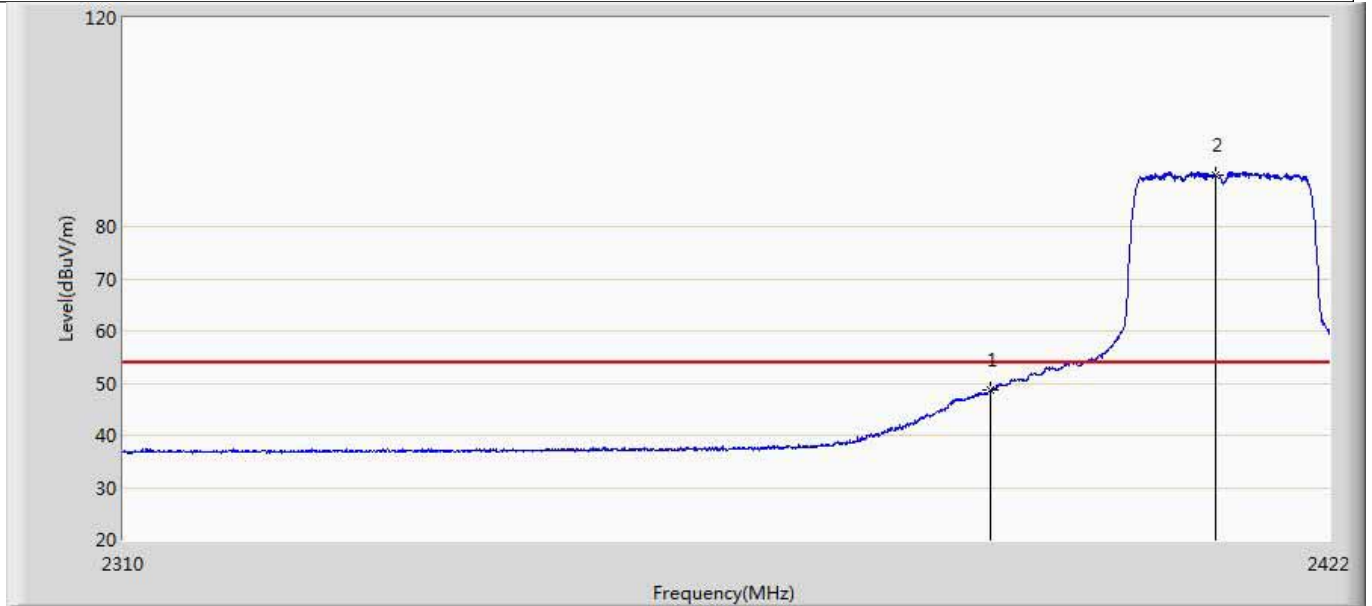

| No | Mark | Frequency (MHz) | Measure Level (dBuV/m) | Reading Level (dBuV) | Over Limit (dB) | Limit (dBuV/m) | Factor (dB) | Type |
|----|------|-----------------|------------------------|----------------------|-----------------|----------------|-------------|------|
| 1 | | 2390.000 | 48.649 | 12.967 | -5.351 | 54.000 | 35.682 | AV |
| 2 | * | 2411.192 | 89.919 | 54.181 | N/A | N/A | 35.738 | AV |

| | |
|---|--------------------------|
| Engineer: Yingfei Wang | |
| Site: AC5 | Time: 2019/07/13 - 17:24 |
| Limit: FCC_Part15.209_RE(3m) | Margin: 0 |
| Probe: Horn_3117_00167055(1-18GHz) | Polarity: Horizontal |
| EUT: WiFi Plug US | Power: AC 120V/60Hz |
| Note: Mode 3:Transmit at 2412MHz by 802.11n20 | |

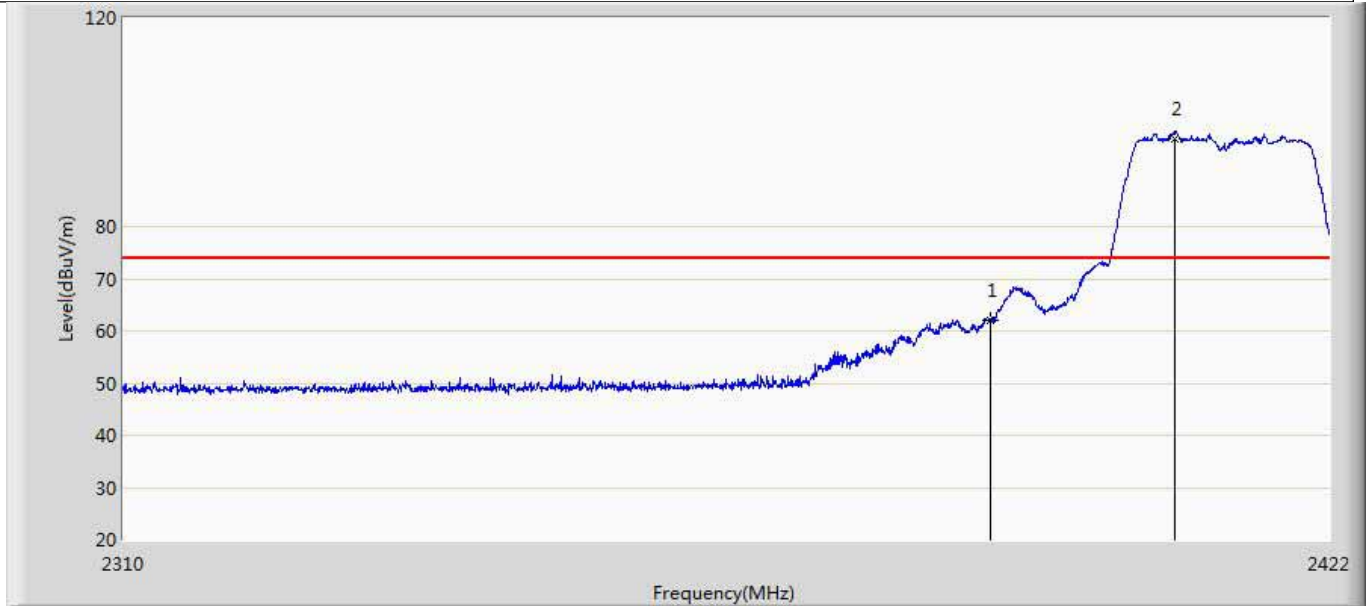

| No | Mark | Frequency (MHz) | Measure Level (dBuV/m) | Reading Level (dBuV) | Over Limit (dB) | Limit (dBuV/m) | Factor (dB) | Type |
|----|------|-----------------|------------------------|----------------------|-----------------|----------------|-------------|------|
| 1 | | 2390.000 | 62.050 | 26.368 | -11.950 | 74.000 | 35.682 | PK |
| 2 | * | 2407.440 | 96.868 | 61.140 | N/A | N/A | 35.728 | PK |

| | |
|---|--------------------------|
| Engineer: Yingfei Wang | |
| Site: AC5 | Time: 2019/07/13 - 17:36 |
| Limit: FCC_Part15.209_RE(3m) | Margin: 0 |
| Probe: Horn_3117_00167055(1-18GHz) | Polarity: Vertical |
| EUT: WiFi Plug US | Power: AC 120V/60Hz |
| Note: Mode 3:Transmit at 2462MHz by 802.11n20 | |

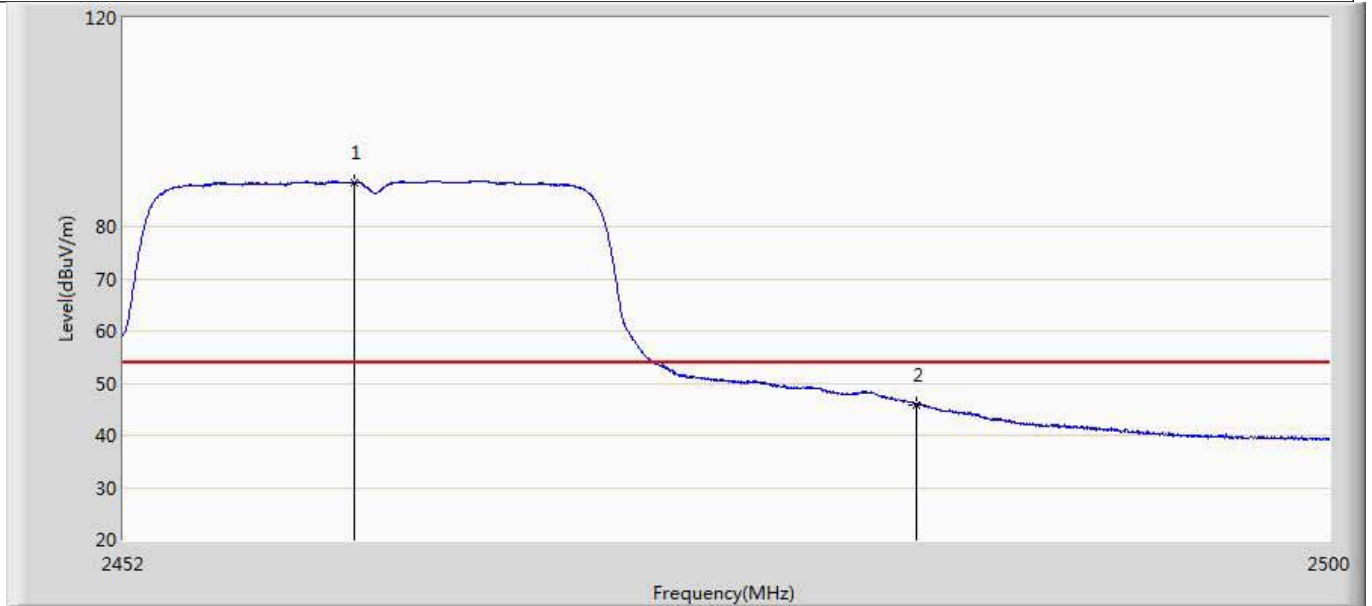

| No | Mark | Frequency (MHz) | Measure Level (dBuV/m) | Reading Level (dBuV) | Over Limit (dB) | Limit (dBuV/m) | Factor (dB) | Type |
|----|------|-----------------|------------------------|----------------------|-----------------|----------------|-------------|------|
| 1 | * | 2461.144 | 88.535 | 52.660 | N/A | N/A | 35.875 | AV |
| 2 | | 2483.500 | 45.893 | 10.001 | -8.107 | 54.000 | 35.891 | AV |

| | |
|---|--------------------------|
| Engineer: Yingfei Wang | |
| Site: AC5 | Time: 2019/07/13 - 17:40 |
| Limit: FCC_Part15.209_RE(3m) | Margin: 0 |
| Probe: Horn_3117_00167055(1-18GHz) | Polarity: Vertical |
| EUT: WiFi Plug US | Power: AC 120V/60Hz |
| Note: Mode 3:Transmit at 2462MHz by 802.11n20 | |

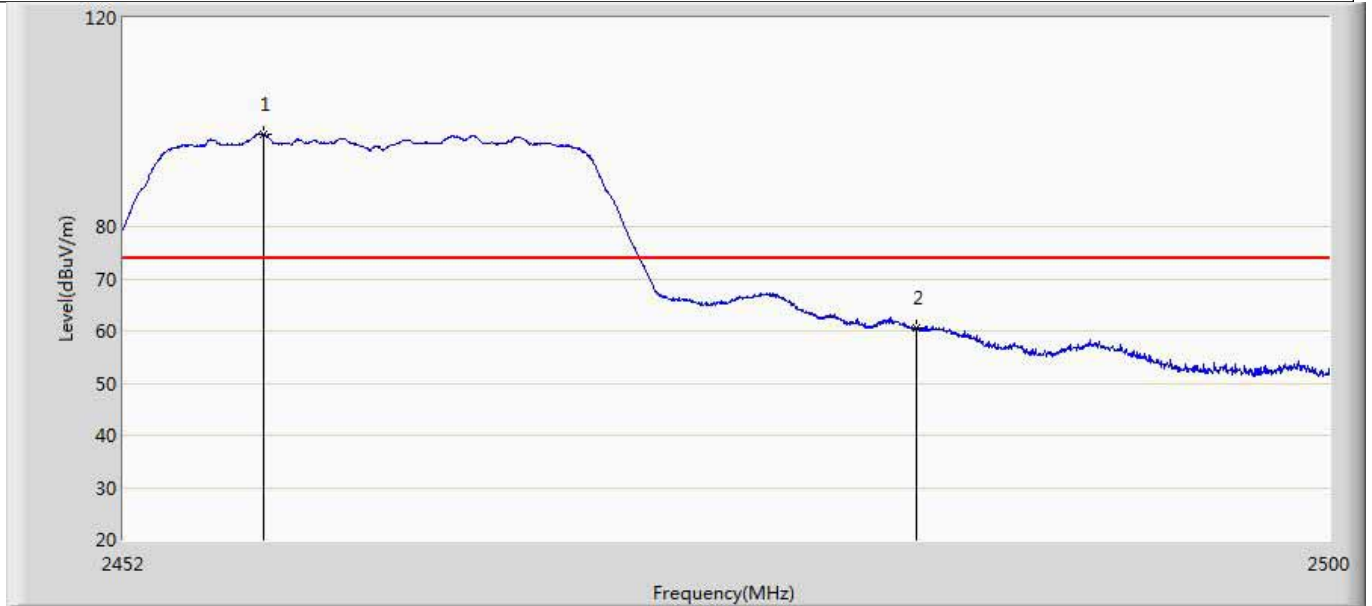

| No | Mark | Frequency (MHz) | Measure Level (dBuV/m) | Reading Level (dBuV) | Over Limit (dB) | Limit (dBuV/m) | Factor (dB) | Type |
|----|------|-----------------|------------------------|----------------------|-----------------|----------------|-------------|------|
| 1 | * | 2457.568 | 97.554 | 61.695 | N/A | N/A | 35.859 | PK |
| 2 | | 2483.500 | 60.545 | 24.653 | -13.455 | 74.000 | 35.891 | PK |

| | |
|---|--------------------------|
| Engineer: Yingfei Wang | |
| Site: AC5 | Time: 2019/07/13 - 18:00 |
| Limit: FCC_Part15.209_RE(3m) | Margin: 0 |
| Probe: Horn_3117_00167055(1-18GHz) | Polarity: Horizontal |
| EUT: WiFi Plug US | Power: AC 120V/60Hz |
| Note: Mode 3:Transmit at 2462MHz by 802.11n20 | |

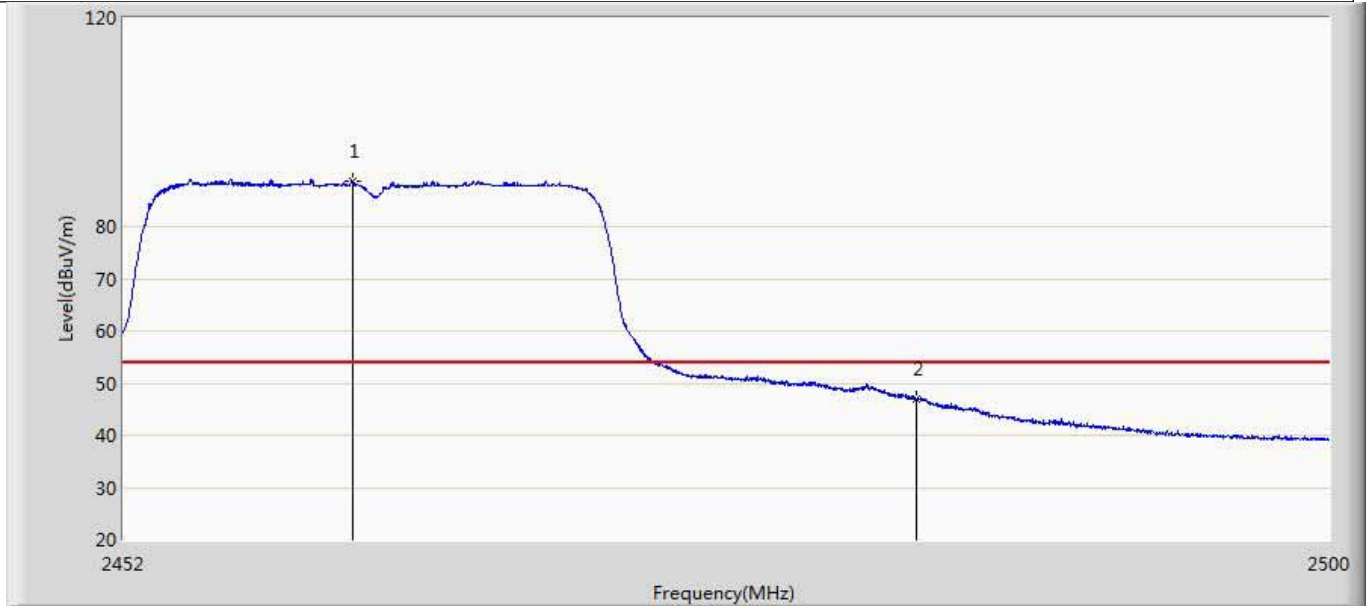

| No | Mark | Frequency (MHz) | Measure Level (dBuV/m) | Reading Level (dBuV) | Over Limit (dB) | Limit (dBuV/m) | Factor (dB) | Type |
|----|------|-----------------|------------------------|----------------------|-----------------|----------------|-------------|------|
| 1 | * | 2461.072 | 88.659 | 52.785 | N/A | N/A | 35.874 | AV |
| 2 | | 2483.500 | 46.948 | 11.056 | -7.052 | 54.000 | 35.891 | AV |

| | |
|---|--------------------------|
| Engineer: Yingfei Wang | |
| Site: AC5 | Time: 2019/07/13 - 18:04 |
| Limit: FCC_Part15.209_RE(3m) | Margin: 0 |
| Probe: Horn_3117_00167055(1-18GHz) | Polarity: Horizontal |
| EUT: WiFi Plug US | Power: AC 120V/60Hz |
| Note: Mode 3:Transmit at 2462MHz by 802.11n20 | |

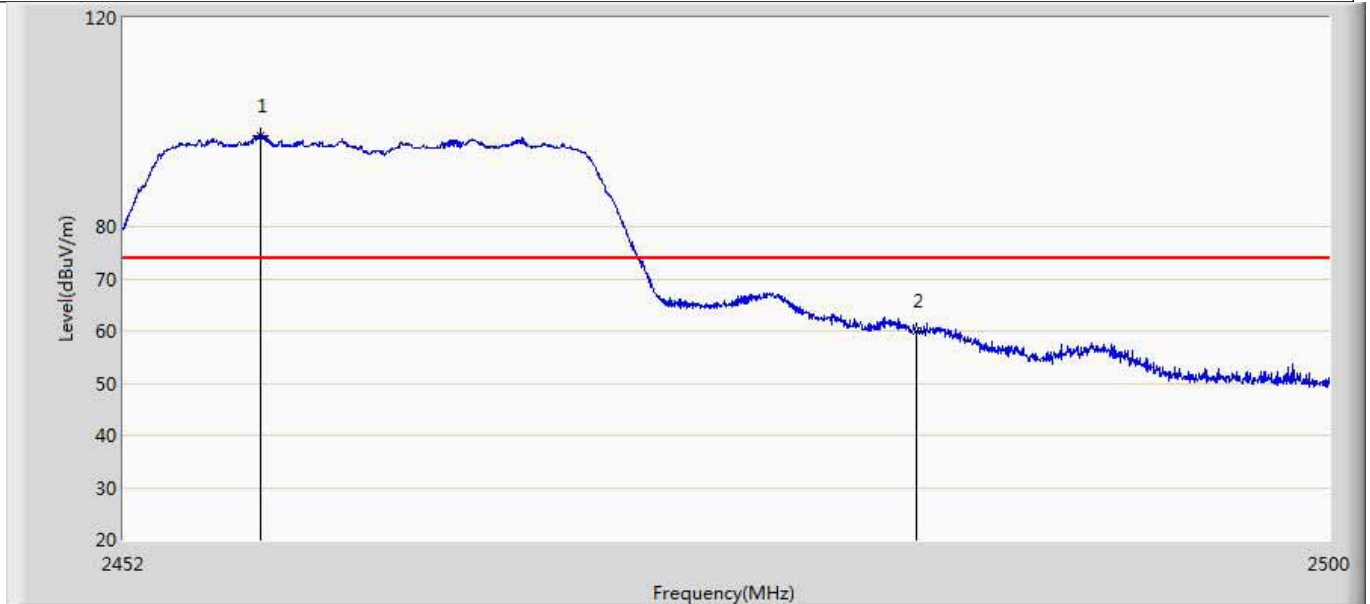

| No | Mark | Frequency (MHz) | Measure Level (dBuV/m) | Reading Level (dBuV) | Over Limit (dB) | Limit (dBuV/m) | Factor (dB) | Type |
|----|------|-----------------|------------------------|----------------------|-----------------|----------------|-------------|------|
| 1 | * | 2457.424 | 97.532 | 61.674 | N/A | N/A | 35.859 | PK |
| 2 | | 2483.500 | 59.903 | 24.011 | -14.097 | 74.000 | 35.891 | PK |

| | |
|--------|---|
| Remark | <p>1. " * ", means this data is the worst emission level.</p> <p>2. Measurement Level = Reading Level + Factor(Probe+Cable-Amp).</p> <p>3. The complete raw data please refer to Appendix RSE, Shown in the report is the worst data.</p> |
|--------|---|

| | |
|--------------------------|----------------------|
| 4.6 DTS Bandwidth | VERDICT: PASS |
|--------------------------|----------------------|

| | |
|--|---|
| 4.6.1 Limit | |
| Standard | FCC Part 15 Subpart C Paragraph 15.247 (a)(2) |
| Systems using digital modulation techniques operate in the 2400-2483.5 MHz. The minimum 6 dB bandwidth shall be at least 500 kHz | |

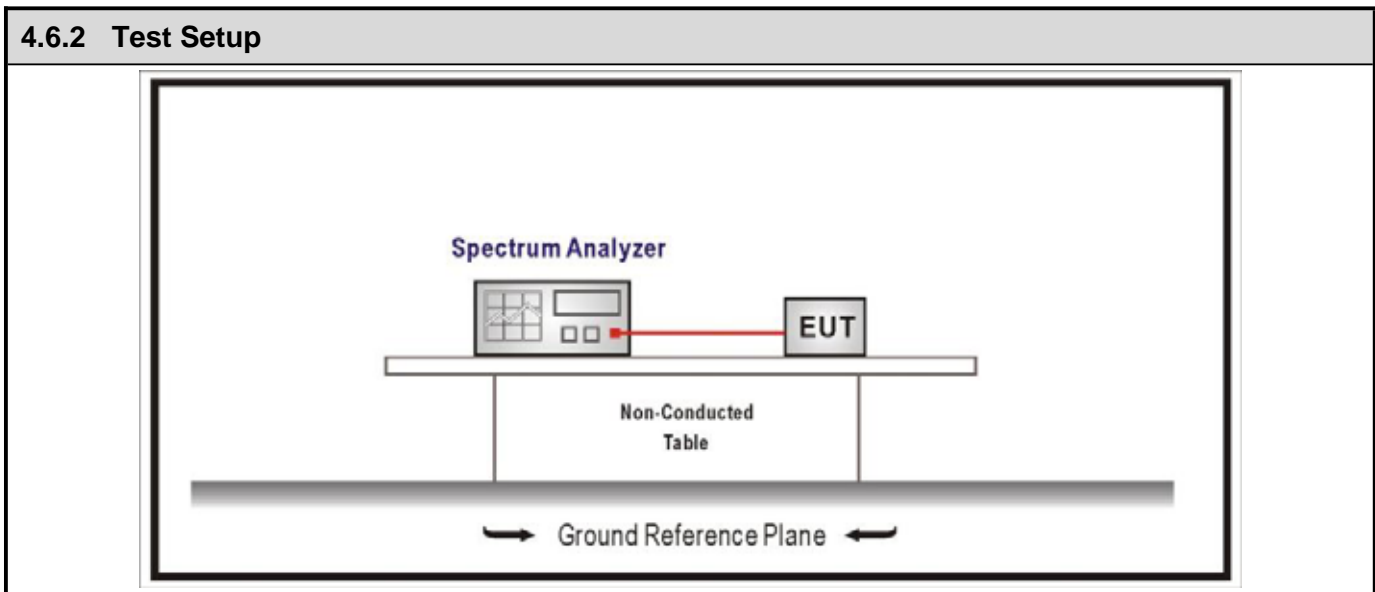

| 4.6.3 Test Procedure | | | |
|-------------------------------------|----------------|---------|---------------|
| | Reference Rule | Chapter | Description |
| <input checked="" type="checkbox"/> | ANSI C63.10 | 11.8 | DTS bandwidth |
| <input type="checkbox"/> | ANSI C63.10 | 11.8.1 | Option 1 |
| <input checked="" type="checkbox"/> | ANSI C63.10 | 11.8.2 | Option 2 |

4.6.4 Test Data

| Mode | CH. | Test Freq. (MHz) | 99% Occupied Bandwidth (MHz) | 6dB Occupied Bandwidth (MHz) | Limit (kHz) | Result |
|------|-----|------------------|------------------------------|------------------------------|-------------|--------|
| 1 | 1 | 2412 | 10.428 | 8.051 | 500 | Pass |
| | 6 | 2437 | 10.501 | 8.115 | 500 | Pass |
| | 11 | 2462 | 10.715 | 8.115 | 500 | Pass |
| 2 | 1 | 2412 | 16.387 | 16.33 | 500 | Pass |
| | 6 | 2437 | 16.401 | 16.07 | 500 | Pass |
| | 11 | 2462 | 16.427 | 16.08 | 500 | Pass |
| 3 | 1 | 2412 | 17.459 | 16.60 | 500 | Pass |
| | 6 | 2437 | 17.493 | 16.59 | 500 | Pass |
| | 11 | 2462 | 17.503 | 16.56 | 500 | Pass |

Note : The worst case of Occupied Bandwidth as below in next page:

Mode 1 CH01 (2412MHz)

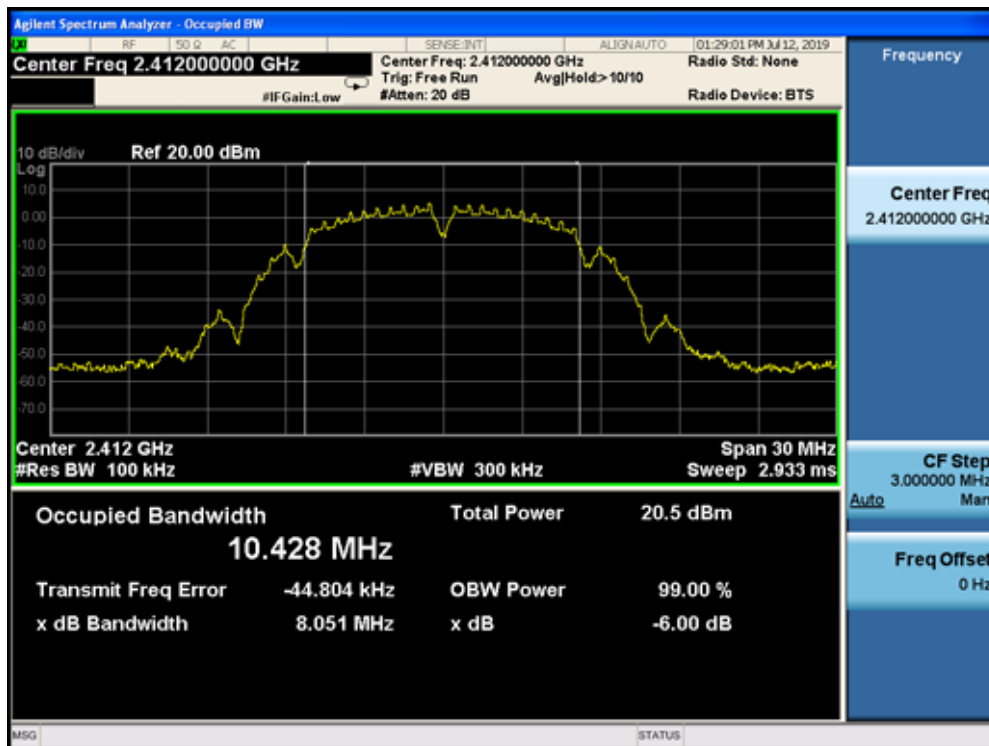

| | |
|--|----------------------|
| 4.7 Fundamental emission output power | VERDICT: PASS |
|--|----------------------|

| 4.7.1 Limit | | |
|--|---|--|
| Standard | FCC Part 15 Subpart C Paragraph 15.247 (b)(3) | |
| <input checked="" type="checkbox"/> GTX < 6dBi | Pout 30dBm | |
| <input type="checkbox"/> GTX > 6dBi | | |
| <input type="checkbox"/> Non-Fix point-point | Pout 30-(GTX -6) | |
| <input type="checkbox"/> Fix point-point | Pout 30-[(GTX-6)]/3 | |
| <input type="checkbox"/> Point-to-multipoint | Pout 30-(GTX-6) | |
| <input type="checkbox"/> Overlap Beams | Pout 30-[(GTX-6)]/3 | |
| <input type="checkbox"/> Aggregate power transmitted simultaneously on all beams | Pout 30-[(GTX-6)]/3 | |
| <input type="checkbox"/> single directional beam | Pout 30-[(GTX-6)]/3+8dB | |
| Note 1 : GTX directional gain of transmitting antennas. | | |
| Note 2 : Pout is maximum peak conducted output power . | | |

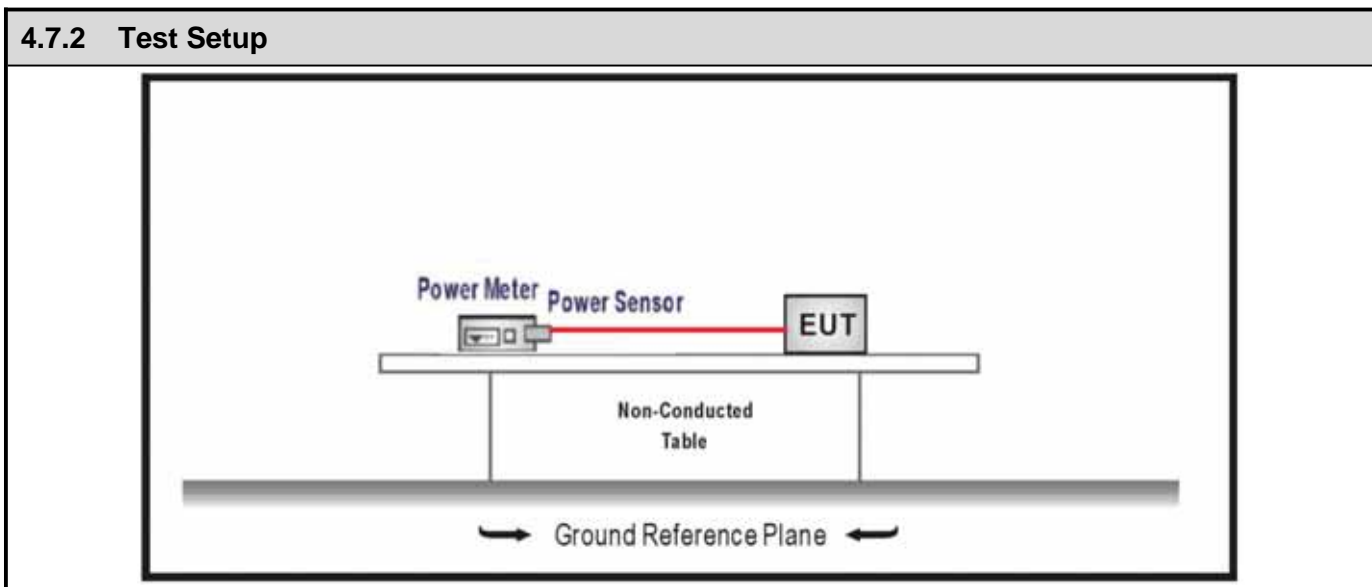

| 4.7.3 Test Procedure | | | | | | |
|-------------------------------------|-------------------------------------|-------------------------------------|--------------------------|-------------------------------------|--|--------------------------------------|
| | References Rule | | Chapter | Description | | |
| <input checked="" type="checkbox"/> | ANSI C63.10 | | 11.9 | Fundamental emission output power | | |
| | <input checked="" type="checkbox"/> | ANSI C63.10 | 11.9.1 | Maximum peak conducted output power | | |
| | | <input type="checkbox"/> | ANSI C63.10 | 11.9.1.1 | RBW DTS bandwidth | |
| | | <input type="checkbox"/> | ANSI C63.10 | 11.9.1.2 | Integrated band power method | |
| | | <input type="checkbox"/> | ANSI C63.10 | 11.9.1.3 | PKPM1 Peak power meter method | |
| | <input type="checkbox"/> | ANSI C63.10 | | 11.9.2 | Maximum conducted (average) output power | |
| | | <input type="checkbox"/> | ANSI C63.10 | 11.9.2.2 | Measurement using a spectrum analyzer (SA) | |
| | | | <input type="checkbox"/> | ANSI C63.10 | 11.9.2.2.2 | Method AVGSA-1(Duty cycle 98%) |
| | | | <input type="checkbox"/> | ANSI C63.10 | 11.9.2.2.3 | Method AVGSA-1A(Duty cycle 98%) |
| | | | <input type="checkbox"/> | ANSI C63.10 | 11.9.2.2.4 | Method AVGSA-2(Duty cycle 98%) |
| | | | <input type="checkbox"/> | ANSI C63.10 | 11.9.2.2.5 | Method AVGSA-2A(Duty cycle 98%) |
| | | | <input type="checkbox"/> | ANSI C63.10 | 11.9.2.2.4 | Method AVGSA-3 |
| | | | <input type="checkbox"/> | ANSI C63.10 | 11.9.2.2.5 | Method AVGSA-3A |
| | | <input checked="" type="checkbox"/> | ANSI C63.10 | | 11.9.2.3 | Measurement using a power meter (PM) |
| | | <input checked="" type="checkbox"/> | ANSI C63.10 | 11.9.2.3.1 | Method AVGPM | |
| <input type="checkbox"/> | | ANSI C63.10 | 11.9.2.3.2 | Method AVGPM-G | | |

4.7.4 Test Data

| Mode | Channel | Test Frequency (MHz) | Power Output (dBm) | Limit (dBm) | Result |
|------|---------|----------------------|--------------------|-------------|--------|
| 1 | 1 | 2412 | 16.05 | 30.00 | Pass |
| | 6 | 2437 | 19.23 | 30.00 | Pass |
| | 11 | 2462 | 20.28 | 30.00 | Pass |
| 2 | 1 | 2412 | 16.02 | 30.00 | Pass |
| | 6 | 2437 | 19.17 | 30.00 | Pass |
| | 11 | 2462 | 19.89 | 30.00 | Pass |
| 3 | 1 | 2412 | 15.86 | 30.00 | Pass |
| | 6 | 2437 | 19.07 | 30.00 | Pass |
| | 11 | 2462 | 19.75 | 30.00 | Pass |

| | |
|--------------------------|----------------------|
| 4.8 Power Density | VERDICT: PASS |
|--------------------------|----------------------|

| | |
|----------------------------------|---|
| 4.8.1 Limit: | |
| Standard | FCC Part 15 Subpart C Paragraph 15.247 (b)(3) |
| Power Spectral Density 8dBm/3kHz | |

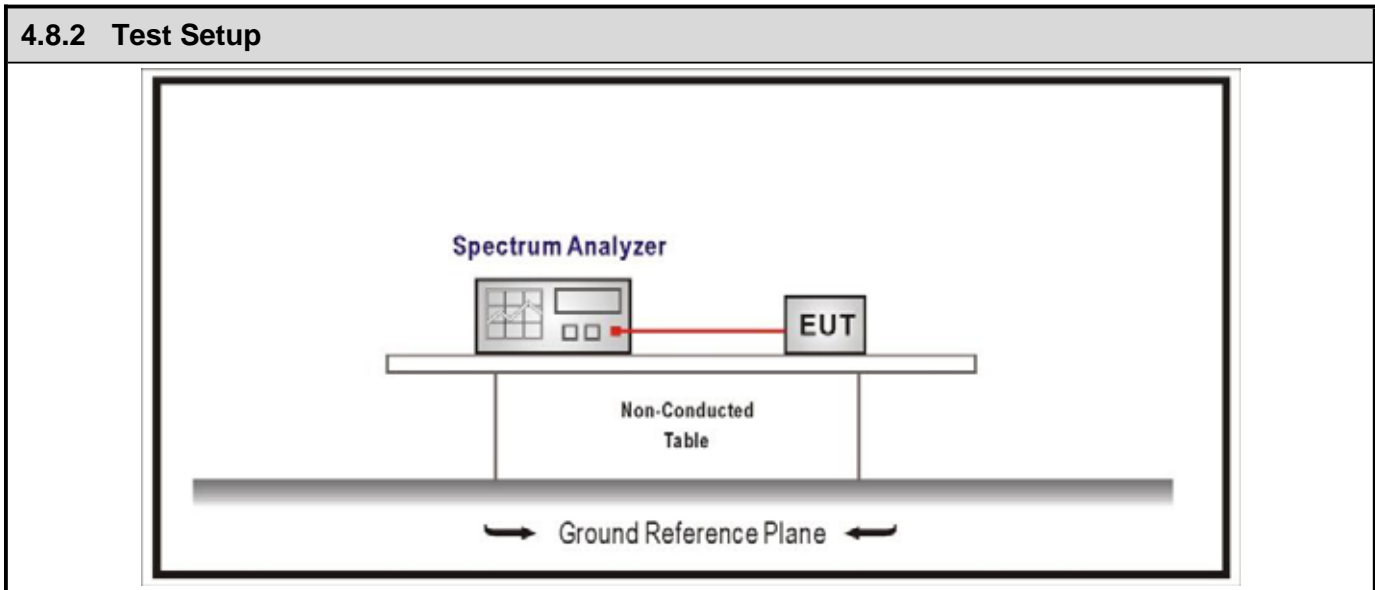

4.8.3 Test Procedure

| | References Rule | Chapter | Description |
|-------------------------------------|-----------------|---------|--|
| <input checked="" type="checkbox"/> | ANSI C63.10 | 11.10 | Maximum power spectral density level in the fundamental emission |
| <input checked="" type="checkbox"/> | ANSI C63.10 | 11.10.2 | Method PKPSD (peak PSD) |
| <input type="checkbox"/> | ANSI C63.10 | 11.10.3 | Method AVGPSD-1(Duty cycle 98%) |
| <input type="checkbox"/> | ANSI C63.10 | 11.10.4 | Method AVGPSD-1A(Duty cycle 98%) |
| <input type="checkbox"/> | ANSI C63.10 | 11.10.5 | Method AVGPSD-2(Duty cycle < 98%) |
| <input type="checkbox"/> | ANSI C63.10 | 11.10.6 | Method AVGPSD-2A(Duty cycle < 98%) |
| <input type="checkbox"/> | ANSI C63.10 | 11.10.7 | Method AVGPSD-3 |
| <input type="checkbox"/> | ANSI C63.10 | 11.10.8 | Method AVGPSD-3A |

4.8.4 Test Data

| Mode | Channel | Test Frequency (MHz) | Measurement PSD (dBm/3kHz) | Antenna Gain (dBi) | Limit (dBm/3kHz) | Result |
|------|---------|----------------------|----------------------------|--------------------|------------------|--------|
| 1 | 1 | 2412 | -8.899 | 2 | 8 | Pass |
| | 6 | 2437 | -6.836 | 2 | 8 | Pass |
| | 11 | 2462 | -5.276 | 2 | 8 | Pass |
| 2 | 1 | 2412 | -12.833 | 2 | 8 | Pass |
| | 6 | 2437 | -8.576 | 2 | 8 | Pass |
| | 11 | 2462 | -5.276 | 2 | 8 | Pass |
| 3 | 1 | 2412 | -13.251 | 2 | 8 | Pass |
| | 6 | 2437 | -9.566 | 2 | 8 | Pass |
| | 11 | 2462 | -8.066 | 2 | 8 | Pass |

Remark: The worst data as below:

Mode 1 CH11(2462MHz)



| | |
|--------------------------------|----------------------|
| 4.9 Antenna Requirement | VERDICT: PASS |
|--------------------------------|----------------------|

| |
|---------------------|
| 4.9.1 Limit: |
|---------------------|

| | |
|---|--|
| Standard | FCC Part 15 Subpart C Paragraph 15.203 |
| <p>An intentional radiator shall be designed to ensure that no antenna other than that furnished by the responsible party shall be used with the device. The use of a permanently attached antenna or of an antenna that uses a unique coupling to the intentional radiator shall be considered sufficient to comply with the provisions of this section. The manufacturer may design the unit so that a broken antenna can be replaced by the user, but the use of a standard antenna jack or electrical connector is prohibited. This requirement does not apply to carrier current devices or to devices operated under the provisions of §15.211, §15.213, §15.217, §15.219, or §15.221. Further, this requirement does not apply to intentional radiators that must be professionally installed, such as perimeter protection systems and some field disturbance sensors, or to other intentional radiators which, in accordance with §15.31(d), must be measured at the installation site. However, the installer shall be responsible for ensuring that the proper antenna is employed so that the limits in this part are not exceeded.</p> | |

| |
|--|
| 4.9.2 Antenna Connector Construction: |
|--|

| | |
|--|--|
| <input type="checkbox"/> | The use of a permanently attached antenna |
| <input type="checkbox"/> | The antenna use of a unique coupling to the intentional radiator |
| <input type="checkbox"/> | The use of a nonstandard antenna jack or electrical connector |
| Please refer to the attached document "Internal Photograph" to show the antenna connector. | |

| |
|--|
| 4.10 Test setup photo and EUT Photo |
|--|

| |
|----------------------|
| VERDICT: PASS |
|----------------------|

Remark: The test setup photo and EUT Photo please see appendix.

_____ The End _____