

# ZEBRA TECHNOLOGIES CORP

P4T with Zcomax 802.11b/g radio module+RFID  
Model: P4T

Dec 17th 2010

Report No.: SL10082306-ZBR-063A1\_FCC,IC(DTS)  
(This report supersedes NONE )



Modifications made to the product : None

This Test Report is Issued Under the Authority of:

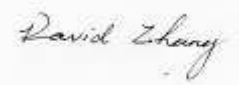
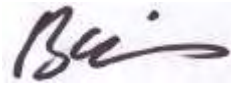
	
David Zhang      Test Engineer	Leslie Bai      Engineering Reviewer

This test report may be reproduced in full only.  
Test result presented in this test report is applicable to the representative sample only.

# RF Test Report

To: FCC 15.247:2010 & RSS-210 Issue 8:2010

SIEMIC, INC.  
Accessing global markets



## Laboratory Introduction

SIEMIC, headquartered in the heart of Silicon Valley, with superior facilities in US and Asia, is one of the leading independent testing and certification facilities providing customers with one-stop shop services for Compliance Testing and Global Certifications.



In addition to [testing](#) and [certification](#), SIEMIC provides initial design reviews and [compliance management](#) through out a project. Our extensive experience with [China](#), [Asia Pacific](#), [North America](#), [European](#), and [international](#) compliance requirements, assures the fastest, most cost effective way to attain regulatory compliance for the [global markets](#).

### Accreditations for Conformity Assessment

Country/Region	Accreditation Body	Scope
USA	FCC, A2LA	EMC , RF/Wireless , Telecom
Canada	IC, A2LA, NIST	EMC, RF/Wireless , Telecom
Taiwan	BSMI , NCC , NIST	EMC, RF, Telecom , Safety
Hong Kong	OFTA , NIST	RF/Wireless ,Telecom
Australia	NATA, NIST	EMC, RF, Telecom , Safety
Korea	KCC/RRA, NIST	EMI, EMS, RF , Telecom, Safety
Japan	VCCI, JATE, TELEC, RFT	EMI, RF/Wireless, Telecom
Mexico	NOM, COFETEL, Caniety	Safety, EMC , RF/Wireless, Telecom
Europe	A2LA, NIST	EMC, RF, Telecom , Safety

### Accreditations for Product Certifications

Country	Accreditation Body	Scope
USA	FCC TCB, NIST	EMC , RF , Telecom
Canada	IC FCB , NIST	EMC , RF , Telecom
Singapore	iDA, NIST	EMC , RF , Telecom
EU	NB	EMC & R&TTE Directive

---

This page has been left blank intentionally.

# CONTENTS

<b>1</b>	<b>EXECUTIVE SUMMARY &amp; EUT INFORMATION .....</b>	<b>6</b>
<b>2</b>	<b>TECHNICAL DETAILS .....</b>	<b>7</b>
<b>3</b>	<b>MODIFICATION .....</b>	<b>8</b>
<b>4</b>	<b>TEST SUMMARY .....</b>	<b>9</b>
<b>5</b>	<b>MEASUREMENTS, EXAMINATION AND DERIVED RESULTS .....</b>	<b>10</b>
	<b>ANNEX A. TEST INSTRUMENT &amp; METHOD.....</b>	<b>48</b>
	<b>ANNEX B EUT PHOTOGRAPHS .....</b>	<b>53</b>
	<b>ANNEX C. TEST SETUP AND SUPPORTING EQUIPMENT .....</b>	<b>56</b>
	<b>ANNEX D USER MANUAL, BLOCK &amp; CIRCUIT DIAGRAM .....</b>	<b>60</b>
	<b>ANNEX E SIEMIC ACCREDITATION .....</b>	<b>61</b>

---

This page has been left blank intentionally.

# 1 Executive Summary & EUT information

The purpose of this test programme was to demonstrate compliance of the ZEBRA Technologies Corp, P4T with Zcomax 802.11b/g radio module+RFID, and Model: P4T against the current Stipulated Standards. The P4T with Zcomax 802.11b/g radio module+RFID have demonstrated compliance with the FCC 15.247:2010 & IC RSS210 Issue 8: 2010.

## EUT Information

<b>EUT Description</b>	: This is a Zebra Host Printer, primarily with P4T WLAN radio and Mercury5e-Compact (M5e-Compact) RFID radio. Those radios will be installed inside the product and will not be user accessible. The antenna is an internal antenna and will not be user accessible. 802.11b/g radios is designed to operate in the international ISM Band from 2.412 to 2.462 GHz. and RFID radio is designed to operate form 902.75MHz to 927.25MHz.
<b>Model No</b>	: P4T
<b>Serial No</b>	: XXPZJ103400046
<b>Input Power</b>	: Input : 100-240V~, 1.5A, 50-60Hz Output : 12VDC, 4.16A Max (50W Max) Battery : 7.4VDC
<b>Classification Per Stipulated Test Standard</b>	: Spread Spectrum System / Device



## **2 TECHNICAL DETAILS**

<b>Purpose</b>	<b>Compliance testing of P4T with Zcomax 802.11b/g + RFID radio modules with stipulated standard</b>
<b>Applicant / Client</b>	<b>ZEBRA Technologies Corp</b>
<b>Manufacturer</b>	<b>Zebra Technologies Corp 1001 Flynn Road Camarillo, CA 93012 USA</b>
<b>Laboratory performing the tests</b>	<b>SIEMIC Laboratories</b>
<b>Test report reference number</b>	<b>SL10082306-ZBR-063A1_FCC,IC(DTS)</b>
<b>Date EUT received</b>	<b>Nov 29<sup>th</sup> 2010</b>
<b>Standard applied</b>	<b>FCC 15.247:2010 &amp; RSS 210 Issue 8: 2010</b>
<b>Dates of test (from – to)</b>	<b>Nov 29th 2010 - Dec 17th 2010</b>
<b>No of Units:</b>	<b>1</b>
<b>Equipment Category:</b>	<b>DTS</b>
<b>Trade Name:</b>	<b>ZEBRA Technologies Corp</b>
<b>Model :</b>	<b>P4T</b>
<b>RF Operating Frequency (ies)</b>	<b>WLAN (2412MHZ-2462MHz)</b>
<b>Number of Channels :</b>	<b>WLAN (11 Channels)</b>
<b>Modulation :</b>	<b>CCK &amp; OFDM</b>
<b>FCC ID :</b>	<b>I28RFID-R4CXNG-01</b>
<b>IC ID :</b>	<b>3798B-R4CXNG01</b>

# 3 MODIFICATION

NONE



## 4 TEST SUMMARY

The product was tested in accordance with the following specifications. All Testing has been performed according to below product classification:

Spread Spectrum System / Device

### Test Results Summary

Test Standard		Description	Pass / Fail
CFR 47 Part 15.247: 2010	RSS 210 Issue 8: 2010		
15.203		Antenna Requirement	Pass
15.205	RSS210(A8.5)	Restricted Band of Operation	Pass
15.207(a)	RSSGen(7.2.2)	Conducted Emissions Voltage	Pass
15.247(a)(1)	RSS210(A8.1)	Channel Separation	N/A
15.247(a)(1)	RSS210(A8.1)	Occupied Bandwidth	Pass
15.247(a)(2)	RSS210 (A8.2)	Bandwidth	Pass
15.247(a)(1)	RSS210(A8.1)	Number of Hopping Channels	N/A
15.247(a)(1)	RSS210(A8.1)	Time of Occupancy	N/A
15.247(b)	RSS210(A8.4)	Output Power	Pass
15.247(c)	RSS210(A8.4)	Antenna Gain > 6 dBi	N/A
15.247(d)	RSS210(A8.5)	Conducted Spurious Emissions	Pass
15.209; 15.247(d)	RSS210(A8.5)	Radiated Spurious Emissions	Pass
15.247(e)	RSS210(A8.3)	Power Spectral Density	Pass
15.247(f)	RSS210(A8.3)	Hybrid System Requirement	N/A
15.247(g)	RSS210(A8.1)	Hopping Capability	N/A
15.247(h)	RSS210(A8.1)	Hopping Coordination Requirement	N/A
15.247(i)	RSSGen(5.5)	RF Exposure requirement	Pass
	RSSGen(4.8)	Receiver Spurious Emissions	Pass

ANSI C63.4: 2009/ RSS-Gen Issue 3: 2010

PS: All measurement uncertainties are not taken into consideration for all presented test result.

## 5 MEASUREMENTS, EXAMINATION AND DERIVED RESULTS

### 5.1 Antenna Requirement

**Requirement(s):** 47 CFR §15.203

An intentional radiator shall be designed to ensure that no antenna other than that furnished by the responsible party shall be used with the device.

Antenna requirement must meet at least one of the following:

- a) Antenna must be permanently attached to the device.
- b) Antenna must use a unique type of connector to attach to the device.
- c) Device must be professionally installed. Installer shall be responsible for ensuring that the correct antenna is employed with the device.

The antenna is chip antenna which is permanently attached to the device. Antenna maximum gain is 3.76dBi for 2412MHz – 2462MHz band.

**Results:** PASS

## 5.2 Conducted Emissions Voltage

Requirement:

Frequency of emission (MHz)	Conducted limit (dB $\mu$ V)	
	Quasi-peak	Average
0.15–0.5	66 to 56*	56 to 46*
0.5–5	56	46
5–30	60	50

\*Decreases with the logarithm of the frequency.

### Procedures:

- All possible modes of operation were investigated. Only the 6 worst case emissions measured, using the correct CISPR and Average detectors, are reported. All other emissions were relatively insignificant.
- A "-ve" margin indicates a PASS as it refers to the margin present below the limit line at the particular frequency.
- Conducted Emissions Measurement Uncertainty  
All test measurements carried out are traceable to national standards. The uncertainty of the measurement at a confidence level of approximately 95% (in the case where distributions are normal), with a coverage factor of 2, in the range 9kHz – 30MHz (Average & Quasi-peak) is  $\pm 3.86$ dB.
- Environmental Conditions
 

Temperature	23°C
Relative Humidity	50%
Atmospheric Pressure	1019mbar

Test Date : Nov 29th 2010 - Dec 17th 2010  
 Tested By :David Zhang

**Results:** Pass

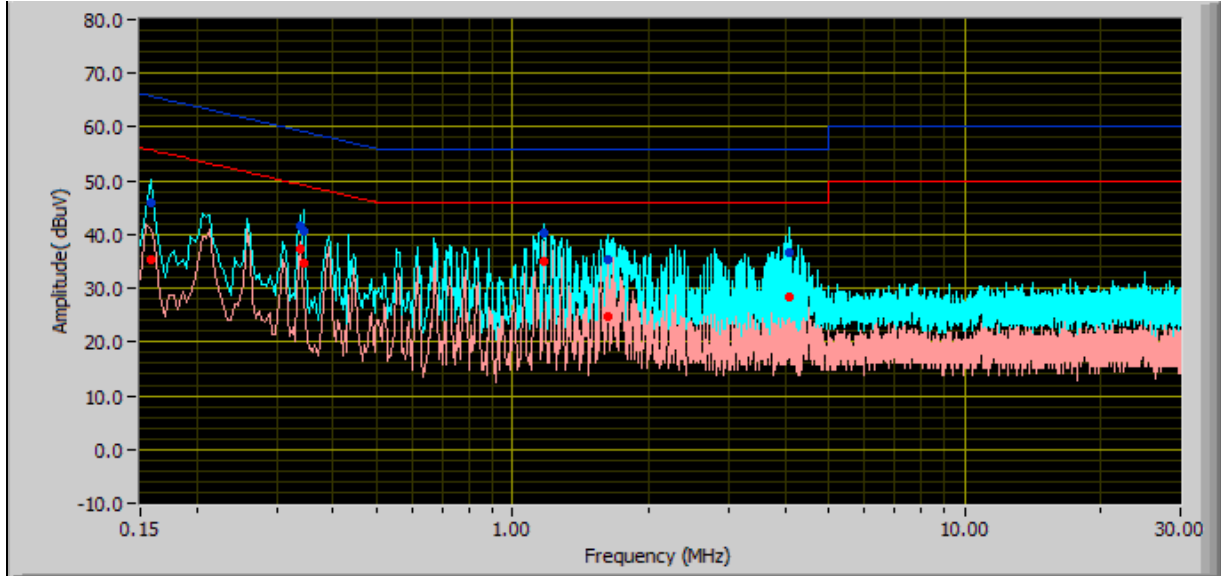

Quasi-Peak Limit

Average Limit

Phase Line Plot at 120VAC, 60Hz

Frequency (MHz)	QP Value (dB $\mu$ V)	Class B Limit (dB)	Pass / Fail	Margin (dB)	Avg Value (dB $\mu$ V)	Class B Limit (dB)	Pass / Fail	Margin (dB)	Line
1.17	40.35	56.00	PASS	-15.65	34.95	46.00	PASS	-11.05	Phase
0.35	40.77	59.11	PASS	-18.34	34.64	49.11	PASS	-14.47	Phase
4.08	36.70	56.00	PASS	-19.30	28.47	46.00	PASS	-17.53	Phase
0.16	45.77	65.75	PASS	-19.98	35.39	55.75	PASS	-20.36	Phase
0.34	41.72	59.31	PASS	-17.59	37.38	49.31	PASS	-11.93	Phase
1.63	35.40	56.00	PASS	-20.60	24.87	46.00	PASS	-21.13	Phase

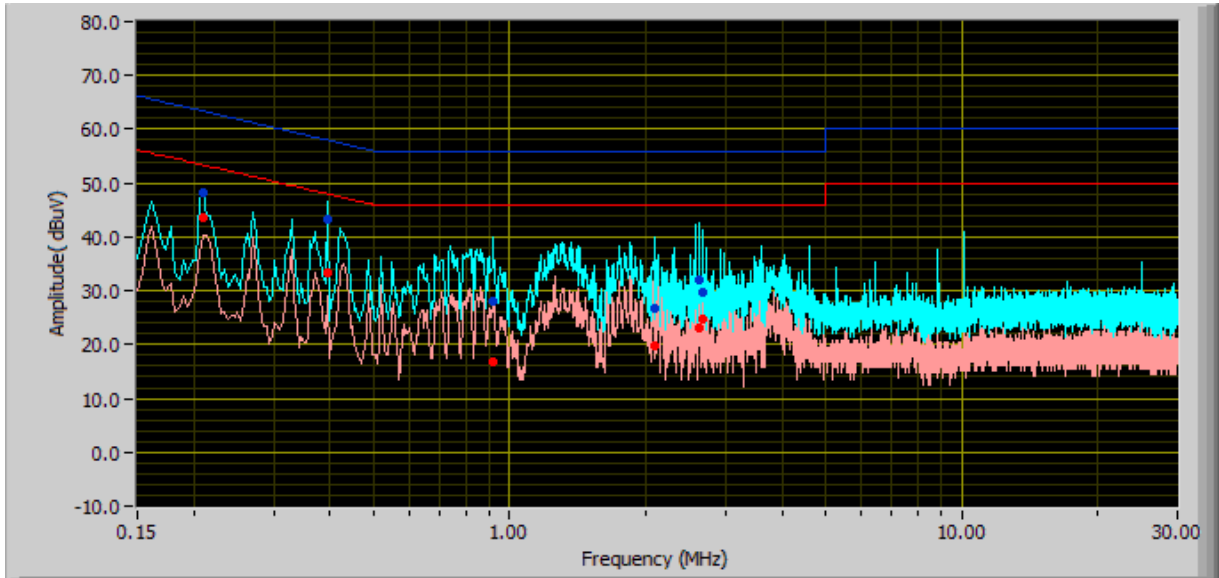

Quasi-Peak Limit

Average Limit

Neutral Line Plot at 120VAC, 60Hz

Frequency (MHz)	QP Value (dB $\mu$ V)	Class B Limit (dB)	Pass / Fail	Margin (dB)	Avg Value (dB $\mu$ V)	Class B Limit (dB)	Pass / Fail	Margin (dB)	Line
0.39	43.21	58.01	PASS	-14.80	33.38	48.01	PASS	-14.63	Neutral
2.62	31.98	56.00	PASS	-24.02	23.15	46.00	PASS	-22.85	Neutral
0.21	48.16	63.34	PASS	-15.18	43.51	53.34	PASS	-9.83	Neutral
2.67	29.57	56.00	PASS	-26.43	24.66	46.00	PASS	-21.34	Neutral
2.09	26.84	56.00	PASS	-29.16	19.66	46.00	PASS	-26.34	Neutral
0.92	28.09	56.00	PASS	-27.91	16.72	46.00	PASS	-29.28	Neutral

### 5.3 6dB & 99% Occupied Bandwidth

1. Conducted Measurement  
 EUT was set for low , mid, high channel with modulated mode and highest RF output power.  
 The spectrum analyzer was connected to the antenna terminal.
2. Environmental Conditions
 

Temperature	23°C
Relative Humidity	50%
Atmospheric Pressure	1019mbar
3. Conducted Emissions Measurement Uncertainty  
 All test measurements carried out are traceable to national standards. The uncertainty of the measurement at a confidence level of approximately 95% (in the case where distributions are normal), with a coverage factor of 2, in the range 30MHz – 40GHz is ±1.5dB.
4. Test Date : Nov 29th 2010 - Dec 17th 2010  
 Tested By :David Zhang

**Requirement(s):** 47 CFR §15.247(a)(1)

**Procedures:** The 6dB bandwidths were measured conducted using a spectrum analyzer at low, mid, and hi channels. 6 dB Bandwidth Limit: > 500 kHz.

**Results:** Pass

Protocol	Channel	Channel Frequency (MHz)	6 dB Channel Bandwidth (MHz)	99% Channel Bandwidth (MHz)	6 dB Occupied Bandwidth Limit (MHz)
802.11b	Low	2412	10.35	13.60	0.5
802.11b	Mid	2437	10.40	13.60	0.5
802.11b	High	2462	11.15	13.65	0.5
802.11g	Low	2412	16.70	16.65	0.5
802.11g	Mid	2437	16.70	16.60	0.5
802.11g	High	2462	16.65	16.60	0.5

Refer to the attached plots.

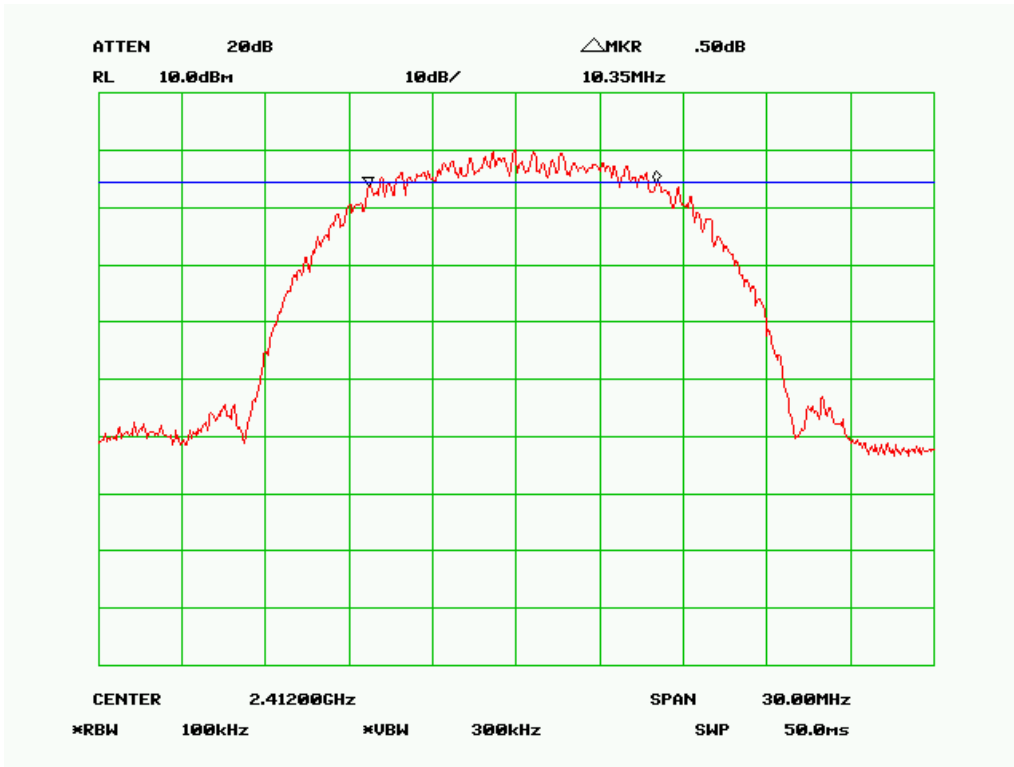

6 dB Bandwidth – 802.11b, Low Channel

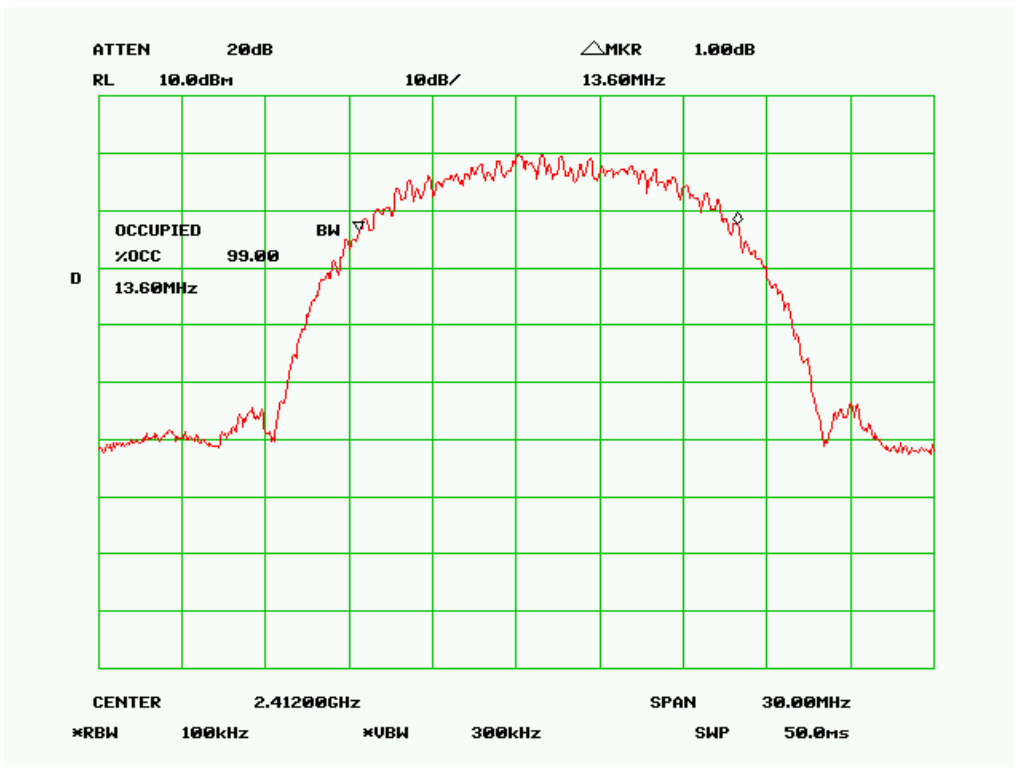

99% dB Bandwidth - 802.11b, Low Channel

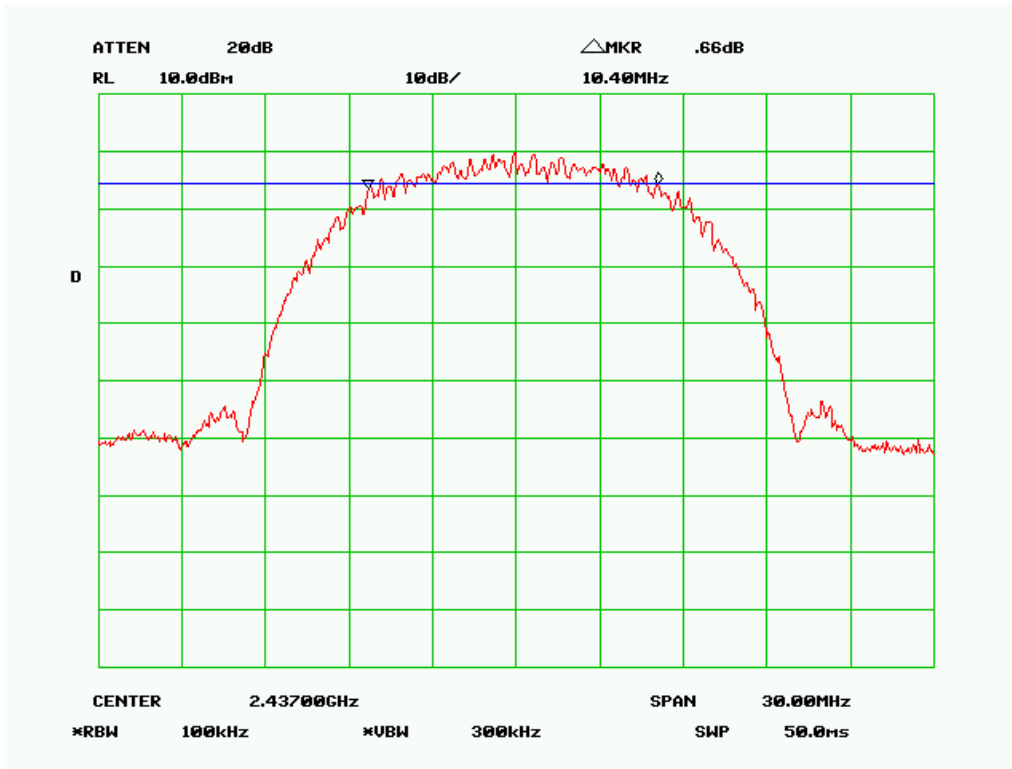

6 dB Bandwidth - 802.11b, Middle Channel

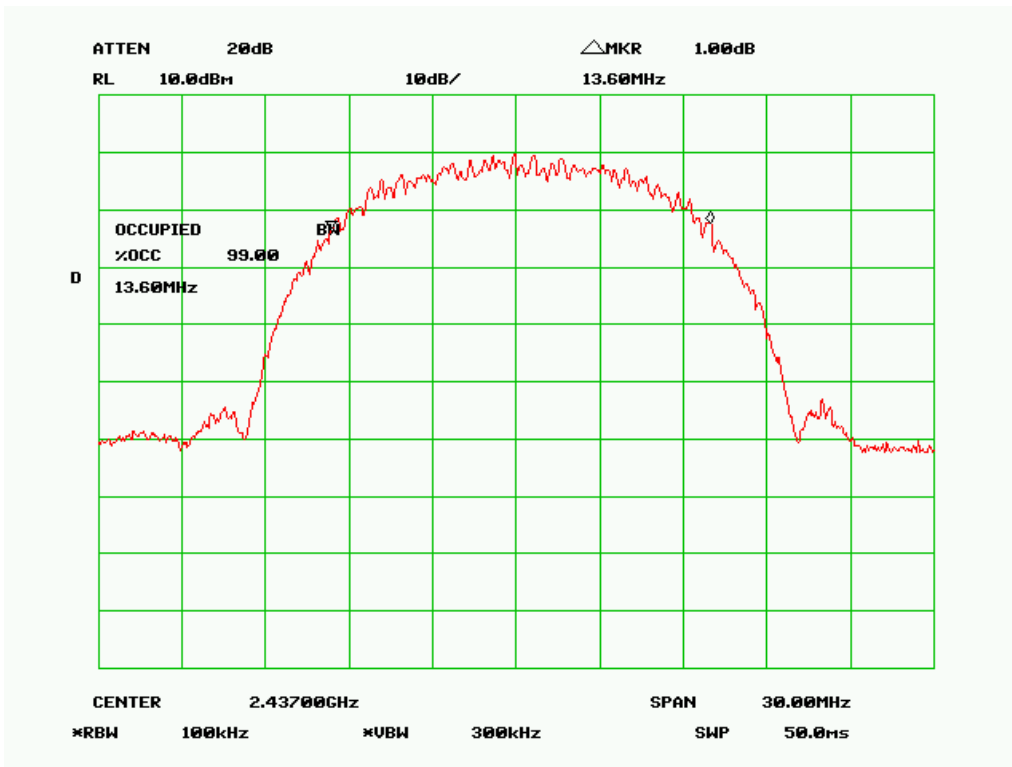

99% dB Bandwidth - 802.11b, Mid Channel



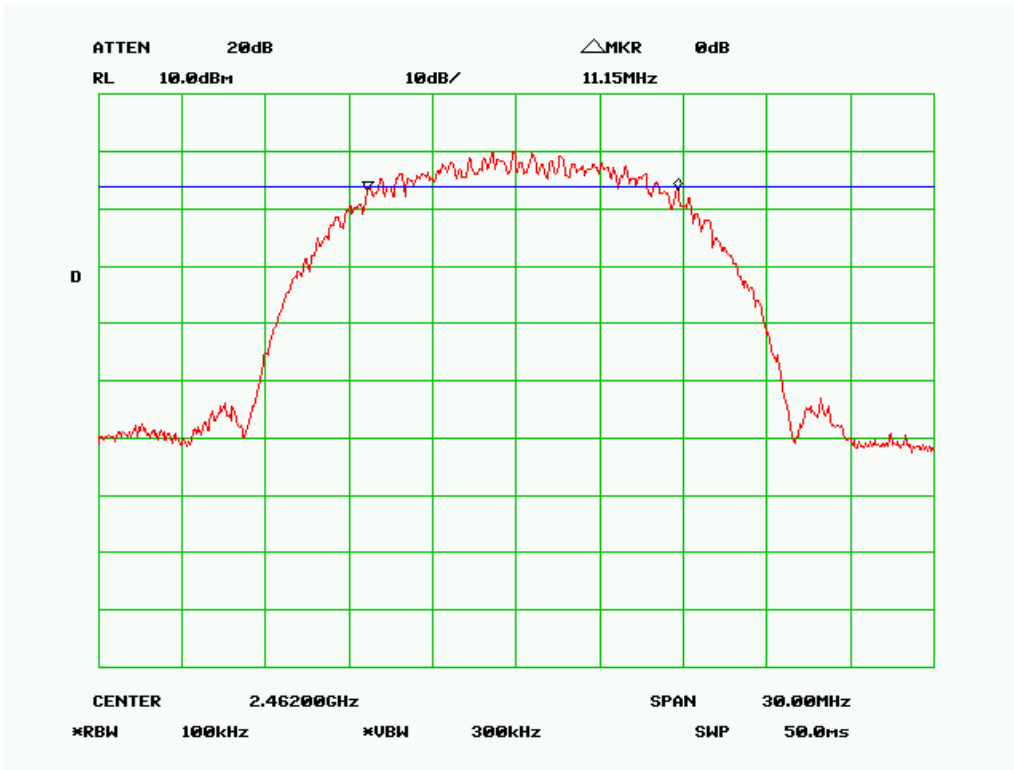

6 dB Bandwidth – 802.11b, High Channel

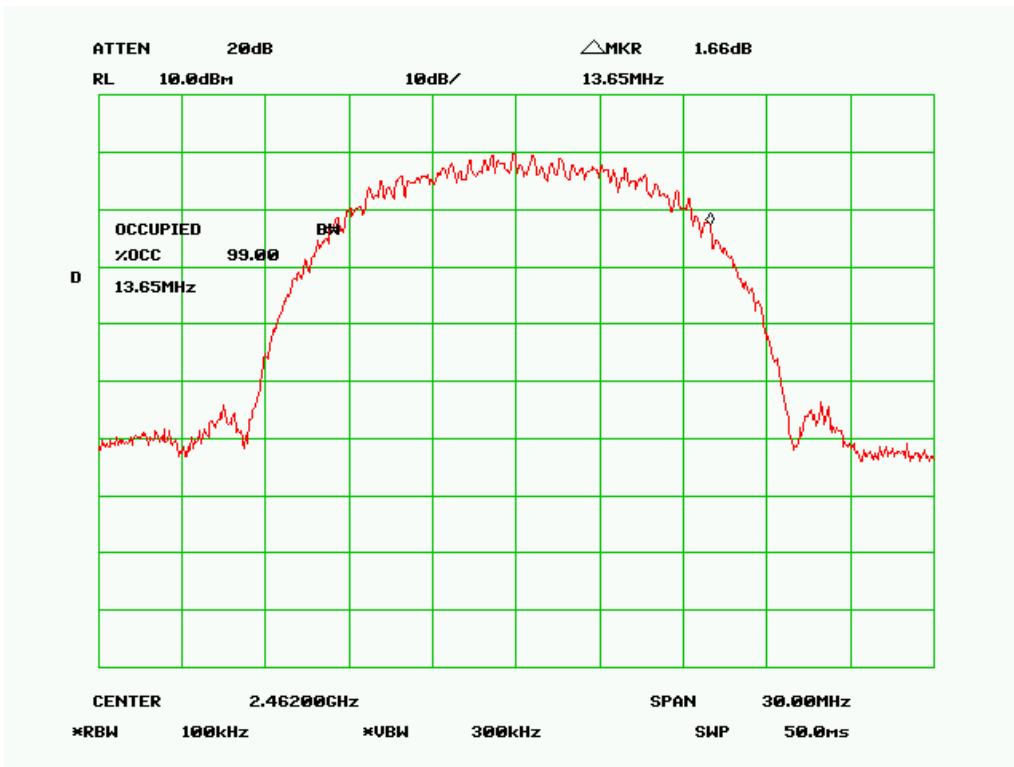

99% dB Bandwidth - 802.11b, High Channel

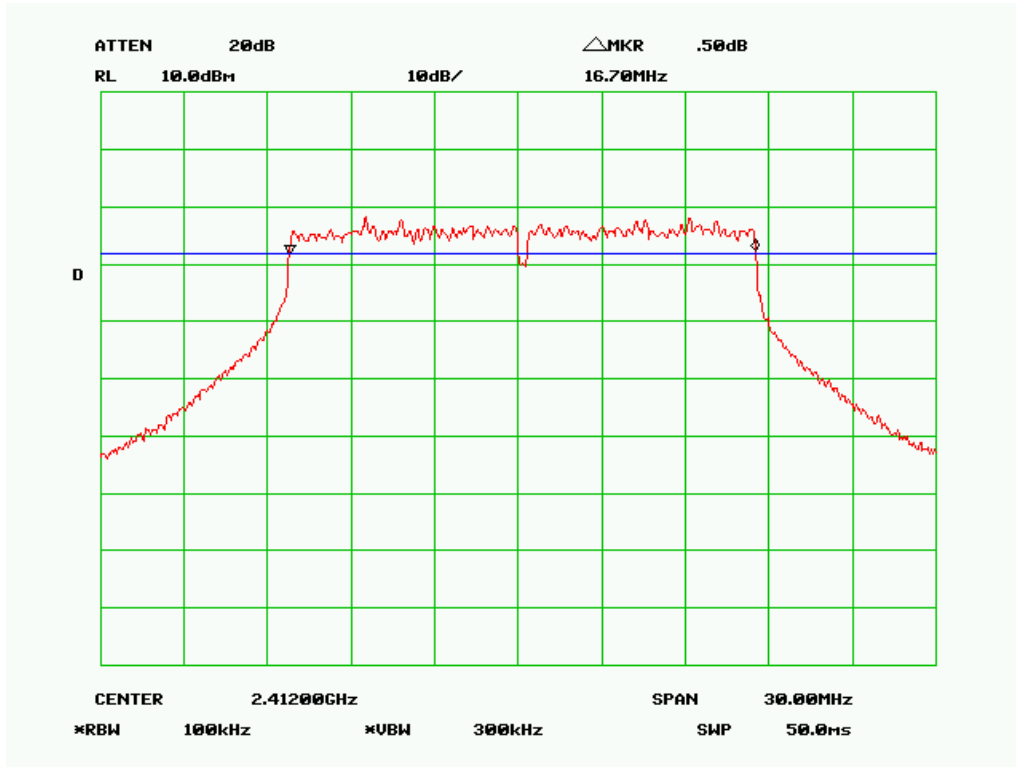

6 dB Bandwidth – 802.11g, Low Channel

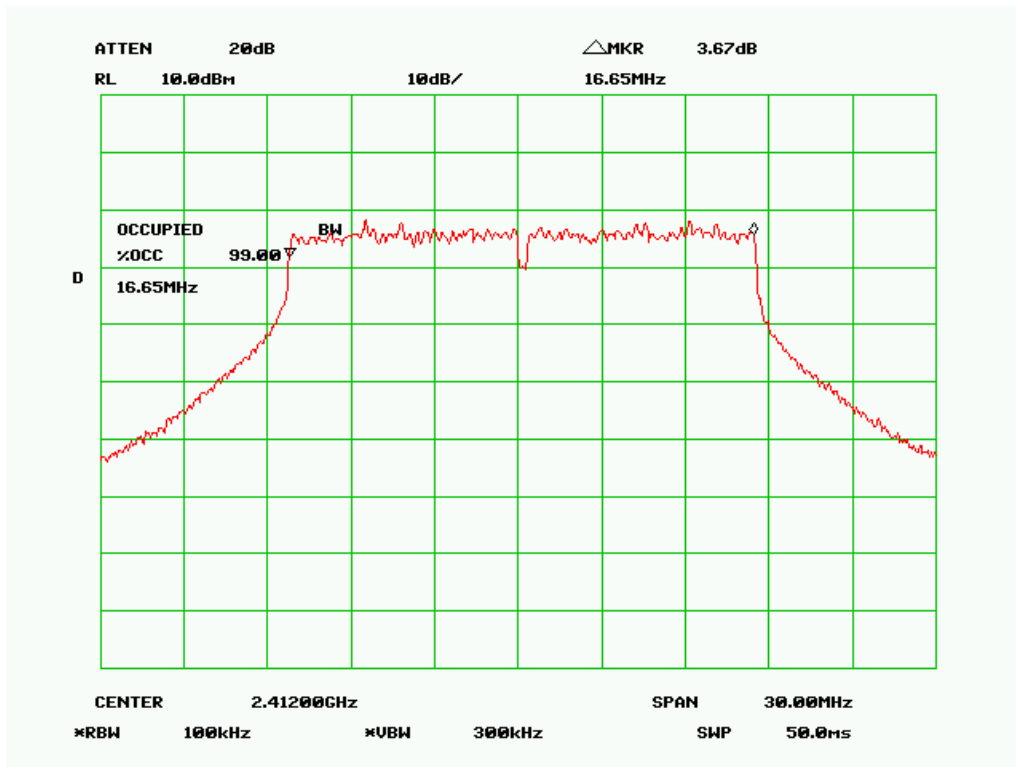

99% dB Bandwidth - 802.11g, Low Channel

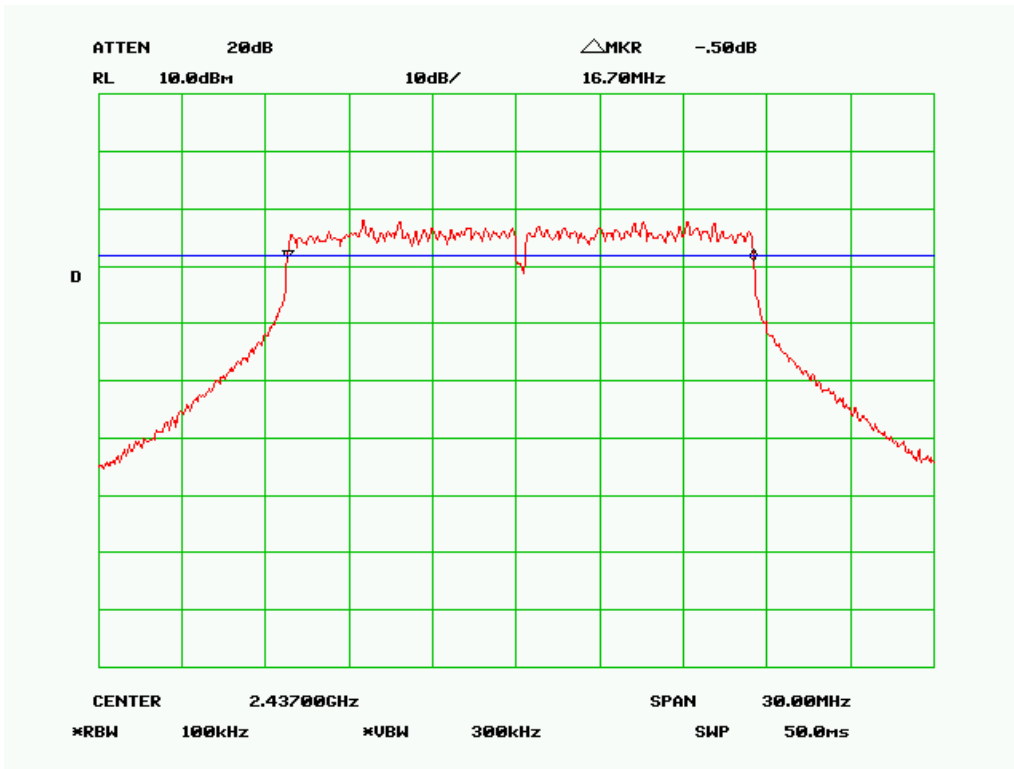

6 dB Bandwidth - 802.11g, Middle Channel

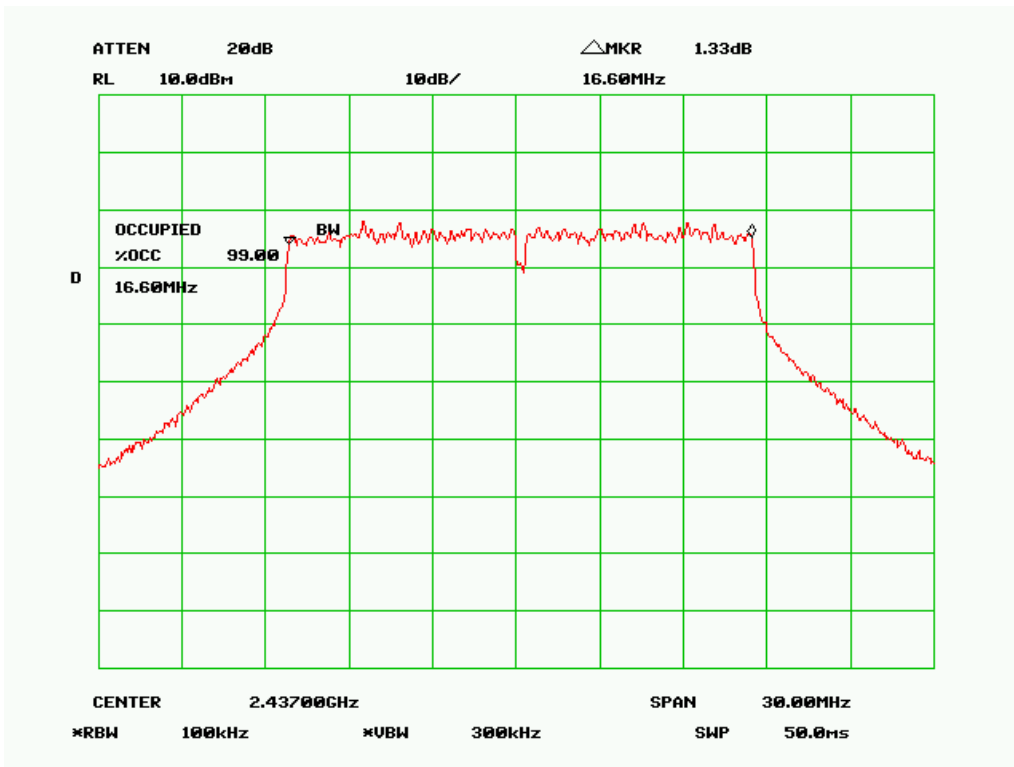

99% dB Bandwidth - 802.11g, Mid Channel

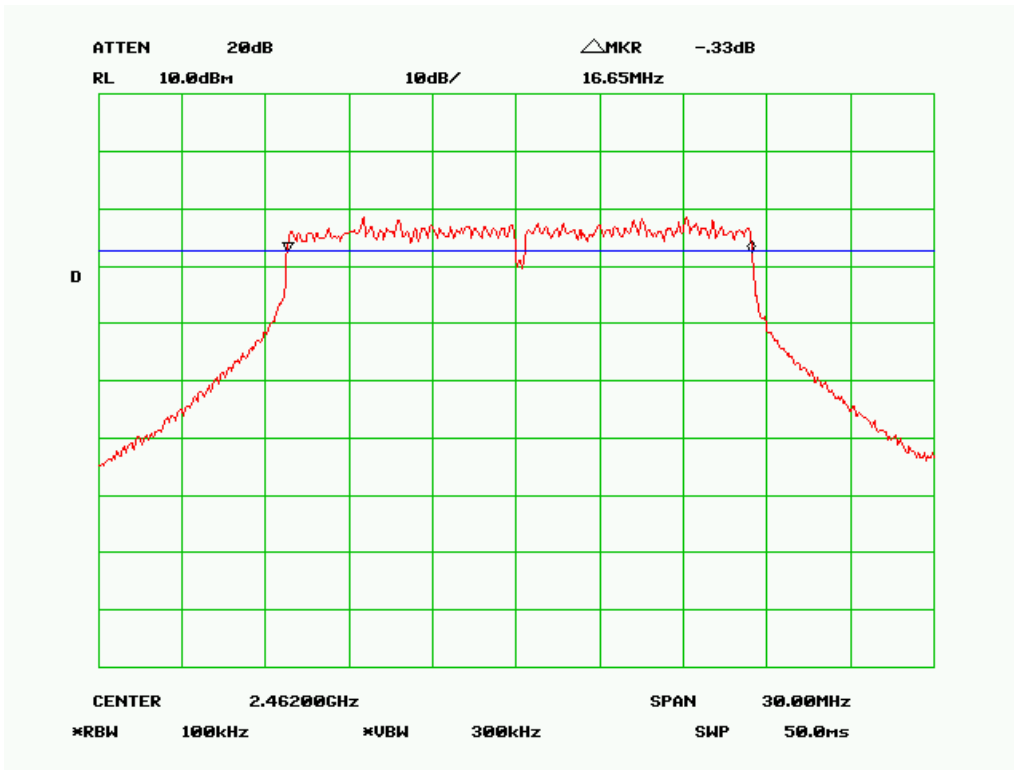

6 dB Bandwidth – 802.11g, High Channel

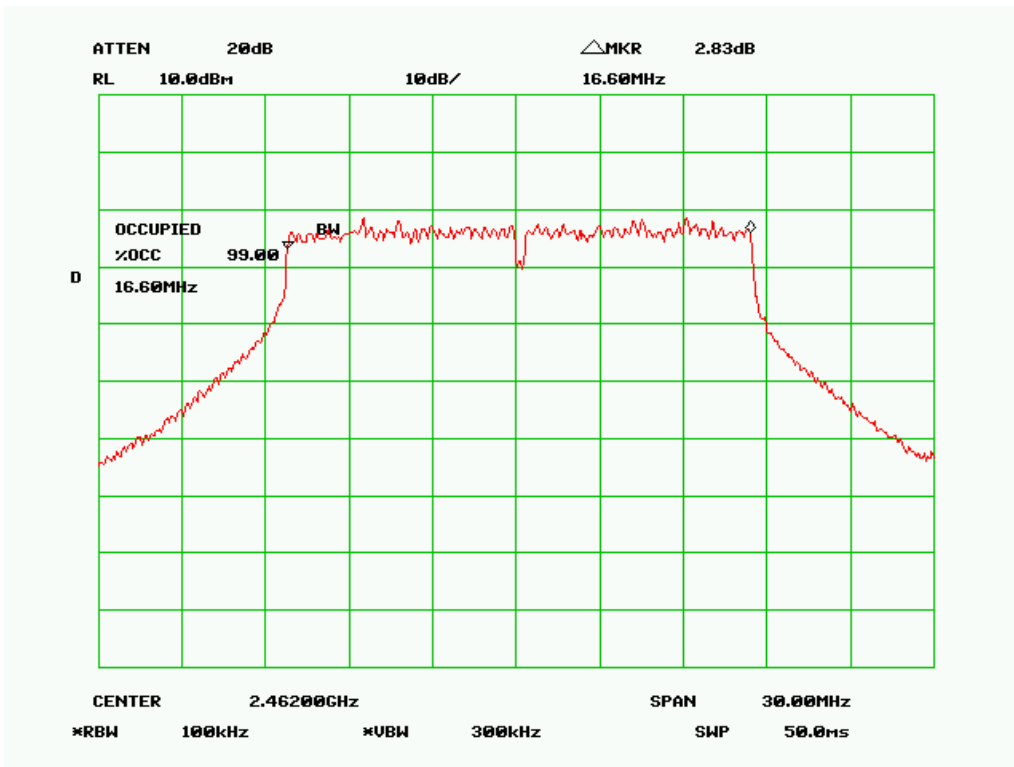

99% dB Bandwidth - 802.11g, High Channel

## 5.4 Peak Spectral Density

1. Conducted Measurement  
 EUT was set for low , mid, high channel with modulated mode and highest RF output power.  
 The spectrum analyzer was connected to the antenna terminal.
2. Conducted Emissions Measurement Uncertainty  
 All test measurements carried out are traceable to national standards. The uncertainty of the measurement at a confidence level of approximately 95% (in the case where distributions are normal), with a coverage factor of 2, in the range 30MHz – 40GHz is ±1.5dB.
3. Environmental Conditions
 

Temperature	23°C
Relative Humidity	50%
Atmospheric Pressure	1019mbar
4. Test Date : Nov 29th 2010 - Dec 17th 2010  
 Tested By :David Zhang

**Standard Requirement:** 47 CFR §15.247(e)

For digitally modulated systems, the power spectral density conducted from the intentional radiator to the antenna shall not be greater than 8 dBm in any 3 kHz band during any time interval of continuous transmission

**Procedures:** The Peak Spectral density measurement was taken conducted using a spectrum analyzer with average measurement method

RBW=3KHz, VBW > RBW, Sweep time auto

**Test Result:** Pass

Protocol	Channel	Channel Frequency (MHz)	Peak Spectral Density Limit (dBm/3KHz)	Peak Spectral Density (dBm/3KHz)
802.11b	Low	2412	8	-14.67
802.11b	Mid	2437	8	-14.83
802.11b	High	2462	8	-14.50
802.11g	Low	2412	8	-29.50
802.11g	Mid	2437	8	-27.00
802.11g	High	2462	8	-26.50

Refer to the attached plots.

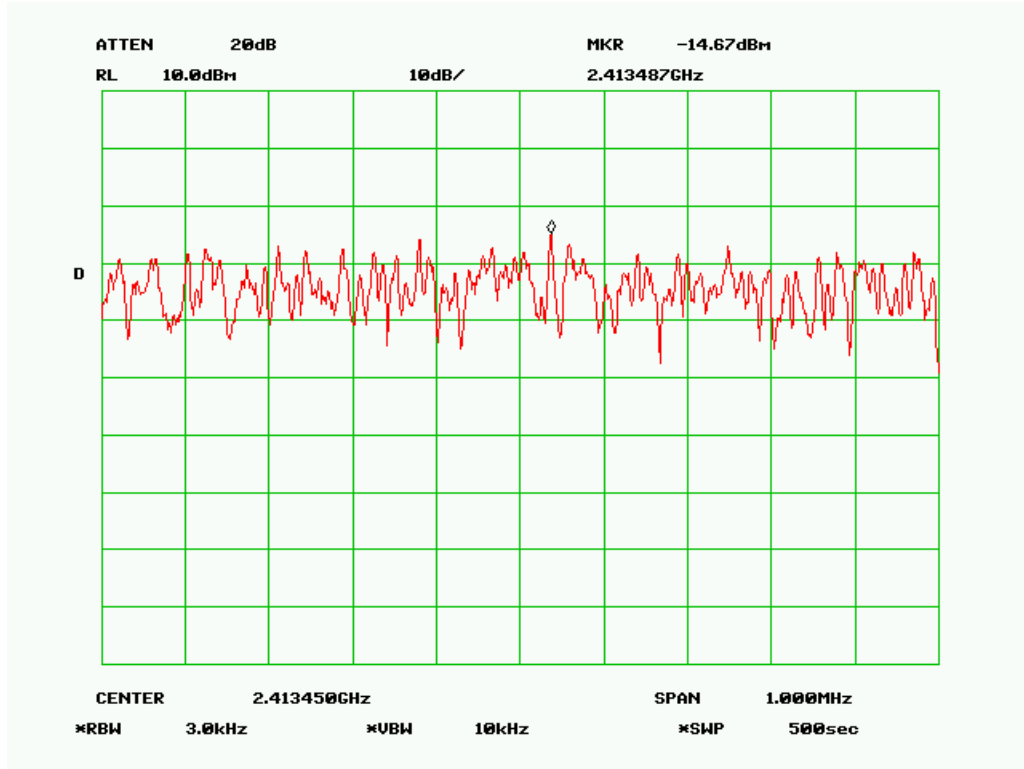

PSD Low Channel( 802.11b)

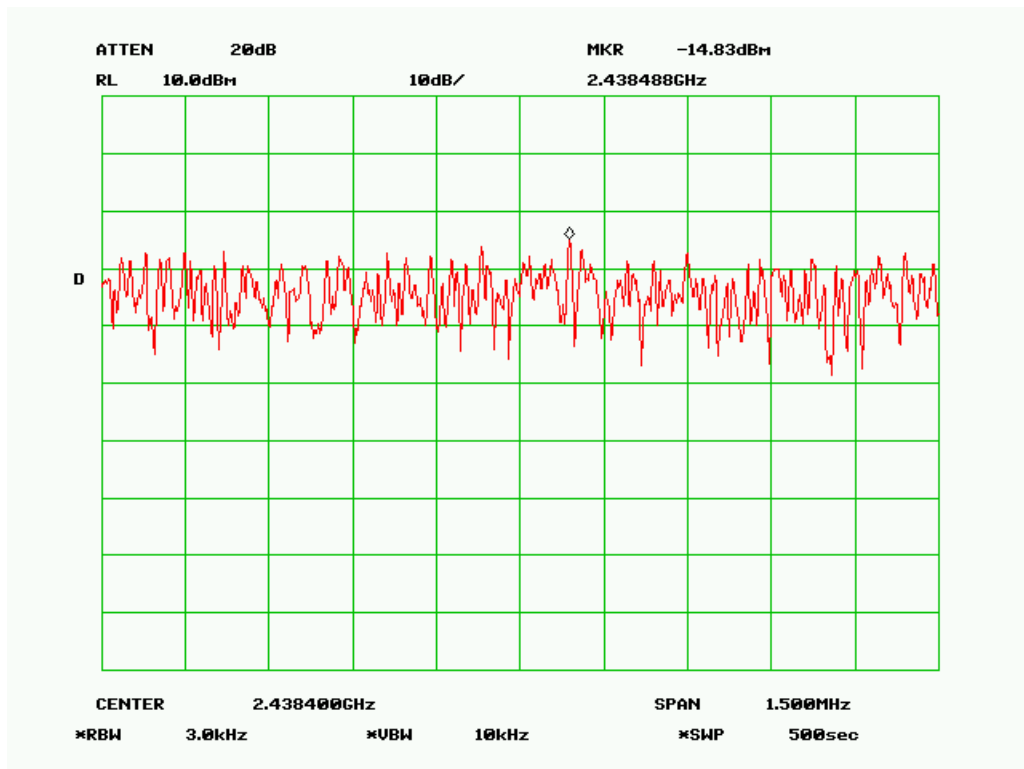

PSD Mid Channel ( 802.11b)

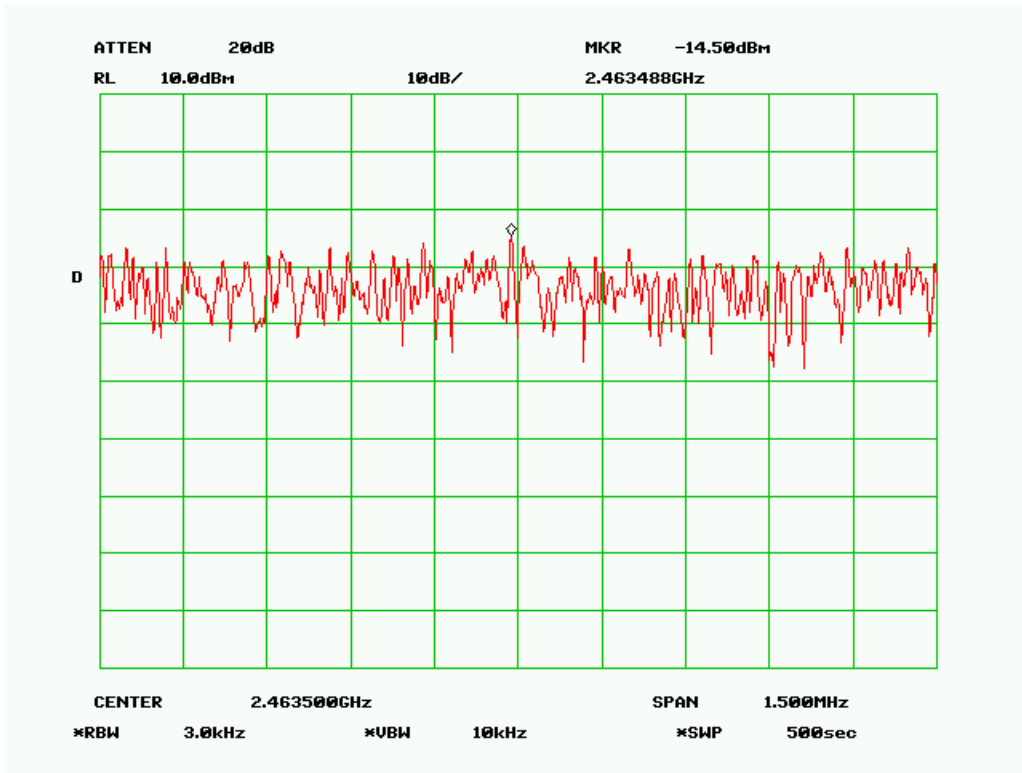

PSD High Channel ( 802.11b)

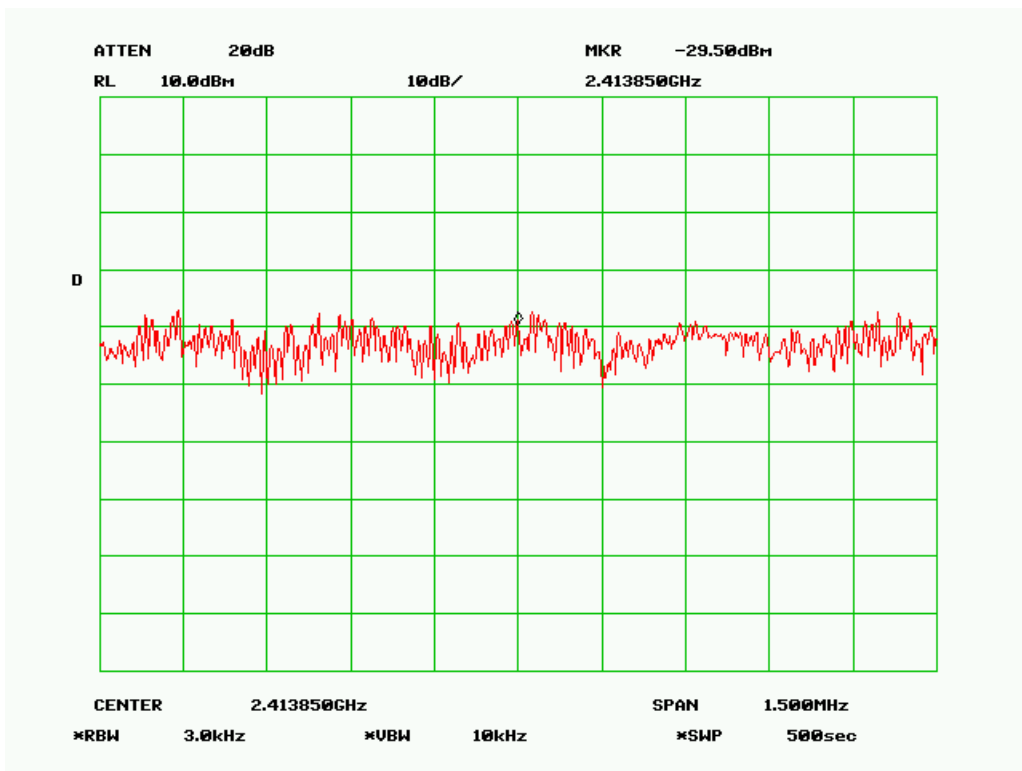

PSD Low Channel ( 802.11g)

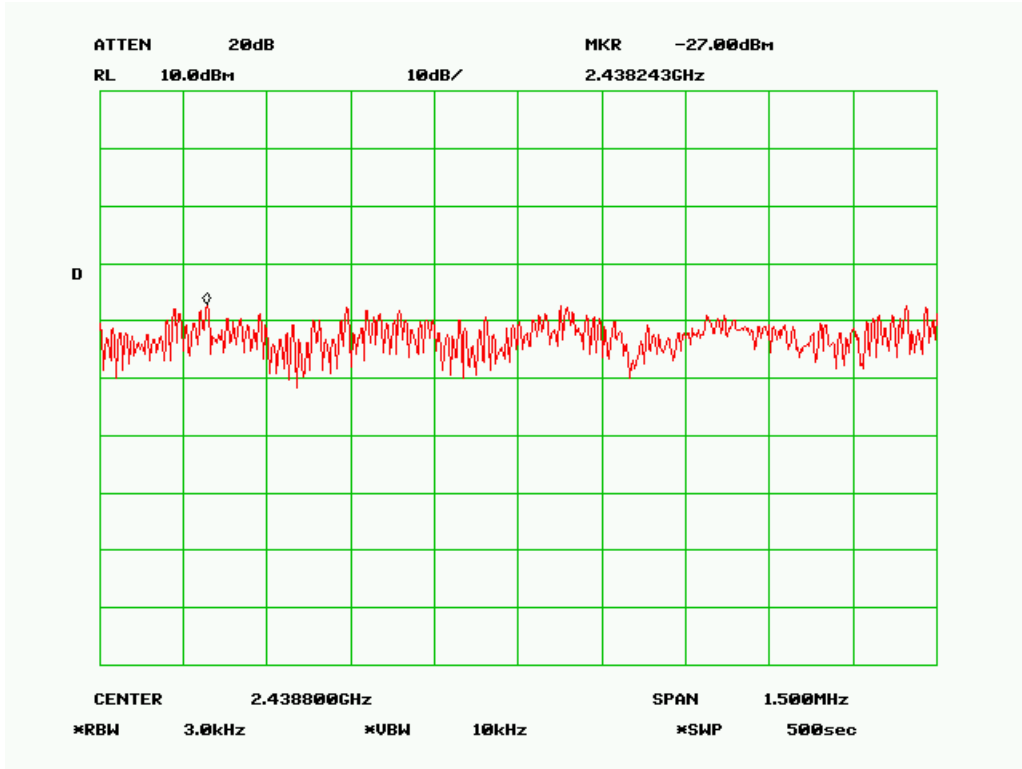

PSD Mid Channel ( 802.11g)

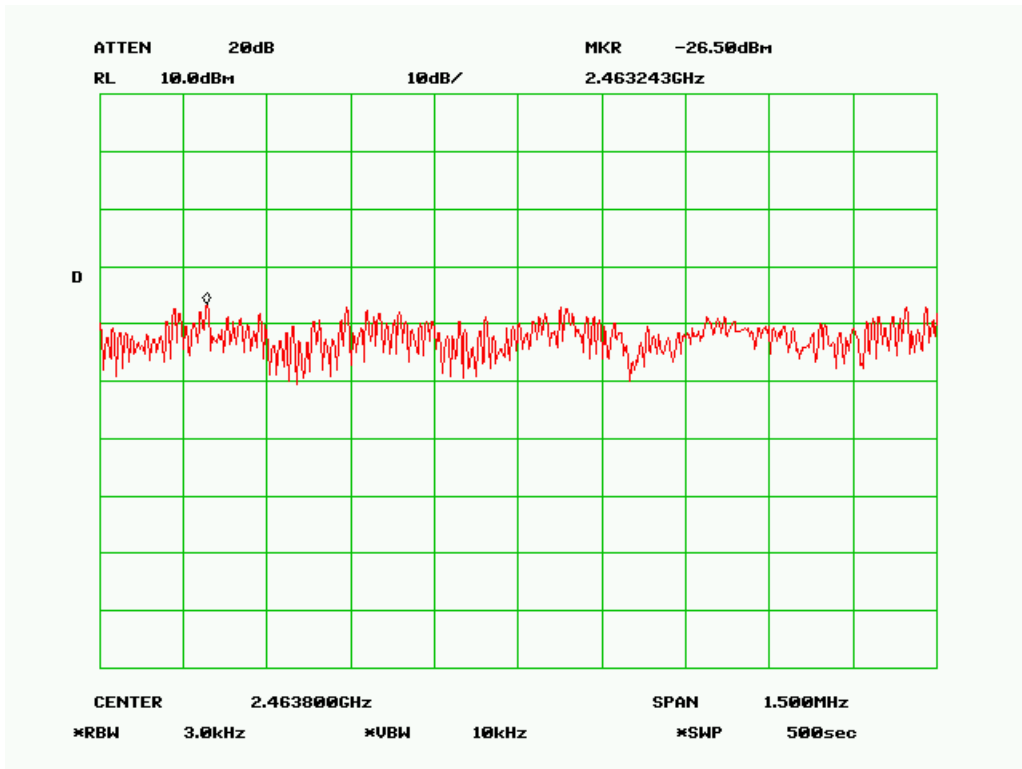

PSD High Channel ( 802.11g)



## 5.5 Peak Output Power

1. Conducted Measurement  
 EUT was set for low , mid, high channel with modulated mode and highest RF output power.  
 The spectrum analyzer was connected to the antenna terminal.
2. Conducted Emissions Measurement Uncertainty  
 All test measurements carried out are traceable to national standards. The uncertainty of the measurement at a confidence level of approximately 95% (in the case where distributions are normal), with a coverage factor of 2, in the range 30MHz – 40GHz is  $\pm 1.5$ dB.
3. Environmental Conditions
 

Temperature	23°C
Relative Humidity	50%
Atmospheric Pressure	1019mbar
4. Test Date : Nov 29th 2010 - Dec 17th 2010  
 Tested By :David Zhang

Standard Requirement: 47 CFR §15.247(b)

**Procedures:** The peak output power was measured conducted using a spectrum analyzer at low, mid, and hi channels. Peak detector was set to measure the power output. The power is converted from watt to dBm, therefore, 1 watt = 30 dBm. The highest antenna gain that will be used is 3.76 dBi.

**Test Result:** Pass

Protocol	Channel	Channel Frequency (MHz)	Peak Output Power Limit (dBm)	Measured Output Power(dBm)
802.11b	Low	2412	30	10.1
802.11b	Mid	2437	30	10.1
802.11b	High	2462	30	10.6
802.11g	Low	2412	30	10.2
802.11g	Mid	2437	30	10.8
802.11g	High	2462	30	10.2

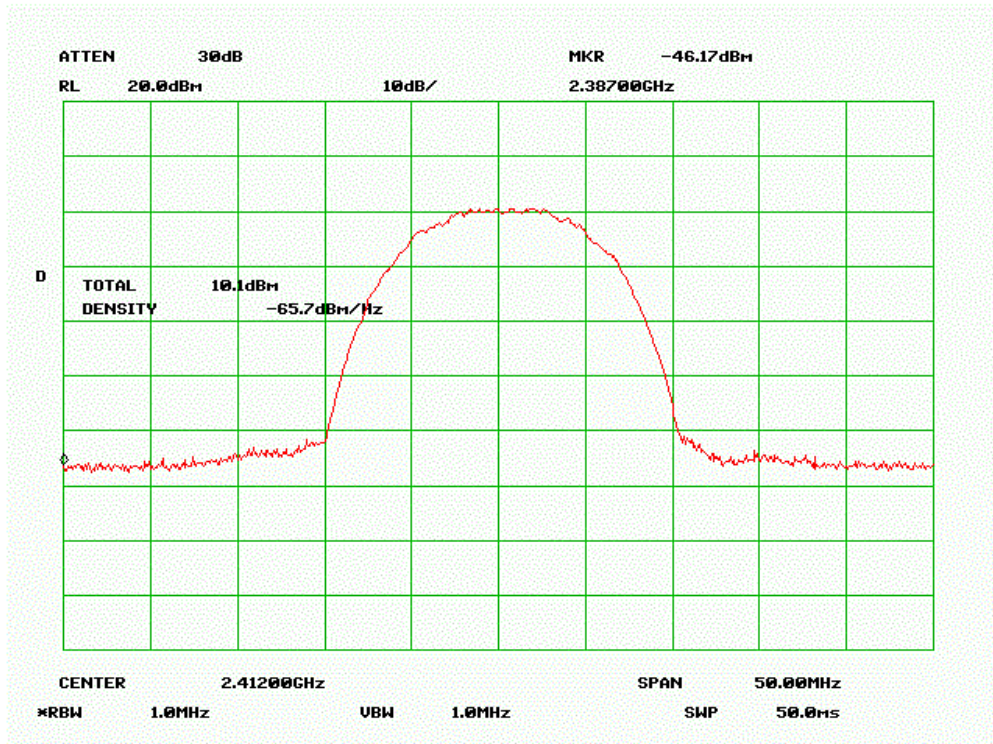

Output Power Low Channel (802.11b)

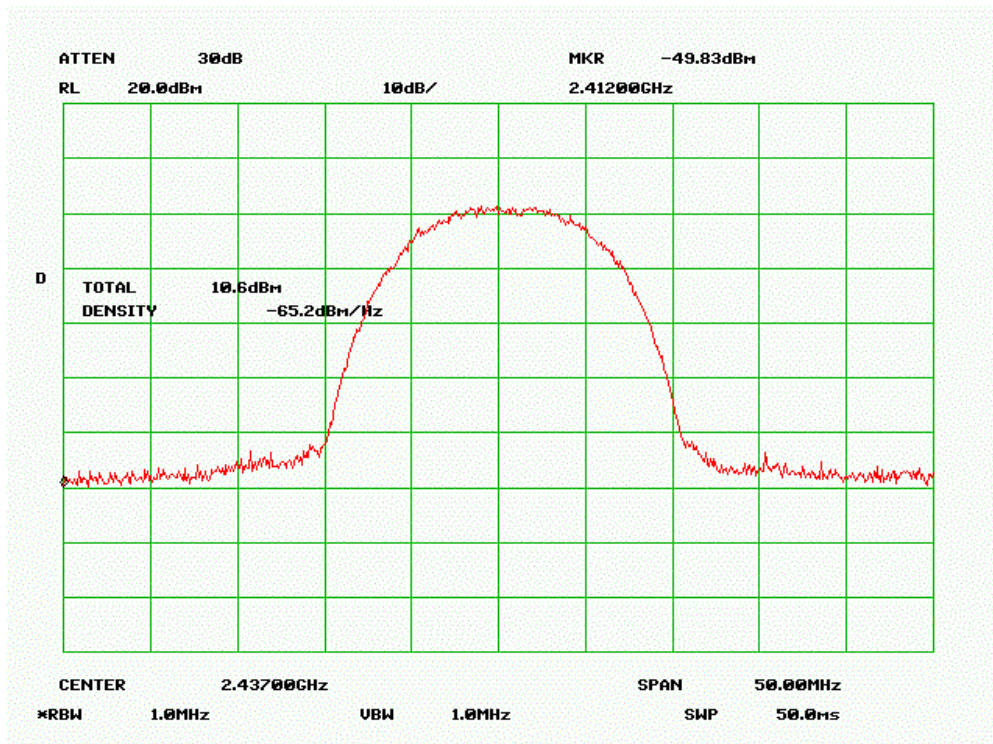

Output Power Middle Channel (802.11b)



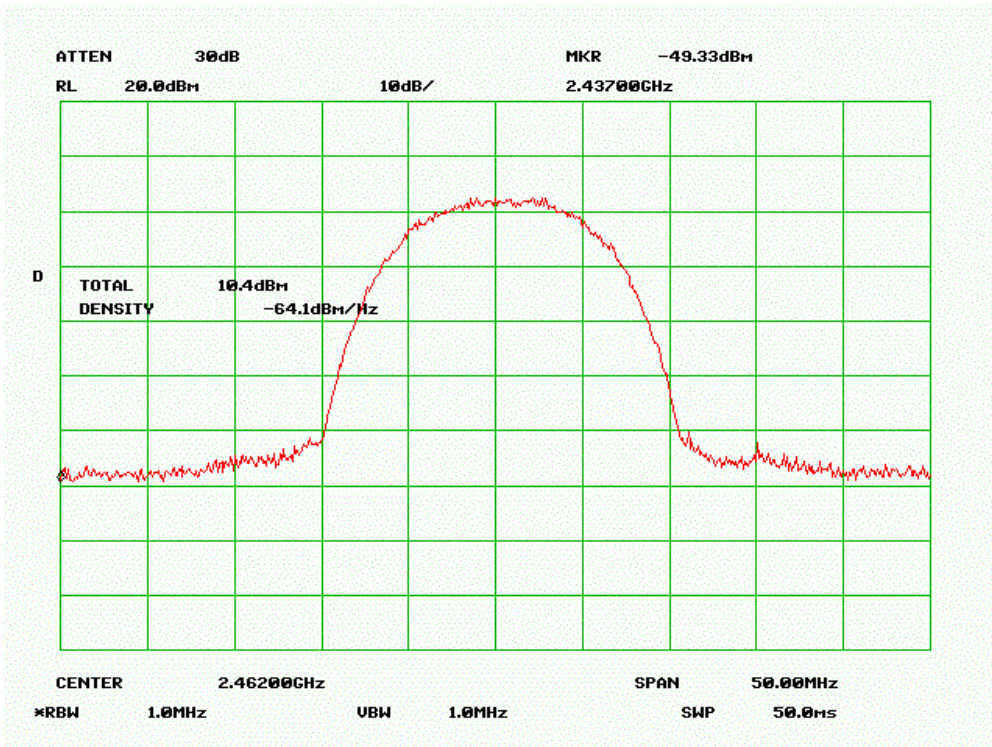

Output Power High Channel (802.11b)

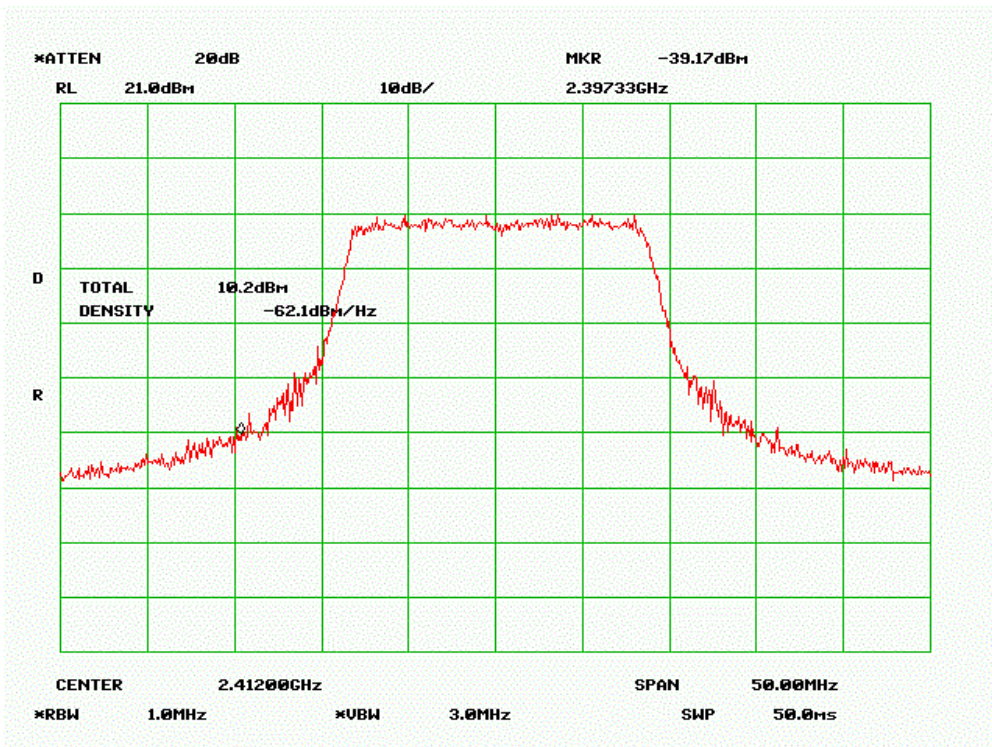

Output Power Low Channel (802.11g)



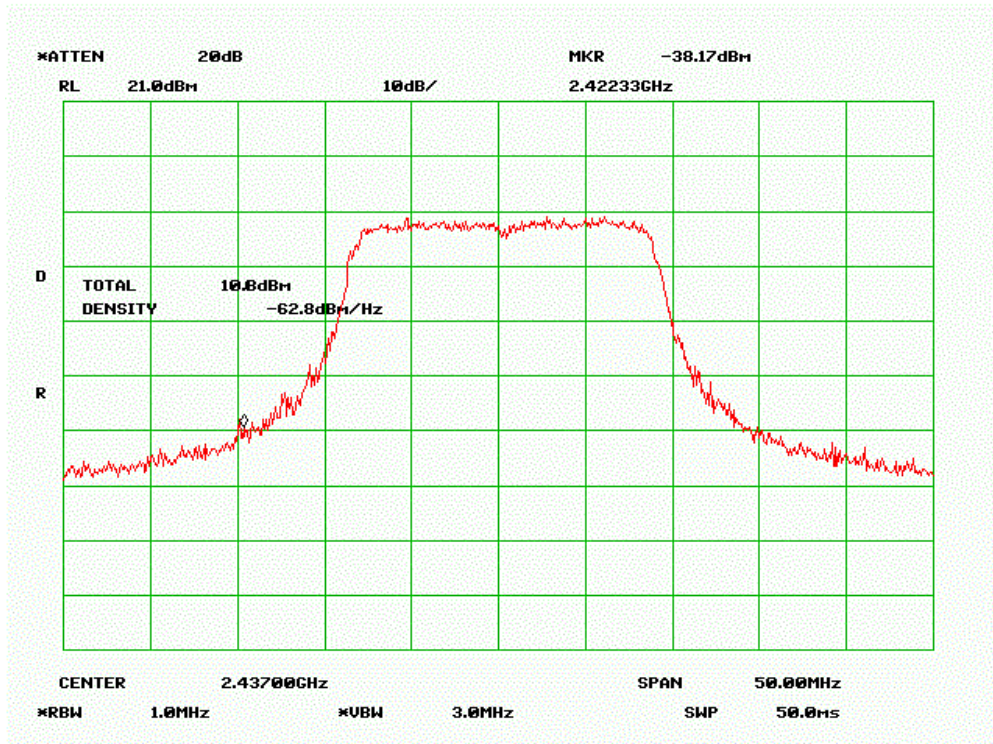

Output Power Middle Channel (802.11g)

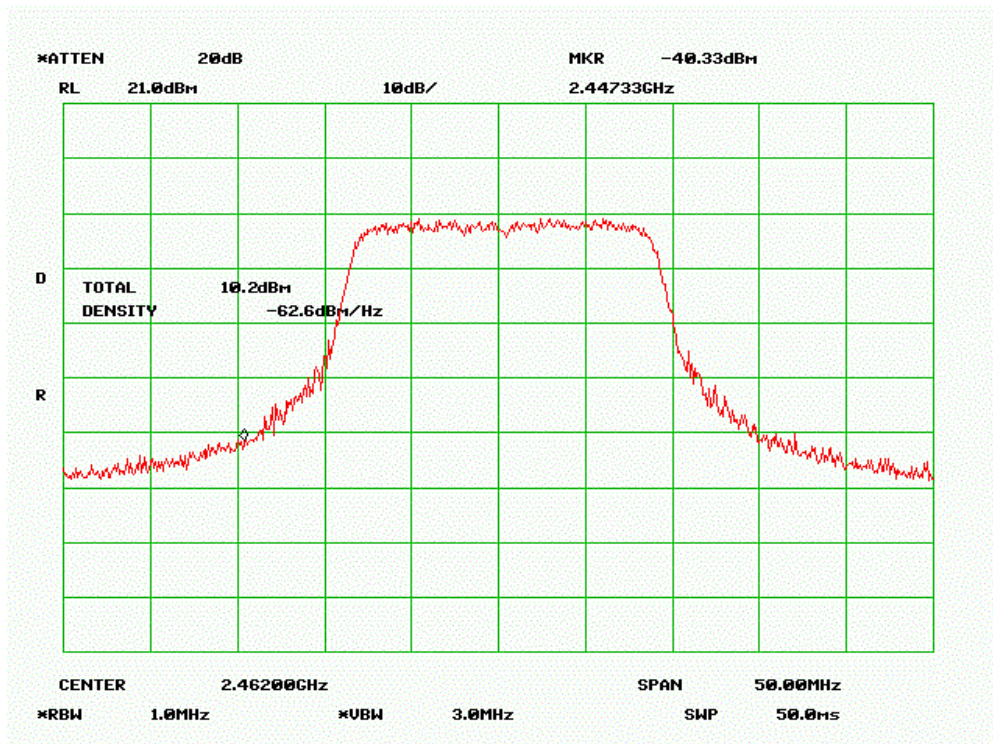

Output Power High Channel (802.11g)

## 5.6 Antenna Port Emission

1. Conducted Measurement  
EUT was set for low , mid, high channel with modulated mode and highest RF output power.  
The spectrum analyzer was connected to the antenna terminal.
2. Conducted Emissions Measurement Uncertainty  
All test measurements carried out are traceable to national standards. The uncertainty of the measurement at a confidence level of approximately 95% (in the case where distributions are normal), with a coverage factor of 2, in the range 30MHz – 40GHz is  $\pm 1.5\text{dB}$ .
3. Environmental Conditions
 

Temperature	23°C
Relative Humidity	50%
Atmospheric Pressure	1019mbar
4. Test Date : Nov 29th 2010 - Dec 17th 2010  
 Tested By : David Zhang

**Standard Requirement:** 47 CFR §15.247(d)

**Procedures:** The conducted spurious emissions were measured conducted using a spectrum analyzer at low, mid, and hi channels. The limit was determined by attenuating 20 dB of the RF peak power output

**Test Result:** Pass

**Configuration Mode : 802.11b**

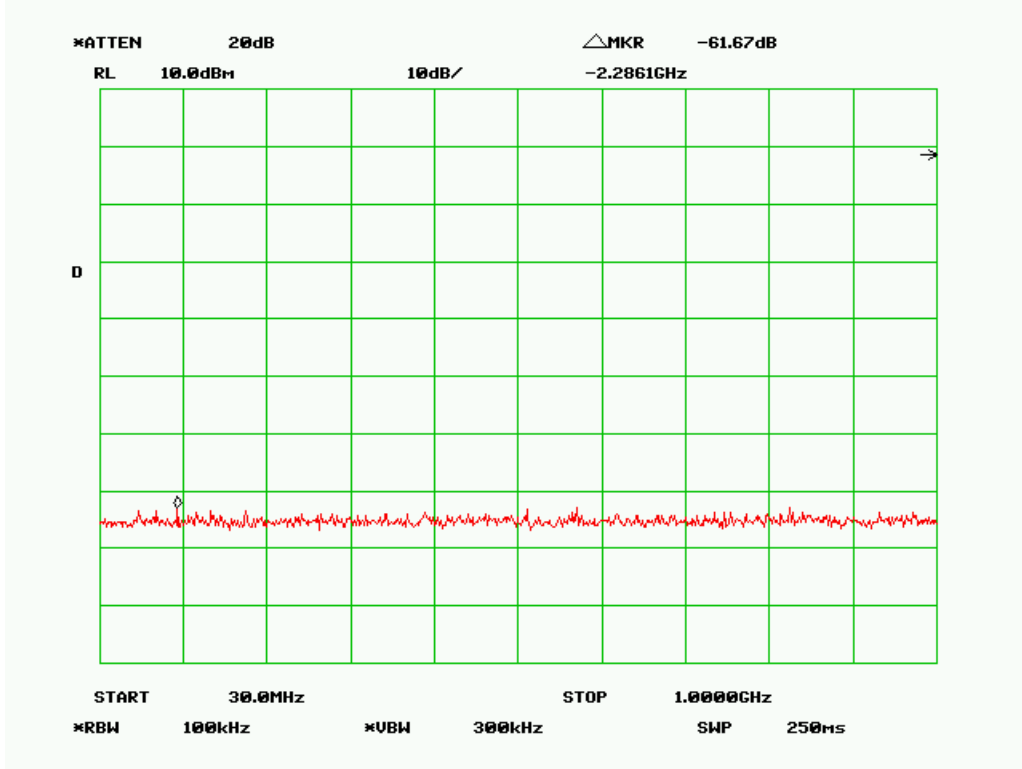

Low Channel -1

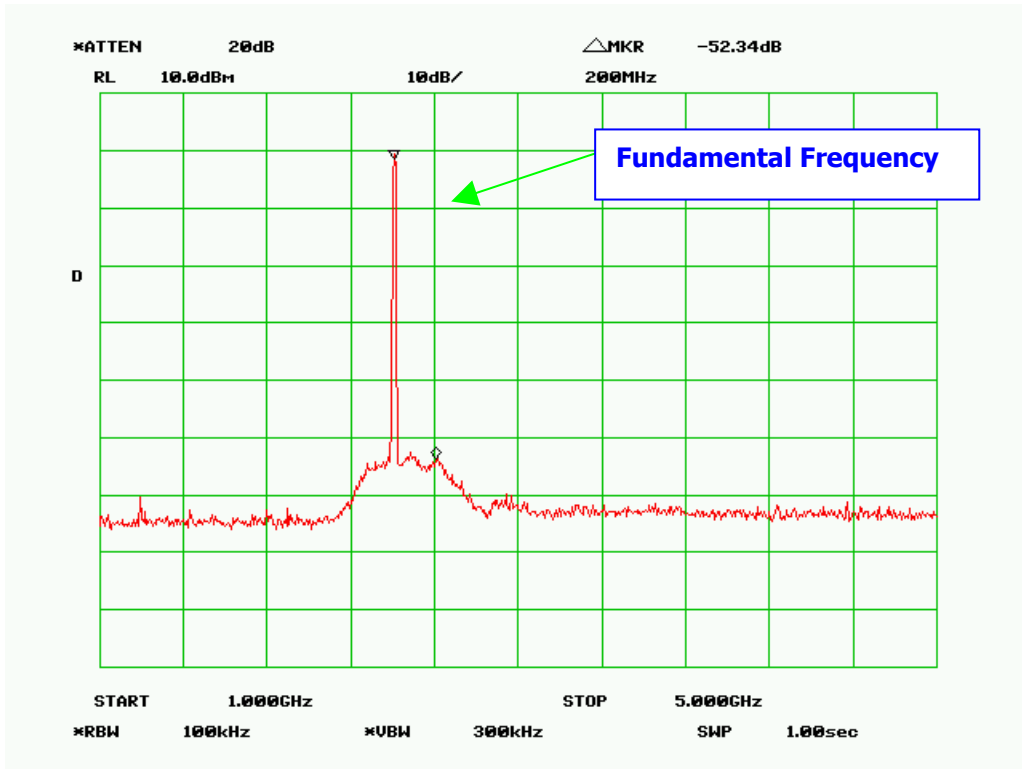

Low Channel -2

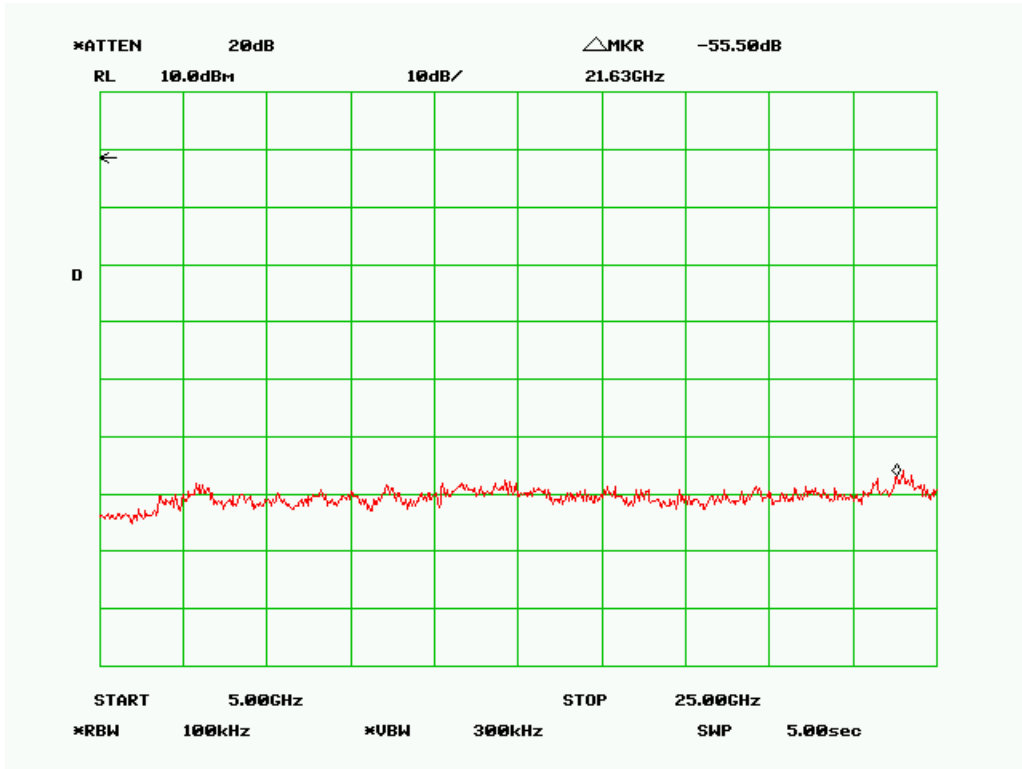

Low Channel -3

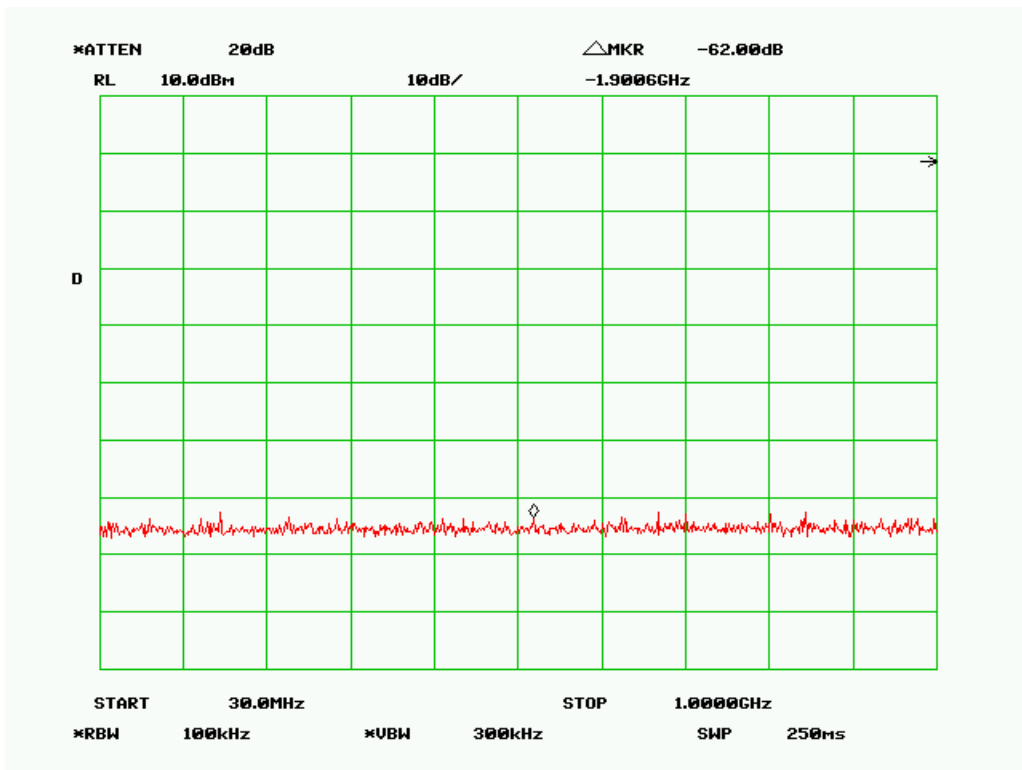

Mid Channel -1

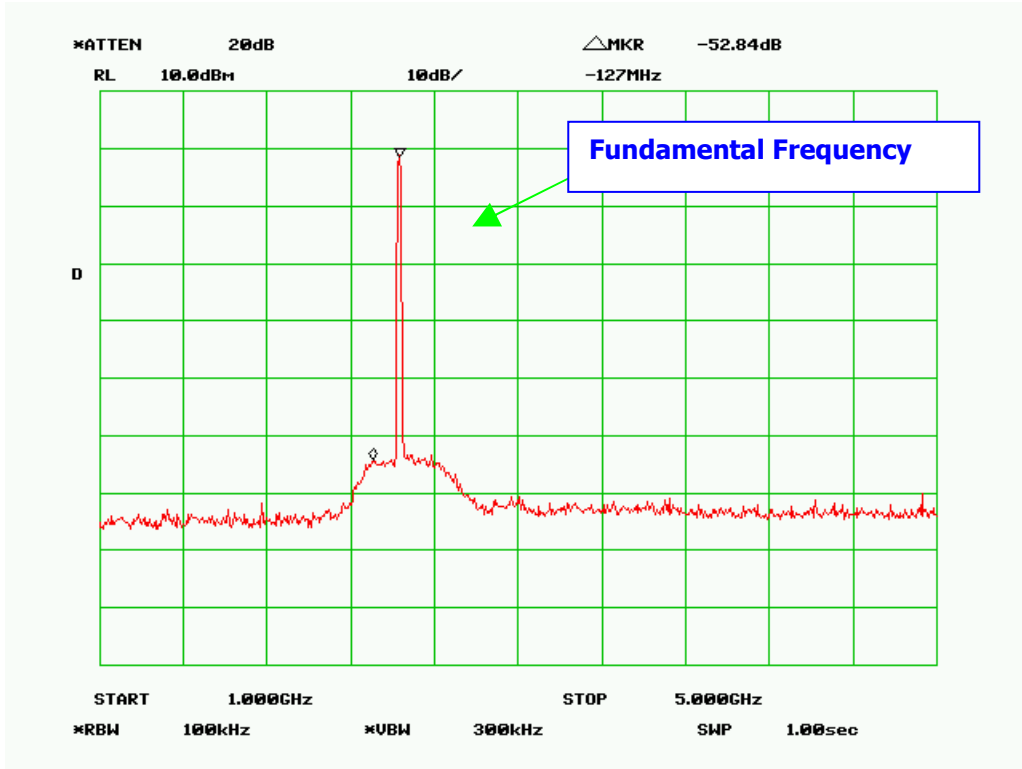

Mid Channel -2

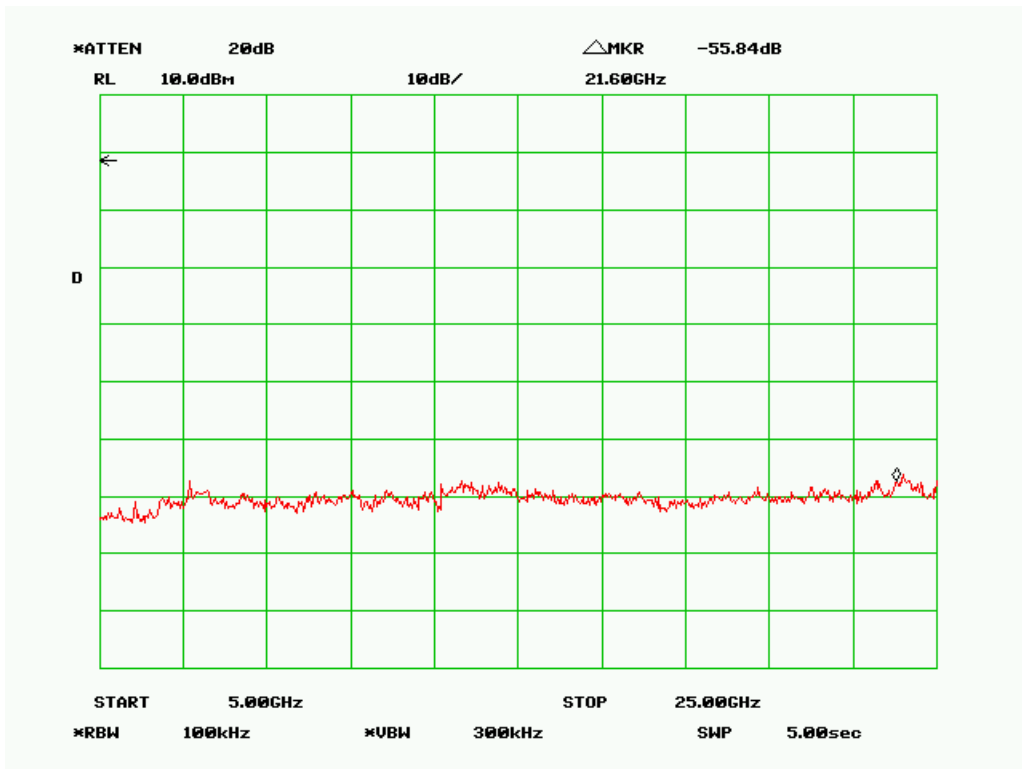

Mid Channel -3



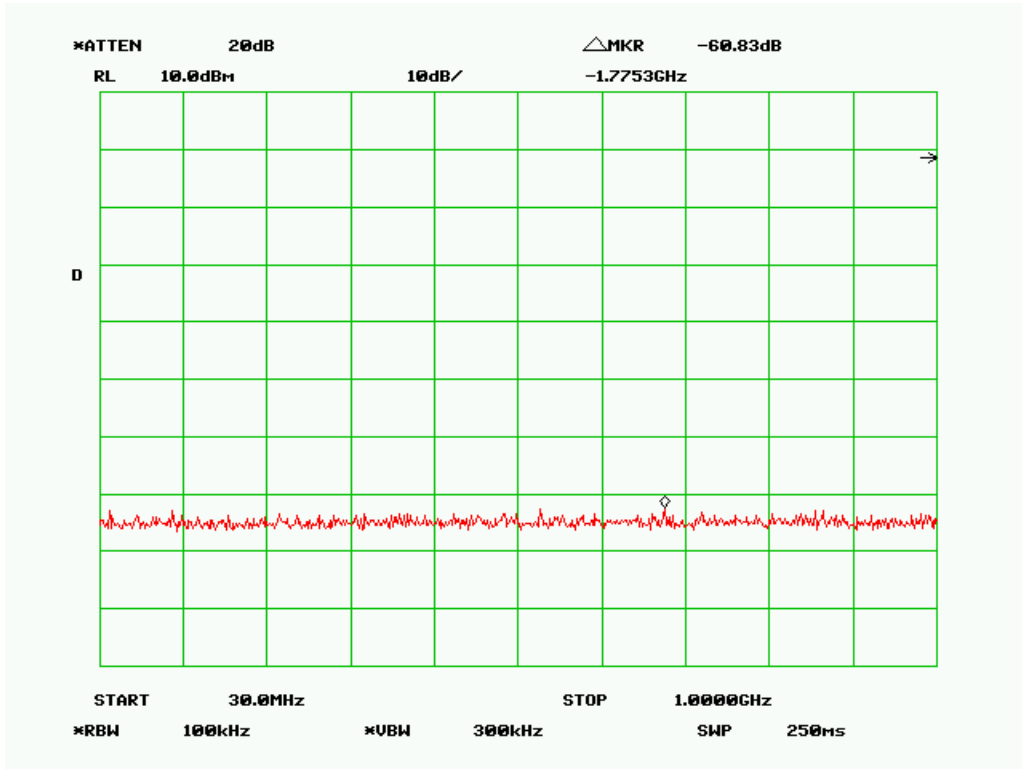

High Channel -1

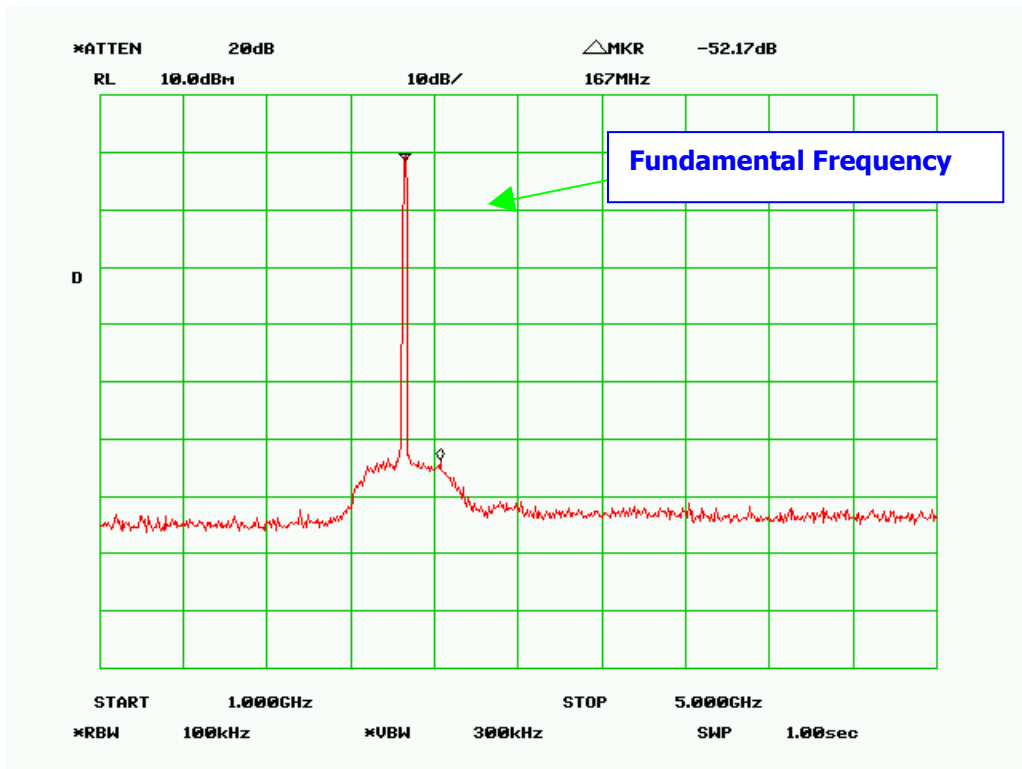

High Channel -2

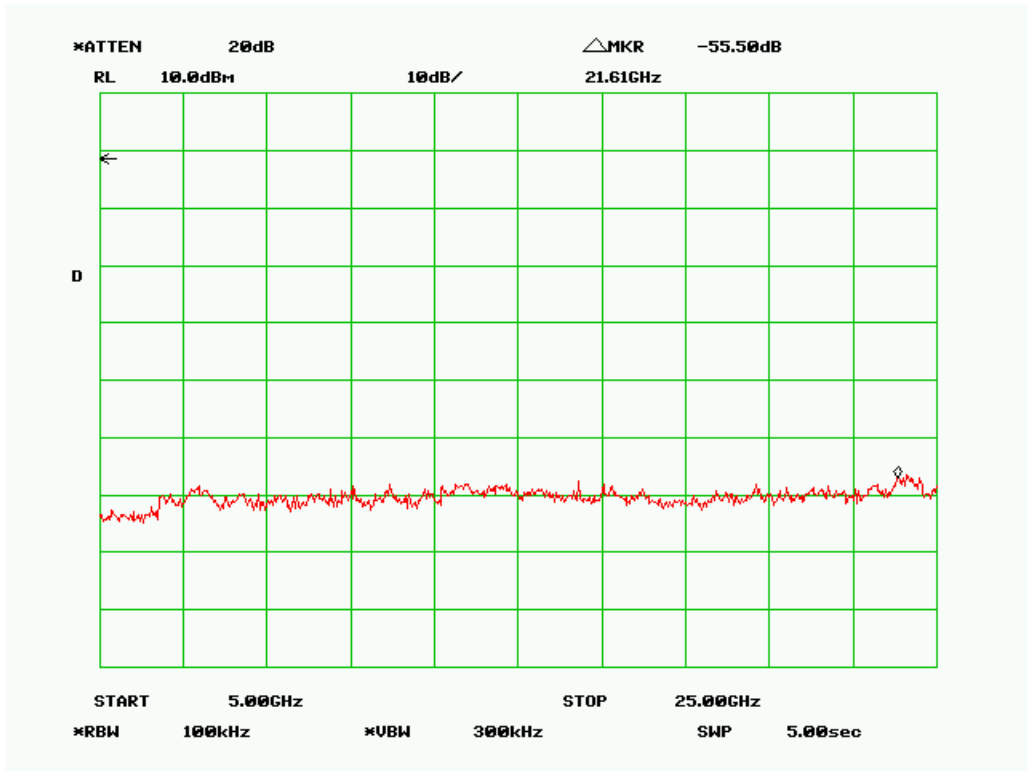

High Channel -3

Configuration Mode : 802.11g

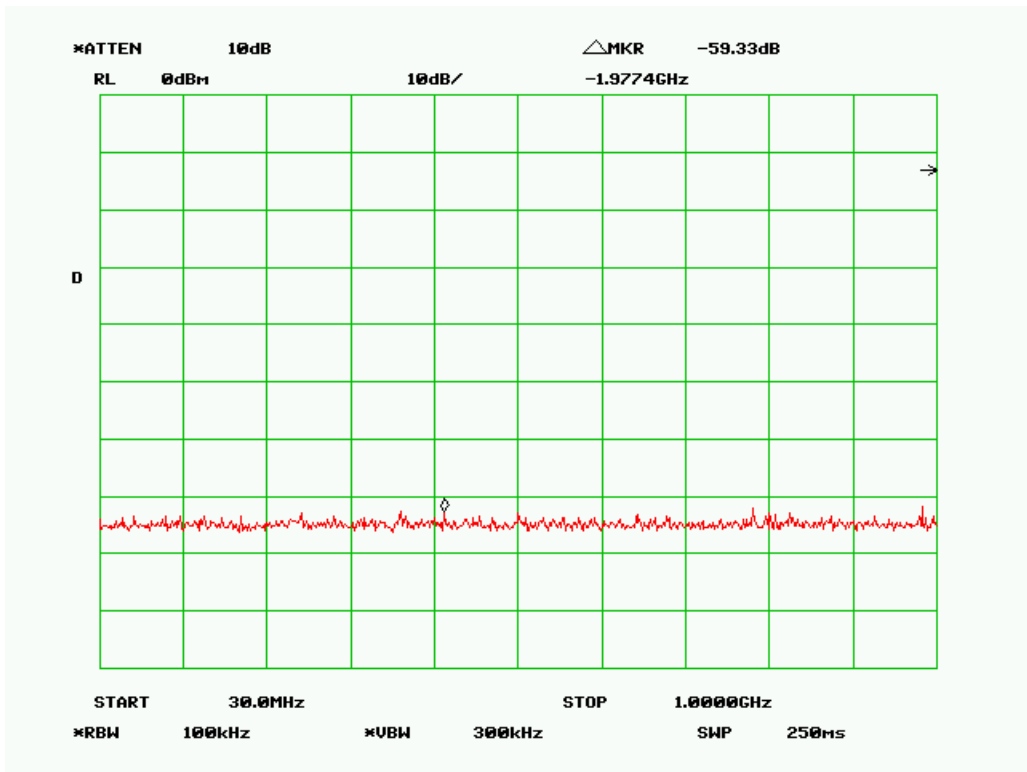

Low Channel -1

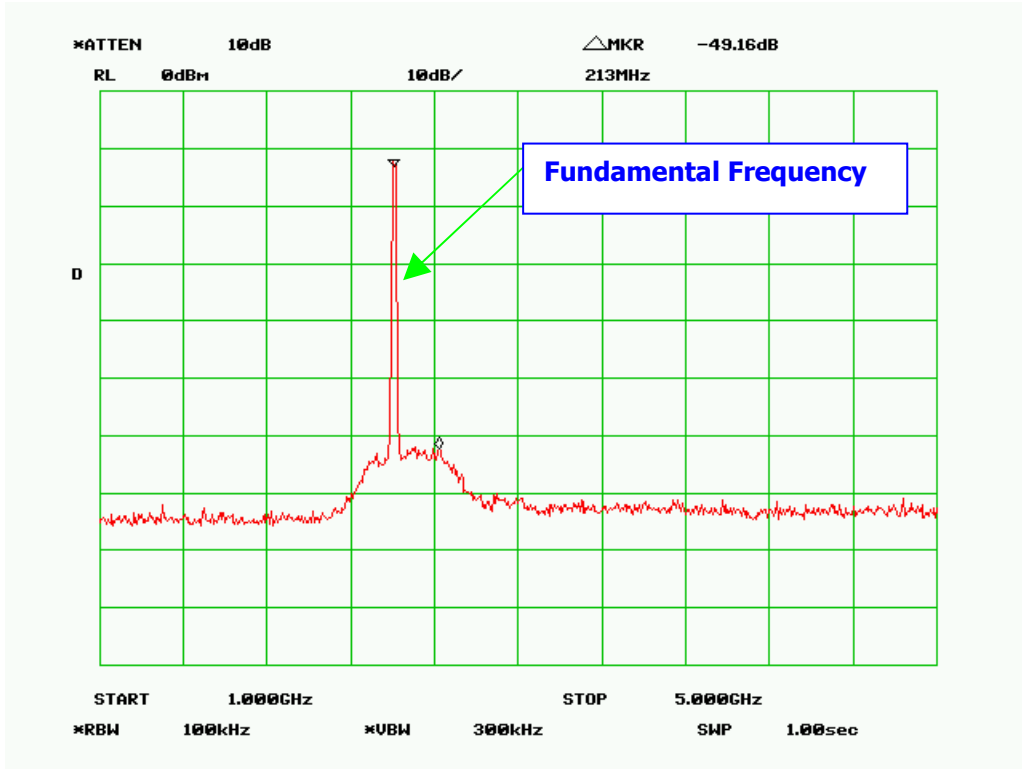

Low Channel -2

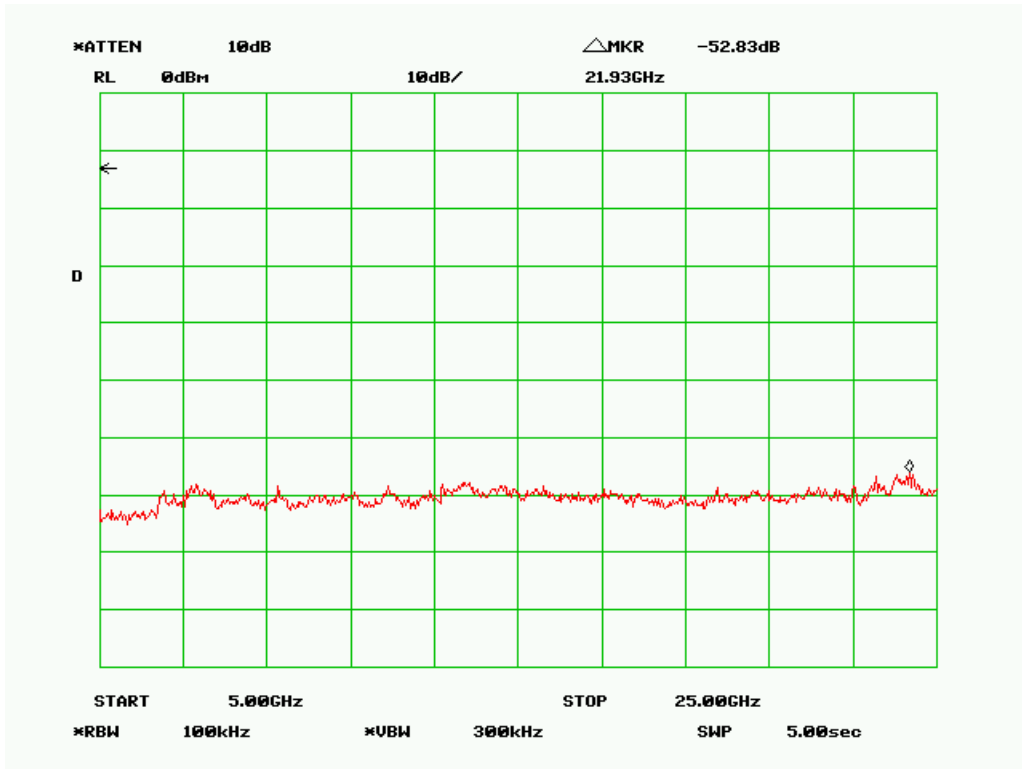

Low Channel -3

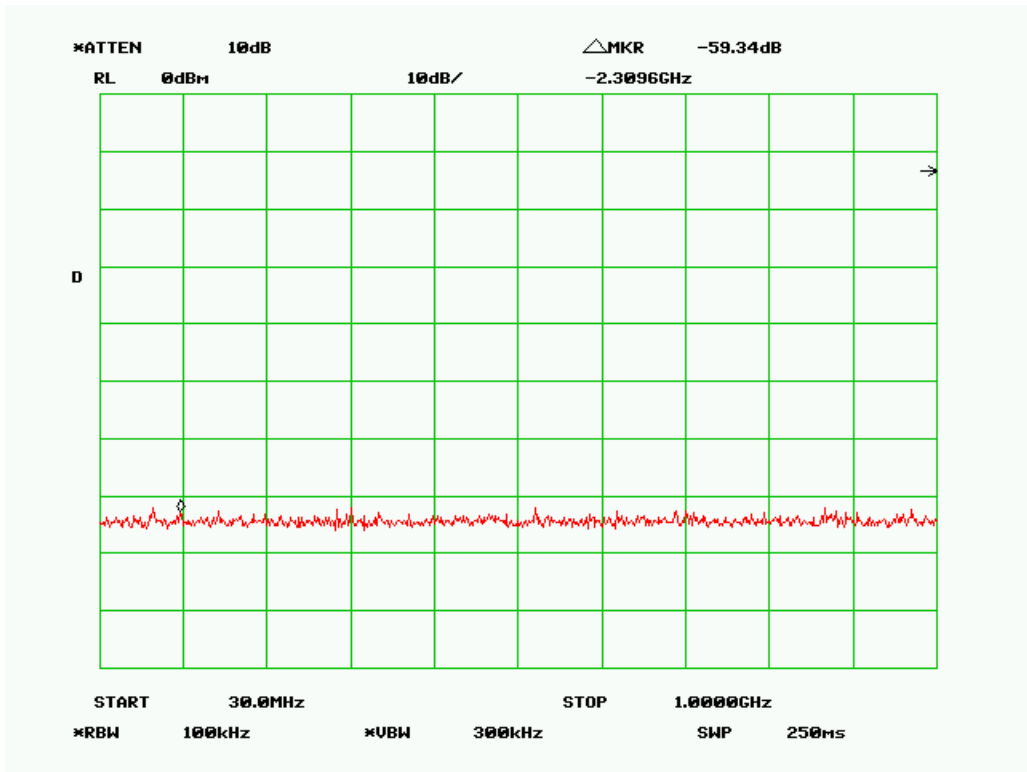

Mid Channel -1

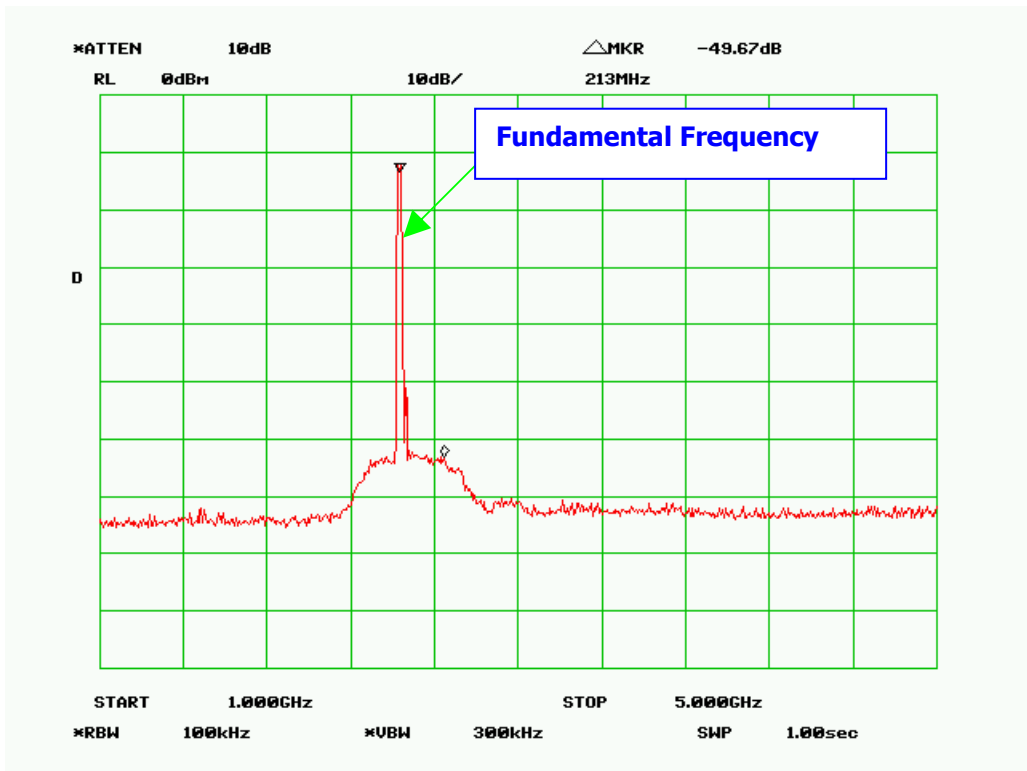

Mid Channel -2

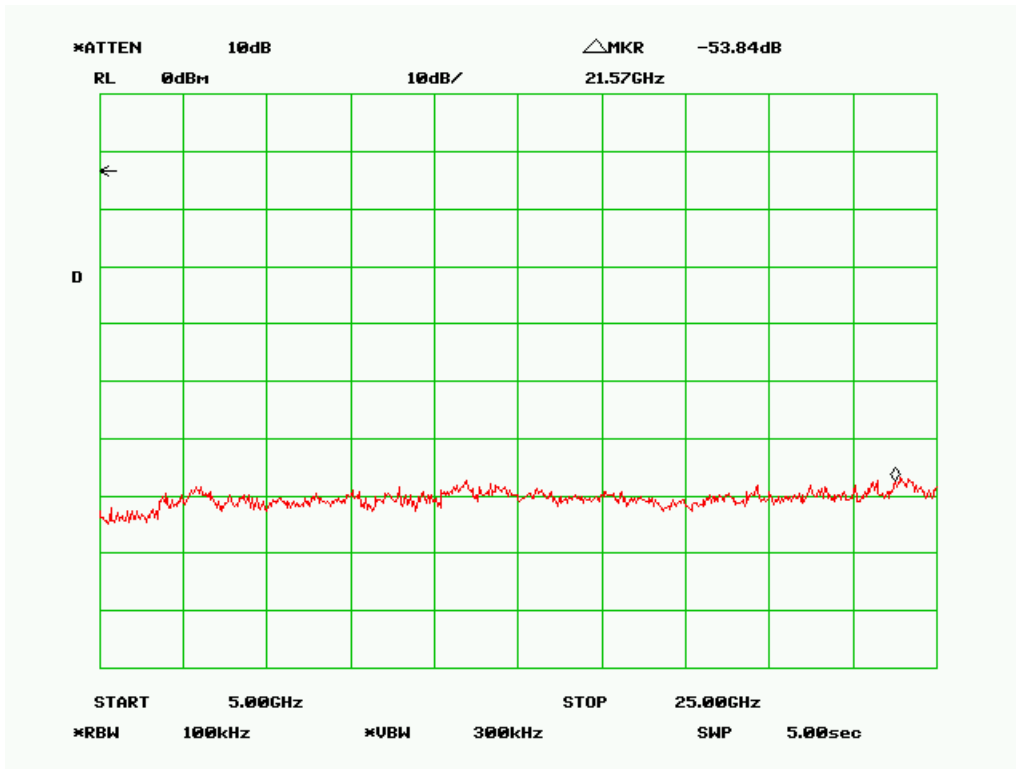

Mid Channel -3

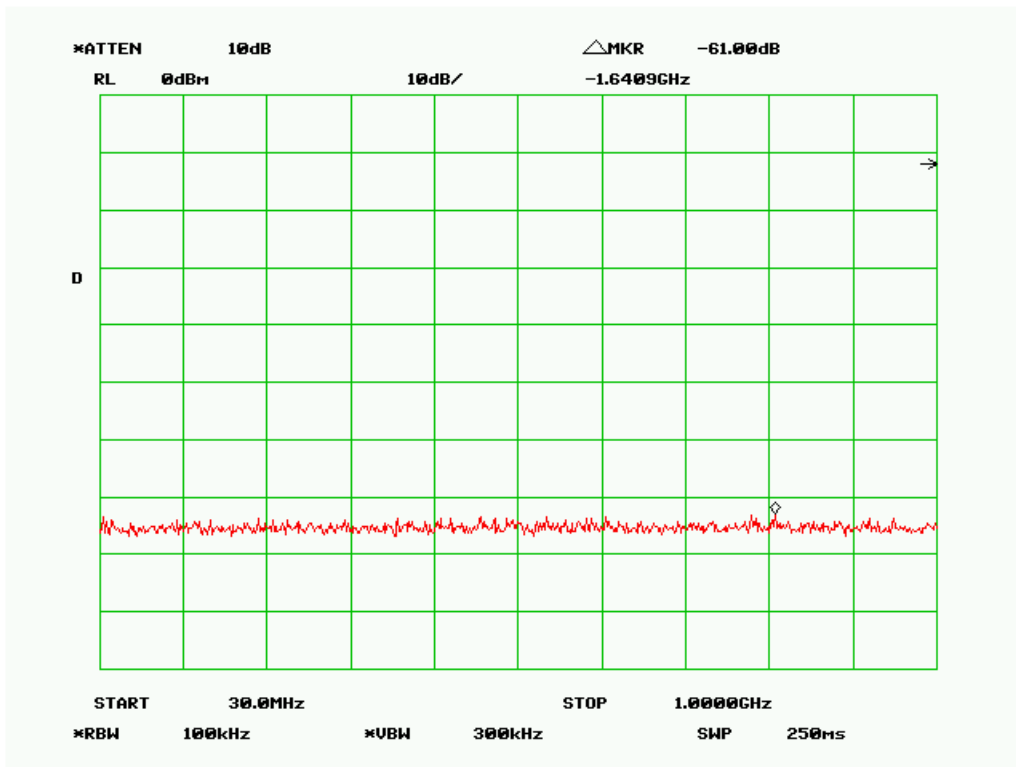

High Channel -1

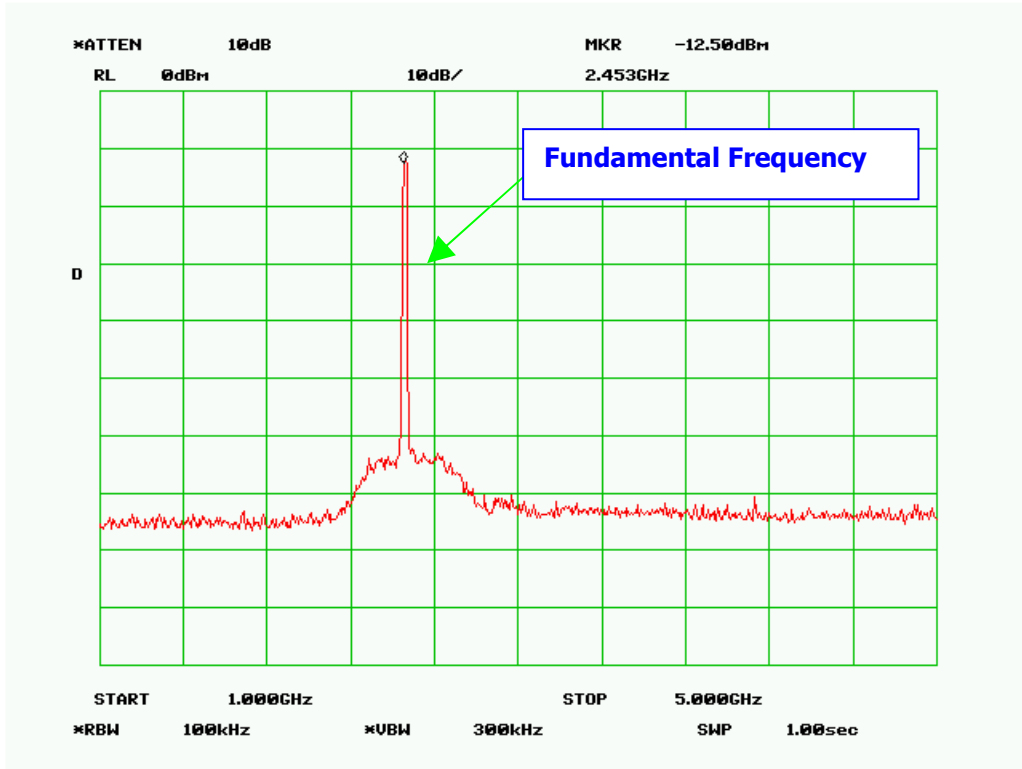

High Channel -2

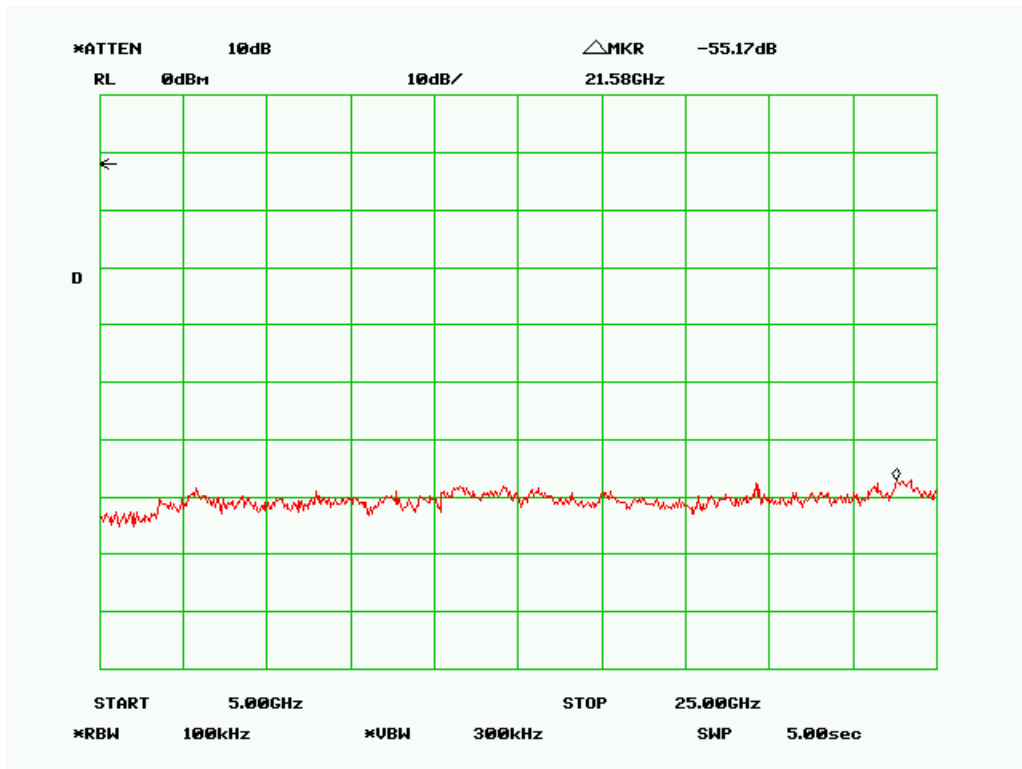

High Channel -3

## 5.7 Radiated Spurious Emission < 1GHz

1. All possible modes of operation were investigated. Only the 6 worst case emissions measured, using the correct CISPR detectors, are reported. All other emissions were relatively insignificant.
2. A "-ve" margin indicates a PASS as it refers to the margin present below the limit line at the particular frequency.
3. Radiated Emissions Measurement Uncertainty  
All test measurements carried out are traceable to national standards. The uncertainty of the measurement at a confidence level of approximately 95% (in the case where distributions are normal), with a coverage factor of 2, in the range 30MHz – 1GHz (QP only @ 3m & 10m) is +6.0dB (for EUTs < 0.5m X 0.5m X 0.5m).
4. Environmental Conditions
 

Temperature	23°C
Relative Humidity	50%
Atmospheric Pressure	1019mbar

Test Date : Nov 29th 2010 - Dec 17th 2010  
 Tested By :David Zhang

**Standard Requirement:** 47 CFR §15.247(d)

**Procedures:** The emissions from the Low-power radio-frequency devices shall not exceed the field strength levels specified in the following table and the level of any unwanted emissions shall not exceed the level of the fundamental emission. The tighter limit applies at the band edges.

The limit is converted from microvolts/meter to decibel microvolts/meter.

Sample Calculation: Corrected Amplitude = Raw Amplitude (dBμV/m) + ACF (dB) + Cable Loss ( dB)

**Test Result:** Pass

### Radiated Emission Plot

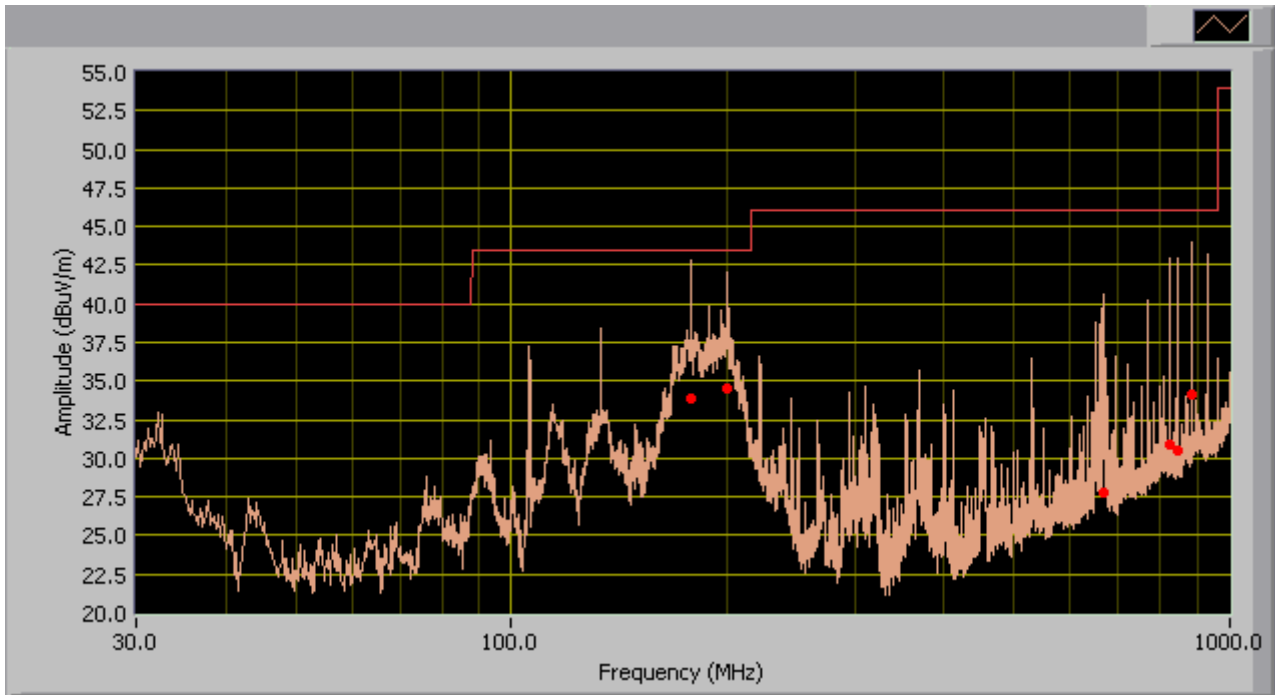

#### 30MHz ~1000MHz

Frequency (MHz)	Quasi-Peak (dBµV/m)	Turntable position (deg)	Polarity	Antenna height (cm)	Limit (dBµV/m)	Margin (dB)
824.76	30.85	350.00	V	108.00	24.91	46.00
884.71	34.15	198.00	V	93.00	25.42	46.00
666.25	27.76	104.00	H	93.00	22.42	46.00
177.90	33.75	50.00	H	93.00	13.09	43.50
846.25	30.48	42.00	V	93.00	24.54	46.00
200.01	34.39	273.00	H	93.00	14.66	43.50

Note: Emission at around 825MHz is cell phone noise signal which is not from EUT.



## 5.8 Radiated Spurious Emissions > 1GHz & Band Edge

1. All possible modes of operation were investigated. Only the 6 worst case emissions measured, using the correct CISPR detectors, are reported. All other emissions were relatively insignificant.
2. A "-ve" margin indicates a PASS as it refers to the margin present below the limit line at the particular frequency.
3. Radiated Emissions Measurement Uncertainty  
All test measurements carried out are traceable to national standards. The uncertainty of the measurement at a confidence level of approximately 95% (in the case where distributions are normal), with a coverage factor of 2, in the range 1GHz – 40GH is +6.0dB (for EUTs < 0.5m X 0.5m X 0.5m).
4. Environmental Conditions
 

Temperature	23°C
Relative Humidity	50%
Atmospheric Pressure	1019mbar

Test Date : Nov 29th 2010 - Dec 17th 2010  
 Tested By :David Zhang

Standard Requirement: 47 CFR §15.247(d)

**Procedures:** Equipment was setup in a semi-anechoic chamber. For measurements above 1 GHz an average measurement was taken with a 10Hz video bandwidth. The EUT was tested at low, mid and high with the highest output power. An emission was scan up to 10<sup>th</sup> harmonic of the operating frequency.

Sample Calculation:

EUT Field Strength = Raw Amplitude (dBμV/m) – Amplifier Gain (dB) + Antenna Factor (dB) + Cable Loss (dB) + Filter Attenuation (dB, if used)

**NOTE: Co-location or operating simultaneously Spurious emission was investigated, and no IM spurious emission was found. Thus present the individual radio spurious emission as worst case in this report.**

**Test Result:** Pass

### 802.11b @ 2412MHz @ 3 Meter

Frequency (GHz)	Reading (dBuV/m)	Direction (degree)	Height (m)	Polarity (H/V)	Antenna Loss (dB)	Cable Loss (dB)	Amplifier (dB)	Corrected Reading (dBuV/m)	15.247/15.209 Limit @ 3m (dBuV/m)	Margin (dBuV/m)	Detector (pk/avg)
4.824	49.64	169.00	1.00	V	32.20	4.13	32.49	53.48	74.00	-20.52	pk
4.824	47.65	212.00	1.60	H	32.20	4.13	32.49	51.49	74.00	-22.51	avg
4.824	34.39	169.00	1.00	V	32.20	4.13	32.49	38.23	54.00	-15.77	pk
4.824	34.49	212.00	1.60	H	32.20	4.13	32.49	38.33	54.00	-15.67	avg
7.236	52.99	295.00	2.00	V	35.10	5.22	32.39	60.92	74.00	-13.08	pk
7.236	53.27	216.00	1.20	H	35.10	5.22	32.39	61.20	74.00	-12.80	avg
7.236	39.70	295.00	2.00	V	35.10	5.22	32.39	47.63	54.00	-6.37	pk
7.236	39.70	216.00	1.20	H	35.10	5.22	32.39	47.63	54.00	-6.37	avg
9.648	42.57	190.00	1.10	V	38.90	6.26	32.32	55.41	74.00	-18.59	pk
9.648	41.86	271.00	1.70	H	38.90	6.26	32.32	54.70	74.00	-19.30	avg
9.648	31.37	190.00	1.10	V	38.90	6.26	32.32	44.21	54.00	-9.79	pk
9.648	31.04	271.00	1.70	H	38.90	6.26	32.32	43.88	54.00	-10.12	avg
2.400	60.23	196.00	1.50	V	27.50	2.50	32.04	58.19	74.00	-15.81	pk
2.400	63.91	263.00	1.50	H	27.50	2.50	32.04	61.87	74.00	-12.13	avg
2.400	40.61	196.00	1.50	V	27.50	2.50	32.04	38.57	54.00	-15.43	pk
2.400	42.06	263.00	1.50	H	27.50	2.50	32.04	40.02	54.00	-14.89	avg

**Note:** Emission was scanned up to 25GHz; no emissions were detected above the noise floor which was at least 20dB below the specification limit

### 802.11b @ 2437MHz @ 3 Meter

Frequency (GHz)	Reading (dBuV/m)	Direction (degree)	Height (m)	Polarity (H/V)	Antenna Loss (dB)	Cable Loss (dB)	Amplifier (dB)	Corrected Reading (dBuV/m)	15.247/15.209 Limit @ 3m (dBuV/m)	Margin (dBuV/m)	Detector (pk/avg)
4.874	49.23	272.00	1.60	V	32.20	4.13	32.49	53.07	74.00	-20.93	pk
4.874	48.58	307.00	1.60	H	32.20	4.13	32.49	52.42	74.00	-21.58	avg
4.874	35.19	272.00	1.60	V	32.20	4.13	32.49	39.03	54.00	-14.97	pk
4.874	35.17	307.00	1.60	H	32.20	4.13	32.49	39.01	54.00	-14.99	avg
7.311	52.68	163.00	1.70	V	35.10	5.22	32.39	60.61	74.00	-13.39	pk
7.311	53.03	279.00	2.00	H	35.10	5.22	32.39	60.96	74.00	-13.04	avg
7.311	39.56	163.00	1.70	V	35.10	5.22	32.39	47.49	54.00	-6.51	pk
7.311	39.57	279.00	2.00	H	35.10	5.22	32.39	47.50	54.00	-6.50	avg
9.748	50.35	284.00	1.60	V	38.90	6.26	32.32	63.19	74.00	-10.81	pk
9.748	50.02	319.00	2.00	H	38.90	6.26	32.32	62.86	74.00	-11.14	avg
9.748	34.62	284.00	1.60	V	38.90	6.26	32.32	47.46	54.00	-6.54	pk
9.748	34.61	319.00	2.00	H	38.90	6.26	32.32	47.45	54.00	-6.55	avg

**Note:** Emission was scanned up to 25GHz; no emissions were detected above the noise floor which was at least 20dB below the specification limit

### 802.11b @ 2462MHz @ 3 Meter

Frequency (GHz)	Reading (dBuV/m)	Direction (degree)	Height (m)	Polarity (H/V)	Antenna Loss (dB)	Cable Loss (dB)	Amplifier (dB)	Corrected Reading (dBuV/m)	15.247/15.209 Limit @ 3m (dBuV/m)	Margin (dBuV/m)	Detector (pk/avg)
4.924	48.33	149.00	1.60	V	32.20	4.13	32.49	52.17	74.00	-21.83	pk
4.924	49.32	235.00	1.60	H	32.20	4.13	32.49	53.16	74.00	-20.84	avg
4.924	35.16	149.00	1.60	V	32.20	4.13	32.49	39.00	54.00	-15.00	pk
4.924	35.16	235.00	1.60	H	32.20	4.13	32.49	39.00	54.00	-15.00	avg
7.386	53.99	276.00	1.70	V	35.10	5.22	32.39	61.92	74.00	-12.08	pk
7.386	54.17	291.00	2.00	H	35.10	5.22	32.39	62.10	74.00	-11.90	avg
7.386	39.65	276.00	1.70	V	35.10	5.22	32.39	47.58	54.00	-6.42	pk
7.386	39.67	291.00	2.00	H	35.10	5.22	32.39	47.60	54.00	-6.40	avg
9.848	47.90	233.00	1.60	V	38.90	6.26	32.32	60.74	74.00	-13.26	pk
9.848	46.66	240.00	2.00	H	38.90	6.26	32.32	59.50	74.00	-14.50	avg
9.848	33.19	233.00	1.60	V	38.90	6.26	32.32	46.03	54.00	-7.97	pk
9.848	33.20	240.00	2.00	H	38.90	6.26	32.32	46.04	54.00	-7.96	avg
2.484	50.29	149.00	1.60	V	27.50	2.50	32.04	48.25	74.00	-25.75	pk
2.484	50.64	235.00	1.60	H	27.50	2.50	32.04	48.60	74.00	-25.40	avg
2.484	37.18	149.00	1.60	V	27.50	2.50	32.04	35.14	54.00	-18.86	pk
2.484	37.25	235.00	1.60	H	27.50	2.50	32.04	35.21	54.00	-14.89	avg

**Note:** Emission was scanned up to 25GHz; no emissions were detected above the noise floor which was at least 20dB below the specification limit

### 802.11g @ 2412MHz @ 3 Meter

Frequency (GHz)	Reading (dBuV/m)	Direction (degree)	Height (m)	Polarity (H/V)	Antenna Loss (dB)	Cable Loss (dB)	Amplifier (dB)	Corrected Reading (dBuV/m)	15.247/15.209 Limit @ 3m (dBuV/m)	Margin (dBuV/m)	Detector (pk/avg)
4.824	48.58	219.00	2.20	V	32.20	4.13	32.49	52.42	74.00	-21.58	pk
4.824	48.42	212.00	1.60	H	32.20	4.13	32.49	52.26	74.00	-21.74	avg
4.824	34.80	219.00	2.20	V	32.20	4.13	32.49	38.64	54.00	-15.36	pk
4.824	34.44	212.00	1.60	H	32.20	4.13	32.49	38.28	54.00	-15.72	avg
7.236	51.37	280.00	1.90	V	35.10	5.22	32.39	59.30	74.00	-14.70	pk
7.236	52.30	216.00	1.20	H	35.10	5.22	32.39	60.23	74.00	-13.77	avg
7.236	38.63	280.00	1.90	V	35.10	5.22	32.39	46.56	54.00	-7.44	pk
7.236	38.69	216.00	1.20	H	35.10	5.22	32.39	46.62	54.00	-7.38	avg
9.648	43.91	156.00	1.10	V	38.90	6.26	32.32	56.75	74.00	-17.25	pk
9.648	43.26	271.00	1.80	H	38.90	6.26	32.32	56.10	74.00	-17.90	avg
9.648	34.80	156.00	1.10	V	38.90	6.26	32.32	47.64	54.00	-6.36	pk
9.648	33.57	271.00	1.80	H	38.90	6.26	32.32	46.41	54.00	-7.59	avg
2.400	59.12	167.00	2.00	V	27.50	2.50	32.04	57.08	74.00	-16.92	pk
2.400	63.82	102.00	2.10	H	27.50	2.50	32.04	61.78	74.00	-12.22	avg
2.400	39.50	167.00	2.00	V	27.50	2.50	32.04	37.46	54.00	-16.54	pk
2.400	40.85	102.00	2.10	H	27.50	2.50	32.04	38.81	54.00	-14.89	avg

**Note:** Emission was scanned up to 25GHz; no emissions were detected above the noise floor which was at least 20dB below the specification limit



**802.11g @ 2437MHz @ 3 Meter**

Frequency (GHz)	Reading (dBuV/m)	Direction (degree)	Height (m)	Polarity (H/V)	Antenna Loss (dB)	Cable Loss (dB)	Amplifier (dB)	Corrected Reading (dBuV/m)	15.247/15.209 Limit @ 3m (dBuV/m)	Margin (dBuV/m)	Detector (pk/avg)
4.874	49.08	174.0	1.32	V	32.20	4.13	32.49	52.92	74.00	-21.08	pk
4.874	49.63	233.0	1.10	H	32.20	4.13	32.49	53.47	74.00	-20.53	avg
4.874	35.07	174.0	1.30	V	32.20	4.13	32.49	38.91	54.00	-15.09	pk
4.874	35.52	233.0	1.10	H	32.20	4.13	32.49	39.36	54.00	-14.64	avg
7.311	51.77	207.0	1.21	V	35.10	5.22	32.39	59.70	74.00	-14.30	pk
7.311	52.02	231.0	1.50	H	35.10	5.22	32.39	59.95	74.00	-14.05	avg
7.311	39.43	207.0	1.21	V	35.10	5.22	32.39	47.36	54.00	-6.64	pk
7.311	39.47	231.0	1.50	H	35.10	5.22	32.39	47.40	54.00	-6.60	avg
9.748	49.64	190.0	1.11	V	38.90	6.26	32.32	62.48	74.00	-11.52	pk
9.748	50.98	271.0	1.70	H	38.90	6.26	32.32	63.82	74.00	-10.18	avg
9.748	34.31	190.0	1.10	V	38.90	6.26	32.32	47.15	54.00	-6.85	pk
9.748	35.72	271.0	1.70	H	38.90	6.26	32.32	48.56	54.00	-5.44	avg

**Note:** Emission was scanned up to 25GHz; no emissions were detected above the noise floor which was at least 20dB below the specification limit

**802.11g @ 2462MHz @ 3 Meter**

Frequency (GHz)	Reading (dBuV/m)	Direction (degree)	Height (m)	Polarity (H/V)	Antenna Loss (dB)	Cable Loss (dB)	Amplifier (dB)	Corrected Reading (dBuV/m)	15.247/15.209 Limit @ 3m (dBuV/m)	Margin (dBuV/m)	Detector (pk/avg)
4.924	49.34	158.00	1.40	V	32.20	4.13	32.49	53.18	74.00	-20.82	pk
4.924	50.54	240.00	1.20	H	32.20	4.13	32.49	54.38	74.00	-19.62	avg
4.924	36.54	158.00	1.40	V	32.20	4.13	32.49	40.38	54.00	-13.62	pk
4.924	36.17	240.00	1.20	H	32.20	4.13	32.49	40.01	54.00	-13.99	avg
7.386	54.64	163.00	2.20	V	35.10	5.22	32.39	62.57	74.00	-11.43	pk
7.386	54.17	279.00	1.60	H	35.10	5.22	32.39	62.10	74.00	-11.90	avg
7.386	40.01	163.00	2.20	V	35.10	5.22	32.39	47.94	54.00	-6.06	pk
7.386	40.23	279.00	1.60	H	35.10	5.22	32.39	48.16	54.00	-5.84	avg
9.848	49.96	190.00	1.10	V	38.90	6.26	32.32	62.80	74.00	-11.20	pk
9.848	50.67	271.00	1.70	H	38.90	6.26	32.32	63.51	74.00	-10.49	avg
9.848	35.41	190.00	1.10	V	38.90	6.26	32.32	48.25	54.00	-5.75	pk
9.848	35.73	271.00	1.70	H	38.90	6.26	32.32	48.57	54.00	-5.43	avg
2.484	50.61	158.00	1.40	V	27.50	2.50	32.04	48.57	74.00	-25.43	pk
2.484	50.64	240.00	1.20	H	27.50	2.50	32.04	48.60	74.00	-25.40	avg
2.484	37.21	158.00	1.40	V	27.50	2.50	32.04	35.17	54.00	-18.83	pk
2.484	37.20	240.00	1.20	H	27.50	2.50	32.04	35.16	54.00	-14.89	avg

**Note:** Emission was scanned up to 25GHz; no emissions were detected above the noise floor which was at least 20dB below the specification limit

## 5.11 Receiver Spurious Emissions

1. Conducted Measurement  
EUT was set for low , mid, high channel with modulated mode and highest RF output power.  
The spectrum analyzer was connected to the antenna terminal.
2. Conducted Emissions Measurement Uncertainty  
All test measurements carried out are traceable to national standards. The uncertainty of the measurement at a confidence level of approximately 95% (in the case where distributions are normal), with a coverage factor of 2, in the range 30MHz – 40GHz is ±1.5dB.
3. Environmental Conditions
 

Temperature	23°C
Relative Humidity	50%
Atmospheric Pressure	1019mbar
4. Test Date : Nov 29th 2010 - Dec 17th 2010  
 Tested By :David Zhang

Standard Requirement: RSSGen(4.8)

**Procedures:** The conducted spurious emissions were measured conducted using a spectrum analyzer at mid channels. the search for spurious emissions shall be from the lowest frequency internally generated or used in the receiver (e.g. local oscillator, intermediate or carrier frequency), or 30 MHz, whichever is the higher, to at least 3 times the highest tuneable or local oscillator frequency, whichever is the higher, without exceeding 40 GHz. Receiver spurious emissions at any discrete frequency shall not exceed 2 nanowatts in the band 30-1000 MHz, or 5 nanowatts above 1 GHz.

**Test Result:** Pass

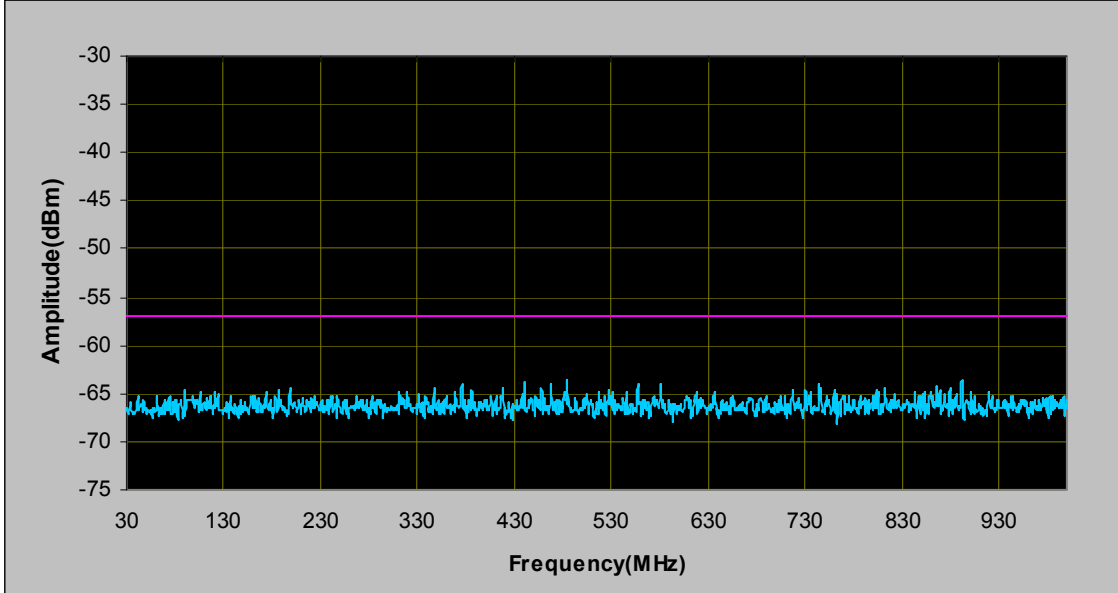

Receiver Spurious Emission Plot- 1

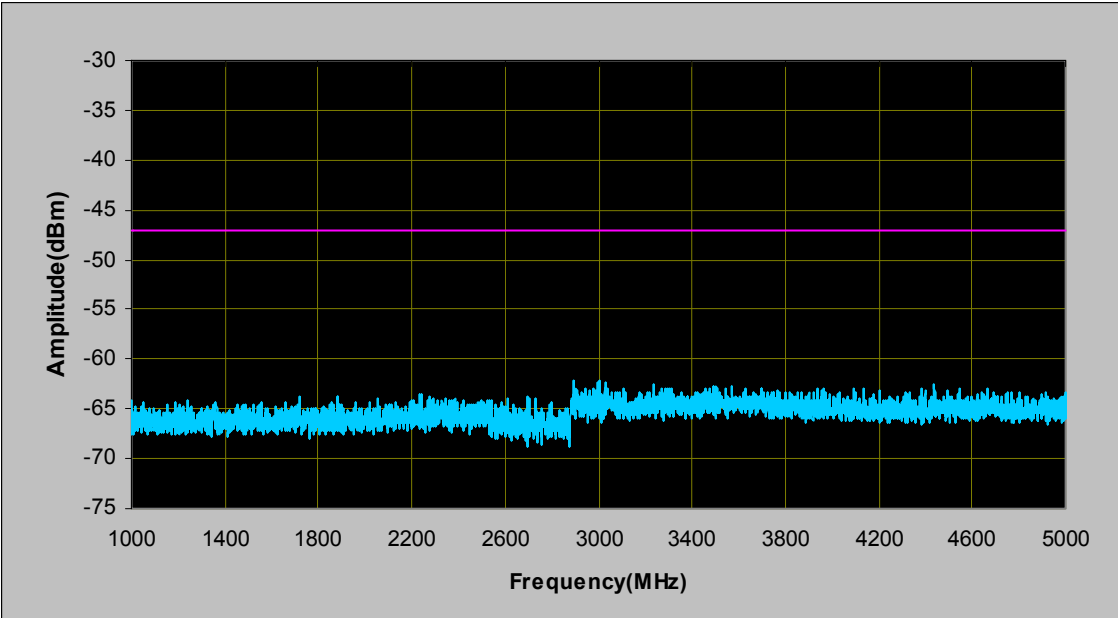

Receiver Spurious Emission Plot- 2

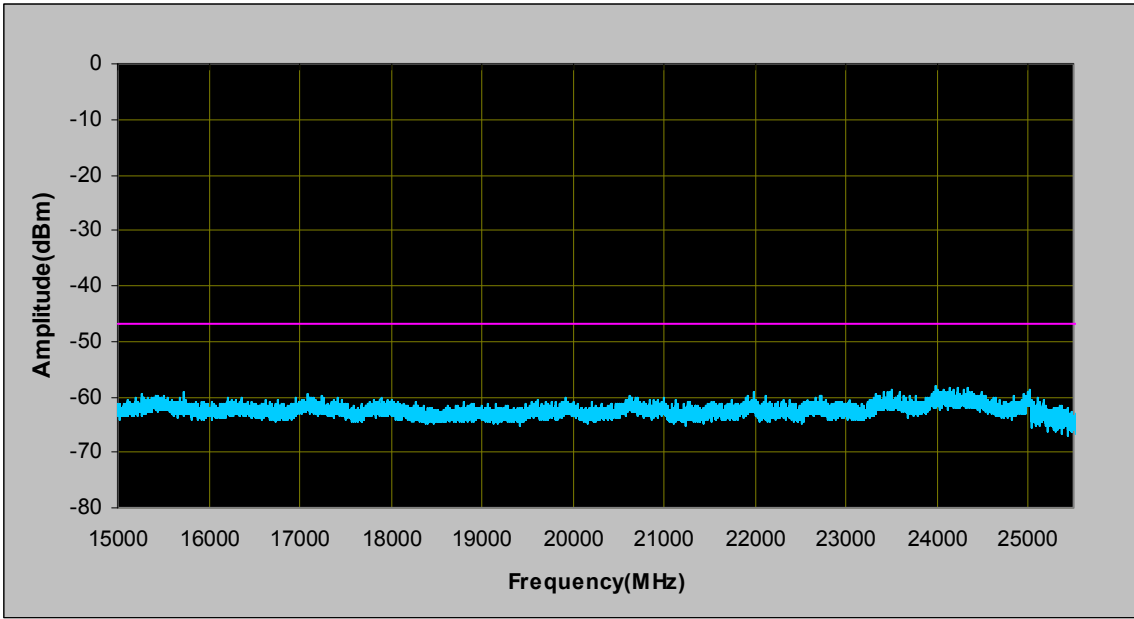

**Receiver Spurious Emission Plot- 3**

**Annex A. TEST INSTRUMENT & METHOD**

**Annex A.i. TEST INSTRUMENTATION & GENERAL PROCEDURES**

Instrument	Manufacturer	Model	CAL Due Date
3m Semi-Anechoic Chamber	ETS-Lingren	3M	10/13/2011
Spectrum Analyzer	HP	8564E	05/19/2011
EMI Receiver	Rohde & Schwarz	ESIB 40	05/19/2011
R&S LISN	R&S	ESH2-Z5	05/18/2011
CHASE LISN	Chase	MN2050B	05/18/2011
Antenna(1 ~18GHz)	Emco	3115	06/04/2012
Antenna (30MHz~2GHz)	Sunol Sciences	JB1	06/04/2012
Chamber	Lingren	3m	10/13/2011
Pre-Amplifier(1 ~ 26GHz)	HP	8449	05/17/2011
Horn Antenna (18~40GHz)	Com Power	AH-840	06/04/2012
Microwave Pre-Amp (18~40GHz)	Com Power	PA-840	Every 2000 hours
Sekonic Hygro Hermograph	ST-50	HE01-000092	06/04/2012

Note: No calibration required.



**Annex A.ii. CONDUCTED EMISSIONS TEST DESCRIPTION**

**Test Set-up**

1. The EUT and supporting equipment were set up in accordance with the requirements of the standard on top of a 1.5m x 1m x 0.8m high, non-metallic table, as shown in Annex B.
2. The power supply for the EUT was fed through a 50Ω/50μH EUT LISN, connected to filtered mains.
3. The RF OUT of the EUT LISN was connected to the EMI test receiver via a low-loss coaxial cable.
4. All other supporting equipments were powered separately from another main supply.

**Test Method**

1. The EUT was switched on and allowed to warm up to its normal operating condition.
2. A scan was made on the NEUTRAL line (for AC mains) or Earth line (for DC power) over the required frequency range using an EMI test receiver.
3. High peaks, relative to the limit line, were then selected.
4. The EMI test receiver was then tuned to the selected frequencies and the necessary measurements made with a receiver bandwidth setting of 10 KHz. For FCC tests, only Quasi-peak measurements were made; while for CISPR/EN tests, both Quasi-peak and Average measurements were made.
5. Steps 2 to 4 were then repeated for the LIVE line (for AC mains) or DC line (for DC power).

**Description of Conducted Emission Program**

This EMC Measurement software run LabView automation software and offers a common user interface for electromagnetic interference (EMI) measurements. This software is a modern and powerful tool for controlling and monitoring EMI test receivers and EMC test systems. It guarantees reliable collection, evaluation, and documentation of measurement results. Basically, this program will run a pre-scan measurement before it proceeds with the final measurement. The pre-scan routine will run the common scan range from 15 kHz to 30 MHz; the program will first start a peak and average scan on selectable measurement time and step size. After the program complete the pre-scan, this program will perform the Quasi Peak and Average measurement, based on the pre-scan peak data reduction result.

**Sample Calculation Example**

At 20 MHz	limit = 250 μV = 47.96 dBμV
Transducer factor of LISN, pulse limiter & cable loss at 20 MHz = 11.20 dB	
Q-P reading obtained directly from EMI Receiver = 40.00 dBμV (Calibrated for system losses)	
Therefore, Q-P margin = 47.96 – 40.00 = 7.96	i.e. <b>7.96 dB below limit</b>

**Annex A. iii RADIATED EMISSIONS TEST DESCRIPTION**

**EUT Characterisation**

EUT characterisation, over the frequency range from 30MHz to 10<sup>th</sup> Harmonic , was done in order to minimise radiated emissions testing time while still maintaining high confidence in the test results.

The EUT was placed in the chamber, at a height of about 0.8m on a turntable. Its radiated emissions frequency profile was observed, using a spectrum analyzer /receiver with the appropriate broadband antenna placed 3m away from the EUT. Radiated emissions from the EUT were maximised by rotating the turntable manually, changing the antenna polarisation and manipulating the EUT cables while observing the frequency profile on the spectrum analyzer / receiver. Frequency points at which maximum emissions occurred, clock frequencies and operating frequencies were then noted for the formal radiated emissions test at the Open Area Test Site (OATS).

**Test Set-up**

1. The EUT and supporting equipment were set up in accordance with the requirements of the standard on top of a 1.5m X 1.0m X 0.8m high, non-metallic table.
2. The filtered power supply for the EUT and supporting equipment were tapped from the appropriate power sockets located on the turntable.
3. The relevant broadband antenna was set at the required test distance away from the EUT and supporting equipment boundary.

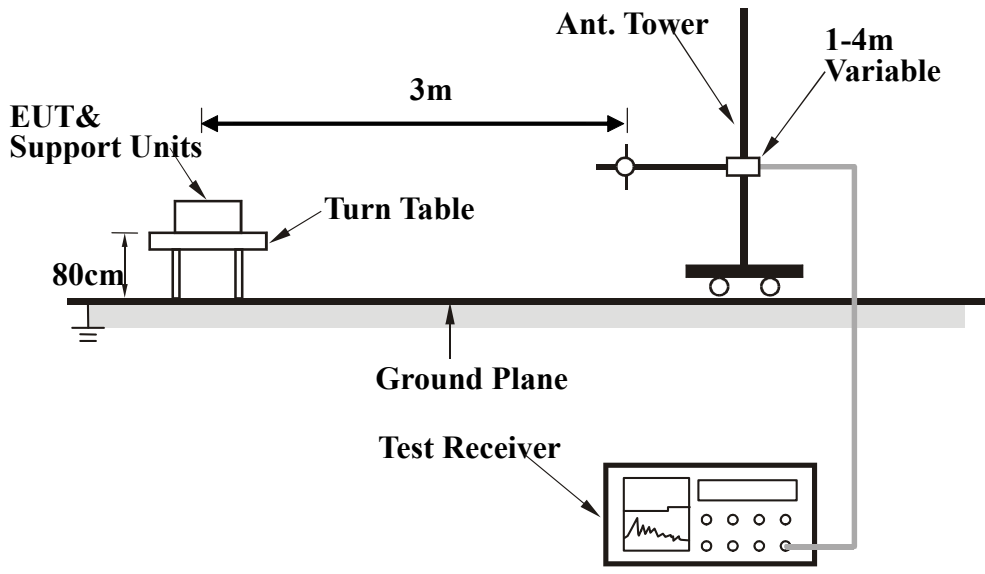

**Test Method**

The following procedure was performed to determine the maximum emission axis of EUT:

1. With the receiving antenna is H polarization, rotate the EUT in turns with three orthogonal axes to determine the axis of maximum emission.
2. With the receiving antenna is V polarization, rotate the EUT in turns with three orthogonal axes to determine the axis of maximum emission.
3. Compare the results derived from above two steps. So, the axis of maximum emission from EUT was determined and the configuration was used to perform the final measurement.

**Final Radiated Emission Measurement**

1. Setup the configuration according to figure 1. Turn on EUT and make sure that it is in normal function.
2. For emission frequencies measured below 1 GHz, a pre-scan is performed in a shielded chamber to determine the accurate frequencies of higher emissions will be checked on a open test site. As the same purpose, for emission frequencies measured above 1 GHz, a pre-scan also be performed with a 1 meter measuring distance before final test.
3. For emission frequencies measured below and above 1 GHz, set the spectrum analyzer on a 100 kHz and 1 MHz resolution bandwidth respectively for each frequency measured in step 2.
4. The search antenna is to be raised and lowered over a range from 1 to 4 meters in horizontally polarized orientation. Position the highness when the highest value is indicated on spectrum analyzer, then change the orientation of EUT on test table over a range from 0 ° to 360 ° with a speed as slow as possible, and keep the azimuth that highest emission is indicated on the spectrum analyzer. Vary the antenna position again and record the highest value as a final reading.
5. Repeat step 4 until all frequencies need to be measured were complete.
6. Repeat step 5 with search antenna in vertical polarized orientations.

During the radiated emission test, the Spectrum Analyzer was set with the following configurations:

Frequency Band (MHz)	Function	Resolution bandwidth	Video Bandwidth
30 to 1000	Peak	100 kHz	100 kHz
Above 1000	Peak	1 MHz	1 MHz
	Average	1 MHz	10 Hz

**Description of Radiated Emission Program**

This EMC Measurement software run LabView automation software and offers a common user interface for electromagnetic interference (EMI) measurements. This software is a modern and powerful tool for controlling and monitoring EMI test receivers and EMC test systems. It guarantees reliable collection, evaluation, and documentation of measurement results. Basically, this program will run a pre-scan measurement before it proceeds with the final measurement. The pre-scan routine will run the scan on four different antenna heights, 2 antenna polarity, and 360 degrees table rotation. For example, the program was set to run 30 MHz to 1 GHz scan; the program will first start from a meter antenna height and divide the 30 MHz to 1 GHz into 10 separate parts of maximum hold sweeps. Each parts of maximum hold sweep, the program will collect the data from 0 degree to 360 degrees table rotation. After the program complete the 1m scan, the antenna continues to rise to 2m and continue the scan. The step will repeated for all specified antenna height and polarity. This program will perform the Quasi Peak measurement after the signal maximization process and pre-scan routine. The final measurement will be base on the pre-scan data reduction result.

**Sample Calculation Example**

The field strength is calculated by adding the Antenna Factor and Cable Factor, and subtracting the Amplifier Gain (if any) from the measured reading. For the limit is employed average value, therefore the peak value can be transferred to average value by subtracting the duty factor. The basic equation with a sample calculation is as follows:

$$\text{Peak} = \text{Reading} + \text{Corrected Factor}$$

where

Corr. Factor = Antenna Factor + Cable Factor - Amplifier Gain (if any)

And the average value is

$$\text{Average} = \text{Peak Value} + \text{Duty Factor or}$$

$$\text{Set RBW} = 1\text{MHz, VBW} = 10\text{Hz.}$$

Note :

If the measured frequencies are fall in the restricted frequency band, the limit employed must be quasi peak value when frequencies are below or equal to 1 GHz. And the measuring instrument is set to quasi peak detector function.

**Annex B EUT PHOTOGRAPHS**

**Annex B. i Photograph 1: EUT External Photo**

See exhibit

**Annex B. ii      Photograph 2: EUT Internal Photo**

**See exhibit**

**Annex B.iv. Photograph 3: Test Setup Photo**

**See exhibit**

**Annex C. TEST SETUP AND SUPPORTING EQUIPMENT**

**EUT TEST CONDITIONS**

**Annex C. i. SUPPORTING EQUIPMENT DESCRIPTION**

The following is a description of supporting equipment and details of cables used with the EUT.

Equipment Description (Including Brand Name)	Model & Serial Number	Cable Description (List Length, Type & Purpose)
Dell / Laptop	D600	USB Cable, 1 meter; Serial Cable 1m



### Block Configuration Diagram for Radiated Emission

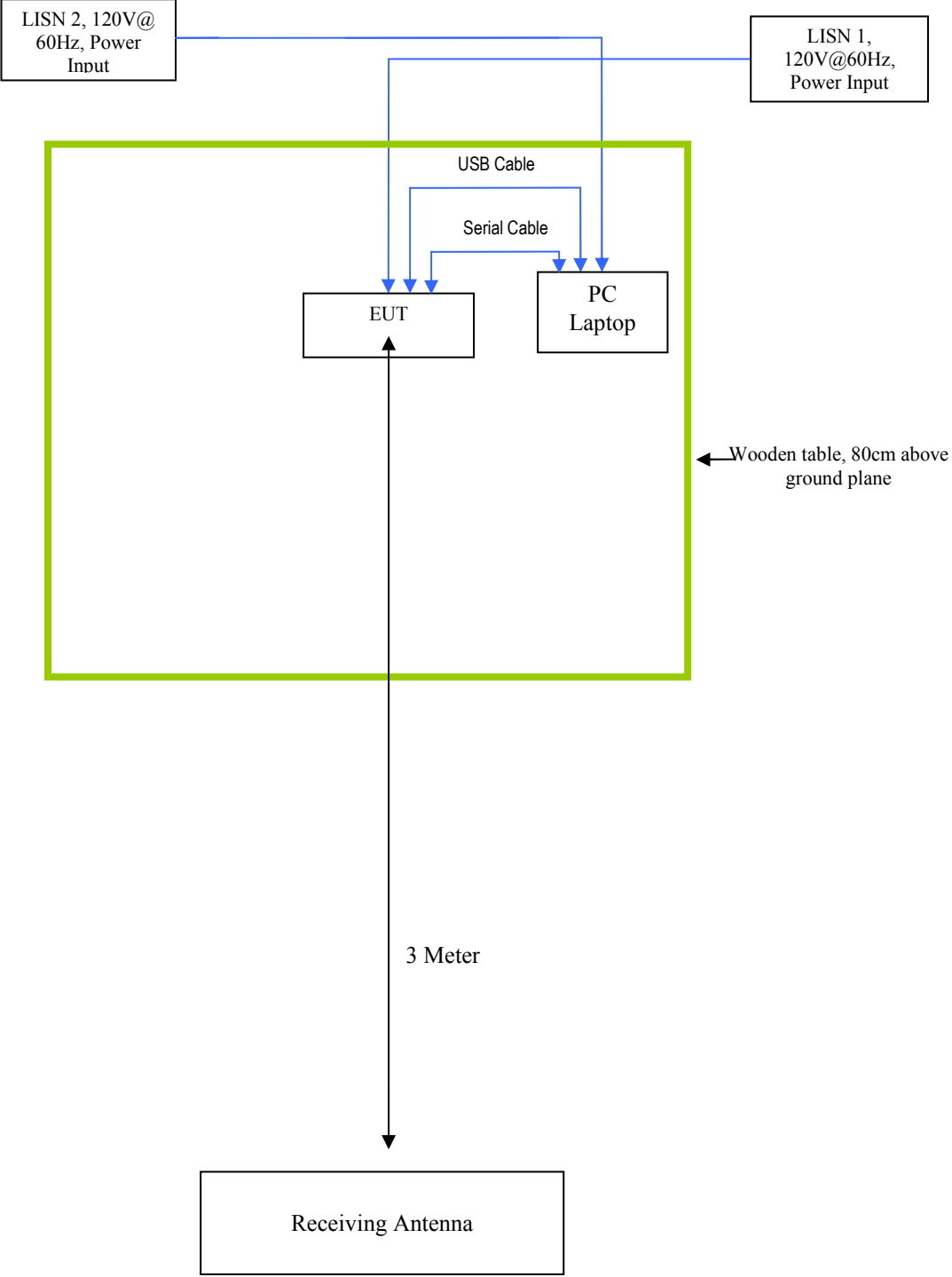

### Block Configuration Diagram for Conducted Emission

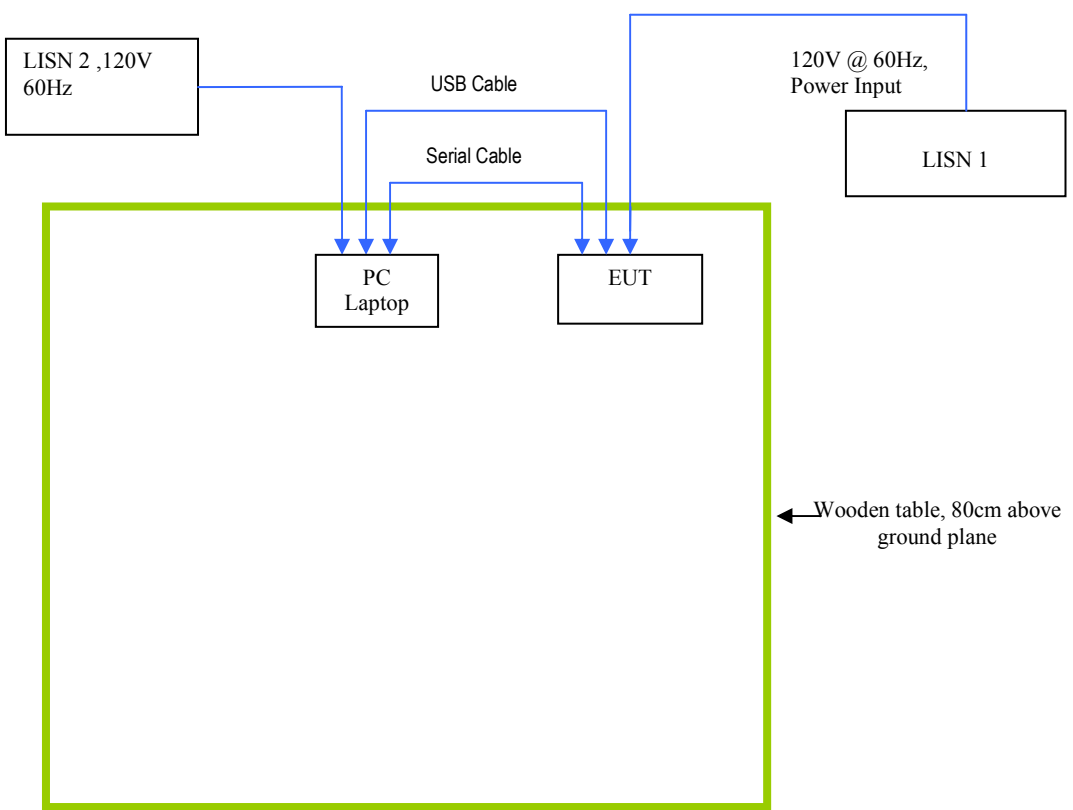

**Annex C.ii. EUT OPERATING CONDITIONS**

The following is the description of how the EUT is exercised during testing.

Test	Description Of Operation
<b>Emissions Testing</b>	The EUT was controlled by itself Using manufacturer's program.
<b>Others Testing</b>	TX mode is normal mode with full power.

## **Annex D USER MANUAL, BLOCK & CIRCUIT DIAGRAM**

**Please see attachment**

**Annex E SIEMIC ACCREDITATION**

**SIEMIC ACCREDITATION DETAILS: A2LA 17025 & ISO Guide 65 : 2742.01 , 2742.2**

  **The American Association for Laboratory Accreditation**  
World Class Accreditation

*Accredited Laboratory*

A2LA has accredited

**SIEMIC LABORATORIES**  
*San Jose, CA*  
for technical competence in the field of  
**Electrical Testing**

This laboratory is accredited in accordance with the recognized International Standard ISO/IEC 17025:2005 *General Requirements for the Competence of Testing and Calibration Laboratories*. This accreditation demonstrates technical competence for a defined scope and the operation of a laboratory quality management system (refer to joint ISO-ILAC-LAF Communiqué dated 8 January 2009).

Presented this 23rd day of November 2010.

   
President & CEO  
For the Accreditation Council  
Certificate Number 2742.01  
Valid to September 30, 2012

*For the tests or types of tests to which this accreditation applies, please refer to the laboratory's Electrical Scope of Accreditation.*



**The American Association for Laboratory Accreditation**

SCOPE OF ACCREDITATION TO ISO/IEC 17025:2005

**SIEMIC LABORATORIES<sup>1</sup>**

2206 Ringwood Ave.  
San Jose, CA 95131

Mr. Leslie Bai Phone: 408 526 1188 Email: leslie.bai@siemic.com  
Mr. Snell Leong Phone: 408 526 1188 Email: snell.leong@siemic.com  
www.siemic.com

**ELECTRICAL**

Valid to: September 30, 2012

Certificate Number: 2742.01

In recognition of the successful completion of the A2LA evaluation process, accreditation is granted to this laboratory to perform the following EMC, Product Safety, Radio and Telecommunication tests:

<b>Test Description:</b>	<b>Test Method:</b>
EN & IEC – Emissions & Immunity	IEC/CISPR 11; IEC/CISPR 12; EN 55011; IEC/CISPR 22; EN 55022; IEC/CISPR 20; EN 55020; EN 61000-6-1; EN 61000-6-2; EN 61000-6-3; EN 61000-6-4; EN 61204-3; EN 61326, EN 61326-1; EN 61000-3-2; EN 61000-3-3; EN 50081-1, EN 50081-2; EN 50082-1; IEC 61000-4-2; EN 61000-4-2; IEC 61000-4-3 (limited up to 2.7 GHz and 3V/m); EN 61000-4-3; (limited up to 2.7 GHz and 3V/m); IEC 61000-4-4; EN 61000-4-4; IEC 61000-4-5; EN 61000-4-5; IEC 61000-4-6; EN 61000-4-6; IEC 61000-4-8; EN 61000-4-8; IEC 61000-4-11; EN 61000-4-11; IEC/CISPR 24; EN 55024; EN 50412-2-1; EN 50083-2; EN 50090-2-2; EN 50091-2; EN 50130-4; EN 50130-4 +A12; IEC 60601-1-2; EN 12184; EN 55015; EN 61547; CISPR 16-1-4
Korea – Emissions & Immunity	KCC Notice 2009-27, Nov. 5, 2009; RRA Announce 2009-9, Dec. 21, 2009; KN 22:2007-12; KCC Notice 2009-27, Nov. 5, 2009; RRA Notice 2009-10, Dec. 21, 2009; KN 24:2008-5; KN 61000-4-2:2008-5; KN 61000-4-3:2008-5; KN 61000-4-4:2008-5; KN 61000-4-5:2008-5; KN 61000-4-6:2008-5; KN 61000-4-8:2008-5; KN 61000-4-11:2008-5; RRL Notice 2008-3; RRL Notice 2008-4; RRL Notice 2005-131; RRL Notice 2007-99; RRL Notice 2007-101; RRL Notice 2008-4; RRA Notice No 2008-11(2008.12.16); RRA Notice No 2008-12(2008.12.16); KN 60601-1-2; KCC Notice 2009-27; KN 301 489-1(2008-05); KN 301 489-7(2008-05); KN 301 489-17(2008-05); KN 301 489-24(2008-05); KN 16-1-1(2008-05); KN 16-1-2(2008-05); KN 16-1-3(2008-05); KN 16-1-4(2008-05); KN 16-1-5(2008-05); KN 16-2-1(2008-05); KN 16-2-2(2008-05); KN 16-2-3(2008-05); KN 16-2-4(2008-05)

(A2LA Certificate No. 2742.01) 11/23/2010

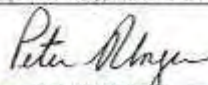

Page 1 of 7





FCC – Emissions	ANSI C63.17:2006; ANSI C63.4(2003) with FCC Method 47 CFR Part 11; ANSI C63.4(2003) with FCC Method 47 CFR Part 15, Subpart E; ANSI C63.4(2003) with FCC Method 47 CFR Part 15, Subpart C; ANSI C63.4(2003) and DA 02-2138; ANSI C63.4(2003) with FCC Method 47 CFR Part 15, Subpart B; ANSI C63.4(2009); ANSI C63.10(2009); FCC Method 47 CFR Part 18, FCC OST/MP-5(1986); FCC Report and Order ET Docket 98-153 (FCC 02-48); FCC Method 47 CFR Part 15, Subpart G, using FCC Order 04-425; FCC Method 47 CFR Parts 11 (Emergency Alert System (EAS)), 15 (Radio Frequency Devices) and 18 (Industrial, Scientific, and Medical Equipment); SAE J1113-11, SAE J1113-12; SAE J1113-41; SAE J1113-4; SAE J1113-13
Canada – Emissions	ICES-001; ICES-002; ICES-003 Issue 4; ICES-003 Issue 4 (2004); ICES-006 Issue 1
Vietnam – Emission & Immunity	TCN 68-193:2003; TCN 68-196:2001; TCVN 7189:2002
Australia / New Zealand – Emissions and Immunity	AS/NZS 1044; AS/NZS 4251.1; AS/NZS 4251.2; AS/NZS CISPR 22; AS/NZS 3548; AS/NZS 2279.3; AS/NZS 61000-3-3; AS/NZS CISPR 11; AS/NZS CISPR 24; AS/NZS 61000.6.3; AS/NZS 61000.6.4; AS/NZS CISPR 14.1; AS/NZS 61000.3.2
Japan – Emissions	JEITA IT-3001; VCCI-V-3:2010.4 (up to 6 GHz)
China – Emissions	GB9254; GB17625.1
Taiwan – Emissions	CNS 13438 (up to 6 GHz); CNS 13783-1; CNS 13803; CNS 13439
Singapore – Emissions & Immunity	IDA TS EMC; CISPR 22; IEC 61000-4-2; IEC 61000-4-3; IEC 61000-4-4; IEC 61000-4-5; IEC 61000-4-6
FCC – Radio TIA/EIA 603-C with 47 CFR Part 2	Maritime and Aviation Radio Services in 47 CFR Parts 80 and 87; Personal Mobile Radio Services in 47 CFR Parts 22 (cellular), 24, 25, 26, and 27; Personal Mobile Radio Services in 47 CFR Part 22 (cellular) and Part 24 – [limited to TX conducted and radiated power and RX - TX radiated spurious emissions]; General Mobile Radio Services in 47 CFR Parts 22 (non-cellular), 74, 90, 95, and 97; General Mobile Radio Services in 47 CFR Part 90; Microwave Radio Services in 47 CFR Parts 21, 27, 74, and 101
Canada – Radio	RSS 102; RSS 111; RSS 112; RSS 117; RSS 118; RSS 119; RSS 123; RSS 125; RSS 127; RSS 128; RSS 129; RSS 131; RSS 132; RSS 133; RSS 134; RSS 135; RSS 136; RSS 137; RSS 138; RSS 139; RSS 141; RSS 142; RSS 170; RSS 181; RSS 182; RSS 188; RSS 191; RSS 192; RSS 193; RSS 194; RSS 195; RSS 196; RSS 197; RSS 198; RSS 199; RSS 210; RSS 220; RSS 213; RSS 215; RSS 243; RSS 287; RSS 310; RSS Gen



CE – Radio	<p>EN 301 502; EN 301 511; EN 301 526; EN 301 681; EN 301 721;  EN 301 751; EN 301 753; EN 301 783-2; EN 301 796; EN 301 797;  EN 301 840-2; EN 301 843-1; EN 301 843-4; EN 301 843-5;  EN 301 893; EN 301 908-01; EN 301 908-02; EN 301 908-03;  EN 301 908-04; EN 301 908-05; EN 301 908-06; EN 301 908-07;  EN 301 908-08; EN 301 908-09; EN 301 908-10; EN 301 908-11;  EN 301 929-2; EN 301 997-2; EN 302 018-2; EN 302 054-2;  EN 302 064-2; EN 302 066-2; EN 302 077-2; EN 302 186; EN 302 195-2;  EN 302 217-3; EN 302 245-2; EN 302 288-2; EN 302 291-2; EN 302 296;  EN 302 297; EN 302 326-2; EN 302 326-3; EN 302 340; EN 302 372-2;  EN 302 426; EN 302 454-2; EN 302 502; EN 302 510-2;  EN 302 217-4-2; EN 300 224-1; EN 300 279; EN 300 339; EN 300 385;  EN 301 839-2; EN 301 843-6; EN 302 017-2; EN 302 208-2;  EN 302 217-2-2; ETS 300 329; ETS 300 445; ETS 300 446; ETS 300 683;  ETS 300 826; ETS EN 300 328; ETSI EN 300 086-2; EN 302217-1;  EN 302217-2-1; EN 302217-4-1; EN 302288-1; EN 302908-12;  EN 302326-1; EN 301929-1; EN 301997-1; EN 300224-2; EN 301839-1;  EN 301843-1; EN 301843-2; EN 301843-3; EN 301843-4; EN 301843-5;  EN 302017-1; EN 302208-1; EN 300086-1; EN 300113-1; EN 300224-1;  EN 300341-1; EN 302291-1; EN 302500-1; EN 302500-2;  ETSI EN 300 113-2; ETSI EN 300 197; ETSI EN 300 198;  ETSI EN 300 219-1; ETSI EN 300 219-2;  ETSI EN 300 220-1; ETSI EN 300 220-2; ETSI EN 300 220-3;  ETSI EN 300 224-2; ETSI EN 300 296-1; ETSI EN 300 296-2;  ETSI EN 300 328-1; ETSI EN 300 328-2;  ETSI EN 300 330; ETSI EN 300 330-1; ETSI EN 300 330-2;  ETSI EN 300 341-2; ETSI EN 300 373-1; ETSI EN 300 373-2;  ETSI EN 300 373-3; ETSI EN 300 390-1; ETSI EN 300 390-2;  ETSI EN 300 422-1; ETSI EN 300 422-2; ETSI EN 300 431;  ETSI EN 300 440-1; ETSI EN 300 440-2; ETSI EN 300 454-1;  ETSI EN 300 454-2; ETSI EN 300 718-2; ETSI EN 301 021;  ETSI EN 301 166-1; ETSI EN 301 166-2; ETSI EN 301 178-2;  ETSI EN 301 213-1; ETSI EN 301 213-2; ETSI EN 301 213-3;  ETSI EN 301 213-4; ETSI EN 301 213-5; ETSI EN 301 357-1;  ETSI EN 301 357-2; ETSI EN 301 390; ETSI EN 301 459;  ETSI EN 301 489-01(excluding section 9.6); ETSI EN 301 489-02;  ETSI EN 301 489-03; ETSI EN 301 489-04; ETSI EN 301 489-05;  ETSI EN 301 489-06; ETSI EN 301 489-07; ETSI EN 301 489-08;  ETSI EN 301 489-09; ETSI EN 301 489-10; ETSI EN 301 489-11;  ETSI EN 301 489-12; ETSI EN 301 489-13; ETSI EN 301 489-14;  ETSI EN 301 489-15; ETSI EN 301 489-16; ETSI EN 301 489-17;  ETSI EN 301 489-18; ETSI EN 301 489-19; ETSI EN 301 489-20;  ETSI EN 301 489-22; ETSI EN 301 489-23; ETSI EN 301 489-24;  ETSI EN 301 489-25; ETSI EN 301 489-26; ETSI EN 301 489-27;  ETSI EN 301 489-28; ETSI EN 301 489-31; ETSI EN 301 489-32;  IEC 60945</p>
IDA – Radio	<p>IDA TS 3G-BS; IDA TS 3G-MT; IDA TS AR; IDA TS CT-CTS;  IDA TS GMPCS; IDA TS GSM-BS; IDA TS GSM-MT; IDA TS LMR;  IDA TS RPG; IDA TS SRD; IDA TS UWB; IDA TS WBA</p>
Vietnam – Radio	<p>TCN 68-242:2006; TCN 68-243:2006; TCN 68-246:2006</p>





Korea – Radio	KCC Notice 2009-13; KCC Notice 2008-26; RRL Notice 2008-2; RRL Notice 2005-105; RRL Notice 2008-17; RRL Notice 2005-127; RRL Notice 2005-24; RRL Notice 2005-25; RRL Notice 2005-179; RRL Notice 2008-10; RRL Notice 2007-49; RRL Notice 2007-20; RRL Notice 2007-11; RRL Notice 2007-80; RRL Notice 2004-68; KCC Notice 2009-36, Dec. 8, 2009; RRL Notice 2009-6, October 15, 2009; KCC Notice 2010-1; KCC Notice 2010-12; KCC Notice 2010-13.
Taiwan – Radio	LP0002; PLMN07; PLMN01; PLMN08
Australia - New Zealand – Radio	AS 2772.2; AS/NZS 4281; AS/NZS 4268; AS/NZS 4280.1; AS/NZS 4583; AS/NZS 4280.2; AS/NZS 4281; AS/NZS 4295; AS/NZS 4582; AS/NZS 4769.1; AS/NZS 4769.2; AS/NZS 4770; AS/NZS 4771
Hong Kong – Radio	HKTA 1002; HKTA 1007; HKTA 1008; HKTA 1010; HKTA 1015; HKTA 1016; HKTA 1020; HKTA 1022; HKTA 1026; HKTA 1027; HKTA 1029; HKTA 1030; HKTA 1031; HKTA 1032; HKTA 1033; HKTA 1034; HKTA 1035; HKTA 1036; HKTA 1037; HKTA 1039; HKTA 1041; HKTA 1042; HKTA 1043; HKTA 1044; HKTA 1046; HKTA 1047; HKTA 1048; HKTA 1049; HKTA 1051; HKTA1052; HKTA1053; HKTA 1054; HKTA 1055
USA – Telecom	ANSI/TIA-968-A-03; ANSI/TIA-968-A-1:03; ANSI/TIA-968-A-2:04; ANSI/TIA-968-A-3:05; ANSI/TIA-968-A-4:07; ANSI/TIA-968-A-5:07; TIA-968-B; FCC Rule Part 68; 47 CFR Part 68.316; 47 CFR Part 68.317; ANSI/TIA/EIA-464-C; TIA-810-B; T1.TRQ6 (2002); TCB-31-B (1998); TIA-470.110-C; TIA-810-B, TIA-920
Canada – Telecom	CS-03 Part V Issue 9:2009 Amendment 1; CS-03 Part VIII Issue 9:2009 Amendment 4; CS-03 Part I Issue 9:2006 Amendment 3; CS-03 Part II Issue 9:2004; CS-03 Part III Issue 9:2004; CS-03 Part V Issue 9:2004; CS-03 Part VI Issue 9:2004; CS-03 Part VII Issue 9:2006 Amendment 3; CS-03 Part VIII Issue 9:2007 Amendment 3; CS-03 Issue 9:04 + A2(06) + A3(06)
Europe – Telecom	TBR 2: 01-1997; TBR 004 Ed.1.95 + A1 (97); TBR 1; TBR 3; TBR 12:A1 01-1996; TBR 013 ed.1; TBR 024 ed.1; TBR 25; TBR 38 ed.1; ETSI ES 203 021-05 ; ETSI ES 203 021-2 ; ETSI ES 021-3; TBR 021; ETSI EG 201 121; ETSI EN 301 437; ETSI TS 101 270-1; ITU-T Recommendation Q.920; ITU-T Recommendation Q.920 – Amendment 1; ITU-T Recommendation Q.921; ITU-T Recommendation Q.921 – Amendment 1; ITU-T Recommendation Q.931; ITU-T Recommendation Q.931 – Amendment 1; Erratum 1 (02/2003) ITU-T Recommendation Q.931 (05/1998); ISDN User Network Interface Layer 3 Specification for Basic Call Control; ITU-T Recommendation P.300
Australia – Telecom	AS/CA S003.1:2010; AS/CA S003.2:2010; AS/CA S003.3:2010; AS/CA S004:2010; AS/ACIF S006:2008; AS/ACIF S041.1:2009

*Peter Mlyns*



Australia – Telecom	AS/ACIF S041.2:2009; AS/ACIF S041.3:2009; AS/ACIF S042.1:2008; AS/ACIF S043.2:2008; AS/ACIF S043.3:2008; AS/ACIF S002:05; AS/ACIF S003:06; AS/ACIF S004:06; AS/ACIF S006:01; AS/ACIF S016:01; AS/ACIF S031:01; AS/ACIF S038:01; AS/ACIF S040:01; AS/ACIF S041:05; AS/ACIF S043.2:06; AS ACIF S042.1
New Zealand – Telecom	PTC200:2006; PTC200 Issue No.2:97 + A1(980); PTC220; PTC273:2007; TNA 115; TNA 117
Singapore – Telecom	IDA TS ADSL, Issue 1, Rev. 1 (April 2006); IDA TS DLCN, Issue 1 (July 2005); IDA TS ISDN BA, Issue 1 (July 2005); IDA TS ISDN PRA, Issue 1 (July 2005); IDA TS ISDN 3 (Oct. 2000); IDA TS-PSTN, Issue 1 (March 2007); IDA TS ACLIP 07
Hong Kong – Telecom	HKTA 2011; HKTA 2012; HKTA 2013; HKTA 2014; HKTA 2017; HKTA 2018; HKTA 2022; HKTA 2024; HKTA 2026; HKTA 2027; HKTA 2028; HKTA 2029; HKTA 2030; HKTA 2031; HKTA 2032; HKTA 2033
Vietnam – Telecom	TCN 68-188:2000; TCN 68-193:2003; TCN 68-196:2001; TCN 68-143:2003; TCN 68-192:2003; TCN 68-189:2000; TCN 68-221:2004; TCN 68-222:2004; TCN 68-245:2004; TCN 68-223:2004
Korea – Telecom	RRA Notice 2009-38, Sep. 11, 2009; RRA Notice 2009-7 (including attachments 1, 3, 5, 6); Presidential Decree 21098, RRL Notice 2007-30; RRL Notice 2008-10 (attachments 1, 3, 5, 6); RRL Notice 2009-25; RRL Notice 2008-59
China – Telecom	YD/T 514-1:98; YD/T 1277.1-2003; GB/T 17904.1-1999; GB/T 17904.2-1999; GB/T 17154.1-1997; GB/T 17154.2-1997; YD/T1091-2000; YD/T1006-1999; GB/T 17789-1999
Taiwan – Telecom	PSTN01:03; ADSL01:08; ID0002; IS6100: 93
Japan – Telecom	JATE Blue Book, Green Book; Ministerial Ordinance of the Ministry of Posts and Telecommunications No. 31 of April 1, 1985 (last amended on March 22 2004); Ordinance Concerning Technical Conditions Compliance Approval etc. of Terminal Equipment
South Africa – Telecom	DPT-TE-001; TE-002; TE-003; TE-004; TE-005; TE-006; TE-007; TE-008; TE-009; TE-010; TE-012 (telephone interface); TE-013 (telephone interface); TE-014; TE-015; TE-018; SWS-001; SWS-002; SWS-003; SWS-004; SWS-005; SWS-006; SWS-007; SWS-008; SWS-009; SWS-010
Israel – Telecom	Israel MoC Spe. 23/96



Mexico – Telecom	NOM-151-SCTI-1999, NOM-152-SCTI-1999
Argentina – Telecom	CNC-ST2-44-01
Brazil – Telecom	Resolution 392-2005
International Telecom Union	ITU-T-G.703.01; ITU-T-G.823-93; ITU-T G.824; ITU-T G.825; ITU-T-G.991.2; ITU-T-G.992.1; ITU-T-G.992.3; ITU-T-G.992.5; ITU-T-G.993.1
Product Safety	IEC 60950-1; EN 60950-1; UL 60950-1; IEC 60601-1-1; CAN/CSA 22.2 NO. 60950-1-03; SS-EN 60950-1; AS/NZ 60950-1; (voltage surge testing up to 6kV, excluding Annex A and H); CNS 14336, CNS 14408; GB4943; President Notice 20664; RRL Notice 2008-10 (attachment 4); RRA Notice 2009-7 (attachment 4); TCN 68-190:2003; SABS IEC 60950; IEC/EN 61558; IEC/EN 61558-2-7; EN 62115; IEC 60215; EN 60958; EN 60598; IEC 215 (1987) + A1 (1992) + A2 (1994)
Japan - Radio	ARIB STD-T81; ARIB STD-T66; RCR STD-1; RCR STD-29; ARIB STD-T94 Fascicle 1; ARIB STD-T90; ARIB STD-T89; RCR STD-33
SAR & HAC	IEEE P1528:2003 + Ad1; IEEE 1528A:2005; FCC OET Bulletin 65 Supplement C; FCC OET Bulletin 65; ANSI C95; ANSI C63.19; FCC 47 CFR 20.19; H46-2/99-273E; EN 50360; EN 50361; IEC62209-1; IEC 62209-2; EN 50371; EN 50383; EN 50357; EN 50364; RRL 2008-18; RRL 2008-16; KCC 2009-27; RRL 2004-67; CNS 14959; NZS 2772.1; NZS 6609.2; Resolution N 533
Japan – Notification No. 88 of MIC 2004	
Table No 13	CB Radio
Table No 21	Cordless Telephone
Table Nos 22-1 thru 22-17	Low Power Radio Equipment
Table No 36	Low Power Security System
Table No 43	Low Power Data Communication in the 2.4 GHz Band
Table No 44	Low Power Data Communication in the 2.4 GHz Band
Table No 45	Low Power Data Communication in the 5.2, 5.3, 5.6 GHz Bands
Table No 46	Low Power Data Communication in the 25 and 27 GHz Bands
Table No 47	Base Station for 5 GHz Band Wireless Access System
Table No 47	Base Station for 5 GHz Band Wireless Access System (low spurious type)
Table No 47	Land Mobile Relay for 5 GHz Band Wireless Access System (limited for use in special zones)





Table No 47	Land Mobile Relay for 5 GHz Band Wireless Access System (limited for use in special zones, low spurious type)
Table No 47	Land Mobile Relay for 5 GHz Band Wireless Access System
Table No 47	Land Mobile Relay for 5 GHz Band Wireless Access System (low spurious type)
Table No 47	Land Mobile Relay for 5 GHz Band Wireless Access System (low power type)
Table No 50	Digital Cordless Telephone
Table No 50	PHS Base Station
Table No 50	PHS Land Mobile Station
Table No 50	PHS Relay Station
Table No 50	PHS Test Station
Table No 64	Mobile Station for Dedicated Short Range Communication Systems
Table No 64	Base Station for Dedicated Short Range Communication Systems
Table No 64	Test Station for Dedicated Short Range Communication Systems
Table No 70	UWB (Ultra Wide Band) Radio System

<sup>1</sup>Note: This accreditation covers testing performed at the laboratory listed above and the OATS located at 44366 South Grimmer Blvd., Fremont CA 94538. At this site "Radiated Emissions" are tested at a measurement distance of 10m.

\*Limitations for listed standards are indicated by italics and Scope excludes protocol sections of applicable standards.



**SIEMIC, INC.**  
Accessing global markets

Title: RF Test Report P4T with Zcomax 802.11b/g radio module+RFID  
Model : P4T  
To : FCC 15.247:2010,RSS-210 Issue 8:2010

Serial# SL10082306-ZBR-063A1\_FCC.IC(DTS)  
Issue Date Dec 17th 2010  
Page 69 of 86  
www.siemic.com



The American Association for Laboratory Accreditation

World Class Accreditation

## Accredited Product Certification Body

A2LA has accredited

### SIEMIC LABORATORIES

San Jose, CA

for technical competence as a

#### Product Certification Body

This product certification body is accredited in accordance with the recognized International Standard ISO/IEC Guide 65:1996 *General requirements for bodies operating product certification systems*. This accreditation demonstrates technical competence for a defined scope and the operation of a quality management system for a Telecommunications Certification Body (TCB) meeting FCC (U.S.), IDA (Singapore), IC (Canada) and OFTA Hong Kong requirements.



Presented this 23rd day of November 2010.

*Peter Noyes*

President & CEO  
For the Accreditation Council  
Certificate Number 2742.01  
Valid to September 30, 2012

*For the product certification schemes to which this accreditation applies, please refer to the organization's Product Certification Scope of Accreditation.*



**The American Association for Laboratory Accreditation**

**SCOPE OF ACCREDITATION TO ISO/IEC GUIDE 65:1996**

SIEMIC INC.  
2206 Ringwood Ave.  
San Jose, CA 95131  
Mr. Snell Leong (Authorized Representative) Phone: 408 526 1188  
[www.siemic.com](http://www.siemic.com)

**PRODUCT CERTIFICATION CONFORMITY ASSESSMENT BODY (CAB)**

Valid to: September 30, 2012

Certificate Number: 2742.02

In recognition of the successful completion of the A2LA Certification Body Accreditation Program evaluation, including the US Federal Communications Commission (FCC), Industry Canada (IC), Singapore (IDA) and Hong Kong (OFTA) requirements for the indicated types of product certifications, accreditation is granted to this organization to perform the following product certification schemes:

**Economy** **Scope**

**Federal Communication Commission - (FCC)**

Unlicensed Radio Frequency Devices	A1, A2, A3, A4
Licensed Radio Frequency Devices	B1, B2, B3, B4
Telephone Terminal Equipment	C

\*Please refer to FCC TCB Program Roles and Responsibilities, released July 22, 2010 detailing scopes, roles and responsibilities. <http://fallfoss.fcc.gov/oetcf/kdb/forms/FTSSearchResultPage.cfm?id=44683&switch=P>

**Industry Canada - (IC)**

Radio	Scope 1-Licence-Exempt Radio Frequency Devices; Scope 2-Licensed Personal Mobile Radio Services; Scope 3-Licensed General Mobile & Fixed Radio Services; Scope 4-Licensed Maritime & Aviation Radio Services; Scope 5-Licensed Fixed Microwave Radio Services;
-------	--

\*Please refer to Industry Canada (IC) website at: <http://www.ic.gc.ca/etic/site/smt-gst.usf/eng/sf09888.html>

**IDA – Singapore**

Line Terminal Equipment	All Technical Specifications for Line Terminal Equipment – Table 1 of IDA MRA Recognition Scheme: 2009, Annex 2
-------------------------	---

Radio-Communication Equipment	All Technical Specifications for Radio-Communication Equipment – Table 2 of IDA MRA Recognition Scheme: 2009, Annex 2
-------------------------------	---

\*Please refer to Info-Communication Development Authority (IDA) Singapore website at: [http://www.ida.gov.sg/doc/Policies%20and%20Regulation/Policies\\_and\\_Regulation\\_Level2:20060609145118/MRARecScheme.pdf](http://www.ida.gov.sg/doc/Policies%20and%20Regulation/Policies_and_Regulation_Level2:20060609145118/MRARecScheme.pdf)

(A2LA Cert. No. 2742.02) 11/23/2010

*Peter Noye* Page 1 of 2



**OFTA – Hong Kong**

Radio Equipment HKTA 1001, 1002, 1003, 1004, 1005, 1006, 1007, 1008,  
1009, 1010, 1015, 1016, 1019, 1020, 1022, 1026, 1027,  
1029, 1030, 1031, 1032, 1033, 1034, 1035, 1036, 1037,  
1038, 1039, 1041, 1042, 1043, 1044, 1045, 1046, 1047,  
1048, 1049, 1050, 1051, 1052, 1053, 1054, 1055

*\*Please refer to the Office of the Telecommunications Authority's website at:  
<http://www.ofta.gov.hk/en/standards/HKTASpec:hkta-1bxx.html>*

Fixed Network Equipment HKTA 2001, 2005, 2011, 2012, 2013, 2014, 2015, 2016,  
2017, 2018, 2019, 2020, 2021, 2022, 2023, 2024, 2025,  
2026, 2027, 2028, 2029, 2030, 2031, 2032, 2033, 2034,  
2035, 2036, 2037, 2040, 2041, 2102, 2103,  
2104, 2108, 2201, 2202, 2203, 2204

*\*Please refer to the Office of the Telecommunications Authority's website at:  
<http://www.ofta.gov.hk/en/standards/HKTASpec:hkta-2xxx.html>*





**SIEMIC, INC.**  
Accessing global markets

Title: RF Test Report P4T with Zcomax 802.11b/g radio module+RFID  
Model: P4T  
To: FCC 15.247:2010,RSS-210 Issue 8:2010

Serial# SL10082306-ZBR-063A1\_FCC.IC(DTS)  
Issue Date Dec 17th 2010  
Page 72 of 86  
www.sieminc.com

**SIEMIC ACCREDITATION DETAILS: FCC Test Site Registration No. 783147**

## FEDERAL COMMUNICATIONS COMMISSION

Laboratory Division  
7435 Oakland Mills Road  
Columbia, MD 21046

December 20, 2007

Registration Number: 783147

SIEMIC Laboratories  
2206 Ringwood Avenue,  
San Jose, CA 95131

Attention: Leslie Bai

Re: Measurement facility located at San Jose  
3 & 10 meter site  
Date of Renewal: December 20, 2007

Dear Sir or Madam:

Your request for renewal of the registration of the subject measurement facility has been received. The information submitted has been placed in your file and the registration has been renewed. The name of your organization will remain on the list of facilities whose measurement data will be accepted in conjunction with applications for Certification under Parts 15 or 18 of the Commission's Rules. Please note that the file must be updated for any changes made to the facility and the registration must be renewed at least every three years.

Measurement facilities that have indicated that they are available to the public to perform measurement services on a fee basis may be found on the FCC website [www.fcc.gov](http://www.fcc.gov) under E-Filing, OET Equipment Authorization Electronic Filing, Test Firms.

Sincerely,

Phyllis Parrish  
Industry Analyst



**SIEMIC ACCREDITATION DETAILS: Industry of Canada CAB ID : US0160**



**UNITED STATES DEPARTMENT OF COMMERCE**  
**National Institute of Standards and Technology**  
Gaithersburg, Maryland 20899

March 4, 2009

Mr. Leslie Bai  
SIEMIC, Inc.  
2206 Ringwood Avenue  
San Jose, CA 95131

Dear Mr. Bai:

NIST is pleased to inform you that your laboratory has been recognized by Industry Canada (IC), under the Asia Pacific Economic Cooperation for Telecommunications Equipment Mutual Recognition Arrangement (APEC Tel MRA). Your laboratory is now designated to act as a Conformity Assessment Body (CAB) under Appendix B, **Phase I** Procedures, of the APEC Tel MRA. The pertinent information about your laboratory's designation is as follows:

CAB Name: SIEMIC, Inc.  
Physical Location: 2206 Ringwood Avenue, San Jose, CA 95131 USA  
Identification No.: US0160  
Recognized Scope: CS-03 Part I, II, V, VI, VII and VIII

You may submit test data to IC to verify that the equipment to be imported into Canada satisfies the applicable requirements. The designation of your organization will remain in force as long as its accreditation for the designated scope remains valid and comply with the designation requirements.

Recognized CABs are listed on the NIST website at <http://ts.nist.gov/mra>. Please contact Ms. Ramona Saar at (301) 975-5521 or [ramona.saar@nist.gov](mailto:ramona.saar@nist.gov) if you have any questions.

Sincerely,

David F. Alderman  
Group Leader, Standards Coordination and Conformity Group  
Standards Services Division

Enclosure

cc: CAB Program Manager



**SIEMIC, INC.**  
Accessing global markets

Title: RF Test Report P4T with Zcomax 802.11b/g radio module+RFID  
Model: P4T  
To: FCC 15.247:2010,RSS-210 Issue 8:2010

Serial# SL10082306-ZBR-063A1\_FCC.IC(DTS)  
Issue Date Dec 17th 2010  
Page 74 of 86  
www.sieminc.com

**SIEMIC ACCREDITATION DETAILS: Industry of Canada Test Site Registration No. 4842-1**



May 27, 2010

OUR FILE: 46405-4842  
Submission No: 140856

**Siemic Inc.**  
2206 Ringwood Ave  
San Jose, CA, 95131  
USA

*Attention:* Snell Leong

Dear Sir/Madame:

The Bureau has received your application for the renewal of a 3m alternative test site. Be advised that the information received was satisfactory to Industry Canada. The following number(s) is now associated to the site(s) for which registration / renewal was sought ( **4842A-1** ). Please reference the appropriate site number in the body of test reports containing measurements performed on the site. In addition, please keep for your records the following information;

- Your primary code is: **4842**
- The company number associated to the site(s) located at the above address is: **4842A**

Furthermore, to obtain or renew a unique site number, the applicant shall demonstrate that the site has been accredited to ANSI C63.4-2003 or later. A scope of accreditation indicating the accreditation by a recognized accreditation body to ANSI C63.4-2003 or later shall be accepted. Please indicate in a letter the previous assigned site number if applicable and the type of site (example: 3 metre OATS or 3 metre chamber). If the test facility is not accredited to ANSI C63.4-2003 or later, the test facility shall submit test data demonstrating full compliance with the ANSI standard. The Bureau will evaluate the filing to determine if recognition shall be granted.

The frequency for re-validation of the test site and the information that is required to be filed or retained by the testing party shall comply with the requirements established by the accrediting organization. However, in all cases, test site re-validation shall occur on an interval not to exceed two years. There is no fee or form associated with an OATS filing. OATS submissions are encouraged to be submitted electronically to the Bureau using the following URL;  
[http://strategis.ic.gc.ca/epic/internet/inceb-bhst.nsf/en/h\\_tt00052e.html](http://strategis.ic.gc.ca/epic/internet/inceb-bhst.nsf/en/h_tt00052e.html)

If you have any questions, you may contact the Bureau by e-mail at [certification.bureau@ic.gc.ca](mailto:certification.bureau@ic.gc.ca) Please reference our file and submission number above for all correspondence.

Yours sincerely,

Dalwinder Gill  
For: Wireless Laboratory Manager  
Certification and Engineering Bureau  
3701 Carling Ave., Building 94  
P.O. Box 11490, Station "H"  
Ottawa, Ontario K2H 8S2  
Email: [dalwinder.gill@ic.gc.ca](mailto:dalwinder.gill@ic.gc.ca)  
Tel. No. (613) 998-8363  
Fax. No. (613) 990-4752



**SIEMIC ACCREDITATION DETAILS: FCC DOC CAB Recognition : US1109**

**FEDERAL COMMUNICATIONS COMMISSION**

**Laboratory Division  
7435 Oakland Mills Road  
Columbia, MD 21046**

August 28, 2008

Siemic Laboratories  
2206 Ringwood Ave.,  
San Jose, CA 95131

Attention: Leslie Bai

Re: Accreditation of Siemic Laboratories  
Designation Number: US1109  
Test Firm Registration #: 540430

Dear Sir or Madam:

We have been notified by American Association for Laboratory Accreditation that Siemic Laboratories has been accredited as a Conformity Assessment Body (CAB).

At this time Siemic Laboratories is hereby designated to perform compliance testing on equipment subject to Declaration Of Conformity (DOC) and Certification under Parts 15 and 18 of the Commission's Rules.

This designation will expire upon expiration of the accreditation or notification of withdrawal of designation.

Sincerely,

George Tannahill  
Electronics Engineer



**SIEMIC, Inc.**  
Accessing global markets

Title: RF Test Report P4T with Zcomax 802.11b/g radio module+RFID  
Model: P4T  
To: FCC 15.247:2010,RSS-210 Issue 8:2010

Serial# SL10082306-ZBR-063A1\_FCC.IC(DTS)  
Issue Date Dec 17th 2010  
Page 76 of 86  
www.sieminc.com

**SIEMIC ACCREDITATION DETAILS: Australia CAB ID : US0160**



**UNITED STATES DEPARTMENT OF COMMERCE**  
**National Institute of Standards and Technology**  
Gaithersburg, Maryland 20899

November 20, 2008

Mr. Leslie Bai  
SIEMIC, Inc.  
2206 Ringwood Avenue  
San Jose, CA 95131

Dear Mr. Bai:

NIST is pleased to inform you that your laboratory has been recognized by the Australian Communications and Media Authority (ACMA) under the Asia Pacific Economic Cooperation for Telecommunications Equipment Mutual Recognition Arrangement (APEC Tel MRA). Your laboratory is now designated to act as a Conformity Assessment Body (CAB) under Appendix B, **Phase I** Procedures, of the APEC Tel MRA. The pertinent information about your laboratory's designation is as follows:

CAB Name: Siemic, Inc.  
Physical Location: 2206 Ringwood Avenue, San Jose, CA 95131  
Identification No.: US0160  
Recognized Scope: EMC: AS/NZS 4251.1 (until 5/31/2009), AS/NZS 4251.2 (until 5/31/2009), AS/NZS CISPR 11, AS/NZS CISPR 14.1, AS/NZS CISPR 22, AS/NZS 61000.6.3, AS/NZS 61000.6.4  
Radiocommunications: AS/NZS 4281, AS/NZS 4268, AS/NZS 4280.1, AS/NZS 4280.2, AS/NZS 4295, AS/NZS 4582, AS/NZS 4583, AS/NZS 4769.1, AS/NZS 4769.2, AS/NZS 4770, AS/NZS 4771  
Telecommunications: AS/ACIF S002:05, AS/ACIF S003:06, AS/ACIF S004:06, AS/ACIF S006:01, AS/ACIF S016:01, AS/ACIF S031:01, AS/ACIF S038:01, AS/ACIF S040:01, AS/ACIF S041:05, AS/ACIF S043.2:06, AS/NZS 60950.1

You may submit test data to ACMA to verify that the equipment to be imported into Australia satisfies the applicable requirements. The designation of your organization will remain in force as long as its accreditation for the designated scope remains valid and comply with the designation requirements. Recognized CABs are listed on the NIST website at <http://ts.nist.gov/mra>. Please contact Ms. Ramona Saar, at (301) 975-5521 or [ramona.saar@nist.gov](mailto:ramona.saar@nist.gov) if you have questions.

Sincerely,

David F. Alderman  
Group Leader, Standards Coordination and Conformity Group  
Standards Services Division

Enclosure

cc: Snell Leong, Siemic, Inc.; Ramona Saar, NIST

**NIST**





**SIEMIC, Inc.**  
Accessing global markets

Title: RF Test Report P4T with Zcomax 802.11b/g radio module+RFID  
Model: P4T  
To: FCC 15.247:2010,RSS-210 Issue 8:2010

Serial# SL10082306-ZBR-063A1\_FCC.IC(DTS)  
Issue Date Dec 17th 2010  
Page 77 of 86  
www.siemic.com

**SIEMIC ACCREDITATION DETAILS: Korea CAB ID: US0160**



**UNITED STATES DEPARTMENT OF COMMERCE**  
**National Institute of Standards and Technology**  
Gaithersburg, Maryland 20899

October 1, 2008

Mr. Leslie Bai  
SIEMIC, Inc.  
2206 Ringwood Avenue  
San Jose, CA 95131

Dear Mr. Bai:

NIST is pleased to inform you that your laboratory has been recognized by the Radio Research Agency (RRA) Korea Communications Commission (KCC) under the Asia Pacific Economic Cooperation for Telecommunications Equipment Mutual Recognition Arrangement (APEC Tel MRA). Your laboratory is now designated to act as a Conformity Assessment Body (CAB) under Appendix B, **Phase I** Procedures, of the APEC Tel MRA. The pertinent information about your laboratory's designation is as follows:

CAB Name: SIEMIC, Inc.  
Physical Location: 2206 Ringwood Avenue, San Jose, CA 95131  
Identification No.: US0160  
Recognized Scope: **EMI:** KCC Notice 2008-39, RRL Notice 2008-3: CA Procedures for EMI  
KN22: Test Method for EMI  
**EMS:** KCC Notice 2008-38, RRL Notice 2008-4: CA Procedures for EMS  
KN24, KN-61000-4-2, -4-3, -4-4, -4-5, -4-6, -4-8, -4-11: Test Method for EMS  
**Wireless:** RRL Notice 2008-26, RRL Notice 2008-2, RRL Notice 2008-10,  
RRL Notice 2007-49, RRL Notice 2007-20, RRL Notice 2007-21,  
RRL Notice 2007-80, RRL Notice 2004-68  
**Wired:** President Notice 20664, RRL Notice 2007-30,  
RRL Notice 2008-7 with attachments 1, 3, 5, 6  
President Notice 20664, RRL Notice 2008-7 with attachment 4

You may submit test data to RRA/KCC to verify that the equipment to be imported into Korea satisfies the applicable requirements. The designation of your organization will remain in force as long as its accreditation for the designated scope remains valid and comply with the designation requirements.

Recognized CABs are listed on the NIST website at <http://ts.nist.gov/mra>. If you have any questions please contact Ramona Saar at (301) 975-5521 or [ramona.saar@nist.gov](mailto:ramona.saar@nist.gov).

Sincerely,

David F. Alderman  
Group Leader, Standards Coordination and Conformity Group  
Standards Services Division

Enclosure

cc: Ramona Saar





**SIEMIC ACCREDITATION DETAILS: Taiwan BSMI Accreditation No. SL2-IN-E-1130R**



UNITED STATES DEPARTMENT OF COMMERCE  
National Institute of Standards and Technology  
Gaithersburg, Maryland 20885

May 3, 2006

Mr. Leslie Bai  
SIEMIC Laboratories  
2206 Ringwood Avenue  
San Jose, CA 95131

Dear Mr. Bai:

I am pleased to inform you that your laboratory has been recognized by the Chinese Taipei's Bureau of Standards, Metrology, and Inspection (BSMI) under the Asia Pacific Economic Cooperation (APEC) Mutual Recognition Arrangement (MRA). Your laboratory is now designated to act as a Conformity Assessment Body (CAB) under Appendix B, **Phase I** Procedures, of the APEC Tel MRA. You may submit test data to BSMI to verify that the equipment to be imported into Chinese Taipei satisfies the applicable requirements. The designation of your organization will remain in force as long as its accreditation for the designated scope remains valid and comply with the designation requirements. The pertinent designation information is as follows:

- BSMI number: **SL2-IN-E-1130R** (Must be applied to the test reports)
- U.S. Identification No: **US0160**
- Scope of Designation: **CNS 13438**
- Authorized signatory: **Mr. Leslie Bai**

The names of all recognized CABs will be posted on the NIST website at <http://ts.nist.gov/mra>. If you have any questions, please contact Mr. Dhillon at 301-975-5521. We appreciate your continued interest in our international conformity assessment activities.

Sincerely,

David F. Alderman  
Group Leader, Standards Coordination and Conformity Group

cc: Joginder Dhillon

**NIST**

**SIEMIC ACCREDITATION DETAILS: Taiwan NCC CAB ID: US0160**



**UNITED STATES DEPARTMENT OF COMMERCE**  
**National Institute of Standards and Technology**  
Gaithersburg, Maryland 20899

November 25, 2008

Mr. Leslie Bai  
SIEMIC, Inc.  
2206 Ringwood Avenue  
San Jose, CA 95131

Dear Mr. Bai:

NIST is pleased to inform you that your laboratory has been recognized by the National Communications Commission (NCC) for the requested scope expansion under the Asia Pacific Economic Cooperation for Telecommunications Equipment Mutual Recognition Arrangement (APEC Tel MRA). Your laboratory is designated to act as a Conformity Assessment Body (CAB) under Appendix B, **Phase I** Procedures, of the APEC Tel MRA. The pertinent information about your laboratory's designation is as follows:

CAB Name: SIEMIC, Inc.  
Physical Location: 2206 Ringwood Avenue, San Jose, CA 95131  
Identification No.: US0160  
Current Scope: LP0002  
Additional Scope: PSTN01, ADSL01, ID0002, IS6100 and CNS 14336

You may submit test data to NCC to verify that the equipment to be imported into China satisfies the applicable requirements. The designation of your organization will remain in force as long as its accreditation for the designated scope remains valid and comply with the designation requirements.

Recognized CABs are listed on the NIST website at <http://ts.nist.gov/mra>. If you have any questions please contact Ramona Saar at (301) 975-5521 or [ramona.saar@nist.gov](mailto:ramona.saar@nist.gov).

Sincerely,

David F. Alderman  
Group Leader, Standards Coordination and Conformity Group  
Standards Services Division

Enclosure

cc: Ramona Saar



**SIEMIC, INC.**  
Accessing global markets

Title: RF Test Report P4T with Zcomax 802.11b/g radio module+RFID  
Model: P4T  
To: FCC 15.247:2010,RSS-210 Issue 8:2010

Serial# SL10082306-ZBR-063A1\_FCC.IC(DTS)  
Issue Date Dec 17th 2010  
Page 80 of 86  
www.siemic.com

**SIEMIC ACCREDITATION DETAILS: Mexico NOM Recognition**



CAMARA NACIONAL  
DE LA INDUSTRIA  
ELECTRONICA, DE  
TELECOMUNICACIONES  
E INFORMÁTICA

**Laboratorio Valentin V. Rivero**

México D.F. a 16 de octubre de 2006.

**LESLIE BAI  
DIRECTOR OF CERTIFICATION  
SIEMIC LABORATORIES, INC.  
ACCESSING GLOBAL MARKETS  
P R E S E N T E**

En contestación a su escrito de fecha 5 de septiembre del año en curso, le comento que estamos muy interesados en su intención de firmar un Acuerdo de Reconocimiento Mutuo, para lo cual adjunto a este escrito encontrara el Acuerdo en idioma inglés y español preferido de los cuales le pido sea revisado y en su caso corregido, para que si está de acuerdo poder firmarlo para mandarlo con las autoridades Mexicanas para su visto bueno y así poder ejercer dicho acuerdo.

Aprovecho este escrito para mencionarle que nuestro intermediario gestor será la empresa Isabel de México, S. A. de C. V. empresa que ha colaborado durante mucho tiempo con nosotros en lo relacionado a la evaluación de la conformidad y que cuenta con amplia experiencia en la gestión de la certificación de cumplimiento con Normas Oficiales Mexicanas de producto en México.

Me despido de usted enviándole un cordial saludo y esperando sus comentarios al Acuerdo que nos ocupa.

Atentamente:

  
**Ing. Faustino Gomez Gonzalez  
Gerente Técnico del Laboratorio de  
CANIETI**

Calle 17  
Paseo de la Reforma  
06100 México, D.F.  
Tel. 5206 6008 con 12 líneas  
Fax: 5206 6000  
www.canietimex.com



**SIEMIC ACCREDITATION DETAILS: Hong Kong OFTA CAB ID : US0160**



**UNITED STATES DEPARTMENT OF COMMERCE**  
**National Institute of Standards and Technology**  
Gaithersburg, Maryland 20899-

December 8, 2008

Mr. Leslie Bai  
SIEMIC, Inc.  
2206 Ringwood Avenue  
San Jose, CA 95131

Dear Mr. Bai:

NIST is pleased to inform you that your laboratory has been recognized by the Office of the Telecommunications Authority (OFTA) under the Asia Pacific Economic Cooperation for Telecommunications Equipment Mutual Recognition Arrangement (APEC Tel MRA). Your laboratory is now designated to act as a Conformity Assessment Body (CAB) under Appendix B, **Phase I** Procedures, of the APEC Tel MRA. The pertinent information about your laboratory's designation is as follows:

CAB Name: SIEMIC, Inc.  
Physical Location: 2206 Ringwood Avenue, San Jose, California 95131 USA  
Identification No.: US0160  
Recognized Scope: **Radio:** HKTA 1002, 1007, 1008, 1010, 1015, 1016, 1020, 1022, 1026, 1027, 1029, 1030, 1031, 1032, 1033, 1034, 1035, 1036, 1037, 1039, 1041, 1042, 1043, 1044, 1046, 1047, 1048, 1049, 1051  
**Telecom:** HKTA 2011, 2012, 2013, 2014, 2017, 2018, 2022, 2024, 2026, 2027, 2028, 2029, 2030, 2031, 2032, 2033

You may submit test data to OFTA to verify that the equipment to be imported into Hong Kong satisfies the applicable requirements. The designation of your organization will remain in force as long as its accreditation for the designated scope remains valid and comply with the designation requirements.

Recognized CABs are listed on the NIST website at <http://ts.nist.gov/mra>. If you have any questions please contact Ramona Saar at (301) 975-5521 or [ramona.saar@nist.gov](mailto:ramona.saar@nist.gov).

Sincerely,

David F. Alderman  
Group Leader, Standards Coordination and Conformity Group  
Standards Services Division

Enclosure

cc: Ramona Saar



**SIEMIC ACCREDITATION DETAILS: Australia ACMA CAB ID: US0160**



**UNITED STATES DEPARTMENT OF COMMERCE**  
**National Institute of Standards and Technology**  
Gaithersburg, Maryland 20899-

November 20, 2008

Mr. Leslie Bai  
SIEMIC, Inc.  
2206 Ringwood Avenue  
San Jose, CA 95131

Dear Mr. Bai:

NIST is pleased to inform you that your laboratory has been recognized by the Australian Communications and Media Authority (ACMA) under the Asia Pacific Economic Cooperation for Telecommunications Equipment Mutual Recognition Arrangement (APEC Tel MRA). Your laboratory is now designated to act as a Conformity Assessment Body (CAB) under Appendix B, **Phase I** Procedures, of the APEC Tel MRA. The pertinent information about your laboratory's designation is as follows:

CAB Name: Siemic, Inc.  
Physical Location: 2206 Ringwood Avenue, San Jose, CA 95131  
Identification No.: US0160  
Recognized Scope: EMC: AS/NZS 4251.1 (until 5/31/2009), AS/NZS 4251.2 (until 5/31/2009), AS/NZS CISPR 11, AS/NZS CISPR 14.1, AS/NZS CISPR 22, AS/NZS 61000.6.3, AS/NZS 61000.6.4  
Radiocommunications: AS/NZS 4281, AS/NZS 4268, AS/NZS 4280.1, AS/NZS 4280.2, AS/NZS 4295, AS/NZS 4582, AS/NZS 4583, AS/NZS 4769.1, AS/NZS 4769.2, AS/NZS 4770, AS/NZS 4771  
Telecommunications: AS/ACIF S002:05, AS/ACIF S003:06, AS/ACIF S004:06, AS/ACIF S006:01, AS/ACIF S016:01, AS/ACIF S031:01, AS/ACIF S038:01, AS/ACIF S040:01, AS/ACIF S041:05, AS/ACIF S043.2:06, AS/NZS 60950.1

You may submit test data to ACMA to verify that the equipment to be imported into Australia satisfies the applicable requirements. The designation of your organization will remain in force as long as its accreditation for the designated scope remains valid and comply with the designation requirements. Recognized CABs are listed on the NIST website at <http://ts.nist.gov/mra>. Please contact Ms. Ramona Saar, at (301) 975-5521 or [ramona.saar@nist.gov](mailto:ramona.saar@nist.gov) if you have questions.

Sincerely,

David F. Alderman  
Group Leader, Standards Coordination and Conformity Group  
Standards Services Division

Enclosure

cc: Snell Leong, Siemic, Inc.; Ramona Saar, NIST



## SIEMIC ACCREDITATION DETAILS: Australia NATA Recognition



Leslie Bai  
SIEMIC, Inc.  
2206 Ringwood Avenue  
San Jose, CA 95131

November 4, 2008

Under Australian government legislation, the Australian Communications and Media Authority (ACMA) has determined the National Association of Testing Authorities, Australia (NATA) as an accreditation body as per Section 409(1) of the Telecommunications Act 1997 (Cth). Pursuant to Section 409(2) of the Telecommunications Act 1997 (Cth), I am pleased to advise that your laboratory has been determined as a Recognised Testing Authority (RTA).

This determination has been made on the basis of your accreditation by A2LA accreditation no. 2742.01 and the Mutual Recognition Agreement between NATA and A2LA. It is effective from 11 July 2008. RTA status applies only to the following standards and is contingent upon their continued inclusion in your laboratory's scope of accreditation.

**AS/ACIF S002, AS/ACIF S003, AS/ACIF S004,  
AS/ACIF S006, AS/ACIF S016, AS/ACIF S031,  
AS/ACIF S038, AS/ACIF S041 and  
AS/ACIF S043.2**

As an RTA, your laboratory has the following obligations.

1. the laboratory shall continue to meet all of the accreditation criteria of A2LA;
2. the authorised representative of the laboratory shall notify NATA of changes to the staff or operations of the laboratory which would affect the performance of the tests for which the laboratory has been determined;
3. compliance of equipment shall be reported on test reports bearing the A2LA logo/endorsement.

Current information on the Australian Communications and Media Authority and regulatory requirements for telecommunications products within Australia can be obtained from the ACMA's web-site at "<http://www.acma.gov.au>". Further information about NATA may be gained by visiting "<http://www.nata.asn.au>".

Please note that AS/ACIF S040 and New Zealand standards do not form part of the RTA scheme.

Your RTA listing will appear on the NATA website shortly.

Kind Regards

Chris Norton,  
Senior Scientific Officer  
Measurement Science and Technology  
National Association of Testing Authorities (NATA)  
71-73 Flemington Road  
North Melbourne Vic 3051  
Australia  
Ph: +61 3 9329 1633 Fax: +61 3 9326 5148  
E-Mail: [Christopher.Norton@nata.asn.au](mailto:Christopher.Norton@nata.asn.au)  
Internet: [www.nata.asn.au](http://www.nata.asn.au)



**SIEMIC ACCREDITATION DETAILS: VCCI Radiated Test Site Registration No. R-3083**

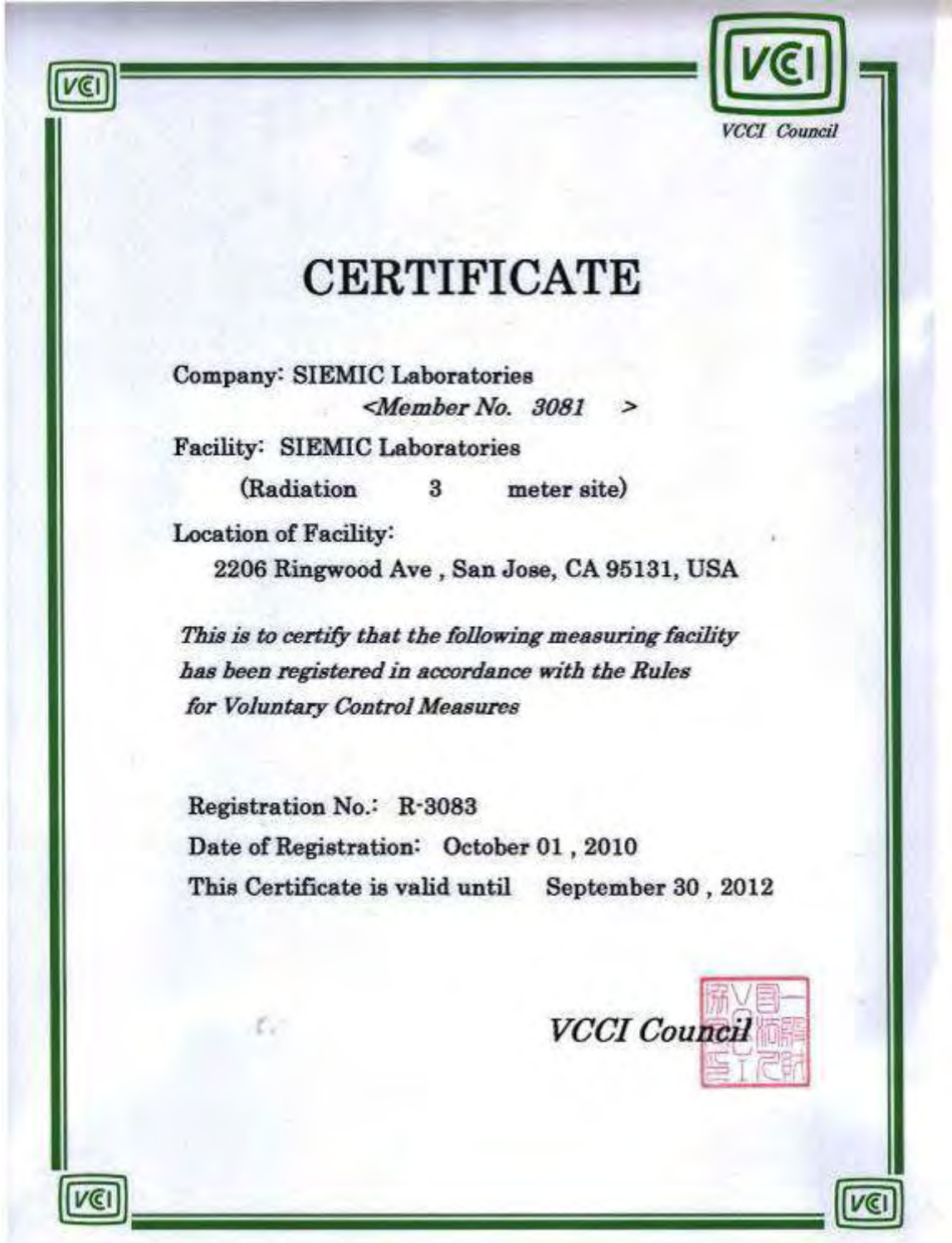



**SIEMIC ACCREDITATION DETAILS: VCCI Conducted (Main Port) Test Site Registration No. C-3421**



VCCI Council

# CERTIFICATE

**Company: SIEMIC Laboratories**

*<Member No. 3081 >*

**Facility: SIEMIC Laboratories**

**(Main Ports Conducted Interference Measurement)**

**Location of Facility:**

**2206 Ringwood Ave San Jose, CA 95131, USA**

*This is to certify that the following measuring facility  
has been registered in accordance with the Rules  
for Voluntary Control Measures*

**Registration No.: C-3421**

**Date of Registration: October 01, 2010**

**This Certificate is valid until September 30, 2012**

**VCCI Council**





**SIEMIC ACCREDITATION DETAILS: VCCI Conducted (Telecom Port) Test Site Registration No. T-1597**

