

Manual Introduction	RP4T Printers
P4T Overview	Maintenance
Printer Preparation	Troubleshooting
Connecting the Printer	Specifications
Radio Regulatory Information	Appendices
	Index

Model RP4T RFID Encoder



The information in this section is provided for your convenience only and is subject to change. Go to <http://www.epcglobalinc.org> for the latest EPC information.

The RP4T printer is equipped with an RFID encoder/reader, which is integrated into the printer's printhead assembly. The RP4T encodes (writes) information on ultra-thin UHF RFID transponders that are embedded in "smart" labels, tickets, and tags. The printer encodes the information; verifies proper encoding; and prints bar codes, graphics, and/or text on the label's surface. The RP4T printer uses Zebra's extensive set of RFID commands running under ZPL programming language emulation.

The RFID transponder is sometimes called the RFID tag or an inlay. The transponder is usually made of an antenna that is bonded to an integrated circuit (IC) chip. The IC chip contains the RF circuit, coders, decoders, and memory. If you hold an RFID label up to the light, you can see the transponder's antenna, and you can feel a bump in the label where the IC chip is located.

The RP4T can encode and verify EPC (Electronic Product Code) Generation 2 Class 1 UHF passive RFID tags, in addition to printing human readable text and conventional 1 and 2-D barcode information on Zebra supplied RFID thermal transfer media.

EPC is a product numbering standard that can be used to identify a variety of items by using RFID technology. EPC Generation 2 tags offer advantages over other tag types. The tag identification (TID) memory in a Generation 2 tag includes the chip manufacturer and model number information, which can be used to identify which optional features are present on the tag. These optional features include those for data content and security.

Gen 2 tags typically have a 96-bit EPC identifier, which is different from the 64-bit identifiers common in early EPC tags. The 96-bit EPC code links to an online database, providing a secure way of sharing product-specific information along the supply chain.

Gen 2 tags also support much larger data structures. The size of user memory available (if any) varies by the model and manufacturer of the tag.



Print quality will be reduced when attempting to print over the transponder portion of an RFID label. It is recommended that RFID label layouts should not allow printing over the RFID transponder portion of a label.

Generation 2 Class 1 UHF Passive Tags Supported By The P4T

- Alien Squiggle*
- Avery Dennison*
- Raflatac Onetenna*
- Omron Wave*

Encoding and printing of an RFID label usually are completed on the first try, but some failures may occur. If you experience consistent encoding failures, it may signal a problem with the RFID tags, your label formats, or with the transponder placement.

If an RFID tag cannot be encoded, "VOID" will be printed on the label. The printer then attempts to read/encode "n" labels before the next format is attempted, where "n" is specified by the ZPL programming language "**^RS**" command. Acceptable values of "n" are 1 to 10 and the default is 3. After printing the defined number of voided RFID labels, printer will go into an error mode. The printer response to an error is defined by the RFID Setup command and will allow:

1. No Action (Label format causing the error is dropped)
2. Notification to the Host of the details of the error (Label format causing the error is dropped).

The user has control of where on the label the VOID is printed.

More information on the "**^RS**" command may be found in Zebra's RFID Programming Guide available on the corporate Web site.

Manual Introduction	RP4T Printers
P4T Overview	Maintenance
Printer Preparation	Troubleshooting
Connecting the Printer	Specifications
Radio Regulatory Information	Appendices
	Index

Preventive Maintenance

Extending Battery Life

- Avoid exposing the battery to direct sunlight or temperatures over 104 °F (40 °C).
- Always use a Zebra charger designed specifically for Lithium-Ion batteries. Use of any other kind of charger may damage the battery.

Caution • Do not print while an LI72 Single Charger is plugged into the unit. Unreliable battery charging can result.

- Use the correct media for your printing requirements. An authorized Zebra re-seller can help you determine the optimum media for your application.
- If you print the same text or graphic on every label, consider using a preprinted label.
- Choose the correct print darkness and print speed for your media.
- RP4T printers (with the RFID encoder/reader): adjust the encoder settings to use the minimum power required for the RFID media in use.
- Use software handshaking (XON/XOFF) whenever possible.
- Use the LCD display backlight only when necessary. Turn it off whenever it is not needed.

- Remove the battery from the printer if it won't be used for a day or more and you're not performing a maintenance charge.
- Consider purchasing an extra battery.
- Remember that any rechargeable battery will lose its ability to maintain a charge over time and can be recharged only a finite number of times before it must be replaced. The "Smart Battery" feature of the P4T Series monitors the battery pack's condition and will prompt you when a battery pack is nearing the end of its useful life.

! Always dispose of used batteries properly. Refer to Appendix E for more information on proper battery disposal.

- When the printer displays "Please Recondition The Battery" and beeps five times, the user should recondition the battery to return it to optimal capacity. Refer to the [Operator Controls](#) section of this manual for information in reconditioning the battery.

General Cleaning Instructions

! Caution • Always turn the printer off before cleaning.

! To avoid possible personal injury or damage to the printer, never insert any pointed or sharp objects into the printer.

! Use care when working near the Tear Bar. The edges are very sharp.

! Caution • The printhead can become very hot after prolonged printing. Allow it to cool off before attempting any cleaning procedures.

Caution • Use only cleaning agents specified in the P4T Series cleaning instructions. Zebra Technologies Corporation will not be responsible for damage caused by any other cleaning materials used on this printer.

Clean the printer with either the cleaning pen supplied with the printer or a cotton swab saturated with alcohol.

Manual Introduction	RP4T Printers
P4T Overview	Maintenance
Printer Preparation	Troubleshooting
Connecting the Printer	Specifications
Radio Regulatory Information	Appendices
	Index

P4T Series Cleaning

⚠ Caution • To avoid possible personal injury or damage to the printer never insert sharp or pointed objects into the printer mechanism.

Figure 17.1- P4T Series Cleaning

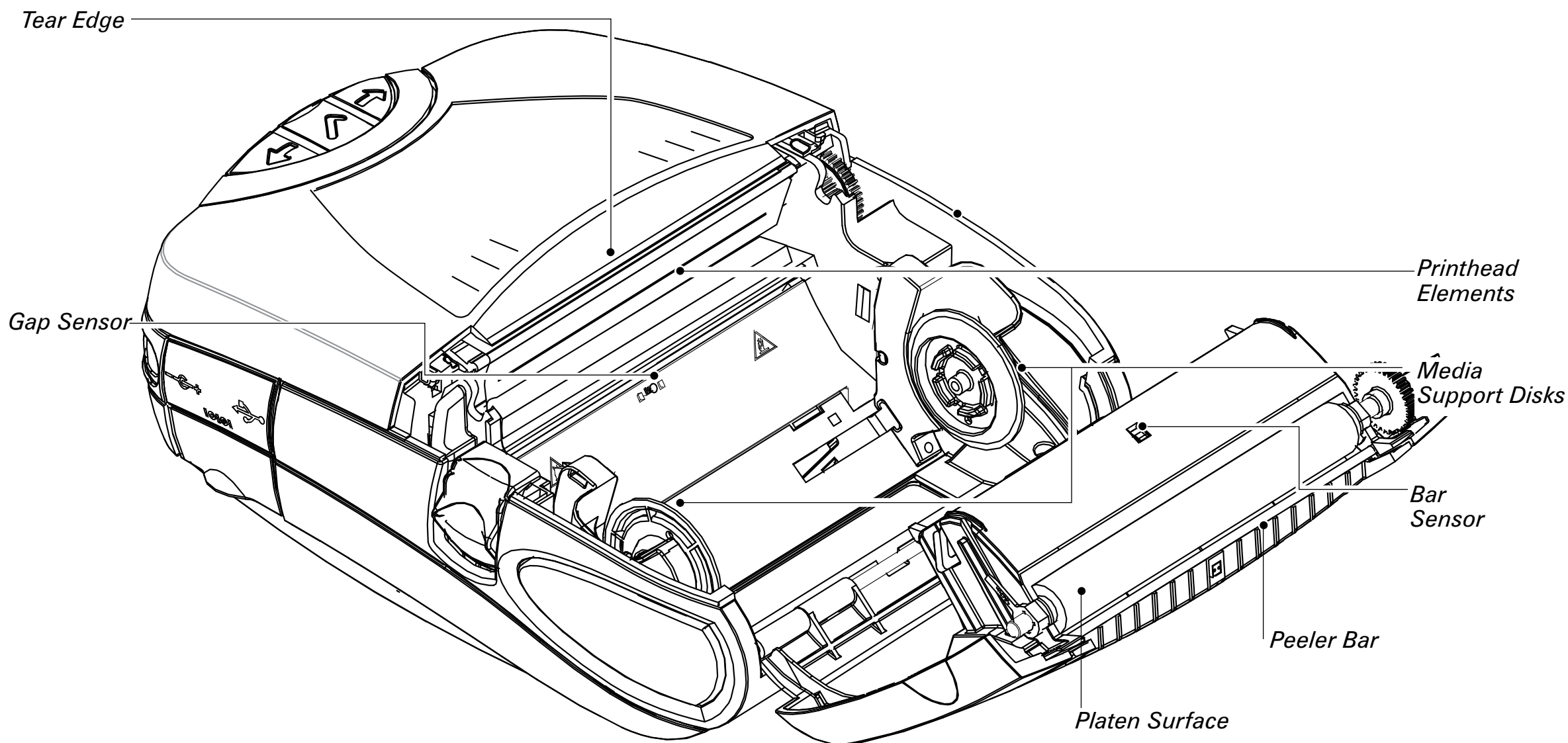
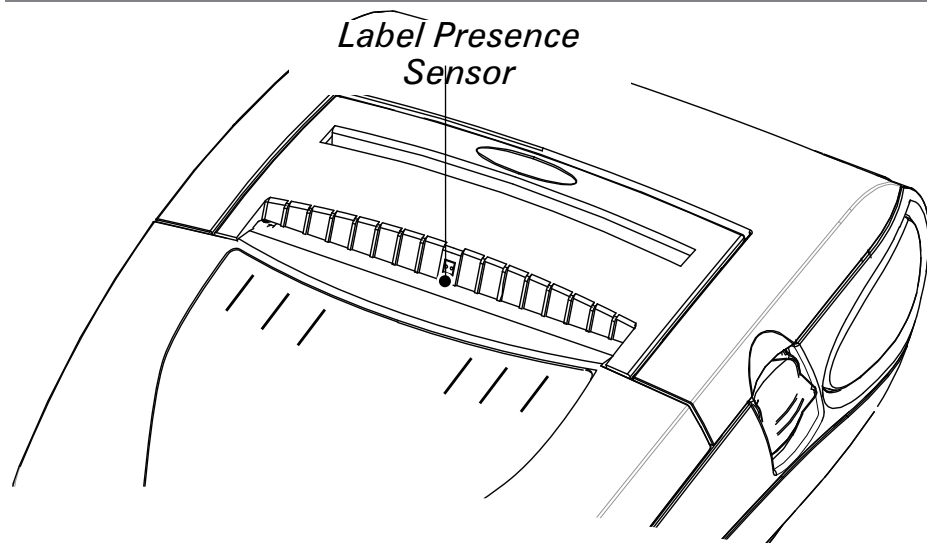

Figure 17.2- Cleaning the P4T Series Peeler Assembly











Area	Cleaning Method	Interval
Printhead Elements	Use the supplied cleaning pen to clean the print elements from end to end (the print elements are located in the thin gray line on the printhead).	After every five rolls of media (or more often, if needed)
Platen Surface	Rotate the platen roller and clean it thoroughly with the cleaning pen.	
Peeler Bar Tear Edge	Clean thoroughly with the cleaning pen.	As needed
Exterior	Wipe with water-dampened cloth	
Interior	Brush/air blow. Ensure the Bar Sensor, Gap Sensor and Label Present Sensor windows and the Media Support Disks are free of dust.	

Manual Introduction	RP4T Printers		
P4T Overview	Maintenance		
Printer Preparation	Troubleshooting		
Connecting the Printer	Specifications		
Radio Regulatory Information	Appendices		
	Index		

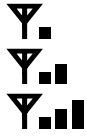
Troubleshooting

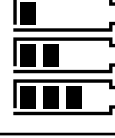
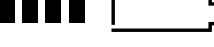
LCD Control Panel

The top of the display shows icons indicating the status of various printer functions. Check the icon's status and refer to the referenced Troubleshooting topic on the following pages.

Icon	Status	Indication	Ref. to Troubleshooting Topic
	On	Bluetooth link established	n/a
	Off	No Bluetooth link	6,8
	On	802.11b/g RF Link established	n/a
	Off	No 802.11b/g RF Link	6,8
		Number of bars indicates 802.11g signal strength	n/a
	Outer icon element flashing	Low Battery	4, 6,
		Number of bars indicates battery charge level. Display will cycle through the battery icons if it is undergoing a charge from the AC Adapter.	n/a
	Flashing	Battery too hot or too cold to charge	2
	Flashing	Out of Media	9
	Flashing	Ribbon Cartridge depleted	9
	Flashing	Data transfer in process	n/a
Blank Screen	n/a	Battery voltage too low to turn printer on or no application loaded	1,14

Troubleshooting Topics

1. No power:

- Check that battery is installed properly.
- Recharge or replace battery as necessary.
- If the battery voltage is outside of the range at which the printer will turn on and the AC Adapter is plugged into printer, the printer will not turn on. The battery will start to charge, but the user will have no indication that the battery is charging. When the battery reaches a valid operating voltage range, the printer will still not turn on unless the user manually turns it on, or unplugs and re-plugs the charge cable.

2. AC Adapter is plugged in and the battery icon is alternately flashing and .

- Indicates that the battery is out of its safe charging temperature range. Charging will resume when the battery reaches a safe charging temperature.

3. Media does not feed:

- Be sure printhead is closed and latched.
- Check media support components for any binding.
- If unit is equipped with label presence sensor, ensure the most recently printed label is removed.
- Ensure label sensor is not blocked.

Manual Introduction	RP4T Printers
P4T Overview	Maintenance
Printer Preparation	Troubleshooting
Connecting the Printer	Specifications
Radio Regulatory Information	Appendices
	Index

Troubleshooting Topics (continued)

4. *Poor or faded print or low battery icon () flashing:*

- Clean printhead.
- Check battery pack. Recharge or replace as necessary.



Always dispose of used battery packs properly. Refer to Appendix E for more information.

- Check quality of media.

5. *Partial/missing print:*

- Check Ribbon Cartridge and/or label media alignment.
- Clean printhead.
- Ensure printhead is properly closed and latched.

6. *No print:*

- Replace battery pack.
- Check cable to terminal.
- Wireless units only: Restore wireless connection.
- Units using Thermal Transfer media: Ensure Ribbon Cartridge has been installed.

7. *Reduced battery life:*

- Check battery pack date code. If battery is one to two years old, short life may be due to normal aging.
- Check printer display. If battery has exceeded a factory set number of charge cycles the printer will display a message that the battery needs re-conditioning or replacing.
- Replace battery pack.

8. or icon off:

- Units with Bluetooth or 802.11g option only: indicates no radio link has been established.

9. or flashing:

- Check that label media is loaded.
- Replace Ribbon Cartridge if depleted.
- Check that the printhead is closed and securely latched.

10. *Skips labels:*

- Ensure correct media is being used.
- Ensure bar/ or gap sensor is not blocked.
- Ensure label design does not exceed actual media length.

11. *Prints “wrinkle pattern” or partial characters:*

- Ensure Ribbon Cartridge has been tensioned prior to installation. Problem will self-correct after printing a few labels.
- Ensure label media tracks properly when emerging from printer. Use the alignment marks on the printer cover to ensure wrinkle

free operation when loading media into the peeler assembly. Correct media alignment if necessary.

12. *Prints multiple “Void” messages:*

- RP4T printers only: Ensure you have installed RFID media. Printer cannot verify RF encoding on non-RFID media and will print “Void” on a pre-set number of labels before stopping.

13. *Communication Error:*

- Check media is loaded, head is closed and all error indicators are off.
- Replace cable to terminal.

14. *Screen blank*

- No application loaded. Attempt to re-load application and restart printer.
- No power. See Topic “1” of this section.

Manual Introduction	RP4T Printers
P4T Overview	Maintenance
Printer Preparation	Troubleshooting
Connecting the Printer	Specifications
Radio Regulatory Information	Appendices
	Index

Troubleshooting Techniques

Printing a Configuration Label

To print out a listing of the printer's current configuration follow these steps:

1. Turn the printer off. Load the media compartment with journal media (media with no black bars printed on the back)
2. Press and hold the Feed Button.
3. Press and release the Power button and keep the Feed button pressed. When printing starts, release the Feed button.
4. The printer will create two reports. The first report is a basic functional test of the printer. It prints a series of interlocking "X" characters which acts as a test of the printhead elements and reports on basic features of the printer including memory installed.

The second report is a detailed list of the printer's configuration, including any options installed (such as radios) and current status of system settings.

Refer to Figures 18.1 through 18.2 for a sample configuration label printout.

Performing a Forced Shutdown

If the printer has locked up and is not responding to any operator inputs or external commands, from either a connected terminal or a linked LAN, you can perform a forced shutdown.

- If the printer software locks up during normal operation, force the printer to shut down by pressing and holding the Power Button for 3 seconds.
- If you try to turn the printer off normally and the software locks up, the printer will automatically shut itself off after a 10 second delay.
- If you try to turn the printer off and it does not respond, you can force an immediate shut down by pressing and holding the Power Button again within 10 seconds.

A forced shutdown will preserve the printer's data and settings.

Communications Diagnostics

If there's a problem transferring data between a terminal or WLAN, placing the printer in the Communications Diagnostics Mode (also referred to as the "DUMP" mode) will allow diagnostic analysis. The printer will print transmitted data as ASCII characters and their text representation (or a period "." if not a printable character) for any data received from the host terminal or network

To enter Communications Diagnostics Mode:

1. Print a configuration label as described above.
2. At the end of 2nd diagnostics report, the printer will print:

"Press FEED key to enter DUMP mode."

3. Press the FEED key. The printer will print: "Entering DUMP mode."



Note • If the FEED key is not pressed within 3 seconds, the printer will print "DUMP mode not entered" and will resume normal operation.

4. At this point, the printer is in DUMP mode and will print the ASCII hex codes of any data sent to it, and their text representation (or "." if not a printable character).

Additionally, a file with a ".dmp" extension containing the ASCII information will be created and stored in the printer's memory. It can be viewed, "cloned" or deleted using the Label Vista application. (Refer the Label Vista documentation for more information.)

To terminate the Communications Diagnostics Mode:

1. Turn the printer OFF.
2. Wait 5 seconds.
3. Turn the printer ON.

The printer will resume normal operation.

Calling Technical Support

If the printer fails to print the configuration label, or you encounter problems not covered in the Troubleshooting Guide, contact Zebra Technical Support. You will need to supply the following information:

- Model number/type (e.g. P4T, RP4T)
- Unit serial number (14 digit number, including dashes) and Product Configuration Code (PCC) (15 digit number, including dashes). Refer to Appendix D for the location of these numbers.
- Technical support contact information may be found in Appendix D of this manual.

Manual Introduction	RP4T Printers
P4T Overview	Maintenance
Printer Preparation	Troubleshooting
Connecting the Printer	Specifications
Radio Regulatory Information	Appendices
	Index

Figure 18.1- P4T Series Configuration Label Sample

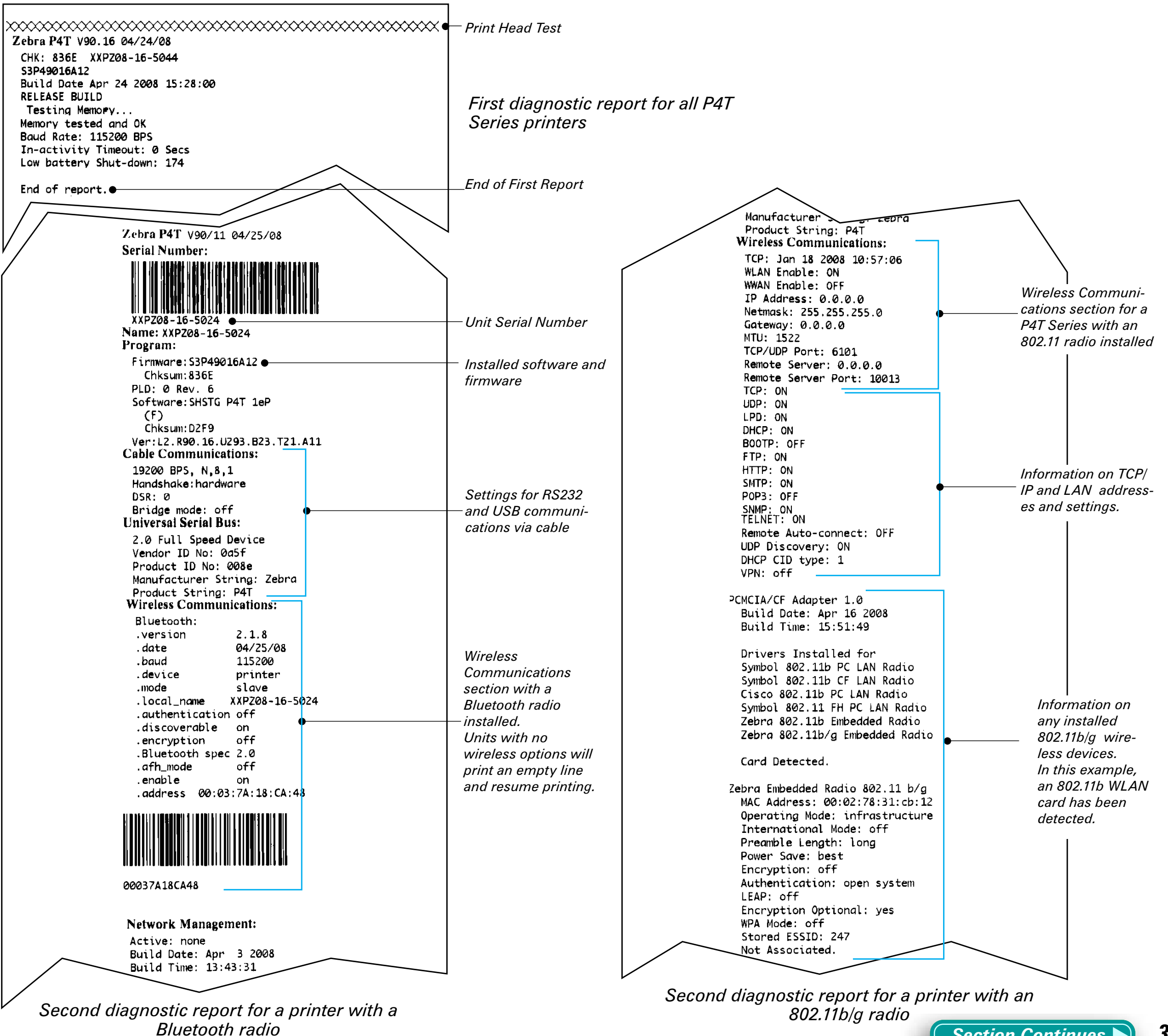

Manual Introduction	RP4T Printers
P4T Overview	Maintenance
Printer Preparation	Troubleshooting
Connecting the Printer	Specifications
Radio Regulatory Information	Appendices
	Index

Figure 18.2- P4T Series Configuration Label Sample

Active: none
 Build Date: Apr 3 2008
 Build Time: 13:43:31

Peripherals:
 MCR 4.10
 LCD: Installed
 Expansion module: 0x77
 Bluetooth

Power Management:
 In-activity Timeout:0 Secs
 Low-battery Timeout:60 Secs
 Remote(DTR) pwr-off:Disabled
 Voltage :8.29(210)
 Low-bat Warning :7.10(182)
 Low-bat Shut-down:6.79(174)
 Power On Cycles :143
 Battery Health :good

Memory:
 Flash :8388607 Bytes
 RAM :16777215 Bytes

Label:
 Width :832 dots, 104 mm
 Height:65535 dots, 8191 mm

Sensors: (Adj)
 Ribn[DAC:225,Thr:100,Cur:254]
 Not Detected
 Pres[DAC:127,Thr:120,Cur:255]
 Label Removed
 Media [255 (384 dots)]
 Gap [DAC:110,Thr: 30,Cur: 70]
 Bar [DAC: 98,Thr: 70,Cur: 10]
 Temperature :179
 Voltage :8.29(210)

Resident Fonts:

Font	Sizes	Chars
0	0- 6	20-FF
1	0	20-80
2	0- 1	20-59
4	0- 7	20-FF
5	0- 3	20-FF
6	0	20-44
7	0- 1	20-FF
10	0- 6	00-FF

File Directory:

File	Size
ZPL_CFG .CFG	76
INDEX .WML	4702

4388000 Bytes Free
Command Language:
 CCL Key '!' [21]
 EPL2 EMULATION VER

Flash Memory Size
RAM Size
Maximum label dimensions and label sensor settings
Resident Fonts Installed
Files Loaded in Printer Memory. Will include file for LCD prompts (.wml format)
Amount of Memory Available

Second diagnostic report continued

INDEX
 4388000 Bytes Free
Command Language:
 CCL Key '!' [21]
 EPL2 EMULATION VER 2.1

ZPL Configuration Information
 [Ver: V30.8.4-Z2.05]
 [Ifont Ver: 1.14]
 Tear Off.. Print Mode
 Non-Continuous.. Media Type
 10... Darkness
 +00... Tear Off Adjust
 1225.. Label length
 100mm. Print Width
 7eh... Control Prefix
 5eh... Format Prefix
 2ch... Delimiter
 00... Top Position
 01... Media Pwr Up
 01... Media Head Close
 00... Left Margin
 800... Dots per row

End of report.

Press FEED key to enter DUMP mode.

Dump mode not entered.

Command languages supported. P4T Series supports both CPCL language and emulates ZPLII.
Configuration settings for ZPL language emulation
End of Configuration Report
End of second diagnostic report

Manual Introduction	RP4T Printers
P4T Overview	Maintenance
Printer Preparation	Troubleshooting
Connecting the Printer	Specifications
Radio Regulatory Information	Appendices
	Index

Specifications



Note.- Printer specifications are subject to change without notice.

Printing Specifications

Maximum Print Width	4.09 in. [103,8 mm]
Print Speed @ 30% density	2.0 in. /sec. [50,8 mm/second] Direct Thermal mode 1.5 in./sec. [38,1 mm/second] Thermal Transfer mode
Distance from Print Element to Tear Edge	0.39 in. [9,91 mm] 41 dots
Print Head Life	1,000,000 inches (25.4 Km) min.
Print Density	203 dots/inch (8 dots/mm)

Memory/Communications Specifications

Flash Memory	8 MB flash (standard)
RAM Memory	16 MB RAM)
Standard Communications	RS-232C serial port (RJ-45 connector) Configurable Baud rate (from 9600 to 115.2 Kbps), parity and data bits. Software (X-ON/X-OFF) or hardware (DTR/STR) communication handshake protocols. Two USB 2.0 Full Speed Interface connections: (1) a "B" type USB connector, and (2) USB signals are also integrated into the RJ-45 connector. Refer to the Communications Ports specifications and Appendix A for information on USB cables.
Optional Wireless Communications	Bluetooth 2.0 compatible 2.4 GHz SRRF link Wireless LAN capabilities comply with 802.11b or 802.11g protocols Co-located Bluetooth 2.0 + 802.11b/g radios (P4T only)
Real Time Clock (RTC)	Time and date under application control. Refer to CPCL Programming Manual, available at www.zebra.com for RTC commands.

Figure 19- P4T Series Communication Ports

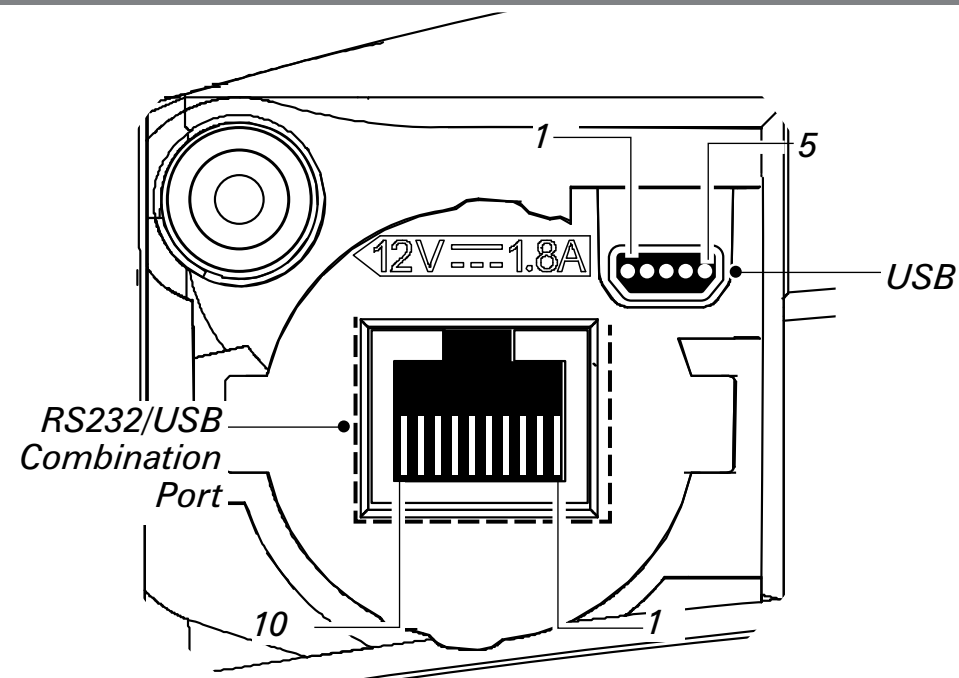

Communications Ports

USB

Signal Pin#	Name	Type	Description
1	VBUS		USB Bus Power
2	USB -	bi-directional	I/O signals
3	USB +	bi-directional	I/O signals
4	USB _ ID		Identifies A/B connector
5	Return		Ground

RS232/USB

Signal Pin#	Name	Type	Description
1	USB D-	bi-directional	I/O signals
2	USB D+	bi-directional	I/O signals
3	RXD	input	Receive Data
4	TXD	output	Transmit Data
5	DTR	output	Data Terminal Ready- set high when printer is on.
6	GND		Ground
7	DSR	input	Data Set Ready- low to high
8	RTS	output	Request To Send- set high when printer is ready to accept a command or data
9	CTS	input	Clear To Send from host
10	VBUS		USB Bus Power

Manual Introduction	RP4T Printers
P4T Overview	Maintenance
Printer Preparation	Troubleshooting
Connecting the Printer	Specifications
Radio Regulatory Information	Appendices
	Index

P4T Series Media Specifications

Media Width	2.0 in. to 4.12 in. (50,8 to 104,6 mm)
Max. continuous receipt (w/std. memory)	Continuous, dependent on installed memory
Inter-label Gap.	0.08 in. to 0.16 in. (0.12 in. preferred)(2 mm to 4 mm [3 mm preferred])
Label Thickness	0.032 in to 0.007" (0,064 mm to 0,165 mm)
RFID Label Thickness (RP4T only)	0.032 in to 0.007" (.064 mm to .165 mm), Thickness over RFID element- .023 in. [0,58 mm]
Max. Label Roll diameter.	2.25 in. (57 mm) O.D.
Label Inner Core	.75 in. (19 mm) minimum diameter; 1.38 in. (35 mm) RFID Media
Black Mark Dimensions	The reflective media black marks should extend past the centerline of the roll. Minimum mark width: 1.0 in. (25,4 mm) perpendicular to edge of media, centered within the width of the roll. Mark length: 0.094 in. (2,4 mm) parallel to edge of media
Media Requirements	

Use Zebra brand direct or thermal transfer media that is outside wound. Media may be reflective (black mark) sensing, or transmissive (gap) sensing, die-cut, or continuous. P4T Series units configured with the External Media option will accept fanfold media used with an external media supply. For die-cut labels, use only full auto dies.

P4T Series Font and Bar Code Specifications

Linear & 2-D Bar Codes Available	Codabar (NW-7)
	UCC/EAN 128
	Code 39
	Code 93
	EAN 8/JAN 8, 2 and 5 digit extensions
	EAN 13/JAN 13, 2 and 5 digit extensions
	EAN 14/JAN 14, 2 and 5 digit extensions
	Interleaved 2 of 5
	MSI/Plessey
	FIM/POSTNET
	UPC-A, 2 and 5 digit extensions
	UPC-E, 2 and 5 digit extensions
	QR Code
	MaxiCode
	PDF 417
	Aztec
	DataMatrix (using ZPL emulation)
RSS (Reduced Space Symbology®): RSS-14 Truncated RSS-14 Stacked RSS-14 Stacked Omnidirectional RSS Limited RSS Expanded	
TLC-39/Micro PDF	
Rotation Angles	0°, 90°, 180°, and 270°
Fonts Available	Standard Fonts: 25 bit-mapped fonts; 1 scalable (CG Trimvirate Bold Condensed*) Downloadable optional bit-mapped & scalable fonts via Label Vista software International character sets: Chinese 16 x 16 (trad.), 16 x 16 (simplified), 24 x 24 (simplified); Japanese 16 x 16, 24 x 24 Korean Myang 16 x 16 Greek Hebrew/Arabic

**Contains UFST from Agfa Monotype Corporation*

**Contains UFST from Agfa Monotype Corporation*

RP4T Printers	Manual Introduction
Maintenance	P4T Overview
Troubleshooting	Printer Preparation
Specifications	Connecting the Printer
Appendices	Radio Regulatory Information
Index	

Physical/Environmental/Electrical Specifications

P4T Series	
Weight w/ battery, and TT ribbon excluding media and radio option	2.9 lbs. (1,32 Kg.)
Operating Temperature	Direct Thermal: -4 °F to 122 °F (-20 °C to 50 °C) Thermal Transfer: 32 °F to 113 °F (0 °C to 45 °C)
Charging Temperature	32 °F to 104 °F (0°C to 40 °C)
Storage Temperature	-22 °F to 149 °F (-30 °C to 65 °C)
Relative Humidity	Operating: 10% to 90% (non-condensing)
	Storage: 10% to 90% (non-condensing)
Battery	7.4V Lithium-Ion 4.2 Ahr.
Intrusion Protection (IP) Rating	14 (54 w/ optional soft case)

Figure 20-P4T Series Overall Dimensions

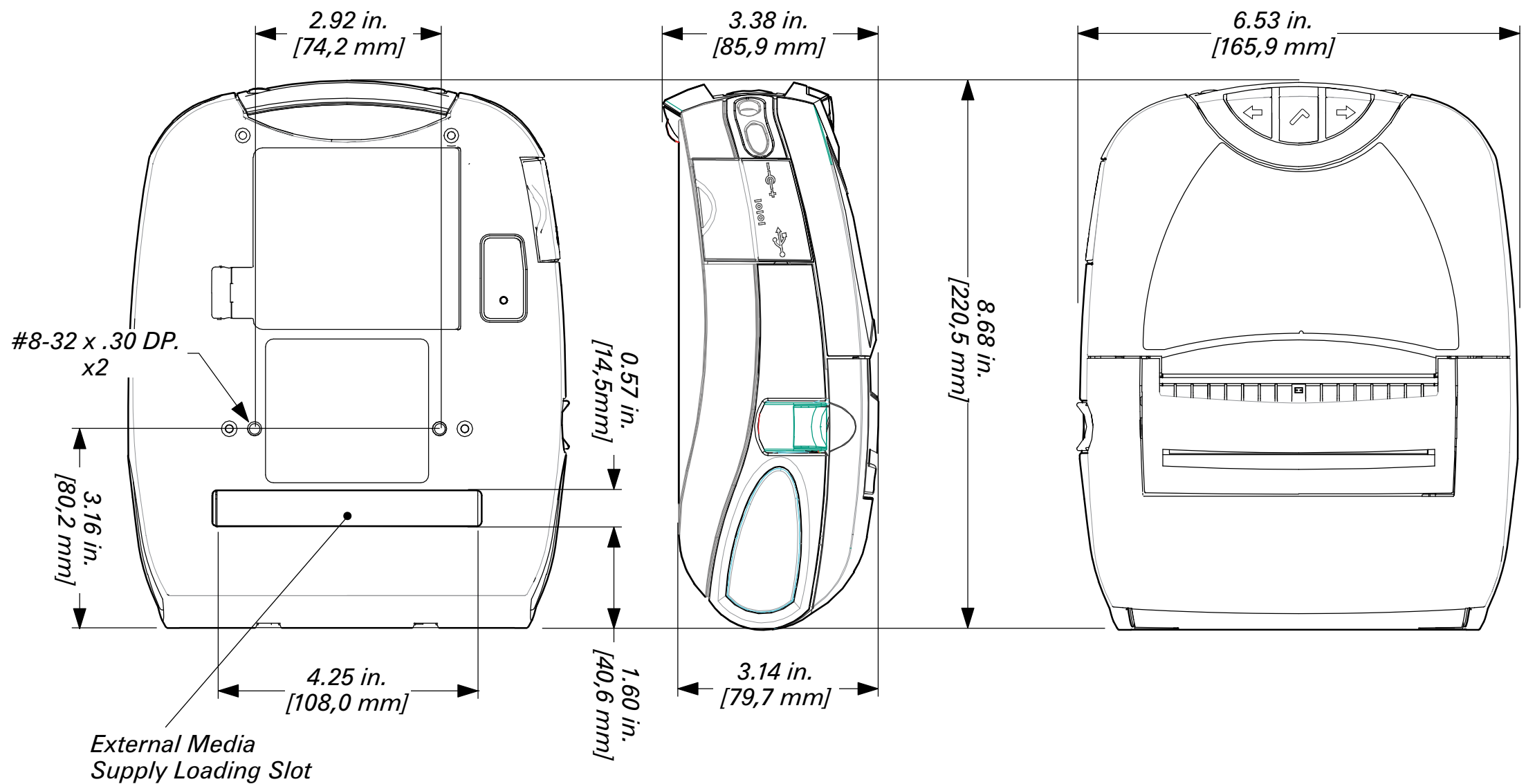

Manual Introduction	RP4T Printers
P4T Overview	Maintenance
Printer Preparation	Troubleshooting
Connecting the Printer	Specifications
Radio Regulatory Information	Appendices
	Index

Appendix A

Interface Cables

RS232 Download Cable

Part Number AK17463-008; RW Mod Plug to 9-Pin DB PC Cable

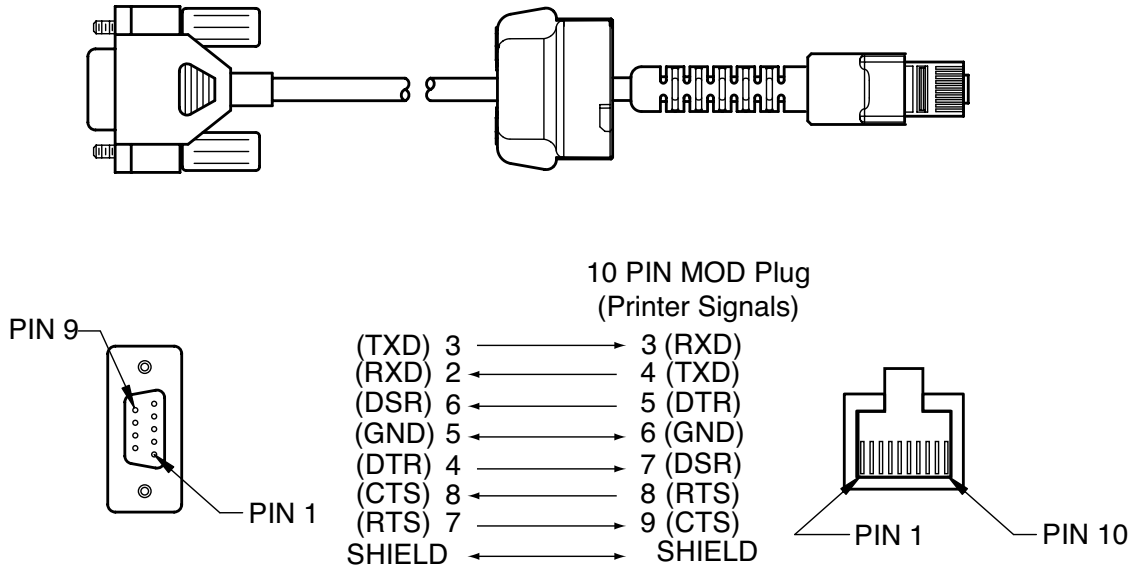

USB Download Cable

Part Number AK18666-1; RW Mod Plug to USB A Cable

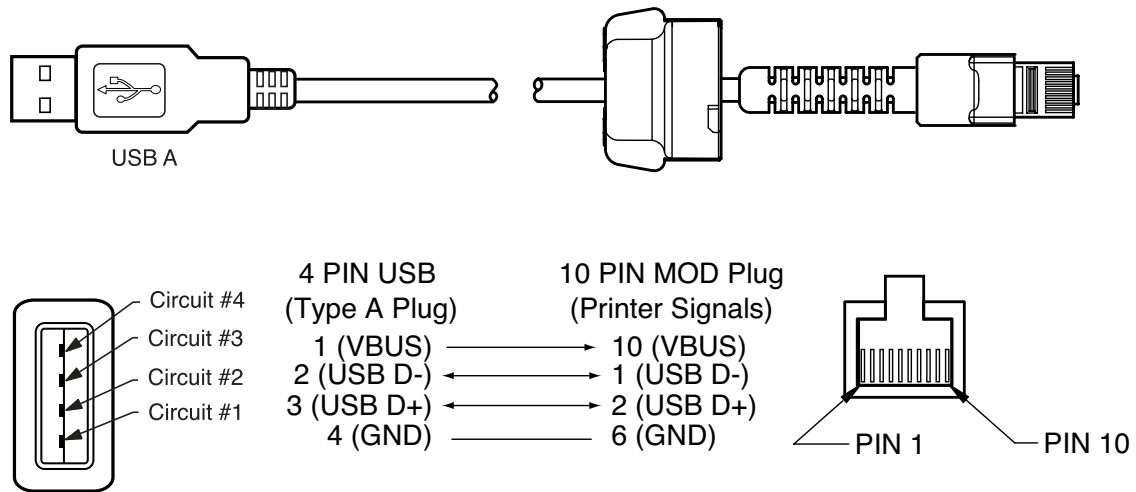

USB Cable

Part Number AT17010-1; USB A to USB Mini B Cable

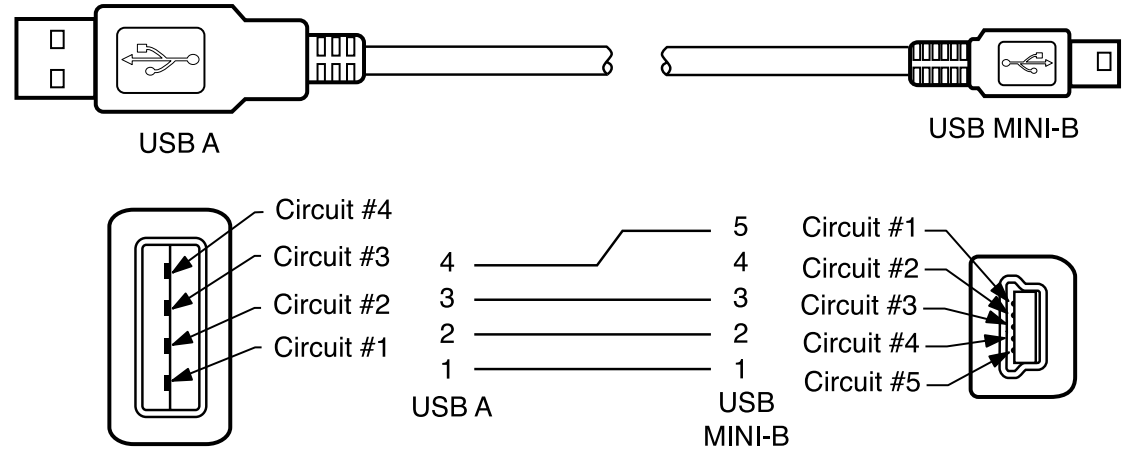

Contact the Factory or your Zebra Sales Representative for more information on interface cables to most major manufacturer's data terminals.

You may also visit the Zebra Web site at www.zebra.com for a listing of interface cables for all series of Zebra mobile printers

RP4T Printers	Manual Introduction
Maintenance	P4T Overview
Troubleshooting	Printer Preparation
Specifications	Connecting the Printer
Appendices	Radio Regulatory Information
Index	

Appendix B

Media Supplies

To insure maximum printer life and consistent print quality and performance for your individual application, it is recommended that only media produced by Zebra be used.

Advantages include:

- Consistent quality and reliability of media products.
- Large range of stocked and standard formats.
- In-house custom format design service.
- Large production capacity which services the needs of many large and small media consumers including major retail chains world wide.
- Media products that meet or exceed industry standards.

For more information about standard or custom media contact your re-seller or Zebra Technologies Corporation at +1.866.230.9495 (U.S., Canada and Mexico) and ask to speak to a Media Sales Representative.

Appendix C

Maintenance Supplies

In addition to using quality media provided by Zebra, it is recommended that the printer be cleaned as prescribed in the Maintenance section. The following items are available for this purpose:

- Cleaning Pen (12 pack), Reorder No. AN11209-1
- Cleaning Kit with Cleaning Pen, and Cotton Swabs, Reorder No. AT702-1

Manual Introduction	RP4T Printers
P4T Overview	Maintenance
Printer Preparation	Troubleshooting
Connecting the Printer	Specifications
Radio Regulatory Information	Appendices
	Index

Appendix D

Product Support

When calling with a specific problem regarding your printer, please have the following information on hand:

- Model number/type (e.g. P4T, RP4T)
- Unit serial number
- Product Configuration Code (PCC)

For on-line product support and the most recent versions of downloadable user documentation, firmware and software utilities, go to the Zebra Web site: www.zebra.com

In the Americas, contact

Regional Headquarters	Technical Support	Customer Service Dept
Zebra Technologies International, LLC 333 Corporate Woods Parkway Vernon Hills, Illinois 60061-3109 U.S.A T: +1 847 793 2600 Toll-free +1 800 423 0422 F: +1 847 913 8766	T: +1 847 913 2259 F: +1 847 913 2578 Hardware: ts1america@zebra.com Software: ts3america@zebra.com	For printers, parts, media, and ribbon, please call your distributor, or contact us. T: +1 877 275 9327 E: clientcare@zebra.com

In Europe, Africa, the Middle East, and India, contact

Regional Headquarters	Technical Support	Internal Sales Dept.
Zebra Technologies Europe Limited Zebra House The Valley Centre, Gordon Road High Wycombe Buckinghamshire HP13 6EQ, UK T: +44 (0)1494 472872 F: +44 (0) 1494 450103	T: +44 (0) 1494 768298 F: +44 (0) 1494 768210 Germany: Tsgermany@zebra.com France: Tsfrence@zebra.com Spain/ Portugal: Tsspain @zebra.com All other areas: Tseurope@zebra.com	For printers, parts, media, and ribbon, please call your distributor, or contact us T: +44 (0) 1494 768316 F: +44 (0) 1494 768244 E: cseurope@zebra.com

In the Asia Pacific region, contact

Regional Headquarters	Technical Support	Customer Service
Zebra Technologies Asia Pacific, LLC Go to www.zebra.com/contact for complete contact information T: +65 6858 0722 F: +65 6885 0838	T: +65 6858 0722 F: +65 6885 0838 E: (China): tschina@zebra.com All other areas: tsasiapacific@zebra.com	For printers, parts, media, and ribbon, please call your distributor, or contact us T: +65 6858 0722 F: +65 6885 0836 E: (China) order-csr@zebra.com All other areas: csasiapacific@zebra.com

Serial and PCC Number Locations for P4T Series Printers

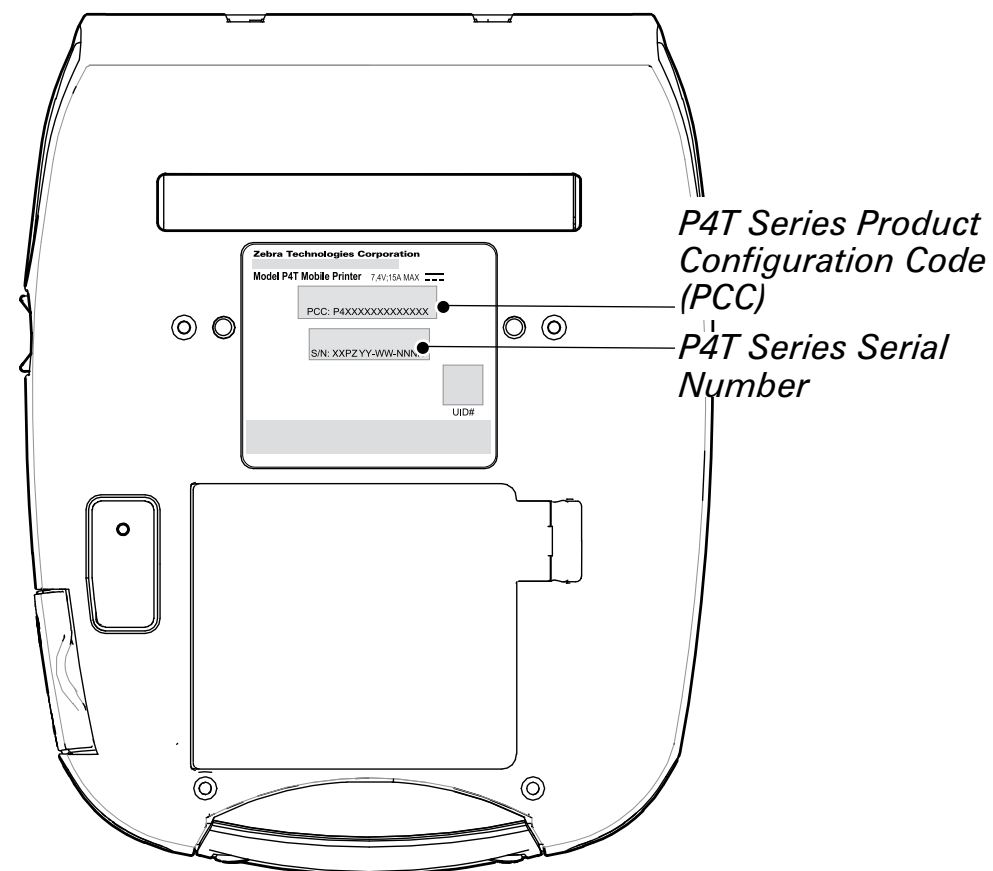

RP4T Printers	Manual Introduction
Maintenance	P4T Overview
Troubleshooting	Printer Preparation
Specifications	Connecting the Printer
Appendices	Radio Regulatory Information
Index	

Appendix E

Battery Disposal



The EPA certified RBRC® Battery Recycling Seal on the Lithium-Ion (Li-ion) battery supplied with your printer indicates Zebra Technologies Corporation is voluntarily participating in an industry program to collect and recycle these batteries at the end of their useful life, when taken out of service in the United States or Canada. The RBRC program provides a convenient alternative to placing used Li-ion batteries into the trash or the municipal waste stream, which may be illegal in your area.



Insulate depleted battery terminals with tape before disposal.

Please call +1 800 8BATTERY for information on Li-ion battery recycling and disposal bans or restrictions in your area. Zebra Technologies Corporation's involvement in this program is part of our commitment to preserving our environment and conserving our natural resources.

Outside North America, please follow local battery recycling guidelines.

Product Disposal



Do not dispose of this product in unsorted municipal waste. This product is recyclable. Please recycle according to your local standards. For more information, please see our web

site at: <http://www.zebra.com/environment>

Manual Introduction	RP4T Printers
P4T Overview	Maintenance
Printer Preparation	Troubleshooting
Connecting the Printer	Specifications
Radio Regulatory Information	Appendices
	Index

Appendix F

Using zebra.com

The following examples use the search functions on Zebra's Web site for finding specific documents .

Example1: Find the Mobile Printer Wireless Configuration Guide.

Go to www.zebra.com/manuals.

Select as a manual type "Networking Manual" then click on "Submit".

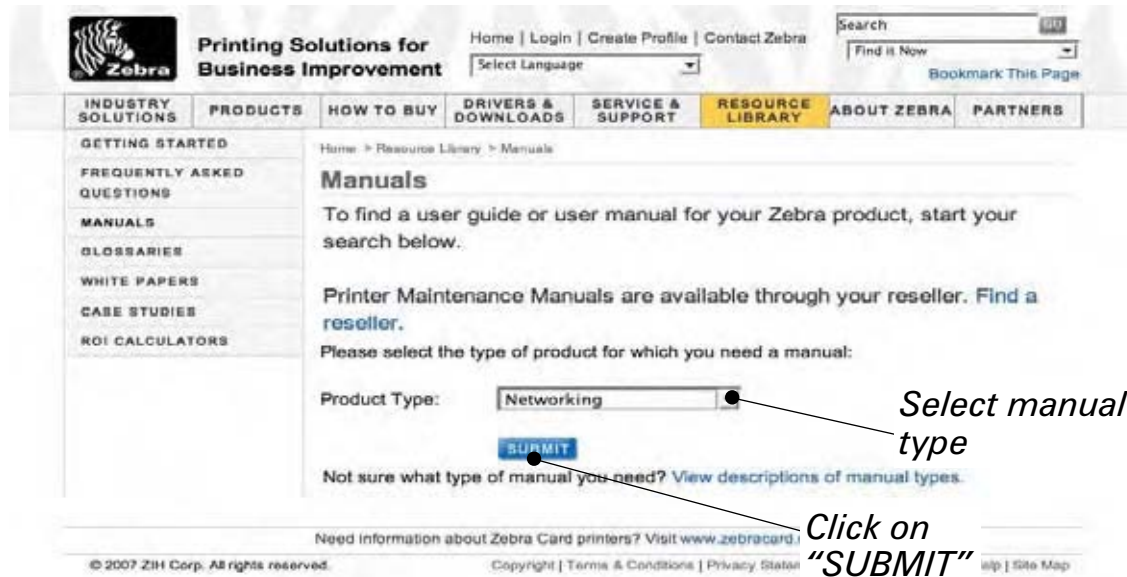

At the resulting screen, select *Wireless Mobile* as the networking type. Then select the desired language. (Best choices are "All" or "English")

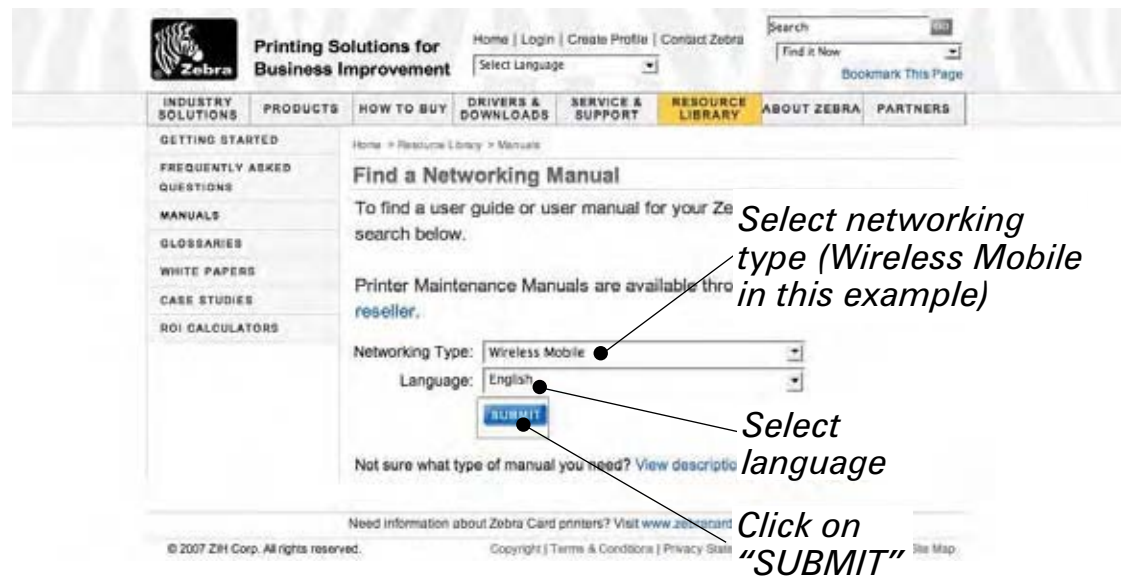

At the resulting screen, select "Zebra Mobile Printers - Wireless Configuration Guide" then click on "Download" to begin the download process.

Example 2: Find the Label Vista Download page:

Go to www.zebra.com/software and select "Label Vista", then click "Submit".

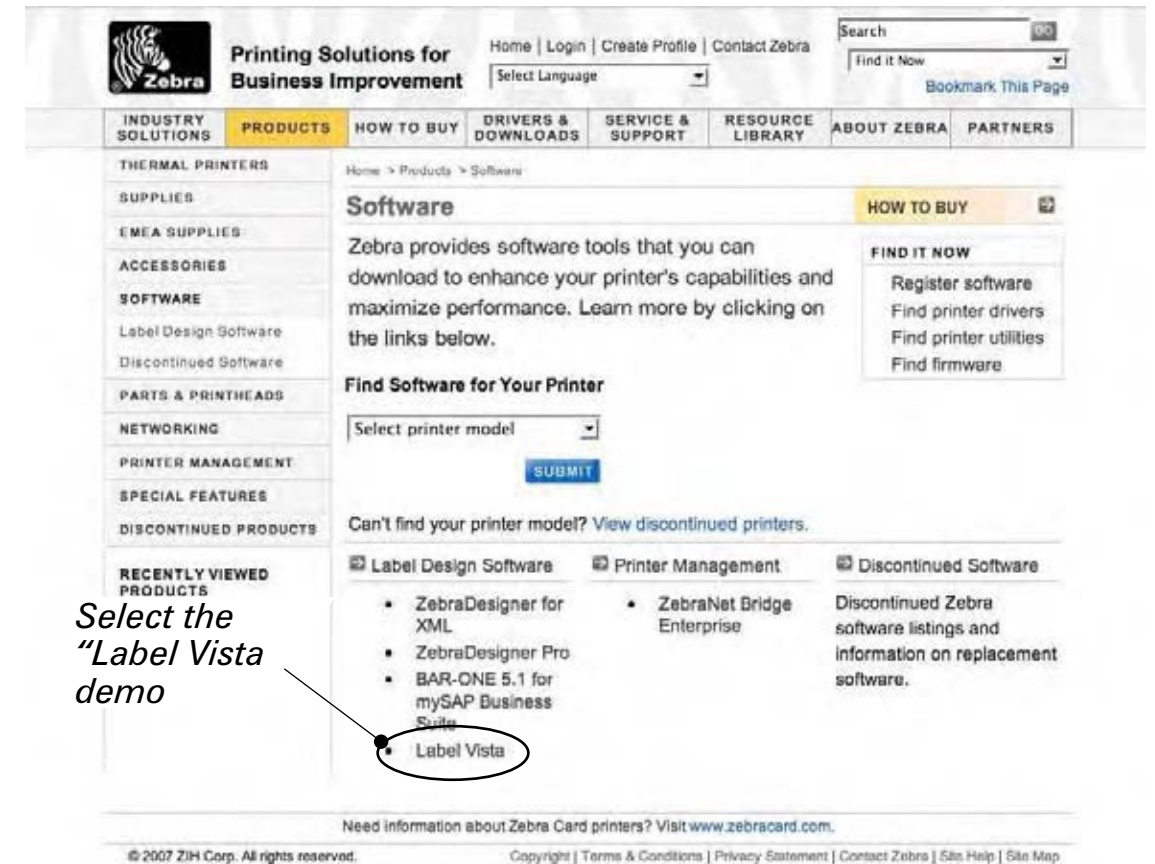

At the resulting window select "Download a free Label Vista demo now "

Appendix G- Patents

This product and/or its use may be covered by one or more of the following US patents and corresponding international patents worldwide

D275,286	5,113,445	5,399,846	5,726,630	6,261,009
D347,021	5,140,144	5,408,081	5,768,991	6,261,013
D389,178	5,132,709	5,410,139	5,790,162	6,267,521
D430,199	5,142,550	5,410,140	5,791,796	6,270,072 B1
D433,702	5,149,950	5,412,198	5,806,993	6,285,845 B1
D549,768	5,157,687	5,415,482	5,813,343	6,292,595
3,964,673	5,168,148	5,418,812	5,816,718	6,296,032
4,019,676	5,168,149	5,420,411	5,820,279	6,364,550
4,044,946	5,180,904	5,436,440	5,848,848	6,379,058 B1
4,360,798	5,229,591	5,444,231	5,860,753	6,409,401 B1
4,369,361	5,230,088	5,449,891	5,872,585	6,411,397 B1
4,387,297	5,235,167	5,449,893	5,874,980	6,428,227 B2
4,460,120	5,243,655	5,468,949	5,909,233	6,480,143
4,496,831	5,247,162	5,479,000	5,976,720	6,530,705
4,593,186	5,250,791	5,479,002	5,978,004	6,540,122
4,607,156	5,250,792	5,479,441	5,995,128	6,540,142
4,673,805	5,262,627	5,486,057	5,997,193	6,607,316
4,736,095	5,267,800	5,503,483	6,004,053	6,609,844
4,758,717	5,280,163	5,504,322	6,010,257	6,655,593
4,816,660	5,280,164	5,519,381	6,020,906	6,784,787
4,845,350	5,280,498	5,528,621	6,034,708	6,874,958
4,896,026	5,304,786	5,532,469	6,036,383	6,899,477
4,897,532	5,304,788	5,543,610	6,057,870	6,908,034
4,923,281	5,321,246	5,545,889	6,068,415	7,126,716
4,933,538	5,335,170	5,552,592	6,068,415	7,137,000
4,992,717	5,364,133	5,570,123	6,095,704	7,172,122
5,015,833	5,367,151	5,578,810	6,109,801	7,190,270
5,017,765	5,372,439	5,589,680	6,123,471	
5,021,641	5,373,148	5,612,531	6,147,767	
5,029,183	5,378,882	5,642,666	6,151,037	
5,047,617	5,396,053	5,657,066	6,201,255 B1	
5,103,461	5,396,055	5,680,459	6,231,253 B1	

RP4T Printers	Manual Introduction
Maintenance	P4T Overview
Troubleshooting	Printer Preparation
Specifications	Connecting the Printer
Appendices	Radio Regulatory Information
Index	

Index

B

- Battery pack
 - installing 12
 - life, tips for extending 32
 - reconditioning 18
 - Smart Battery, features 6

C

- Cable Communications 23
 - Combination Port 23
 - USB 24
- Charger, battery
 - AC Adapter 10
 - LI72 single charger 8
 - AT17696-xx 9
 - List of approved 8
 - UCLI72-4 Quad Charger 11
 - battery charge times 11
 - indicators 11

Cleaning

- general instructions 32
- methods & intervals
 - table of 33

Communications, Wireless

- 802.11 b/g 26
- Bluetooth 26

Controls, Operator

- functions illustrated 18
- LCD functions, extended 19

E

- Encoder option
 - RFID 5, 6

L

- Label, Configuration 22
 - use as a diagnostic tool 22

Label Vista

- setting WLAN parameters with 26

M

Manual

- CPCL Programming 26
- RFID Programming Guide 31
- Wireless Configuration Guide 25

Media, loading

- adjusting for core diameter 16
- external media
 - media Spacer, use of 14
- Internal roll 13
- thermal transfer film 17
- use of label peeler 15
- using external supply 14

P

P4T Media 40

Printing Method

- Direct Thermal 6
- thermal transfer
 - Loading thermal transfer film 17
- Thermal Transfer 6
 - thermal transfer film 6

Programming language

- CPCL 4
- ZPL II 4, 31

R

Radio Regulatory Information

- 802.11b/g Radio 27
 - Republic of China 28
- Bluetooth radio (ZBR4) 27
- Co-located 802.11b & Bluetooth 26, 29
- RFID Encoder 30

RFID

- label types supported 31
- Model RP4T 6

S

Safety

- Battery 7
- Charger 7

Shoulder Strap, Adjustable 21

Specifications

- Font/bar Codes 41
- Media 40
- Memory/communications 39
 - communications ports 39
- Physical 41
 - overall dimensions 41
- printing 39

T

Technical Support

- contacting 36

Troubleshooting

- entering communications diagnostic mode 36
- forced shutdown 36
- LCD Control Panel 34
- printing a configuration label 22, 36, 37, 38

Troubleshooting Topics 34



Zebra Technologies International, LLC

333 Corporate Woods Parkway

Vernon Hills, Illinois 60061-3109 USA

Phone: +1.847.634.6700

Toll-Free: +1.800.423.0422

Fax: +1.847.913.8766

Manual Introduction	RP4T Printers
P4T Overview	Maintenance
Printer Preparation	Troubleshooting
Connecting the Printer	Specifications
Radio Regulatory Information	Appendices
	Index

Wireless Communications

Wireless Communications with Bluetooth®

“Bluetooth” is a worldwide standard for the exchange of data between two devices via radio frequencies. Bluetooth radios are relatively low powered to help prevent interference with other devices running at similar radio frequencies. This limits the range of a Bluetooth device to about 10 meters (about 32 feet).

Both the printer and the device it communicates with must follow the Bluetooth standard.

Bluetooth Networking Overview

Each Bluetooth enabled P4T series printer has a unique Bluetooth Device Address (BDA) loaded into its radio module when manufactured.

Bluetooth software is always running in the background, ready to respond to connection requests. One device (known as the master or the client) must request a connection with another. The second device (the slave or the server) then accepts or rejects the connection. A Bluetooth enabled P4T series printer will normally act as a slave creating a miniature network with the terminal sometimes referred to as a “piconet.”

For the most part, communications using Bluetooth are initiated and processed without any operator intervention.

P4T Series printers can be equipped with both a Bluetooth and an 802.11b/g radio, allowing communications with both Bluetooth enabled devices and a Wireless Local Area Network (WLAN) (see discussion below).

Wireless Local Area Network Overview

P4T Series printers can be equipped with several radio options which use the industry standard 802.11b or g WLAN protocols.

- P4T Series Wireless Network Printers with the Zebra 802.11b/g WLAN radio module can be identified by the Product Configuration Code (PCC) on the serial number label on the back of the printer. Printers with this option will have a “K” as the seventh character of the PCC Code. Printers with this option may also be identified by the FCC ID: I28-PLAN11BG, or the Industrie Canada ID: 3798B-PLAN11BG on printers built for the North American region.
- P4T printers with both an 802.11b/g WLAN radio and a Bluetooth radio running in the same unit are considered to be dual radio devices. Printers with this option will have an “A” as the seventh character of the PCC Code.



RP4T model printers cannot be configured with the 802.11g/Bluetooth dual radio option.

Such dual radio equipped P4T units will have an FCC ID: I28-ZB4LAN-01 and an Industrie Canada ID: 3798B-ZB4LAN01. The FCC and IC ID numbers and other regulatory information for this radio configuration are also located on the serial number label of printers built for the North American region.



Refer to Appendix D of this manual for more information on locating the Product Configuration Code.

Printers equipped with either of the 802.11b/g radio options allow wireless communication as a node within a WLAN and its wireless capabilities allow communications from any point within the WLAN’s perimeter. P4T printers equipped with the dual Bluetooth/802.11b/g WLAN radio configuration can be linked to both a WLAN and a Bluetooth network simultaneously.

Methods of establishing communications to P4T Series printers will vary with each LAN application. General information on establishing WLAN communications can be found in either the “CPCL Programmers Manual” or the “Quick Start Guide for Mobile Wireless Printers” both available on-line at the Zebra Web site www.zebra.com/manuals. More information and LAN configuration utilities may also be found in Zebra’s Label Vista™ program (version 2.8 and later). The latest version of Label Vista may be downloaded from Zebra’s Web site.

Setting Up the Software

P4T Series printers use Zebra’s CPCL Programming language which was designed for mobile printing applications. CPCL is fully described in the “CPCL Programmers Manual”, available on-line at the Zebra Web site.

You can also use Label Vista™, Zebra’s Windows based label creation program which uses a graphical interface to create and edit labels in the CPCL language.

All P4T Series printers support an interpreter for the ZPL II programming language. RP4T printers (with RFID encoding/reading capabilities) use the ZPL programming language’s extensive set of RFID commands.

If you plan to use ZPL II, refer to the appropriate Programming Guides available on-line from Zebra’s Web site.

If you have a printer with wireless capabilities, you can refer to the “Wireless Configuration Guide.” also available on the Zebra web site.

If you choose to use a third party label preparation system, follow the installation instructions included in the package.

Manual Introduction	RP4T Printers
P4T Overview	Maintenance
Printer Preparation	Troubleshooting
Connecting the Printer	Specifications
Radio Regulatory Information	Appendices
Index	

Radio Regulatory Information

Bluetooth ZBR4 Radio

The following section only applies when the Bluetooth ZBR4 module is installed in a P4T series printer. This radio configuration has demonstrated compliance to FCC regulations. P4T series printers with this configuration sold in North America will have the FCC ID: I28-MD-ZBR4WA and the Industrie Canada ID: 3798B-ZBR4WA for this radio module on a label on the back of the printer.



Caution • Exposure to Radio Frequency Radiation.

The radiated output power of this internal Bluetooth radio is far below the FCC radio frequency exposure limits. The internal Bluetooth radio operates within guidelines found in radio frequency safety standards and recommendations. Do not use the printer in an unauthorized manner.



Note • The following section only applies when the ZBR4 Bluetooth Radio is installed in a P4T Series printer. Unless specified elsewhere in this manual, the antenna used for this transmitter must not be co-located or must not operate in conjunction with any other antenna.

European Regulatory Information for the ZBR4 Bluetooth Radio

This device is intended for use in all EU and EFTA member states.

Europe – EU Declaration of Conformity

This device complies with the essential requirements of the R&TTE Directive 1999/5/EC. The following test methods have been applied in order to prove presumption of compliance with the R&TTE Directive 1999/5/EC:

- EN 60950: 2000 Safety of Information Technology Equipment
- EN 300 328-2 V1.4.1 (2003-04) Technical requirements for spread-spectrum radio equipment
- EN 301 489-1/-17 V1.4.1/1.2.1 (2002-08) EMC requirements for spread-spectrum radio equipment.

This device is a 2.4 GHz wireless LAN transceiver, intended for indoor home and office use in all EU and EFTA member states.



Important Notice:

This device is a portable RF printer intended for commercial and industrial use in all EU and EFTA member states.

WLAN Module Using 802.11b/g Radio

The following section only applies when the 802.11b/g WLAN module is installed in a P4T series printer. Other than conditions specified elsewhere in this manual, only one of the radio options can be installed in the printer at one time and the antenna used for these transmitters must not be co-located or must not operate in conjunction with any other antenna.

P4T Series printers for sale in North America will have the 802.11b/g radio FCC ID: I28-PLAN11BG, and the Industrie Canada ID: 3798B-PLAN11BG printed on a label on the back of the unit.



Caution • The radiated output power of this internal 802.11b/g WLAN radio is far below the FCC radio frequency exposure limits. The internal radio operates within guidelines found in radio frequency safety standards and recommendations. Do not use the printer in an unauthorized manner.

European Regulatory Information for this Radio

AT	BE	CY	CZ	DK
EE	FI	FR	DE	GR
HU	IE	IT	LV	LT
LU	MT	NL	PL	PT
SK	SI	ES	SE	GB

Note: -Member states in the EU with restrictive use for this device are crossed out!

This device is also authorized for use in all EFTA member states (CH, IS, LI, NO)



Important Notice:

This device is a portable RF printer intended for commercial and industrial use in all EU and EFTA member states except in France where restrictive use applies

Manual Introduction	RP4T Printers
P4T Overview	Maintenance
Printer Preparation	Troubleshooting
Connecting the Printer	Specifications
Radio Regulatory Information	Appendices
Index	

Europe – EU Declaration of Conformity

This device complies with the essential requirements of the R&TTE Directive 1999/5/EC. The following test methods have been applied in order to prove presumption of compliance with the R&TTE Directive 1999/5/EC:

- EN55022:1998
- European Emissions Standard
 - EN 60950: 2000
- Safety of Information Technology Equipment
 - EN 300 328-2 V1.2.1 (2001-12)
- Technical requirements for spread-spectrum radio equipment
 - EN 301 489-17 V1.2.1 (2002-08)

EMC requirements for spread-spectrum radio equipment.

This device is a 2.4 GHz wireless LAN transceiver, intended for indoor home and office use in all EU and EFTA member states, except in France where restrictive use applies.

The use of this frequency band in France is subject to restrictions. You may only use channels 10 and 11 (2457 and 2462 MHz) on French territory, except in those French departments as listed in the table below where channels 1-13 (2412-2472 MHz) may be used. For more information see <http://www.anfr.fr/> and/or <http://www.art-telecom.fr>

01	Ain	36	Indre	69	Rhone
02	Aisne	37	Indre et Loire	70	Haute Saone
03	Allier	39	Jura	71	Saone et Loire
05	Hautes Alpes	41	Loir et Cher	72	Sarthe
08	Ardennes	42	Loire	75	Paris
09	Ariege	45	Loiret	77	Seine et Marne
10	Aube	50	Manche	78	Yvelines
11	Aude	54	Meurthe et Moselle	79	Deux Sievres
12	Aveyron	55	Meuse	82	Tarn et Garonne
16	Charente	57	Moselle	84	Vaucluse
19	Correze	58	Nievre	86	Vienne
2A	Corse Sud	59	Nord	88	Vosges
2B	Haute Corse	60	Oise	89	Yonne
21	Cote d'Or	61	Orne	90	Territoire de Belfort
24	Dordogne	63	Puy de Dome	91	Essonne
25	Doubs	64	Pyrenees Atlantique	92	Hauts de Seine
26	Drome	65	Hautes Pyrenees	93	Seine St Denis
27	Eure	66	Pyrenees Orientales	94	Val de Marne
32	Gers	67	Bas Rhin		
35	Ille et Vilaine	68	Haute Rhin		

Republic of China Regulatory Information for the 802.11b/g Radio

經型式認證合格之低功率射頻電機,非經許可,公司、商號或使用者均不得擅自變更頻率、加大功率或變更原設計之特性及功能。低功率射頻電機之使用不得影響飛航安全及干擾合法通信;經發現有干擾現象時,應立即停用,並改善至無干擾時方得繼續使用。前項合法通信,指依電信法規定作業之無線電通信。低功率射頻電機須忍受合法通信或工業、科學及醫療用電波輻射性電機設備之干擾。

According to “Administrative Regulations on Low Power Radio Waves Radiated Devices” Without permission granted by the DGT, any company, enterprise, or user is not allowed to change frequency, enhance transmitting power or alter original characteristic as well as performance to a approved low power radio-frequency devices. The low power radio-frequency devices shall not influence aircraft security and interfere legal communications; If found, the user shall cease operating immediately until no interference is achieved. The said legal communications means radio communications is operated in compliance with the Telecommunications Act.

The low power radio-frequency devices must be susceptible with the interference from legal communications or ISM radio wave radiated devices.

Manual Introduction	RP4T Printers
P4T Overview	Maintenance
Printer Preparation	Troubleshooting
Connecting the Printer	Specifications
Radio Regulatory Information	Appendices
Index	

802.11b/g and Bluetooth Co-located Radio Modules

The following section only applies when the CF (Compact Flash) WLAN module and Bluetooth ZBR4 module are installed in a P4T printer. This co-located radio configuration has demonstrated compliance to FCC regulations. P4T printers with this configuration sold in North America will have the FCC ID: I28-ZB4LAN-01 and the Industrie Canada ID: 3798B-ZB4LAN01 for this radio configuration printed on a label on the back of the printer.



Caution • Use of a P4T printer with the co-located ZBR4 Bluetooth radio module and the 802.11b/g WLAN radio module meets the FCC requirements for radio frequency (RF) radiation exposure in the standard body worn configuration with no minimum separation. In this configuration, which applies whether the belt clip or shoulder strap is used, the face of the printer from which paper is transported is facing away from the user's body. The standard configuration must always be used when the printer is body worn.



The radiated output power of this radio configuration is far below the FCC radio frequency exposure limits. Both the internal Bluetooth and the 802.11b/G radio operate within guidelines found in radio frequency safety standards and recommendations. Do not use the printer in an unauthorized manner.

RP4T printers are not configured with this radio option.

European Regulatory Information for the Compact Flash 802.11b Radio and Bluetooth Co-located Radio Modules

AT	BE	CY	CZ	DK
EE	FI	FR	DE	GR
HU	IE	IT	LV	LT
LU	MT	NL	PL	PT
SK	SI	ES	SE	GB

Note: -Member states in the EU with restrictive use for this device are crossed out!
This device is also authorized for use in all EFTA member states (CH, IS, LI, NO)

Europe – EU Declaration of Conformity

This device complies with the essential requirements of the R&TTE Directive 1999/5/EC. The following test methods have been applied in order to prove presumption of compliance with the R&TTE Directive 1999/5/EC:

- EN 60950: 2000

Safety of Information Technology Equipment

- EN 300 328-2 V1.2.1 (2001-12)

Technical requirements for spread-spectrum radio equipment

- EN 301 489-17 V1.2.1 (2002-08)

EMC requirements for spread-spectrum radio equipment.

This device is a 2.4 GHz wireless LAN transceiver, intended for indoor home and office use in all EU and EFTA member states, except in France where restrictive use applies.

The use of this frequency band in France is subject to restrictions. You may only use channels 10 and 11 (2457 and 2462 MHz) on French territory, except in those French departments as listed in the table below where channels 1-13 (2412-2472 MHz) may be used. For more information see <http://www.anfr.fr/> and/or <http://www.art-telecom.fr>

01	Ain	36	Indre	69	Rhone
02	Aisne	37	Indre et Loire	70	Haute Saone
03	Allier	39	Jura	71	Saone et Loire
05	Hautes Alpes	41	Loir et Cher	72	Sarthe
08	Ardennes	42	Loire	75	Paris
09	Ariege	45	Loiret	77	Seine et Marne
10	Aube	50	Manche	78	Yvelines
11	Aude	54	Meurthe et Moselle	79	Deux Sievres
12	Aveyron	55	Meuse	82	Tarn et Garonne
16	Charente	57	Moselle	84	Vaucluse
19	Correze	58	Nievre	86	Vienne
2A	Corse Sud	59	Nord	88	Vosges
2B	Haute Corse	60	Oise	89	Yonne
21	Cote d'Or	61	Orne	90	Territoire de Belfort
24	Dordogne	63	Puy de Dome	91	Essonne
25	Doubs	64	Pyrenees Atlantique	92	Hauts de Seine
26	Drome	65	Hautes Pyrenees	93	Seine St Denis
27	Eure	66	Pyrenees Orientales	94	Val de Marne
32	Gers	67	Bas Rhin		
35	Ille et Vilaine	68	Haute Rhin		

Manual Introduction	RP4T Printers
P4T Overview	Maintenance
Printer Preparation	Troubleshooting
Connecting the Printer	Specifications
Radio Regulatory Information	Appendices
Index	

RFID Encoder

The following section only applies when the RFID encoder is installed in an RP4T printer. The RFID encoder may be installed in conjunction with either the Bluetooth or 802.11g radio options detailed previously, but may not be installed with the Bluetooth/802.11g dual radio option.

RP4T Series printers will have the fifth character of the Product Configuration Code (PCC), which determines country compatibility for the RFID encoder, per the following table:

RFID option	PCC digit "5"	Printer Model
No RFID	0	P4T
US	U	RP4T
EU	1	RP4T
Australia	2	RP4T
Taiwan	6	RP4T
New Zealand	8	RP4T
Brazil	9	RP4T
China	A	RP4T
Malaysia	B	RP4T
Phillipines	C	RP4T
India	D	RP4T
El Salvador	E	RP4T
Isreal	F	RP4T
Japan	G	RP4T
Korea	H	RP4T

The following table lists FCC and Industrie Canada ID numbers for the various configurations of RP4T printer radio options.

Configuration	FCC ID:	Industrie Canada ID:
RFID Encoder	I28RFID-M5ECZ-01	3798B-M5ECZ01
RFID Encoder & 801.11b/G Radio)	I28RFID-R4LANG-01	3798B-R4LANG01
RFID Encoder & BT2.0 Radio	I28RFID-M5ZBR4-01	3798B-M5ZBR401:



Caution • Exposure to Radio Frequency Radiation.

The radiated output power of this RFID encoder is far below the FCC radio frequency exposure limits. The RFID encoder operates within guidelines found in radio frequency safety standards and recommendations. Do not use the printer in an unauthorized manner.