



# FCC RADIO TEST REPORT

**FCC ID** : I28-WYSBHVDXP  
**Equipment** : WLAN/BTLE module  
**Brand Name** : ZEBRA  
**Model Name** : WYSBHVDXP  
**Applicant** : Zebra Technologies Corporation  
3 Overlook Point, Lincolnshire, IL  
60069, United States  
**Manufacturer** : Zebra Technologies Corporation  
3 Overlook Point, Lincolnshire, IL  
60069, United States  
**Standard** : FCC Part 15 Subpart C §15.247

The product was received on Mar. 08, 2021 and testing was started from Mar. 15, 2021 and completed on Apr. 27, 2021. We, Sporton International Inc. Wensan Laboratory, would like to declare that the tested sample has been evaluated in accordance with the test procedures and has been in compliance with the applicable technical standards.

The test results in this report apply exclusively to the tested model / sample. Without written approval of Sporton International Inc. Wensan Laboratory, the test report shall not be reproduced except in full.

Approved by: Louis Wu

**Sporton International Inc. Wensan Laboratory**

No.58, Aly. 75, Ln. 564, Wenhua 3rd, Rd., Guishan Dist., Taoyuan City 333010, Taiwan (R.O.C.)



## Table of Contents

History of this test report.....	3
Summary of Test Result.....	4
<b>1 General Description.....</b>	<b>5</b>
1.1 Product Feature of Equipment Under Test.....	5
1.2 Product Specification of Equipment Under Test.....	5
1.3 Modification of EUT .....	6
1.4 Testing Location .....	6
1.5 Applicable Standards.....	6
<b>2 Test Configuration of Equipment Under Test.....</b>	<b>7</b>
2.1 Carrier Frequency Channel .....	7
2.2 Test Mode.....	8
2.3 Connection Diagram of Test System.....	9
2.4 Support Unit used in test configuration and system .....	10
2.5 EUT Operation Test Setup .....	11
2.6 Measurement Results Explanation Example.....	11
<b>3 Test Result.....</b>	<b>12</b>
3.1 6dB and 99% Bandwidth Measurement .....	12
3.2 Output Power Measurement.....	19
3.3 Power Spectral Density Measurement .....	21
3.4 Conducted Band Edges and Spurious Emission Measurement .....	27
3.5 Radiated Band Edges and Spurious Emission Measurement .....	33
3.6 AC Conducted Emission Measurement.....	37
3.7 Antenna Requirements.....	39
<b>4 List of Measuring Equipment .....</b>	<b>40</b>
<b>5 Uncertainty of Evaluation.....</b>	<b>42</b>
<b>Appendix A. AC Conducted Emission Test Result</b>	
<b>Appendix B. Radiated Spurious Emission</b>	
<b>Appendix C. Radiated Spurious Emission Plots</b>	
<b>Appendix D. Duty Cycle Plots</b>	
<b>Appendix E. Setup Photographs</b>	



### History of this test report

Report No.	Version	Description	Issued Date
FR0D2423B	01	Initial issue of report	May 05, 2021



### Summary of Test Result

Report Clause	Ref Std. Clause	Test Items	Result (PASS/FAIL)	Remark
3.1	15.247(a)(2)	6dB Bandwidth	Pass	-
3.1	2.1049	99% Occupied Bandwidth	Reporting only	-
3.2	15.247(b)(3)	Output Power	Pass	-
3.3	15.247(e)	Power Spectral Density	Pass	-
3.4	15.247(d)	Conducted Band Edges and Spurious Emission	Pass	-
3.5	15.247(d)	Radiated Band Edges and Spurious Emission	Pass	Under limit 7.62 dB at 2344.440 MHz
3.6	15.207	AC Conducted Emission	Pass	Under limit 9.58 dB at 13.241 MHz
3.7	15.203 & 15.247(b)	Antenna Requirement	Pass	-

**Declaration of Conformity:**

The test results with all measurement uncertainty excluded are presented in accordance with the regulation limits or requirements declared by manufacturers.

**Comments and Explanations:**

The declared of product specification for EUT presented in the report are provided by the manufacturer, and the manufacturer takes all the responsibilities for the accuracy of product specification.

**Reviewed by: Wii Chang**

**Report Producer: Ruby Zou**



# 1 General Description

## 1.1 Product Feature of Equipment Under Test

Product Feature	
Equipment	WLAN/BTLE module
Brand Name	ZEBRA
Model Name	WYSBHVDXP
FCC ID	I28-WYSBHVDXP
EUT supports Radios application	WLAN 11a/b/g/n HT20/HT40 WLAN 11ac VHT20/VHT40/VHT80 WLAN 11ax HE20/HE40/HE80 Bluetooth BR/EDR/LE
HW Version	Revision F
SW Version	17.68.01.p13
EUT Stage	Identical Prototype

Remark: The above EUT's information was declared by manufacturer.

Supported Unit Used in Test Configuration and System				
Printer (Fixture)	Brand Name	ZEBRA	Model Name	ZQ521
Battery	Brand Name	ZEBRA	Part Number	P1089503-003
AC Adapter	Brand Name	ZEBRA	Model Name	FSP025-DYAA3
Bluetooth Antenna 1	Brand Name	gigaAnt	Model Name	3030A5645-01
Bluetooth Antenna 2	Brand Name	TAIYO YUDEN	Model Name	AH 168M245001
Bluetooth Antenna 3	Brand Name	Johanson Technology	Model Name	2450AT07A0100
WLAN Antenna 1	Brand Name	Laird	Model Name	RD2458-5
WLAN Antenna 2	Brand Name	Pulse	Model Name	W3006
WLAN Antenna 3	Brand Name	Auden	Model Name	220370-09
WLAN Antenna 4	Brand Name	Auden	Model Name	B91882-30

## 1.2 Product Specification of Equipment Under Test

Product Specification subjective to this standard	
Tx/Rx Frequency Range	2402 MHz ~ 2480 MHz
Number of Channels	40
Carrier Frequency of Each Channel	40 Channel (37 hopping + 3 advertising channel)
Maximum Output Power to Antenna	8.50 dBm (0.0071 W) for 1Mbps 8.60 dBm (0.0072 W) for 2Mbps
99% Occupied Bandwidth	1.001 MHz for 1Mbps 1.990 MHz for 2Mbps
Antenna Type	<3030A5645-01>: Monopole Antenna with gain 2.7 dBi <AH 168M245001>: Monopole Antenna with gain 3.0 dBi <2450AT07A0100>: Monopole Antenna with gain 1.0 dBi
Type of Modulation	Bluetooth LE : GFSK

Remark: The above EUT's information was declared by manufacturer. Please refer to Comments and Explanations in report summary.



### 1.3 Modification of EUT

No modifications are made to the EUT during all test items.

### 1.4 Testing Location

<b>Test Site</b>	Sporton International Inc. Wensan Laboratory
<b>Test Site Location</b>	No.58, Aly. 75, Ln. 564, Wenhua 3rd, Rd., Guishan Dist., Taoyuan City 333010, Taiwan (R.O.C.) TEL: +886-3-327-0868 FAX: +886-3-327-0855
<b>Test Site No.</b>	<b>Sporton Site No.</b> TH05-HY, CO07-HY, 03CH13-HY

**Note:** The test site complies with ANSI C63.4 2014 requirement.

FCC designation No.: TW3786

### 1.5 Applicable Standards

According to the specifications of the manufacturer, the EUT must comply with the requirements of the following standards:

- ♦ FCC Part 15 Subpart C §15.247
- ♦ FCC KDB Publication No. 558074 D01 DTS Meas. Guidance v05r02
- ♦ FCC KDB 414788 D01 Radiated Test Site v01r01
- ♦ ANSI C63.10-2013

**Remark:**

1. All test items were verified and recorded according to the standards and without any deviation during the test.
2. The TAF code is not including all the FCC KDB listed without accreditation.
3. This EUT has also been tested and complied with the requirements of FCC Part 15, Subpart B, recorded in a separate test report.



## 2 Test Configuration of Equipment Under Test

### 2.1 Carrier Frequency Channel

Frequency Band	Channel	Freq. (MHz)	Channel	Freq. (MHz)
2400-2483.5 MHz	0	2402	21	2444
	1	2404	22	2446
	2	2406	23	2448
	3	2408	24	2450
	4	2410	25	2452
	5	2412	26	2454
	6	2414	27	2456
	7	2416	28	2458
	8	2418	29	2460
	9	2420	30	2462
	10	2422	31	2464
	11	2424	32	2466
	12	2426	33	2468
	13	2428	34	2470
	14	2430	35	2472
	15	2432	36	2474
	16	2434	37	2476
	17	2436	38	2478
	18	2438	39	2480
	19	2440	-	-
20	2442	-	-	

## 2.2 Test Mode

Channel	Frequency	Bluetooth – LE RF Average Output Power	
		Data Rate / Modulation	
		GFSK	
		1Mbps	
Ch00	2402MHz	8.50 dBm	
Ch19	2440MHz	8.40 dBm	
Ch39	2480MHz	8.30 dBm	

Channel	Frequency	Bluetooth – LE RF Average Output Power	
		Data Rate / Modulation	
		GFSK	
		2Mbps	
Ch00	2402MHz	8.60 dBm	
Ch19	2440MHz	8.50 dBm	
Ch39	2480MHz	8.40 dBm	

- a. The EUT has been associated with peripherals and configuration operated in a manner tended to maximize its emission characteristics in a typical application. Frequency range investigated: conduction emission (150 kHz to 30 MHz), radiation emission (9 kHz to the 10th harmonic of the highest fundamental frequency or to 40 GHz, whichever is lower). For radiated measurement, pre-scanned in two antenna polarization (Horizontal and Vertical). The worst cases (Ant. Horizontal) were recorded in this report.
  
- b. AC power line Conducted Emission was tested under maximum output power.



The following summary table is showing all test modes to demonstrate in compliance with the standard.

Summary table of Test Cases	
Test Item	Data Rate / Modulation
<b>Conducted Test Cases</b>	<b>Bluetooth – LE / GFSK</b>
	Mode 1: Bluetooth Tx CH00_2402 MHz_1Mbps
	Mode 2: Bluetooth Tx CH19_2440 MHz_1Mbps
	Mode 3: Bluetooth Tx CH39_2480 MHz_1Mbps
	Mode 4: Bluetooth Tx CH00_2402 MHz_2Mbps
	Mode 5: Bluetooth Tx CH19_2440 MHz_2Mbps
	Mode 6: Bluetooth Tx CH39_2480 MHz_2Mbps
<b>Radiated Test Cases</b>	Mode 1: Bluetooth Tx CH00_2402 MHz_1Mbps
	Mode 2: Bluetooth Tx CH19_2440 MHz_1Mbps
	Mode 3: Bluetooth Tx CH39_2480 MHz_1Mbps
	Mode 4: Bluetooth Tx CH00_2402 MHz_2Mbps
	Mode 5: Bluetooth Tx CH19_2440 MHz_2Mbps
	Mode 6: Bluetooth Tx CH39_2480 MHz_2Mbps
	<b>AC Conducted Emission</b>

**Remark:** For Radiated Test Cases, the tests were performed Bluetooth Antenna (AH 168M245001).

### 2.3 Connection Diagram of Test System

<AC Conducted Emission Mode>

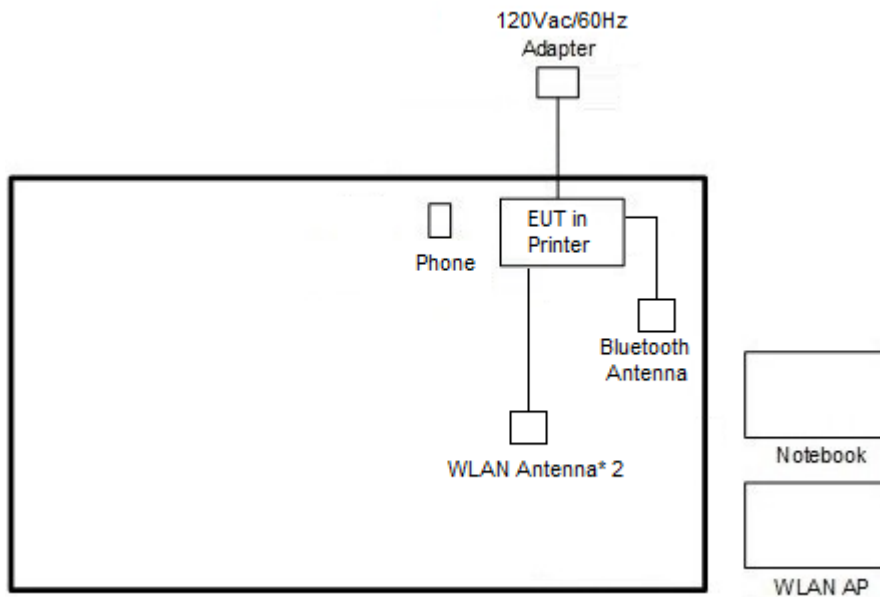

<Bluetooth - LE Tx Mode>

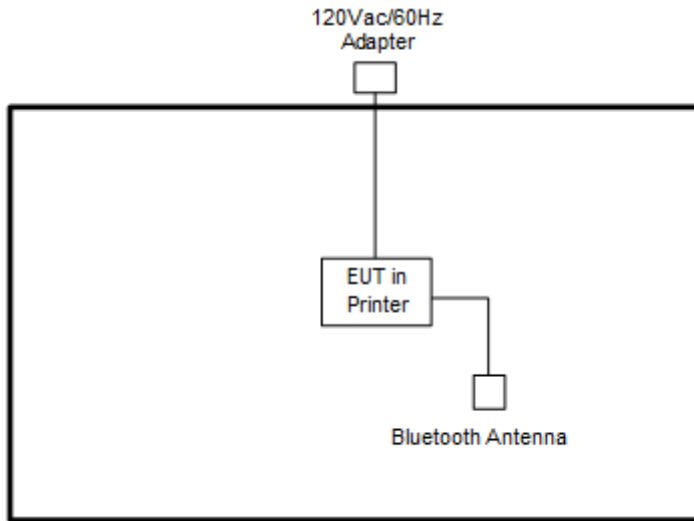

**2.4 Support Unit used in test configuration and system**

Item	Equipment	Brand Name	Model Name	FCC ID	Data Cable	Power Cord
1.	Phone	SUGAR	Y12s	FCC DoC	N/A	N/A
2.	WLAN AP	ASUS	RT-AC66U	MSQ-RTAC66U	N/A	Unshielded, 1.8m
3.	Notebook	Dell	Latitude 3400	FCC DoC	N/A	AC I/P : Unshielded, 1.2m DC O/P : Shielded, 1.8m



## 2.5 EUT Operation Test Setup

The RF test items, utility “Toolbox\_Version 1.84” was installed in Notebook which was programmed in order to make the EUT get into the engineering modes to provide channel selection, power level, data rate and the application type and for continuous transmitting signals.

## 2.6 Measurement Results Explanation Example

**For all conducted test items:**

The offset level is set in the spectrum analyzer to compensate the RF cable loss and attenuator factor between EUT conducted output port and spectrum analyzer. With the offset compensation, the spectrum analyzer reading level is exactly the EUT RF output level.

Example :

The spectrum analyzer offset is derived from RF cable loss and attenuator factor.

*Offset = RF cable loss + attenuator factor.*

Following shows an offset computation example with cable loss 4.2 dB and 10 dB attenuator.

$$\begin{aligned} \text{Offset(dB)} &= \text{RF cable loss(dB)} + \text{attenuator factor(dB)}. \\ &= 4.2 + 10 = 14.2 \text{ (dB)} \end{aligned}$$

### 3 Test Result

#### 3.1 6dB and 99% Bandwidth Measurement

##### 3.1.1 Limit of 6dB and 99% Bandwidth

The minimum 6 dB bandwidth shall be at least 500 kHz.

##### 3.1.2 Measuring Instruments

See list of measuring equipment of this test report.

##### 3.1.3 Test Procedures

1. The testing follows the ANSI C63.10 Section 6.9.3 (OBW) and 11.8.1 (6dB BW).
2. The RF output of EUT was connected to the spectrum analyzer by RF cable and attenuator. The path loss was compensated to the results for each measurement.
3. Set the maximum power setting and enable the EUT to transmit continuously.
4. Make the measurement with the spectrum analyzer's resolution bandwidth (RBW) = 100 kHz. Set the Video bandwidth (VBW) = 300 kHz. In order to make an accurate measurement. The 6dB bandwidth must be greater than 500 kHz.
5. For 99% Bandwidth Measurement, the spectrum analyzer's resolution bandwidth (RBW) is set 1-5% of the emission bandwidth and set the Video bandwidth (VBW)  $\geq 3 * RBW$ .
6. Measure and record the results in the test report.

##### 3.1.4 Test Setup





3.1.5 Test Result of 6dB Bandwidth

Test Engineer :	Rebecca Li, Tommy Lee and Hank Hsu	Temperature :	21~25°C
		Relative Humidity :	51~54%

Mod.	Data Rate	NTX	CH.	Freq. (MHz)	6dB BW (MHz)	6dB BW Limit (MHz)	Pass/Fail
BLE	1Mbps	1	0	2402	0.650	0.50	Pass
BLE	1Mbps	1	19	2440	0.652	0.50	Pass
BLE	1Mbps	1	39	2480	0.652	0.50	Pass
BLE	2Mbps	1	0	2402	1.148	0.50	Pass
BLE	2Mbps	1	19	2440	1.152	0.50	Pass
BLE	2Mbps	1	39	2480	1.152	0.50	Pass



<1Mbps>

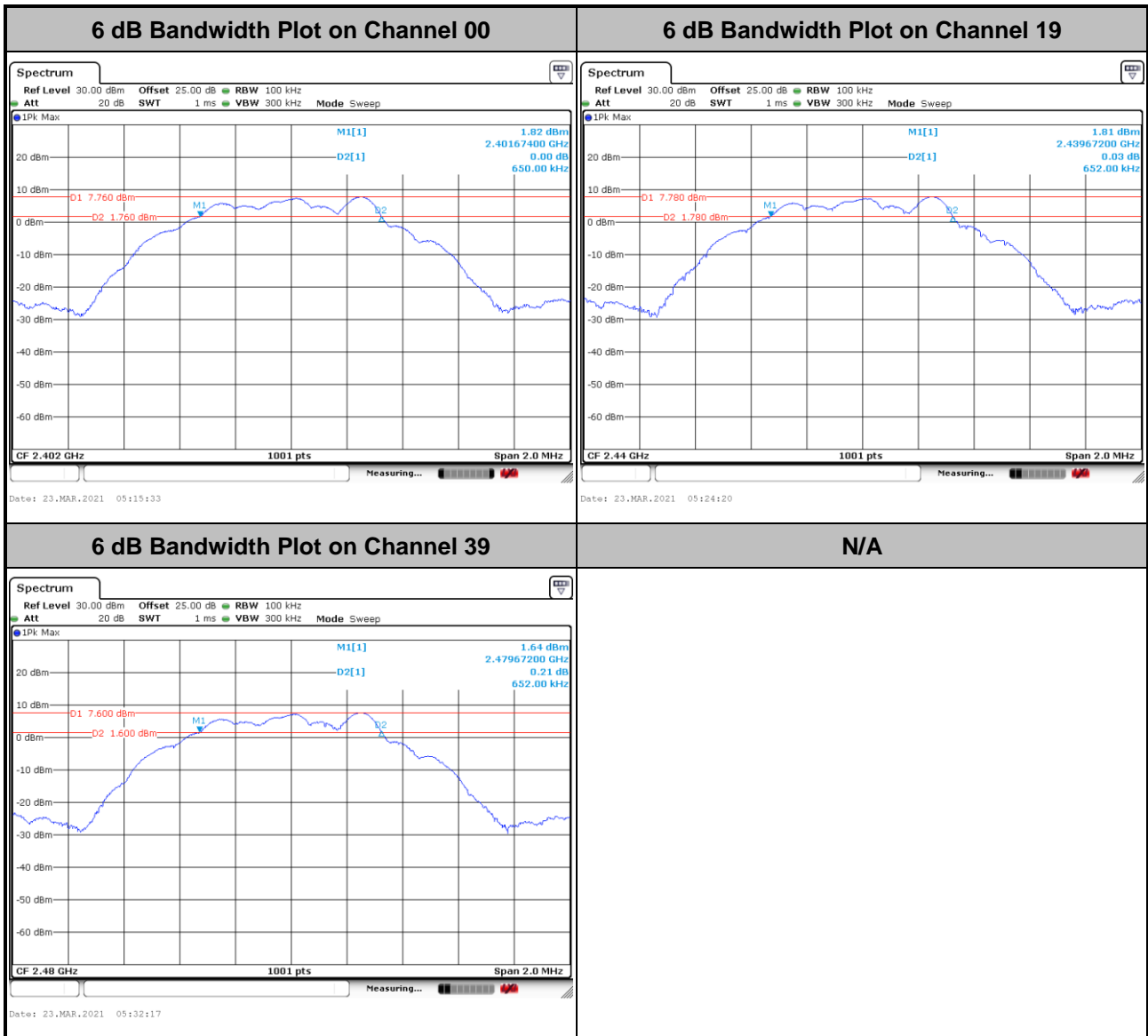



<2Mbps>

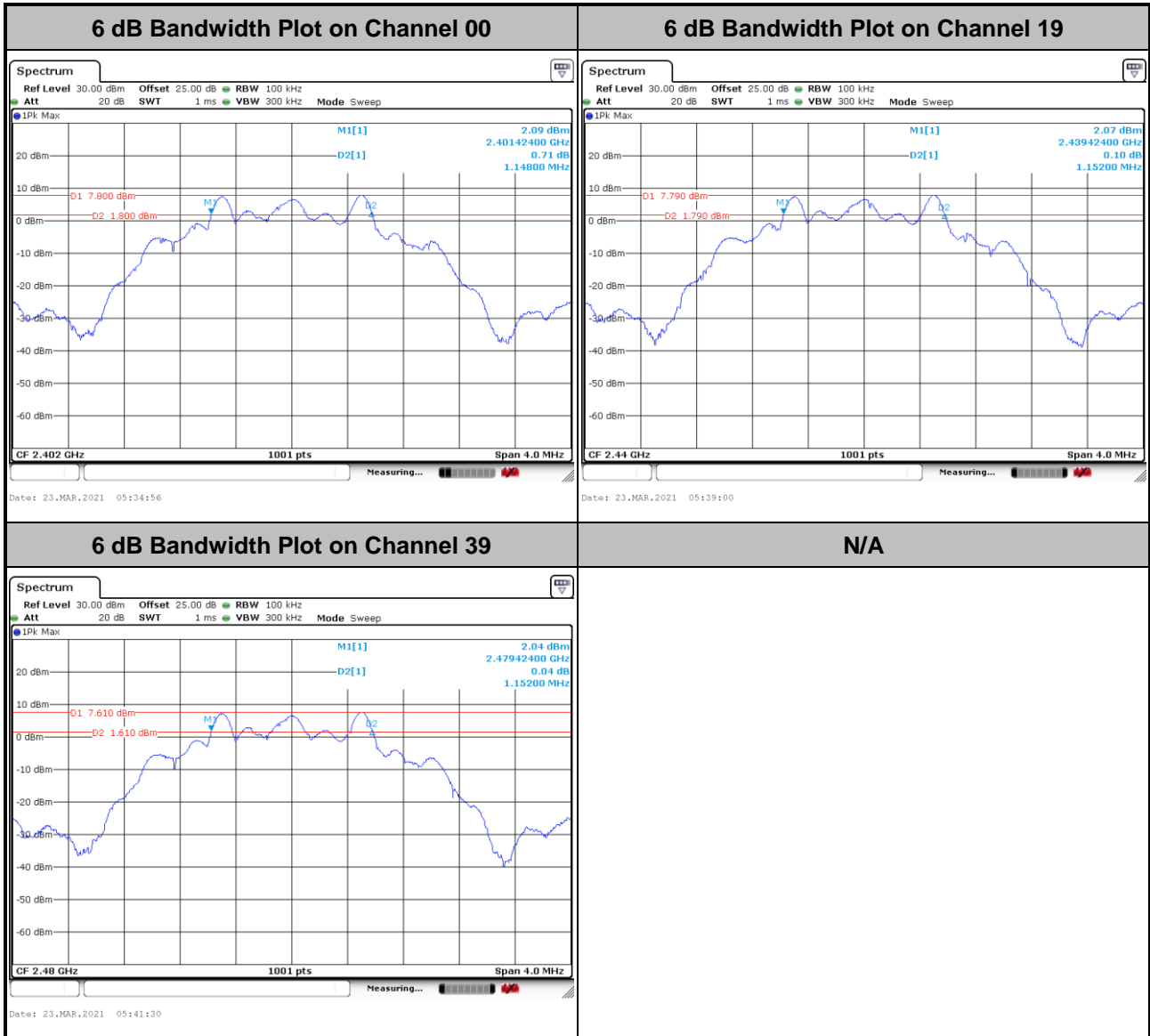



3.1.6 Test Result of 99% Occupied Bandwidth

Test Engineer :	Rebecca Li, Tommy Lee and Hank Hsu	Temperature :	21~25°C
		Relative Humidity :	51~54%

Mod.	Data Rate	NTX	CH.	Freq. (MHz)	99% Occupied BW (MHz)	Pass/Fail
BLE	1Mbps	1	0	2402	1.001	Pass
BLE	1Mbps	1	19	2440	1.001	Pass
BLE	1Mbps	1	39	2480	1.001	Pass
BLE	2Mbps	1	0	2402	1.990	Pass
BLE	2Mbps	1	19	2440	1.990	Pass
BLE	2Mbps	1	39	2480	1.990	Pass





<1Mbps>

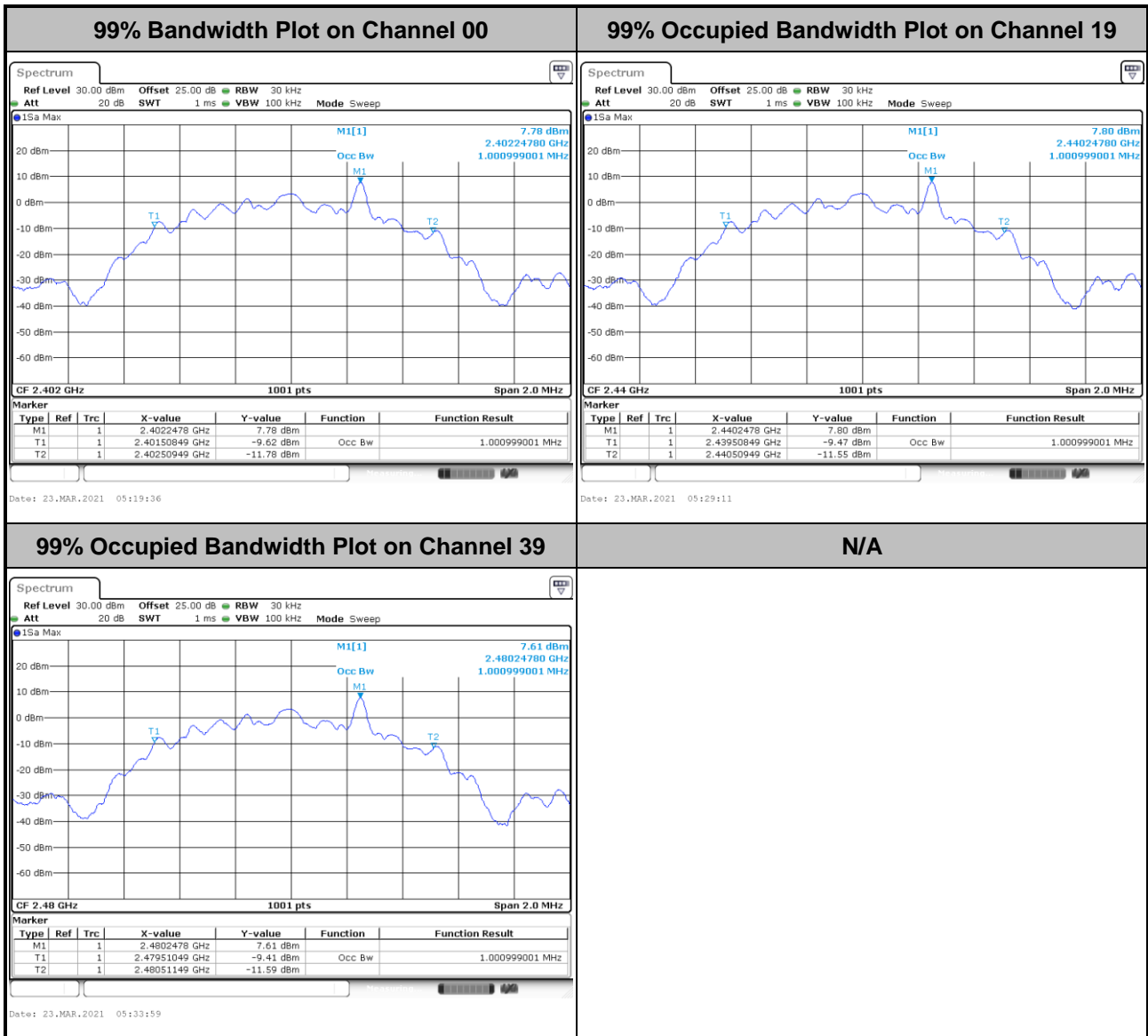

Note: The occupied channel bandwidth is maintained within the band of operation for all of the modulations.



<2Mbps>

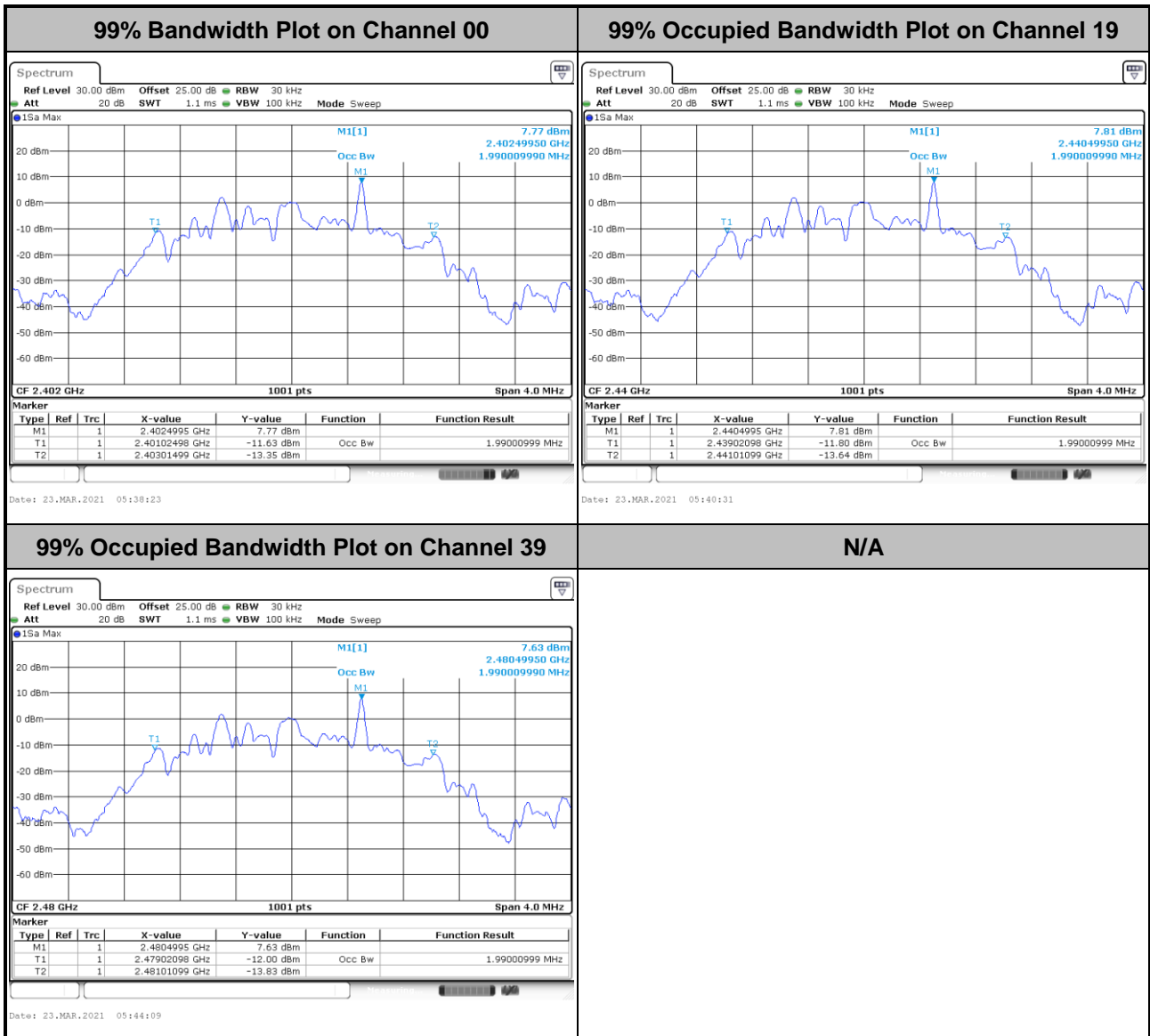

Note: The occupied channel bandwidth is maintained within the band of operation for all of the modulations.

## 3.2 Output Power Measurement

### 3.2.1 Limit of Output Power

For systems using digital modulation in the 2400-2483.5 MHz, the limit for output power is 30 dBm. If transmitting antenna of directional gain greater than 6 dBi is used, the peak output power from the intentional radiator shall be reduced below the above stated value by the amount in dB that the directional gain of the antenna exceeds 6 dBi. In case of point-to-point operation, the limit has to be reduced by 1 dB for every 3 dB that the directional gain of the antenna exceeds 6 dBi.

### 3.2.2 Measuring Instruments

See list of measuring equipment of this test report.

### 3.2.3 Test Procedures

1. For Average Power, the testing follows ANSI C63.10 Section 11.9.2.3.2 Method AVGPM-G
2. The RF output of EUT was connected to the power meter by RF cable and attenuator.
3. The path loss was compensated to the results for each measurement.
4. Set the maximum power setting and enable the EUT to transmit continuously.
5. Measure the conducted output power and record the results in the test report.

### 3.2.4 Test Setup

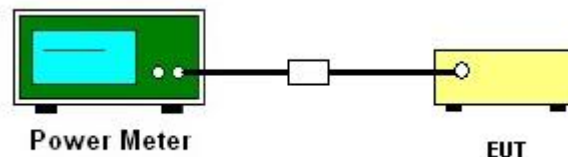



3.2.5 Test Result of Average Output Power

Test Engineer :	Rebecca Li, Tommy Lee and Hank Hsu	Temperature :	21~25°C
		Relative Humidity :	51~54%

Mod.	Data Rate	NTX	CH.	Freq. (MHz)	Average Conducted Power (dBm)	Conducted Power Limit (dBm)	DG (dBi)	EIRP Power (dBm)	EIRP Power Limit (dBm)	Pass /Fail
BLE	1Mbps	1	0	2402	8.50	30.00	3.00	11.20	36.00	Pass
BLE	1Mbps	1	19	2440	8.40	30.00	3.00	11.10	36.00	Pass
BLE	1Mbps	1	39	2480	8.30	30.00	3.00	11.00	36.00	Pass
BLE	2Mbps	1	0	2402	8.60	30.00	3.00	11.30	36.00	Pass
BLE	2Mbps	1	19	2440	8.50	30.00	3.00	11.20	36.00	Pass
BLE	2Mbps	1	39	2480	8.40	30.00	3.00	11.10	36.00	Pass

### 3.3 Power Spectral Density Measurement

#### 3.3.1 Limit of Power Spectral Density

The peak power spectral density shall not be greater than 8 dBm in any 3 kHz band at any time interval of continuous transmission.

#### 3.3.2 Measuring Instruments

See list of measuring equipment of this test report.

#### 3.3.3 Test Procedures

1. The testing follows the ANSI C63.10 Section 11.10.2 Method PKPSD.
2. The RF output of EUT was connected to the spectrum analyzer by RF cable and attenuator. The path loss was compensated to the results for each measurement.
3. Set the maximum power setting and enable the EUT to transmit continuously.
4. Make the measurement with the spectrum analyzer's resolution bandwidth (RBW) = 3 kHz. Video bandwidth VBW = 10 kHz. In order to make an accurate measurement, set the span to 1.5 times DTS Channel Bandwidth. (6dB BW)
5. Detector = peak, Sweep time = auto couple, Trace mode = max hold, Allow trace to fully stabilize. Use the peak marker function to determine the maximum power level.
6. Measure and record the results in the test report.
7. The Measured power density (dBm)/ 100 kHz is a reference level and is used as 20 dBc down limit line for Conducted Band Edges and Conducted Spurious Emission.

#### 3.3.4 Test Setup

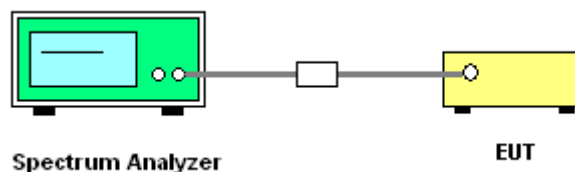



3.3.5 Test Result of Power Spectral Density

Test Engineer :	Rebecca Li, Tommy Lee and Hank Hsu	Temperature :	21~25°C
		Relative Humidity :	51~54%

Mod.	Data Rate	N <sub>TX</sub>	CH.	Freq. (MHz)	Peak PSD (dBm /100kHz)	Peak PSD (dBm /3kHz)	DG (dBi)	Peak PSD Limit (dBm /3kHz)	Pass/Fail
BLE	1Mbps	1	0	2402	7.77	7.85	3.00	8.00	Pass
BLE	1Mbps	1	19	2440	7.79	7.87	3.00	8.00	Pass
BLE	1Mbps	1	39	2480	7.61	7.69	3.00	8.00	Pass
BLE	2Mbps	1	0	2402	7.79	7.88	3.00	8.00	Pass
BLE	2Mbps	1	19	2440	7.79	7.89	3.00	8.00	Pass
BLE	2Mbps	1	39	2480	7.61	7.69	3.00	8.00	Pass



3.3.6 Test Result of Power Spectral Density Plots (100kHz)

Test Engineer : Rebecca Li, Tommy Lee and Hank Hsu	Temperature :	21~25°C
	Relative Humidity :	51~54%

<1Mbps>

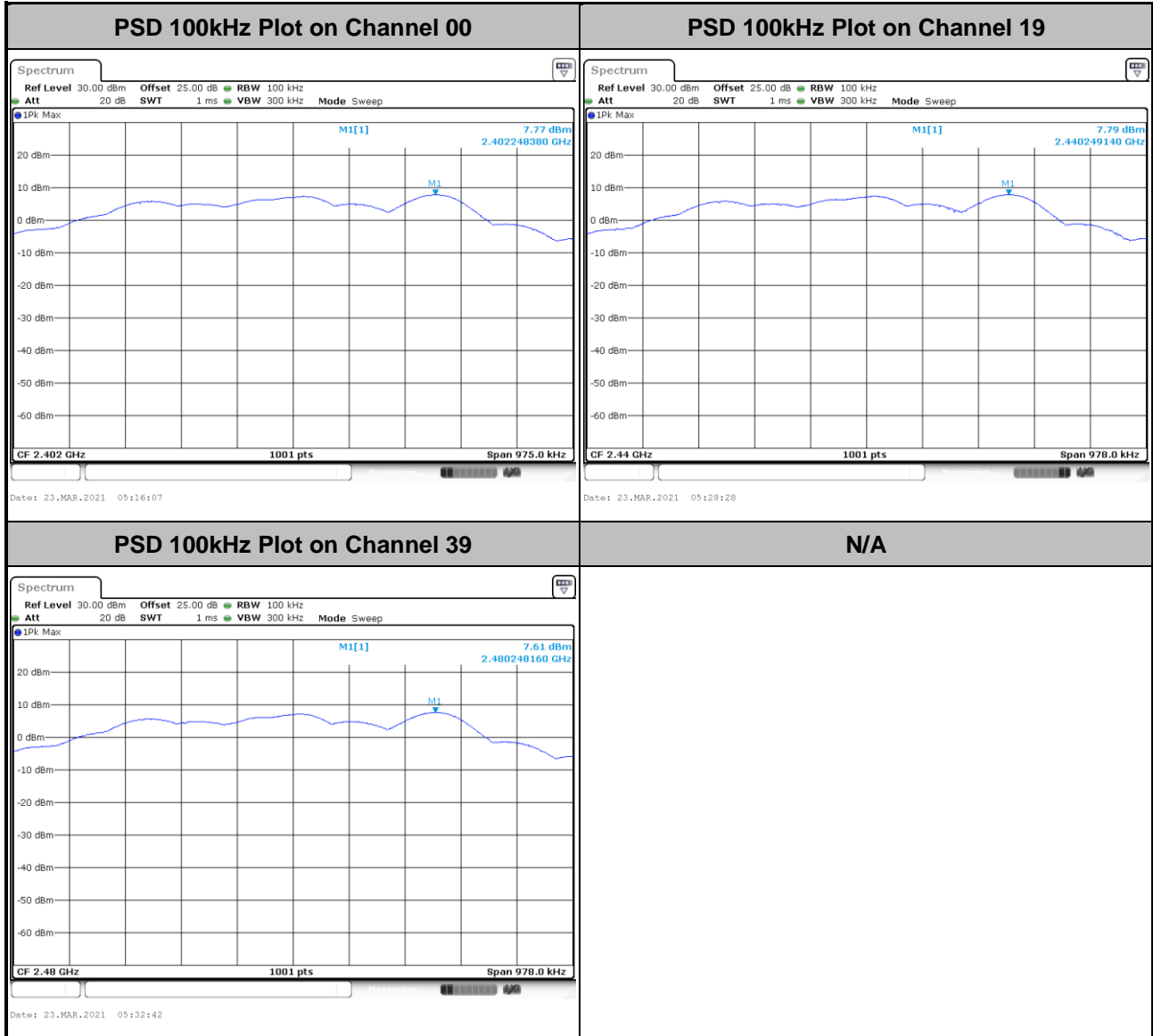



<2Mbps>

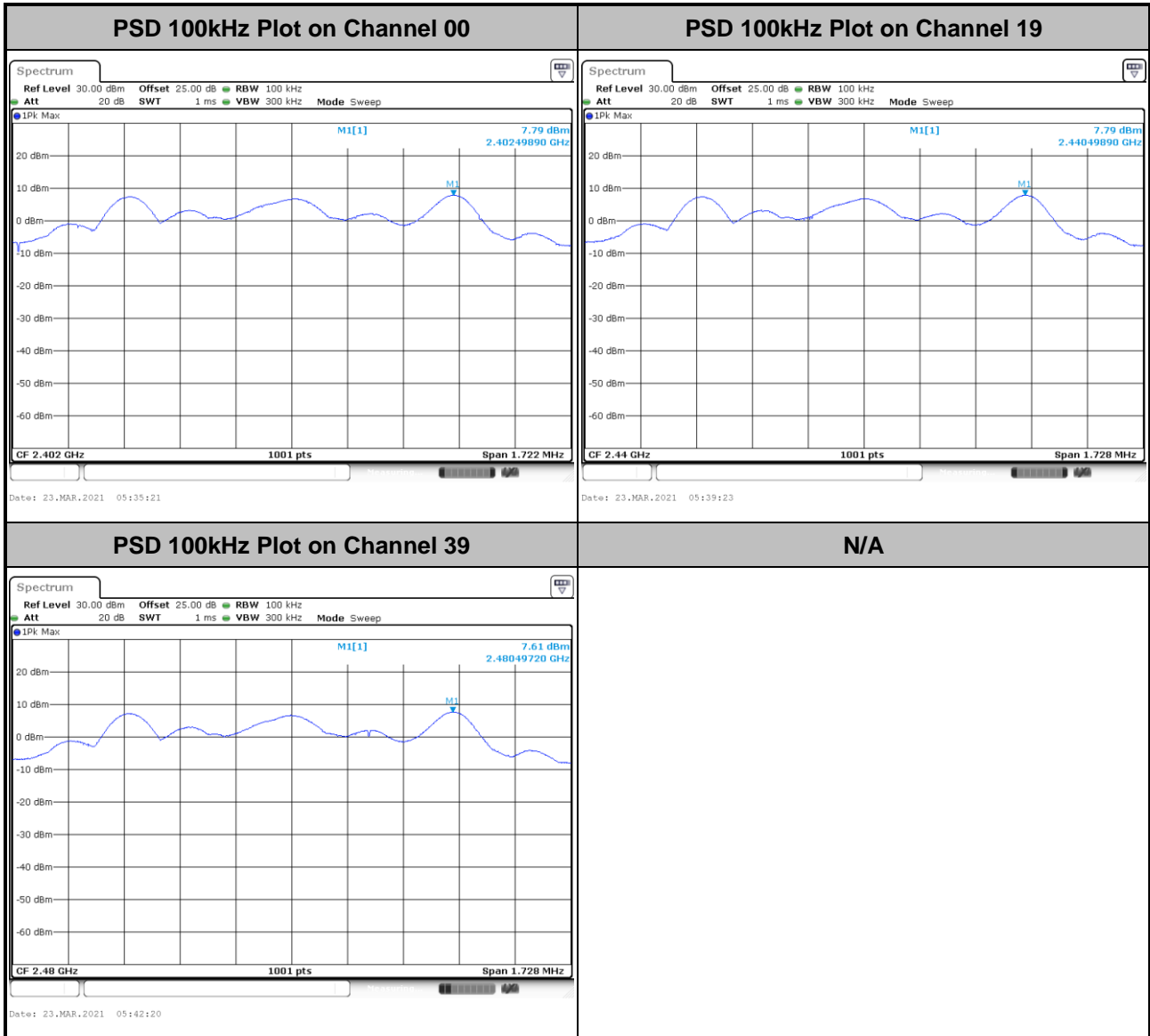





3.3.7 Test Result of Power Spectral Density Plots (3kHz)

Test Engineer : Rebecca Li, Tommy Lee and Hank Hsu	Temperature :	21~25°C
	Relative Humidity :	51~54%

<1Mbps>

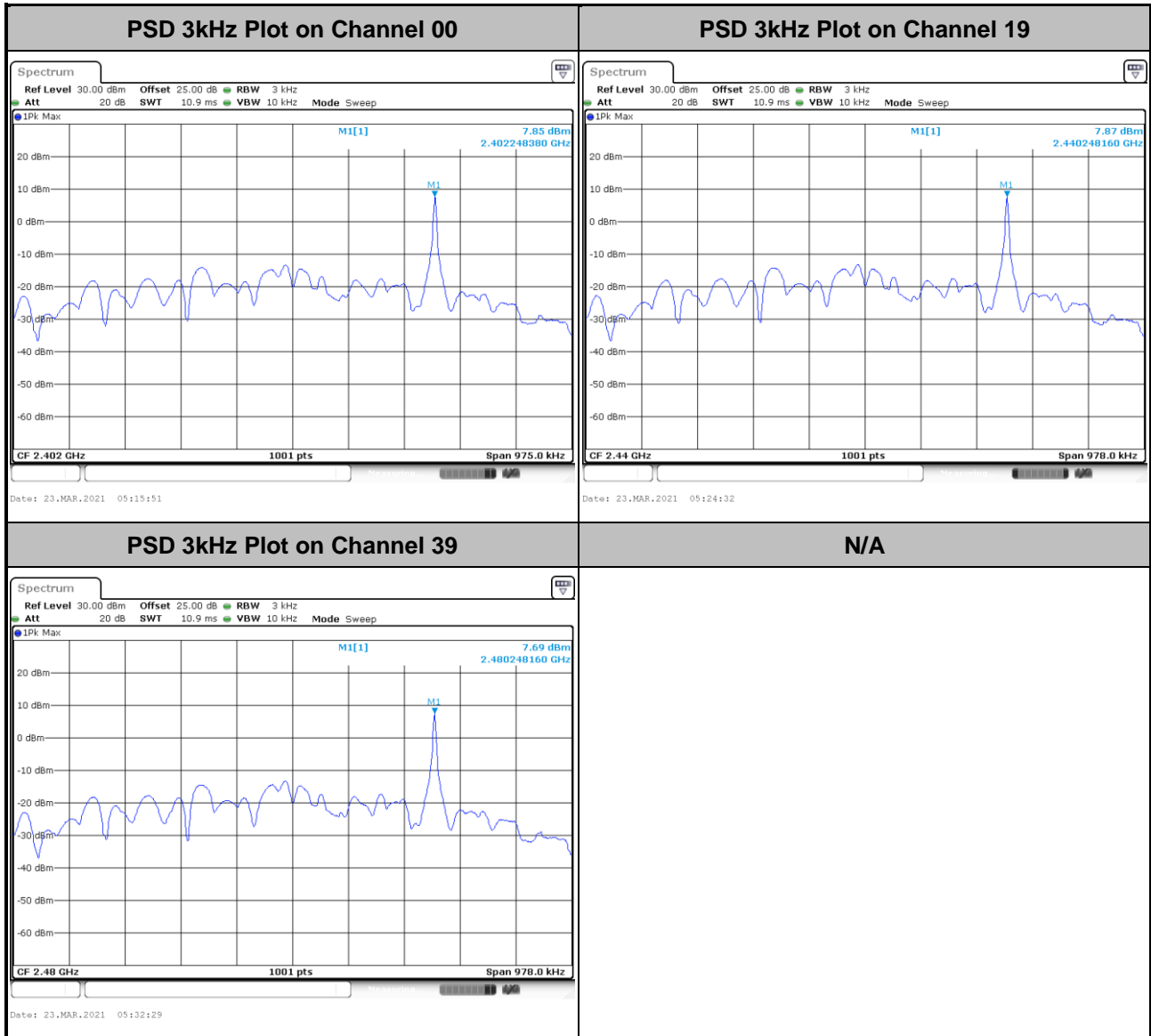



<2Mbps>

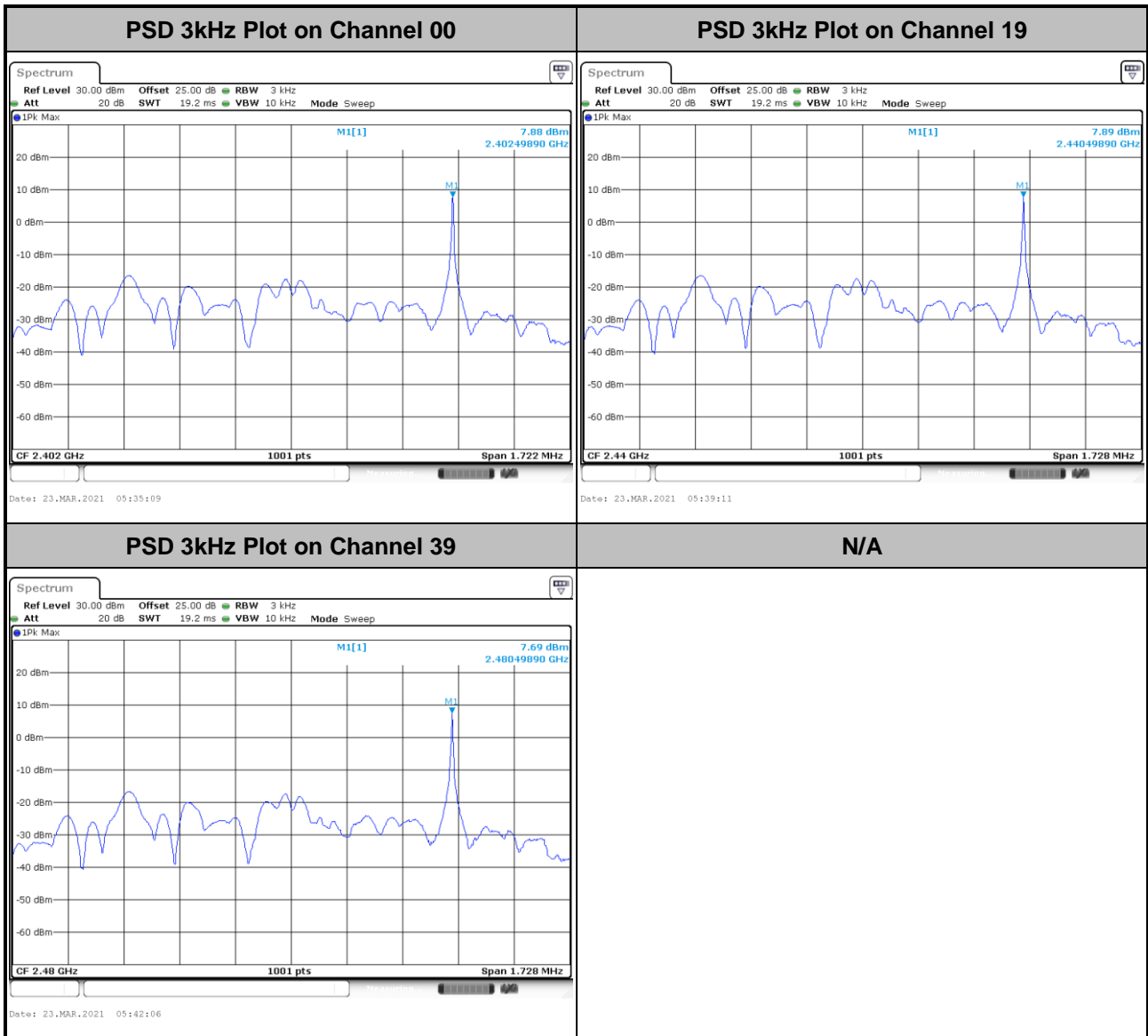

## 3.4 Conducted Band Edges and Spurious Emission Measurement

### 3.4.1 Limit of Conducted Band Edges and Spurious Emission

All harmonics/spurious must be at least 20 dB down from the highest emission level within the authorized band.

### 3.4.2 Measuring Instruments

See list of measuring equipment of this test report.

### 3.4.3 Test Procedure

1. The testing follows the ANSI C63.10 Section 11.11.3 Emission level measurement.
2. The RF output of EUT was connected to the spectrum analyzer by RF cable and attenuator. The path loss was compensated to the results for each measurement.
3. Set the maximum power setting and enable the EUT to transmit continuously.
4. Set RBW = 100 kHz, VBW = 300 kHz, Peak Detector. Unwanted Emissions measured in any 100 kHz bandwidth outside of the authorized frequency band shall be attenuated by at least 20 dB relative to the maximum in-band peak PSD level in 100 kHz when maximum peak conducted output power procedure is used. If the transmitter complies with the conducted power limits based on the use of RMS averaging over a time interval, the attenuation required under this paragraph shall be 30 dB instead of 20 dB.
5. Measure and record the results in the test report.
6. The RF fundamental frequency should be excluded against the limit line in the operating frequency band.

### 3.4.4 Test Setup

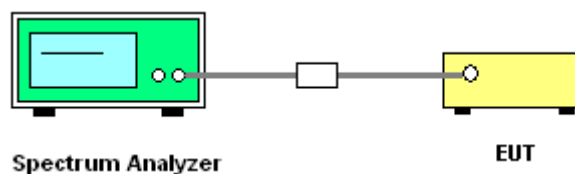



3.4.5 Test Result of Conducted Band Edges Plots

Test Engineer :	Rebecca Li, Tommy Lee and Hank Hsu	Temperature :	21~25°C
		Relative Humidity :	51~54%

<1Mbps>

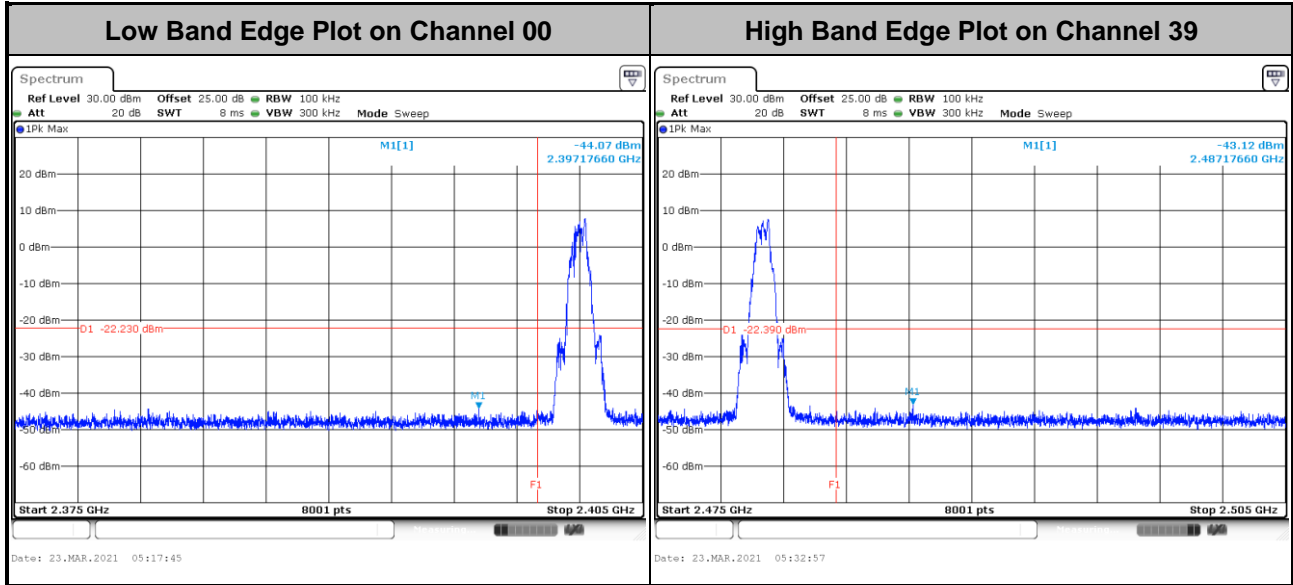

<2Mbps>

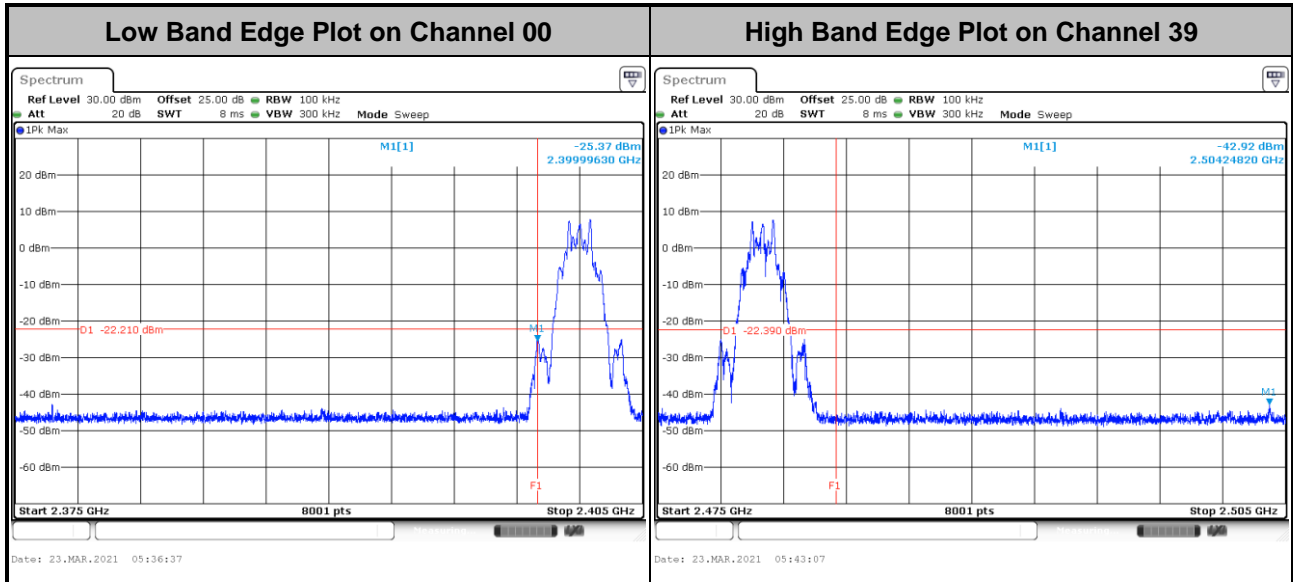



3.4.6 Test Result of Conducted Spurious Emission Plots

Test Engineer :	Rebecca Li, Tommy Lee and Hank Hsu	Temperature :	21~25°C
		Relative Humidity :	51~54%

<1Mbps>

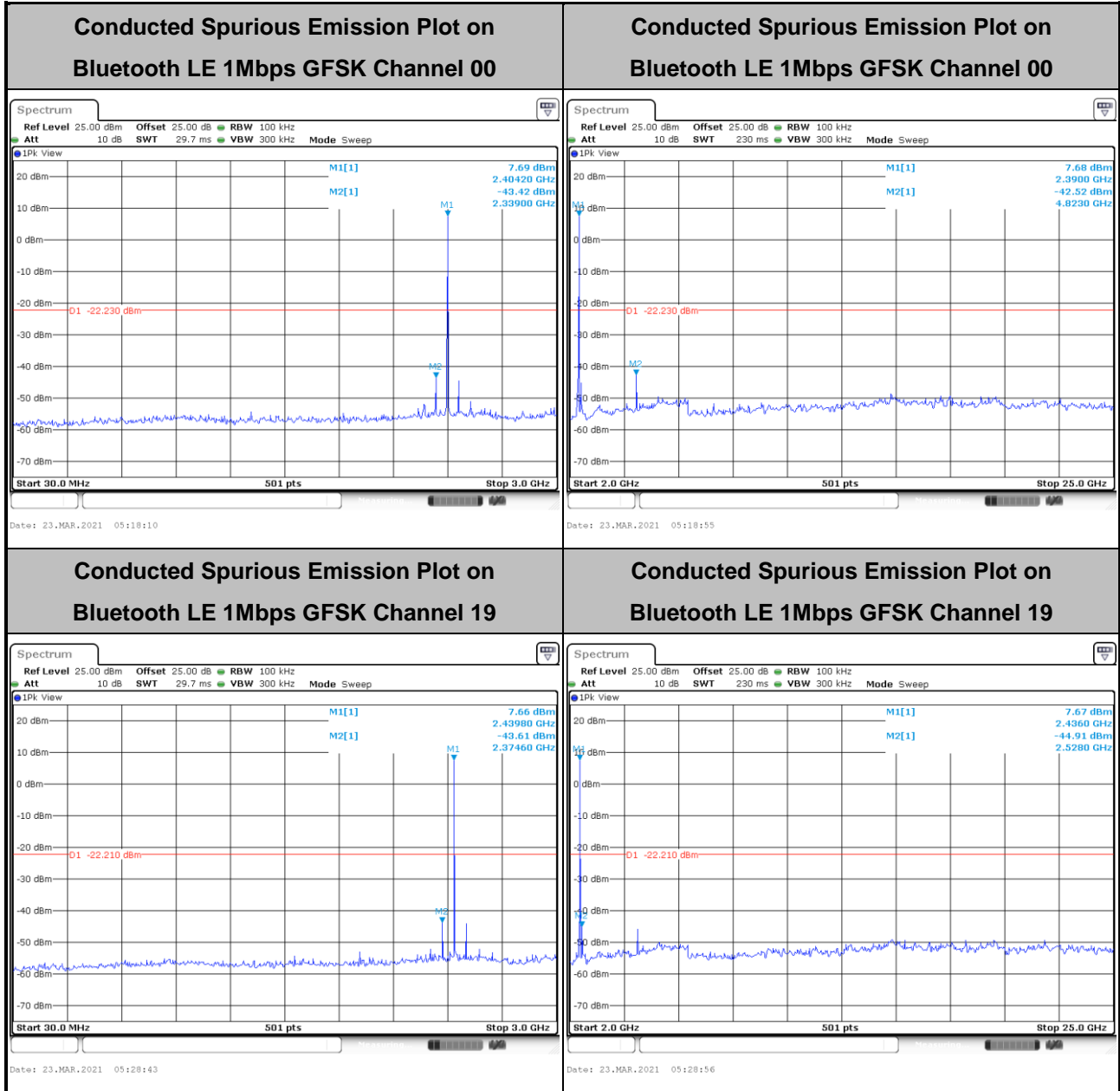

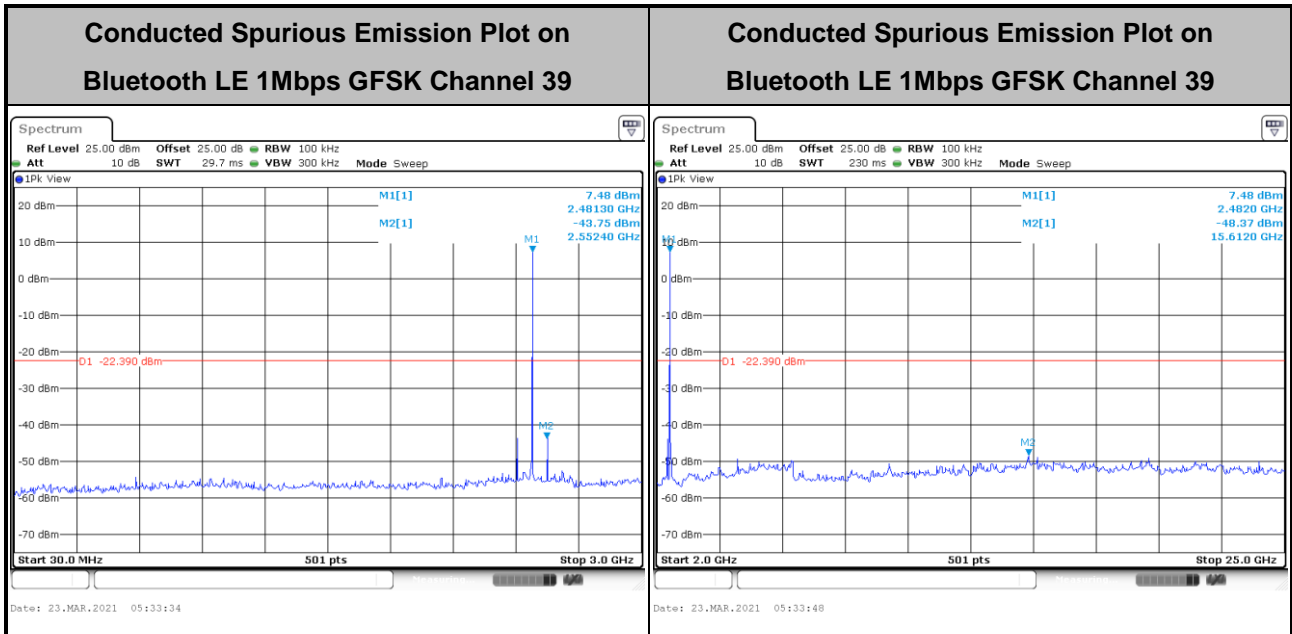



<2Mbps>

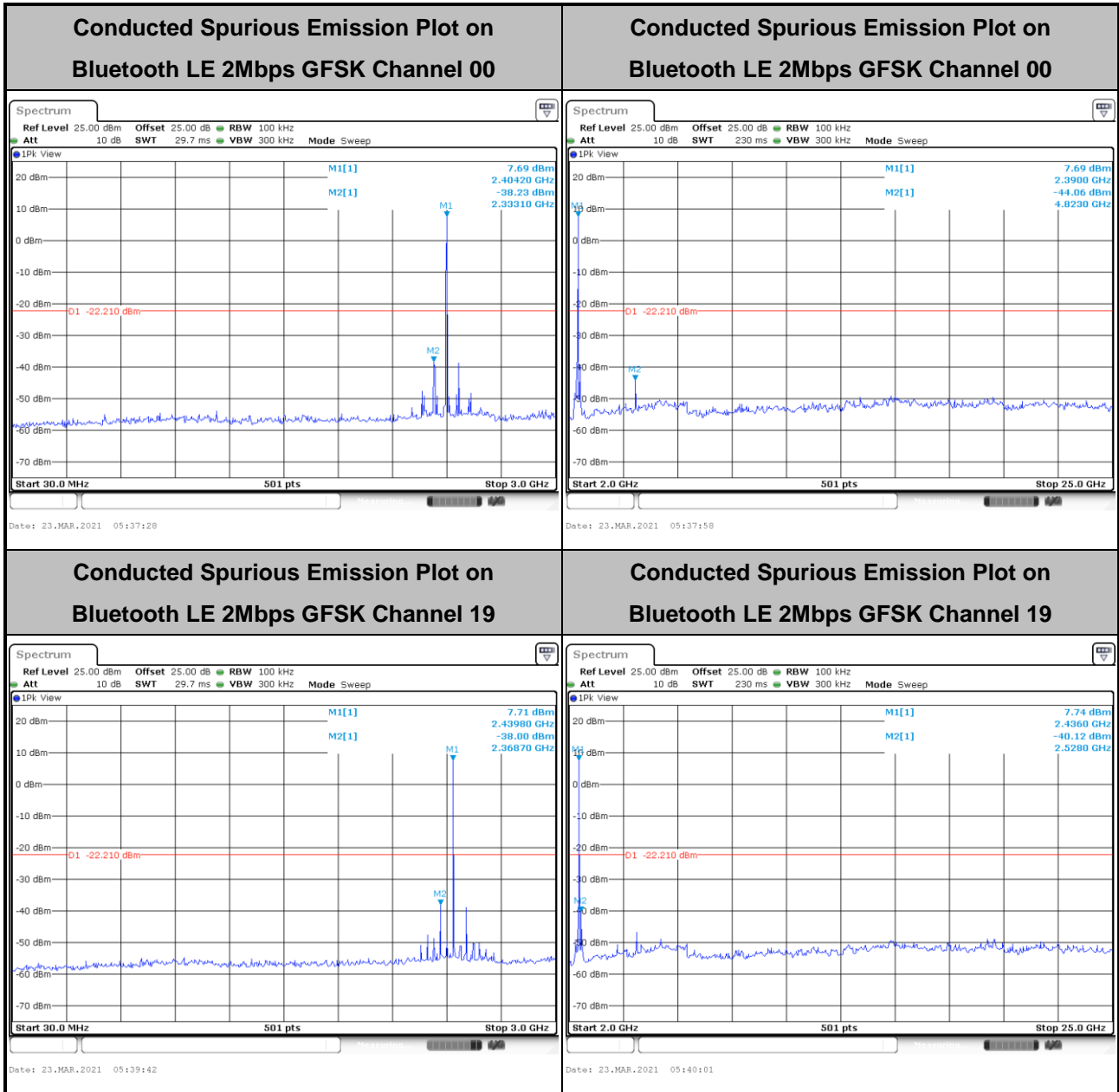

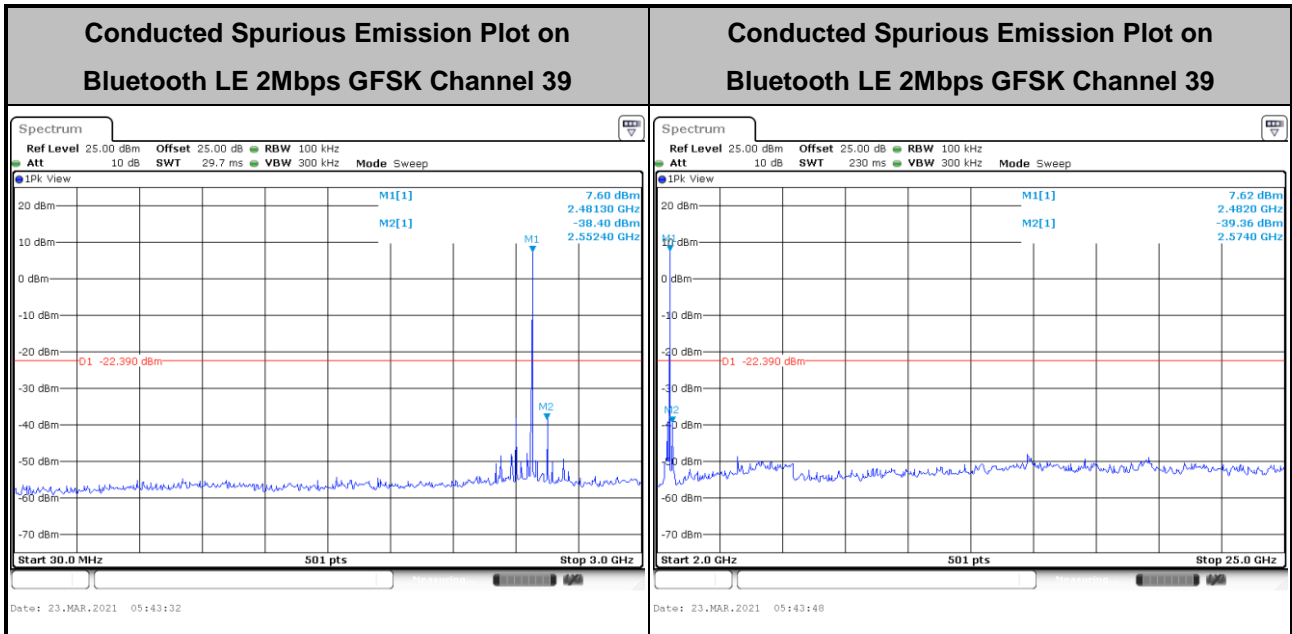





### 3.5 Radiated Band Edges and Spurious Emission Measurement

#### 3.5.1 Limit of Radiated Band Edges and Spurious Emission

In any 100 kHz bandwidth outside the intentional radiator frequency band, all harmonics/spurious must be at least 20 dB below the highest emission level within the authorized band. If the output power of this device was measured by spectrum analyzer, the attenuation under this paragraph shall be 30 dB instead of 20 dB. In addition, radiated emissions which fall in the restricted bands must also comply with the limits as below.

Frequency (MHz)	Field Strength (microvolts/meter)	Measurement Distance (meters)
0.009 – 0.490	2400/F(kHz)	300
0.490 – 1.705	24000/F(kHz)	30
1.705 – 30.0	30	30
30 – 88	100	3
88 – 216	150	3
216 - 960	200	3
Above 960	500	3

#### 3.5.2 Measuring Instruments

See list of measuring equipment of this test report.



### 3.5.3 Test Procedures

1. The testing follows the ANSI C63.10 Section 11.12.1 Radiated emission measurements.
2. The EUT was arranged to its worst case and then tune the antenna tower (from 1 m to 4 m) and turntable (from 0 degree to 360 degrees) to find the maximum reading. A pre-amp and a high pass filter are used for the test in order to get better signal level.
3. The EUT was placed on a turntable with 0.8 meter for frequency below 1 GHz and 1.5 meter for frequency above 1 GHz respectively above ground.
4. The EUT was set 3 meters from the interference receiving antenna, which was mounted on the top of a variable height antenna tower.
5. Corrected Reading: Antenna Factor + Cable Loss + Read Level - Preamp Factor = Level
6. For testing below 1 GHz, if the emission level of the EUT in peak mode was 3 dB lower than the limit specified, then peak values of EUT will be reported, otherwise, the emissions will be repeated one by one using the CISPR quasi-peak method and be reported.
7. For testing above 1 GHz, the emission level of the EUT in peak mode was 20 dB lower than average limit (that means the emission level in average mode also complies with the limit in average mode), then peak values of EUT will be reported, otherwise, the emissions will be measured in average mode again and be reported.
8. Use the following spectrum analyzer settings:
  - (1) Span shall wide enough to fully capture the emission being measured;
  - (2) Set RBW = 100 kHz for  $f < 1$  GHz; VBW  $\geq$  RBW; Sweep = auto; Detector function = peak; Trace = max hold;
  - (3) Set RBW = 1 MHz, VBW = 3 MHz for  $f \geq 1$  GHz for peak measurement.  
For average measurement:
    - VBW = 10 Hz, when duty cycle is no less than 98 percent.
    - VBW  $\geq 1/T$ , when duty cycle is less than 98 percent where T is the minimum transmission duration over which the transmitter is on and is transmitting at its maximum power control level for the tested mode of operation.

### 3.5.4 Test Setup

For radiated test below 30MHz

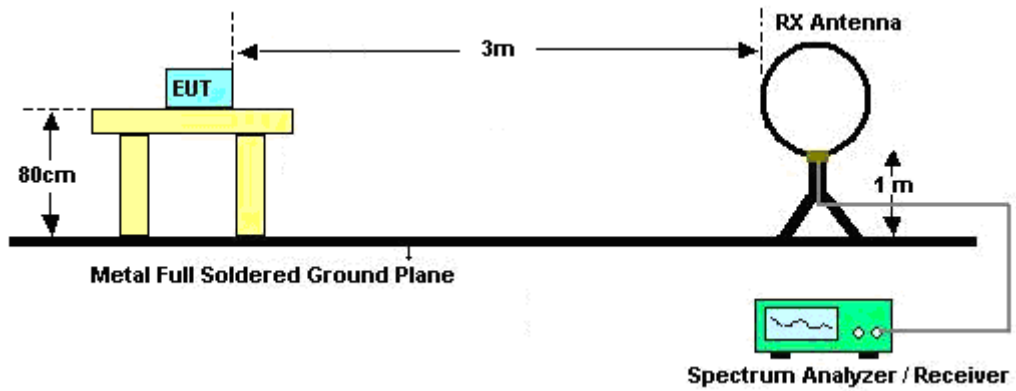

For radiated test from 30MHz to 1GHz

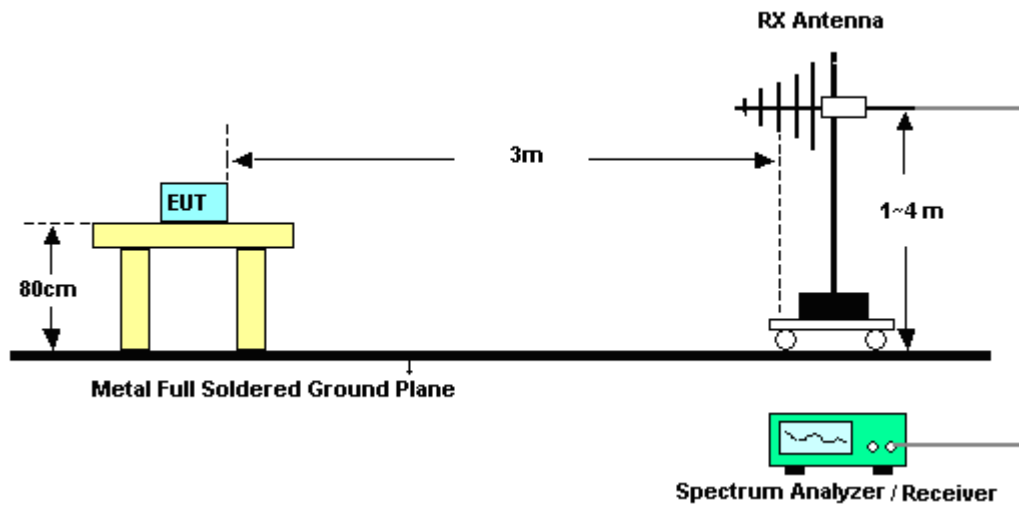

For radiated test above 1GHz

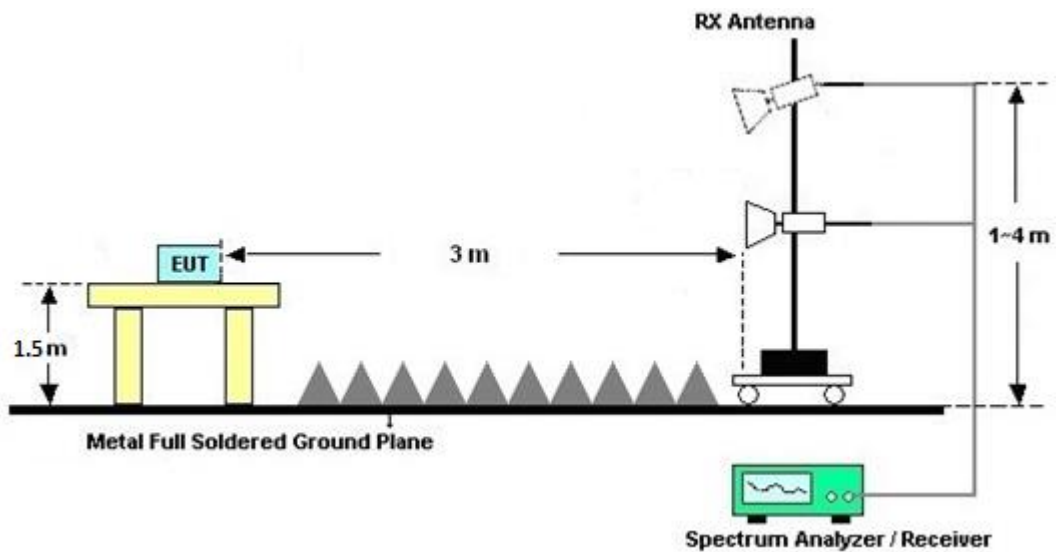



### **3.5.5 Test Results of Radiated Spurious Emissions (9 kHz ~ 30 MHz)**

The low frequency, which started from 9 kHz to 30MHz, was pre-scanned and the result which was 20dB lower than the limit line was not reported.

There is a comparison data of both open-field test site and alternative test site - semi-Anechoic chamber according to 414788 D01 Radiated Test Site v01r01, and the result came out very similar.

### **3.5.6 Test Result of Radiated Spurious at Band Edges**

Please refer to Appendix B and C.

### **3.5.7 Duty Cycle**

Please refer to Appendix D.

### **3.5.8 Test Result of Radiated Spurious Emission (30 MHz ~ 10th Harmonic)**

Please refer to Appendix B and C.



### 3.6 AC Conducted Emission Measurement

#### 3.6.1 Limit of AC Conducted Emission

For equipment that is designed to be connected to the public utility (AC) power line, the radio frequency voltage that is conducted back onto the AC power line on any frequency or frequencies within the band 150 kHz to 30 MHz shall not exceed the limits in the following table.

Frequency of emission (MHz)	Conducted limit (dB $\mu$ V)	
	Quasi-peak	Average
0.15-0.5	66 to 56*	56 to 46*
0.5-5	56	46
5-30	60	50

\*Decreases with the logarithm of the frequency.

#### 3.6.2 Measuring Instruments

See list of measuring equipment of this test report.

#### 3.6.3 Test Procedures

1. The EUT was placed 0.4 meter from the conducting wall of the shielding room was kept at least 80 centimeters from any other grounded conducting surface.
2. Connect EUT to the power mains through a line impedance stabilization network (LISN).
3. All the support units are connecting to the other LISN.
4. The LISN provides 50 ohm coupling impedance for the measuring instrument.
5. The FCC states that a 50 ohm, 50 microhenry LISN shall be used.
6. Both sides of AC line were checked for maximum conducted interference.
7. The frequency range from 150 kHz to 30 MHz was searched.
8. Set the test-receiver system to Peak Detect Function and specified bandwidth (IF Bandwidth = 9kHz) with Maximum Hold Mode. Then measurement is also conducted by Average Detector and Quasi-Peak Detector Function respectively.

### 3.6.4 Test Setup

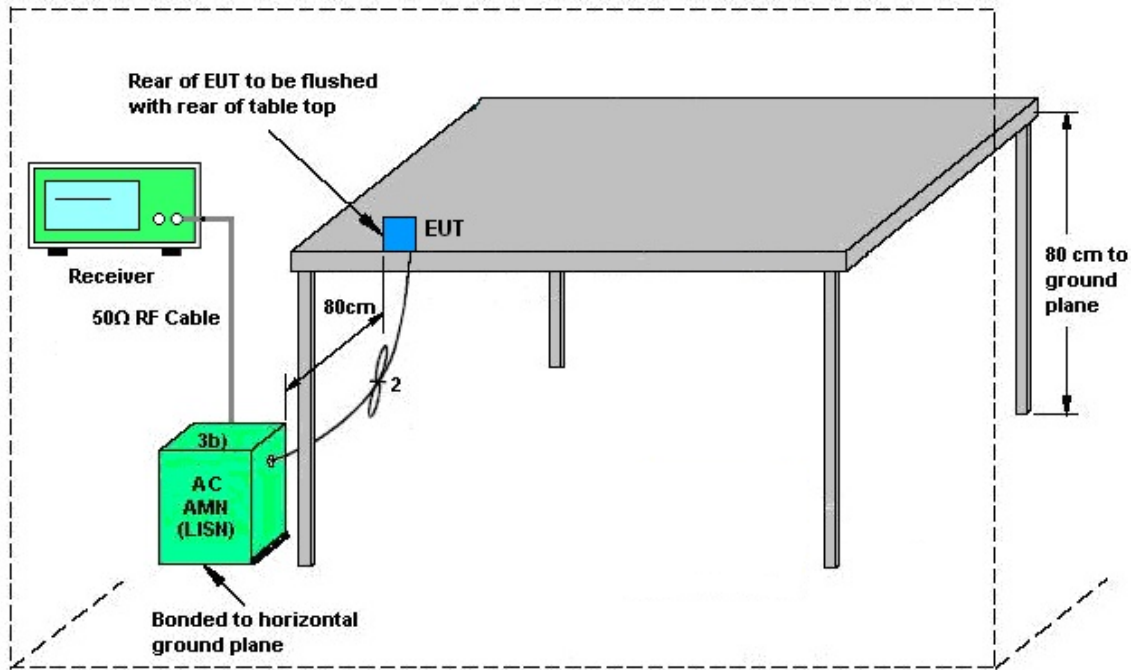

AMN = Artificial mains network (LISN)  
AE = Associated equipment  
EUT = Equipment under test  
ISN = Impedance stabilization network

### 3.6.5 Test Result of AC Conducted Emission

Please refer to Appendix A.



## **3.7 Antenna Requirements**

### **3.7.1 Standard Applicable**

If directional gain of transmitting antennas is greater than 6 dBi, the power shall be reduced by the same level in dB comparing to gain minus 6 dBi. The use of a permanently attached antenna or of an antenna that uses a unique coupling to the intentional radiator shall be considered sufficient to comply with the rule.

### **3.7.2 Antenna Anti-Replacement Construction**

An embedded-in antenna design is used.

### **3.7.3 Antenna Gain**

The antenna peak gain of EUT is less than 6 dBi. Therefore, it is not necessary to reduce maximum peak output power limit.



## 4 List of Measuring Equipment

Instrument	Brand Name	Model No.	Serial No.	Characteristics	Calibration Date	Test Date	Due Date	Remark
Loop Antenna	Rohde & Schwarz	HFH2-Z2	100488	9 kHz~30 MHz	Jul. 14, 2020	Mar. 24, 2021~ Apr. 14, 2021	Jul. 13, 2021	Radiation (03CH13-HY)
Bilog Antenna	TESEQ	CBL 6111D & 00800N1D01 N-06	40103 & 07	30MHz~1GHz	Apr. 29, 2020	Mar. 24, 2021~ Apr. 14, 2021	Apr. 28, 2021	Radiation (03CH13-HY)
Horn Antenna	SCHWARZBE CK	BBHA 9120 D	9120D-124 1	1GHz~18GHz	Jul. 15, 2020	Mar. 24, 2021~ Apr. 14, 2021	Jul. 14, 2021	Radiation (03CH13-HY)
SHF-EHF Horn Antenna	SCHWARZBE CK	BBHA 9170	BBHA9170 576	18GHz~40GHz	May 22, 2020	Mar. 24, 2021~ Apr. 14, 2021	May 21, 2021	Radiation (03CH13-HY)
Preamplifier	MITEQ	AMF-7D-0010 1800-30-10P	1590074	1GHz~18GHz	May 19, 2020	Mar. 24, 2021~ Apr. 14, 2021	May 18, 2021	Radiation (03CH13-HY)
Preamplifier	Keysight	83017A	MY532701 47	1GHz~26.5GHz	Oct. 28, 2020	Mar. 24, 2021~ Apr. 14, 2021	Oct. 27, 2021	Radiation (03CH13-HY)
Preamplifier	EMEC	EM18G40G	0600789	18GHz~40GHz	Jul. 31, 2020	Mar. 24, 2021~ Apr. 14, 2021	Jul. 30, 2021	Radiation (03CH13-HY)
Spectrum Analyzer	Keysight	N9010B	MY602405 20	10Hz~44GHz	Dec. 02, 2020	Mar. 24, 2021~ Apr. 14, 2021	Dec. 01, 2021	Radiation (03CH13-HY)
RF Cable	HUBER + SUHNER	SUCOFLEX 104	MY9837/4 PE	9kHz~30MHz	Mar. 11, 2021	Mar. 24, 2021~ Apr. 14, 2021	Mar. 10, 2022	Radiation (03CH13-HY)
RF Cable	HUBER + SUHNER	SUCOFLEX 102	MY4274/2	30MHz~40GHz	Mar. 11, 2021	Mar. 24, 2021~ Apr. 14, 2021	Mar. 10, 2022	Radiation (03CH13-HY)
RF Cable	HUBER + SUHNER	SUCOFLEX 126E	0030/126E	30MHz~18GHz	Feb. 10, 2021	Mar. 24, 2021~ Apr. 14, 2021	Feb. 09, 2022	Radiation (03CH13-HY)
RF Cable	HUBER + SUHNER	SUCOFLEX 104	804793/4	30MHz~18GHz	Feb. 10, 2021	Mar. 24, 2021~ Apr. 14, 2021	Feb. 09, 2022	Radiation (03CH13-HY)
RF Cable	HUBER + SUHNER	SUCOFLEX 104	MY24961/ 4	30MHz~18GHz	Feb. 10, 2021	Mar. 24, 2021~ Apr. 14, 2021	Feb. 09, 2022	Radiation (03CH13-HY)
Antenna Mast	EMEC	AM-BS-4500- B	N/A	1m~4m	N/A	Mar. 24, 2021~ Apr. 14, 2021	N/A	Radiation (03CH13-HY)
Turn Table	EMEC	TT2000	N/A	0~360 Degree	N/A	Mar. 24, 2021~ Apr. 14, 2021	N/A	Radiation (03CH13-HY)
Software	AUDIX	E3 6.2009-8-24c	RK-001124	N/A	N/A	Mar. 24, 2021~ Apr. 14, 2021	N/A	Radiation (03CH13-HY)
EMI Test Receiver	Keysight	N9038A(MXE )	MY532900 45	20MHz~8.4GHz	Jan. 13, 2021	Mar. 24, 2021~ Apr. 14, 2021	Jan. 12, 2022	Radiation (03CH13-HY)
Filter	Wainwright	WHKX12-270 0-3000-18000 -60SS	SN2	3GHz High Pass Filter	Jul. 13, 2020	Mar. 24, 2021~ Apr. 14, 2021	Jul. 12, 2021	Radiation (03CH13-HY)
Filter	Wainwright	WHKX8-5872. 5-6750-18000 -40ST	SN5	6.75GHz High Pass Filter	Mar. 11, 2021	Mar. 24, 2021~ Apr. 14, 2021	Mar. 10, 2022	Radiation (03CH13-HY)
Amplifier	Sonoma-Instru ment	310 N	187282	9KHz~1GHz	Dec. 16, 2020	Mar. 24, 2021~ Apr. 14, 2021	Dec. 15, 2021	Radiation (03CH13-HY)
Filter	Wainwright	WLK4-1000-1 530-8000-40S S	SN12	1.53GHz Low Pass Filter	Sep. 15, 2020	Mar. 24, 2021~ Apr. 14, 2021	Sep. 14, 2021	Radiation (03CH13-HY)





Instrument	Brand Name	Model No.	Serial No.	Characteristics	Calibration Date	Test Date	Due Date	Remark
AC Power Source	ACPOWER	AFC-11003G	F3170400 33	N/A	N/A	Apr. 27, 2021	N/A	Conduction (CO07-HY)
Software	Rohde & Schwarz	EMC32 V10.30	N/A	N/A	N/A	Apr. 27, 2021	N/A	Conduction (CO07-HY)
Pulse Limiter	SCHWARZBE CK	VTSD 9561-F N	9561-F N00373	9kHz-200MHz	Nov. 02, 2020	Apr. 27, 2021	Nov. 01, 2021	Conduction (CO07-HY)
RF Cable	HUBER + SUHNER	RG 214/U	1358175	9kHz~30MHz	N/A	Apr. 27, 2021	N/A	Conduction (CO07-HY)
Two-Line V-Network	TESEQ	NNB 51	45051	N/A	Feb. 01, 2021	Apr. 27, 2021	Jan. 31, 2022	Conduction (CO07-HY)
EMI Test Receiver	Rohde & Schwarz	ESR3	102317	9kHz~3.6GHz	Sep. 11, 2020	Apr. 27, 2021	Sep. 10, 2021	Conduction (CO07-HY)
Hygrometer	Testo	608-H1	34893241	N/A	Mar. 02, 2021	Mar. 15, 2021~ Mar. 23, 2021	Mar. 01, 2022	Conducted (TH05-HY)
Power Sensor	DARE	RPR3006W	16I00054S NO12	10MHz~6GHz	Dec. 16, 2020	Mar. 15, 2021~ Mar. 23, 2021	Dec. 15, 2021	Conducted (TH05-HY)
Signal Analyzer	Rohde & Schwarz	FSV40	101566	10Hz ~ 40GHz	Jul. 22, 2020	Mar. 15, 2021~ Mar. 23, 2021	Jul. 21, 2021	Conducted (TH05-HY)
Switch Control Manframe	E-IUSTRUME NT	ETF-1405-0	EC190015 7	N/A	Aug. 15 ,2020	Mar. 15, 2021~ Mar. 23, 2021	Aug. 14, 2021	Conducted (TH05-HY)



## 5 Uncertainty of Evaluation

### Uncertainty of Conducted Emission Measurement (150 kHz ~ 30 MHz)

Measuring Uncertainty for a Level of Confidence of 95% ( $U = 2Uc(y)$ )	2.2
---	-----

### Uncertainty of Radiated Emission Measurement (30 MHz ~ 1000 MHz)

Measuring Uncertainty for a Level of Confidence of 95% ( $U = 2Uc(y)$ )	4.8
---	-----

### Uncertainty of Radiated Emission Measurement (1000 MHz ~ 18000 MHz)

Measuring Uncertainty for a Level of Confidence of 95% ( $U = 2Uc(y)$ )	5.1
---	-----

### Uncertainty of Radiated Emission Measurement (18000 MHz ~ 40000 MHz)

Measuring Uncertainty for a Level of Confidence of 95% ( $U = 2Uc(y)$ )	4.6
---	-----



## Appendix A. AC Conducted Emission Test Results

Test Engineer :	Tom Lee	Temperature :	23~26°C
		Relative Humidity :	40~50%

## EUT Information

Report NO : 0D2423  
 Test Mode : Mode 1  
 Test Voltage : 120Vac/60Hz  
 Phase : Line

Full Spectrum

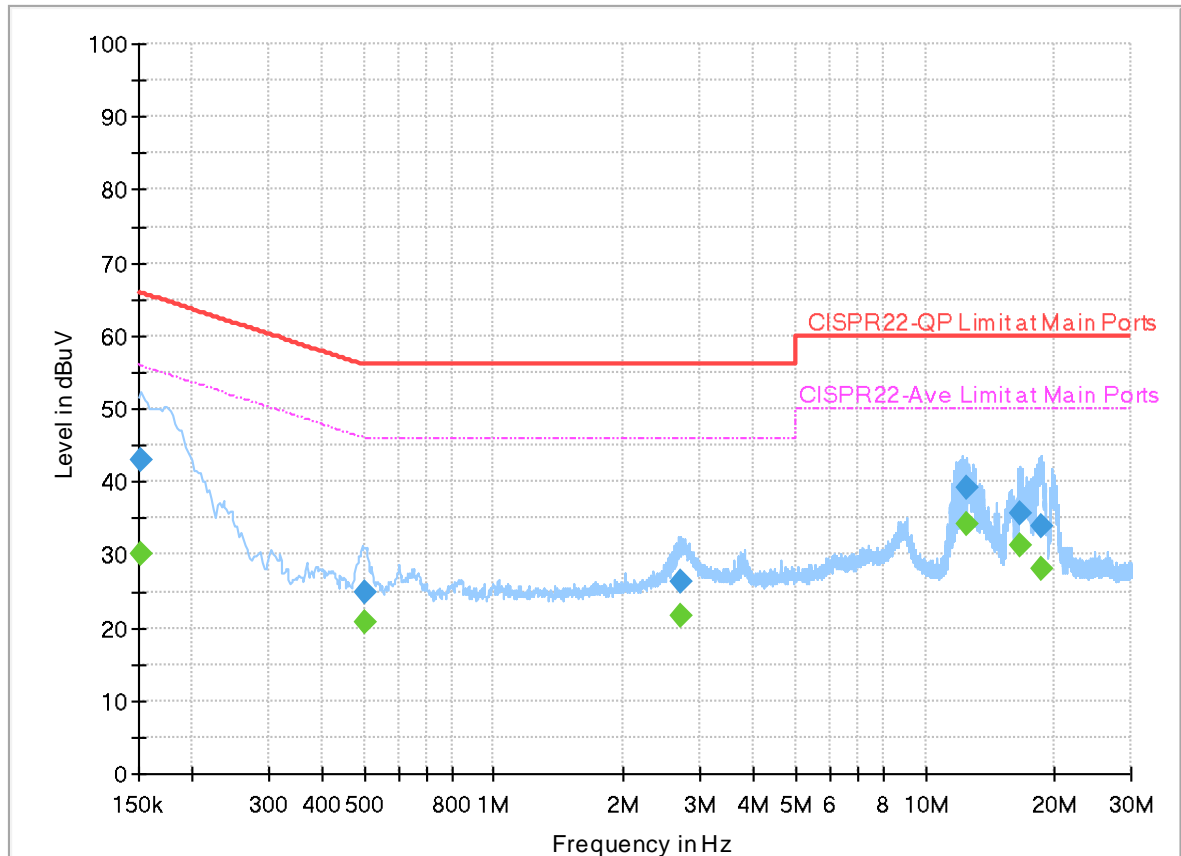

## Final\_Result

Frequency (MHz)	QuasiPeak (dBuV)	CAverage (dBuV)	Limit (dBuV)	Margin (dB)	Line	Filter	Corr. (dB)
0.152250	---	30.20	55.88	25.68	L1	OFF	20.0
0.152250	43.10	---	65.88	22.78	L1	OFF	20.0
0.501000	---	20.89	46.00	25.11	L1	OFF	20.0
0.501000	24.80	---	56.00	31.20	L1	OFF	20.0
2.719500	---	21.73	46.00	24.27	L1	OFF	20.1
2.719500	26.27	---	56.00	29.73	L1	OFF	20.1
12.491250	---	34.11	50.00	15.89	L1	OFF	20.2
12.491250	39.22	---	60.00	20.78	L1	OFF	20.2
16.599750	---	31.27	50.00	18.73	L1	OFF	20.2
16.599750	35.77	---	60.00	24.23	L1	OFF	20.2
18.577500	---	28.03	50.00	21.97	L1	OFF	20.2
18.577500	33.94	---	60.00	26.06	L1	OFF	20.2

## EUT Information

Report NO : 0D2423  
 Test Mode : Mode 1  
 Test Voltage : 120Vac/60Hz  
 Phase : Neutral

Full Spectrum

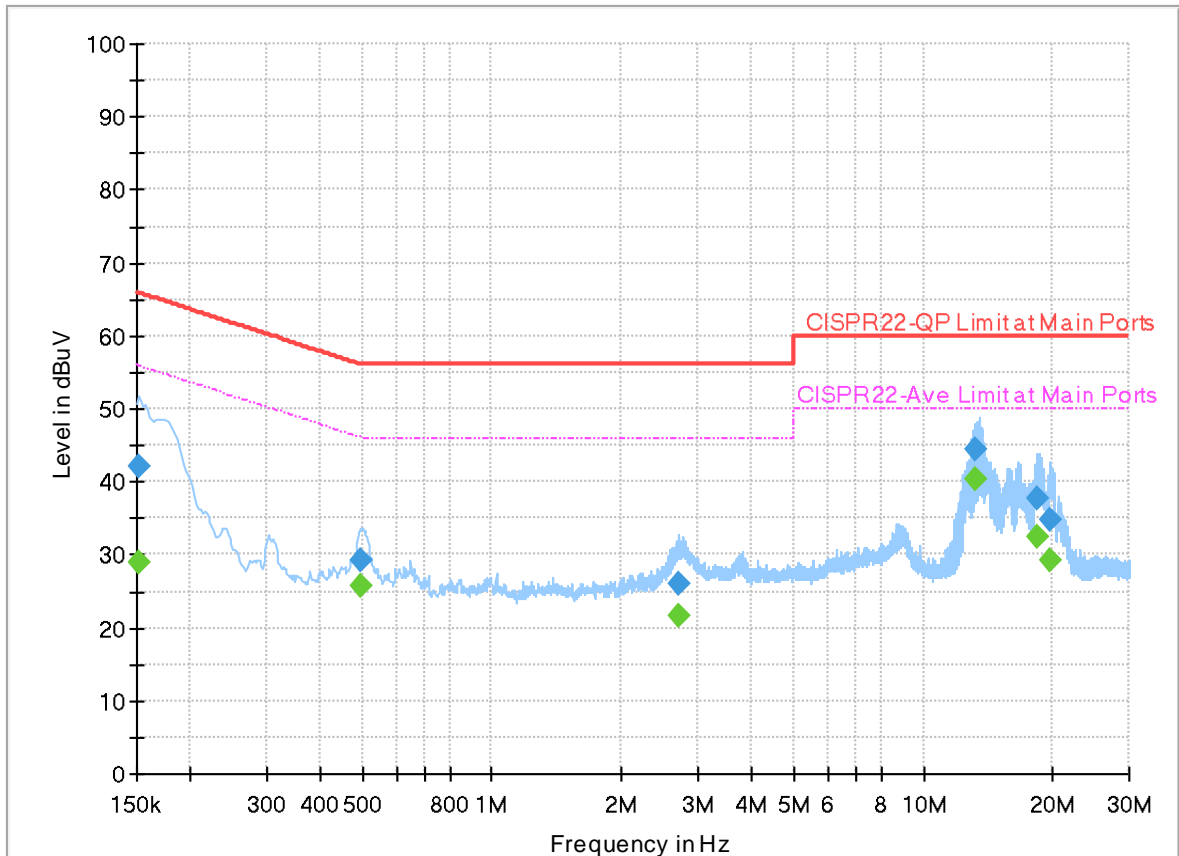

## Final\_Result

Frequency (MHz)	QuasiPeak (dBuV)	CAverage (dBuV)	Limit (dBuV)	Margin (dB)	Line	Filter	Corr. (dB)
0.152250	---	28.98	55.88	26.90	N	OFF	20.0
0.152250	42.14	---	65.88	23.74	N	OFF	20.0
0.494250	---	25.79	46.10	20.31	N	OFF	20.0
0.494250	29.15	---	56.10	26.95	N	OFF	20.0
2.717250	---	21.69	46.00	24.31	N	OFF	20.1
2.717250	26.08	---	56.00	29.92	N	OFF	20.1
13.240500	---	40.42	50.00	9.58	N	OFF	20.2
13.240500	44.44	---	60.00	15.56	N	OFF	20.2
18.462750	---	32.39	50.00	17.61	N	OFF	20.3
18.462750	37.75	---	60.00	22.25	N	OFF	20.3
19.770000	---	29.33	50.00	20.67	N	OFF	20.3
19.770000	34.78	---	60.00	25.22	N	OFF	20.3



## Appendix B. Radiated Spurious Emission

Test Engineer :	Daniel Lee, Jacky Hung and Wilson Wu	Temperature :	20~25°C
		Relative Humidity :	50~60%

<1Mbps>

2.4GHz 2400~2483.5MHz

BLE (Band Edge @ 3m)

BLE	Note	Frequency ( MHz )	Level ( dBμV/m )	Over Limit ( dB )	Limit Line ( dBμV/m )	Read Level ( dBμV )	Antenna Factor ( dB/m )	Path Loss ( dB )	Preamp Factor ( dB )	Ant Pos ( cm )	Table Pos ( deg )	Peak Avg. ( P/A )	Pol. ( H/V )	
BLE CH 00 2402MHz		2322.915	55.11	-18.89	74	41.17	27.75	14.05	27.86	378	66	P	H	
		2343.285	46.1	-7.9	54	32.17	27.71	14.07	27.85	378	66	A	H	
	*	2402	98.14	-	-	84.25	27.6	14.13	27.84	378	66	P	H	
	*	2402	97.77	-	-	83.88	27.6	14.13	27.84	378	66	A	H	
													H	
			2343.39	55.54	-18.46	74	41.61	27.71	14.07	27.85	320	172	P	V
			2342.97	46.16	-7.84	54	32.23	27.71	14.07	27.85	320	172	A	V
	*		2402	96.09	-	-	82.2	27.6	14.13	27.84	320	172	P	V
	*		2402	95.48	-	-	81.59	27.6	14.13	27.84	320	172	A	V
														V
BLE CH 19 2440MHz		2380.14	54.57	-19.43	74	40.66	27.64	14.11	27.84	369	62	P	H	
		2377.76	45.65	-8.35	54	31.74	27.64	14.11	27.84	369	62	A	H	
	*	2440	96.12	-	-	82.27	27.52	14.16	27.83	369	62	P	H	
	*	2440	95.7	-	-	81.85	27.52	14.16	27.83	369	62	A	H	
			2493.35	54.37	-19.63	74	40.49	27.5	14.2	27.82	369	62	P	H
			2493.21	44.41	-9.59	54	30.53	27.5	14.2	27.82	369	62	A	H
			2384.06	54.91	-19.09	74	41.01	27.63	14.11	27.84	313	171	P	V
			2378.74	46.23	-7.77	54	32.32	27.64	14.11	27.84	313	171	A	V
	*		2440	95.33	-	-	81.48	27.52	14.16	27.83	313	171	P	V
	*		2440	94.7	-	-	80.85	27.52	14.16	27.83	313	171	A	V
			2496.71	54.37	-19.63	74	40.48	27.5	14.21	27.82	313	171	P	V
			2496.92	44.4	-9.6	54	30.51	27.5	14.21	27.82	313	171	A	V



<b>BLE CH 39 2480MHz</b>	*	2480	94.45	-	-	80.58	27.5	14.19	27.82	400	62	P	H
	*	2480	94.01	-	-	80.14	27.5	14.19	27.82	400	62	A	H
		2491.4	54.8	-19.2	74	40.92	27.5	14.2	27.82	400	62	P	H
		2485.04	44.43	-9.57	54	30.55	27.5	14.2	27.82	400	62	A	H
													H
													H
	*	2480	92.81	-	-	78.94	27.5	14.19	27.82	295	171	P	V
	*	2480	92.02	-	-	78.15	27.5	14.19	27.82	295	171	A	V
		2498.36	54.42	-19.58	74	40.53	27.5	14.21	27.82	295	171	P	V
		2492	44.55	-9.45	54	30.67	27.5	14.2	27.82	295	171	A	V
													V
													V
<b>Remark</b>	1. No other spurious found. 2. All results are PASS against Peak and Average limit line.												



2.4GHz 2400~2483.5MHz  
BLE (Harmonic @ 3m)

BLE	Note	Frequency ( MHz )	Level ( dBµV/m )	Over Limit ( dB )	Limit Line ( dBµV/m )	Read Level ( dBµV )	Antenna Factor ( dB/m )	Path Loss ( dB )	Preamp Factor ( dB )	Ant Pos ( cm )	Table Pos ( deg )	Peak Avg. ( P/A )	Pol. ( H/V )	
BLE CH 00 2402MHz		4804	45.96	-28.04	74	65.83	31.11	6.51	57.49	100	0	P	H	
													H	
													H	
													H	
		4804	44.71	-29.29	74	64.58	31.11	6.51	57.49	100	0	P	V	
														V
														V
BLE CH 19 2440MHz		4880	48.06	-25.94	74	67.36	31.2	6.83	57.33	100	0	P	H	
		7320	44.69	-29.31	74	56.3	36.76	8.73	57.1	100	0	P	H	
													H	
													H	
		4880	47.23	-26.77	74	66.53	31.2	6.83	57.33	100	0	P	V	
		7320	45.68	-28.32	74	57.29	36.76	8.73	57.1	100	0	P	V	
														V
BLE CH 39 2480MHz		4960	47.93	-26.07	74	66.5	31.42	7.17	57.16	100	0	P	H	
		7440	43.94	-30.06	74	55.7	36.82	8.7	57.28	100	0	P	H	
													H	
													H	
		4960	47.46	-26.54	74	66.03	31.42	7.17	57.16	100	0	P	V	
		7440	44.08	-29.92	74	55.84	36.82	8.7	57.28	100	0	P	V	
														V
Remark	1. No other spurious found. 2. All results are PASS against Peak and Average limit line.													





Emission below 1GHz

2.4GHz BLE (LF)

BLE	Note	Frequency	Level	Over	Limit	Read	Antenna	Path	Preamp	Ant	Table	Peak	Pol.	
		( MHz )	( dBμV/m )	( dB )	( dBμV/m )	( dBμV )	( dB/m )	( dB )	( dB )	( cm )	( deg )	( P/A )	( H/V )	
2.4GHz BLE LF		30.97	22.13	-17.87	40	29.63	24.21	0.52	32.23	-	-	P	H	
		259.89	34.88	-11.12	46	45.65	19.77	1.48	32.02	-	-	P	H	
		406.36	36.73	-9.27	46	44.4	22.13	1.77	31.57	100	0	P	H	
		742.95	31.19	-14.81	46	32.5	27.98	2.46	31.75	-	-	P	H	
		830.25	31.13	-14.87	46	31.39	28.37	2.61	31.24	-	-	P	H	
		954.41	33.63	-12.37	46	30.91	30.68	2.81	30.77	-	-	P	H	
														H
														H
														H
														H
														H
														H
			31.94	22.4	-17.6	40	30.48	23.62	0.53	32.23	-	-	P	V
			260.86	25.69	-20.31	46	36.44	19.79	1.48	32.02	-	-	P	V
			415.09	29.73	-16.27	46	37	22.54	1.79	31.6	-	-	P	V
			738.1	30.44	-15.56	46	31.91	27.87	2.45	31.79	-	-	P	V
			840.92	30.65	-15.35	46	30.46	28.77	2.63	31.21	-	-	P	V
			924.34	32.23	-13.77	46	31.14	29.26	2.75	30.92	100	0	P	V
														V
														V
													V	
													V	
													V	
													V	
Remark	1. No other spurious found. 2. All results are PASS against limit line.													



<2Mbps>

2.4GHz 2400~2483.5MHz

BLE (Band Edge @ 3m)

BLE	Note	Frequency	Level	Over Limit	Limit Line	Read Level	Antenna Factor	Path Loss	Preamp Factor	Ant Pos	Table Pos	Peak Avg.	Pol.	
		( MHz )	( dBμV/m )	( dB )	( dBμV/m )	( dBμV )	( dB/m )	( dB )	( dB )	( cm )	( deg )	( P/A )	( H/V )	
BLE CH 00 2402MHz		2331	54.54	-19.46	74	40.59	27.74	14.06	27.85	381	62	P	H	
		2344.44	46.38	-7.62	54	32.45	27.71	14.07	27.85	381	62	A	H	
	*	2402	97.97	-	-	84.08	27.6	14.13	27.84	381	62	P	H	
	*	2402	97.42	-	-	83.53	27.6	14.13	27.84	381	62	A	H	
													H	
													H	
			2319.975	54.71	-19.29	74	40.76	27.76	14.05	27.86	323	174	P	V
			2343.495	46.15	-7.85	54	32.22	27.71	14.07	27.85	323	174	A	V
	*		2402	96.19	-	-	82.3	27.6	14.13	27.84	323	174	P	V
	*		2402	95.8	-	-	81.91	27.6	14.13	27.84	323	174	A	V
													V	
												V		
BLE CH 19 2440MHz		2384.34	55.24	-18.76	74	41.34	27.63	14.11	27.84	367	59	P	H	
		2377.62	45.23	-8.77	54	31.32	27.64	14.11	27.84	367	59	A	H	
	*	2440	96.34	-	-	82.49	27.52	14.16	27.83	367	59	P	H	
	*	2440	95.7	-	-	81.85	27.52	14.16	27.83	367	59	A	H	
			2493.35	55.22	-18.78	74	41.34	27.5	14.2	27.82	367	59	P	H
			2493.56	44.51	-9.49	54	30.63	27.5	14.2	27.82	367	59	A	H
			2344.02	54.51	-19.49	74	40.58	27.71	14.07	27.85	316	173	P	V
			2377.62	46.1	-7.9	54	32.19	27.64	14.11	27.84	316	173	A	V
	*		2440	95.15	-	-	81.3	27.52	14.16	27.83	316	173	P	V
	*		2440	94.65	-	-	80.8	27.52	14.16	27.83	316	173	A	V
			2499.09	54.11	-19.89	74	40.22	27.5	14.21	27.82	316	173	P	V
		2493.49	44.58	-9.42	54	30.7	27.5	14.2	27.82	316	173	A	V	



<b>BLE CH 39 2480MHz</b>	*	2480	95.36	-	-	81.49	27.5	14.19	27.82	400	63	P	H
	*	2480	93.96	-	-	80.09	27.5	14.19	27.82	400	63	A	H
		2484.4	54.5	-19.5	74	40.62	27.5	14.2	27.82	400	63	P	H
		2483.68	44.52	-9.48	54	30.64	27.5	14.2	27.82	400	63	A	H
													H
													H
	*	2480	93.58	-	-	79.71	27.5	14.19	27.82	294	154	P	V
	*	2480	92.18	-	-	78.31	27.5	14.19	27.82	294	154	A	V
		2491.2	54.73	-19.27	74	40.85	27.5	14.2	27.82	294	154	P	V
		2487.16	44.49	-9.51	54	30.61	27.5	14.2	27.82	294	154	A	V
													V
													V
<b>Remark</b>	1. No other spurious found. 2. All results are PASS against Peak and Average limit line.												



2.4GHz 2400~2483.5MHz  
BLE (Harmonic @ 3m)

BLE	Note	Frequency ( MHz )	Level ( dBμV/m )	Over Limit ( dB )	Limit Line ( dBμV/m )	Read Level ( dBμV )	Antenna Factor ( dB/m )	Path Loss ( dB )	Preamp Factor ( dB )	Ant Pos ( cm )	Table Pos ( deg )	Peak Avg. ( P/A )	Pol. ( H/V )	
BLE CH 00 2402MHz		4804	45.17	-28.83	74	65.04	31.11	6.51	57.49	100	0	P	H	
													H	
													H	
													H	
		4804	43.74	-30.26	74	63.61	31.11	6.51	57.49	100	0	P	V	
														V
														V
BLE CH 19 2440MHz		4880	47.91	-26.09	74	67.21	31.2	6.83	57.33	100	0	P	H	
		7320	45.06	-28.94	74	56.67	36.76	8.73	57.1	100	0	P	H	
													H	
													H	
		4880	46.39	-27.61	74	65.69	31.2	6.83	57.33	100	0	P	V	
		7320	45.13	-28.87	74	56.74	36.76	8.73	57.1	100	0	P	V	
														V
BLE CH 39 2480MHz		4960	48.21	-25.79	74	66.78	31.42	7.17	57.16	100	0	P	H	
		7440	43.92	-30.08	74	55.68	36.82	8.7	57.28	100	0	P	H	
													H	
													H	
		4960	46.88	-27.12	74	65.45	31.42	7.17	57.16	100	0	P	V	
		7440	45.19	-28.81	74	56.95	36.82	8.7	57.28	100	0	P	V	
														V
Remark	1. No other spurious found.													
	2. All results are PASS against Peak and Average limit line.													



Emission below 1GHz

2.4GHz BLE (LF)

BLE	Note	Frequency	Level	Over	Limit	Read	Antenna	Path	Preamp	Ant	Table	Peak	Pol.	
		( MHz )	( dBμV/m )	( dB )	( dBμV/m )	( dBμV )	( dB/m )	( dB )	( dB )	( cm )	( deg )	( P/A )	( H/V )	
2.4GHz BLE LF		30	21.81	-18.19	40	28.93	24.59	0.51	32.22	-	-	P	H	
		259.89	34.64	-11.36	46	45.41	19.77	1.48	32.02	-	-	P	H	
		325.85	31.95	-14.05	46	42.45	19.66	1.62	31.78	-	-	P	H	
		410.24	36.94	-9.06	46	44.45	22.29	1.78	31.58	100	0	P	H	
		854.5	31.39	-14.61	46	30.9	29.01	2.65	31.17	-	-	P	H	
		940.83	32.71	-13.29	46	30.8	29.97	2.78	30.84	-	-	P	H	
														H
														H
														H
														H
														H
														H
			57.16	24.67	-15.33	40	44.18	12.08	0.69	32.28	-	-	P	V
			90.14	32.48	-11.02	43.5	48.98	14.87	0.87	32.24	100	0	P	V
			408.3	29.67	-16.33	46	37.25	22.21	1.78	31.57	-	-	P	V
			787.57	30.28	-15.72	46	31.05	28.11	2.53	31.41	-	-	P	V
			839.95	31.7	-14.3	46	31.55	28.74	2.62	31.21	-	-	P	V
			903	32.23	-13.77	46	31.73	28.82	2.71	31.03	-	-	P	V
														V
														V
													V	
													V	
													V	
													V	
Remark	1. No other spurious found. 2. All results are PASS against limit line.													



**Note symbol**

*	<b>Fundamental Frequency</b> which can be ignored. However, the level of any unwanted emissions shall not exceed the level of the fundamental frequency.
!	Test result is <b>over limit</b> line.
P/A	<b>Peak</b> or <b>Average</b>
H/V	<b>Horizontal</b> or <b>Vertical</b>



A calculation example for radiated spurious emission is shown as below:

BLE	Note	Frequency	Level	Over	Limit	Read	Antenna	Path	Preamp	Ant	Table	Peak	Pol.
		( MHz )	( dBμV/m )	( dB )	Limit Line	Level	Factor	Loss	Factor	Pos	Pos	Avg.	
					( dBμV/m )	( dBμV )	( dB/m )	( dB )	( dB )	( cm )	( deg )	( P/A )	( H/V )
BLE CH 00 2402MHz		2390	55.45	-18.55	74	54.51	32.22	4.58	35.86	103	308	P	H
		2390	43.54	-10.46	54	42.6	32.22	4.58	35.86	103	308	A	H

1. Path Loss(dB) = Cable loss(dB) + Filter loss(dB) + Attenuator loss(dB)
2. Level(dBμV/m) =  
Antenna Factor(dB/m) + Path Loss(dB) + Read Level(dBμV) - Preamp Factor(dB)
3. Over Limit(dB) = Level(dBμV/m) – Limit Line(dBμV/m)

**For Peak Limit @ 2390MHz:**

1. Level(dBμV/m)  
= Antenna Factor(dB/m) + Path Loss(dB) + Read Level(dBμV) - Preamp Factor(dB)  
= 32.22(dB/m) + 4.58(dB) + 54.51(dBμV) – 35.86 (dB)  
= 55.45 (dBμV/m)
2. Over Limit(dB)  
= Level(dBμV/m) – Limit Line(dBμV/m)  
= 55.45(dBμV/m) – 74(dBμV/m)  
= -18.55(dB)

**For Average Limit @ 2390MHz:**

1. Level(dBμV/m)  
= Antenna Factor(dB/m) + Path Loss(dB) + Read Level(dBμV) - Preamp Factor(dB)  
= 32.22(dB/m) + 4.58(dB) + 42.6(dBμV) – 35.86 (dB)  
= 43.54 (dBμV/m)
2. Over Limit(dB)  
= Level(dBμV/m) – Limit Line(dBμV/m)  
= 43.54(dBμV/m) – 54(dBμV/m)  
= -10.46(dB)

**Both peak and average measured complies with the limit line, so test result is “PASS”.**



## Appendix C. Radiated Spurious Emission Plots

Test Engineer :	Daniel Lee, Jacky Hung and Wilson Wu	Temperature :	20~25°C
		Relative Humidity :	50~60%

### Note symbol

-L	Low channel location
-R	High channel location





<1Mbps>

2.4GHz 2400~2483.5MHz

BLE (Band Edge @ 3m)

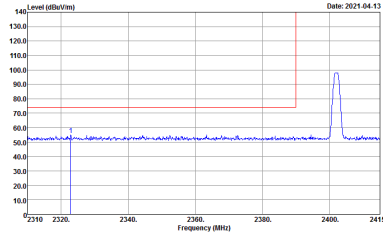
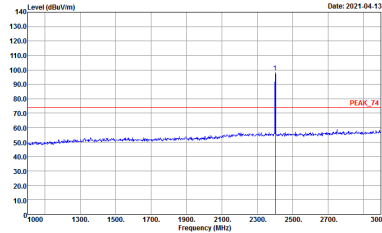
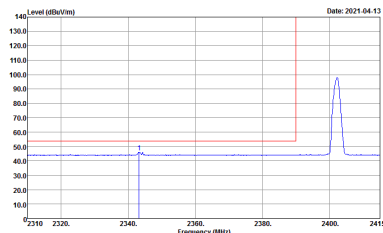
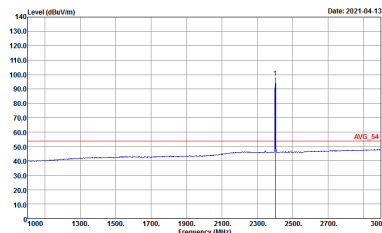
BLE	2.4GHz 2400~2483.5MHz Band Edge @ 3m	
	BLE CH00 2402MHz	
	Horizontal	Fundamental
Peak	 <p>Site : 03CH13-HY Condition : PEAK_BE_74 3m HORN_91200_1241 HORIZONTAL : RBW:1000.000KHz VBW:3000.000KHz SWT:Auto</p>	 <p>Site : 03CH13-HY Condition : PEAK_74 3m HORN_91200_1241 HORIZONTAL : RBW:1000.000KHz VBW:3000.000KHz SWT:Auto</p>
Avg.	 <p>Site : 03CH13-HY Condition : AVG_BE_54 3m HORN_91200_1241 HORIZONTAL : RBW:1000.000KHz VBW:1000KHz SWT:Auto</p>	 <p>Site : 03CH13-HY Condition : AVG_54 3m HORN_91200_1241 HORIZONTAL : RBW:1000.000KHz VBW:1000KHz SWT:Auto</p>



BLE	2.4GHz 2400~2483.5MHz Band Edge @ 3m	
BLE CH00 2402MHz		
	Vertical	Fundamental
Peak	<p>Site : 03CH13-HY Condition : PEAK_BE_74 3m HORN_91200_1241 VERTICAL : RBW:1000.000KHz VBW:3000.000KHz SWT:Auto</p>	<p>Site : 03CH13-HY Condition : PEAK_74 3m HORN_91200_1241 VERTICAL : RBW:1000.000KHz VBW:3000.000KHz SWT:Auto</p>
Avg	<p>Site : 03CH13-HY Condition : AV6_BE_54 3m HORN_91200_1241 VERTICAL : RBW:1000.000KHz VBW:1000KHz SWT:Auto</p>	<p>Site : 03CH13-HY Condition : AV6_54 3m HORN_91200_1241 VERTICAL : RBW:1000.000KHz VBW:1000KHz SWT:Auto</p>

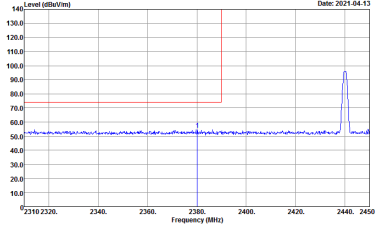
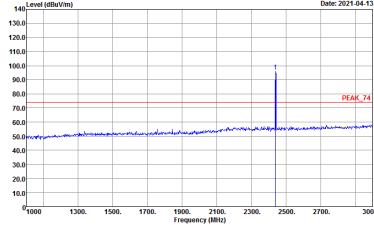
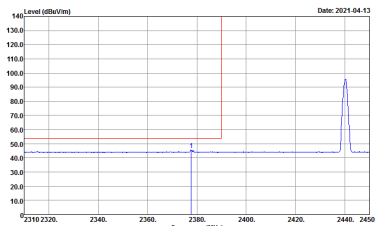
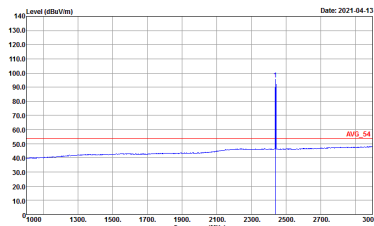

BLE	2.4GHz 2400~2483.5MHz Band Edge @ 3m	
	BLE CH19 2440MHz - L	
	Horizontal	Fundamental
Peak	 <p>Date: 2021-04-13</p> <p>Site : 03CH13-1FV Condition : PEAK_BE_74 3m HORN_9120D_1241 HORIZONTAL : RBW:1000.000KHz VBW:3000.000KHz SWT:Auto</p>	 <p>Date: 2021-04-13</p> <p>Site : 03CH13-1FV Condition : PEAK_74 3m HORN_9120D_1241 HORIZONTAL : RBW:1000.000KHz VBW:3000.000KHz SWT:Auto</p>
Avg.	 <p>Date: 2021-04-13</p> <p>Site : 03CH13-1FV Condition : AVG_BE_54 3m HORN_9120D_1241 HORIZONTAL : RBW:1000.000KHz VBW:1.000KHz SWT:Auto</p>	 <p>Date: 2021-04-13</p> <p>Site : 03CH13-1FV Condition : AVG_54 3m HORN_9120D_1241 HORIZONTAL : RBW:1000.000KHz VBW:1.000KHz SWT:Auto</p>

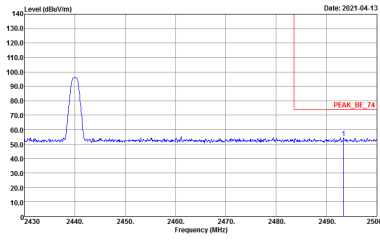
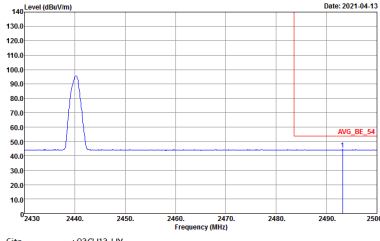

BLE	2.4GHz 2400~2483.5MHz Band Edge @ 3m	
BLE CH19 2440MHz - R		
	Horizontal	Fundamental
Peak	 <p>Site : 03CH13-HY Condition : PEAK_BE_74 3m HORN_91200_1241 HORIZONTAL RBW:1000.000KHz VBW:3000.000KHz SWT:Auto</p>	Left blank
Avg.	 <p>Site : 03CH13-HY Condition : AV6_BE_54 3m HORN_91200_1241 HORIZONTAL RBW:1000.000KHz VBW:1.000KHz SWT:Auto</p>	Left blank

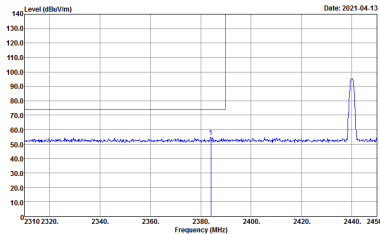
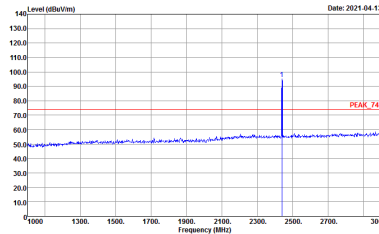
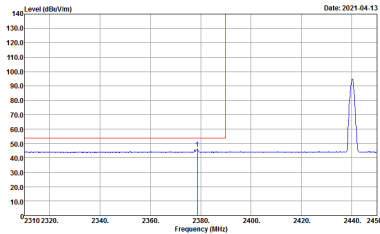
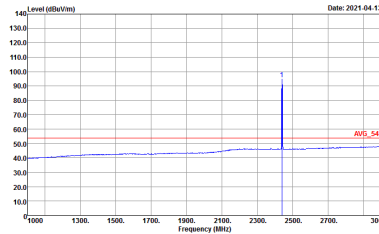

BLE	2.4GHz 2400~2483.5MHz Band Edge @ 3m	
BLE CH19 2440MHz - L		
	Vertical	Fundamental
Peak	 <p>Site : 03CH13-HY Condition : PEAK_BE_74 3m HORN_91200_1241 VERTICAL : RBW:1000.000KHz VBW:3000.000KHz SWT:Auto</p>	 <p>Site : 03CH13-HY Condition : PEAK_74 3m HORN_91200_1241 VERTICAL : RBW:1000.000KHz VBW:3000.000KHz SWT:Auto</p>
Avg.	 <p>Site : 03CH13-HY Condition : AVG_BE_54 3m HORN_91200_1241 VERTICAL : RBW:1000.000KHz VBW:1000KHz SWT:Auto</p>	 <p>Site : 03CH13-HY Condition : AVG_54 3m HORN_91200_1241 VERTICAL : RBW:1000.000KHz VBW:1000KHz SWT:Auto</p>

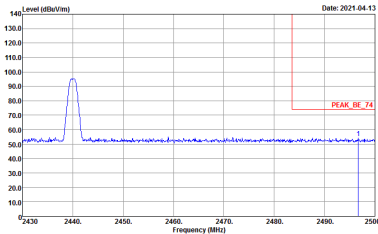
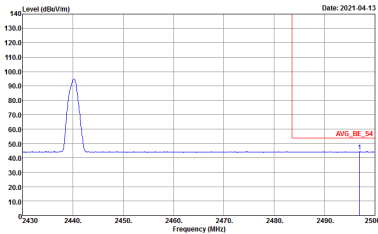

BLE	2.4GHz 2400~2483.5MHz Band Edge @ 3m	
BLE CH19 2440MHz - R		
	Vertical	Fundamental
Peak	 <p>Site : 03CH13-HY Condition : PEAK_BE_74 3m HORN_91200_1241 VERTICAL : RBW:1000.000KHz VBW:3000.000KHz SWT:Auto</p>	Left blank
Avg.	 <p>Site : 03CH13-HY Condition : AVG_BE_54 3m HORN_91200_1241 VERTICAL : RBW:1000.000KHz VBW:1000KHz SWT:Auto</p>	Left blank



BLE	2.4GHz 2400~2483.5MHz Band Edge @ 3m	
BLE CH39 2480MHz		
	Horizontal	Fundamental
Peak	<p>Site : 03CH13-HY Condition : PEAK_BE_74 3m HORN_91200_1241 HORIZONTAL : RBW:1000.000KHz VBW:3000.000KHz SWT:Auto</p>	<p>Site : 03CH13-HY Condition : PEAK_74 3m HORN_91200_1241 HORIZONTAL : RBW:1000.000KHz VBW:3000.000KHz SWT:Auto</p>
Avg.	<p>Site : 03CH13-HY Condition : AVG_BE_54 3m HORN_91200_1241 HORIZONTAL : RBW:1000.000KHz VBW:1000KHz SWT:Auto</p>	<p>Site : 03CH13-HY Condition : AVG_54 3m HORN_91200_1241 HORIZONTAL : RBW:1000.000KHz VBW:1000KHz SWT:Auto</p>



BLE	2.4GHz 2400~2483.5MHz Band Edge @ 3m	
BLE CH39 2480MHz		
	Vertical	Fundamental
Peak	<p>Site : 03CH13-HY Condition : PEAK_BE_74 3m HORN_91200_1241 VERTICAL : RBW:1000.000KHz VBW:3000.000KHz SWT:Auto</p>	<p>Site : 03CH13-HY Condition : PEAK_74 3m HORN_91200_1241 VERTICAL : RBW:1000.000KHz VBW:3000.000KHz SWT:Auto</p>
Avg.	<p>Site : 03CH13-HY Condition : AVG_BE_54 3m HORN_91200_1241 VERTICAL : RBW:1000.000KHz VBW:1000KHz SWT:Auto</p>	<p>Site : 03CH13-HY Condition : AVG_54 3m HORN_91200_1241 VERTICAL : RBW:1000.000KHz VBW:1000KHz SWT:Auto</p>





2.4GHz 2400~2483.5MHz

BLE (Harmonic @ 3m)

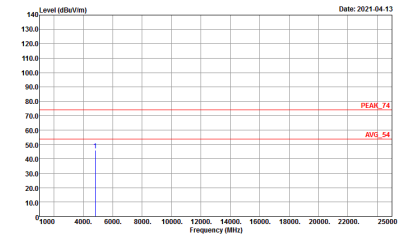
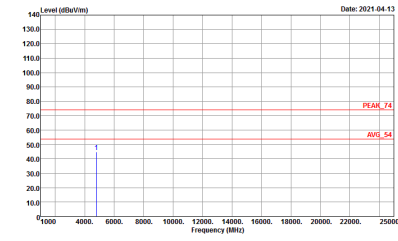
BLE	2.4GHz 2400~2483.5MHz Harmonic @ 3m	
BLE CH00 2402MHz		
Horizontal		Vertical
<p><b>Peak</b></p> <p><b>Avg.</b></p>	 <p>Site : 03CH13-HY Condition : PEAK_74 3m HORN_9120D_1241 HORIZONTAL Detector : Peak</p>	 <p>Site : 03CH13-HY Condition : PEAK_74 3m HORN_9120D_1241 VERTICAL Detector : Peak</p>



BLE	2.4GHz 2400~2483.5MHz Harmonic @ 3m	
	BLE CH19 2440MHz	
	Horizontal	Vertical
<b>Peak</b> <b>Avg.</b>	<p>Site : 03CH13-HY Condition : PEAK_T4 3m HORN_9120D_1241 HORIZONTAL Detector : Peak</p>	<p>Site : 03CH13-HY Condition : PEAK_T4 3m HORN_9120D_1241 VERTICAL Detector : Peak</p>



BLE	2.4GHz 2400~2483.5MHz Harmonic @ 3m	
	BLE CH39 2480MHz	
	Horizontal	Vertical
<b>Peak</b>	<p>Site : 03CH13-HY Condition : PEAK_74 3m HORN_9120D_1241 HORIZONTAL Detector : Peak</p>	<p>Site : 03CH13-HY Condition : PEAK_74 3m HORN_9120D_1241 VERTICAL Detector : Peak</p>



Emission below 1GHz  
2.4GHz BLE (LF)

BLE	2.4GHz 2400~2483.5MHz	
	BLE LF	
	Horizontal	Vertical
QP / Peak	<p>Site : 03CH13-HY Condition : QP 3m BIL06_40103 HORIZONTAL Detector : Peak</p>	<p>Site : 03CH13-HY Condition : QP 3m BIL06_40103 VERTICAL Detector : Peak</p>



<2Mbps>

2.4GHz 2400~2483.5MHz

BLE (Band Edge @ 3m)

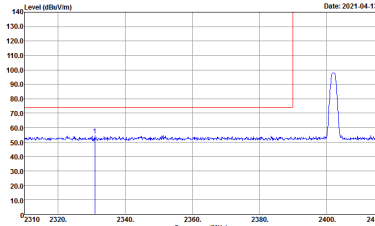
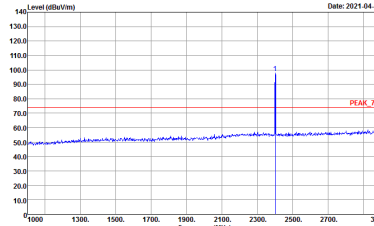
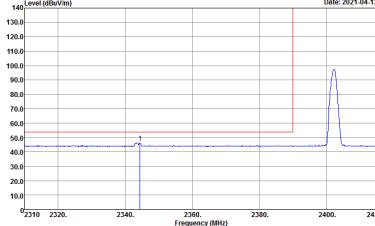
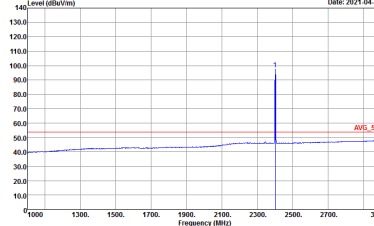
BLE	2.4GHz 2400~2483.5MHz Band Edge @ 3m	
	BLE CH00 2402MHz	
	Horizontal	Fundamental
Peak	 <p>Site : 03CH13-HY Condition : PEAK_BE_74 3m HORN_91200_1241 HORIZONTAL : RBW:1000.000KHz VBW:3000.000KHz SWT:Auto</p>	 <p>Site : 03CH13-HY Condition : PEAK_74 3m HORN_91200_1241 HORIZONTAL : RBW:1000.000KHz VBW:3000.000KHz SWT:Auto</p>
Avg.	 <p>Site : 03CH13-HY Condition : AVG_BE_54 3m HORN_91200_1241 HORIZONTAL : RBW:1000.000KHz VBW:1000KHz SWT:Auto</p>	 <p>Site : 03CH13-HY Condition : AVG_54 3m HORN_91200_1241 HORIZONTAL : RBW:1000.000KHz VBW:1000KHz SWT:Auto</p>



BLE	2.4GHz 2400~2483.5MHz Band Edge @ 3m	
BLE CH00 2402MHz		
	Vertical	Fundamental
Peak	<p>Site : 03CH13-HY Condition : PEAK_BE_74 3m HORN_91200_1241 VERTICAL : RBW:1000.000KHz VBW:3000.000KHz SWT:Auto</p>	<p>Site : 03CH13-HY Condition : PEAK_74 3m HORN_91200_1241 VERTICAL : RBW:1000.000KHz VBW:3000.000KHz SWT:Auto</p>
Avg	<p>Site : 03CH13-HY Condition : AVG_BE_54 3m HORN_91200_1241 VERTICAL : RBW:1000.000KHz VBW:1000KHz SWT:Auto</p>	<p>Site : 03CH13-HY Condition : AVG_54 3m HORN_91200_1241 VERTICAL : RBW:1000.000KHz VBW:1000KHz SWT:Auto</p>

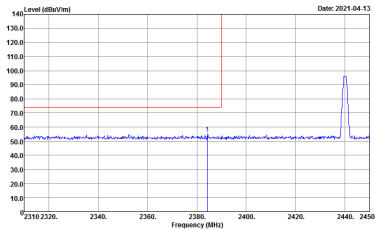
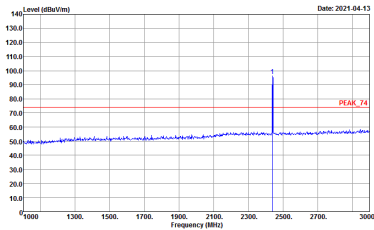
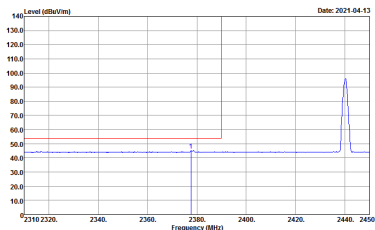
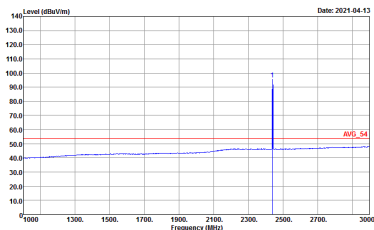

BLE	2.4GHz 2400~2483.5MHz Band Edge @ 3m	
	BLE CH19 2440MHz - L	
	Horizontal	Fundamental
Peak	 <p>Site : 03CH13-1Y Condition : PEAK_BE_74 3m HORN_9120D_1241 HORIZONTAL : RBW:1000.000KHz VBW:3000.000KHz SWT:Auto</p>	 <p>Site : 03CH13-1Y Condition : PEAK_74 3m HORN_9120D_1241 HORIZONTAL : RBW:1000.000KHz VBW:3000.000KHz SWT:Auto</p>
Avg.	 <p>Site : 03CH13-1Y Condition : AVG_BE_54 3m HORN_9120D_1241 HORIZONTAL : RBW:1000.000KHz VBW:1.000KHz SWT:Auto</p>	 <p>Site : 03CH13-1Y Condition : AVG_54 3m HORN_9120D_1241 HORIZONTAL : RBW:1000.000KHz VBW:1.000KHz SWT:Auto</p>



BLE	2.4GHz 2400~2483.5MHz Band Edge @ 3m	
BLE CH19 2440MHz - R		
	Horizontal	Fundamental
<p><b>Peak</b></p>	<p>Site : 03CH13-HY Condition : PEAK_BE_74 3m HORN_91200_1241 HORIZONTAL : RBW:1000.000KHz VBW:3000.000KHz SWT:Auto</p>	<p>Left blank</p>
<p><b>Avg.</b></p>	<p>Site : 03CH13-HY Condition : AVG_BE_54 3m HORN_91200_1241 HORIZONTAL : RBW:1000.000KHz VBW:1000KHz SWT:Auto</p>	<p>Left blank</p>





BLE	2.4GHz 2400~2483.5MHz Band Edge @ 3m	
BLE CH19 2440MHz - L		
	Vertical	Fundamental
Peak	<p>Date: 2021-04-13</p> <p>Site : 03CH13-HY Condition : PEAK_BE_74 3m HORN_91200_1241 VERTICAL : RBW:1000.000KHz VBW:3000.000KHz SWT:Auto</p>	<p>Date: 2021-04-13</p> <p>Site : 03CH13-HY Condition : PEAK_74 3m HORN_91200_1241 VERTICAL : RBW:1000.000KHz VBW:3000.000KHz SWT:Auto</p>
Avg.	<p>Date: 2021-04-13</p> <p>Site : 03CH13-HY Condition : AV6_BE_54 3m HORN_91200_1241 VERTICAL : RBW:1000.000KHz VBW:1000KHz SWT:Auto</p>	<p>Date: 2021-04-13</p> <p>Site : 03CH13-HY Condition : AV6_54 3m HORN_91200_1241 VERTICAL : RBW:1000.000KHz VBW:1000KHz SWT:Auto</p>

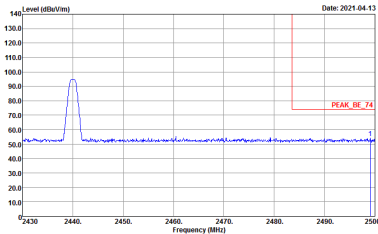
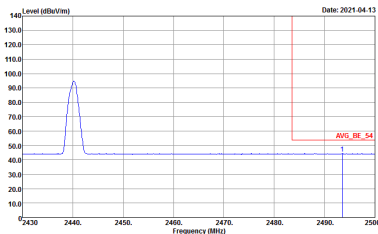

BLE	2.4GHz 2400~2483.5MHz Band Edge @ 3m	
BLE CH19 2440MHz - R		
	Vertical	Fundamental
Peak	 <p>Site : 03CH13-HY Condition : PEAK_BE_74 3m HORN_91200_1241 VERTICAL : RBW:1000.000KHz VBW:3000.000KHz SWT:Auto</p>	Left blank
Avg.	 <p>Site : 03CH13-HY Condition : AVG_BE_54 3m HORN_91200_1241 VERTICAL : RBW:1000.000KHz VBW:1.000KHz SWT:Auto</p>	Left blank



BLE	2.4GHz 2400~2483.5MHz Band Edge @ 3m	
BLE CH39 2480MHz		
	Horizontal	Fundamental
Peak	<p>Site : 03CH13-HY Condition : PEAK_BE_74 3m HORN_91200_1241 HORIZONTAL : RBW:1000.000KHz VBW:3000.000KHz SWT:Auto</p>	<p>Site : 03CH13-HY Condition : PEAK_74 3m HORN_91200_1241 HORIZONTAL : RBW:1000.000KHz VBW:3000.000KHz SWT:Auto</p>
Avg.	<p>Site : 03CH13-HY Condition : AVG_BE_54 3m HORN_91200_1241 HORIZONTAL : RBW:1000.000KHz VBW:1000KHz SWT:Auto</p>	<p>Site : 03CH13-HY Condition : AVG_54 3m HORN_91200_1241 HORIZONTAL : RBW:1000.000KHz VBW:1000KHz SWT:Auto</p>



BLE	2.4GHz 2400~2483.5MHz Band Edge @ 3m	
BLE CH39 2480MHz		
	Vertical	Fundamental
Peak	<p>Site : 03CH13-HY Condition : PEAK_BE_74 3m HORN_91200_1241 VERTICAL : RBW:1000.000KHz VBW:3000.000KHz SWT:Auto</p>	<p>Site : 03CH13-HY Condition : PEAK_74 3m HORN_91200_1241 VERTICAL : RBW:1000.000KHz VBW:3000.000KHz SWT:Auto</p>
Avg.	<p>Site : 03CH13-HY Condition : AV6_BE_54 3m HORN_91200_1241 VERTICAL : RBW:1000.000KHz VBW:1000KHz SWT:Auto</p>	<p>Site : 03CH13-HY Condition : AV6_54 3m HORN_91200_1241 VERTICAL : RBW:1000.000KHz VBW:1000KHz SWT:Auto</p>



2.4GHz 2400~2483.5MHz

BLE (Harmonic @ 3m)

BLE	2.4GHz 2400~2483.5MHz Harmonic @ 3m	
	BLE CH00 2402MHz	
	Horizontal	Vertical
<b>Peak</b> <b>Avg.</b>	<p>Site : 03CH13-HY Condition : PEAK_74 3m HORN_91200_1241 HORIZONTAL Detector : Peak</p>	<p>Site : 03CH13-HY Condition : PEAK_74 3m HORN_91200_1241 VERTICAL Detector : Peak</p>



BLE	2.4GHz 2400~2483.5MHz Harmonic @ 3m	
	BLE CH19 2440MHz	
	Horizontal	Vertical
<b>Peak</b> <b>Avg.</b>	<p>Site : 03CH13-HY Condition : PEAK_74 3m HORN_9120D_1241 HORIZONTAL Detector : Peak</p>	<p>Site : 03CH13-HY Condition : PEAK_74 3m HORN_9120D_1241 VERTICAL Detector : Peak</p>



BLE	2.4GHz 2400~2483.5MHz Harmonic @ 3m	
	BLE CH39 2480MHz	
	Horizontal	Vertical
Peak	<p>Site : 03CH13-HY Condition : PEAK_74 3m HORN_9120D_1241 HORIZONTAL Detector : Peak</p>	<p>Site : 03CH13-HY Condition : PEAK_74 3m HORN_9120D_1241 VERTICAL Detector : Peak</p>



Emission below 1GHz  
2.4GHz BLE (LF)

BLE	2.4GHz 2400~2483.5MHz	
	BLE LF	
	Horizontal	Vertical
QP / Peak	<p>Site : 03CH13-HY Condition : QP 3m BIL06_40103 HORIZONTAL Detector : Peak</p>	<p>Site : 03CH13-HY Condition : QP 3m BIL06_40103 VERTICAL Detector : Peak</p>





## Appendix D. Duty Cycle Plots

Band	Duty Cycle(%)	T(us)	1/T(kHz)	VBW Setting	Duty Factor(dB)
Bluetooth –LE for 1Mbps	85.2	1070	0.93	1kHz	0.70
Bluetooth –LE for 2Mbps	42.8	2130	0.47	1kHz	3.69

