



# SPORTON International Inc.

No. 52, Hwa Ya 1st Rd., Hwa Ya Technology Park, Kwei-Shan Hsiang, Tao Yuan Hsien, Taiwan, R.O.C.  
Ph: 886-3-327-3456 / FAX: 886-3-327-0973 / www.sporton.com.tw

## FCC RADIO TEST REPORT

Applicant's company	Proxim Wireless Corporation
Applicant Address	1561 Buckeye Drive, Milpitas, CA 95035, USA
FCC ID	HZB-XB92WFR
Manufacturer's company	Proxim Wireless Corporation
Manufacturer Address	1561 Buckeye Drive, Milpitas, CA 95035, USA

Product Name	802.11 a/n PCIe Module
Brand Name	Proxim
Model No.	XB92HPW
Test Rule Part(s)	47 CFR FCC Part 15 Subpart E § 15.407
Test Freq. Range	5150 ~ 5250 MHz
Received Date	Apr. 29, 2013
Final Test Date	Aug. 21, 2014
Submission Type	Class II Change
Operating Mode	Master

### Statement

**Test result included is for the IEEE 802.11n and IEEE 802.11a of the product.**

The test result in this report refers exclusively to the presented test model / sample.

Without written approval of SPORTON International Inc., the test report shall not be reproduced except in full.

The measurements and test results shown in this test report were made in accordance with the procedures and found in compliance with the limit given in **ANSI C63.10-2009, 47 CFR FCC Part 15 Subpart E, KDB789033 D02 v01, KDB662911 D01 v02r01.**

The test equipment used to perform the test is calibrated and traceable to NML/ROC.





## Table of Contents

<b>1. CERTIFICATE OF COMPLIANCE .....</b>	<b>1</b>
<b>2. SUMMARY OF THE TEST RESULT .....</b>	<b>2</b>
<b>3. GENERAL INFORMATION .....</b>	<b>3</b>
3.1. Product Details.....	3
3.2. Accessories.....	6
3.3. Table for Filed Antenna.....	7
3.4. Table for Carrier Frequencies .....	8
3.5. Table for Test Modes.....	9
3.6. Table for Testing Locations.....	10
3.7. Table for Class II Change .....	11
3.8. Table for Supporting Units .....	11
3.9. Table for Parameters of Test Software Setting .....	12
3.10. EUT Operation during Test .....	16
3.11. Duty Cycle.....	17
3.12. Test Configurations .....	18
<b>4. TEST RESULT .....</b>	<b>19</b>
4.1. 26dB Bandwidth and 99% Occupied Bandwidth Measurement.....	19
4.2. Maximum Conducted Output Power Measurement.....	80
4.3. Power Spectral Density Measurement .....	92
4.4. Radiated Emissions Measurement .....	124
4.5. Band Edge Emissions Measurement .....	187
4.6. Frequency Stability Measurement .....	209
4.7. Antenna Requirements .....	211
<b>5. LIST OF MEASURING EQUIPMENTS .....</b>	<b>212</b>
<b>6. MEASUREMENT UNCERTAINTY.....</b>	<b>214</b>
<b>APPENDIX A. TEST PHOTOS .....</b>	<b>A1 ~ A7</b>
<b>APPENDIX B. MAXIMUM PERMISSIBLE EXPOSURE .....</b>	<b>B1 ~ B3</b>
<b>APPENDIX C. MAXIMUM E.I.R.P. AT ANY ELEVATION ANGLE ABOVE 30 DEGREES</b>	



## History of This Test Report

REPORT NO.	VERSION	DESCRIPTION	ISSUED DATE
FR342910-07	Rev. 01	Initial issue of report	Aug. 29, 2014

## 1. CERTIFICATE OF COMPLIANCE

Product Name : 802.11 a/n PCIe Module  
Brand Name : Proxim  
Model No. : XB92HPW  
Applicant : Proxim Wireless Corporation  
Test Rule Part(s) : 47 CFR FCC Part 15 Subpart E § 15.407

Sporton International as requested by the applicant to evaluate the EMC performance of the product sample received on Apr. 29, 2013 would like to declare that the tested sample has been evaluated and found to be in compliance with the tested rule parts. The data recorded as well as the test configuration specified is true and accurate for showing the sample's EMC nature.

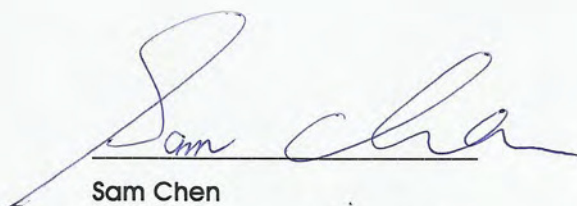

Sam Chen

SPORTON INTERNATIONAL INC.

## 2. SUMMARY OF THE TEST RESULT

Applied Standard: 47 CFR FCC Part 15 Subpart E				
Part	Rule Section	Description of Test	Result	Under Limit
4.1	15.407(a)	26dB Spectrum Bandwidth and 99% Occupied Bandwidth	Complies	-
4.2	15.407(a)	Maximum Conducted Output Power	Complies	2.78 dB
4.3	15.407(a)	Power Spectral Density	Complies	0.02 dB
4.4	15.407(b)	Radiated Emissions	Complies	0.02 dB
4.5	15.407(b)	Band Edge Emissions	Complies	0.04 dB
4.6	15.407(g)	Frequency Stability	Complies	-
4.7	15.203	Antenna Requirements	Complies	-

### 3. GENERAL INFORMATION

#### 3.1. Product Details

##### IEEE 802.11n

Items	Description
Product Type	WLAN (2TX, 2RX)
Radio Type	Intentional Transceiver
Power Type	From host system
Modulation	see the below table for IEEE 802.11n
Data Modulation	OFDM (BPSK / QPSK / 16QAM / 64QAM)
Data Rate (Mbps)	see the below table for IEEE 802.11n
Frequency Range	5150 ~ 5250 MHz
Channel Number	3 for 5 MHz bandwidth ; 3 for 10 MHz bandwidth ; 4 for 20 MHz bandwidth ; 2 for 40 MHz bandwidth
Channel Band Width (99%)	<p>Mode 1 / P to P MCS0 (5 MHz): 5.48 MHz ; MCS0 (10 MHz): 9.84 MHz MCS0 (20 MHz): 18.40 MHz ; MCS0 (40 MHz): 36.48 MHz</p> <p>Mode 1 / P to M MCS0 (5 MHz): 5.40 MHz ; MCS0 (10 MHz): 9.84 MHz MCS0 (20 MHz): 18.40 MHz ; MCS0 (40 MHz): 36.48 MHz</p> <p>Mode 2 / P to P MCS0 (5 MHz): 5.40 MHz ; MCS0 (10 MHz): 9.92 MHz MCS0 (20 MHz): 18.56 MHz ; MCS0 (40 MHz): 36.48 MHz</p> <p>Mode 2 / P to M MCS0 (5 MHz): 5.40 MHz ; MCS0 (10 MHz): 9.92 MHz MCS0 (20 MHz): 18.56 MHz ; MCS0 (40 MHz): 36.48 MHz</p> <p>Mode 3 / P to M MCS0 (5 MHz): 5.40 MHz ; MCS0 (10 MHz): 9.84 MHz MCS0 (20 MHz): 18.88 MHz ; MCS0 (40 MHz): 36.48 MHz</p>
Maximum Conducted Output Power	<p>Mode 1 / P to P MCS0 (5 MHz): 17.26 dBm ; MCS0 (10 MHz): 17.12 dBm MCS0 (20 MHz): 17.13 dBm ; MCS0 (40 MHz): 16.93 dBm</p> <p>Mode 1 / P to M MCS0 (5 MHz): 14.42 dBm ; MCS0 (10 MHz): 17.12 dBm MCS0 (20 MHz): 17.13 dBm ; MCS0 (40 MHz): 16.93 dBm</p> <p>Mode 2 / P to P MCS0 (5 MHz): 21.87 dBm ; MCS0 (10 MHz): 21.71 dBm MCS0 (20 MHz): 21.90 dBm ; MCS0 (40 MHz): 21.01 dBm</p>



	Mode 2 / P to M MCS0 (5 MHz): 21.87 dBm ; MCS0 (10 MHz): 21.71 dBm MCS0 (20 MHz): 21.90 dBm ; MCS0 (40 MHz): 21.01 dBm Mode 3 / P to M MCS0 (5 MHz): 19.31 dBm ; MCS0 (10 MHz): 22.23 dBm MCS0 (20 MHz): 22.91 dBm ; MCS0 (40 MHz): 21.47 dBm
Carrier Frequencies	Please refer to section 3.4
Antenna	Please refer to section 3.3

**IEEE 802.11a**

Items	Description
Product Type	WLAN (2TX, 2RX)
Radio Type	Intentional Transceiver
Power Type	From host system
Modulation	OFDM for IEEE 802.11a
Data Modulation	OFDM (BPSK / QPSK / 16QAM / 64QAM)
Data Rate (Mbps)	OFDM (6/9/12/18/24/36/48/54)
Frequency Range	5150 ~ 5250 MHz
Channel Number	3 for 5 MHz bandwidth ; 3 for 10 MHz bandwidth ; 4 for 20 MHz bandwidth
Channel Band Width (99%)	Mode 1 / P to P 11a (5 MHz): 4.96 MHz ; 11a (10 MHz): 9.04 MHz 11a (20 MHz): 16.96 MHz Mode 1 / P to M 11a (5 MHz): 5.00 MHz ; 11a (10 MHz): 9.04 MHz 11a (20 MHz): 16.96 MHz Mode 2 / P to P 11a (5 MHz): 5.04 MHz ; 11a (10 MHz): 9.20 MHz 11a (20 MHz): 17.28 MHz Mode 2 / P to M 11a (5 MHz): 5.04 MHz ; 11a (10 MHz): 9.20 MHz 11a (20 MHz): 17.28 MHz Mode 3 / P to M 11a (5 MHz): 5.04 MHz ; 11a (10 MHz): 9.20 MHz 11a (20 MHz): 17.92 MHz
Maximum Conducted Output Power	Mode 1 / P to P 11a (5 MHz): 17.23 dBm ; 11a (10 MHz): 17.14 dBm 11a (20 MHz): 17.22 dBm Mode 1 / P to M 11a (5 MHz): 14.40 dBm ; 11a (10 MHz): 17.14 dBm 11a (20 MHz): 17.22 dBm Mode 2 / P to P 11a (5 MHz): 21.35 dBm ; 11a (10 MHz): 21.66 dBm 11a (20 MHz): 21.73 dBm Mode 2 / P to M 11a (5 MHz): 21.35 dBm ; 11a (10 MHz): 21.66 dBm 11a (20 MHz): 21.73 dBm



	Mode 3 / P to M 11a (5 MHz): 19.33 dBm ; 11a (10 MHz): 21.66 dBm 11a (20 MHz): 22.95 dBm
Carrier Frequencies	Please refer to section 3.4
Antenna	Please refer to section 3.3

Items	Description	
Communication Mode	<input checked="" type="checkbox"/> IP Based (Load Based)	<input type="checkbox"/> Frame Based
Beamforming Function	<input type="checkbox"/> With beamforming	<input checked="" type="checkbox"/> Without beamforming
Band 1 Information	<input checked="" type="checkbox"/> Point-to-multipoint	<input checked="" type="checkbox"/> Fixed point-to-point
	<input type="checkbox"/> Indoor	
	<input checked="" type="checkbox"/> Outdoor	

#### Antenna and Band width

Antenna	Two (TX)			
Band width Mode	5 MHz	10 MHz	20 MHz	40 MHz
IEEE 802.11a	V	V	V	X
IEEE 802.11n	V	V	V	V

#### IEEE 11a/n Spec.

Protocol	Number of Transmit Chains (NTX)	Data Rate / MCS
802.11a (5 MHz)	2	6-54 Mbps
802.11a (10 MHz)	2	6-54 Mbps
802.11a (20 MHz)	2	6-54 Mbps
802.11n (5 MHz)	2	MCS0-15
802.11n (10 MHz)	2	MCS0-15
802.11n (20 MHz)	2	MCS0-15
802.11n (40 MHz)	2	MCS0-15

Note: Modulation modes consist of below configuration: 5 MHz/10 MHz/20 MHz: IEEE 802.11a,  
5 MHz/10 MHz/20 MHz/40 MHz: IEEE 802.11n

### 3.2. Accessories

N/A

### 3.3. Table for Filed Antenna

Ant.	Brand	Model Name	Antenna Type	Connector
1	MARS	MA-WA55-30	Panel Antenna	N Type
2	MARS	MA-WB55-20	Sector Antenna	N Type
3	SmartAnt	SAA08-220570	Omni Antenna	N Jack
4	Grand-Tek	GTT-AC-05-001	Panel Antenna	MMCX type

Ant.	Ant. Gain (dBi)	Cable Loss (dB)	Attenuator (dB)	Test Gain (dBi)	Remark
1	30	2	12	16	(P to P) / (P to M)
2	20	2	10	8	(P to P) / (P to M)
3	10	2	0	8	(P to M)
4	16	0	0	16	(P to P) / (P to M)

Note1 : Ant. 1: 12dB attenuator was added in front of antenna port due to simulate the real cable use.

Ant. 2: 10dB attenuator was added in front of antenna port due to simulate the real cable use.

Note2 : Ant. 1 & Ant. 4 are the same type antennas, only antenna "Ant. 1" was tested and recorded in the report.

Note3 : The EUT has total antennas amounted to four sets.

**For IEEE 802.11a/n mode (2TX/2RX)**

Chain 1 and Chain 2 could transmit/receive simultaneously.

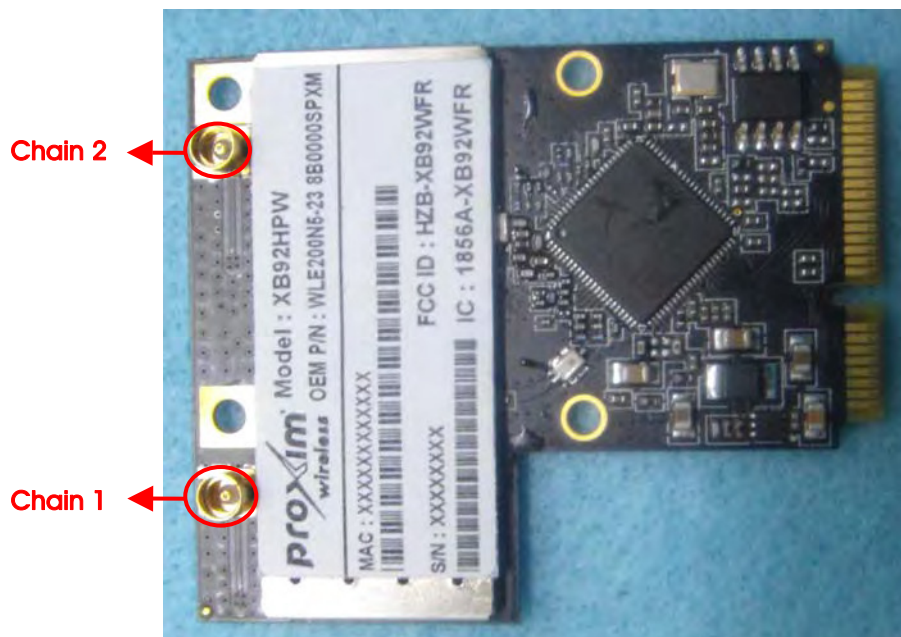

### 3.4. Table for Carrier Frequencies

The EUT has four bandwidth system.

For 5MHz bandwidth systems, use Channel 36, 42, 48.

For 10MHz bandwidth systems, use Channel 36, 42, 48.

For 20MHz bandwidth systems, use Channel 36, 40, 44, 48.

For 40MHz bandwidth systems, use Channel 38, 46.

Frequency Band	Channel No.	Frequency	Channel No.	Frequency
5150~5250 MHz Band 1	36	5180 MHz	44	5220 MHz
	38	5190 MHz	46	5230 MHz
	40	5200 MHz	48	5240 MHz
	42	5210 MHz	-	-

### 3.5. Table for Test Modes

Preliminary tests were performed in different data rate to find the worst radiated emission. The data rate shown in the table below is the worst-case rate with respect to the specific test item. Investigation has been done on all the possible configurations for searching the worst cases. The following table is a list of the test modes shown in this test report.

Test Items	Mode		Data Rate	Channel	Chain
Max. Conducted Output Power	11n (5 MHz)	Band 1	MCS0	36/42/48	1+2
	11n (10 MHz)	Band 1	MCS0	36/42/48	1+2
	11n (20 MHz)	Band 1	MCS0	36/40/48	1+2
	11n (40 MHz)	Band 1	MCS0	38/46	1+2
	11α/BPSK (5 MHz)	Band 1	6Mbps	36/42/48	1+2
	11α/BPSK (10 MHz)	Band 1	6Mbps	36/42/48	1+2
	11α/BPSK (20 MHz)	Band 1	6Mbps	36/40/48	1+2
Power Spectral Density	11n (5 MHz)	Band 1	MCS0	36/42/48	1+2
	11n (10 MHz)	Band 1	MCS0	36/42/48	1+2
	11n (20 MHz)	Band 1	MCS0	36/40/48	1+2
	11n (40 MHz)	Band 1	MCS0	38/46	1+2
	11α/BPSK (5 MHz)	Band 1	6Mbps	36/42/48	1+2
	11α/BPSK (10 MHz)	Band 1	6Mbps	36/42/48	1+2
	11α/BPSK (20 MHz)	Band 1	6Mbps	36/40/48	1+2
26dB&6dB Spectrum Bandwidth 99% Occupied Bandwidth Measurement	11n (5 MHz)	Band 1	MCS0	36/42/48	1+2
	11n (10 MHz)	Band 1	MCS0	36/42/48	1+2
	11n (20 MHz)	Band 1	MCS0	36/40/48	1+2
	11n (40 MHz)	Band 1	MCS0	38/46	1+2
	11α/BPSK (5 MHz)	Band 1	6Mbps	36/42/48	1+2
	11α/BPSK (10 MHz)	Band 1	6Mbps	36/42/48	1+2
	11α/BPSK (20 MHz)	Band 1	6Mbps	36/40/48	1+2
Radiated Emission Above 1GHz	11n (5 MHz)	Band 1	MCS0	36/42/48	1+2
	11n (10 MHz)	Band 1	MCS0	36/42/48	1+2
	11n (20 MHz)	Band 1	MCS0	36/40/48	1+2
	11n (40 MHz)	Band 1	MCS0	38/46	1+2
	11α/BPSK (5 MHz)	Band 1	6Mbps	36/42/48	1+2
	11α/BPSK (10 MHz)	Band 1	6Mbps	36/42/48	1+2
	11α/BPSK (20 MHz)	Band 1	6Mbps	36/40/48	1+2

Band Edge Emission	11n (5 MHz)	Band 1	MCS0	36/42/48	1+2
	11n (10 MHz)	Band 1	MCS0	36/42/48	1+2
	11n (20 MHz)	Band 1	MCS0	36/40/48	1+2
	11n (40 MHz)	Band 1	MCS0	38/46	1+2
	11a/BPSK (5 MHz)	Band 1	6Mbps	36/42/48	1+2
	11a/BPSK (10 MHz)	Band 1	6Mbps	36/42/48	1+2
	11a/BPSK (20 MHz)	Band 1	6Mbps	36/40/48	1+2
Frequency Stability	Un-modulation		-	40	1+2

The following test modes were performed for all tests:

**For Radiated Emission above 1GHz test:**

Mode 1. EUT + Ant. 1

Mode 2. EUT + Ant. 2

Mode 3. EUT + Ant. 3

Note1: The antennas are placed by cross-polarization during operating, therefore no array gain issue will be considered.

Note2: There are two modes of Ant. 1 and Ant 2, one is P to P, and the other is P to M, and all test results were recorded in the report.

### 3.6. Table for Testing Locations

Test Site Location					
Address:	No.8, Lane 724, Bo-ai St., Jhubei City, Hsinchu County 302, Taiwan, R.O.C.				
TEL:	886-3-656-9065				
FAX:	886-3-656-9085				
Test Site No.	Site Category	Location	FCC Reg. No.	IC File No.	VCCI Reg. No
03CH01-CB	SAC	Hsin Chu	262045	IC 4086D	-
TH01-CB	OVEN Room	Hsin Chu	-	-	-

Open Area Test Site (OATS); Semi Anechoic Chamber (SAC).

### 3.7. Table for Class II Change

This product is an extension of original one reported under Sporton project number: 342910-03

Below is the table for the change of the product with respect to the original one.

Modifications	Performance Checking
1. Changing 5GHz Band 1 to "New Rules" from "Old Rules".	1. 26dB Bandwidth and 99% Occupied Bandwidth Measurement
2. Ant. 3 was replaced by another antenna (Model: SAA08-220570, Brand: SmartAnt).	2. Maximum Conducted Output Power Measurement
3. Ant. 1, Ant. 2 and Ant. 4 are equipped with p to p / p to m functions at 5G B1.	3. Power Spectral Density Measurement
4. There is no change in hardware or in existing RF relevant portion.	4. Radiated Emissions above 1GHz
	5. Band Edge Emissions Measurement
	6. Frequency Stability Measurement
	7. Maximum Permissible Exposure

### 3.8. Table for Supporting Units

For Test Site No: 03CH01-CB

Support Unit	Brand	Model	FCC ID
Notebook	DELL	E6430	QDS-BRCM1049LE
Power Supply	Gwinstek	GPC-6030D	N/A
Fixture	Bplus Technology	PE3B	N/A

For Test Site No: TH01-CB

Support Unit	Brand	Model	FCC ID
Notebook	DELL	D420	E2KWM3945ABG
Power Supply	Gwinstek	GPC-6030D	N/A
Fixture	Bplus Technology	PE3B	N/A

### 3.9. Table for Parameters of Test Software Setting

During testing, Channel and Power Controlling Software provided by the customer was used to control the operating channel as well as the output power level. The RF output power selection is for the setting of RF output power expected by the customer and is going to be fixed on the firmware of the final end product.

#### Test Mode 1 / P to P

#### Power Parameters of IEEE 802.11n MCS0 5 MHz

Test Software Version	DOS		
Frequency	5180 MHz	5210 MHz	5240 MHz
MCS0 5 MHz	11	11.5	11.5

#### Power Parameters of IEEE 802.11n MCS0 10 MHz

Test Software Version	DOS		
Frequency	5180 MHz	5210 MHz	5240 MHz
MCS0 10 MHz	11	11.5	11.5

#### Power Parameters of IEEE 802.11n MCS0 20 MHz

Test Software Version	DOS		
Frequency	5180 MHz	5200 MHz	5240 MHz
MCS0 20 MHz	11	11.5	12

#### Power Parameters of IEEE 802.11n MCS0 40 MHz

Test Software Version	DOS	
Frequency	5190 MHz	5230 MHz
MCS0 40 MHz	8	10.5

#### Power Parameters of IEEE 802.11a 5 MHz

Test Software Version	ART v0.9 b27		
Frequency	5180 MHz	5210 MHz	5240 MHz
802.11a 5MHz	11	11.5	11.5

#### Power Parameters of IEEE 802.11a 10 MHz

Test Software Version	DOS		
Frequency	5180 MHz	5210 MHz	5240 MHz
802.11a 10MHz	11	11.5	11

#### Power Parameters of IEEE 802.11a 20 MHz

Test Software Version	DOS		
Frequency	5180 MHz	5200 MHz	5240 MHz
802.11a 20MHz	11.5	11.5	12

**Test Mode 1 / P to M**
**Power Parameters of IEEE 802.11n MCS0 5 MHz**

Test Software Version	DOS		
Frequency	5180 MHz	5210 MHz	5240 MHz
MCS0 5 MHz	9	9	9

**Power Parameters of IEEE 802.11n MCS0 10 MHz**

Test Software Version	DOS		
Frequency	5180 MHz	5210 MHz	5240 MHz
MCS0 10 MHz	11	11.5	11.5

**Power Parameters of IEEE 802.11n MCS0 20 MHz**

Test Software Version	DOS		
Frequency	5180 MHz	5200 MHz	5240 MHz
MCS0 20 MHz	11	11.5	12

**Power Parameters of IEEE 802.11n MCS0 40 MHz**

Test Software Version	DOS	
Frequency	5190 MHz	5230 MHz
MCS0 40 MHz	8	10.5

**Power Parameters of IEEE 802.11a 5 MHz**

Test Software Version	DOS		
Frequency	5180 MHz	5210 MHz	5240 MHz
802.11a 5MHz	9	9	9

**Power Parameters of IEEE 802.11a 10 MHz**

Test Software Version	DOS		
Frequency	5180 MHz	5210 MHz	5240 MHz
802.11a 10MHz	11	11.5	11

**Power Parameters of IEEE 802.11a 20 MHz**

Test Software Version	DOS		
Frequency	5180 MHz	5200 MHz	5240 MHz
802.11a 20MHz	11.5	11.5	12



**Test Mode 2 / P to P**
**Power Parameters of IEEE 802.11n MCS0 5 MHz**

Test Software Version	DOS		
Frequency	5180 MHz	5210 MHz	5240 MHz
MCS0 5 MHz	14.5	14.5	16.5

**Power Parameters of IEEE 802.11n MCS0 10 MHz**

Test Software Version	DOS		
Frequency	5180 MHz	5210 MHz	5240 MHz
MCS0 10 MHz	16	15.5	16.5

**Power Parameters of IEEE 802.11n MCS0 20 MHz**

Test Software Version	DOS		
Frequency	5180 MHz	5200 MHz	5240 MHz
MCS0 20 MHz	13	16.5	16.5

**Power Parameters of IEEE 802.11n MCS0 40 MHz**

Test Software Version	DOS	
Frequency	5190 MHz	5230 MHz
MCS0 40 MHz	9	14.5

**Power Parameters of IEEE 802.11a 5 MHz**

Test Software Version	DOS		
Frequency	5180 MHz	5210 MHz	5240 MHz
802.11a 5MHz	15	15	16

**Power Parameters of IEEE 802.11a 10 MHz**

Test Software Version	DOS		
Frequency	5180 MHz	5210 MHz	5240 MHz
802.11a 10MHz	16	16	16.5

**Power Parameters of IEEE 802.11a 20 MHz**

Test Software Version	DOS		
Frequency	5180 MHz	5200 MHz	5240 MHz
802.11a 20MHz	13.5	16	16.5

**Test Mode 2 / P to M**
**Power Parameters of IEEE 802.11n MCS0 5 MHz**

Test Software Version	DOS		
Frequency	5180 MHz	5210 MHz	5240 MHz
MCS0 5 MHz	14.5	14.5	16.5

**Power Parameters of IEEE 802.11n MCS0 10 MHz**

Test Software Version	DOS		
Frequency	5180 MHz	5210 MHz	5240 MHz
MCS0 10 MHz	16	15.5	16.5

**Power Parameters of IEEE 802.11n MCS0 20 MHz**

Test Software Version	DOS		
Frequency	5180 MHz	5200 MHz	5240 MHz
MCS0 20 MHz	13	16.5	16.5

**Power Parameters of IEEE 802.11n MCS0 40 MHz**

Test Software Version	DOS	
Frequency	5190 MHz	5230 MHz
MCS0 40 MHz	9	14.5

**Power Parameters of IEEE 802.11a 5 MHz**

Test Software Version	DOS		
Frequency	5180 MHz	5210 MHz	5240 MHz
802.11a 5MHz	15	15	16

**Power Parameters of IEEE 802.11a 10 MHz**

Test Software Version	DOS		
Frequency	5180 MHz	5210 MHz	5240 MHz
802.11a 10MHz	16	16	16.5

**Power Parameters of IEEE 802.11a 20 MHz**

Test Software Version	DOS		
Frequency	5180 MHz	5200 MHz	5240 MHz
802.11a 20MHz	13.5	16	16.5

**Test Mode 3 / P to M**
**Power Parameters of IEEE 802.11n MCS0 5 MHz**

Test Software Version	DOS		
Frequency	5180 MHz	5210 MHz	5240 MHz
MCS0 5 MHz	13.5	13.5	14

**Power Parameters of IEEE 802.11n MCS0 10 MHz**

Test Software Version	DOS		
Frequency	5180 MHz	5210 MHz	5240 MHz
MCS0 10 MHz	16.5	14.5	17

**Power Parameters of IEEE 802.11n MCS0 20 MHz**

Test Software Version	DOS		
Frequency	5180 MHz	5200 MHz	5240 MHz
MCS0 20 MHz	13.5	16.5	18.5

**Power Parameters of IEEE 802.11n MCS0 40 MHz**

Test Software Version	DOS	
Frequency	5190 MHz	5230 MHz
MCS0 40 MHz	9.5	15

**Power Parameters of IEEE 802.11a 5 MHz**

Test Software Version	DOS		
Frequency	5180 MHz	5210 MHz	5240 MHz
802.11a 5MHz	13.5	13.5	14

**Power Parameters of IEEE 802.11a 10 MHz**

Test Software Version	DOS		
Frequency	5180 MHz	5210 MHz	5240 MHz
802.11a 10MHz	16	15	16

**Power Parameters of IEEE 802.11a 20 MHz**

Test Software Version	DOS		
Frequency	5180 MHz	5200 MHz	5240 MHz
802.11a 20MHz	15.5	15.5	18.5

### 3.10. EUT Operation during Test

The EUT was programmed to be in continuously transmitting mode.

### 3.11. Duty Cycle

Mode	On Time (ms)	On+Off Time (ms)	Duty Cycle (%)	Duty Factor (dB)	1/T Minimum VBW (kHz)
802.11n MCS0 5 MHz	11.490	11.56	99.39	0.03	0.01
802.11n MCS0 10 MHz	5.810	5.9	98.47	0.07	0.01
802.11n MCS0 20 MHz	2.890	2.96	97.64	0.10	0.35
802.11n MCS0 40 MHz	1.410	1.49	94.63	0.24	0.71
802.11a 5 MHz	12.55	12.58	99.76	0.01	0.01
802.11a 10 MHz	12.59	12.660	99.45	0.02	0.01
802.11a 20 MHz	3.12	3.190	97.81	0.10	0.32

### 3.12. Test Configurations

#### 3.12.1. Radiation Emissions above 1GHz Test Configuration

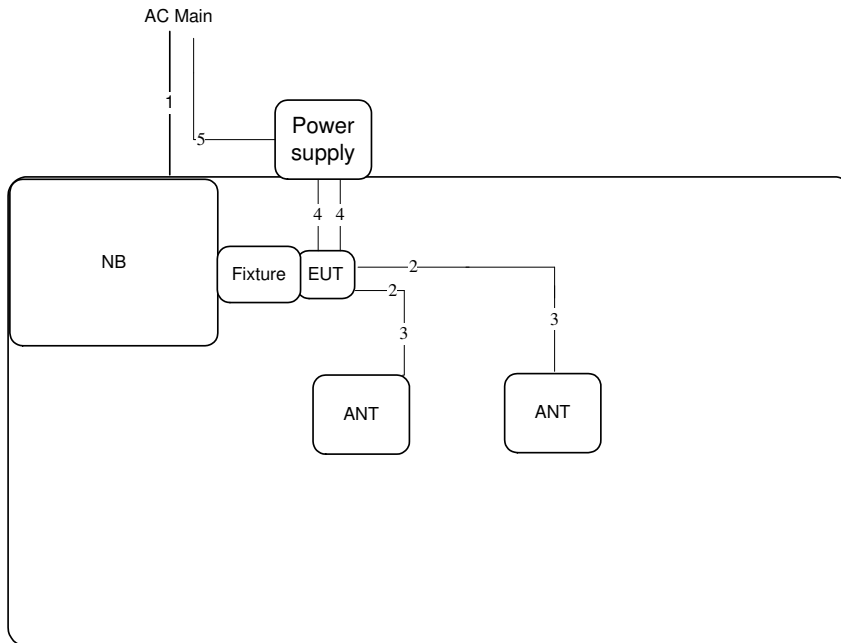

Item	Connection	Shielded	Length
1	AC Power cable	No	1.8m
2	Ant. cable	No	0.17m
3	Ant. cable	No	1m
4	Power supply cable	No	1.1m
5	AC Power cable	No	1.8m

## 4. TEST RESULT

### 4.1. 26dB Bandwidth and 99% Occupied Bandwidth Measurement

#### 4.1.1. Limit

No restriction limits.

#### 4.1.2. Measuring Instruments and Setting

Please refer to section 5 of equipments list in this report. The following table is the setting of the spectrum analyzer.

26dB Bandwidth	
Spectrum Parameters	Setting
Attenuation	Auto
Span Frequency	> 26dB Bandwidth
RBW	Approximately 1% of the emission bandwidth
VBW	VBW > RBW
Detector	Peak
Trace	Max Hold
Sweep Time	Auto
99% Occupied Bandwidth	
Spectrum Parameters	Setting
Span	1.5 times to 5.0 times the OBW
RBW	1 % to 5 % of the OBW
VBW	$\geq 3 \times$ RBW
Detector	Peak
Trace	Max Hold

#### 4.1.3. Test Procedures

For Radiated 26dB Bandwidth and 99% Occupied Bandwidth Measurement:

1. The transmitter was radiated to the spectrum analyzer in peak hold mode.
2. Measure the maximum width of the emission that is 26 dB down from the peak of the emission. Compare this with the RBW setting of the analyzer. Readjust RBW and repeat measurement as needed until the RBW/EBW ratio is approximately 1%.

#### 4.1.4. Test Setup Layout

For Radiated 26dB Bandwidth and 99% Occupied Bandwidth Measurement:

This test setup layout is the same as that shown in section 4.4.4.

#### 4.1.5. Test Deviation

There is no deviation with the original standard.

#### 4.1.6. EUT Operation during Test

The EUT was programmed to be in continuously transmitting mode.

#### 4.1.7. Test Result of 26dB Bandwidth and 99% Occupied Bandwidth

Temperature	26°C	Humidity	63%
Test Engineer	Jim Huang	Configurations	IEEE 802.11n/a
Test Mode	Mode 1 / P to P		

##### Configuration IEEE 802.11n MCS0 5 MHz / Chain 1 + Chain 2

Channel	Frequency	26dB Bandwidth (MHz)	99% Occupied Bandwidth (MHz)
36	5180 MHz	7.92	5.44
42	5210 MHz	7.68	5.48
48	5240 MHz	7.88	5.44

##### Configuration IEEE 802.11n MCS0 10 MHz / Chain 1 + Chain 2

Channel	Frequency	26dB Bandwidth (MHz)	99% Occupied Bandwidth (MHz)
36	5180 MHz	13.68	9.84
42	5210 MHz	14.24	9.76
48	5240 MHz	13.68	9.84

##### Configuration IEEE 802.11n MCS0 20 MHz / Chain 1 + Chain 2

Channel	Frequency	26dB Bandwidth (MHz)	99% Occupied Bandwidth (MHz)
36	5180 MHz	24.96	18.40
40	5200 MHz	25.28	18.40
48	5240 MHz	25.28	18.40

##### Configuration IEEE 802.11n MCS0 40 MHz / Chain 1 + Chain 2

Channel	Frequency	26dB Bandwidth (MHz)	99% Occupied Bandwidth (MHz)
38	5190 MHz	44.48	36.48
46	5230 MHz	44.80	36.48

**Configuration IEEE 802.11a 5MHz / Chain 1 + Chain 2**

Channel	Frequency	26dB Bandwidth (MHz)	99% Occupied Bandwidth (MHz)
36	5180 MHz	7.60	4.92
42	5210 MHz	7.44	4.96
48	5240 MHz	7.24	4.96

**Configuration IEEE 802.11a 10MHz / Chain 1 + Chain 2**

Channel	Frequency	26dB Bandwidth (MHz)	99% Occupied Bandwidth (MHz)
36	5180 MHz	12.88	9.04
42	5210 MHz	12.72	8.96
48	5240 MHz	13.52	8.96

**Configuration IEEE 802.11a 20MHz / Chain 1 + Chain 2**

Channel	Frequency	26dB Bandwidth (MHz)	99% Occupied Bandwidth (MHz)
36	5180 MHz	22.88	16.96
40	5200 MHz	23.52	16.96
48	5240 MHz	23.36	16.96



<b>Temperature</b>	26°C	<b>Humidity</b>	63%
<b>Test Engineer</b>	Jim Huang	<b>Configurations</b>	IEEE 802.11n/a
<b>Test Mode</b>	Mode 1 / P to M		

**Configuration IEEE 802.11n MCS0 5 MHz / Chain 1 + Chain 2**

Channel	Frequency	26dB Bandwidth (MHz)	99% Occupied Bandwidth (MHz)
36	5180 MHz	7.84	5.36
42	5210 MHz	7.92	5.32
48	5240 MHz	8.00	5.40

**Configuration IEEE 802.11n MCS0 10 MHz / Chain 1 + Chain 2**

Channel	Frequency	26dB Bandwidth (MHz)	99% Occupied Bandwidth (MHz)
36	5180 MHz	13.68	9.84
42	5210 MHz	14.24	9.76
48	5240 MHz	13.68	9.84

**Configuration IEEE 802.11n MCS0 20 MHz / Chain 1 + Chain 2**

Channel	Frequency	26dB Bandwidth (MHz)	99% Occupied Bandwidth (MHz)
36	5180 MHz	24.96	18.40
40	5200 MHz	25.28	18.40
48	5240 MHz	25.28	18.40

**Configuration IEEE 802.11n MCS0 40 MHz / Chain 1 + Chain 2**

Channel	Frequency	26dB Bandwidth (MHz)	99% Occupied Bandwidth (MHz)
38	5190 MHz	44.48	36.48
46	5230 MHz	44.80	36.48

**Configuration IEEE 802.11a 5MHz / Chain 1 + Chain 2**

Channel	Frequency	26dB Bandwidth (MHz)	99% Occupied Bandwidth (MHz)
36	5180 MHz	7.28	5.00
42	5210 MHz	7.40	5.00
48	5240 MHz	7.28	5.00

**Configuration IEEE 802.11a 10MHz / Chain 1 + Chain 2**

Channel	Frequency	26dB Bandwidth (MHz)	99% Occupied Bandwidth (MHz)
36	5180 MHz	12.88	9.04
42	5210 MHz	12.72	8.96
48	5240 MHz	13.52	8.96

**Configuration IEEE 802.11a 20MHz / Chain 1 + Chain 2**

Channel	Frequency	26dB Bandwidth (MHz)	99% Occupied Bandwidth (MHz)
36	5180 MHz	22.88	16.96
40	5200 MHz	23.52	16.96
48	5240 MHz	23.36	16.96

<b>Temperature</b>	26°C	<b>Humidity</b>	63%
<b>Test Engineer</b>	Jim Huang	<b>Configurations</b>	IEEE 802.11n/a
<b>Test Mode</b>	Mode 2 / P to P		

**Configuration IEEE 802.11n MCS0 5 MHz / Chain 1 + Chain 2**

Channel	Frequency	26dB Bandwidth (MHz)	99% Occupied Bandwidth (MHz)
36	5180 MHz	7.76	5.36
42	5210 MHz	7.84	5.40
48	5240 MHz	9.04	5.40

**Configuration IEEE 802.11n MCS0 10 MHz / Chain 1 + Chain 2**

Channel	Frequency	26dB Bandwidth (MHz)	99% Occupied Bandwidth (MHz)
36	5180 MHz	15.12	9.84
42	5210 MHz	14.88	9.92
48	5240 MHz	17.20	9.84

**Configuration IEEE 802.11n MCS0 20 MHz / Chain 1 + Chain 2**

Channel	Frequency	26dB Bandwidth (MHz)	99% Occupied Bandwidth (MHz)
36	5180 MHz	25.60	18.24
40	5200 MHz	30.72	18.56
48	5240 MHz	26.24	18.56

**Configuration IEEE 802.11n MCS0 40 MHz / Chain 1 + Chain 2**

Channel	Frequency	26dB Bandwidth (MHz)	99% Occupied Bandwidth (MHz)
38	5190 MHz	45.12	36.48
46	5230 MHz	64.64	36.48

**Configuration IEEE 802.11a 5MHz / Chain 1 + Chain 2**

Channel	Frequency	26dB Bandwidth (MHz)	99% Occupied Bandwidth (MHz)
36	5180 MHz	7.36	5.04
42	5210 MHz	7.60	5.00
48	5240 MHz	7.60	5.00

**Configuration IEEE 802.11a 10MHz / Chain 1 + Chain 2**

Channel	Frequency	26dB Bandwidth (MHz)	99% Occupied Bandwidth (MHz)
36	5180 MHz	13.68	9.12
42	5210 MHz	13.76	9.12
48	5240 MHz	16.72	9.20

**Configuration IEEE 802.11a 20MHz / Chain 1 + Chain 2**

Channel	Frequency	26dB Bandwidth (MHz)	99% Occupied Bandwidth (MHz)
36	5180 MHz	22.88	16.96
40	5200 MHz	25.44	17.12
48	5240 MHz	27.36	17.28

<b>Temperature</b>	26°C	<b>Humidity</b>	63%
<b>Test Engineer</b>	Jim Huang	<b>Configurations</b>	IEEE 802.11n/a
<b>Test Mode</b>	Mode 2 / P to M		

**Configuration IEEE 802.11n MCS0 5 MHz / Chain 1 + Chain 2**

Channel	Frequency	26dB Bandwidth (MHz)	99% Occupied Bandwidth (MHz)
36	5180 MHz	7.76	5.36
42	5210 MHz	7.84	5.40
48	5240 MHz	9.04	5.40

**Configuration IEEE 802.11n MCS0 10 MHz / Chain 1 + Chain 2**

Channel	Frequency	26dB Bandwidth (MHz)	99% Occupied Bandwidth (MHz)
36	5180 MHz	15.12	9.84
42	5210 MHz	14.88	9.92
48	5240 MHz	17.20	9.84

**Configuration IEEE 802.11n MCS0 20 MHz / Chain 1 + Chain 2**

Channel	Frequency	26dB Bandwidth (MHz)	99% Occupied Bandwidth (MHz)
36	5180 MHz	25.60	18.24
40	5200 MHz	30.72	18.56
48	5240 MHz	26.24	18.56

**Configuration IEEE 802.11n MCS0 40 MHz / Chain 1 + Chain 2**

Channel	Frequency	26dB Bandwidth (MHz)	99% Occupied Bandwidth (MHz)
38	5190 MHz	45.12	36.48
46	5230 MHz	64.64	36.48

**Configuration IEEE 802.11a 5MHz / Chain 1 + Chain 2**

Channel	Frequency	26dB Bandwidth (MHz)	99% Occupied Bandwidth (MHz)
36	5180 MHz	7.36	5.04
42	5210 MHz	7.60	5.00
48	5240 MHz	7.60	5.00

**Configuration IEEE 802.11a 10MHz / Chain 1 + Chain 2**

Channel	Frequency	26dB Bandwidth (MHz)	99% Occupied Bandwidth (MHz)
36	5180 MHz	13.68	9.12
42	5210 MHz	13.76	9.12
48	5240 MHz	16.72	9.20

**Configuration IEEE 802.11a 20MHz / Chain 1 + Chain 2**

Channel	Frequency	26dB Bandwidth (MHz)	99% Occupied Bandwidth (MHz)
36	5180 MHz	22.88	16.96
40	5200 MHz	25.44	17.12
48	5240 MHz	27.36	17.28

<b>Temperature</b>	26°C	<b>Humidity</b>	63%
<b>Test Engineer</b>	Jim Huang	<b>Configurations</b>	IEEE 802.11n/a
<b>Test Mode</b>	Mode 3 / P to M		

**Configuration IEEE 802.11n MCS0 5 MHz / Chain 1 + Chain 2**

Channel	Frequency	26dB Bandwidth (MHz)	99% Occupied Bandwidth (MHz)
36	5180 MHz	8.00	5.40
42	5210 MHz	7.68	5.40
48	5240 MHz	7.84	5.36

**Configuration IEEE 802.11n MCS0 10 MHz / Chain 1 + Chain 2**

Channel	Frequency	26dB Bandwidth (MHz)	99% Occupied Bandwidth (MHz)
36	5180 MHz	13.76	9.68
42	5210 MHz	14.24	9.84
48	5240 MHz	13.76	9.76

**Configuration IEEE 802.11n MCS0 20 MHz / Chain 1 + Chain 2**

Channel	Frequency	26dB Bandwidth (MHz)	99% Occupied Bandwidth (MHz)
36	5180 MHz	24.16	18.24
40	5200 MHz	28.32	18.40
48	5240 MHz	36.48	18.88

**Configuration IEEE 802.11n MCS0 40 MHz / Chain 1 + Chain 2**

Channel	Frequency	26dB Bandwidth (MHz)	99% Occupied Bandwidth (MHz)
38	5190 MHz	45.76	36.48
46	5230 MHz	59.84	36.48

**Configuration IEEE 802.11a 5MHz / Chain 1 + Chain 2**

Channel	Frequency	26dB Bandwidth (MHz)	99% Occupied Bandwidth (MHz)
36	5180 MHz	7.32	5.00
42	5210 MHz	7.28	5.00
48	5240 MHz	7.68	5.04

**Configuration IEEE 802.11a 10MHz / Chain 1 + Chain 2**

Channel	Frequency	26dB Bandwidth (MHz)	99% Occupied Bandwidth (MHz)
36	5180 MHz	13.68	9.12
42	5210 MHz	13.52	9.20
48	5240 MHz	13.76	9.20

**Configuration IEEE 802.11a 20MHz / Chain 1 + Chain 2**

Channel	Frequency	26dB Bandwidth (MHz)	99% Occupied Bandwidth (MHz)
36	5180 MHz	25.28	16.96
40	5200 MHz	25.92	16.96
48	5240 MHz	34.40	17.92



Test Mode 1 / P to P

26dB Bandwidth and 99% Occupied Bandwidth Plot on Configuration IEEE 802.11n MCS0 5 MHz / Chain 1 + Chain 2 / 5180 MHz

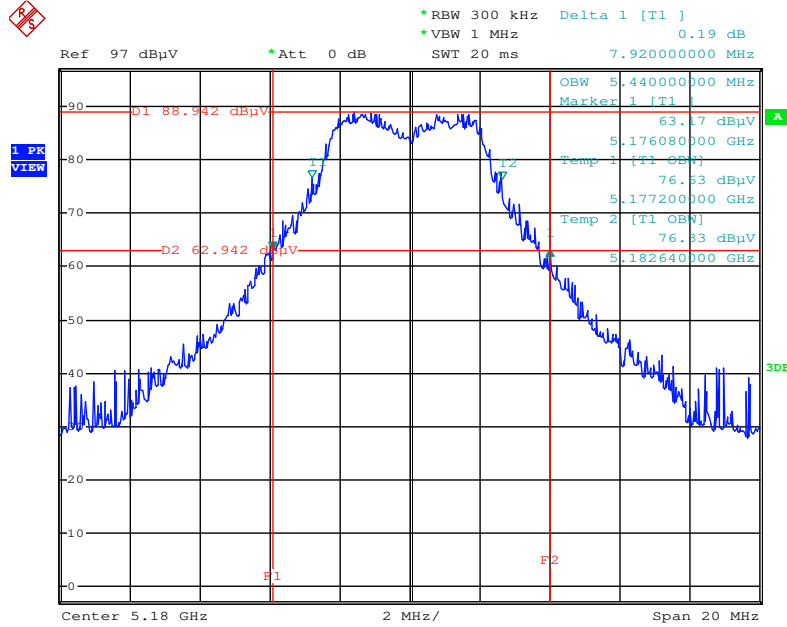

Date: 21.AUG.2014 10:39:00

26dB Bandwidth and 99% Occupied Bandwidth Plot on Configuration IEEE 802.11n MCS0 5 MHz / Chain 1 + Chain 2 / 5210 MHz

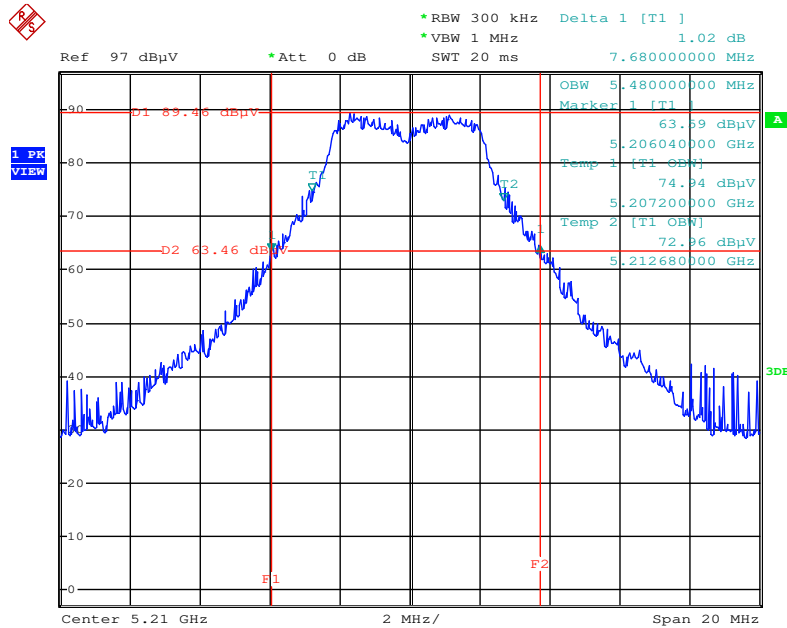

Date: 21.AUG.2014 10:39:50

**26dB Bandwidth and 99% Occupied Bandwidth Plot on Configuration IEEE 802.11n MCS0 5 MHz / Chain 1 + Chain 2 / 5240 MHz**

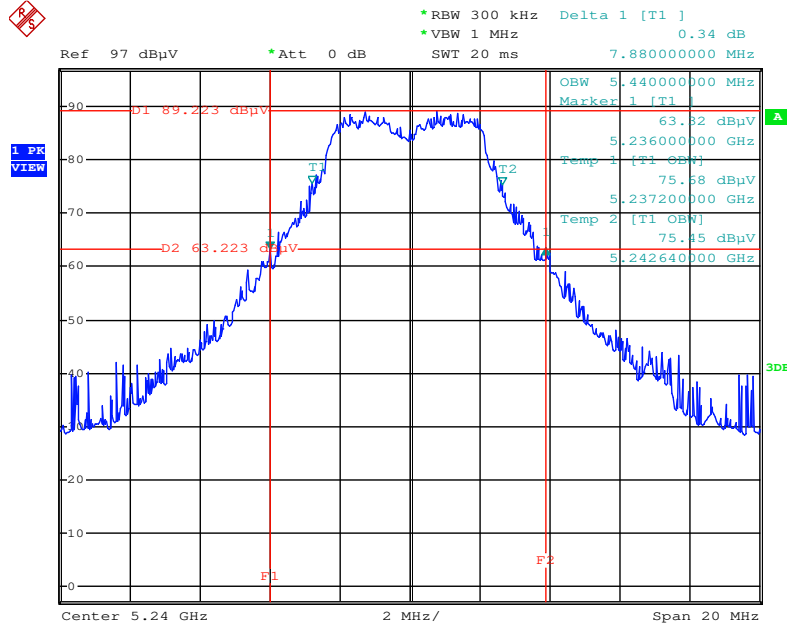

Date: 21.AUG.2014 10:40:26

**26dB Bandwidth and 99% Occupied Bandwidth Plot on Configuration IEEE 802.11n MCS0 10 MHz / Chain 1 + Chain 2 / 5180 MHz**

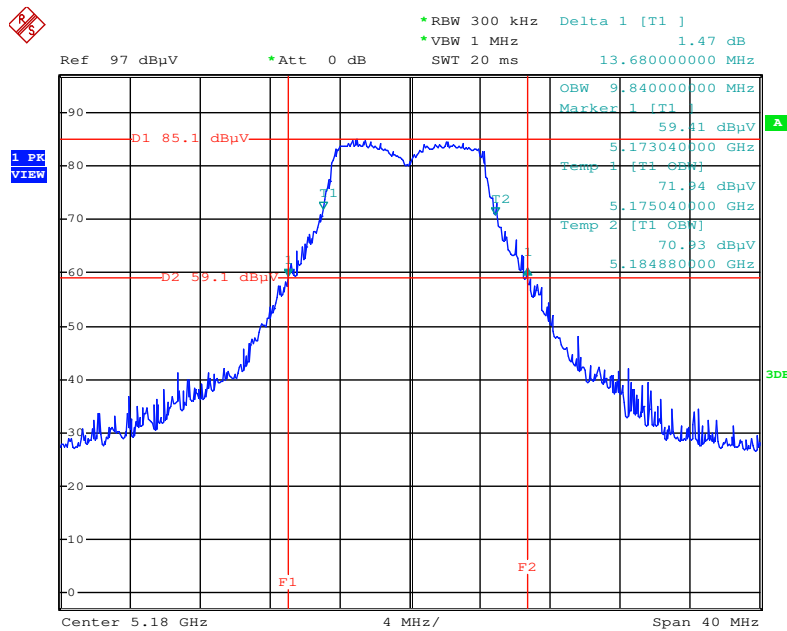

Date: 21.AUG.2014 11:17:29

**26dB Bandwidth and 99% Occupied Bandwidth Plot on Configuration IEEE 802.11n MCS0 10 MHz / Chain 1 + Chain 2 / 5210 MHz**

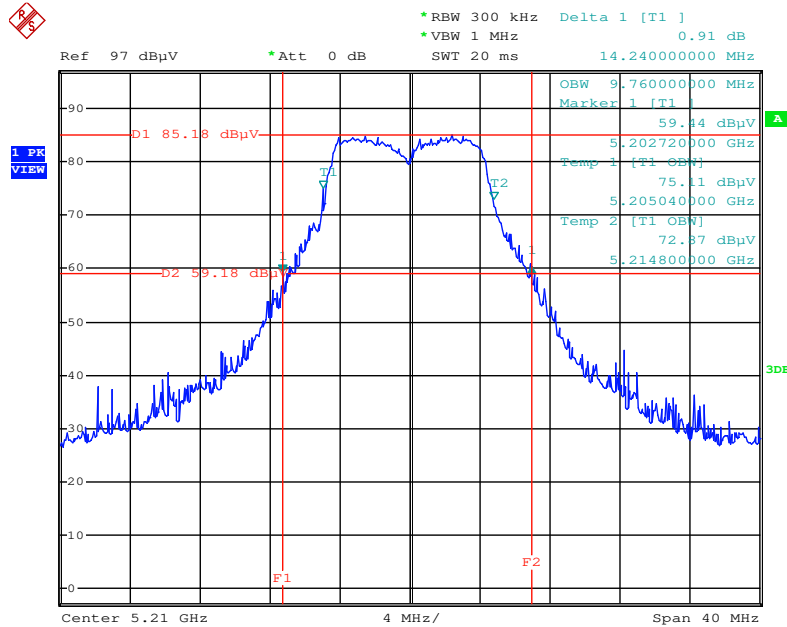

Date: 21.AUG.2014 11:18:11

**26dB Bandwidth and 99% Occupied Bandwidth Plot on Configuration IEEE 802.11n MCS0 10 MHz / Chain 1 + Chain 2 / 5240 MHz**

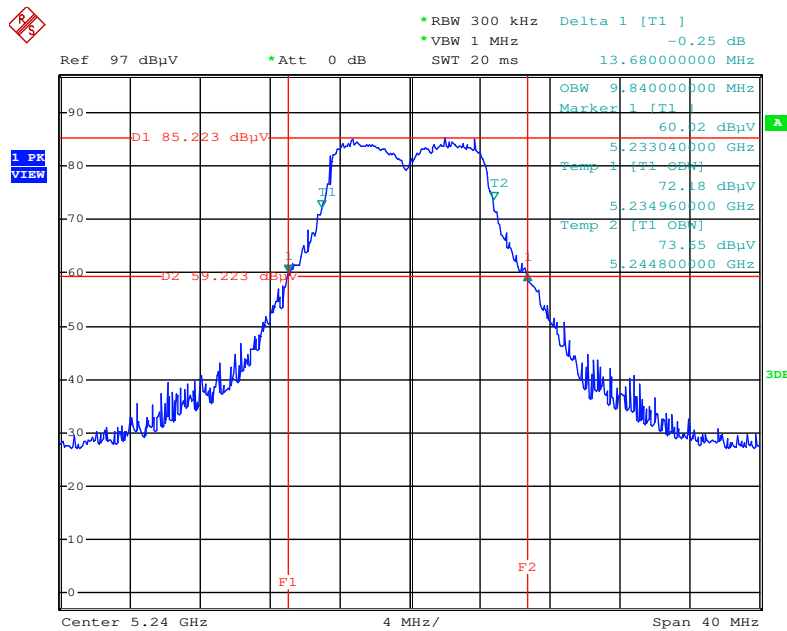

Date: 21.AUG.2014 11:18:50

**26dB Bandwidth and 99% Occupied Bandwidth Plot on Configuration IEEE 802.11n MCS0 20 MHz / Chain 1 + Chain 2 / 5180 MHz**

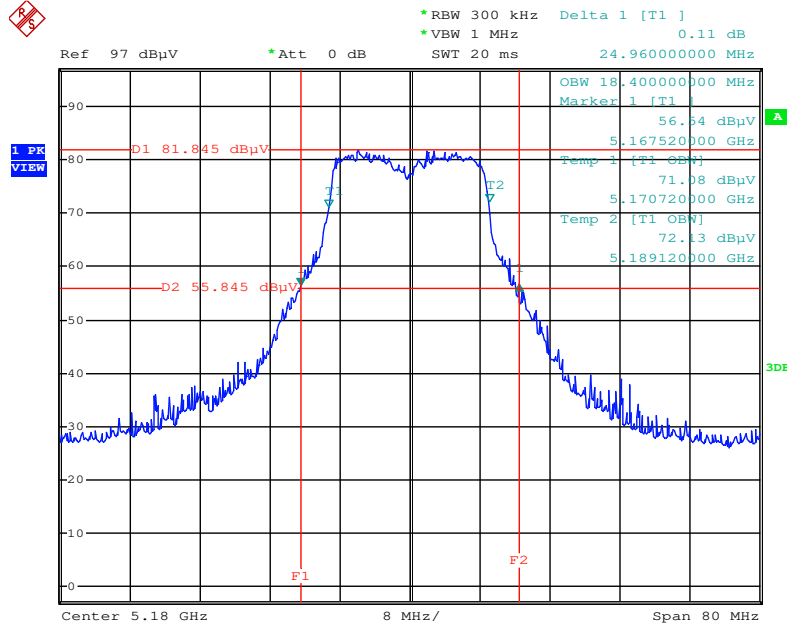

Date: 21.AUG.2014 12:09:30

**26dB Bandwidth and 99% Occupied Bandwidth Plot on Configuration IEEE 802.11n MCS0 20 MHz / Chain 1 + Chain 2 / 5200 MHz**

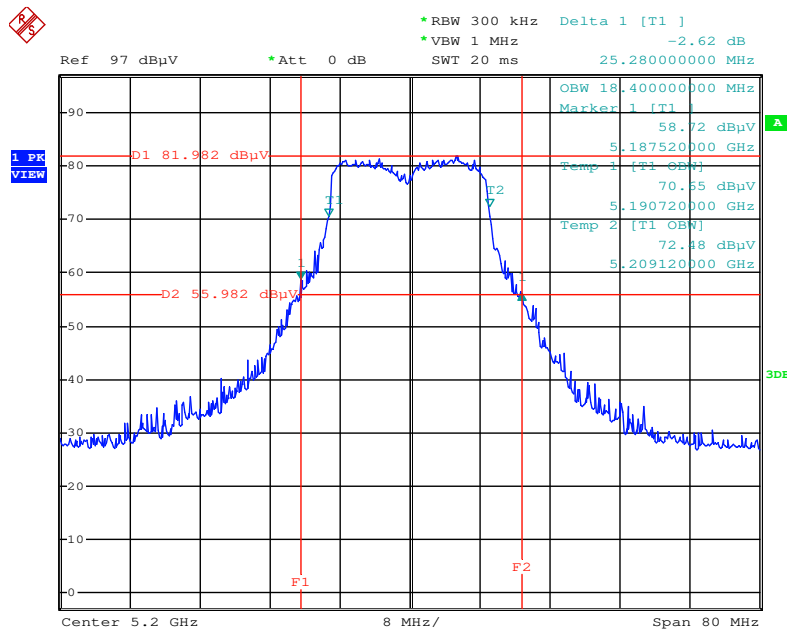

Date: 21.AUG.2014 12:08:51

**26dB Bandwidth and 99% Occupied Bandwidth Plot on Configuration IEEE 802.11n MCS0 20 MHz / Chain 1 + Chain 2 / 5240 MHz**

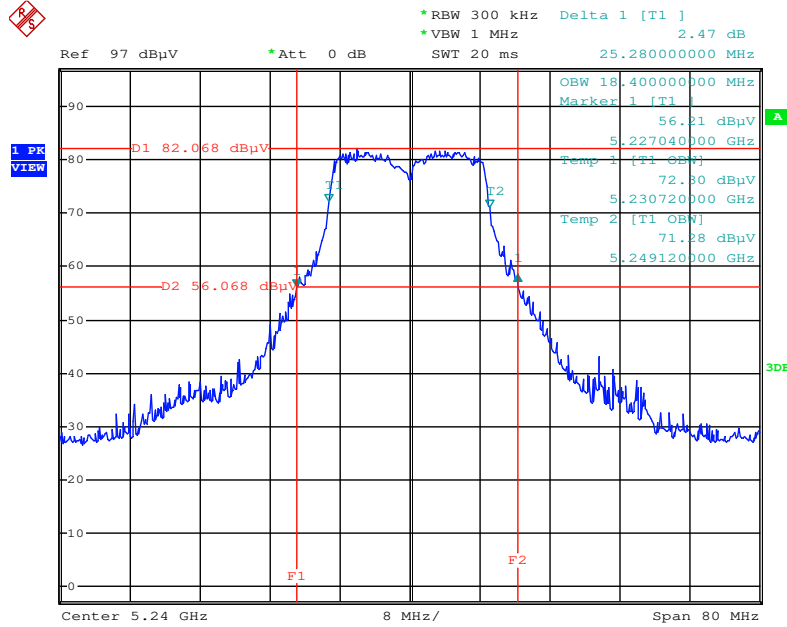

Date: 21.AUG.2014 12:07:55

**26dB Bandwidth and 99% Occupied Bandwidth Plot on Configuration IEEE 802.11n MCS0 40 MHz / Chain 1 + Chain 2 / 5190 MHz**

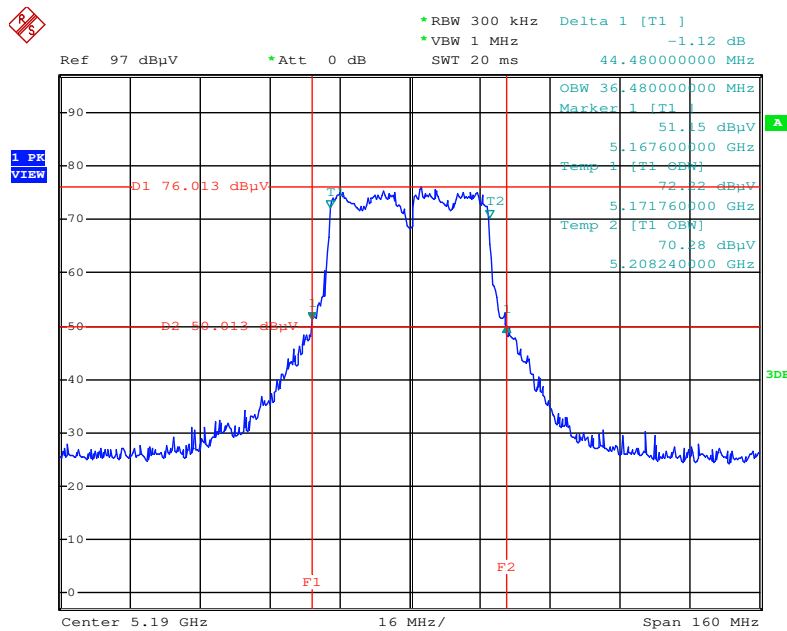

Date: 21.AUG.2014 12:04:16

**26dB Bandwidth and 99% Occupied Bandwidth Plot on Configuration IEEE 802.11n MCS0 40 MHz / Chain 1 + Chain 2 / 5230 MHz**

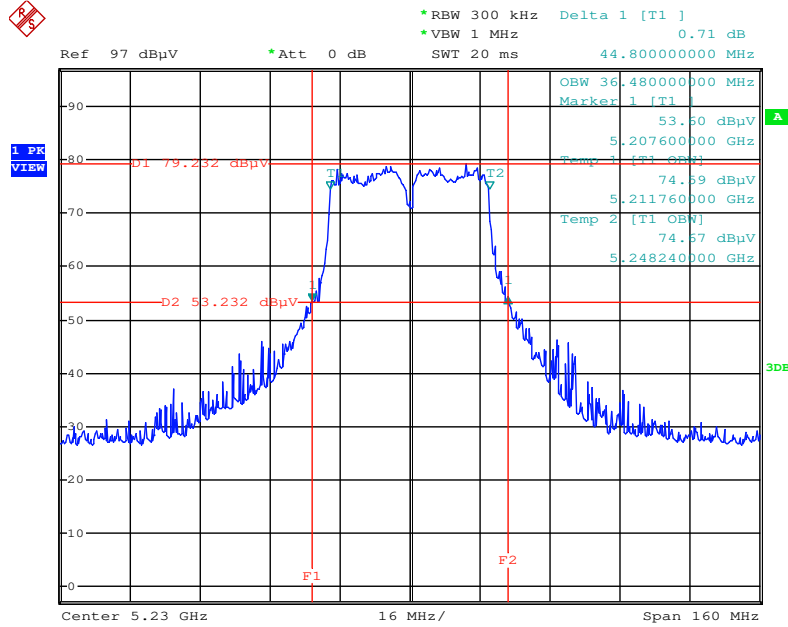

Date: 21.AUG.2014 12:03:29

**26dB Bandwidth and 99% Occupied Bandwidth Plot on Configuration IEEE 802.11a 5 MHz / Chain 1 + Chain 2 / 5180 MHz**

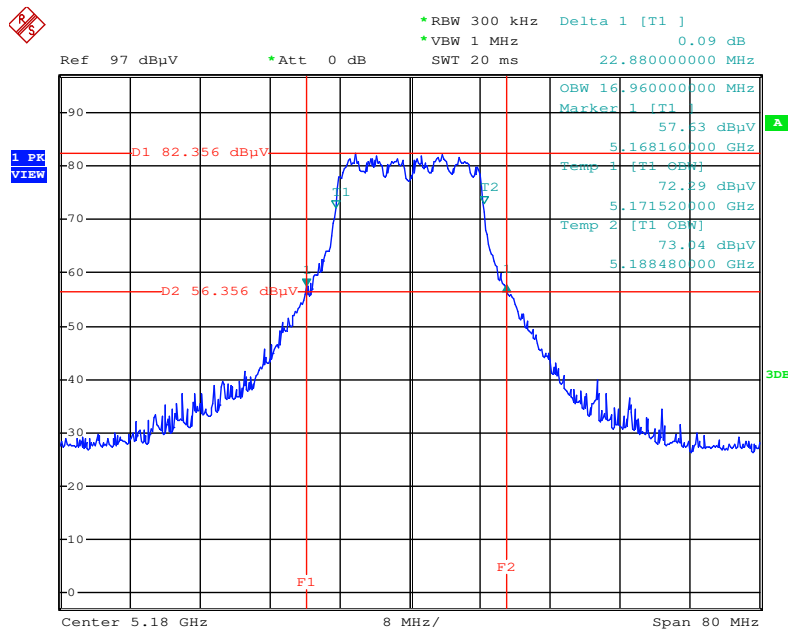

Date: 21.AUG.2014 12:05:20

**26dB Bandwidth and 99% Occupied Bandwidth Plot on Configuration IEEE 802.11a 5 MHz / Chain 1 + Chain 2 / 5210 MHz**

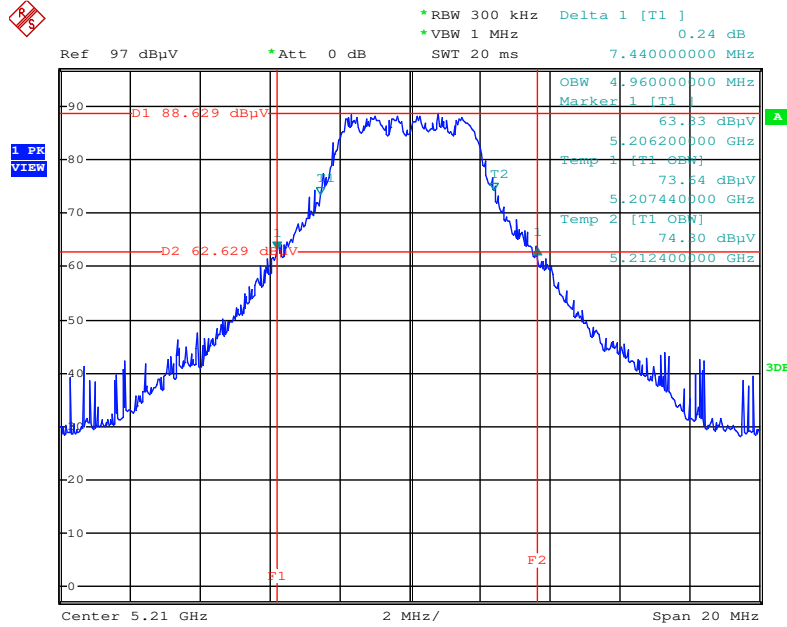

Date: 21.AUG.2014 10:42:26

**26dB Bandwidth and 99% Occupied Bandwidth Plot on Configuration IEEE 802.11a 5 MHz / Chain 1 + Chain 2 / 5240 MHz**

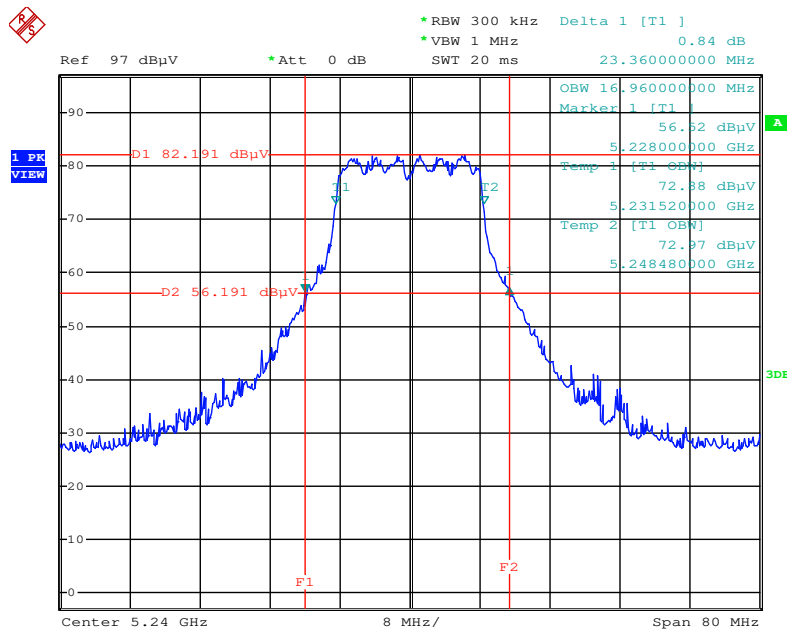

Date: 21.AUG.2014 12:06:31

**26dB Bandwidth and 99% Occupied Bandwidth Plot on Configuration IEEE 802.11a 10 MHz / Chain 1 + Chain 2 / 5180 MHz**

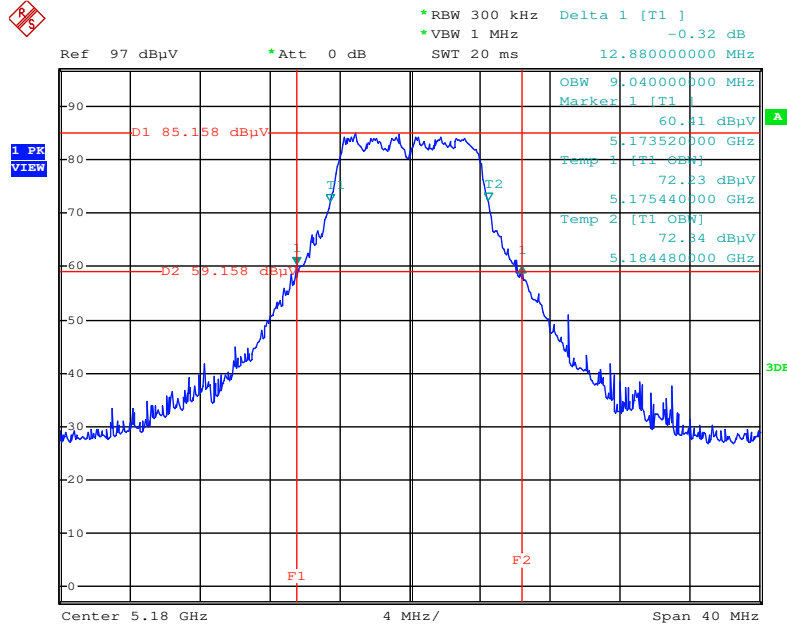

Date: 21.AUG.2014 11:15:46

**26dB Bandwidth and 99% Occupied Bandwidth Plot on Configuration IEEE 802.11a 10 MHz / Chain 1 + Chain 2 / 5210 MHz**

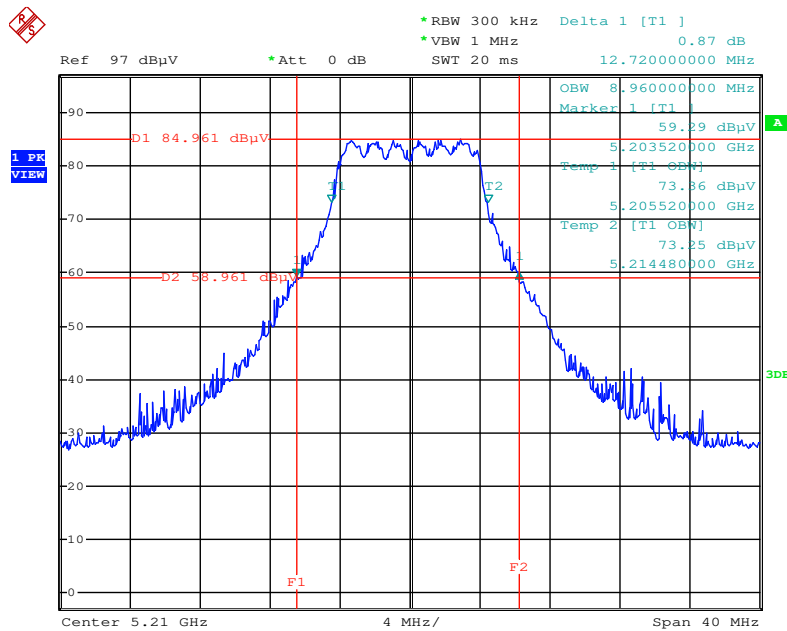

Date: 21.AUG.2014 11:15:09



**26dB Bandwidth and 99% Occupied Bandwidth Plot on Configuration IEEE 802.11a 10 MHz / Chain 1 + Chain 2 / 5240 MHz**

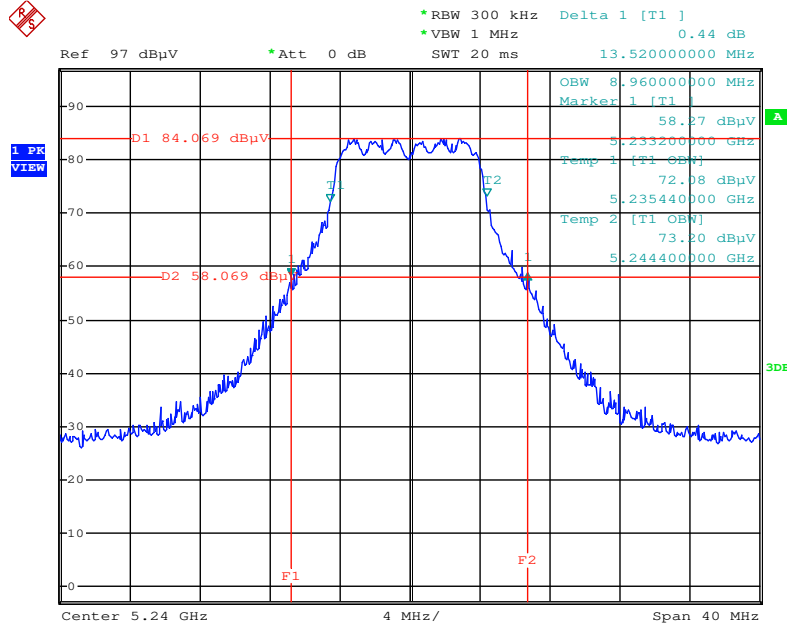

Date: 21.AUG.2014 11:14:17

**26dB Bandwidth and 99% Occupied Bandwidth Plot on Configuration IEEE 802.11a 20 MHz / Chain 1 + Chain 2 / 5180 MHz**

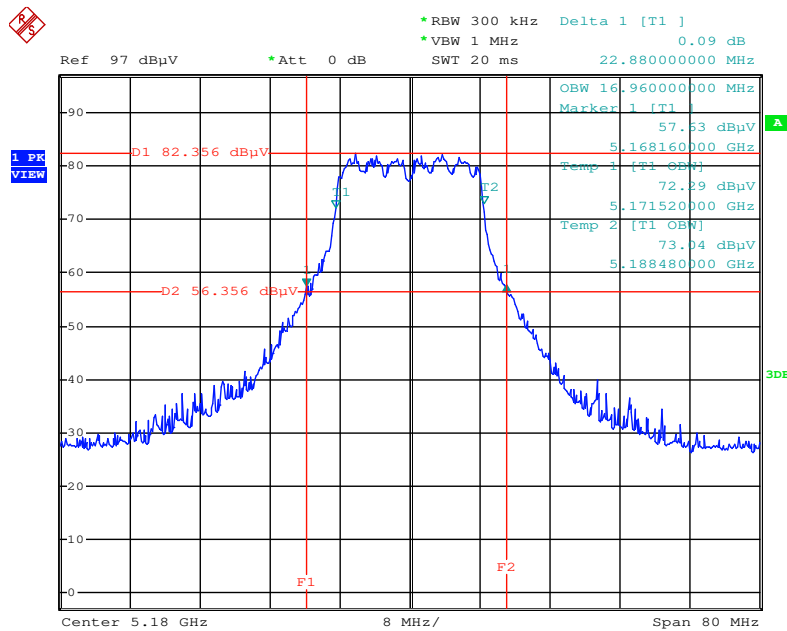

Date: 21.AUG.2014 12:05:20

**26dB Bandwidth and 99% Occupied Bandwidth Plot on Configuration IEEE 802.11a 20 MHz / Chain 1 + Chain 2 / 5200 MHz**

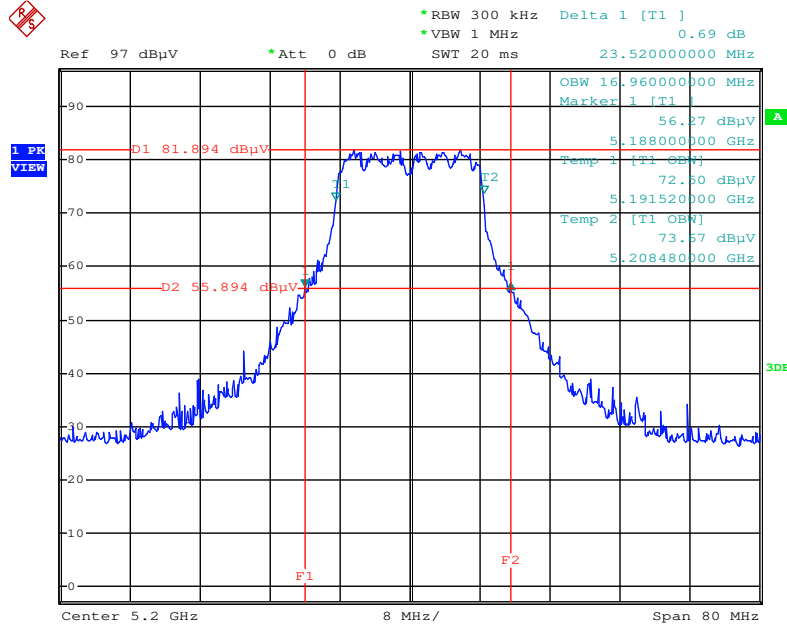

Date: 21.AUG.2014 12:05:54

**26dB Bandwidth and 99% Occupied Bandwidth Plot on Configuration IEEE 802.11a 20 MHz / Chain 1 + Chain 2 / 5240 MHz**

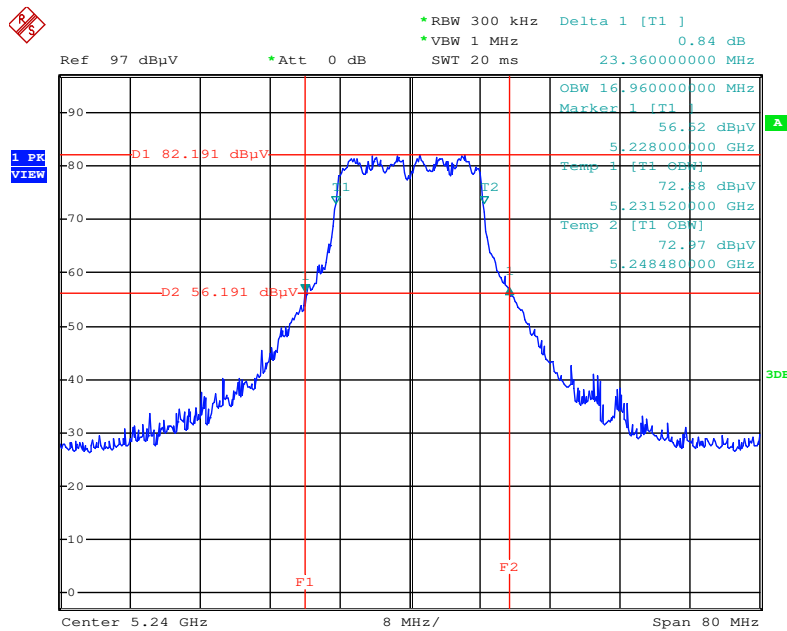

Date: 21.AUG.2014 12:06:31

Test Mode 1 / P to M

26dB Bandwidth and 99% Occupied Bandwidth Plot on Configuration IEEE 802.11n MCS0 5 MHz / Chain 1 + Chain 2 / 5180 MHz

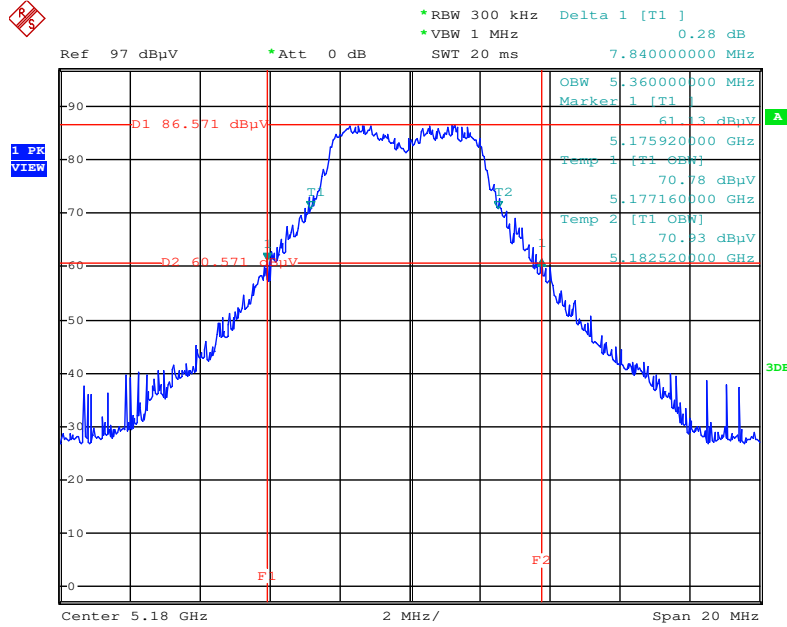

Date: 21.AUG.2014 10:30:49

26dB Bandwidth and 99% Occupied Bandwidth Plot on Configuration IEEE 802.11n MCS0 5 MHz / Chain 1 + Chain 2 / 5210 MHz

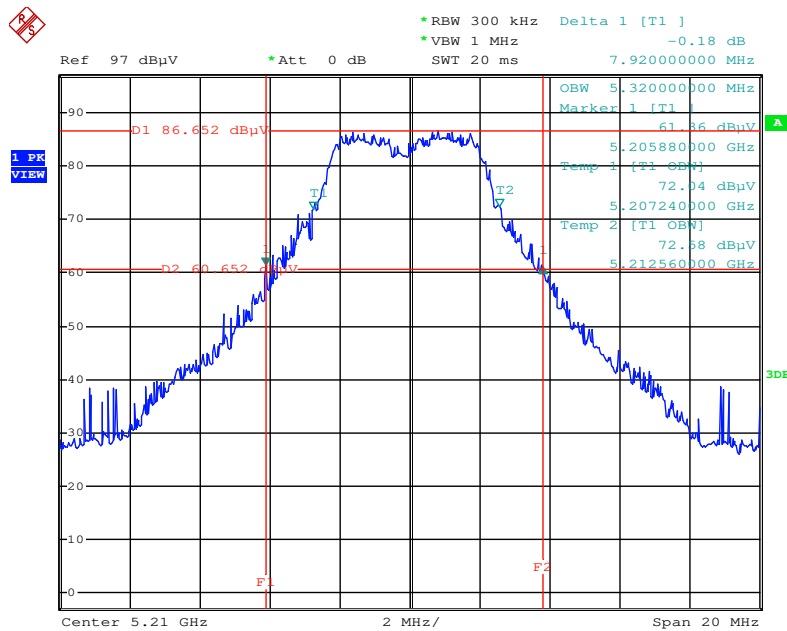

Date: 21.AUG.2014 10:30:04

**26dB Bandwidth and 99% Occupied Bandwidth Plot on Configuration IEEE 802.11n MCS0 5 MHz / Chain 1 + Chain 2 / 5240 MHz**

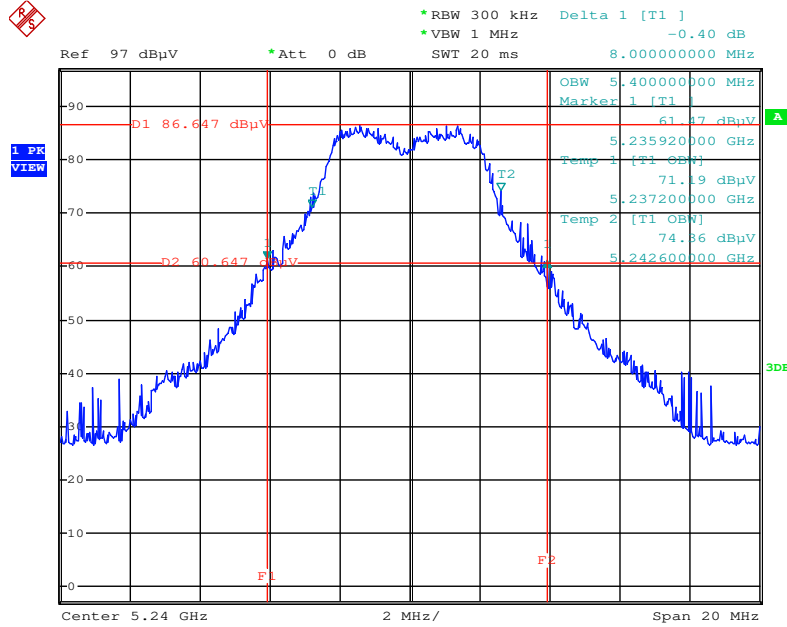

Date: 21.AUG.2014 10:29:16

**26dB Bandwidth and 99% Occupied Bandwidth Plot on Configuration IEEE 802.11n MCS0 10 MHz / Chain 1 + Chain 2 / 5180 MHz**

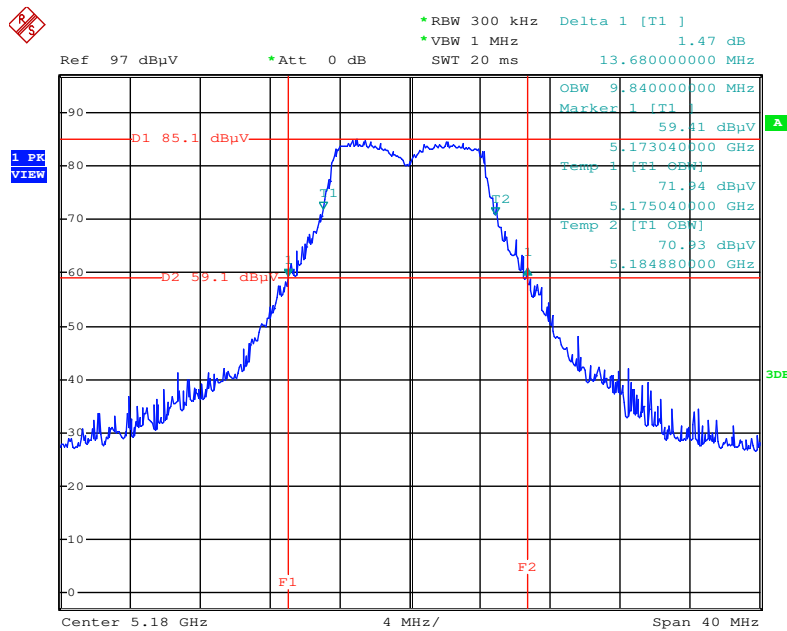

Date: 21.AUG.2014 11:17:29

**26dB Bandwidth and 99% Occupied Bandwidth Plot on Configuration IEEE 802.11n MCS0 10 MHz / Chain 1 + Chain 2 / 5210 MHz**

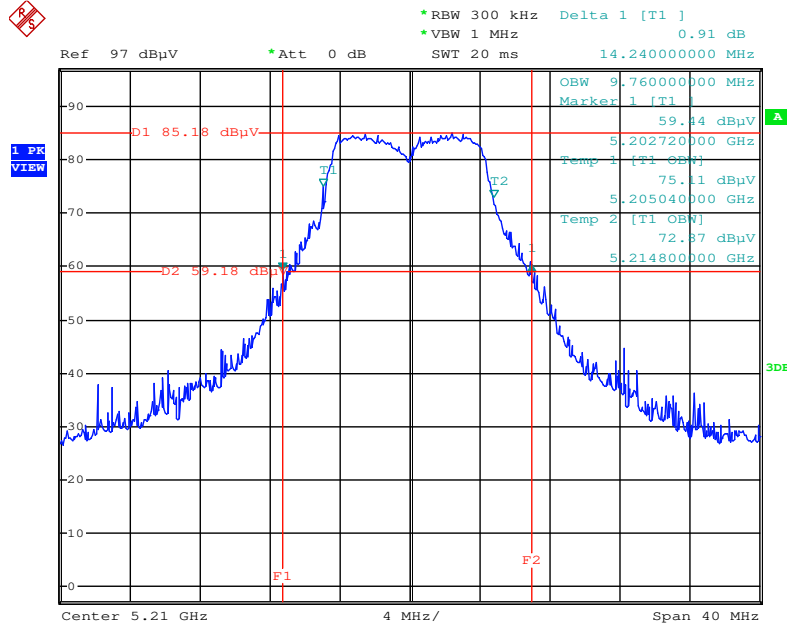

Date: 21.AUG.2014 11:18:11

**26dB Bandwidth and 99% Occupied Bandwidth Plot on Configuration IEEE 802.11n MCS0 10 MHz / Chain 1 + Chain 2 / 5240 MHz**

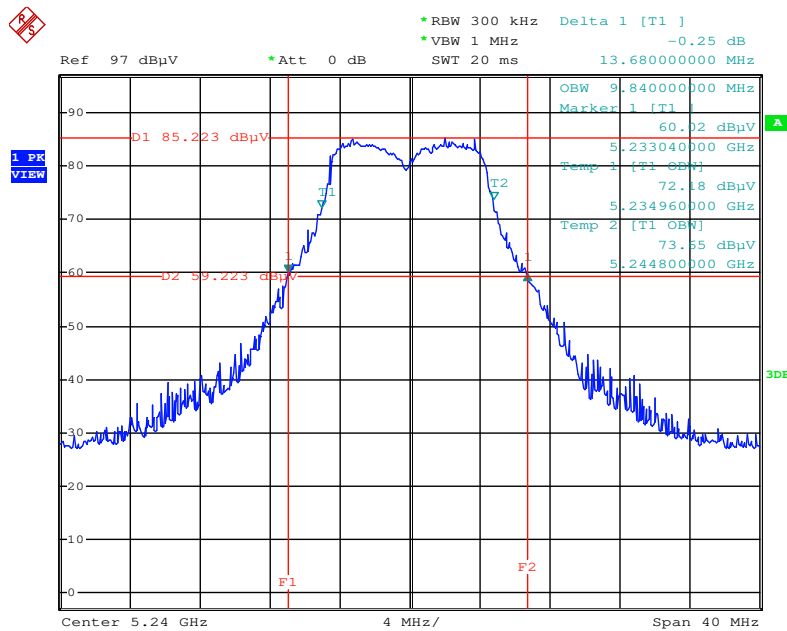

Date: 21.AUG.2014 11:18:50

**26dB Bandwidth and 99% Occupied Bandwidth Plot on Configuration IEEE 802.11n MCS0 20 MHz / Chain 1 + Chain 2 / 5180 MHz**

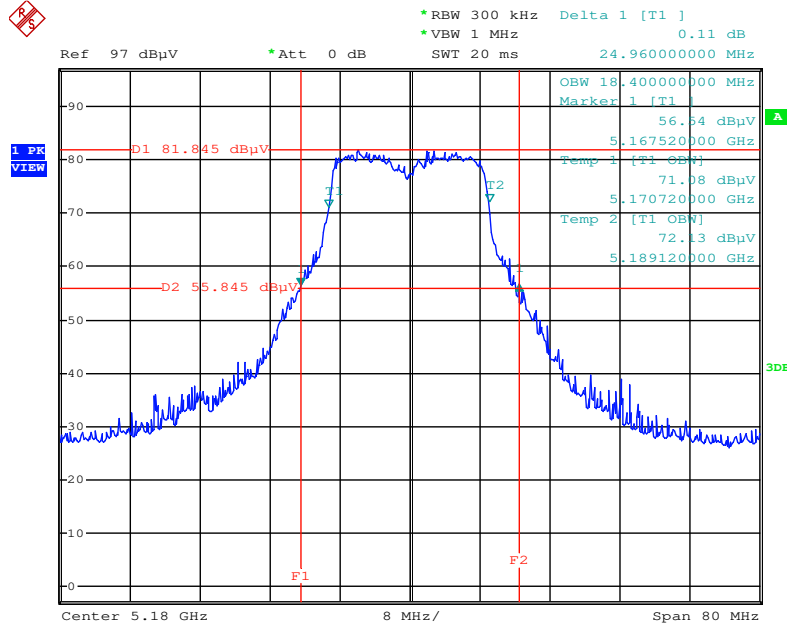

Date: 21.AUG.2014 12:09:30

**26dB Bandwidth and 99% Occupied Bandwidth Plot on Configuration IEEE 802.11n MCS0 20 MHz / Chain 1 + Chain 2 / 5200 MHz**

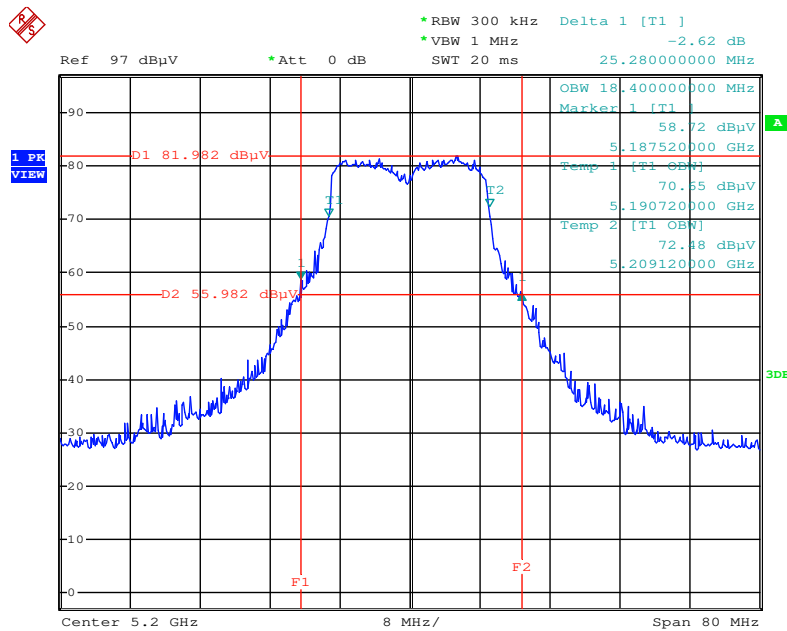

Date: 21.AUG.2014 12:08:51

**26dB Bandwidth and 99% Occupied Bandwidth Plot on Configuration IEEE 802.11n MCS0 20 MHz / Chain 1 + Chain 2 / 5240 MHz**

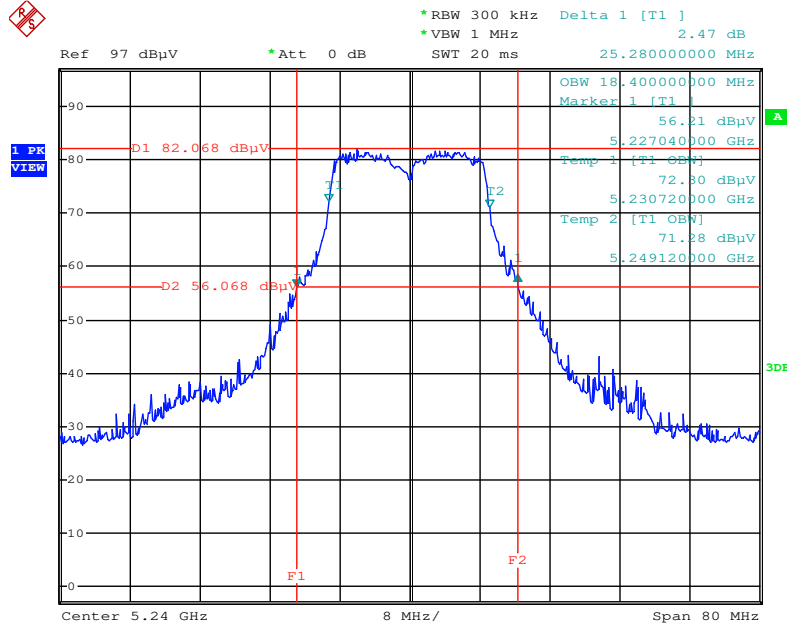

Date: 21.AUG.2014 12:07:55

**26dB Bandwidth and 99% Occupied Bandwidth Plot on Configuration IEEE 802.11n MCS0 40 MHz / Chain 1 + Chain 2 / 5190 MHz**

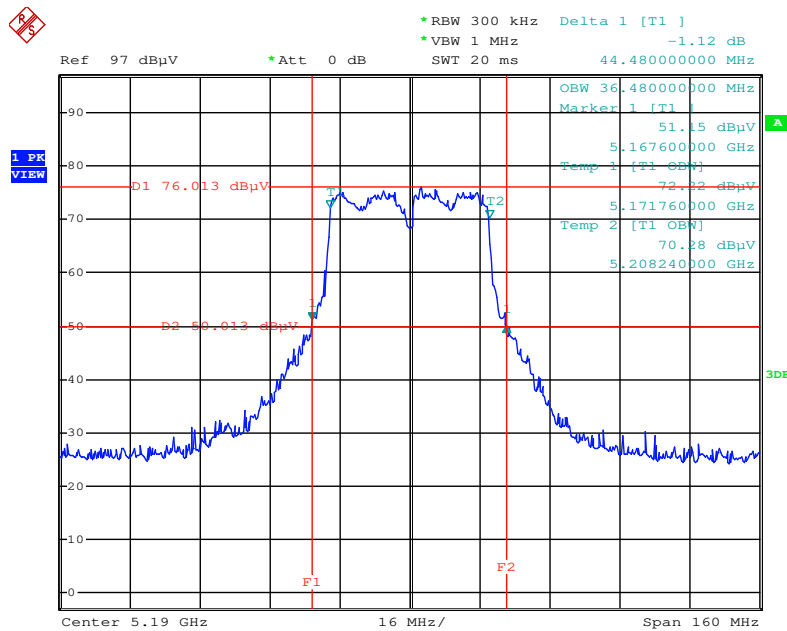

Date: 21.AUG.2014 12:04:16

**26dB Bandwidth and 99% Occupied Bandwidth Plot on Configuration IEEE 802.11n MCS0 40 MHz / Chain 1 + Chain 2 / 5230 MHz**

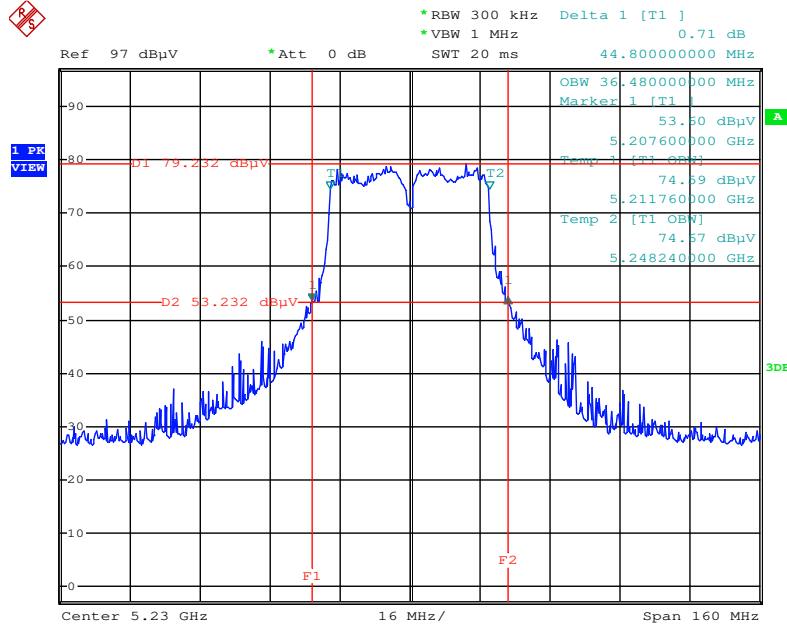

Date: 21.AUG.2014 12:03:29

**26dB Bandwidth and 99% Occupied Bandwidth Plot on Configuration IEEE 802.11a 5 MHz / Chain 1 + Chain 2 / 5180 MHz**

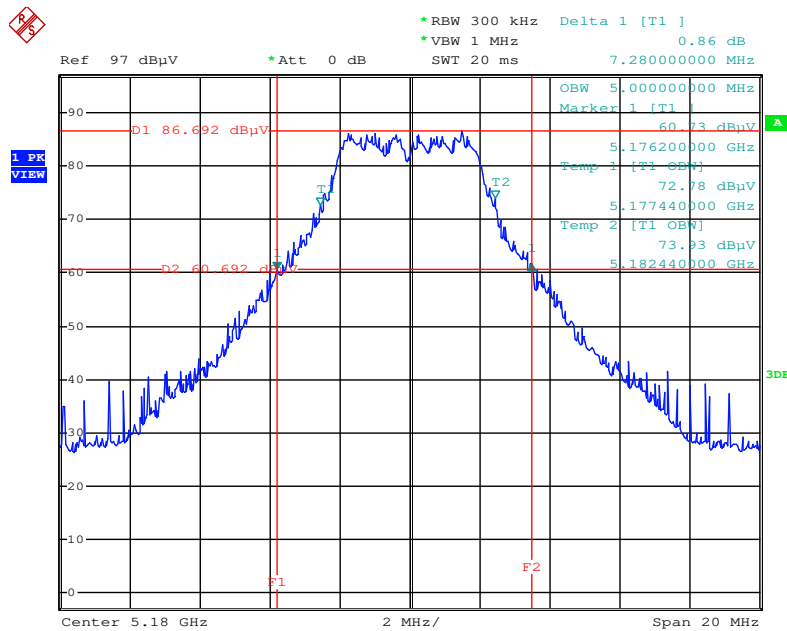

Date: 21.AUG.2014 10:23:47



**26dB Bandwidth and 99% Occupied Bandwidth Plot on Configuration IEEE 802.11a 5 MHz / Chain 1 + Chain 2 / 5210 MHz**

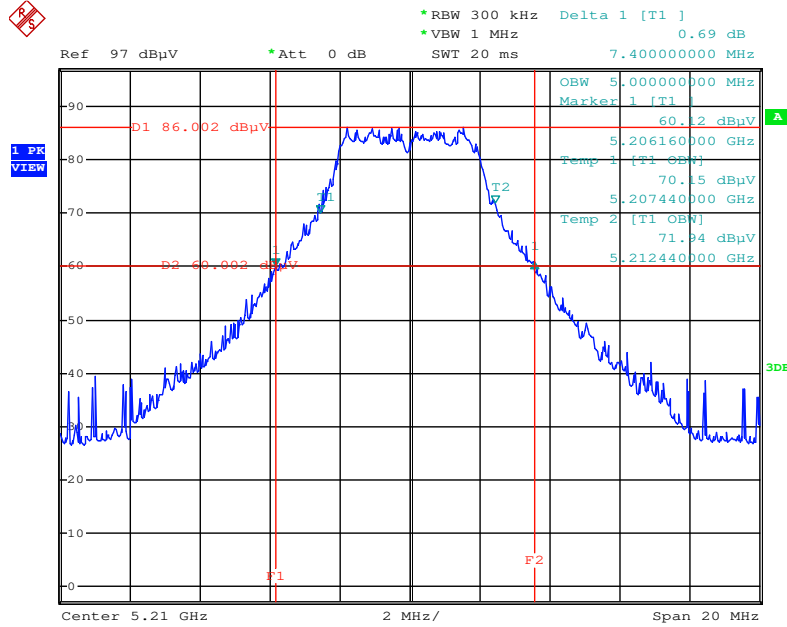

Date: 21.AUG.2014 10:24:56

**26dB Bandwidth and 99% Occupied Bandwidth Plot on Configuration IEEE 802.11a 5 MHz / Chain 1 + Chain 2 / 5240 MHz**

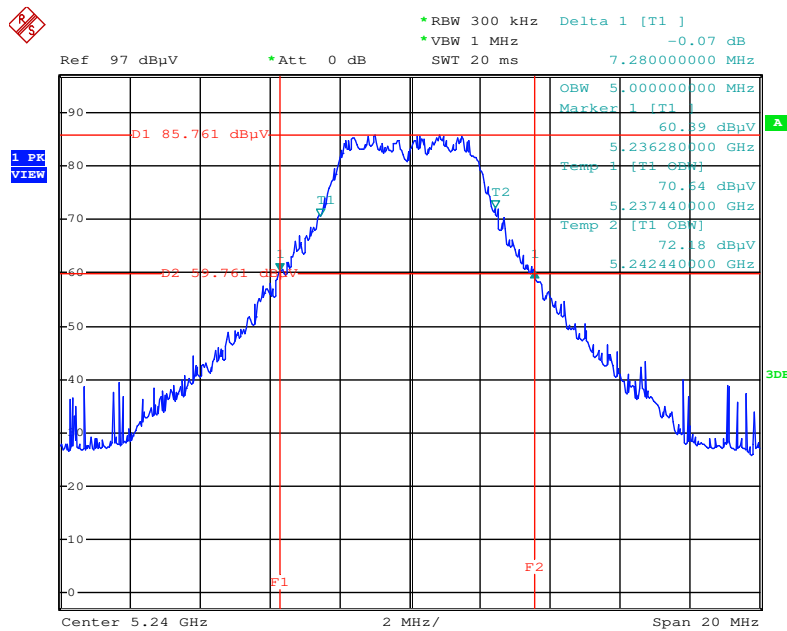

Date: 21.AUG.2014 10:25:23

**26dB Bandwidth and 99% Occupied Bandwidth Plot on Configuration IEEE 802.11a 10 MHz / Chain 1 + Chain 2 / 5180 MHz**

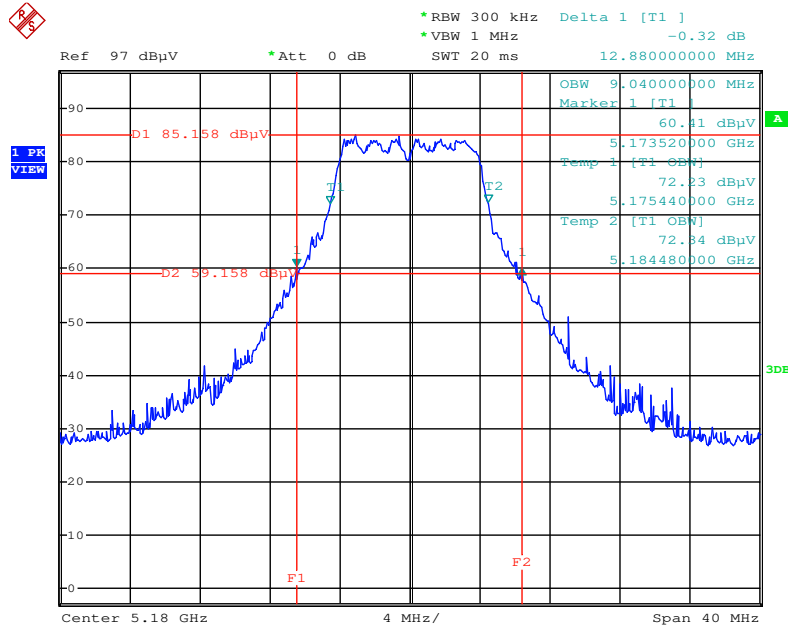

Date: 21.AUG.2014 11:15:46

**26dB Bandwidth and 99% Occupied Bandwidth Plot on Configuration IEEE 802.11a 10 MHz / Chain 1 + Chain 2 / 5210 MHz**

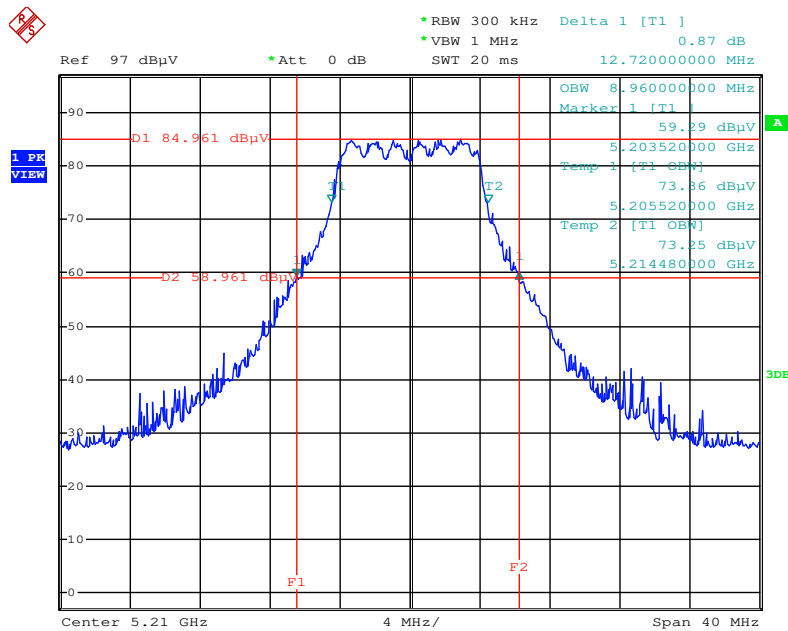

Date: 21.AUG.2014 11:15:09

**26dB Bandwidth and 99% Occupied Bandwidth Plot on Configuration IEEE 802.11a 10 MHz / Chain 1 + Chain 2 / 5240 MHz**

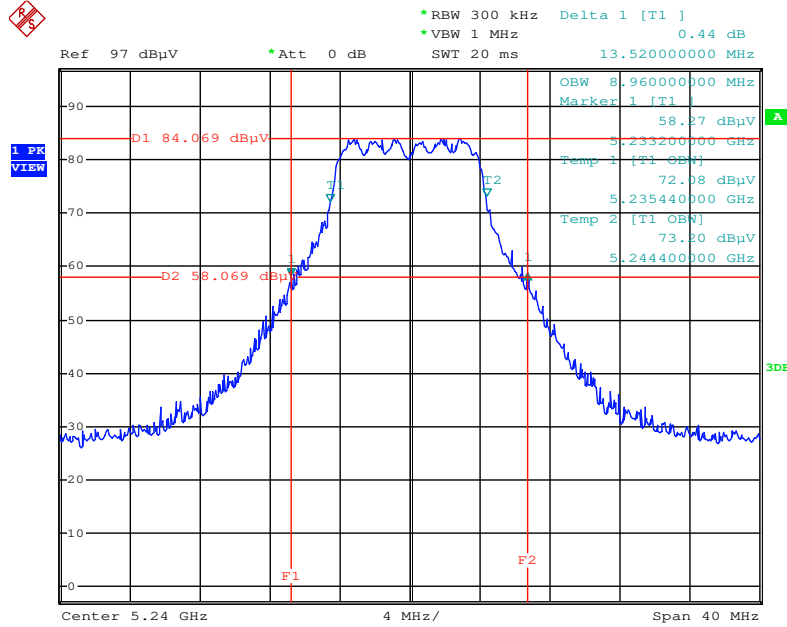

Date: 21.AUG.2014 11:14:17

**26dB Bandwidth and 99% Occupied Bandwidth Plot on Configuration IEEE 802.11a 20 MHz / Chain 1 + Chain 2 / 5180 MHz**

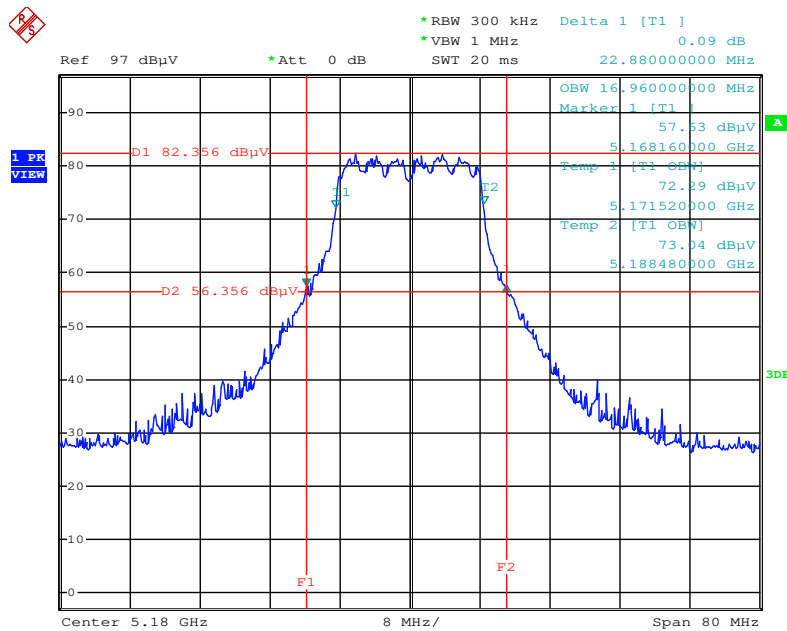

Date: 21.AUG.2014 12:05:20

**26dB Bandwidth and 99% Occupied Bandwidth Plot on Configuration IEEE 802.11a 20 MHz / Chain 1 + Chain 2 / 5200 MHz**

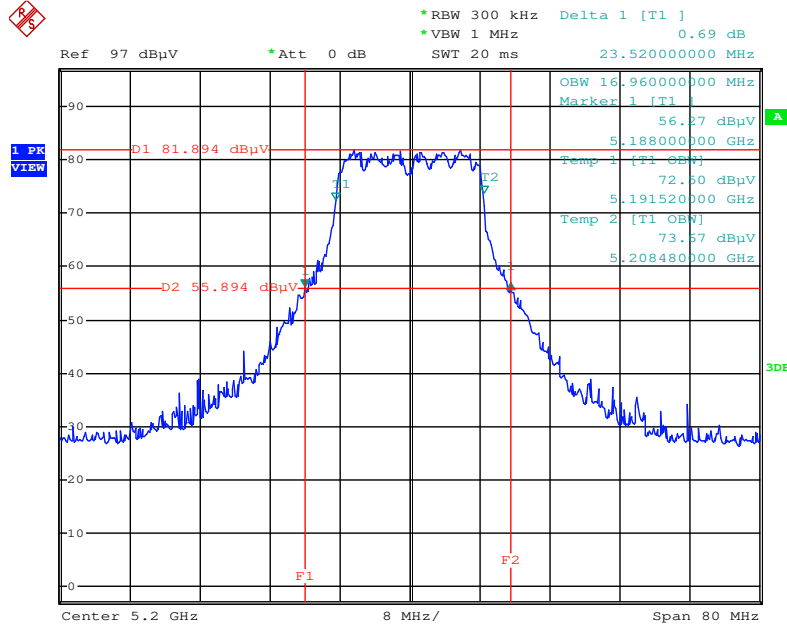

Date: 21.AUG.2014 12:05:54

**26dB Bandwidth and 99% Occupied Bandwidth Plot on Configuration IEEE 802.11a 20 MHz / Chain 1 + Chain 2 / 5240 MHz**

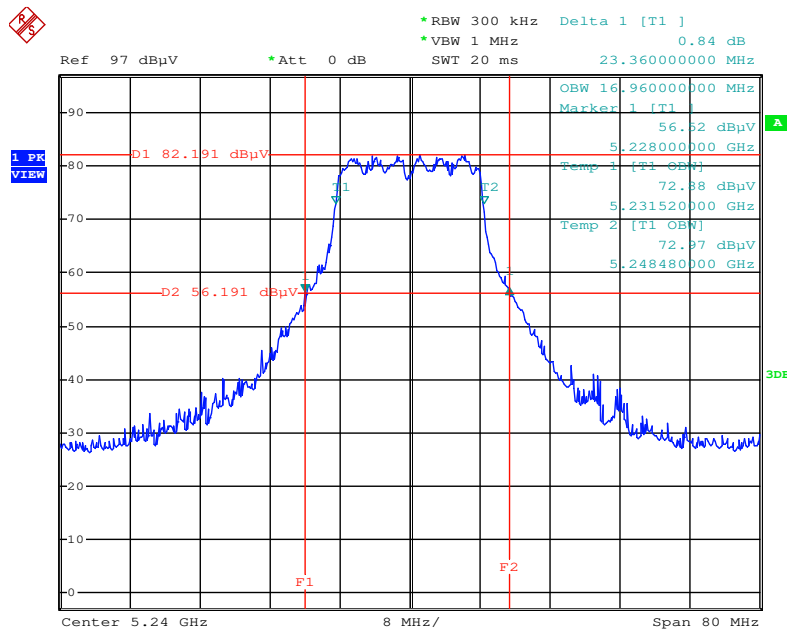

Date: 21.AUG.2014 12:06:31

**Test Mode 2 / P to P**

**26dB Bandwidth and 99% Occupied Bandwidth Plot on Configuration IEEE 802.11n MCS0 5 MHz / Chain 1 + Chain 2 / 5180 MHz**

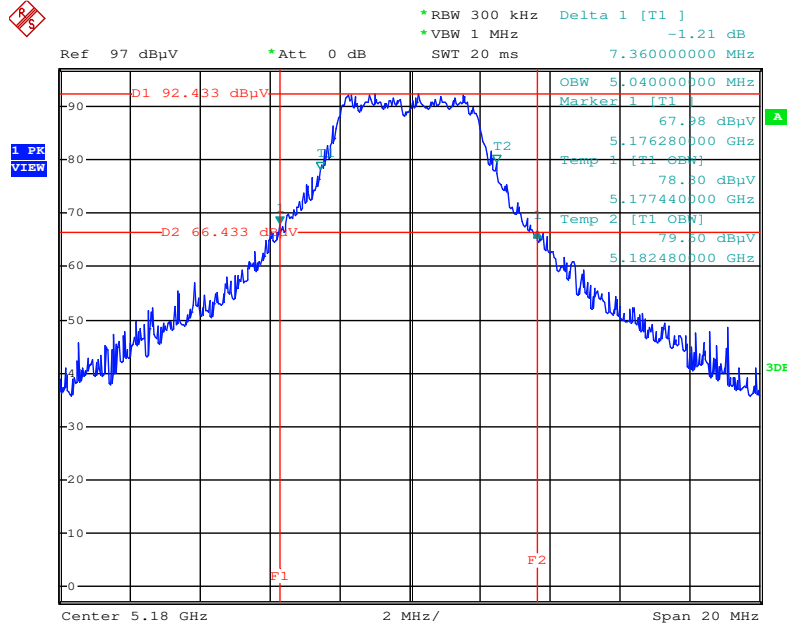

Date: 21.AUG.2014 10:49:00

**26dB Bandwidth and 99% Occupied Bandwidth Plot on Configuration IEEE 802.11n MCS0 5 MHz / Chain 1 + Chain 2 / 5210 MHz**

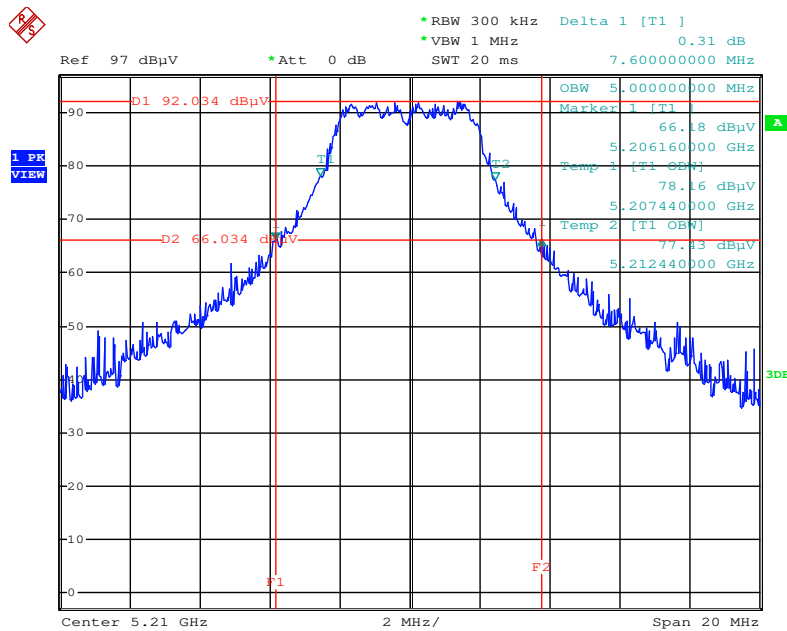

Date: 21.AUG.2014 10:49:36

**26dB Bandwidth and 99% Occupied Bandwidth Plot on Configuration IEEE 802.11n MCS0 5 MHz / Chain 1 + Chain 2 / 5240 MHz**

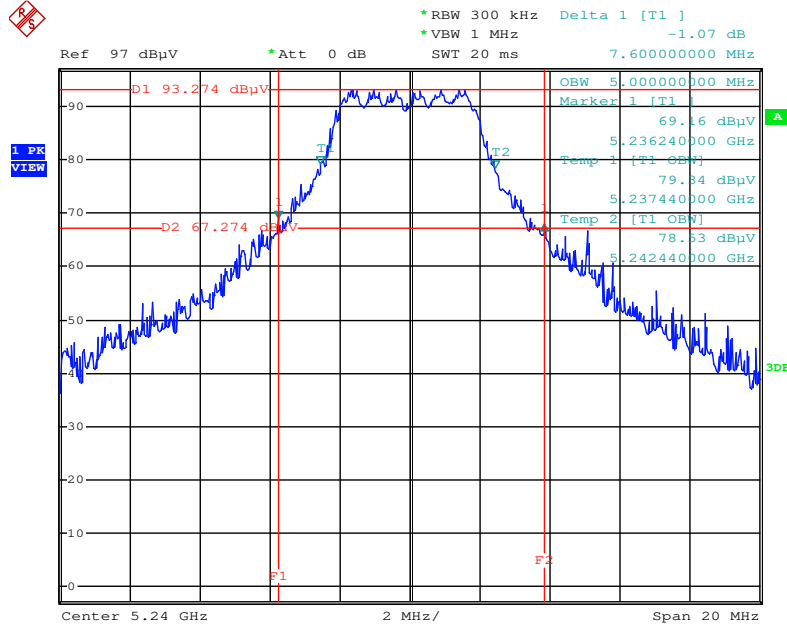

Date: 21.AUG.2014 10:50:12

**26dB Bandwidth and 99% Occupied Bandwidth Plot on Configuration IEEE 802.11n MCS0 10 MHz / Chain 1 + Chain 2 / 5180 MHz**

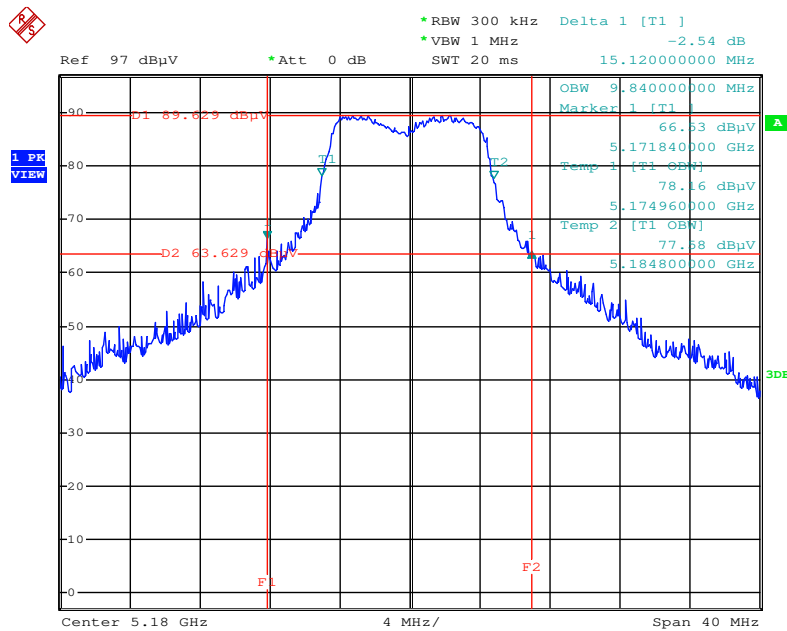

Date: 21.AUG.2014 11:25:27

**26dB Bandwidth and 99% Occupied Bandwidth Plot on Configuration IEEE 802.11n MCS0 10 MHz / Chain 1 + Chain 2 / 5210 MHz**

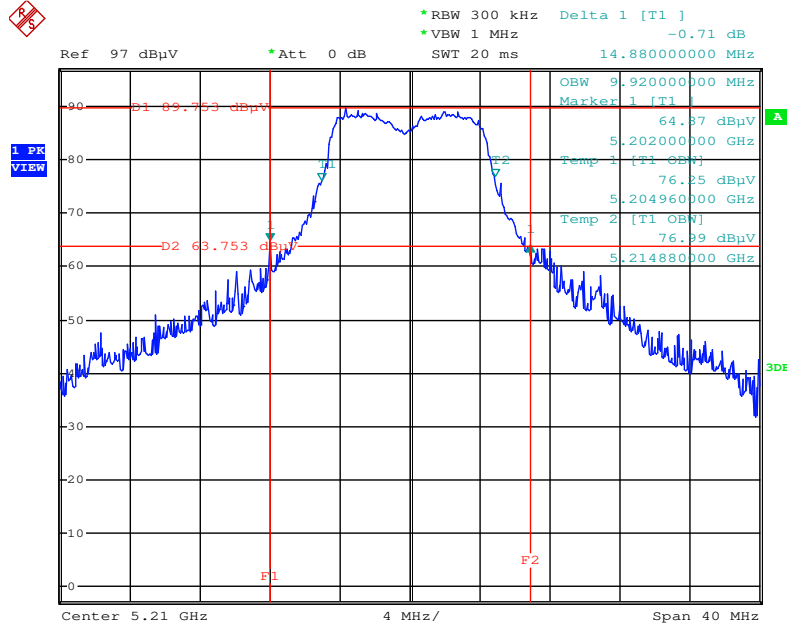

Date: 21.AUG.2014 11:23:43

**26dB Bandwidth and 99% Occupied Bandwidth Plot on Configuration IEEE 802.11n MCS0 10 MHz / Chain 1 + Chain 2 / 5240 MHz**

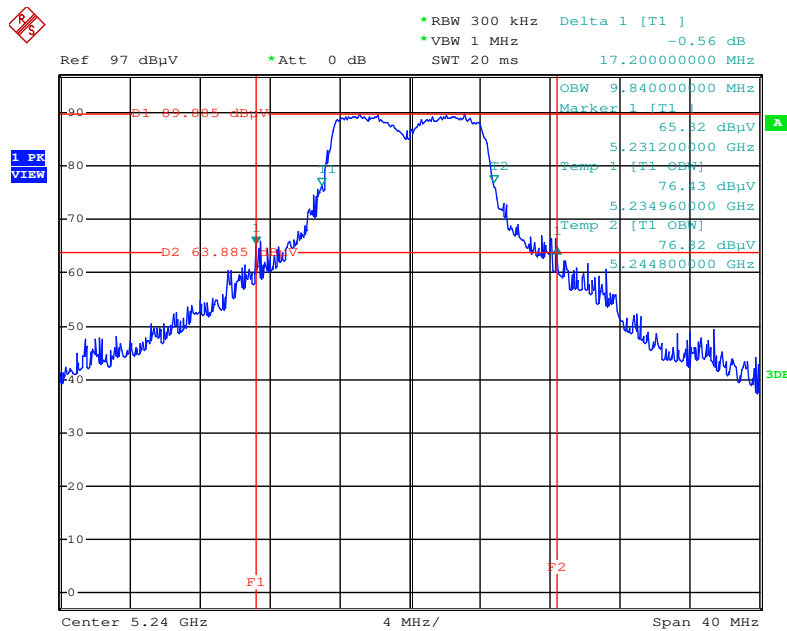

Date: 21.AUG.2014 11:23:01

**26dB Bandwidth and 99% Occupied Bandwidth Plot on Configuration IEEE 802.11n MCS0 20 MHz / Chain 1 + Chain 2 / 5180 MHz**

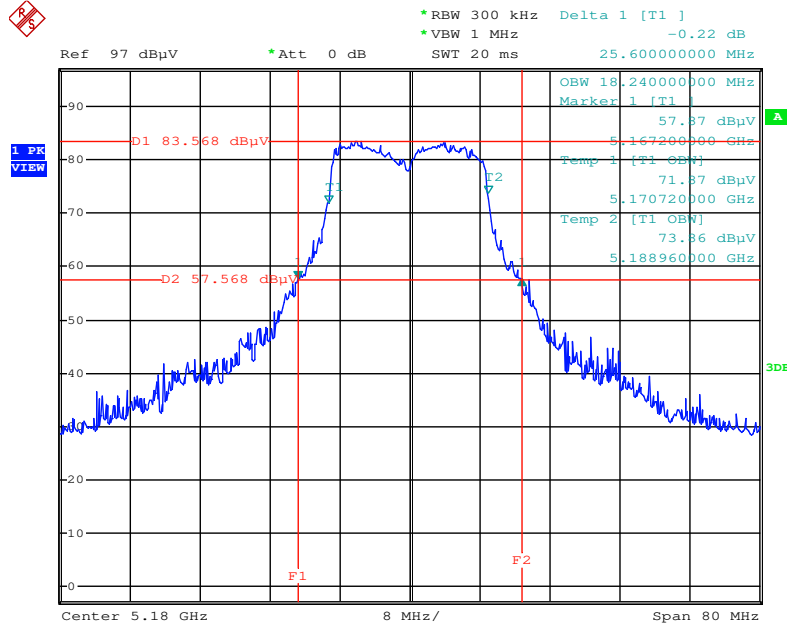

Date: 21.AUG.2014 11:59:16

**26dB Bandwidth and 99% Occupied Bandwidth Plot on Configuration IEEE 802.11n MCS0 20 MHz / Chain 1 + Chain 2 / 5200 MHz**

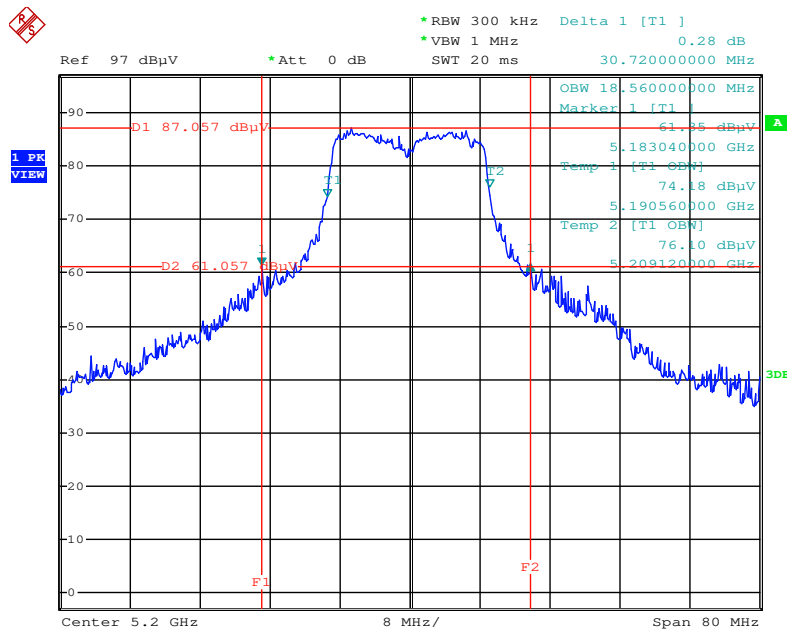

Date: 21.AUG.2014 11:58:19



**26dB Bandwidth and 99% Occupied Bandwidth Plot on Configuration IEEE 802.11n MCS0 20 MHz / Chain 1 + Chain 2 / 5240 MHz**

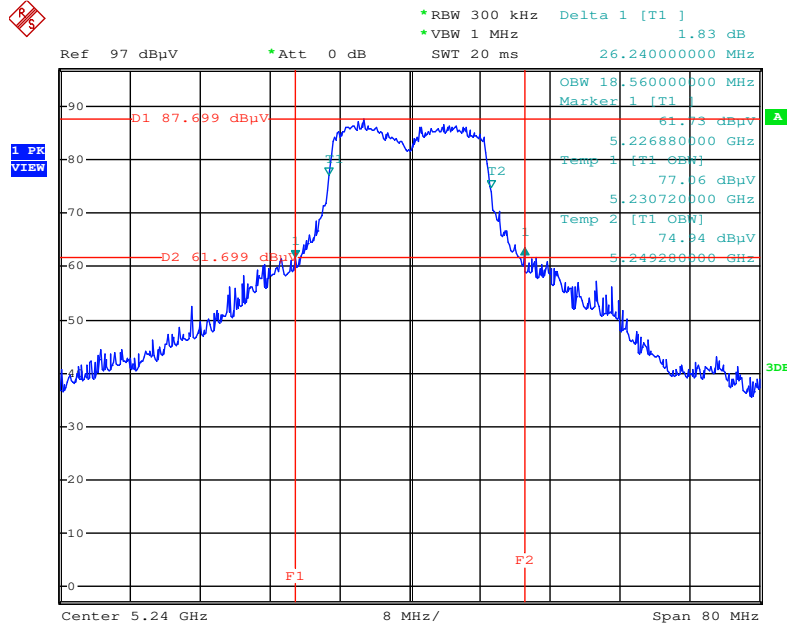

Date: 21.AUG.2014 11:57:42

**26dB Bandwidth and 99% Occupied Bandwidth Plot on Configuration IEEE 802.11n MCS0 40 MHz / Chain 1 + Chain 2 / 5190 MHz**

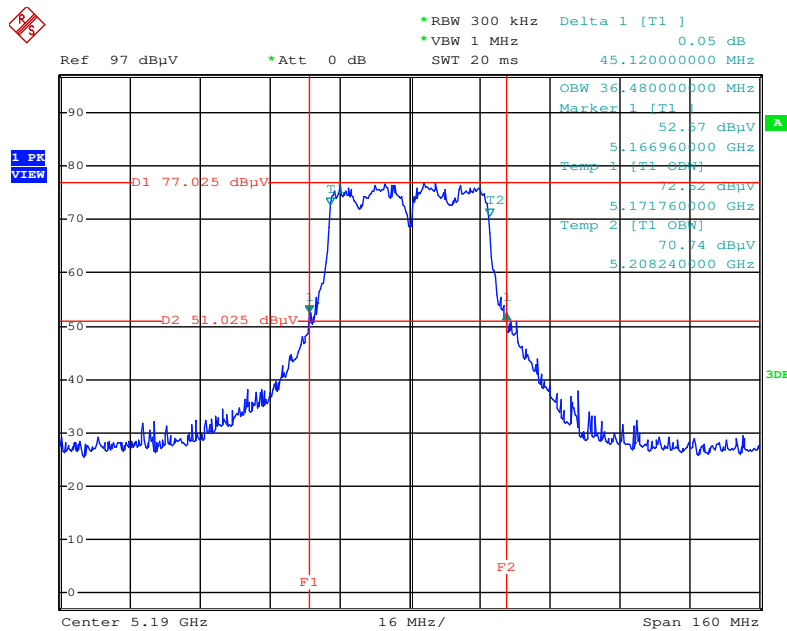

Date: 21.AUG.2014 12:00:17

**26dB Bandwidth and 99% Occupied Bandwidth Plot on Configuration IEEE 802.11n MCS0 40 MHz / Chain 1 + Chain 2 / 5230 MHz**

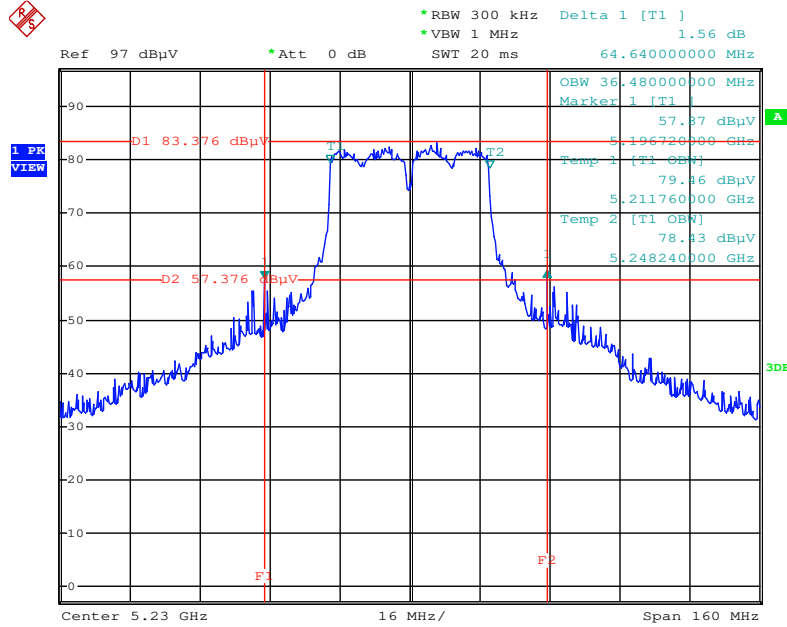

Date: 21.AUG.2014 12:00:57

**26dB Bandwidth and 99% Occupied Bandwidth Plot on Configuration IEEE 802.11a 5 MHz / Chain 1 + Chain 2 / 5180 MHz**

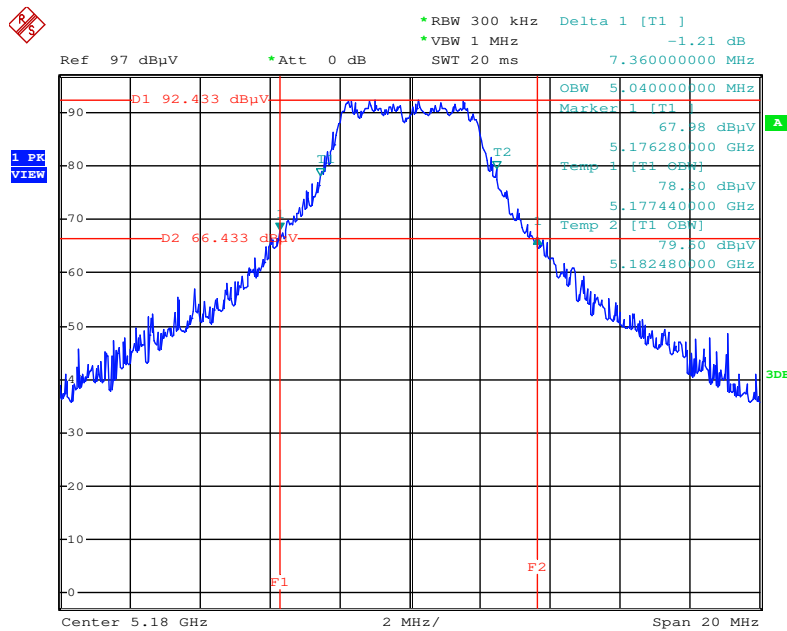

Date: 21.AUG.2014 10:49:00

**26dB Bandwidth and 99% Occupied Bandwidth Plot on Configuration IEEE 802.11a 5 MHz / Chain 1 + Chain 2 / 5210 MHz**

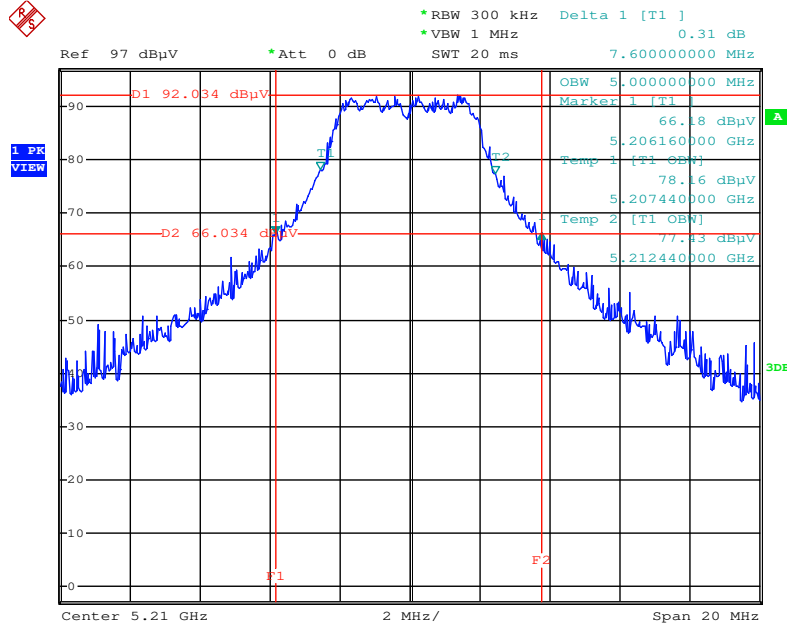

Date: 21.AUG.2014 10:49:36

**26dB Bandwidth and 99% Occupied Bandwidth Plot on Configuration IEEE 802.11a 5 MHz / Chain 1 + Chain 2 / 5240 MHz**

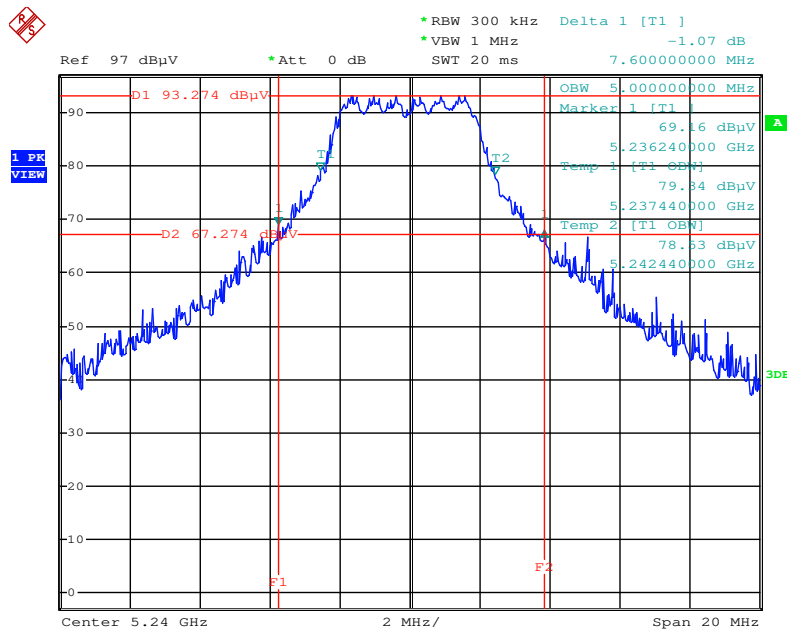

Date: 21.AUG.2014 10:50:12

**26dB Bandwidth and 99% Occupied Bandwidth Plot on Configuration IEEE 802.11a 10 MHz / Chain 1 + Chain 2 / 5180 MHz**

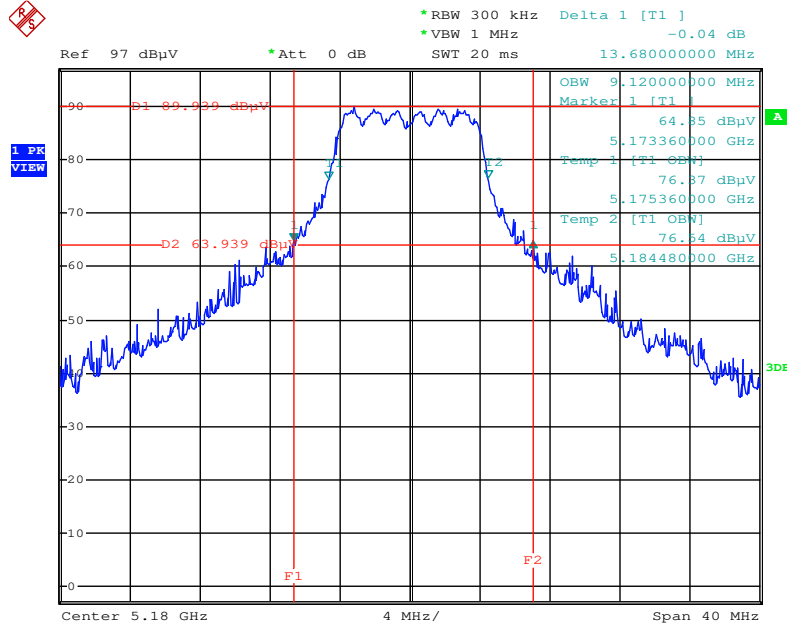

Date: 21.AUG.2014 11:27:54

**26dB Bandwidth and 99% Occupied Bandwidth Plot on Configuration IEEE 802.11a 10 MHz / Chain 1 + Chain 2 / 5210 MHz**

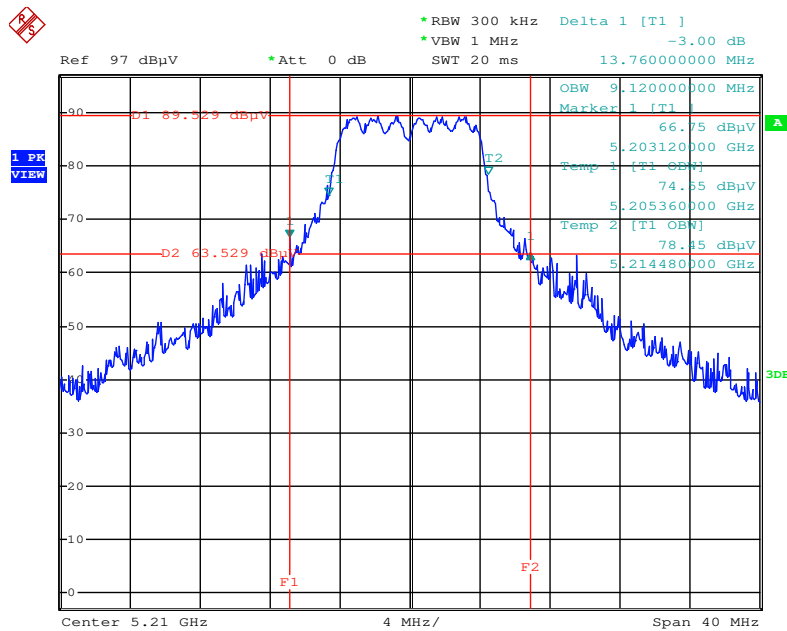

Date: 21.AUG.2014 11:28:35

**26dB Bandwidth and 99% Occupied Bandwidth Plot on Configuration IEEE 802.11a 10 MHz / Chain 1 + Chain 2 / 5240 MHz**

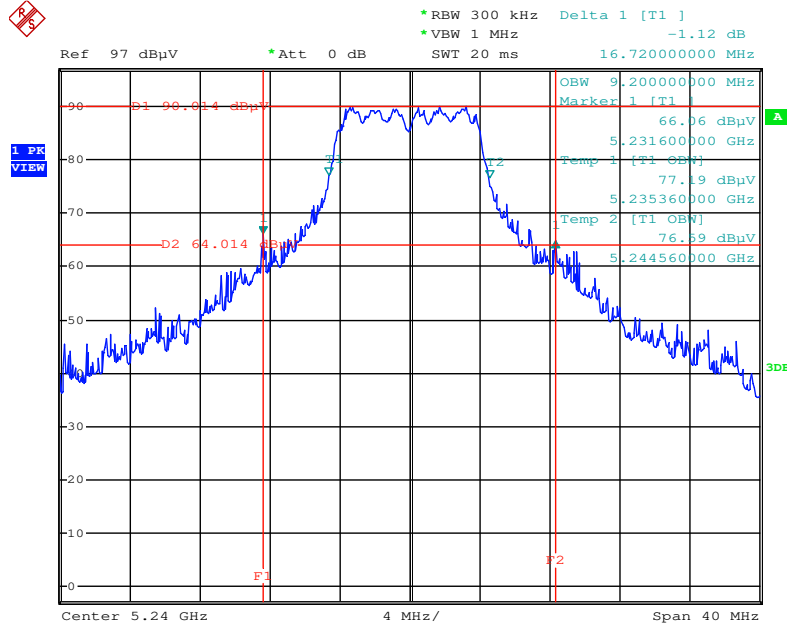

Date: 21.AUG.2014 11:29:42

**26dB Bandwidth and 99% Occupied Bandwidth Plot on Configuration IEEE 802.11a 20 MHz / Chain 1 + Chain 2 / 5180 MHz**

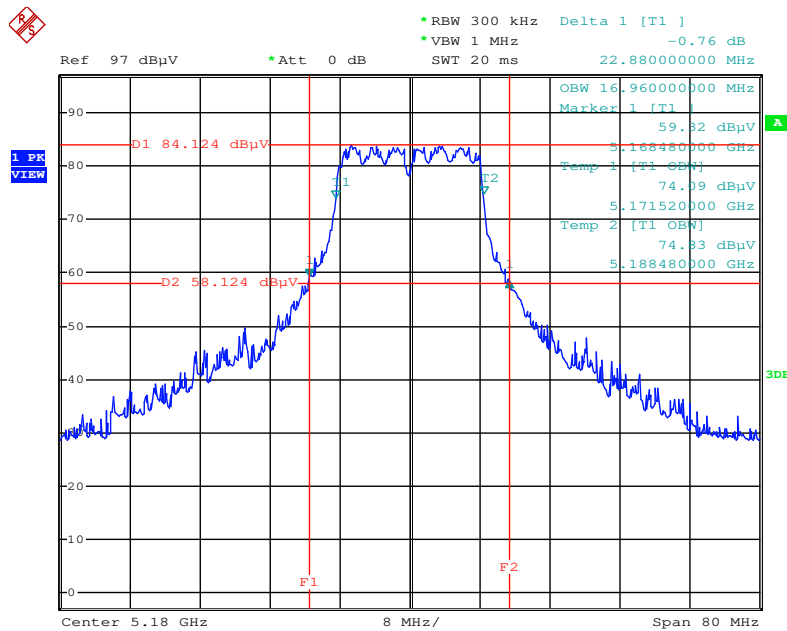

Date: 21.AUG.2014 11:55:39

**26dB Bandwidth and 99% Occupied Bandwidth Plot on Configuration IEEE 802.11a 20 MHz / Chain 1 + Chain 2 / 5200 MHz**

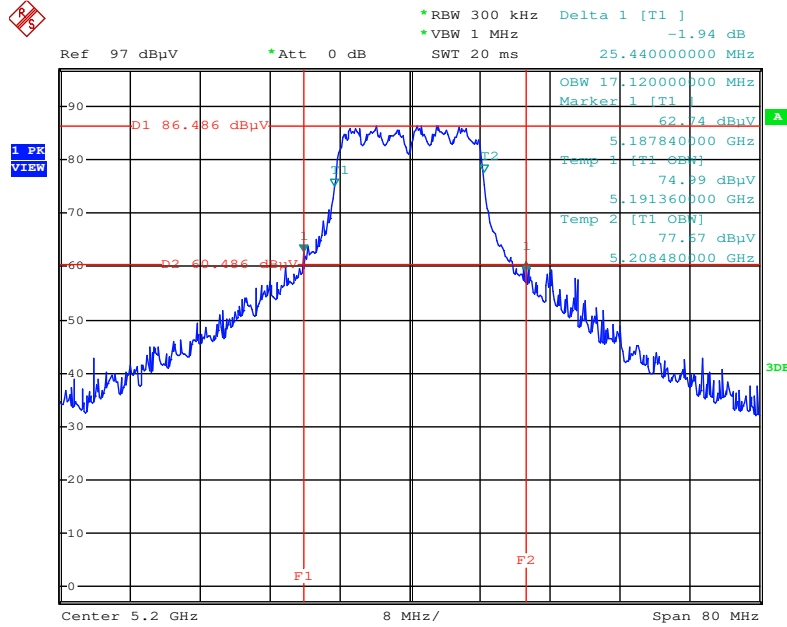

Date: 21.AUG.2014 11:56:20

**26dB Bandwidth and 99% Occupied Bandwidth Plot on Configuration IEEE 802.11a 20 MHz / Chain 1 + Chain 2 / 5240 MHz**

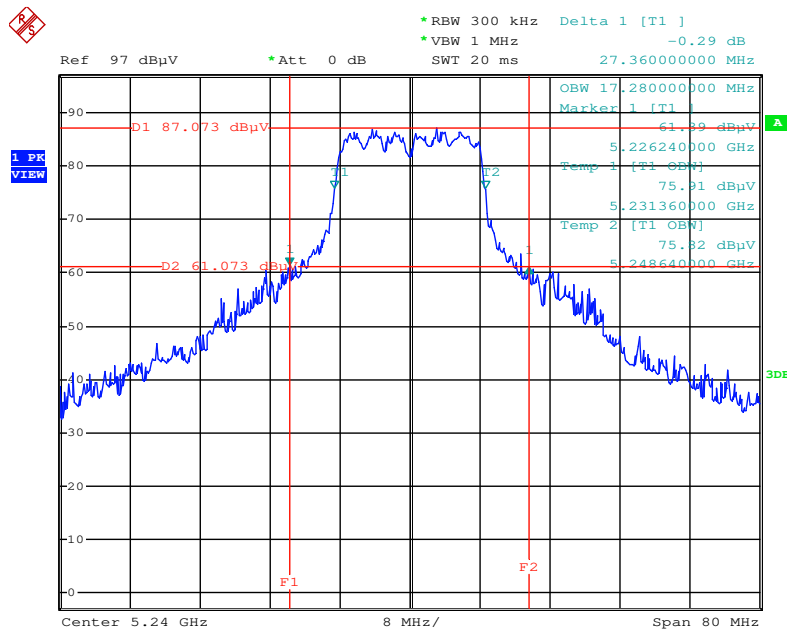

Date: 21.AUG.2014 11:56:59

Test Mode 2 / P to M

26dB Bandwidth and 99% Occupied Bandwidth Plot on Configuration IEEE 802.11n MCS0 5 MHz / Chain 1 + Chain 2 / 5180 MHz

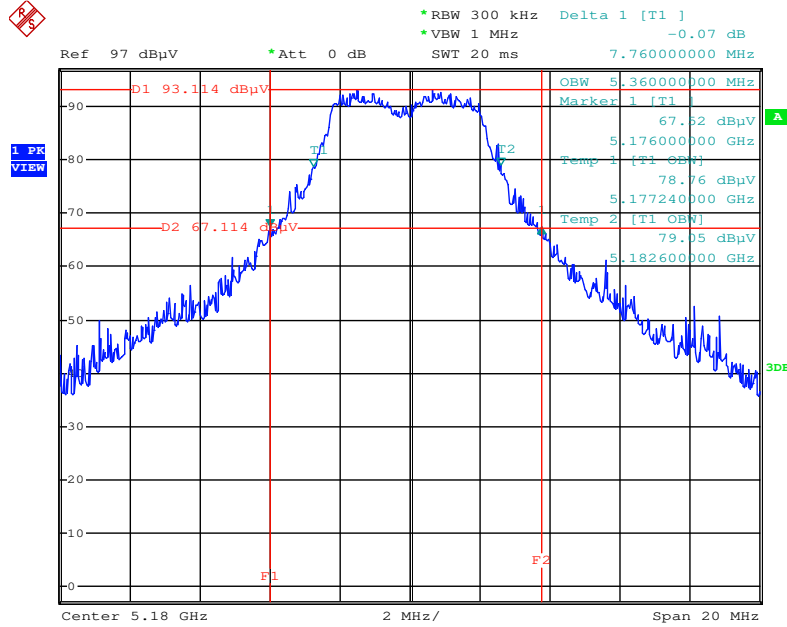

Date: 21.AUG.2014 10:52:33

26dB Bandwidth and 99% Occupied Bandwidth Plot on Configuration IEEE 802.11n MCS0 5 MHz / Chain 1 + Chain 2 / 5210 MHz

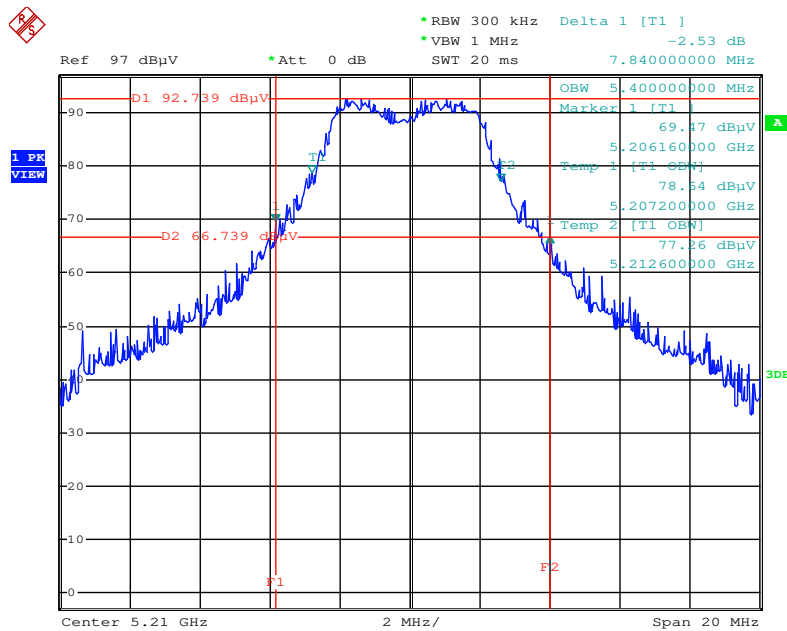

Date: 21.AUG.2014 10:51:56

**26dB Bandwidth and 99% Occupied Bandwidth Plot on Configuration IEEE 802.11n MCS0 5 MHz / Chain 1 + Chain 2 / 5240 MHz**

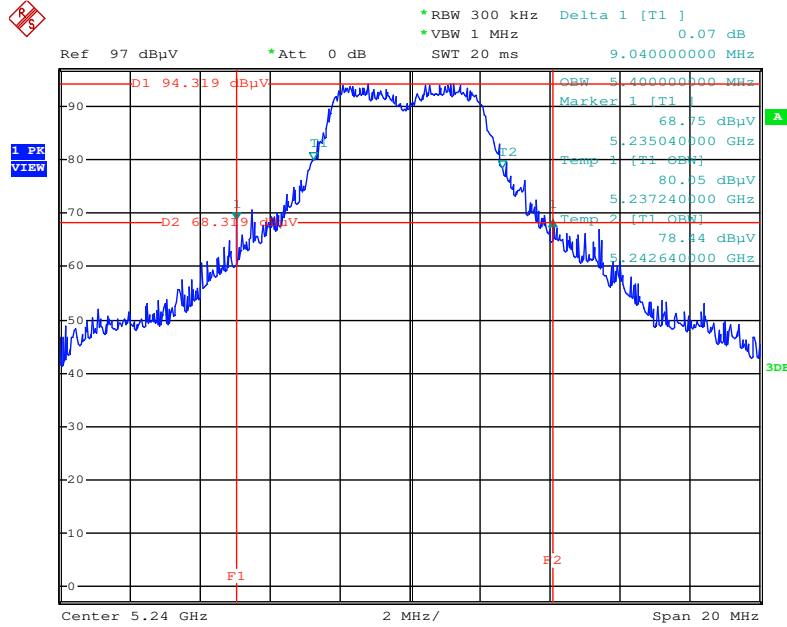

Date: 21.AUG.2014 10:51:05

**26dB Bandwidth and 99% Occupied Bandwidth Plot on Configuration IEEE 802.11n MCS0 10 MHz / Chain 1 + Chain 2 / 5180 MHz**

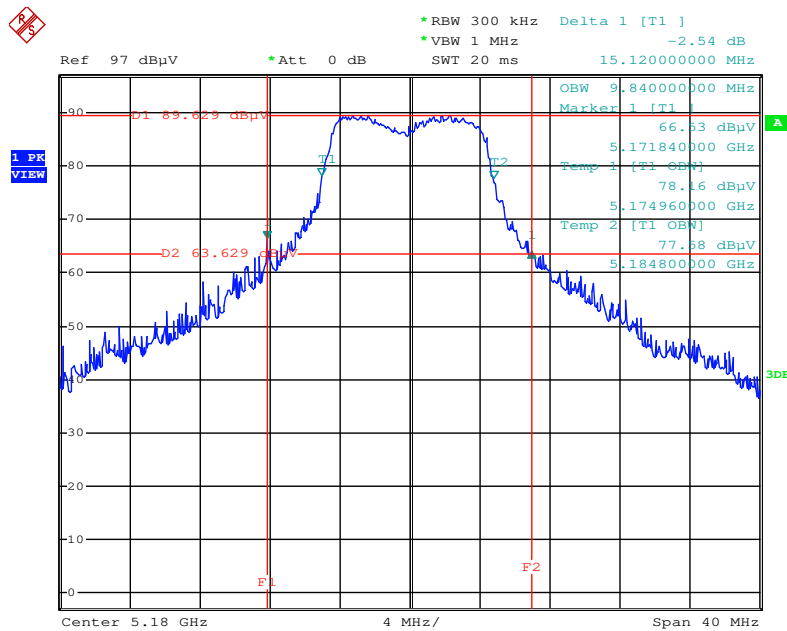

Date: 21.AUG.2014 11:25:27



**26dB Bandwidth and 99% Occupied Bandwidth Plot on Configuration IEEE 802.11n MCS0 10 MHz / Chain 1 + Chain 2 / 5210 MHz**

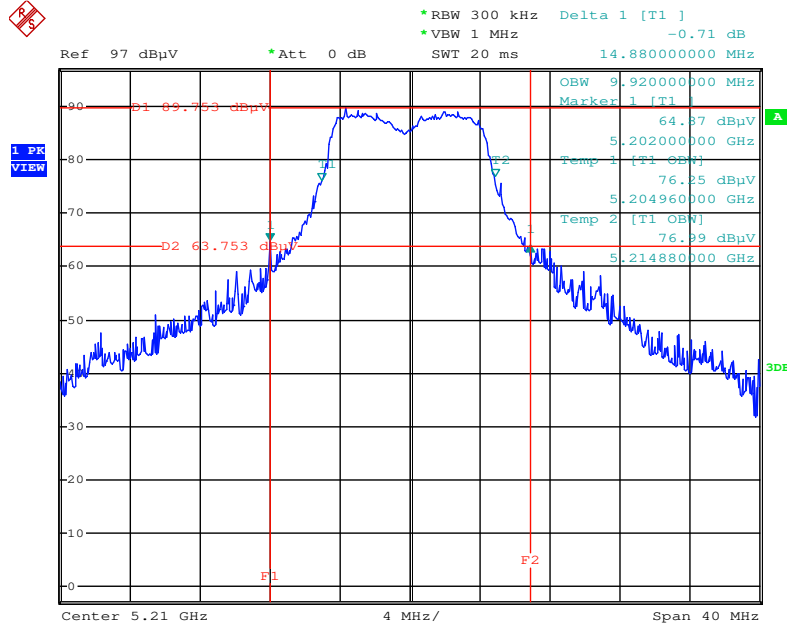

Date: 21.AUG.2014 11:23:43

**26dB Bandwidth and 99% Occupied Bandwidth Plot on Configuration IEEE 802.11n MCS0 10 MHz / Chain 1 + Chain 2 / 5240 MHz**

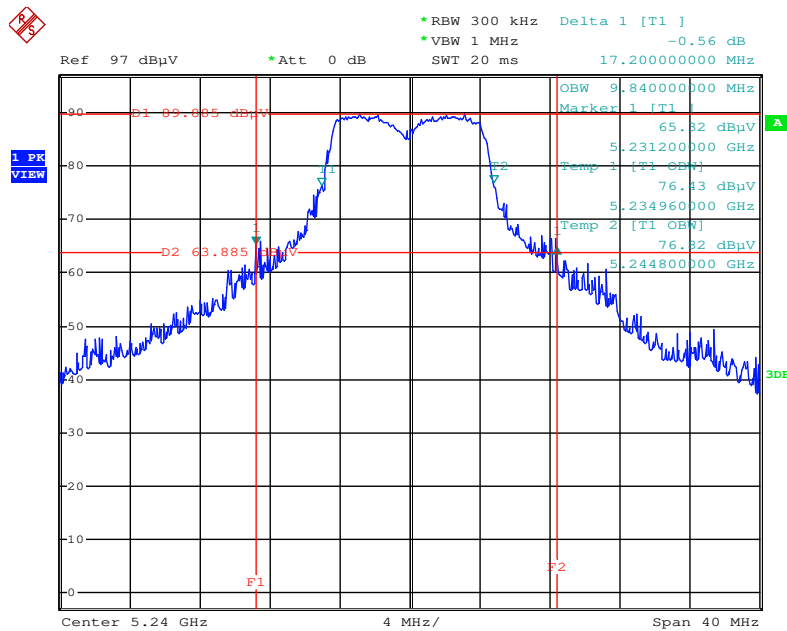

Date: 21.AUG.2014 11:23:01

**26dB Bandwidth and 99% Occupied Bandwidth Plot on Configuration IEEE 802.11n MCS0 20 MHz / Chain 1 + Chain 2 / 5180 MHz**

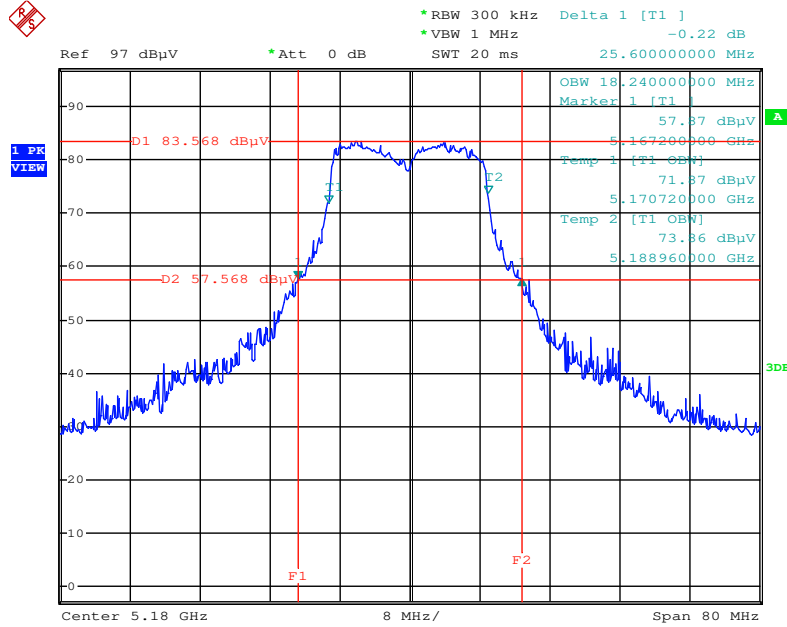

Date: 21.AUG.2014 11:59:16

**26dB Bandwidth and 99% Occupied Bandwidth Plot on Configuration IEEE 802.11n MCS0 20 MHz / Chain 1 + Chain 2 / 5200 MHz**

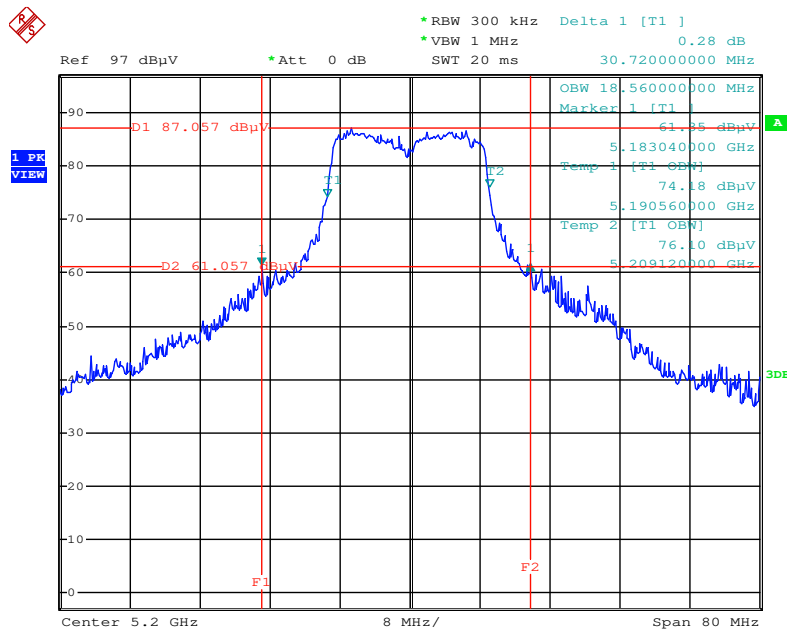

Date: 21.AUG.2014 11:58:19

**26dB Bandwidth and 99% Occupied Bandwidth Plot on Configuration IEEE 802.11n MCS0 20 MHz / Chain 1 + Chain 2 / 5240 MHz**

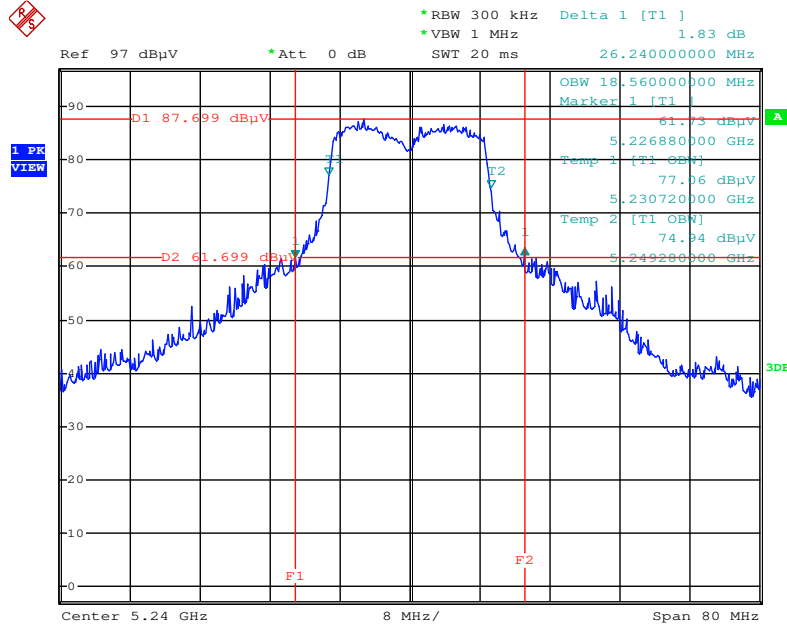

Date: 21.AUG.2014 11:57:42

**26dB Bandwidth and 99% Occupied Bandwidth Plot on Configuration IEEE 802.11n MCS0 40 MHz / Chain 1 + Chain 2 / 5190 MHz**

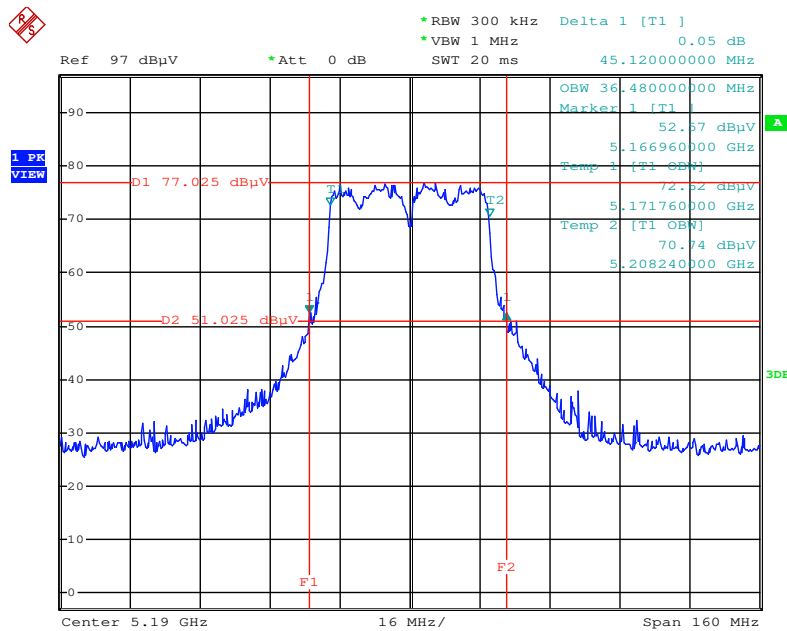

Date: 21.AUG.2014 12:00:17

**26dB Bandwidth and 99% Occupied Bandwidth Plot on Configuration IEEE 802.11n MCS0 40 MHz / Chain 1 + Chain 2 / 5230 MHz**

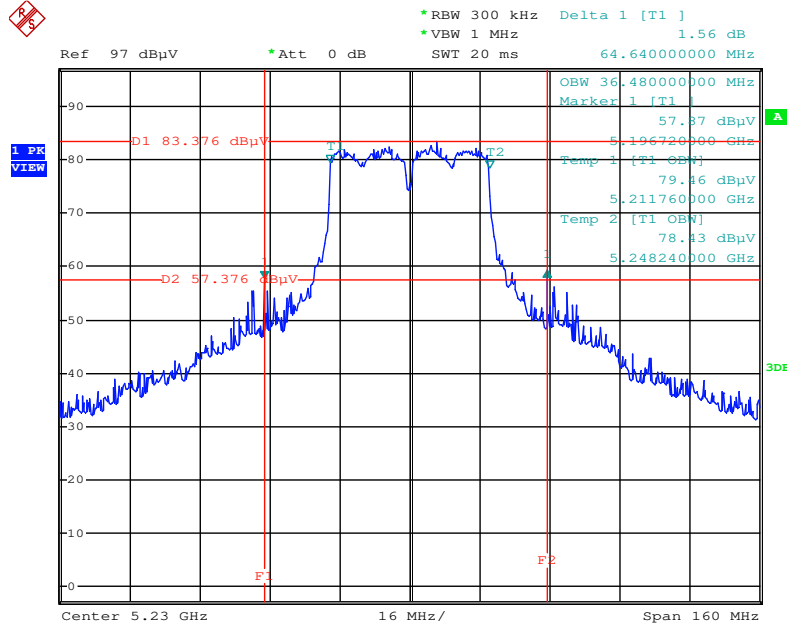

Date: 21.AUG.2014 12:00:57

**26dB Bandwidth and 99% Occupied Bandwidth Plot on Configuration IEEE 802.11a 5 MHz / Chain 1 + Chain 2 / 5180 MHz**

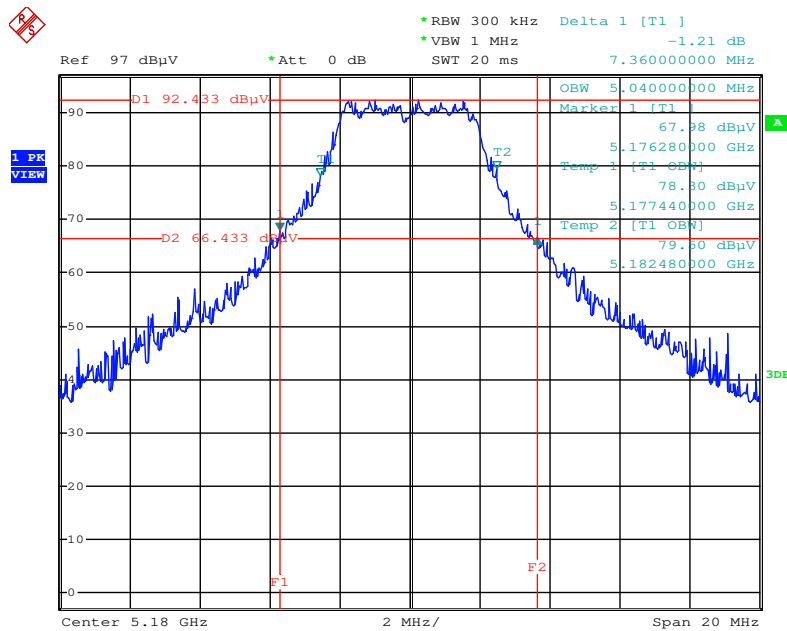

Date: 21.AUG.2014 10:49:00

**26dB Bandwidth and 99% Occupied Bandwidth Plot on Configuration IEEE 802.11a 5 MHz / Chain 1 + Chain 2 / 5210 MHz**

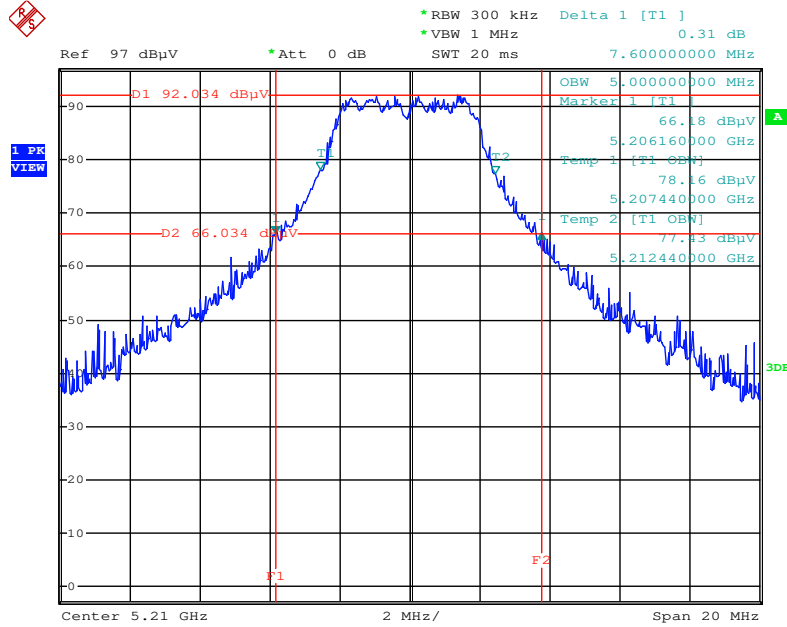

Date: 21.AUG.2014 10:49:36

**26dB Bandwidth and 99% Occupied Bandwidth Plot on Configuration IEEE 802.11a 5 MHz / Chain 1 + Chain 2 / 5240 MHz**

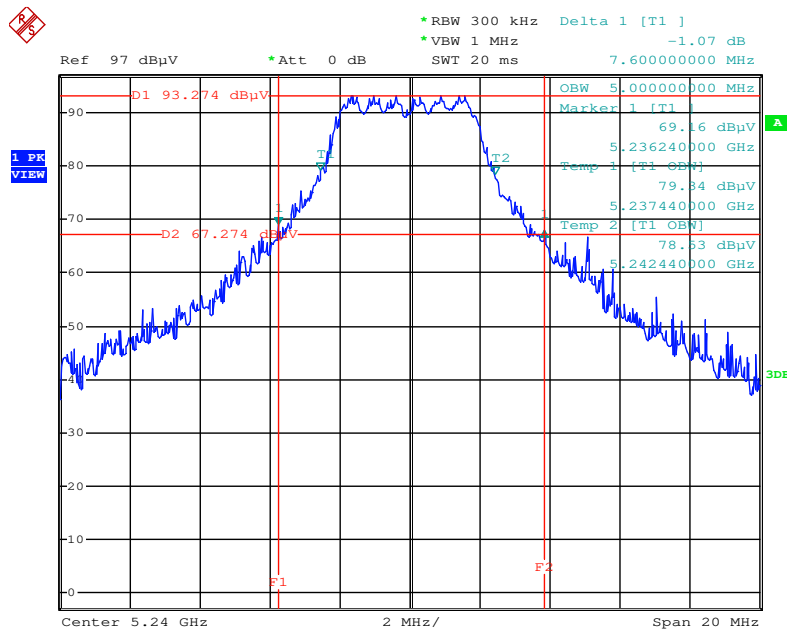

Date: 21.AUG.2014 10:50:12

**26dB Bandwidth and 99% Occupied Bandwidth Plot on Configuration IEEE 802.11a 10 MHz / Chain 1 + Chain 2 / 5180 MHz**

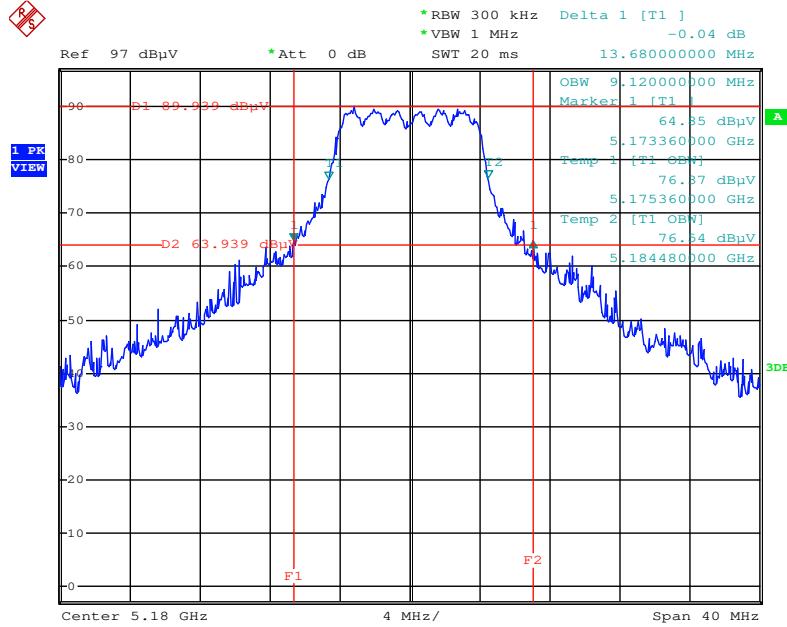

Date: 21.AUG.2014 11:27:54

**26dB Bandwidth and 99% Occupied Bandwidth Plot on Configuration IEEE 802.11a 10 MHz / Chain 1 + Chain 2 / 5210 MHz**

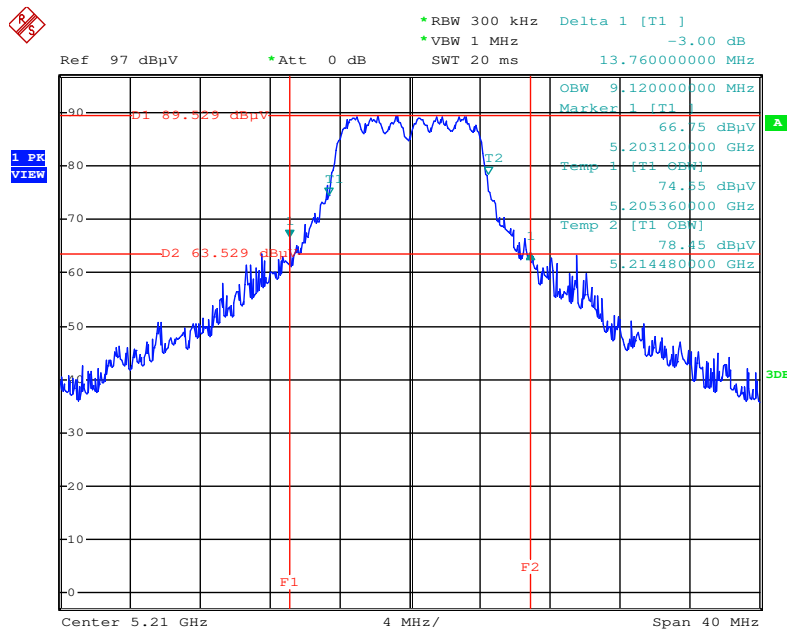

Date: 21.AUG.2014 11:28:35

**26dB Bandwidth and 99% Occupied Bandwidth Plot on Configuration IEEE 802.11a 10 MHz / Chain 1 + Chain 2 / 5240 MHz**

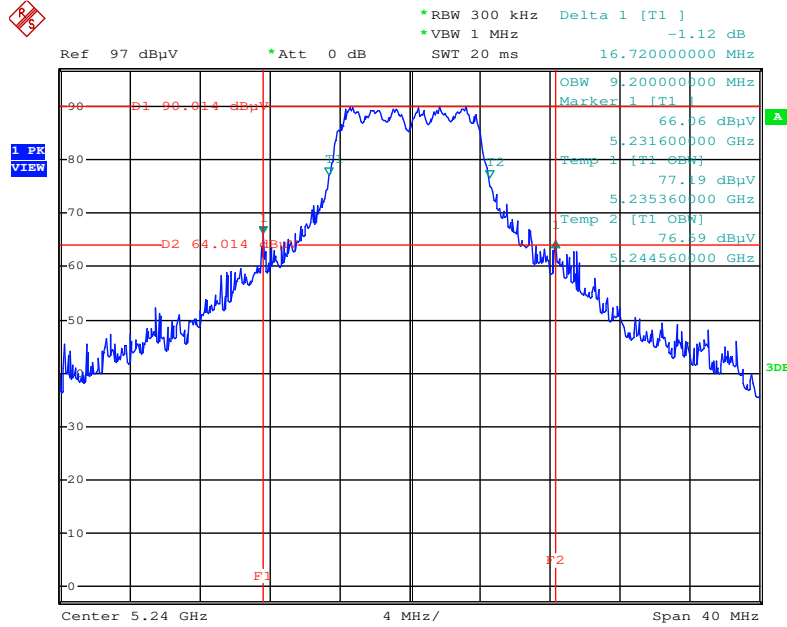

Date: 21.AUG.2014 11:29:42

**26dB Bandwidth and 99% Occupied Bandwidth Plot on Configuration IEEE 802.11a 20 MHz / Chain 1 + Chain 2 / 5180 MHz**

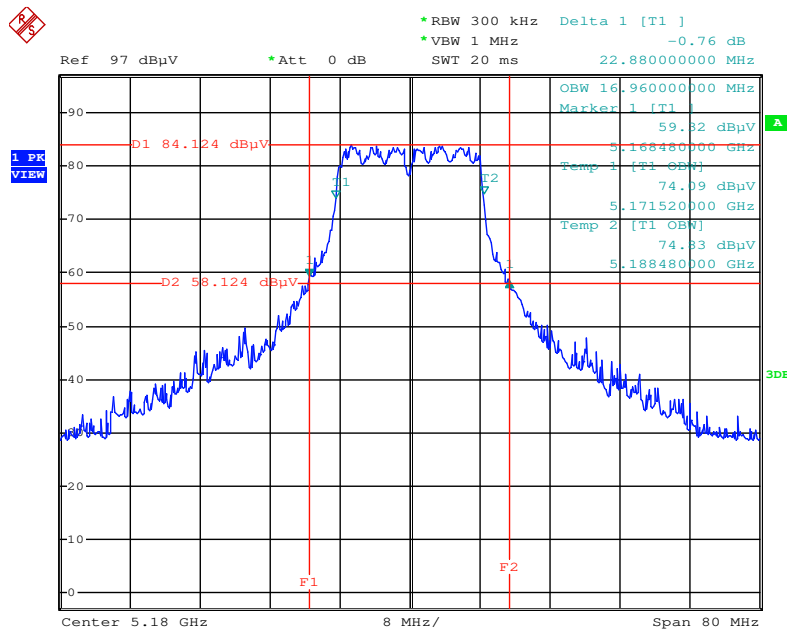

Date: 21.AUG.2014 11:55:39

**26dB Bandwidth and 99% Occupied Bandwidth Plot on Configuration IEEE 802.11a 20 MHz / Chain 1 + Chain 2 / 5200 MHz**

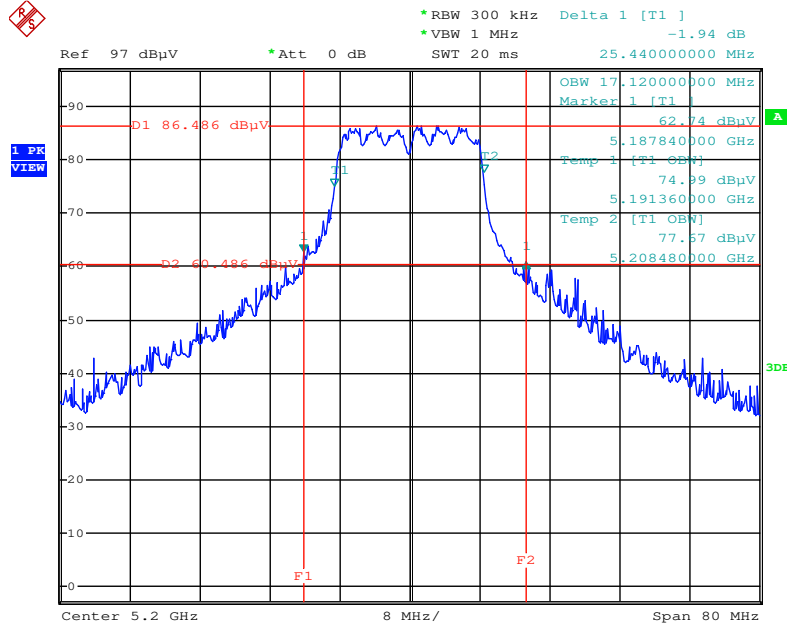

Date: 21.AUG.2014 11:56:20

**26dB Bandwidth and 99% Occupied Bandwidth Plot on Configuration IEEE 802.11a 20 MHz / Chain 1 + Chain 2 / 5240 MHz**

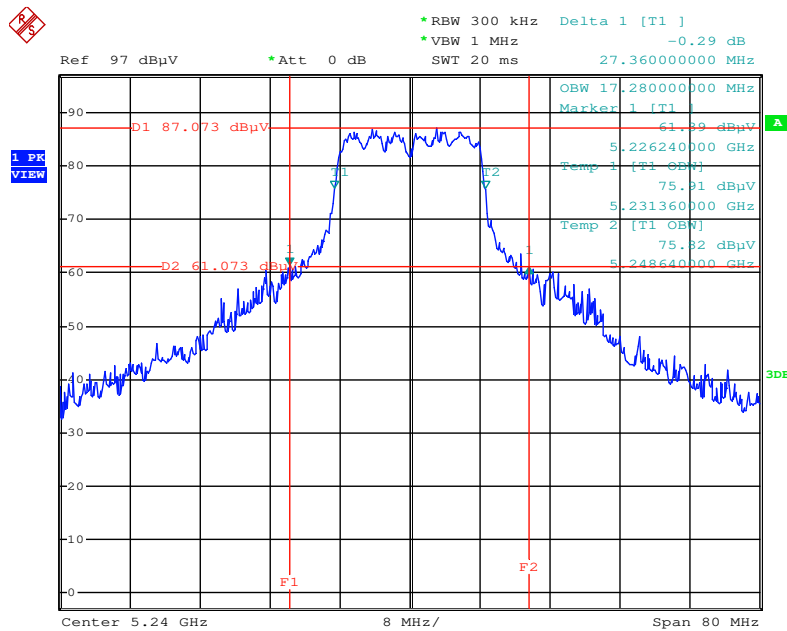

Date: 21.AUG.2014 11:56:59



Test Mode 3 / P to M

26dB Bandwidth and 99% Occupied Bandwidth Plot on Configuration IEEE 802.11n MCS0 5 MHz / Chain 1 + Chain 2 / 5180 MHz

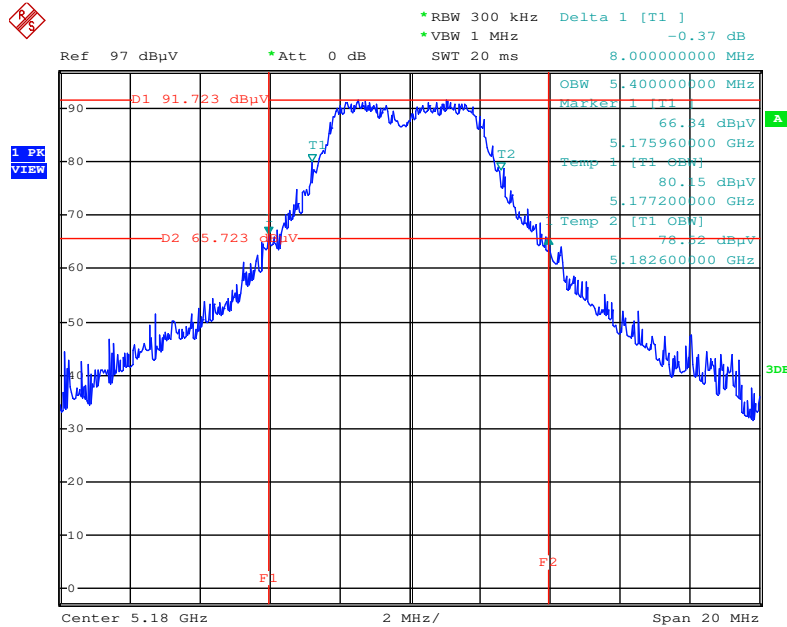

Date: 21.AUG.2014 11:02:40

26dB Bandwidth and 99% Occupied Bandwidth Plot on Configuration IEEE 802.11n MCS0 5 MHz / Chain 1 + Chain 2 / 5210 MHz

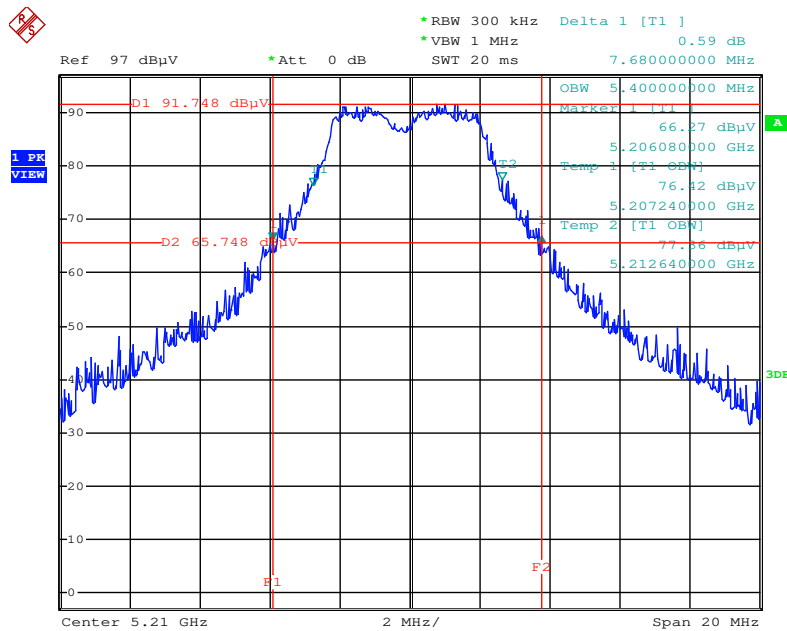

Date: 21.AUG.2014 11:03:13

**26dB Bandwidth and 99% Occupied Bandwidth Plot on Configuration IEEE 802.11n MCS0 5 MHz / Chain 1 + Chain 2 / 5240 MHz**

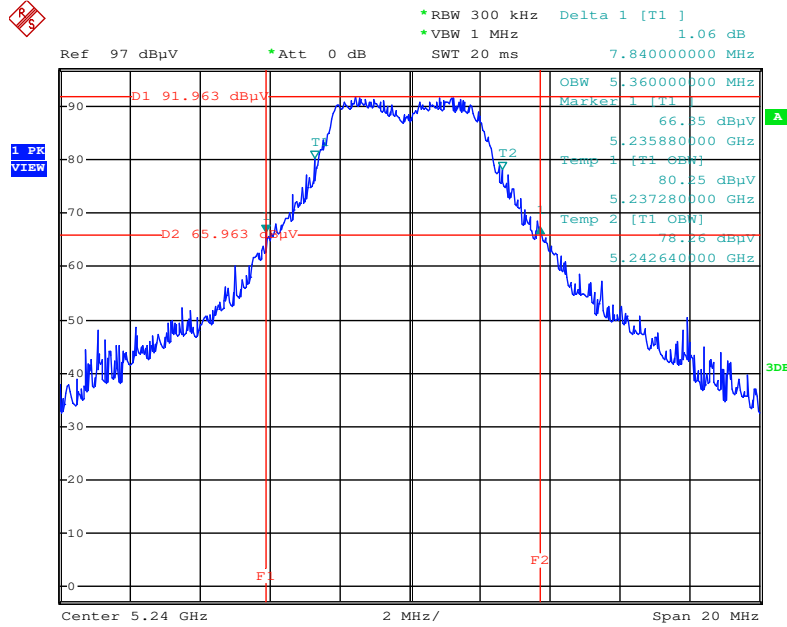

Date: 21.AUG.2014 11:04:03

**26dB Bandwidth and 99% Occupied Bandwidth Plot on Configuration IEEE 802.11n MCS0 10 MHz / Chain 1 + Chain 2 / 5180 MHz**

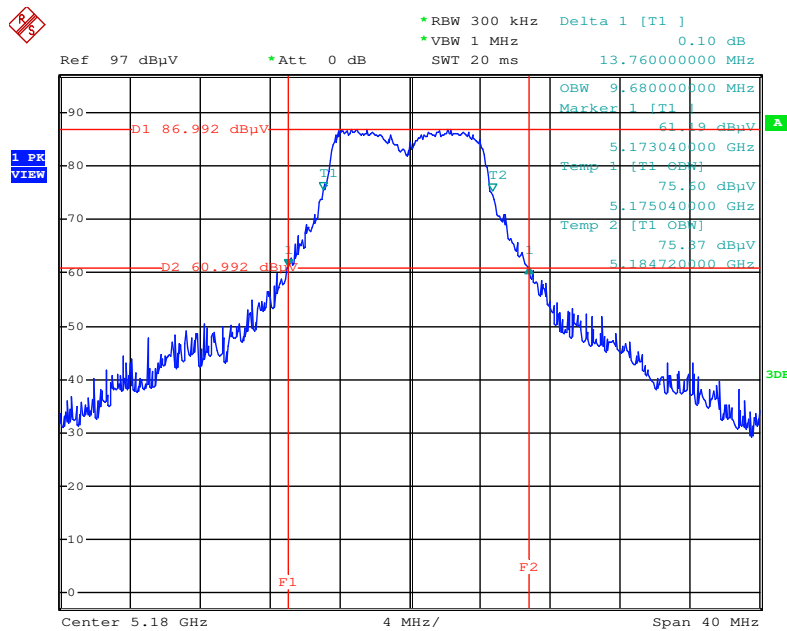

Date: 21.AUG.2014 11:42:38

**26dB Bandwidth and 99% Occupied Bandwidth Plot on Configuration IEEE 802.11n MCS0 10 MHz / Chain 1 + Chain 2 / 5210 MHz**

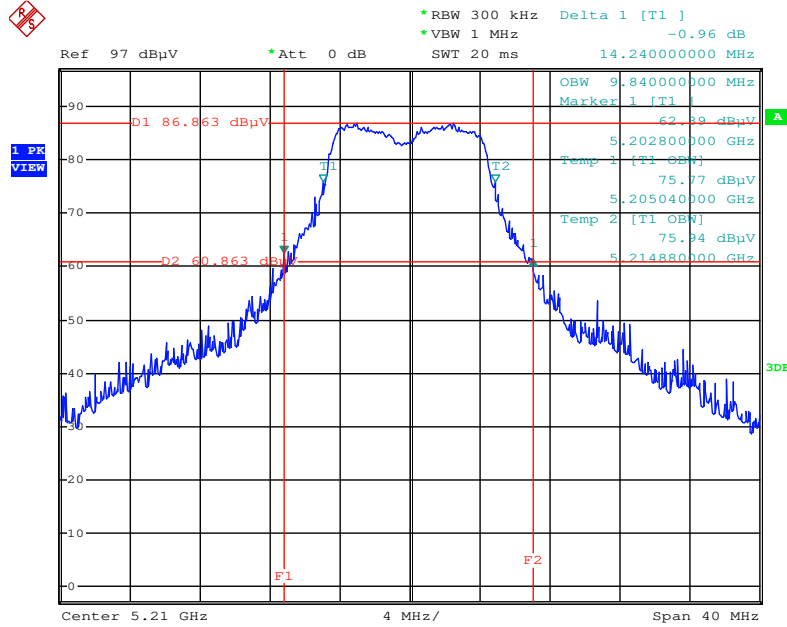

Date: 21.AUG.2014 11:41:50

**26dB Bandwidth and 99% Occupied Bandwidth Plot on Configuration IEEE 802.11n MCS0 10 MHz / Chain 1 + Chain 2 / 5240 MHz**

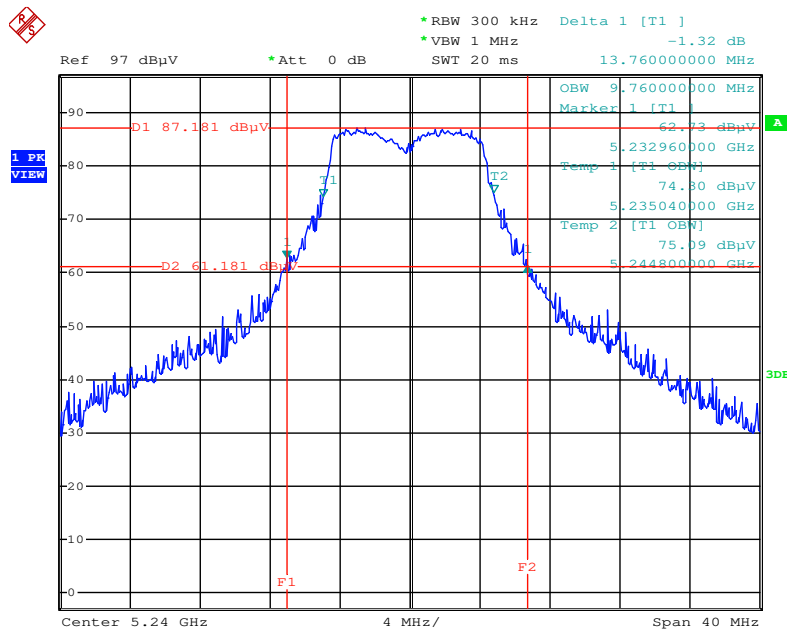

Date: 21.AUG.2014 11:40:59

**26dB Bandwidth and 99% Occupied Bandwidth Plot on Configuration IEEE 802.11n MCS0 20 MHz / Chain 1 + Chain 2 / 5180 MHz**

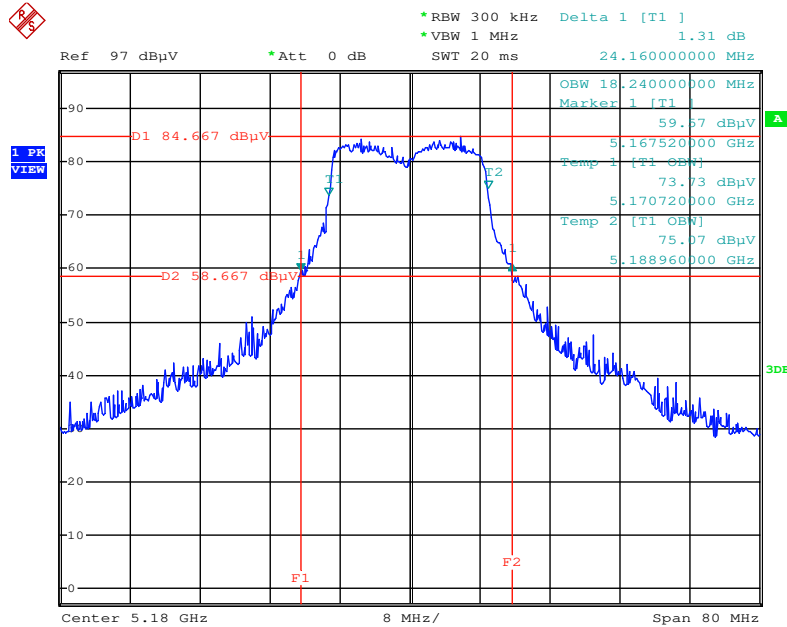

Date: 21.AUG.2014 11:47:52

**26dB Bandwidth and 99% Occupied Bandwidth Plot on Configuration IEEE 802.11n MCS0 20 MHz / Chain 1 + Chain 2 / 5200 MHz**

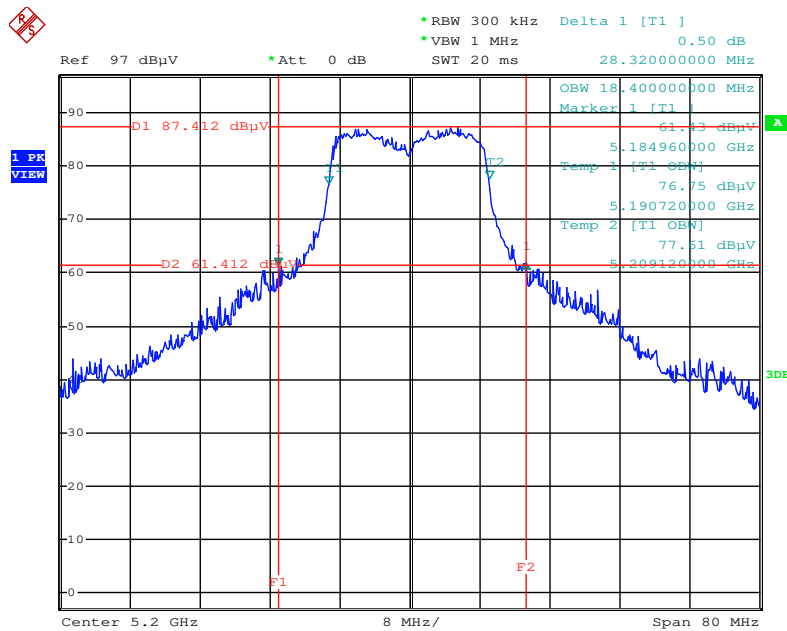

Date: 21.AUG.2014 11:48:34

**26dB Bandwidth and 99% Occupied Bandwidth Plot on Configuration IEEE 802.11n MCS0 20 MHz / Chain 1 + Chain 2 / 5240 MHz**

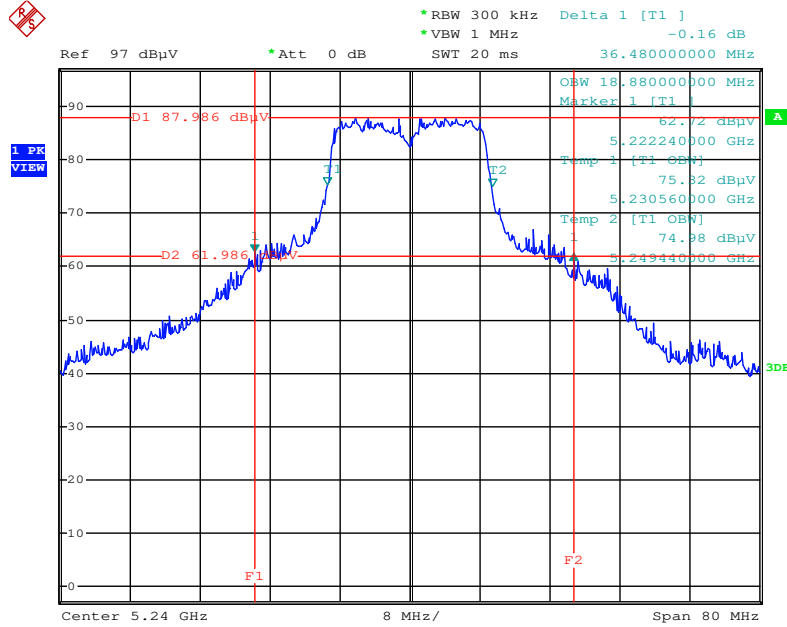

Date: 21.AUG.2014 11:49:20

**26dB Bandwidth and 99% Occupied Bandwidth Plot on Configuration IEEE 802.11n MCS0 40 MHz / Chain 1 + Chain 2 / 5190 MHz**

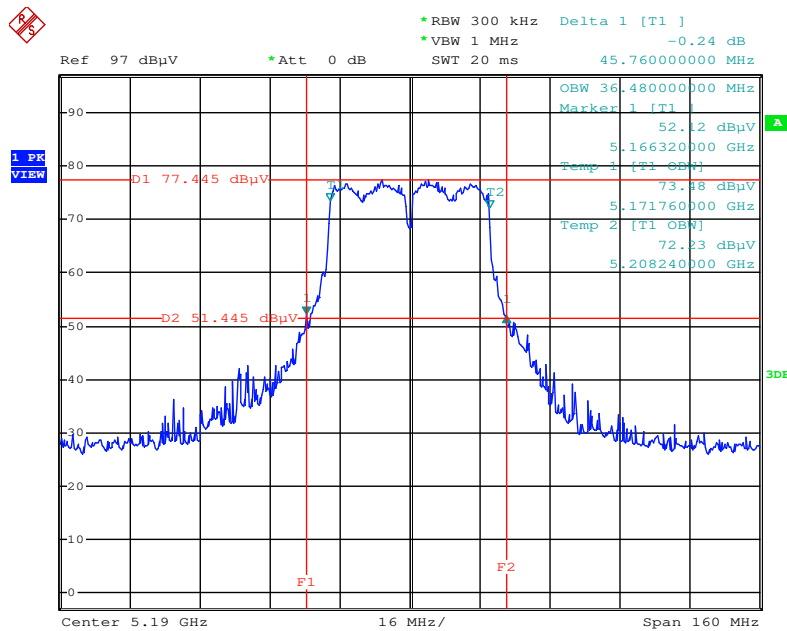

Date: 21.AUG.2014 11:51:26

**26dB Bandwidth and 99% Occupied Bandwidth Plot on Configuration IEEE 802.11n MCS0 40 MHz / Chain 1 + Chain 2 / 5230 MHz**

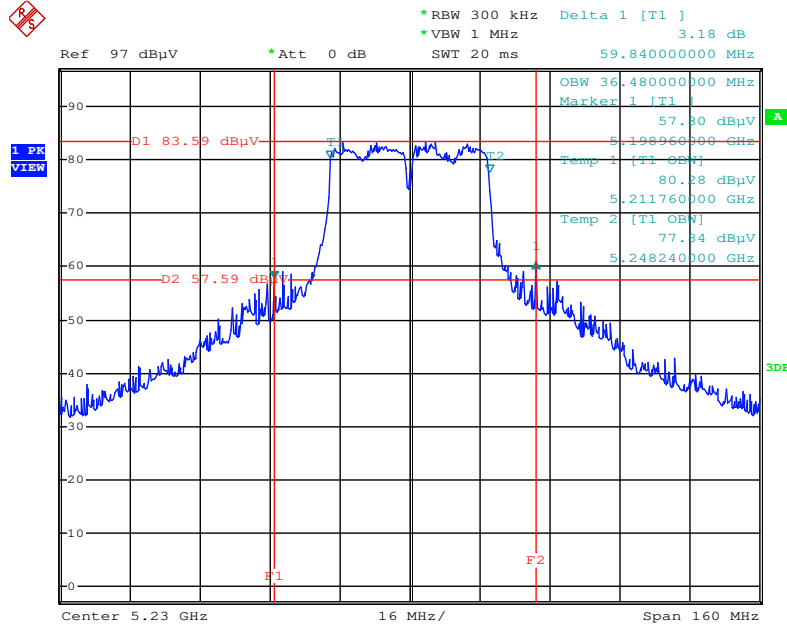

Date: 21.AUG.2014 11:50:42

**26dB Bandwidth and 99% Occupied Bandwidth Plot on Configuration IEEE 802.11a 5 MHz / Chain 1 + Chain 2 / 5180 MHz**

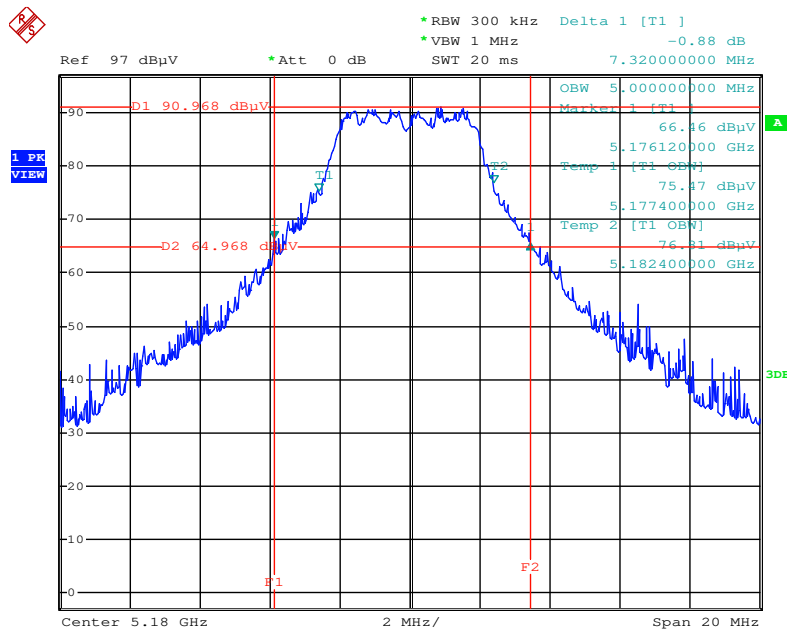

Date: 21.AUG.2014 11:08:30

**26dB Bandwidth and 99% Occupied Bandwidth Plot on Configuration IEEE 802.11a 5 MHz / Chain 1 + Chain 2 / 5210 MHz**

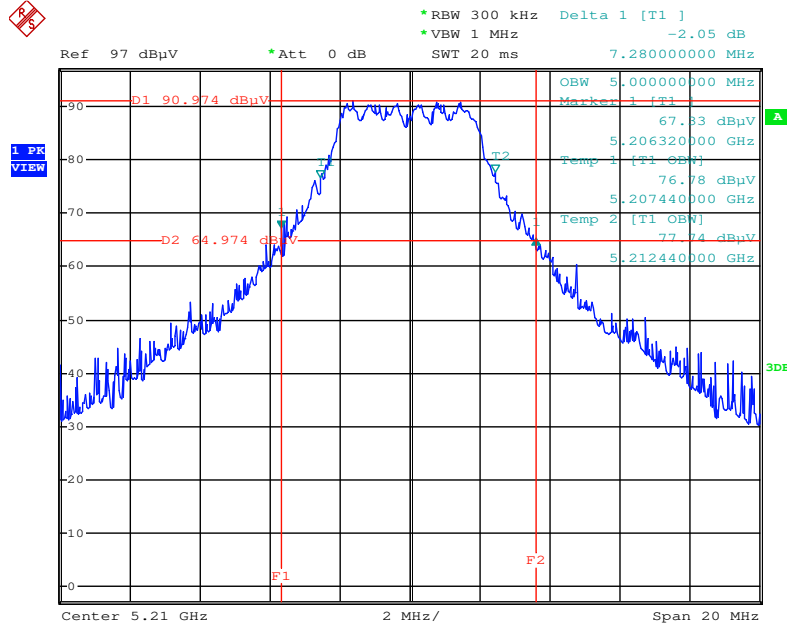

Date: 21.AUG.2014 11:07:33

**26dB Bandwidth and 99% Occupied Bandwidth Plot on Configuration IEEE 802.11a 5 MHz / Chain 1 + Chain 2 / 5240 MHz**

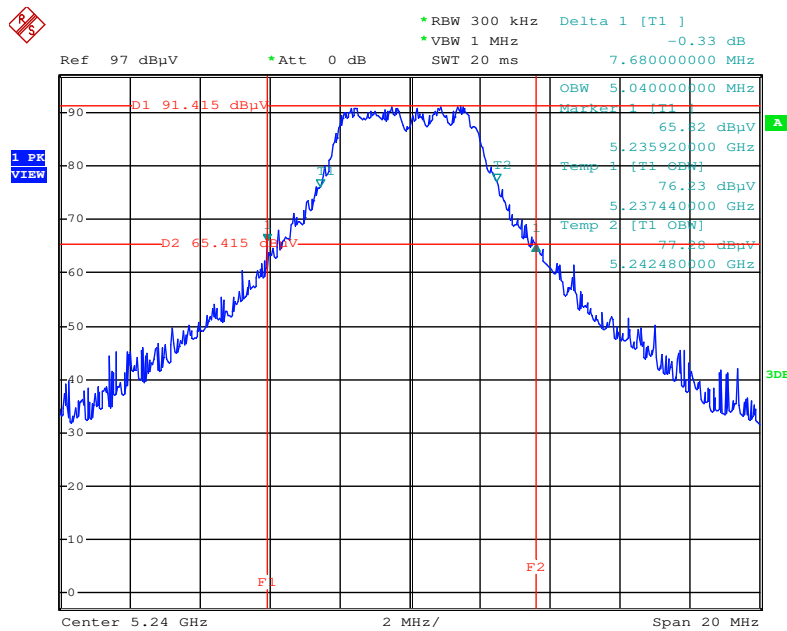

Date: 21.AUG.2014 11:04:58

**26dB Bandwidth and 99% Occupied Bandwidth Plot on Configuration IEEE 802.11a 10 MHz / Chain 1 + Chain 2 / 5180 MHz**

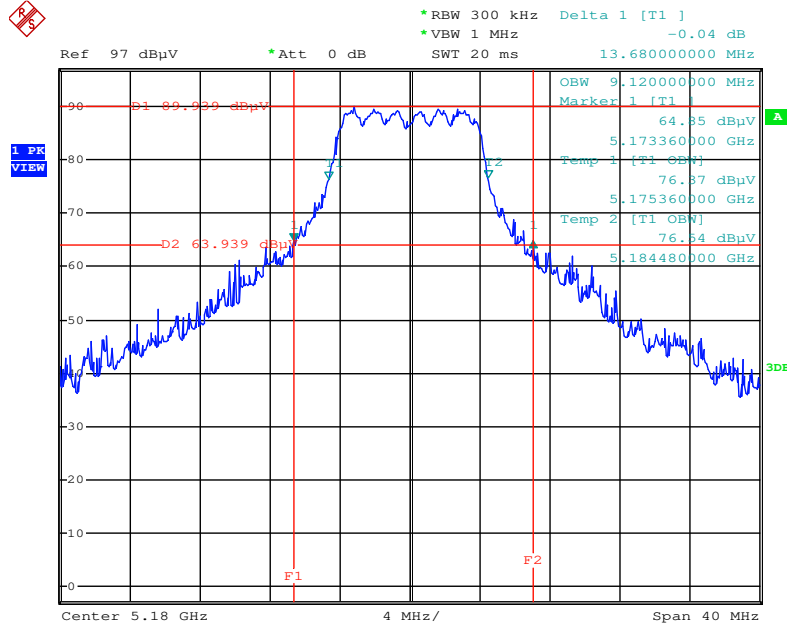

Date: 21.AUG.2014 11:27:54

**26dB Bandwidth and 99% Occupied Bandwidth Plot on Configuration IEEE 802.11a 10 MHz / Chain 1 + Chain 2 / 5210 MHz**

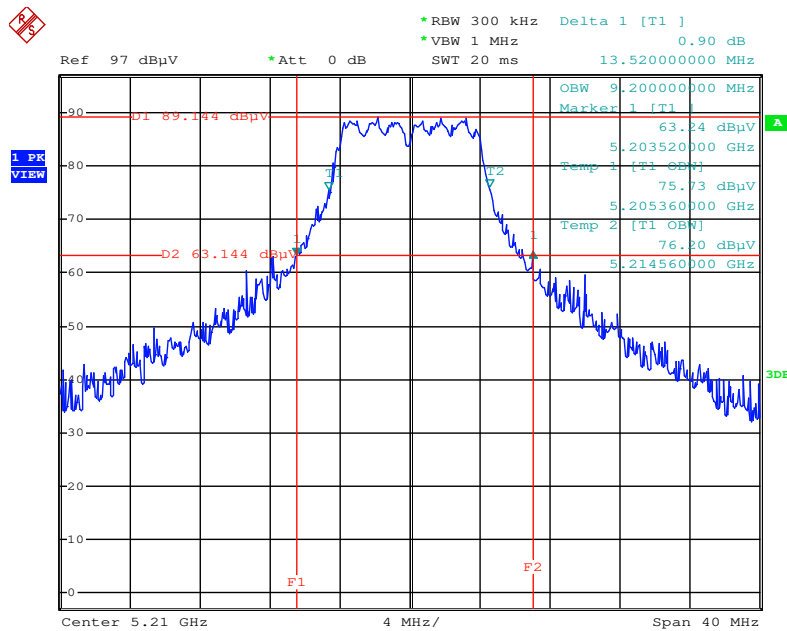

Date: 21.AUG.2014 11:35:51



**26dB Bandwidth and 99% Occupied Bandwidth Plot on Configuration IEEE 802.11a 10 MHz / Chain 1 + Chain 2 / 5240 MHz**

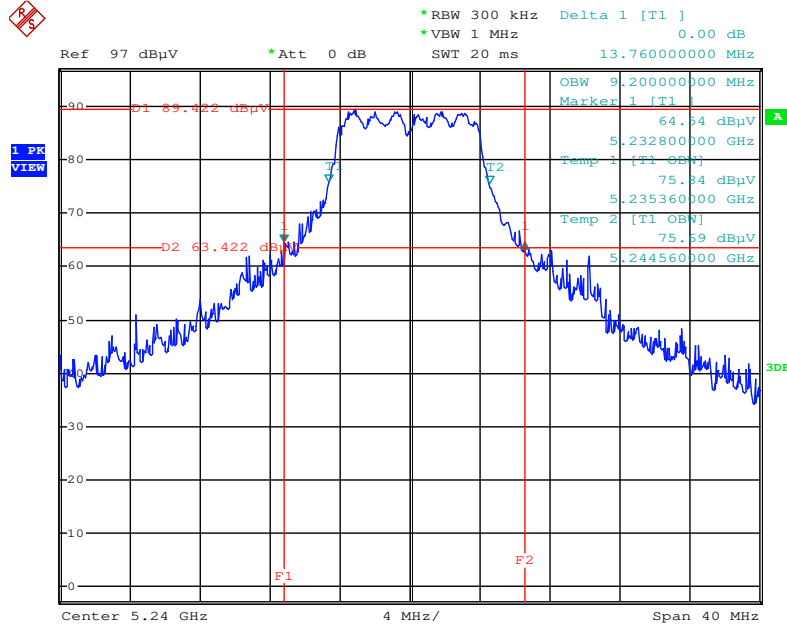

Date: 21.AUG.2014 11:37:27

**26dB Bandwidth and 99% Occupied Bandwidth Plot on Configuration IEEE 802.11a 20 MHz / Chain 1 + Chain 2 / 5180 MHz**

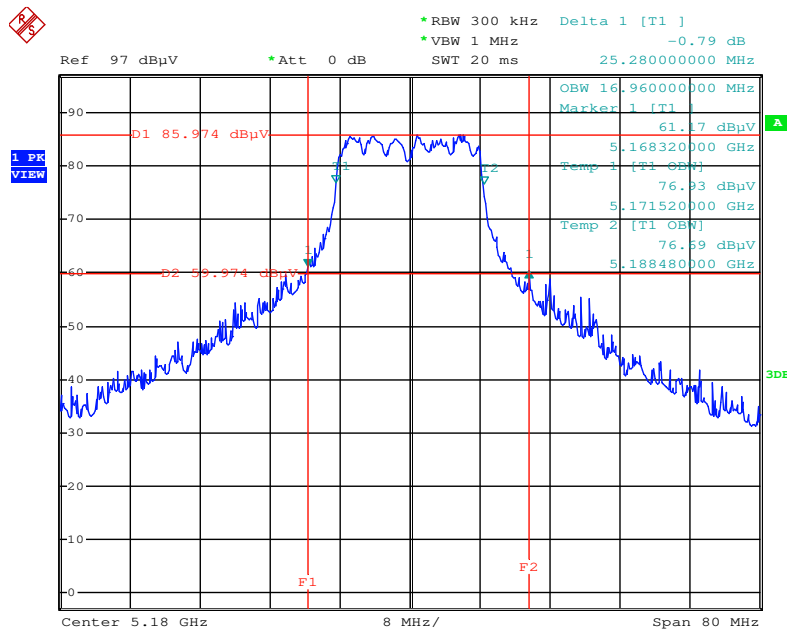

Date: 21.AUG.2014 11:47:05

**26dB Bandwidth and 99% Occupied Bandwidth Plot on Configuration IEEE 802.11a 20 MHz / Chain 1 + Chain 2 / 5200 MHz**

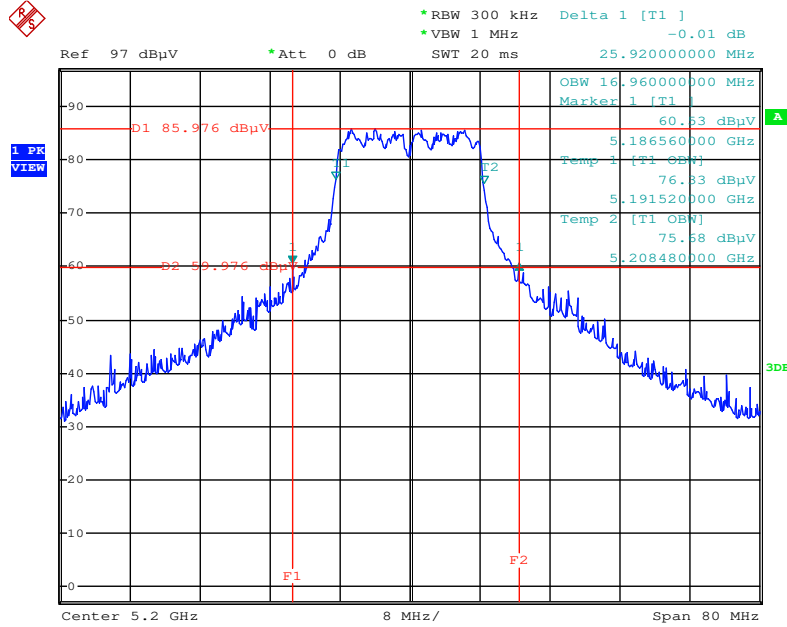

Date: 21.AUG.2014 11:46:32

**26dB Bandwidth and 99% Occupied Bandwidth Plot on Configuration IEEE 802.11a 20 MHz / Chain 1 + Chain 2 / 5240 MHz**

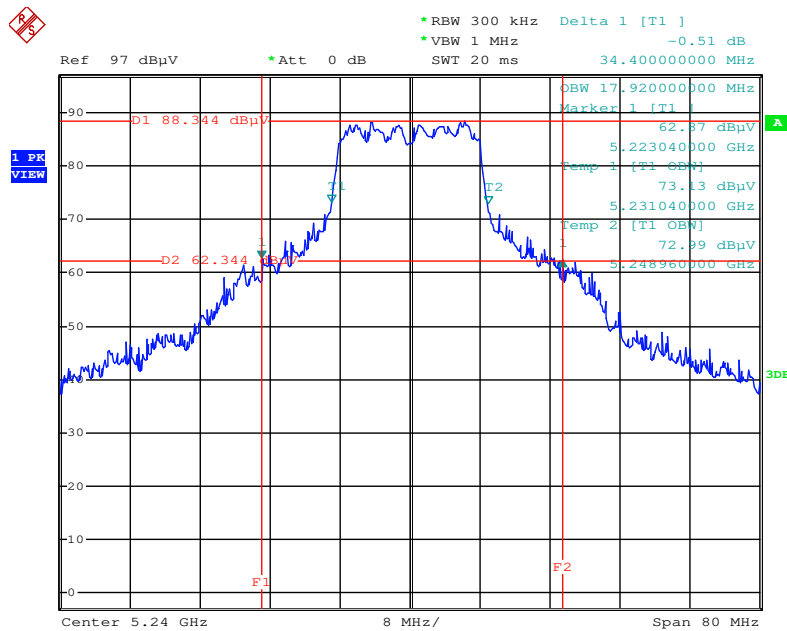

Date: 21.AUG.2014 11:45:32

## 4.2. Maximum Conducted Output Power Measurement

### 4.2.1. Limit

For an outdoor access point operating in the band 5.15-5.25 GHz, the maximum conducted output power over the frequency band of operation shall not exceed 1 W provided the maximum antenna gain does not exceed 6 dBi. In addition, the maximum power spectral density shall not exceed 17 dBm in any 1 megahertz band. If transmitting antennas of directional gain greater than 6 dBi are used, both the maximum conducted output power and the maximum power spectral density shall be reduced by the amount in dB that the directional gain of the antenna exceeds 6 dBi. The maximum e.i.r.p. at any elevation angle above 30 degrees as measured from the horizon must not exceed 125 mW (21 dBm).

For fixed point-to-point access points operating in the band 5.15-5.25 GHz, the maximum conducted output power over the frequency band of operation shall not exceed 1 W. Fixed point-to-point U-NII devices may employ antennas with directional gain up to 23 dBi without any corresponding reduction in the maximum conducted output power or maximum power spectral density. For fixed point-to-point transmitters that employ a directional antenna gain greater than 23 dBi, a 1 dB reduction in maximum conducted output power and maximum power spectral density is required for each 1 dB of antenna gain in excess of 23 dBi. Fixed, point-to-point operations exclude the use of point-to-multipoint systems, omnidirectional applications, and multiple collocated transmitters transmitting the same information. The operator of the U-NII device, or if the equipment is professionally installed, the installer, is responsible for ensuring that systems employing high gain directional antennas are used exclusively for fixed, point-to-point operations.

### 4.2.2. Measuring Instruments and Setting

Please refer to section 5 of equipments list in this report. The following table is the setting of the power meter.

Power Meter Parameter	Setting
Bandwidth	50MHz bandwidth is greater than the EUT emission bandwidth
Detector	AVERAGE

#### 4.2.3. Test Procedures

1. The transmitter output (antenna port) was connected to the power meter.
2. Test was performed in accordance with KDB789033 D02 v01 for Compliance Testing of Unlicensed National Information Infrastructure (U-NII) Devices - section (E) Maximum conducted output power =>3. Measurement using a Power Meter (PM) =>b) Method PM-G (Measurement using a gated RF average power meter).
3. Multiple antenna systems was performed in accordance with KDB662911 D01 v02r01 Emissions Testing of Transmitters with Multiple Outputs in the Same Band.
4. When measuring maximum conducted output power with multiple antenna systems, add every result of the values by mathematic formula.

#### 4.2.4. Test Setup Layout

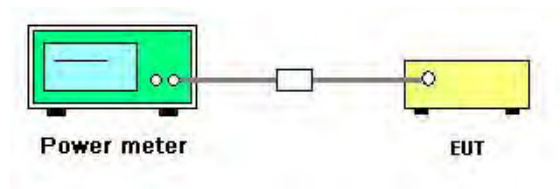

#### 4.2.5. Test Deviation

There is no deviation with the original standard.

#### 4.2.6. EUT Operation during Test

The EUT was programmed to be in continuously transmitting mode.

#### 4.2.7. Test Result of Maximum Conducted Output Power

Temperature	26°C	Humidity	63%
Test Engineer	Jim Huang	Configurations	IEEE 802.11n/a
Test Date	Aug. 21, 2014	Test Mode	Mode 1 / P to P

##### Configuration IEEE 802.11n MCS0 5 MHz

Channel	Frequency	Conducted Power (dBm)			Max. Limit (dBm)	Result
		Chain 1	Chain 2	Total		
36	5180 MHz	14.02	13.92	16.98	30.00	Complies
42	5210 MHz	14.42	14.07	17.26	30.00	Complies
48	5240 MHz	13.95	13.87	16.92	30.00	Complies

##### Configuration IEEE 802.11n MCS0 10 MHz

Channel	Frequency	Conducted Power (dBm)			Max. Limit (dBm)	Result
		Chain 1	Chain 2	Total		
36	5180 MHz	13.75	13.81	16.79	30.00	Complies
42	5210 MHz	14.12	14.09	17.12	30.00	Complies
48	5240 MHz	13.72	13.78	16.76	30.00	Complies

##### Configuration IEEE 802.11n MCS0 20 MHz

Channel	Frequency	Conducted Power (dBm)			Max. Limit (dBm)	Result
		Chain 1	Chain 2	Total		
36	5180 MHz	13.72	13.76	16.75	30.00	Complies
40	5200 MHz	14.12	14.03	17.09	30.00	Complies
48	5240 MHz	14.24	13.99	17.13	30.00	Complies

##### Configuration IEEE 802.11n MCS0 40 MHz

Channel	Frequency	Conducted Power (dBm)			Max. Limit (dBm)	Result
		Chain 1	Chain 2	Total		
38	5190 MHz	10.69	11.08	13.90	30.00	Complies
46	5230 MHz	14.12	13.72	16.93	30.00	Complies

**Configuration IEEE 802.11a 5 MHz**

Channel	Frequency	Conducted Power (dBm)			Max. Limit (dBm)	Result
		Chain 1	Chain 2	Total		
36	5180 MHz	13.98	14.02	17.01	30.00	Complies
42	5210 MHz	14.32	14.11	17.23	30.00	Complies
48	5240 MHz	14.08	14.03	17.07	30.00	Complies

**Configuration IEEE 802.11a 10 MHz**

Channel	Frequency	Conducted Power (dBm)			Max. Limit (dBm)	Result
		Chain 1	Chain 2	Total		
36	5180 MHz	13.82	13.96	16.90	30.00	Complies
42	5210 MHz	14.21	14.05	17.14	30.00	Complies
48	5240 MHz	13.09	13.22	16.17	30.00	Complies

**Configuration IEEE 802.11a 20 MHz**

Channel	Frequency	Conducted Power (dBm)			Max. Limit (dBm)	Result
		Chain 1	Chain 2	Total		
36	5180 MHz	14.26	14.16	17.22	30.00	Complies
40	5200 MHz	14.03	14.02	17.04	30.00	Complies
48	5240 MHz	14.28	14.01	17.16	30.00	Complies

Temperature	26°C	Humidity	63%
Test Engineer	Jim Huang	Configurations	IEEE 802.11n/a
Test Date	Aug. 21, 2014	Test Mode	Mode 1 / P to M

**Configuration IEEE 802.11n MCS0 5 MHz**

Channel	Frequency	Conducted Power (dBm)			Max. Limit (dBm)	Result
		Chain 1	Chain 2	Total		
36	5180 MHz	11.12	11.68	14.42	20.00	Complies
42	5210 MHz	11.25	11.45	14.36	20.00	Complies
48	5240 MHz	11.02	11.51	14.28	20.00	Complies

Note: Antenna Gain= 16dBi>6dBi,So B1 Power Limit=30-(16-6)=20dBm.

**Configuration IEEE 802.11n MCS0 10 MHz**

Channel	Frequency	Conducted Power (dBm)			Max. Limit (dBm)	Result
		Chain 1	Chain 2	Total		
36	5180 MHz	13.75	13.81	16.79	20.00	Complies
42	5210 MHz	14.12	14.09	17.12	20.00	Complies
48	5240 MHz	13.72	13.78	16.76	20.00	Complies

Note: Antenna Gain= 16dBi>6dBi,So B1 Power Limit=30-(16-6)=20dBm.

**Configuration IEEE 802.11n MCS0 20 MHz**

Channel	Frequency	Conducted Power (dBm)			Max. Limit (dBm)	Result
		Chain 1	Chain 2	Total		
36	5180 MHz	13.72	13.76	16.75	20.00	Complies
40	5200 MHz	14.12	14.03	17.09	20.00	Complies
48	5240 MHz	14.24	13.99	17.13	20.00	Complies

Note: Antenna Gain= 16dBi>6dBi,So B1 Power Limit=30-(16-6)=20dBm.

**Configuration IEEE 802.11n MCS0 40 MHz**

Channel	Frequency	Conducted Power (dBm)			Max. Limit (dBm)	Result
		Chain 1	Chain 2	Total		
38	5190 MHz	10.69	11.08	13.90	20.00	Complies
46	5230 MHz	14.12	13.72	16.93	20.00	Complies

Note: Antenna Gain= 16dBi>6dBi,So B1 Power Limit=30-(16-6)=20dBm.

**Configuration IEEE 802.11a 5 MHz**

Channel	Frequency	Conducted Power (dBm)			Max. Limit (dBm)	Result
		Chain 1	Chain 2	Total		
36	5180 MHz	11.25	11.49	14.38	20.00	Complies
42	5210 MHz	11.27	11.51	14.40	20.00	Complies
48	5240 MHz	11.24	11.53	14.40	20.00	Complies

Note: Antenna Gain = 16dBi > 6dBi, So B1 Power Limit = 30 - (16 - 6) = 20dBm.

**Configuration IEEE 802.11a 10 MHz**

Channel	Frequency	Conducted Power (dBm)			Max. Limit (dBm)	Result
		Chain 1	Chain 2	Total		
36	5180 MHz	13.82	13.96	16.90	20.00	Complies
42	5210 MHz	14.21	14.05	17.14	20.00	Complies
48	5240 MHz	13.34	13.45	16.41	20.00	Complies

Note: Antenna Gain = 16dBi > 6dBi, So B1 Power Limit = 30 - (16 - 6) = 20dBm.

**Configuration IEEE 802.11a 20 MHz**

Channel	Frequency	Conducted Power (dBm)			Max. Limit (dBm)	Result
		Chain 1	Chain 2	Total		
36	5180 MHz	14.26	14.16	17.22	20.00	Complies
40	5200 MHz	14.03	14.02	17.04	20.00	Complies
48	5240 MHz	14.28	14.01	17.16	20.00	Complies

Note: Antenna Gain = 16dBi > 6dBi, So B1 Power Limit = 30 - (16 - 6) = 20dBm.



Temperature	26°C	Humidity	63%
Test Engineer	Jim Huang	Configurations	IEEE 802.11n/a
Test Date	Aug. 21, 2014	Test Mode	Mode 2 / P to P

**Configuration IEEE 802.11n MCS0 5 MHz**

Channel	Frequency	Conducted Power (dBm)			Max. Limit (dBm)	Result
		Chain 1	Chain 2	Total		
36	5180 MHz	17.35	17.38	20.38	30.00	Complies
42	5210 MHz	17.06	17.46	20.27	30.00	Complies
48	5240 MHz	18.69	19.02	21.87	30.00	Complies

**Configuration IEEE 802.11n MCS0 10 MHz**

Channel	Frequency	Conducted Power (dBm)			Max. Limit (dBm)	Result
		Chain 1	Chain 2	Total		
36	5180 MHz	18.38	18.72	21.56	30.00	Complies
42	5210 MHz	17.63	18.09	20.88	30.00	Complies
48	5240 MHz	18.58	18.82	21.71	30.00	Complies

**Configuration IEEE 802.11n MCS0 20 MHz**

Channel	Frequency	Conducted Power (dBm)			Max. Limit (dBm)	Result
		Chain 1	Chain 2	Total		
36	5180 MHz	15.72	15.34	18.54	30.00	Complies
40	5200 MHz	18.87	18.91	21.90	30.00	Complies
48	5240 MHz	18.62	18.82	21.73	30.00	Complies

**Configuration IEEE 802.11n MCS0 40 MHz**

Channel	Frequency	Conducted Power (dBm)			Max. Limit (dBm)	Result
		Chain 1	Chain 2	Total		
38	5190 MHz	12.09	12.12	15.12	30.00	Complies
46	5230 MHz	17.81	18.18	21.01	30.00	Complies

**Configuration IEEE 802.11a 5 MHz**

Channel	Frequency	Conducted Power (dBm)			Max. Limit (dBm)	Result
		Chain 1	Chain 2	Total		
36	5180 MHz	17.81	17.79	20.81	30.00	Complies
42	5210 MHz	17.59	17.72	20.67	30.00	Complies
48	5240 MHz	18.12	18.54	21.35	30.00	Complies

**Configuration IEEE 802.11a 10 MHz**

Channel	Frequency	Conducted Power (dBm)			Max. Limit (dBm)	Result
		Chain 1	Chain 2	Total		
36	5180 MHz	18.48	18.81	21.66	30.00	Complies
42	5210 MHz	18.56	18.72	21.65	30.00	Complies
48	5240 MHz	18.42	18.83	21.64	30.00	Complies

**Configuration IEEE 802.11a 20 MHz**

Channel	Frequency	Conducted Power (dBm)			Max. Limit (dBm)	Result
		Chain 1	Chain 2	Total		
36	5180 MHz	16.28	15.92	19.11	30.00	Complies
40	5200 MHz	18.21	18.39	21.31	30.00	Complies
48	5240 MHz	18.65	18.78	21.73	30.00	Complies

Temperature	26°C	Humidity	63%
Test Engineer	Jim Huang	Configurations	IEEE 802.11n/a
Test Date	Aug. 21, 2014	Test Mode	Mode 2 / P to M

**Configuration IEEE 802.11n MCS0 5 MHz**

Channel	Frequency	Conducted Power (dBm)			Max. Limit (dBm)	Result
		Chain 1	Chain 2	Total		
36	5180 MHz	17.35	17.38	20.38	28.00	Complies
42	5210 MHz	17.06	17.46	20.27	28.00	Complies
48	5240 MHz	18.69	19.02	21.87	28.00	Complies

Note: Antenna Gain= 8dBi>6dBi,So B1 Power Limit=30-(8-6)=28dBm.

**Configuration IEEE 802.11n MCS0 10 MHz**

Channel	Frequency	Conducted Power (dBm)			Max. Limit (dBm)	Result
		Chain 1	Chain 2	Total		
36	5180 MHz	18.38	18.72	21.56	28.00	Complies
42	5210 MHz	17.63	18.09	20.88	28.00	Complies
48	5240 MHz	18.58	18.82	21.71	28.00	Complies

Note: Antenna Gain= 8dBi>6dBi,So B1 Power Limit=30-(8-6)=28dBm.

**Configuration IEEE 802.11n MCS0 20 MHz**

Channel	Frequency	Conducted Power (dBm)			Max. Limit (dBm)	Result
		Chain 1	Chain 2	Total		
36	5180 MHz	15.72	15.34	18.54	28.00	Complies
40	5200 MHz	18.87	18.91	21.90	28.00	Complies
48	5240 MHz	18.62	18.82	21.73	28.00	Complies

Note: Antenna Gain= 8dBi>6dBi,So B1 Power Limit=30-(8-6)=28dBm.

**Configuration IEEE 802.11n MCS0 40 MHz**

Channel	Frequency	Conducted Power (dBm)			Max. Limit (dBm)	Result
		Chain 1	Chain 2	Total		
38	5190 MHz	12.09	12.12	15.12	28.00	Complies
46	5230 MHz	17.81	18.18	21.01	28.00	Complies

Note: Antenna Gain= 8dBi>6dBi,So B1 Power Limit=30-(8-6)=28dBm.

**Configuration IEEE 802.11a 5 MHz**

Channel	Frequency	Conducted Power (dBm)			Max. Limit (dBm)	Result
		Chain 1	Chain 2	Total		
36	5180 MHz	17.81	17.79	20.81	28.00	Complies
42	5210 MHz	17.59	17.72	20.67	28.00	Complies
48	5240 MHz	18.12	18.54	21.35	28.00	Complies

Note: Antenna Gain = 8dBi > 6dBi, So B1 Power Limit =  $30 - (8 - 6) = 28$  dBm.

**Configuration IEEE 802.11a 10 MHz**

Channel	Frequency	Conducted Power (dBm)			Max. Limit (dBm)	Result
		Chain 1	Chain 2	Total		
36	5180 MHz	18.48	18.81	21.66	28.00	Complies
42	5210 MHz	18.56	18.72	21.65	28.00	Complies
48	5240 MHz	18.42	18.83	21.64	28.00	Complies

Note: Antenna Gain = 8dBi > 6dBi, So B1 Power Limit =  $30 - (8 - 6) = 28$  dBm.

**Configuration IEEE 802.11a 20 MHz**

Channel	Frequency	Conducted Power (dBm)			Max. Limit (dBm)	Result
		Chain 1	Chain 2	Total		
36	5180 MHz	16.28	15.92	19.11	28.00	Complies
40	5200 MHz	18.21	18.39	21.31	28.00	Complies
48	5240 MHz	18.65	18.78	21.73	28.00	Complies

Note: Antenna Gain = 8dBi > 6dBi, So B1 Power Limit =  $30 - (8 - 6) = 28$  dBm.

Temperature	26°C	Humidity	63%
Test Engineer	Jim Huang	Configurations	IEEE 802.11n/a
Test Date	Aug. 21, 2014	Test Mode	Mode 3 / P to M

**Configuration IEEE 802.11n MCS0 5 MHz**

Channel	Frequency	Conducted Power (dBm)			Max. Limit (dBm)	Result
		Chain 1	Chain 2	Total		
36	5180 MHz	16.52	15.93	19.25	28.00	Complies
42	5210 MHz	16.28	16.32	19.31	28.00	Complies
48	5240 MHz	16.22	16.16	19.20	28.00	Complies

Note: Antenna Gain= 8dBi>6dBi,So B1 Power Limit=30-(8-6)=28dBm.

**Configuration IEEE 802.11n MCS0 10 MHz**

Channel	Frequency	Conducted Power (dBm)			Max. Limit (dBm)	Result
		Chain 1	Chain 2	Total		
36	5180 MHz	19.11	19.32	22.23	28.00	Complies
42	5210 MHz	16.81	17.09	19.96	28.00	Complies
48	5240 MHz	19.08	19.23	22.17	28.00	Complies

Note: Antenna Gain= 8dBi>6dBi,So B1 Power Limit=30-(8-6)=28dBm.

**Configuration IEEE 802.11n MCS0 20 MHz**

Channel	Frequency	Conducted Power (dBm)			Max. Limit (dBm)	Result
		Chain 1	Chain 2	Total		
36	5180 MHz	16.16	15.71	18.95	28.00	Complies
40	5200 MHz	18.87	18.91	21.90	28.00	Complies
48	5240 MHz	19.72	20.08	22.91	28.00	Complies

Note: Antenna Gain= 8dBi>6dBi,So B1 Power Limit=30-(8-6)=28dBm.

**Configuration IEEE 802.11n MCS0 40 MHz**

Channel	Frequency	Conducted Power (dBm)			Max. Limit (dBm)	Result
		Chain 1	Chain 2	Total		
38	5190 MHz	12.78	12.73	15.77	28.00	Complies
46	5230 MHz	18.39	18.52	21.47	28.00	Complies

Note: Antenna Gain= 8dBi>6dBi,So B1 Power Limit=30-(8-6)=28dBm.

**Configuration IEEE 802.11a 5 MHz**

Channel	Frequency	Conducted Power (dBm)			Max. Limit (dBm)	Result
		Chain 1	Chain 2	Total		
36	5180 MHz	16.38	16.25	19.33	28.00	Complies
42	5210 MHz	16.31	16.21	19.27	28.00	Complies
48	5240 MHz	16.23	16.16	19.21	28.00	Complies

Note: Antenna Gain = 8dBi > 6dBi, So B1 Power Limit =  $30 - (8 - 6) = 28$  dBm.

**Configuration IEEE 802.11a 10 MHz**

Channel	Frequency	Conducted Power (dBm)			Max. Limit (dBm)	Result
		Chain 1	Chain 2	Total		
36	5180 MHz	18.48	18.81	21.66	28.00	Complies
42	5210 MHz	17.24	17.85	20.57	28.00	Complies
48	5240 MHz	18.05	18.52	21.30	28.00	Complies

Note: Antenna Gain = 8dBi > 6dBi, So B1 Power Limit =  $30 - (8 - 6) = 28$  dBm.

**Configuration IEEE 802.11a 20 MHz**

Channel	Frequency	Conducted Power (dBm)			Max. Limit (dBm)	Result
		Chain 1	Chain 2	Total		
36	5180 MHz	18.02	18.13	21.09	28.00	Complies
40	5200 MHz	17.82	18.09	20.97	28.00	Complies
48	5240 MHz	19.79	20.09	22.95	28.00	Complies

Note: Antenna Gain = 8dBi > 6dBi, So B1 Power Limit =  $30 - (8 - 6) = 28$  dBm.

Note: Maximum e.i.r.p. at any elevation angle above 30 degrees data (please refer to Appendix C).

### 4.3. Power Spectral Density Measurement

#### 4.3.1. Limit

The power spectral density is defined as the highest level of power in dBm per MHz generated by the transmitter within the power envelope. The following table is power spectral density limits and decrease power density limit rule refer to section 4.2.1.

Frequency Range	Power Spectral Density limit (dBm/MHz)
5.15~5.25 GHz	17

#### 4.3.2. Measuring Instruments and Setting

Please refer to section 5 of equipments list in this report. The following table is the setting of the spectrum analyzer.

For 5.15-5.25 GHz

Spectrum Parameter	Setting
Attenuation	Auto
Span Frequency	Encompass the entire emissions bandwidth (EBW) of the signal
RBW	1000 kHz
VBW	3000 kHz
Detector	RMS
Trace	AVERAGE
Sweep Time	Auto
Trace Average	100 times

#### 4.3.3. Test Procedures

For 5.15-5.25 GHz / 5.470-5.725 GHz

1. The transmitter output (antenna port) was connected RF switch to the spectrum analyzer.
2. Test was performed in accordance with KDB789033 D02 v01 for Compliance Testing of Unlicensed National Information Infrastructure (U-NII) Devices - section (F) Maximum Power Spectral Density (PSD).
3. Multiple antenna systems was performed in accordance KDB662911 D01 v02r01 in-Band Power Spectral Density (PSD) Measurements (a) Measure and sum the spectra across the outputs.
4. When measuring first spectral bin of output 1 is summed with that in the first spectral bin of output 2 and that from the first spectral bin of output 3 and so on up to the Nth output to obtain the value for the first frequency bin of the summed spectrum. The summed spectrum value for each of the other frequency bins is computed in the same way.

#### 4.3.4. Test Setup Layout

For 5.15-5.25 GHz

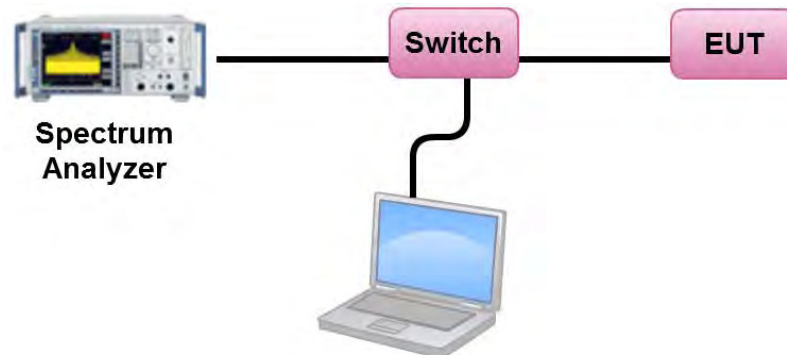

#### 4.3.5. Test Deviation

There is no deviation with the original standard.

#### 4.3.6. EUT Operation during Test

The EUT was programmed to be in continuously transmitting mode.



#### 4.3.7. Test Result of Power Spectral Density

Temperature	26°C	Humidity	63%
Test Engineer	Jim Huang	Configurations	IEEE 802.11n/a
Test Date	Aug. 21, 2014	Test Mode	Mode 1 / P to P

##### Configuration IEEE 802.11n MCS0 5 MHz / Chain 1 + Chain 2

Channel	Frequency	Total Power Density (dBm/MHz)	Max. Limit (dBm/MHz)	Result
36	5180 MHz	9.35	17.00	Complies
42	5210 MHz	9.77	17.00	Complies
48	5240 MHz	9.37	17.00	Complies

##### Configuration IEEE 802.11n MCS0 10 MHz / Chain 1 + Chain 2

Channel	Frequency	Total Power Density (dBm/MHz)	Max. Limit (dBm/MHz)	Result
36	5180 MHz	6.32	17.00	Complies
42	5210 MHz	6.88	17.00	Complies
48	5240 MHz	6.41	17.00	Complies

##### Configuration IEEE 802.11n MCS0 20 MHz / Chain 1 + Chain 2

Channel	Frequency	Total Power Density (dBm/MHz)	Max. Limit (dBm/MHz)	Result
36	5180 MHz	3.23	17.00	Complies
40	5200 MHz	3.65	17.00	Complies
48	5240 MHz	3.60	17.00	Complies

##### Configuration IEEE 802.11n MCS0 40 MHz / Chain 1 + Chain 2

Channel	Frequency	Total Power Density (dBm/MHz)	Max. Limit (dBm/MHz)	Result
38	5190 MHz	-2.48	17.00	Complies
46	5230 MHz	0.52	17.00	Complies

**Configuration IEEE 802.11a 5 MHz / Chain 1 + Chain 2**

Channel	Frequency	Total Power Density (dBm/MHz)	Max. Limit (dBm/MHz)	Result
36	5180 MHz	9.39	17.00	Complies
42	5210 MHz	9.85	17.00	Complies
48	5240 MHz	9.80	17.00	Complies

**Configuration IEEE 802.11a 10 MHz / Chain 1 + Chain 2**

Channel	Frequency	Total Power Density (dBm/MHz)	Max. Limit (dBm/MHz)	Result
36	5180 MHz	6.49	17.00	Complies
42	5210 MHz	6.86	17.00	Complies
48	5240 MHz	5.87	17.00	Complies

**Configuration IEEE 802.11a 20 MHz / Chain 1 + Chain 2**

Channel	Frequency	Total Power Density (dBm/MHz)	Max. Limit (dBm/MHz)	Result
36	5180 MHz	3.66	17.00	Complies
40	5200 MHz	3.87	17.00	Complies
48	5240 MHz	3.67	17.00	Complies

Temperature	26°C	Humidity	63%
Test Engineer	Jim Huang	Configurations	IEEE 802.11n/a
Test Date	Aug. 21, 2014	Test Mode	Mode 1 / P to M

**Configuration IEEE 802.11n MCS0 5 MHz / Chain 1 + Chain 2**

Channel	Frequency	Total Power Density (dBm/MHz)	Max. Limit (dBm/MHz)	Result
36	5180 MHz	6.81	7.00	Complies
42	5210 MHz	6.95	7.00	Complies
48	5240 MHz	6.90	7.00	Complies

Note:  $DirectionalGain = 10 \cdot \log \left[ \frac{\sum_{f=1}^N \left\{ \sum_{j=1}^M g_{j,k} \right\}^2}{N_{ANT}} \right] = 16 \text{dBi} > 6 \text{dBi}$ , So Band1 Limit =  $17 - (16 - 6) = 7 \text{dBm/MHz}$ .

**Configuration IEEE 802.11n MCS0 10 MHz / Chain 1 + Chain 2**

Channel	Frequency	Total Power Density (dBm/MHz)	Max. Limit (dBm/MHz)	Result
36	5180 MHz	6.32	7.00	Complies
42	5210 MHz	6.88	7.00	Complies
48	5240 MHz	6.41	7.00	Complies

Note:  $DirectionalGain = 10 \cdot \log \left[ \frac{\sum_{f=1}^N \left\{ \sum_{j=1}^M g_{j,k} \right\}^2}{N_{ANT}} \right] = 16 \text{dBi} > 6 \text{dBi}$ , So Band1 Limit =  $17 - (16 - 6) = 7 \text{dBm/MHz}$ .

**Configuration IEEE 802.11n MCS0 20 MHz / Chain 1 + Chain 2**

Channel	Frequency	Total Power Density (dBm/MHz)	Max. Limit (dBm/MHz)	Result
36	5180 MHz	3.23	7.00	Complies
40	5200 MHz	3.65	7.00	Complies
48	5240 MHz	3.60	7.00	Complies

Note:  $DirectionalGain = 10 \cdot \log \left[ \frac{\sum_{f=1}^N \left\{ \sum_{j=1}^M g_{j,k} \right\}^2}{N_{ANT}} \right] = 16 \text{dBi} > 6 \text{dBi}$ , So Band1 Limit =  $17 - (16 - 6) = 7 \text{dBm/MHz}$ .

**Configuration IEEE 802.11n MCS0 40 MHz / Chain 1 + Chain 2**

Channel	Frequency	Total Power Density (dBm/MHz)	Max. Limit (dBm/MHz)	Result
38	5190 MHz	-2.48	7.00	Complies
46	5230 MHz	0.52	7.00	Complies

Note:  $DirectionalGain = 10 \cdot \log \left[ \frac{\sum_{f=1}^N \left\{ \sum_{j=1}^M g_{j,k} \right\}^2}{N_{ANT}} \right] = 16 \text{dBi} > 6 \text{dBi}$ , So Band1 Limit =  $17 - (16 - 6) = 7 \text{dBm/MHz}$ .

**Configuration IEEE 802.11a 5 MHz / Chain 1 + Chain 2**

Channel	Frequency	Total Power Density (dBm/MHz)	Max. Limit (dBm/MHz)	Result
36	5180 MHz	6.79	7.00	Complies
42	5210 MHz	6.83	7.00	Complies
48	5240 MHz	6.89	7.00	Complies

Note:  $DirectionalGain = 10 \cdot \log \left[ \frac{\sum_{j=1}^{N_{ANT}} \left\{ \sum_{i=1}^{N_{CH}} S_{j,i} \right\}^2}{N_{ANT}} \right] = 16 \text{dBi} > 6 \text{dBi}$ , So Band1 Limit =  $17 - (16 - 6) = 7 \text{dBm/MHz}$ .

**Configuration IEEE 802.11a 10 MHz / Chain 1 + Chain 2**

Channel	Frequency	Total Power Density (dBm/MHz)	Max. Limit (dBm/MHz)	Result
36	5180 MHz	6.49	7.00	Complies
42	5210 MHz	6.86	7.00	Complies
48	5240 MHz	5.87	7.00	Complies

Note:  $DirectionalGain = 10 \cdot \log \left[ \frac{\sum_{j=1}^{N_{ANT}} \left\{ \sum_{i=1}^{N_{CH}} S_{j,i} \right\}^2}{N_{ANT}} \right] = 16 \text{dBi} > 6 \text{dBi}$ , So Band1 Limit =  $17 - (16 - 6) = 7 \text{dBm/MHz}$ .

**Configuration IEEE 802.11a 20 MHz / Chain 1 + Chain 2**

Channel	Frequency	Total Power Density (dBm/MHz)	Max. Limit (dBm/MHz)	Result
36	5180 MHz	3.66	7.00	Complies
40	5200 MHz	3.87	7.00	Complies
48	5240 MHz	3.67	7.00	Complies

Note:  $DirectionalGain = 10 \cdot \log \left[ \frac{\sum_{j=1}^{N_{ANT}} \left\{ \sum_{i=1}^{N_{CH}} S_{j,i} \right\}^2}{N_{ANT}} \right] = 16 \text{dBi} > 6 \text{dBi}$ , So Band1 Limit =  $17 - (16 - 6) = 7 \text{dBm/MHz}$ .

<b>Temperature</b>	26°C	<b>Humidity</b>	63%
<b>Test Engineer</b>	Jim Huang	<b>Configurations</b>	IEEE 802.11n/a
<b>Test Date</b>	Aug. 21, 2014	<b>Test Mode</b>	Mode 2 / P to P

**Configuration IEEE 802.11n MCS0 5 MHz / Chain 1 + Chain 2**

Channel	Frequency	Total Power Density (dBm/MHz)	Max. Limit (dBm/MHz)	Result
36	5180 MHz	12.91	17.00	Complies
42	5210 MHz	13.01	17.00	Complies
48	5240 MHz	14.45	17.00	Complies

**Configuration IEEE 802.11n MCS0 10 MHz / Chain 1 + Chain 2**

Channel	Frequency	Total Power Density (dBm/MHz)	Max. Limit (dBm/MHz)	Result
36	5180 MHz	11.10	17.00	Complies
42	5210 MHz	10.34	17.00	Complies
48	5240 MHz	11.30	17.00	Complies

**Configuration IEEE 802.11n MCS0 20 MHz / Chain 1 + Chain 2**

Channel	Frequency	Total Power Density (dBm/MHz)	Max. Limit (dBm/MHz)	Result
36	5180 MHz	5.29	17.00	Complies
40	5200 MHz	8.33	17.00	Complies
48	5240 MHz	8.16	17.00	Complies

**Configuration IEEE 802.11n MCS0 40 MHz / Chain 1 + Chain 2**

Channel	Frequency	Total Power Density (dBm/MHz)	Max. Limit (dBm/MHz)	Result
38	5190 MHz	-1.33	17.00	Complies
46	5230 MHz	4.60	17.00	Complies

**Configuration IEEE 802.11a 5 MHz / Chain 1 + Chain 2**

Channel	Frequency	Total Power Density (dBm/MHz)	Max. Limit (dBm/MHz)	Result
36	5180 MHz	13.27	17.00	Complies
42	5210 MHz	13.02	17.00	Complies
48	5240 MHz	14.04	17.00	Complies

**Configuration IEEE 802.11a 10 MHz / Chain 1 + Chain 2**

Channel	Frequency	Total Power Density (dBm/MHz)	Max. Limit (dBm/MHz)	Result
36	5180 MHz	11.21	17.00	Complies
42	5210 MHz	11.48	17.00	Complies
48	5240 MHz	10.97	17.00	Complies

**Configuration IEEE 802.11a 20 MHz / Chain 1 + Chain 2**

Channel	Frequency	Total Power Density (dBm/MHz)	Max. Limit (dBm/MHz)	Result
36	5180 MHz	5.91	17.00	Complies
40	5200 MHz	7.72	17.00	Complies
48	5240 MHz	8.16	17.00	Complies

Temperature	26°C	Humidity	63%
Test Engineer	Jim Huang	Configurations	IEEE 802.11n/a
Test Date	Aug. 21, 2014	Test Mode	Mode 2 / P to M

**Configuration IEEE 802.11n MCS0 5 MHz / Chain 1 + Chain 2**

Channel	Frequency	Total Power Density (dBm/MHz)	Max. Limit (dBm/MHz)	Result
36	5180 MHz	12.91	15.00	Complies
42	5210 MHz	13.01	15.00	Complies
48	5240 MHz	14.45	15.00	Complies

Note:  $DirectionalGain = 10 \cdot \log \left[ \frac{\sum_{f=1}^N \left\{ \sum_{j=1}^M S_{j,k} \right\}^2}{N_{ANT}} \right] = 8\text{dBi} > 6\text{dBi}$ , So Band1 Limit = 17 - (8 - 6) = 15 dBm/MHz.

**Configuration IEEE 802.11n MCS0 10 MHz / Chain 1 + Chain 2**

Channel	Frequency	Total Power Density (dBm/MHz)	Max. Limit (dBm/MHz)	Result
36	5180 MHz	11.10	15.00	Complies
42	5210 MHz	10.34	15.00	Complies
48	5240 MHz	11.30	15.00	Complies

Note:  $DirectionalGain = 10 \cdot \log \left[ \frac{\sum_{f=1}^N \left\{ \sum_{j=1}^M S_{j,k} \right\}^2}{N_{ANT}} \right] = 8\text{dBi} > 6\text{dBi}$ , So Band1 Limit = 17 - (8 - 6) = 15 dBm/MHz.

**Configuration IEEE 802.11n MCS0 20 MHz / Chain 1 + Chain 2**

Channel	Frequency	Total Power Density (dBm/MHz)	Max. Limit (dBm/MHz)	Result
36	5180 MHz	5.29	15.00	Complies
40	5200 MHz	8.33	15.00	Complies
48	5240 MHz	8.16	15.00	Complies

Note:  $DirectionalGain = 10 \cdot \log \left[ \frac{\sum_{f=1}^N \left\{ \sum_{j=1}^M S_{j,k} \right\}^2}{N_{ANT}} \right] = 8\text{dBi} > 6\text{dBi}$ , So Band1 Limit = 17 - (8 - 6) = 15 dBm/MHz.

**Configuration IEEE 802.11n MCS0 40 MHz / Chain 1 + Chain 2**

Channel	Frequency	Total Power Density (dBm/MHz)	Max. Limit (dBm/MHz)	Result
38	5190 MHz	-1.33	15.00	Complies
46	5230 MHz	4.60	15.00	Complies

Note:  $DirectionalGain = 10 \cdot \log \left[ \frac{\sum_{f=1}^N \left\{ \sum_{j=1}^M S_{j,k} \right\}^2}{N_{ANT}} \right] = 8\text{dBi} > 6\text{dBi}$ , So Band1 Limit = 17 - (8 - 6) = 15 dBm/MHz.

**Configuration IEEE 802.11a 5 MHz / Chain 1 + Chain 2**

Channel	Frequency	Total Power Density (dBm/MHz)	Max. Limit (dBm/MHz)	Result
36	5180 MHz	13.27	15.00	Complies
42	5210 MHz	13.02	15.00	Complies
48	5240 MHz	14.04	15.00	Complies

Note:  $DirectionalGain = 10 \cdot \log \left[ \frac{\sum_{j=1}^{N_{ANT}} \left\{ \sum_{i=1}^{N_{CH}} S_{j,i} \right\}^2}{N_{ANT}} \right] = 8\text{dBi} > 6\text{dBi}$ , So Band1 Limit = 17-(8-6) = 15dBm/MHz.

**Configuration IEEE 802.11a 10 MHz / Chain 1 + Chain 2**

Channel	Frequency	Total Power Density (dBm/MHz)	Max. Limit (dBm/MHz)	Result
36	5180 MHz	11.21	15.00	Complies
42	5210 MHz	11.48	15.00	Complies
48	5240 MHz	10.97	15.00	Complies

Note:  $DirectionalGain = 10 \cdot \log \left[ \frac{\sum_{j=1}^{N_{ANT}} \left\{ \sum_{i=1}^{N_{CH}} S_{j,i} \right\}^2}{N_{ANT}} \right] = 8\text{dBi} > 6\text{dBi}$ , So Band1 Limit = 17-(8-6) = 15dBm/MHz.

**Configuration IEEE 802.11a 20 MHz / Chain 1 + Chain 2**

Channel	Frequency	Total Power Density (dBm/MHz)	Max. Limit (dBm/MHz)	Result
36	5180 MHz	5.91	15.00	Complies
40	5200 MHz	7.72	15.00	Complies
48	5240 MHz	8.16	15.00	Complies

Note:  $DirectionalGain = 10 \cdot \log \left[ \frac{\sum_{j=1}^{N_{ANT}} \left\{ \sum_{i=1}^{N_{CH}} S_{j,i} \right\}^2}{N_{ANT}} \right] = 8\text{dBi} > 6\text{dBi}$ , So Band1 Limit = 17-(8-6) = 15dBm/MHz.



Temperature	26°C	Humidity	63%
Test Engineer	Jim Huang	Configurations	IEEE 802.11n/a
Test Date	Aug. 21, 2014	Test Mode	Mode 3 / P to M

**Configuration IEEE 802.11n MCS0 5 MHz / Chain 1 + Chain 2**

Channel	Frequency	Total Power Density (dBm/MHz)	Max. Limit (dBm/MHz)	Result
36	5180 MHz	11.77	11.99	Complies
42	5210 MHz	11.88	11.99	Complies
48	5240 MHz	11.97	11.99	Complies

Note:  $^{1}DirectionalGain = 10 \cdot \log \left[ \frac{\sum_{f=1}^N \left\{ \sum_{k=1}^{N_{ANT}} S_{f,k} \right\}^2}{N_{ANT}} \right] = 11.01 \text{ dBi} > 6 \text{ dBi}$ , So Band1 Limit =  $17 - (11.01 - 6) = 11.99 \text{ dBm/MHz}$

**Configuration IEEE 802.11n MCS0 10 MHz / Chain 1 + Chain 2**

Channel	Frequency	Total Power Density (dBm/MHz)	Max. Limit (dBm/MHz)	Result
36	5180 MHz	11.69	11.99	Complies
42	5210 MHz	9.63	11.99	Complies
48	5240 MHz	11.68	11.99	Complies

Note:  $^{1}DirectionalGain = 10 \cdot \log \left[ \frac{\sum_{f=1}^N \left\{ \sum_{k=1}^{N_{ANT}} S_{f,k} \right\}^2}{N_{ANT}} \right] = 11.01 \text{ dBi} > 6 \text{ dBi}$ , So Band1 Limit =  $17 - (11.01 - 6) = 11.99 \text{ dBm/MHz}$

**Configuration IEEE 802.11n MCS0 20 MHz / Chain 1 + Chain 2**

Channel	Frequency	Total Power Density (dBm/MHz)	Max. Limit (dBm/MHz)	Result
36	5180 MHz	5.61	11.99	Complies
40	5200 MHz	8.33	11.99	Complies
48	5240 MHz	9.40	11.99	Complies

Note:  $^{1}DirectionalGain = 10 \cdot \log \left[ \frac{\sum_{f=1}^N \left\{ \sum_{k=1}^{N_{ANT}} S_{f,k} \right\}^2}{N_{ANT}} \right] = 11.01 \text{ dBi} > 6 \text{ dBi}$ , So Band1 Limit =  $17 - (11.01 - 6) = 11.99 \text{ dBm/MHz}$

**Configuration IEEE 802.11n MCS0 40 MHz / Chain 1 + Chain 2**

Channel	Frequency	Total Power Density (dBm/MHz)	Max. Limit (dBm/MHz)	Result
38	5190 MHz	-0.87	11.99	Complies
46	5230 MHz	5.00	11.99	Complies

Note:  $^{1}DirectionalGain = 10 \cdot \log \left[ \frac{\sum_{f=1}^N \left\{ \sum_{k=1}^{N_{ANT}} S_{f,k} \right\}^2}{N_{ANT}} \right] = 11.01 \text{ dBi} > 6 \text{ dBi}$ , So Band1 Limit =  $17 - (11.01 - 6) = 11.99 \text{ dBm/MHz}$

**Configuration IEEE 802.11a 5 MHz / Chain 1 + Chain 2**

Channel	Frequency	Total Power Density (dBm/MHz)	Max. Limit (dBm/MHz)	Result
36	5180 MHz	11.87	11.99	Complies
42	5210 MHz	11.95	11.99	Complies
48	5240 MHz	11.74	11.99	Complies

Note:  $DirectionalGain = 10 \cdot \log \left[ \frac{\sum_{f=1}^{N_{ANT}} \left\{ \sum_{k=1}^{N_{CH}} S_{f,k} \right\}^2}{N_{ANT}} \right] = 11.01 \text{ dBi} > 6 \text{ dBi}$ , So Band1 Limit = 17 - (11.01 - 6) = 11.99 dBm/MHz

**Configuration IEEE 802.11a 10 MHz / Chain 1 + Chain 2**

Channel	Frequency	Total Power Density (dBm/MHz)	Max. Limit (dBm/MHz)	Result
36	5180 MHz	11.21	11.99	Complies
42	5210 MHz	9.94	11.99	Complies
48	5240 MHz	10.77	11.99	Complies

Note:  $DirectionalGain = 10 \cdot \log \left[ \frac{\sum_{f=1}^{N_{ANT}} \left\{ \sum_{k=1}^{N_{CH}} S_{f,k} \right\}^2}{N_{ANT}} \right] = 11.01 \text{ dBi} > 6 \text{ dBi}$ , So Band1 Limit = 17 - (11.01 - 6) = 11.99 dBm/MHz

**Configuration IEEE 802.11a 20 MHz / Chain 1 + Chain 2**

Channel	Frequency	Total Power Density (dBm/MHz)	Max. Limit (dBm/MHz)	Result
36	5180 MHz	7.56	11.99	Complies
40	5200 MHz	7.41	11.99	Complies
48	5240 MHz	9.81	11.99	Complies

Note:  $DirectionalGain = 10 \cdot \log \left[ \frac{\sum_{f=1}^{N_{ANT}} \left\{ \sum_{k=1}^{N_{CH}} S_{f,k} \right\}^2}{N_{ANT}} \right] = 11.01 \text{ dBi} > 6 \text{ dBi}$ , So Band1 Limit = 17 - (11.01 - 6) = 11.99 dBm/MHz

Note: All the test values were listed in the report.

For plots, only the channel with worse result was shown.

## Test Mode 1 / P to P

## Power Density Plot on Configuration IEEE 802.11n MCS0 5 MHz / Chain 1 + Chain 2 / 5210 MHz

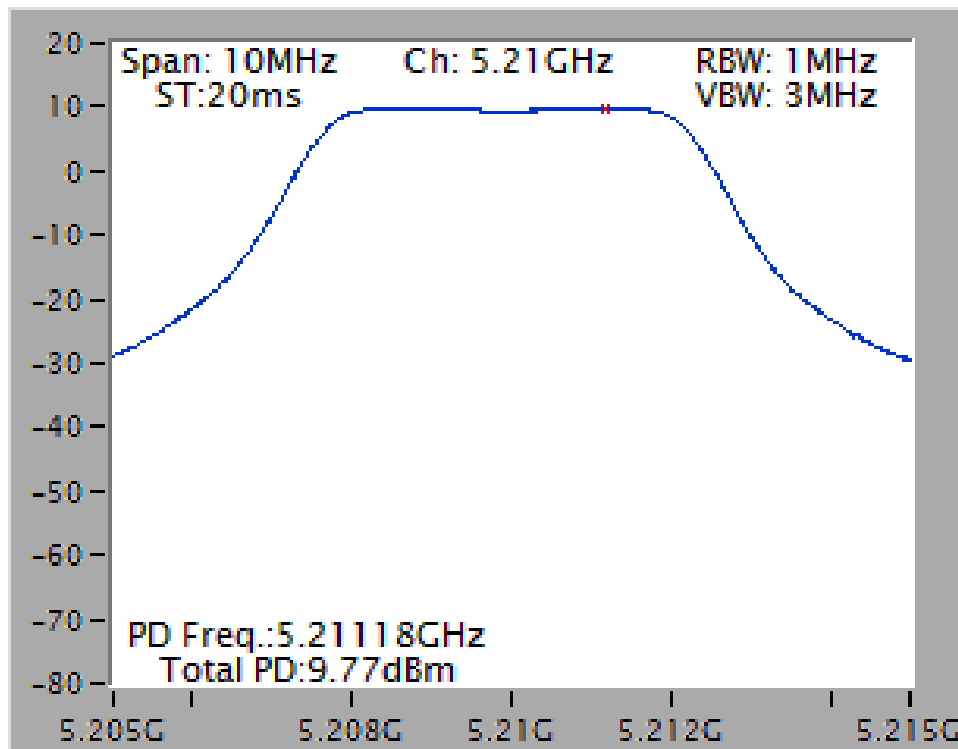

## Power Density Plot on Configuration IEEE 802.11n MCS0 10 MHz / Chain 1 + Chain 2 / 5210 MHz

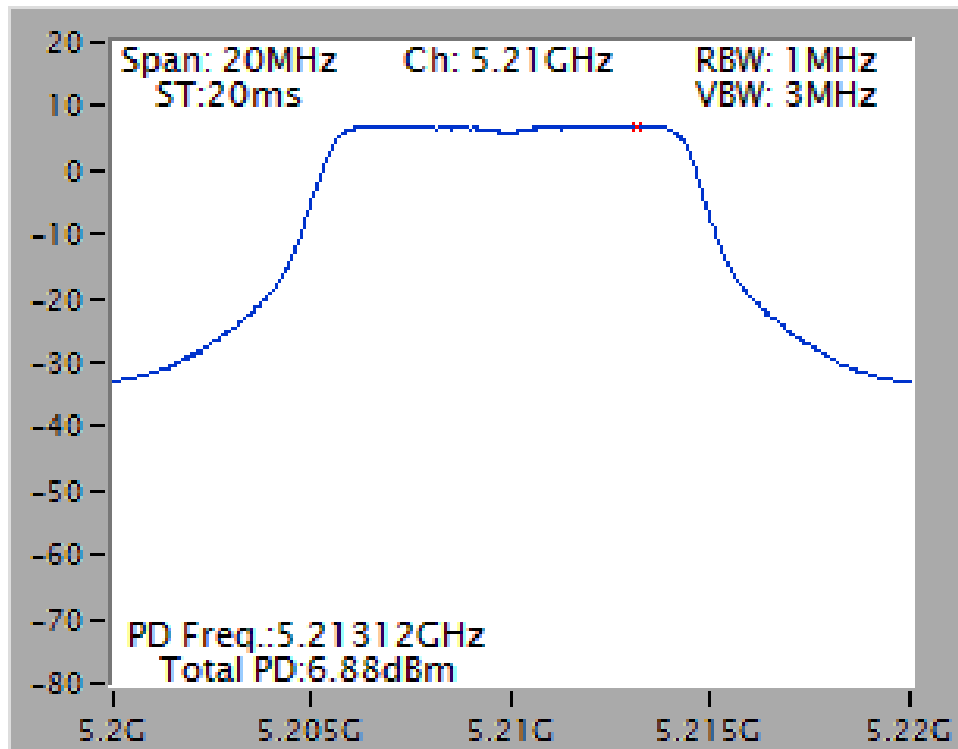

Power Density Plot on Configuration IEEE 802.11n MCS0 20 MHz / Chain 1 + Chain 2 / 5200 MHz

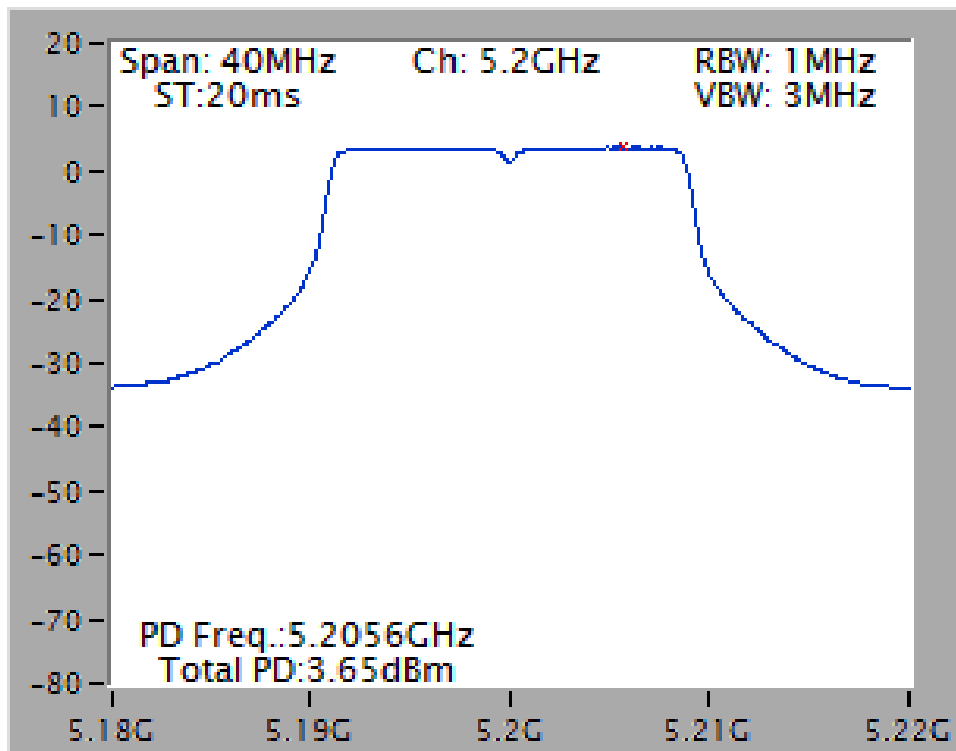

Power Density Plot on Configuration IEEE 802.11n MCS0 40 MHz / Chain 1 + Chain 2 / 5230 MHz

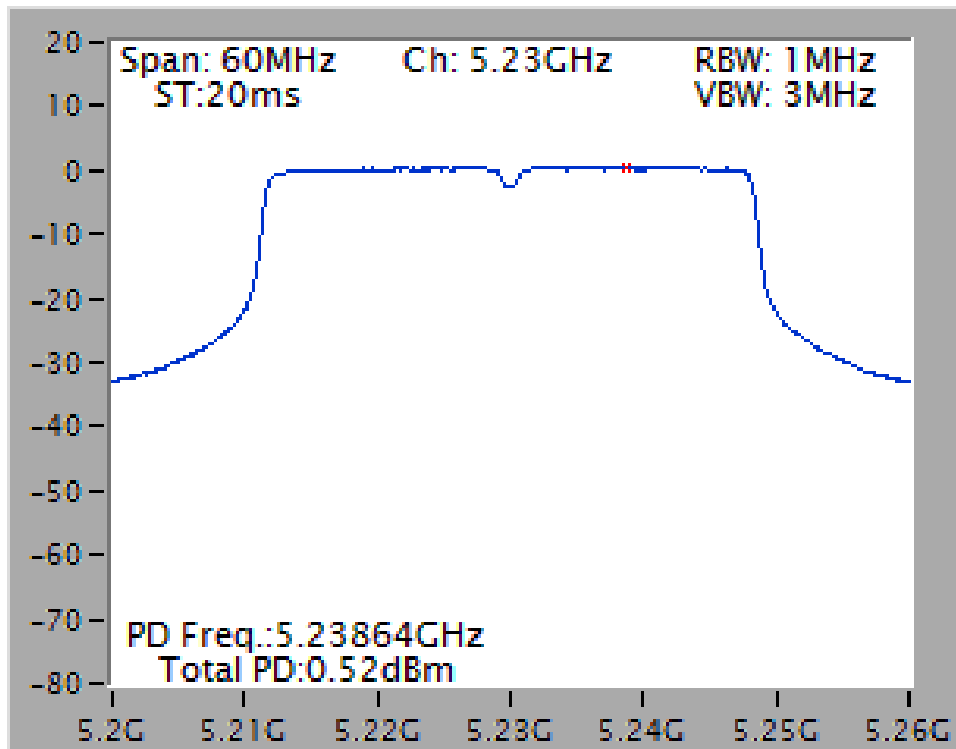

Power Density Plot on Configuration IEEE 802.11a 5 MHz / Chain 1 + Chain 2 / 5210 MHz

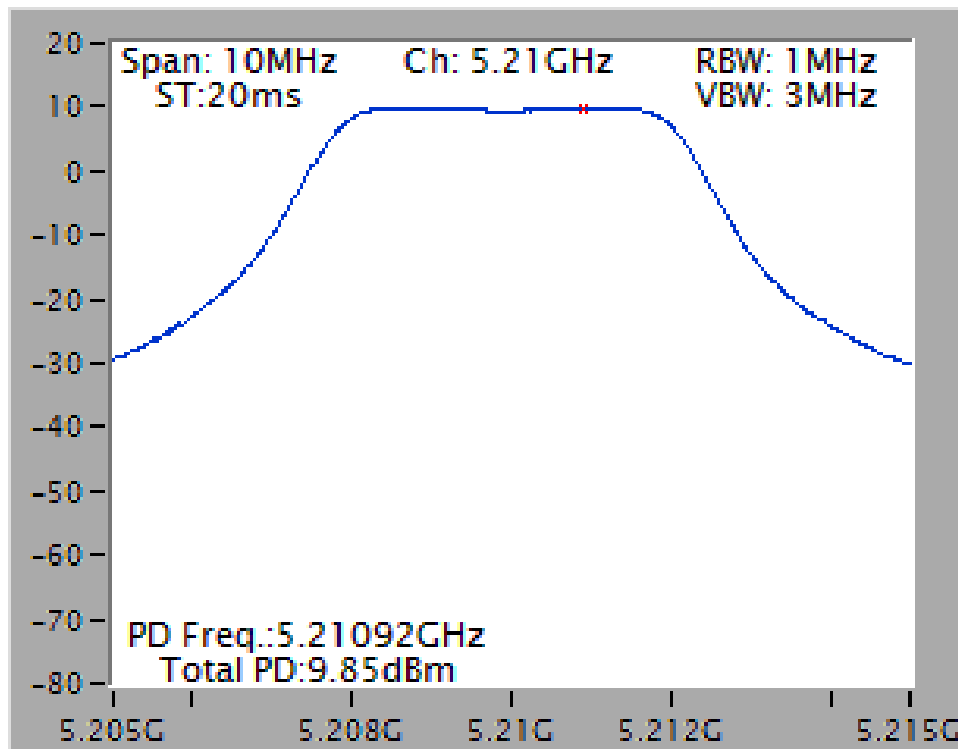

Power Density Plot on Configuration IEEE 802.11a 10 MHz / Chain 1 + Chain 2 / 5210 MHz

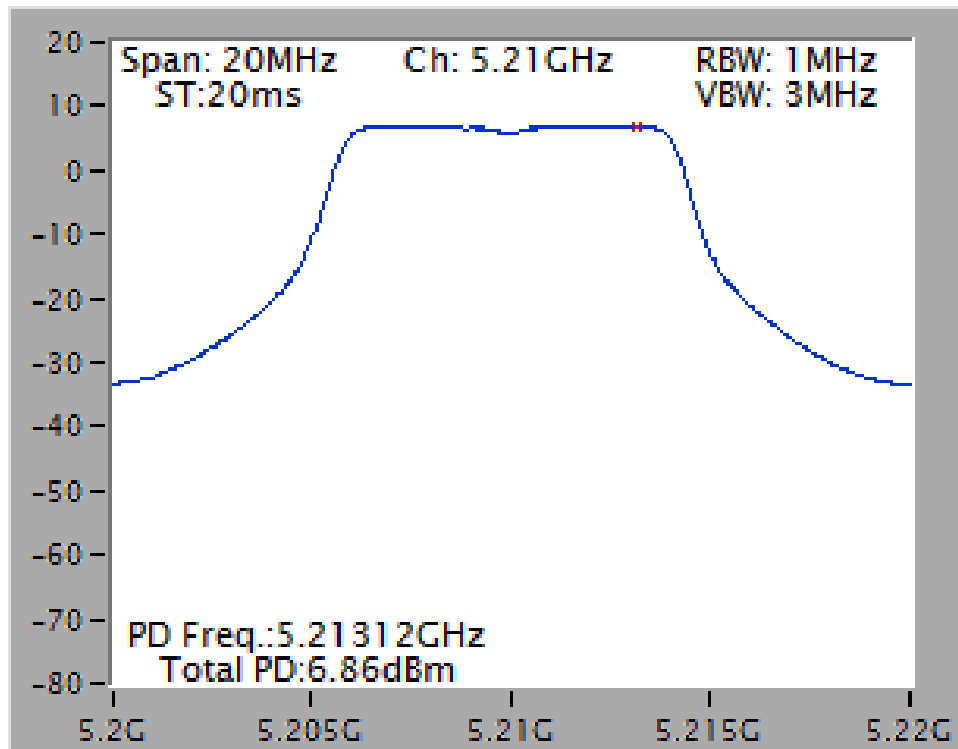

Power Density Plot on Configuration IEEE 802.11a 20 MHz / Chain 1 + Chain 2 / 5200 MHz

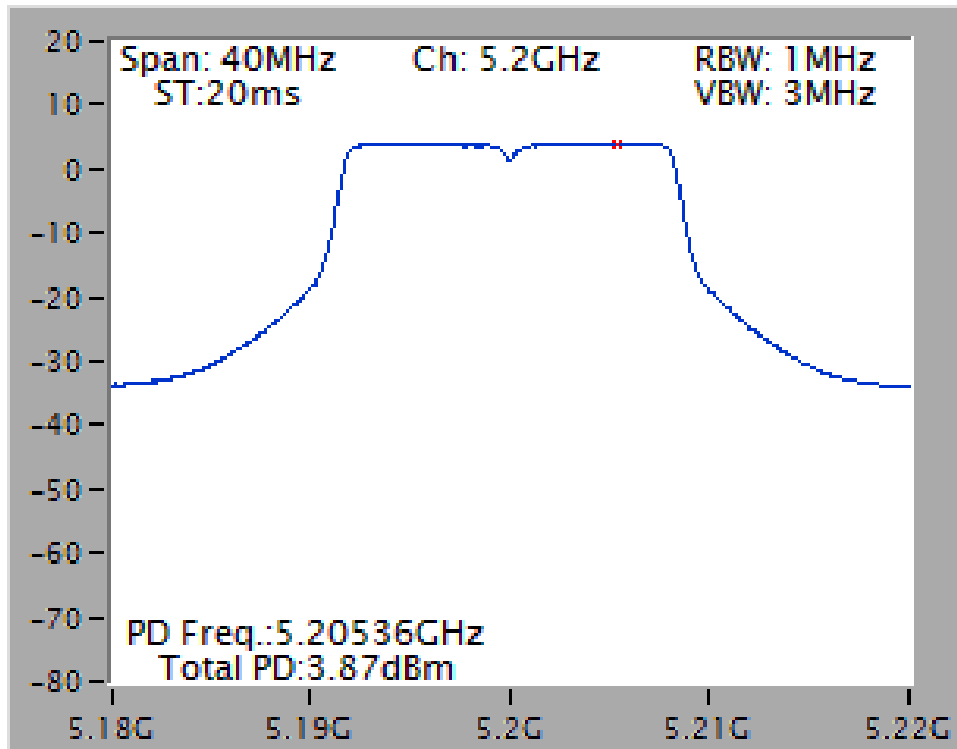

## Test Mode 1 / P to M

## Power Density Plot on Configuration IEEE 802.11n MCS0 5 MHz / Chain 1 + Chain 2 / 5210 MHz

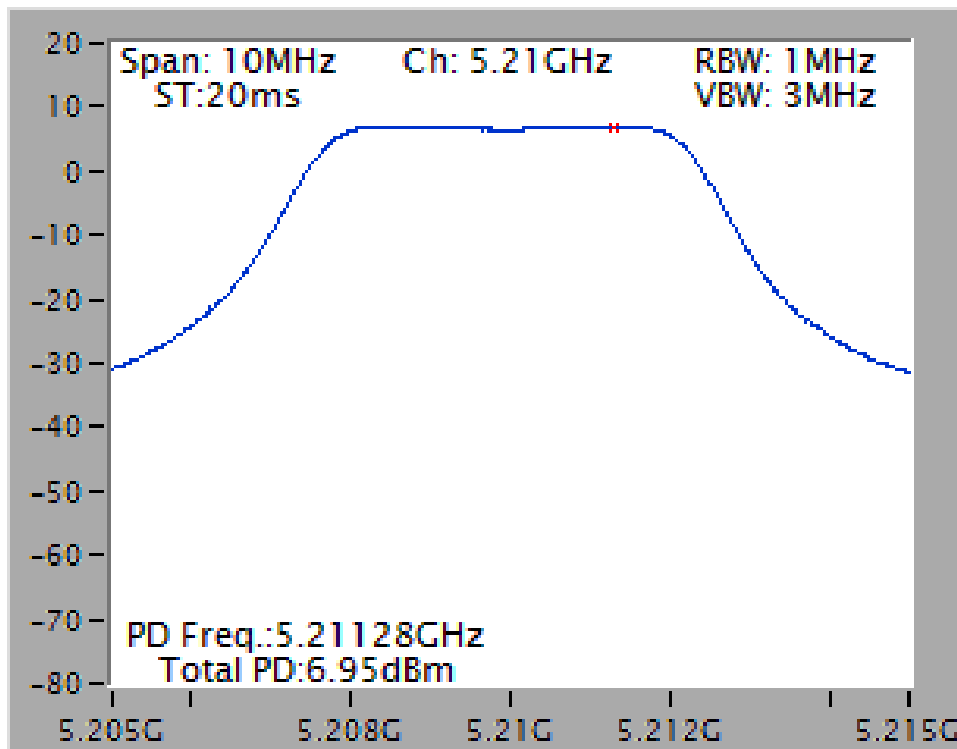

## Power Density Plot on Configuration IEEE 802.11n MCS0 10 MHz / Chain 1 + Chain 2 / 5210 MHz

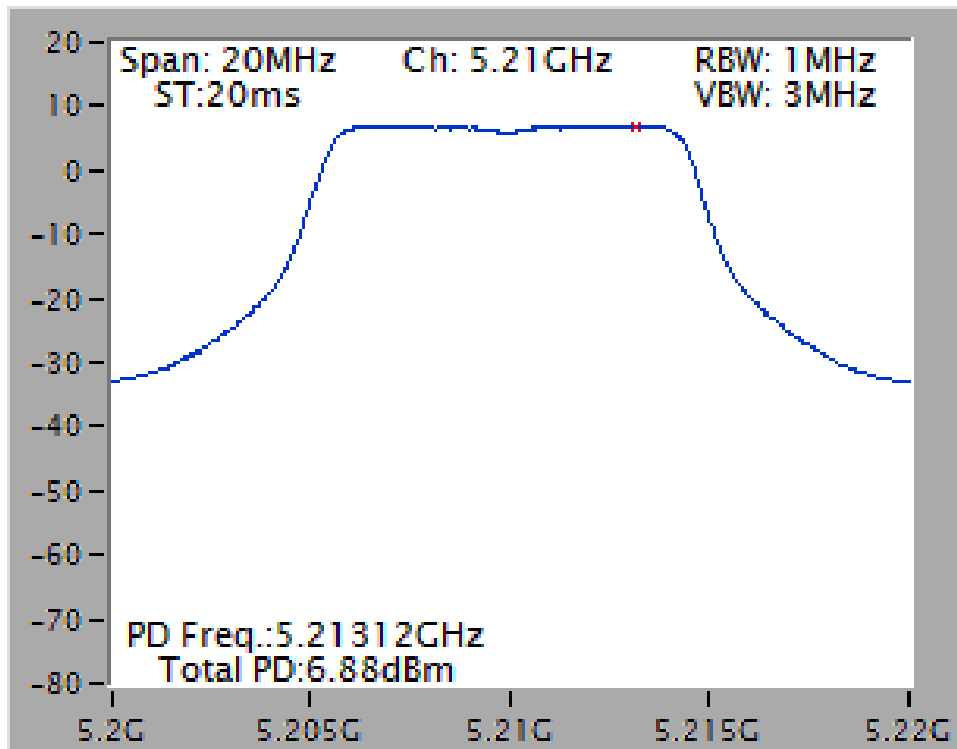

Power Density Plot on Configuration IEEE 802.11n MCS0 20 MHz / Chain 1 + Chain 2 / 5200 MHz

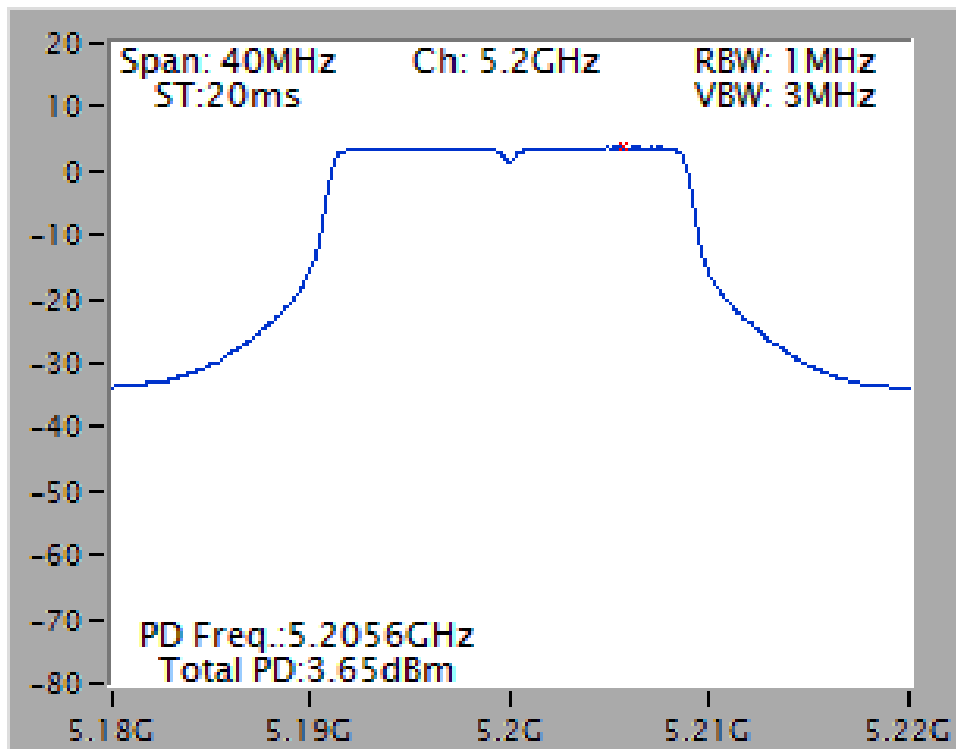

Power Density Plot on Configuration IEEE 802.11n MCS0 40 MHz / Chain 1 + Chain 2 / 5230 MHz

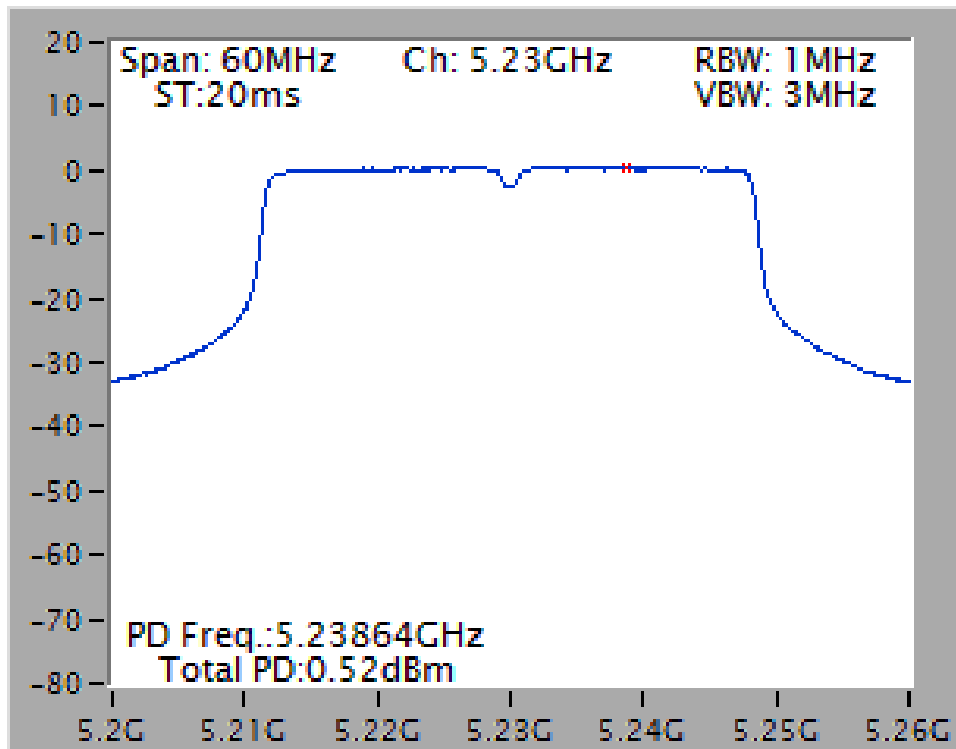



Power Density Plot on Configuration IEEE 802.11a 5 MHz / Chain 1 + Chain 2 / 5240 MHz

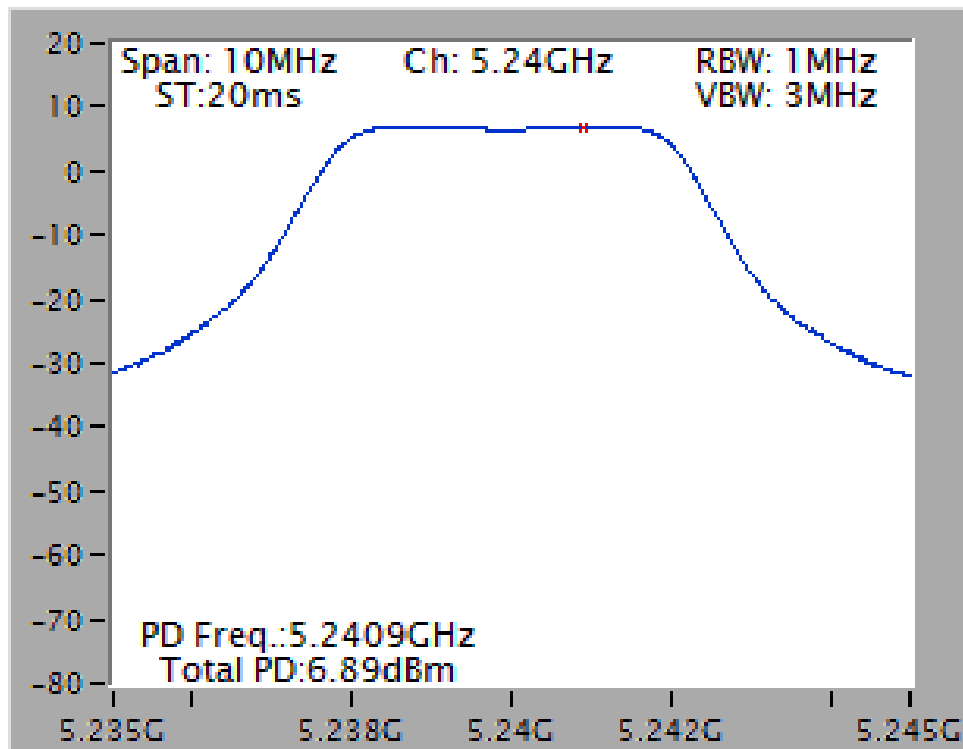

Power Density Plot on Configuration IEEE 802.11a 10 MHz / Chain 1 + Chain 2 / 5210 MHz

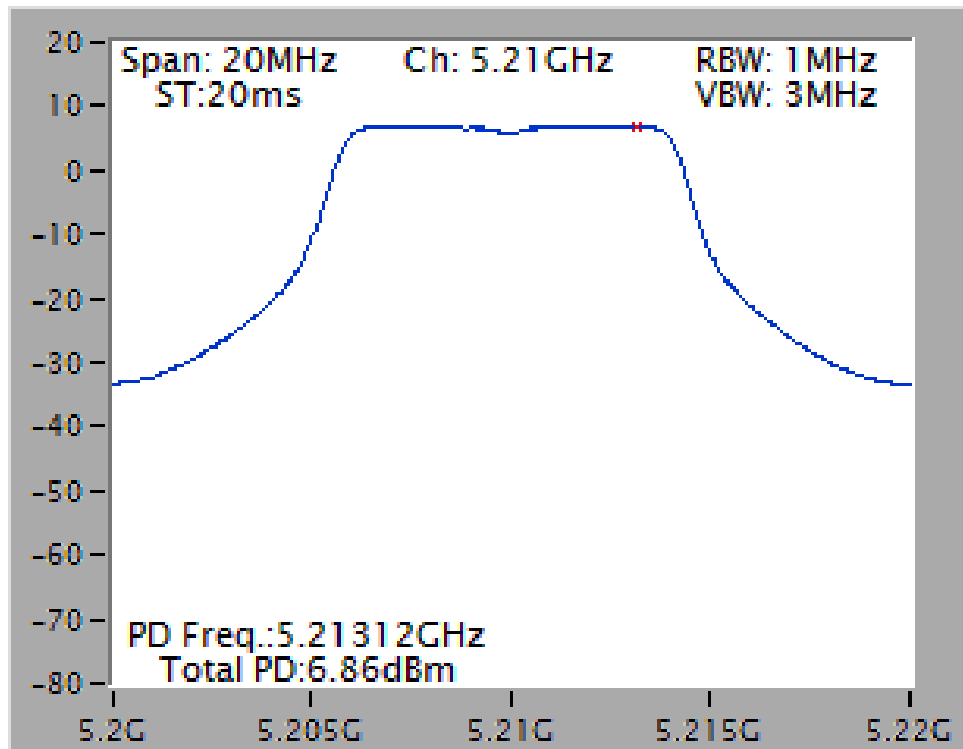

Power Density Plot on Configuration IEEE 802.11a 20 MHz / Chain 1 + Chain 2 / 5200 MHz

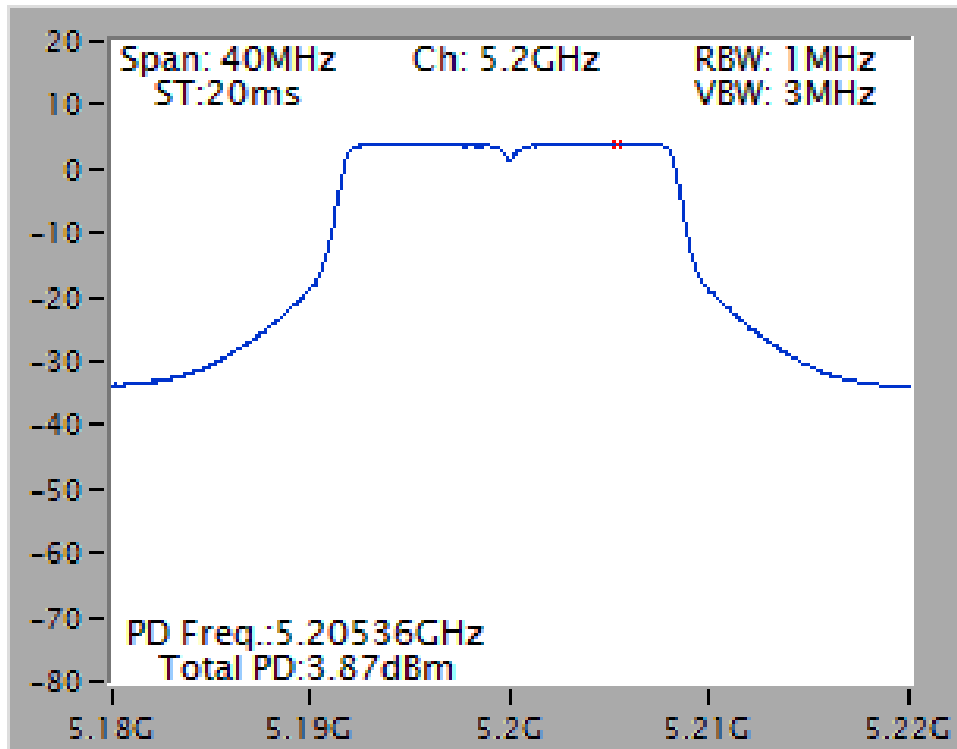

## Test Mode 2 / P to P

## Power Density Plot on Configuration IEEE 802.11n MCS0 5 MHz / Chain 1 + Chain 2 / 5240 MHz

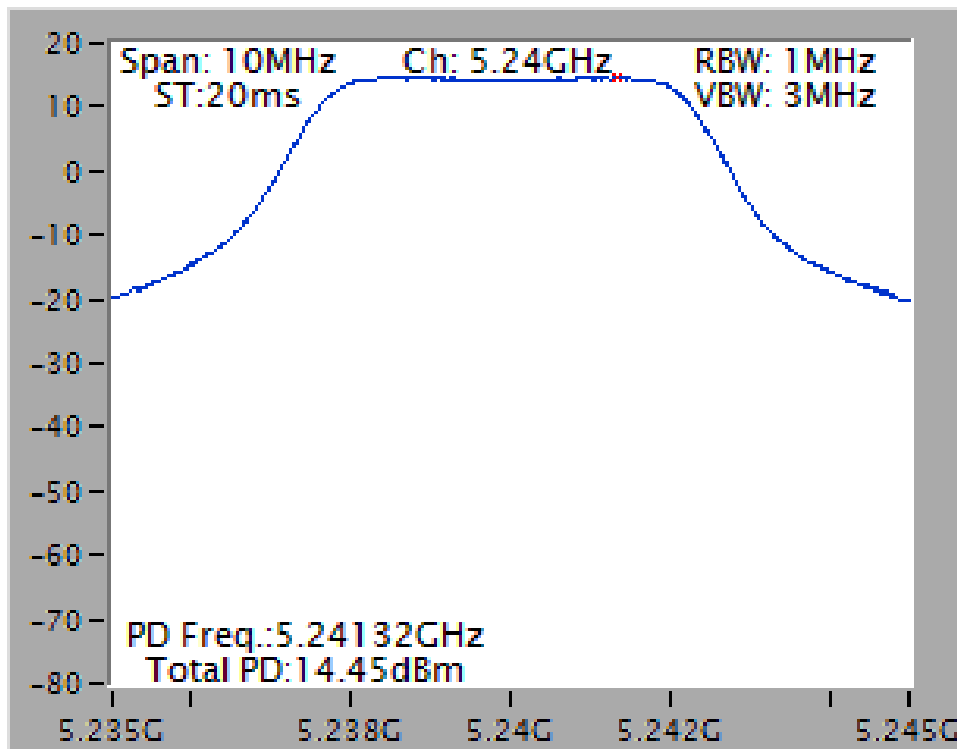

## Power Density Plot on Configuration IEEE 802.11n MCS0 10 MHz / Chain 1 + Chain 2 / 5240 MHz

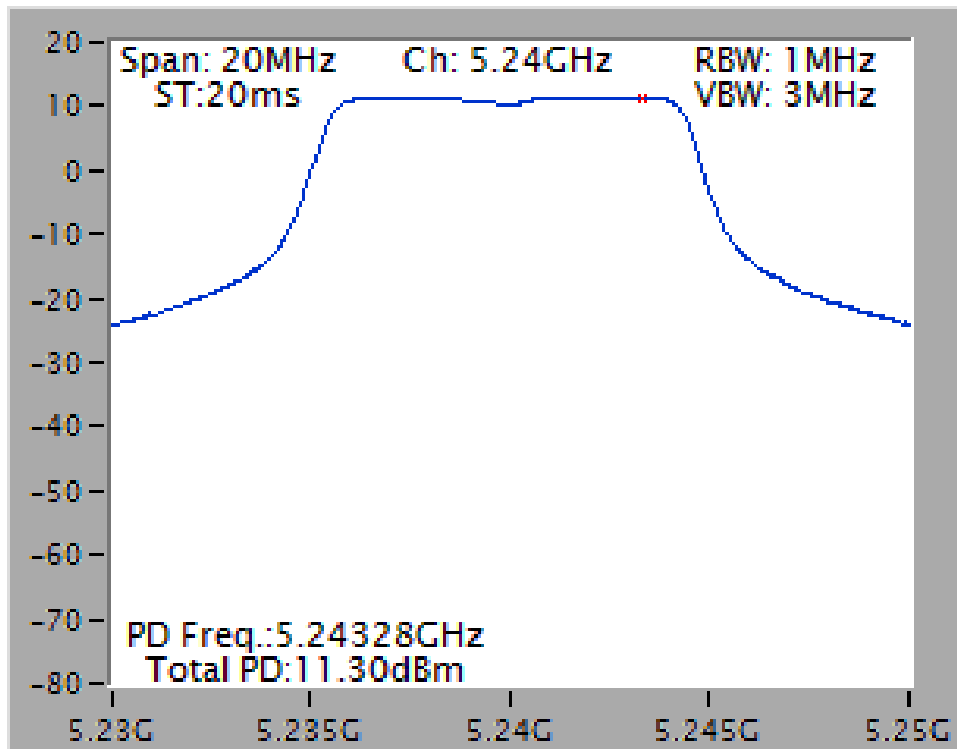

Power Density Plot on Configuration IEEE 802.11n MCS0 20 MHz / Chain 1 + Chain 2 / 5200 MHz

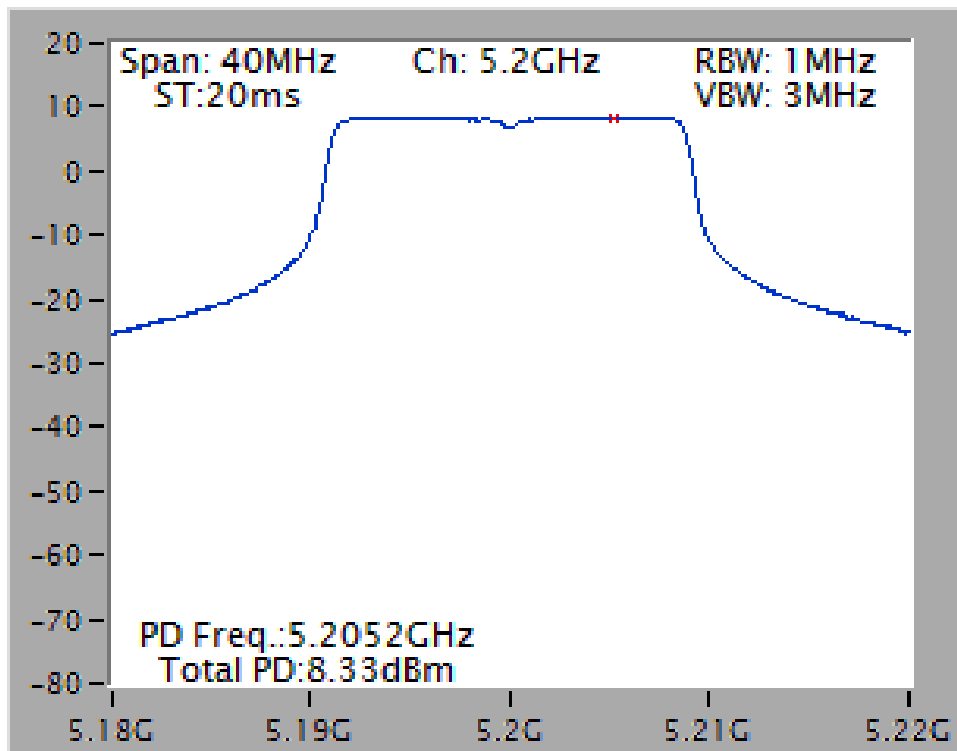

Power Density Plot on Configuration IEEE 802.11n MCS0 40 MHz / Chain 1 + Chain 2 / 5230 MHz

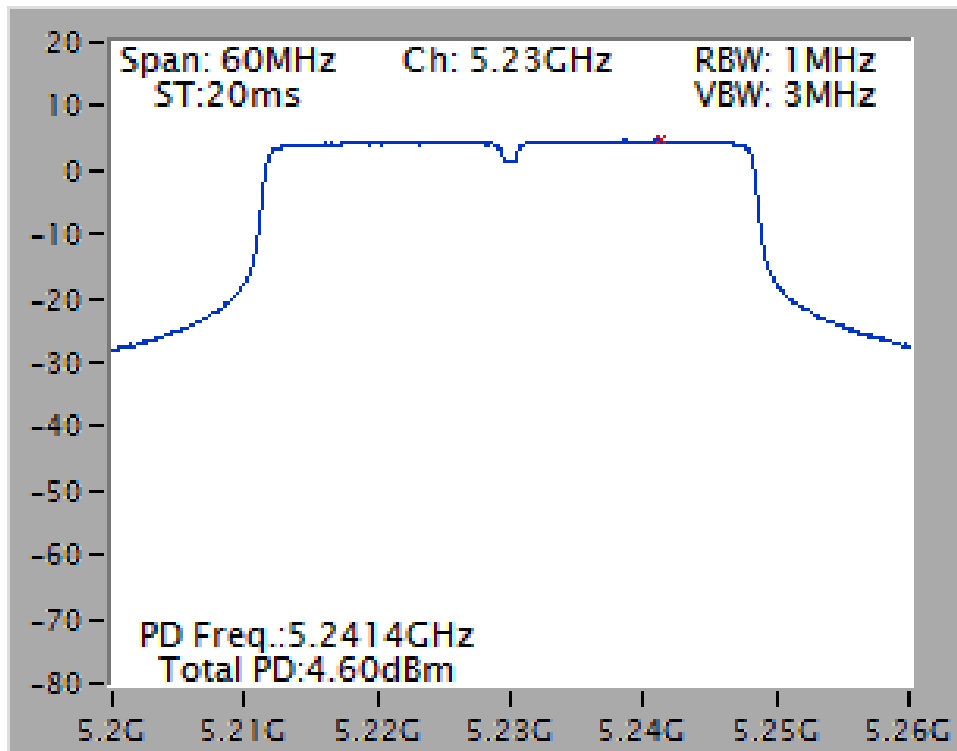

Power Density Plot on Configuration IEEE 802.11a 5 MHz / Chain 1 + Chain 2 / 5240 MHz

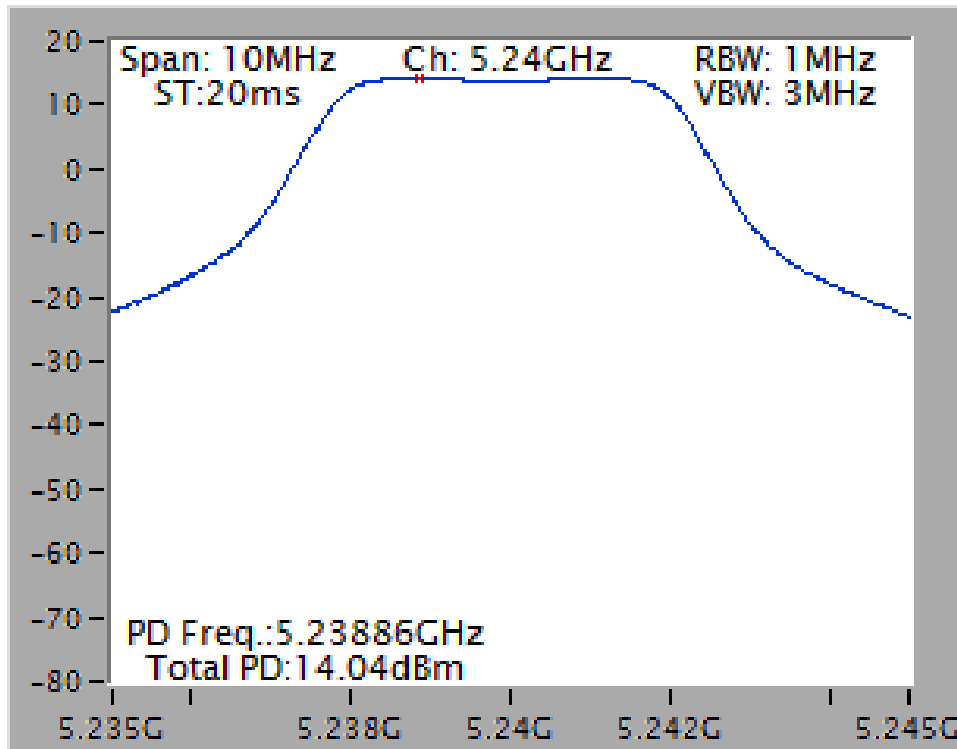

Power Density Plot on Configuration IEEE 802.11a 10 MHz / Chain 1 + Chain 2 / 5210 MHz

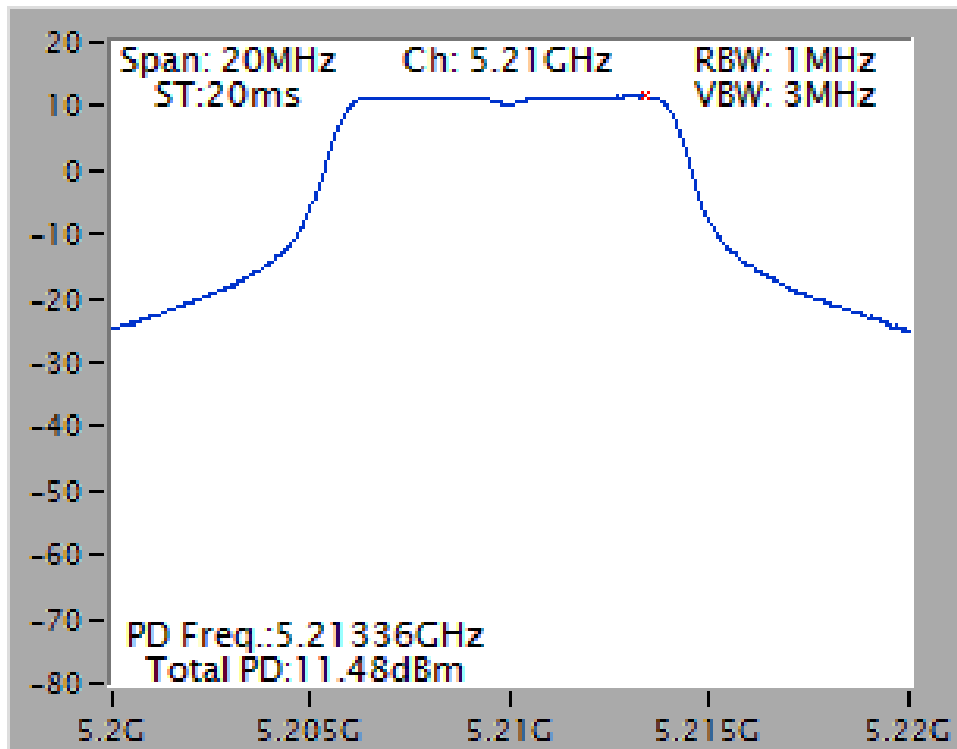

Power Density Plot on Configuration IEEE 802.11a 20 MHz / Chain 1 + Chain 2 / 5240 MHz

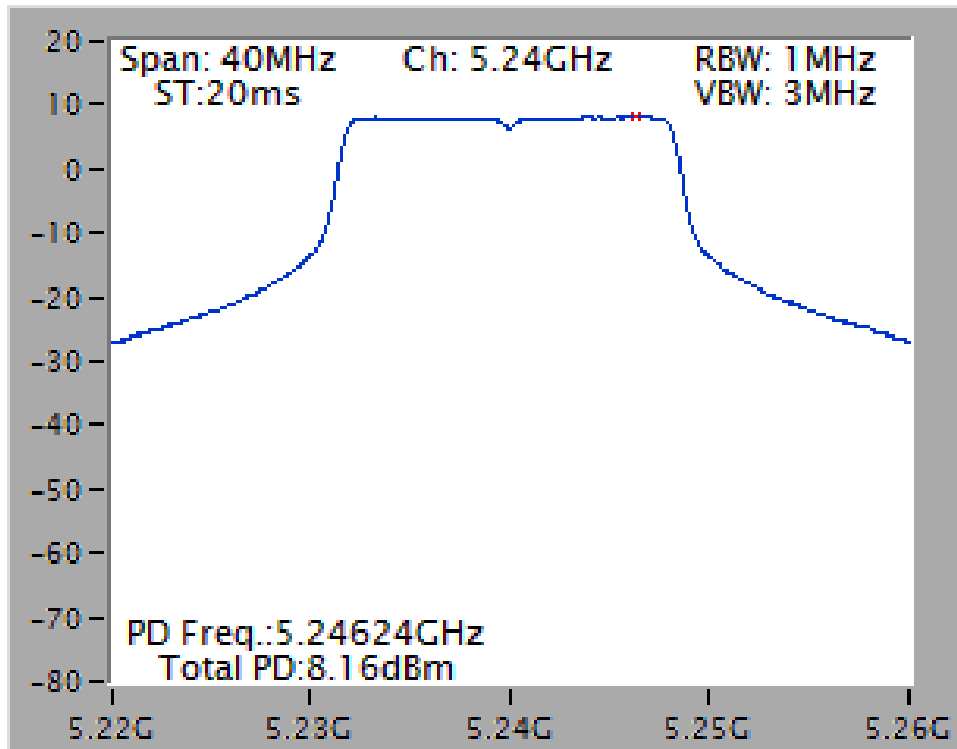

## Test Mode 2 / P to M

## Power Density Plot on Configuration IEEE 802.11n MCS0 5 MHz / Chain 1 + Chain 2 / 5240 MHz

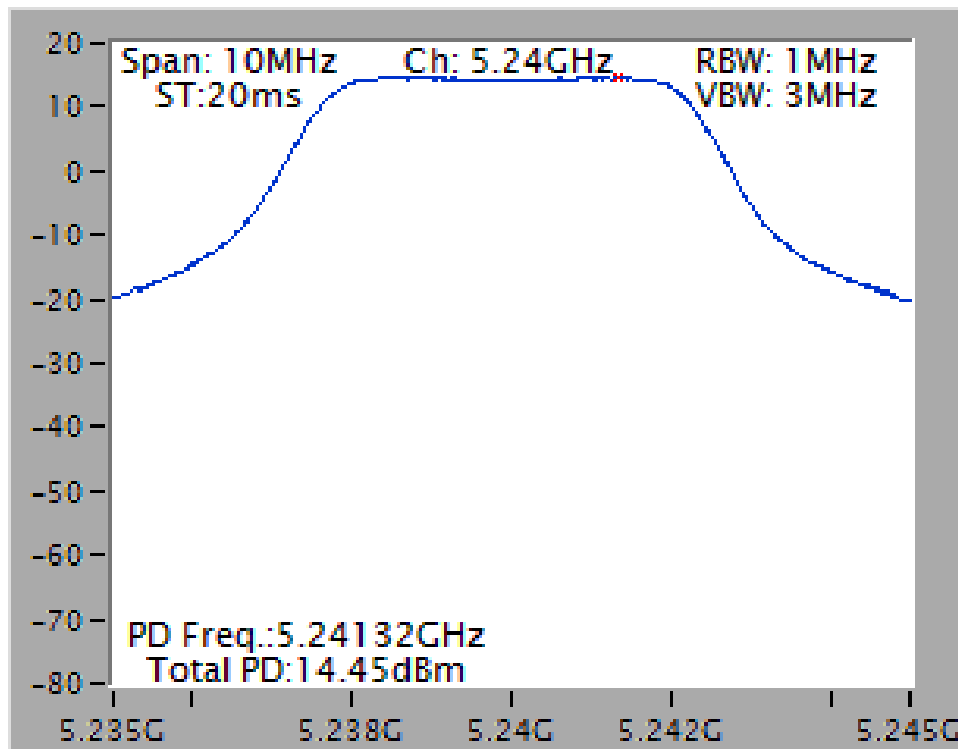

## Power Density Plot on Configuration IEEE 802.11n MCS0 10 MHz / Chain 1 + Chain 2 / 5240 MHz

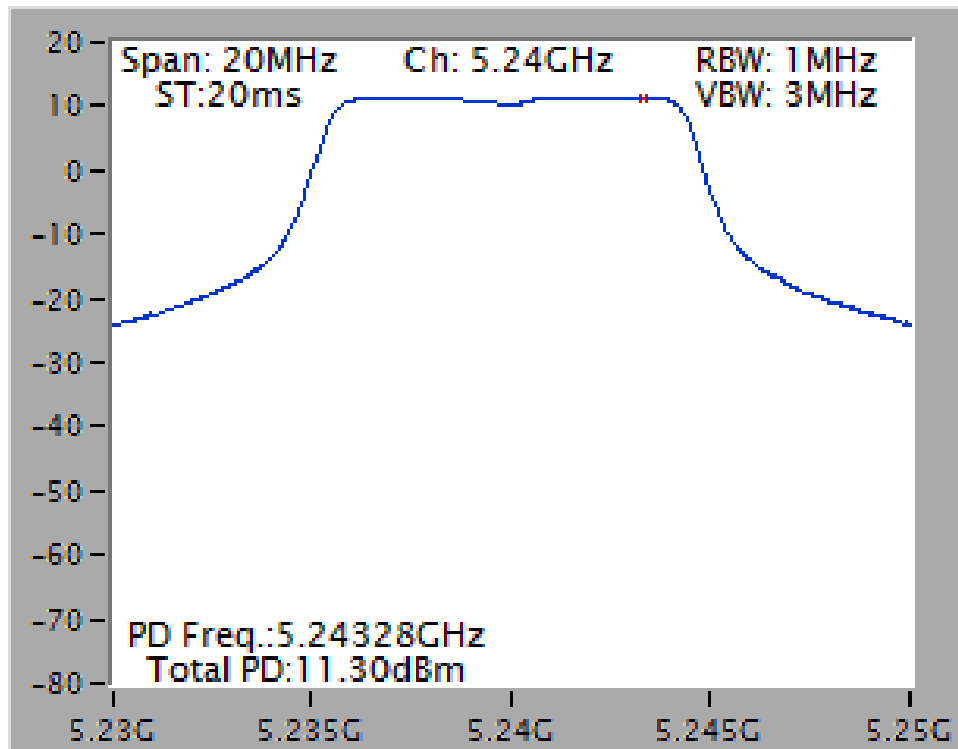

Power Density Plot on Configuration IEEE 802.11n MCS0 20 MHz / Chain 1 + Chain 2 / 5200 MHz

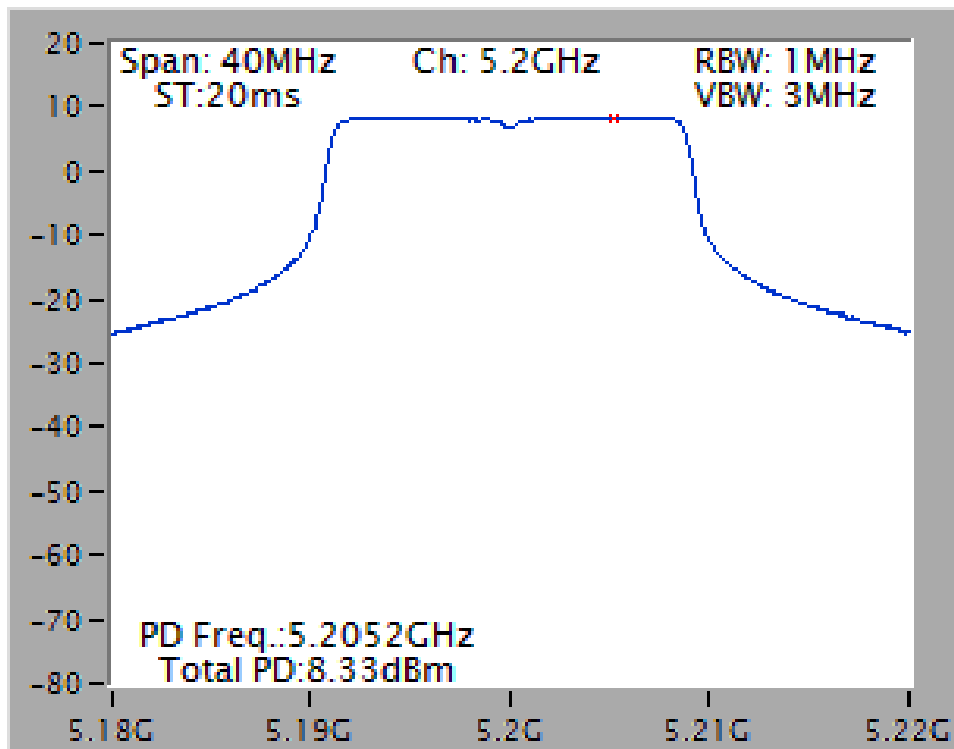

Power Density Plot on Configuration IEEE 802.11n MCS0 40 MHz / Chain 1 + Chain 2 / 5230 MHz

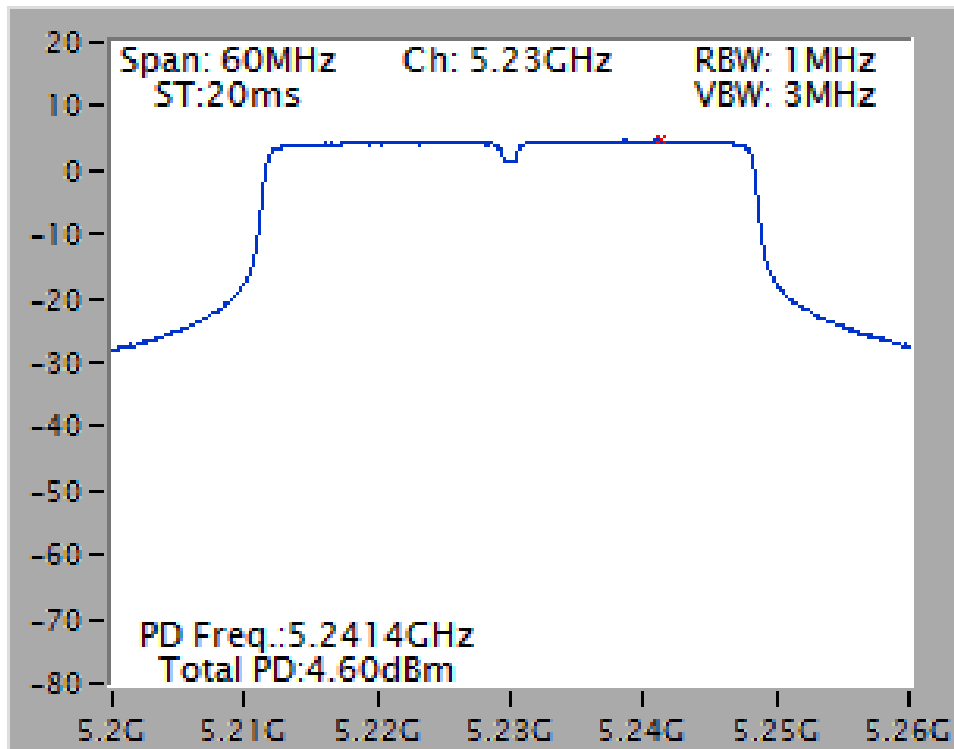



Power Density Plot on Configuration IEEE 802.11a 5 MHz / Chain 1 + Chain 2 / 5240 MHz

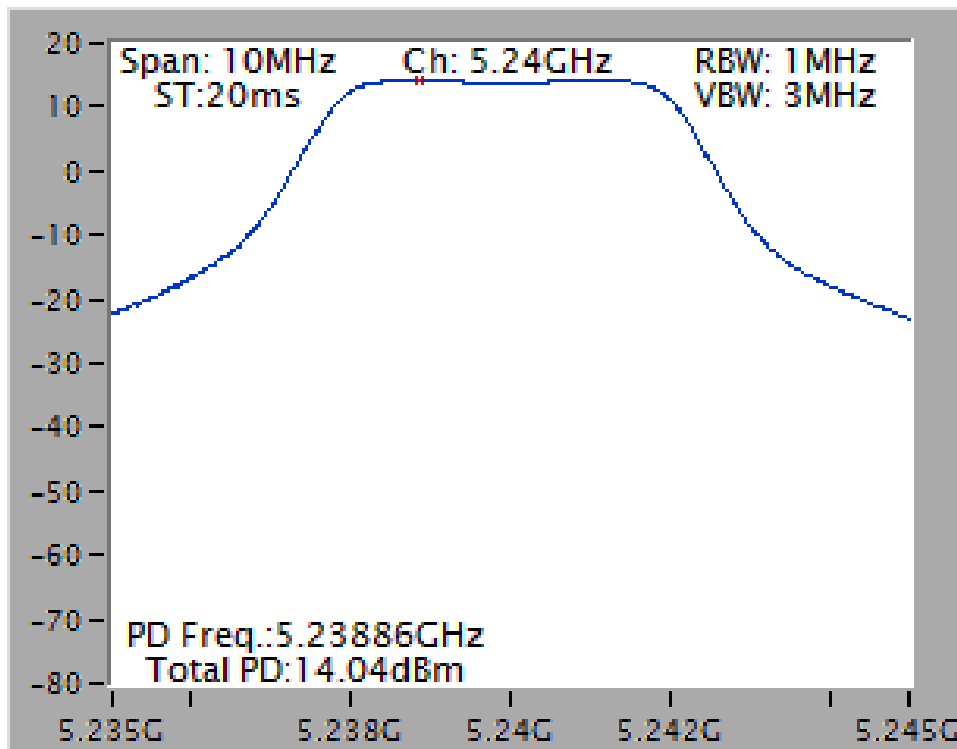

Power Density Plot on Configuration IEEE 802.11a 10 MHz / Chain 1 + Chain 2 / 5210 MHz

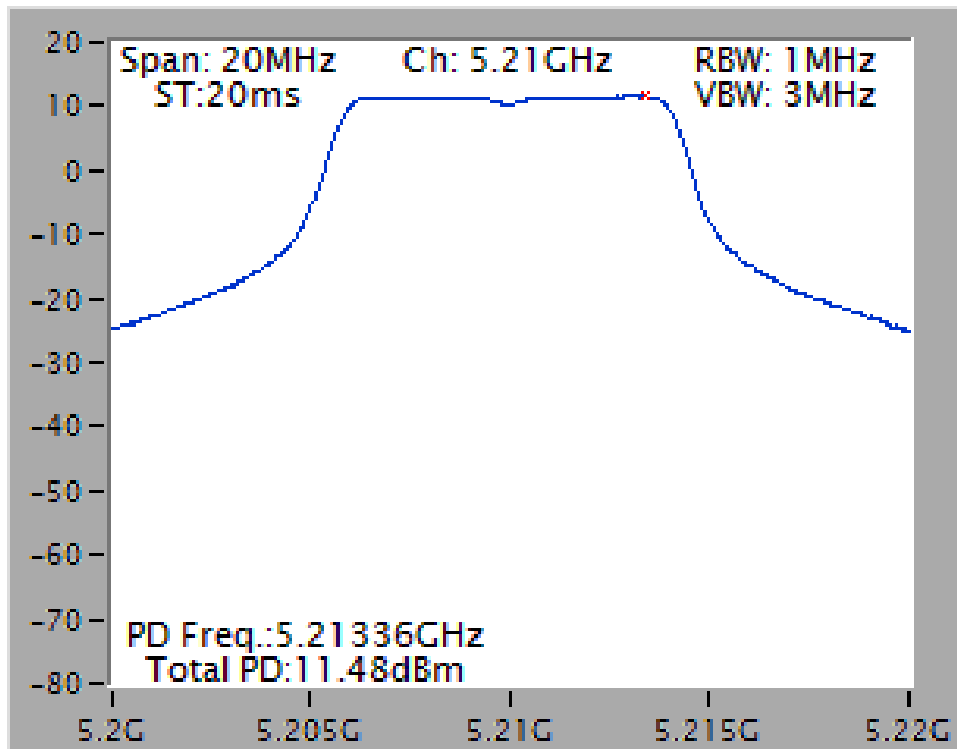

Power Density Plot on Configuration IEEE 802.11a 20 MHz / Chain 1 + Chain 2 / 5240 MHz

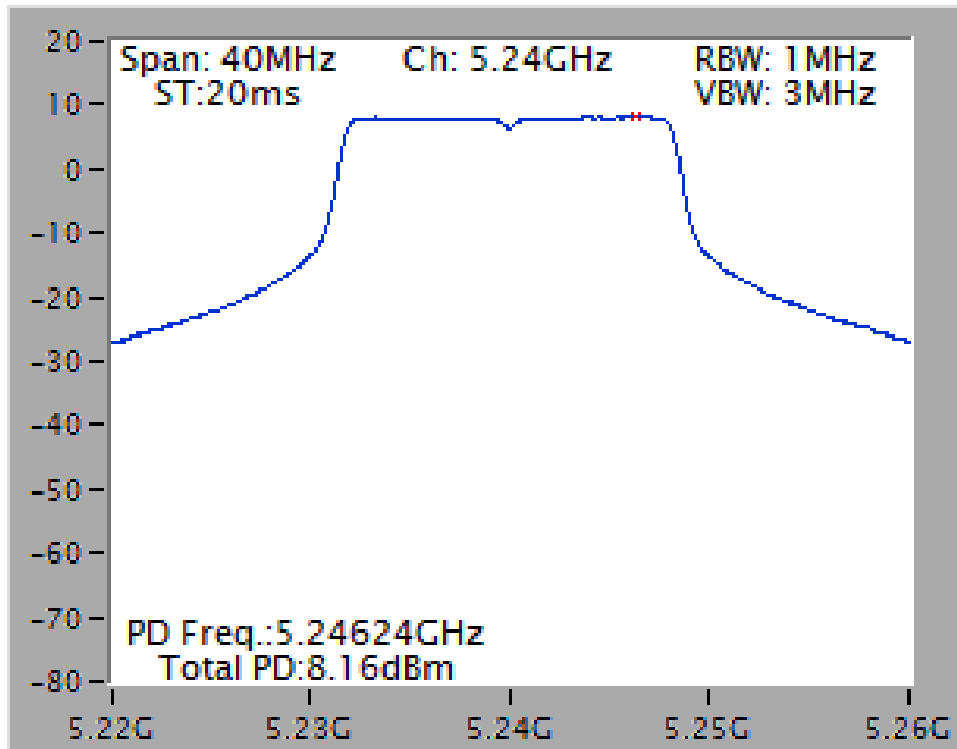

## Test Mode 3 / P to M

## Power Density Plot on Configuration IEEE 802.11n MCS0 5 MHz / Chain 1 + Chain 2 / 5240 MHz

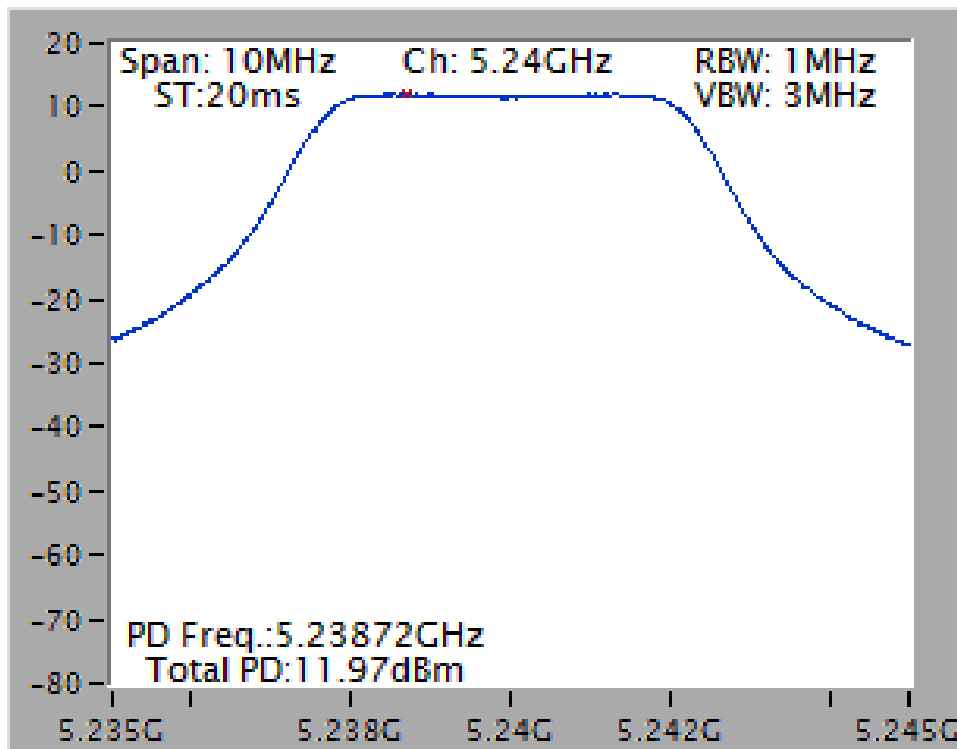

## Power Density Plot on Configuration IEEE 802.11n MCS0 10 MHz / Chain 1 + Chain 2 / 5180 MHz

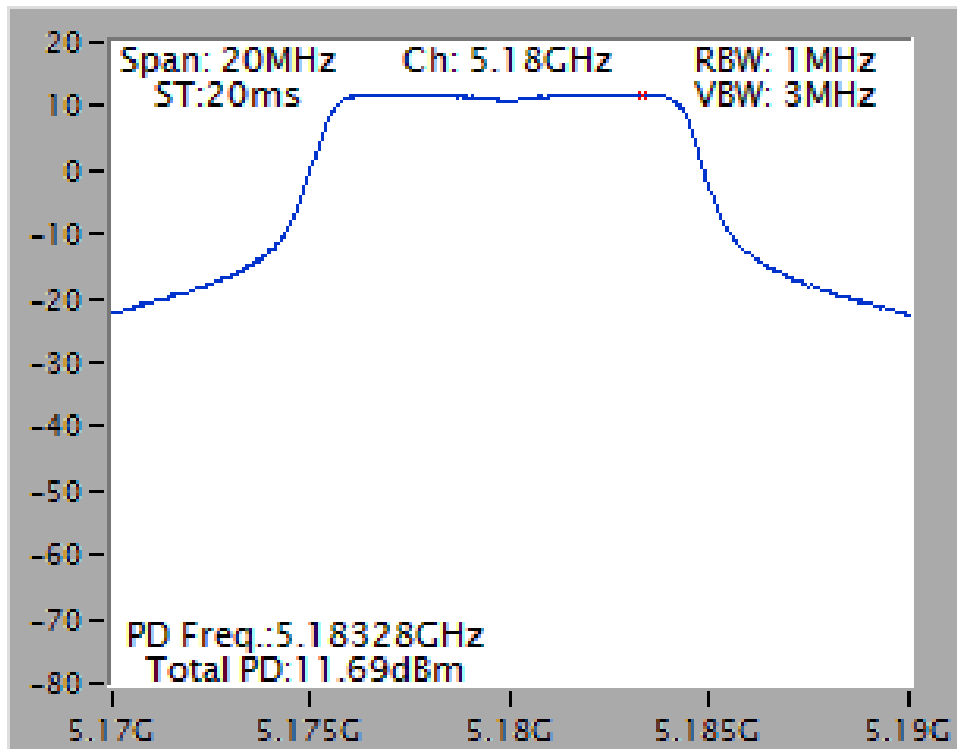

Power Density Plot on Configuration IEEE 802.11n MCS0 20 MHz / Chain 1 + Chain 2 / 5240 MHz

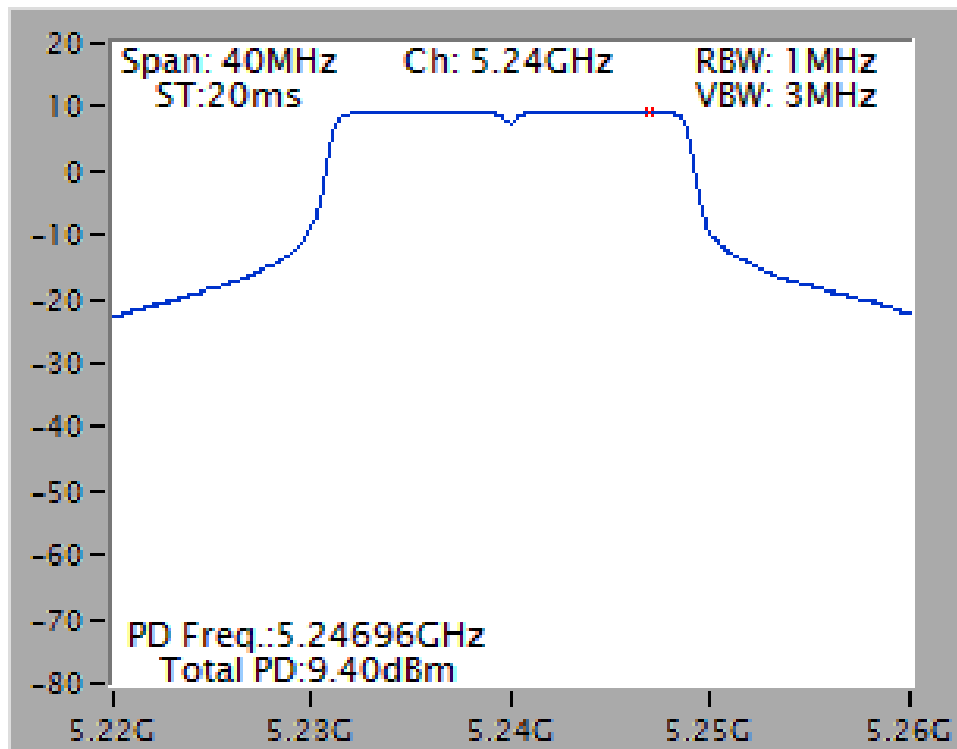

Power Density Plot on Configuration IEEE 802.11n MCS0 40 MHz / Chain 1 + Chain 2 / 5230 MHz

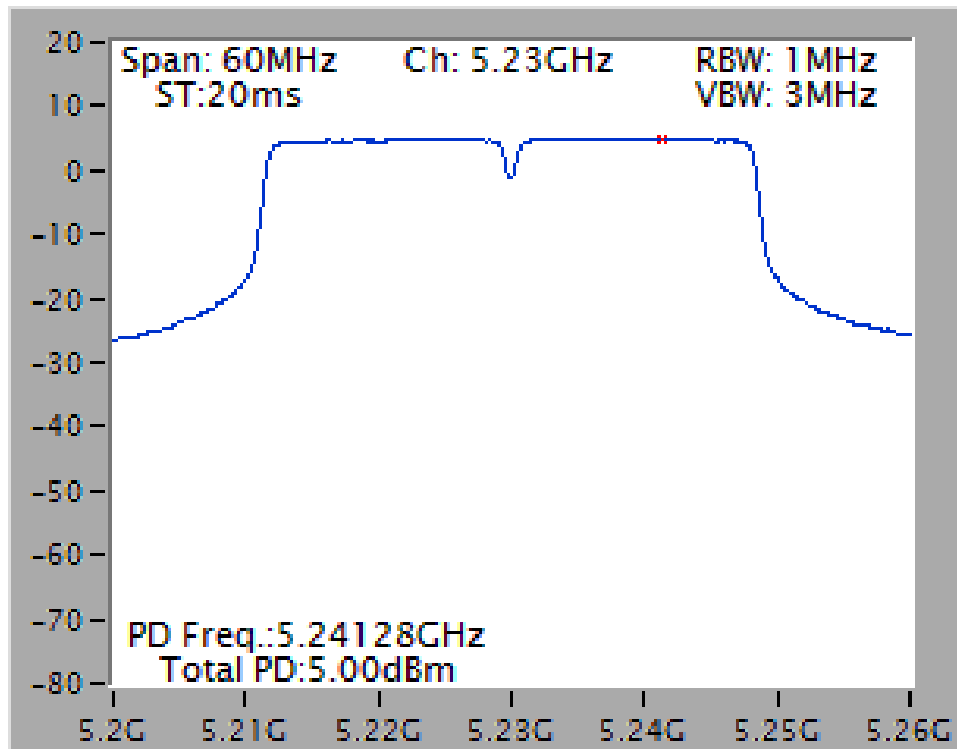

Power Density Plot on Configuration IEEE 802.11a 5 MHz / Chain 1 + Chain 2 / 5210 MHz

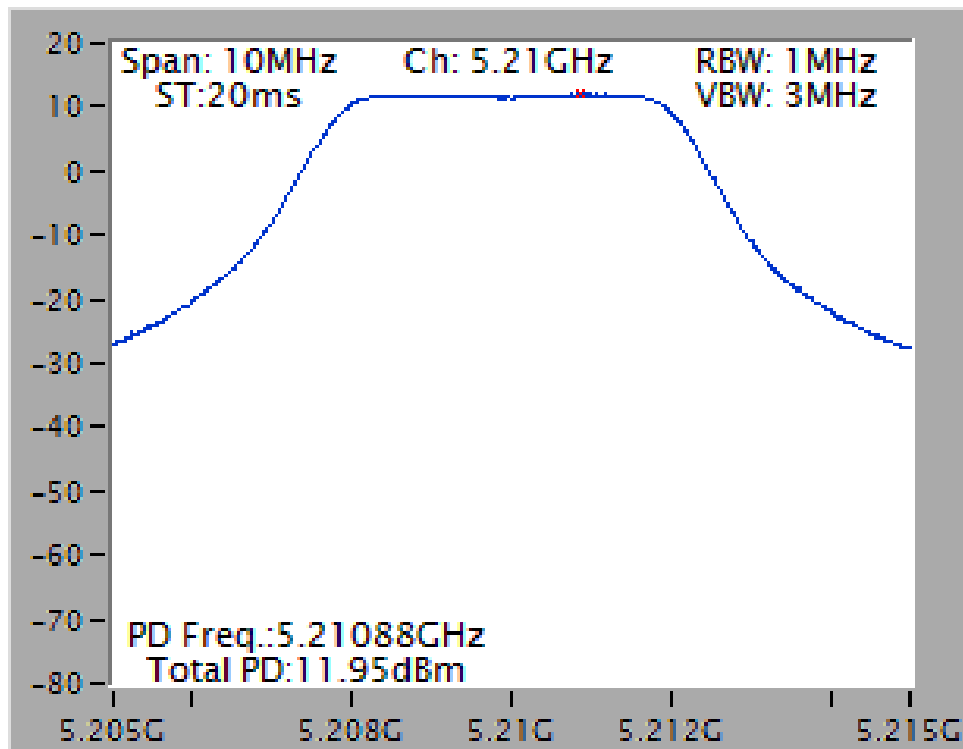

Power Density Plot on Configuration IEEE 802.11a 10 MHz / Chain 1 + Chain 2 / 5180 MHz

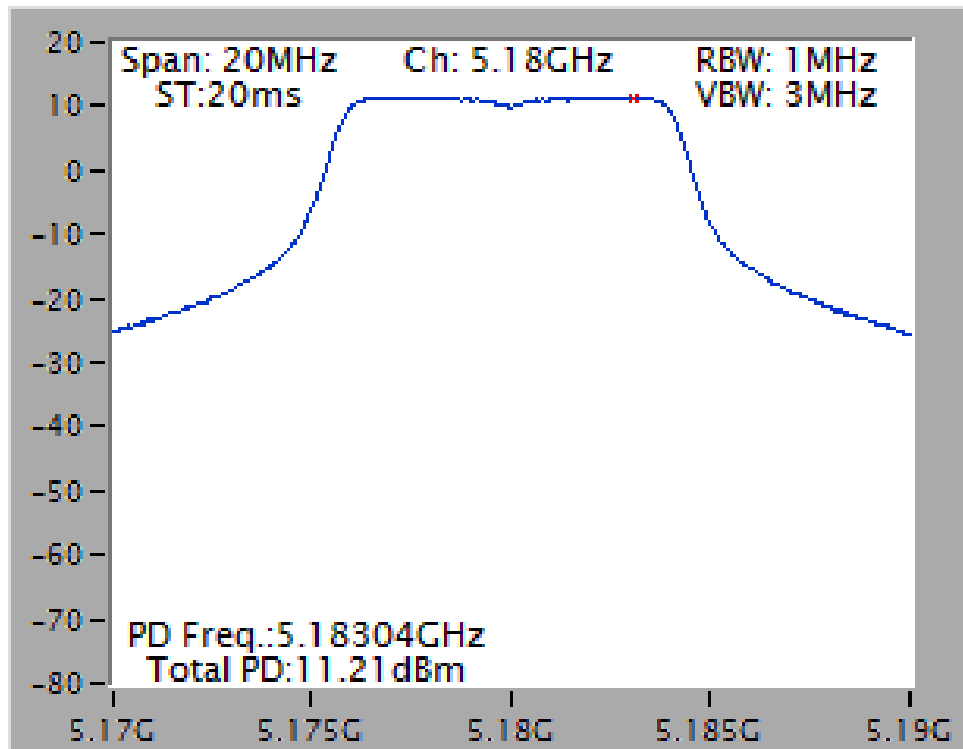

Power Density Plot on Configuration IEEE 802.11a 20 MHz / Chain 1 + Chain 2 / 5240 MHz

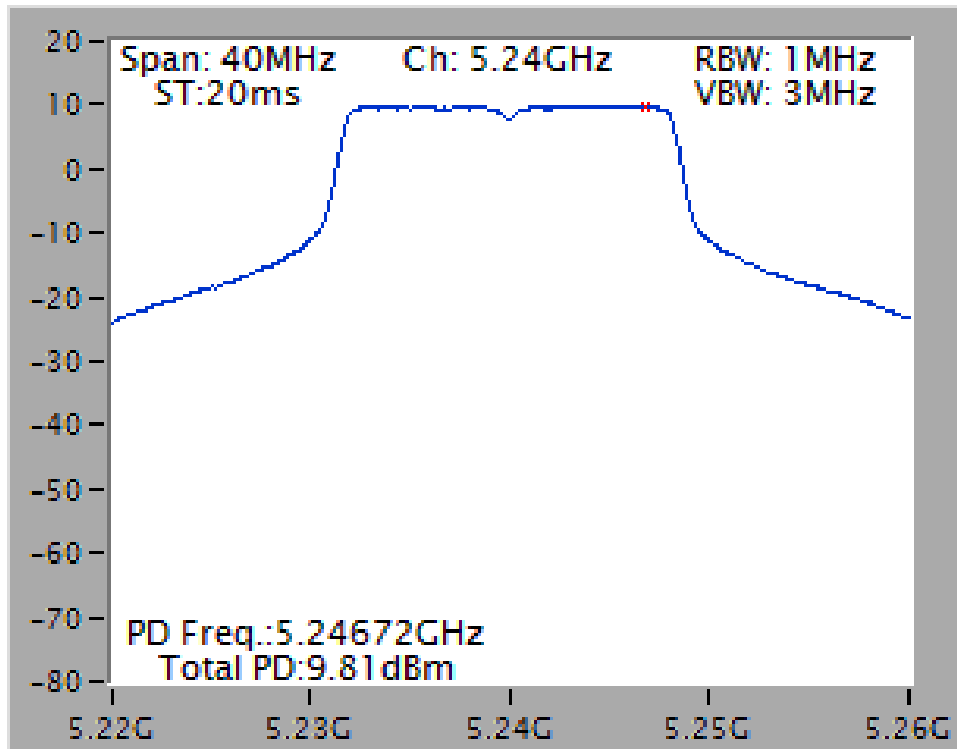

## 4.4. Radiated Emissions Measurement

### 4.4.1. Limit

For transmitters operating in the 5.15-5.25 GHz band: all emissions outside of the 5.15-5.25 GHz band shall not exceed an e.i.r.p. of  $-27$  dBm/MHz.

In addition, In case the emission fall within the restricted band specified on 15.205(a), then the 15.209(a) limit in the table below has to be followed.

Frequencies (MHz)	Field Strength (micovolts/meter)	Measurement Distance (meters)
0.009~0.490	2400/F(kHz)	300
0.490~1.705	24000/F(kHz)	30
1.705~30.0	30	30
30~88	100	3
88~216	150	3
216~960	200	3
Above 960	500	3

### 4.4.2. Measuring Instruments and Setting

Please refer to section 5 of equipments list in this report. The following table is the setting of spectrum analyzer and receiver.

Spectrum Parameter	Setting
Attenuation	Auto
Start Frequency	1000 MHz
Stop Frequency	40 GHz
RBW / VBW (Emission in restricted band)	1 MHz / 3MHz for Peak, 1 MHz / 1/T for Average
RBW / VBW (Emission in non-restricted band)	1 MHz / 3MHz for peak

Receiver Parameter	Setting
Attenuation	Auto
Start ~ Stop Frequency	9kHz~150kHz / RBW 200Hz for QP
Start ~ Stop Frequency	150kHz~30MHz / RBW 9kHz for QP
Start ~ Stop Frequency	30MHz~1000MHz / RBW 120kHz for QP

#### 4.4.3. Test Procedures

1. Configure the EUT according to ANSI C63.10. The EUT was placed on the top of the turntable 0.8 meter above ground. The phase center of the receiving antenna mounted on the top of a height-variable antenna tower was placed 3 meters far away from the turntable.
2. Power on the EUT and all the supporting units. The turntable was rotated by 360 degrees to determine the position of the highest radiation.
3. The height of the broadband receiving antenna was varied between one meter and four meters above ground to find the maximum emissions field strength of both horizontal and vertical polarization.
4. For each suspected emissions, the antenna tower was scan (from 1 M to 4 M) and then the turntable was rotated (from 0 degree to 360 degrees) to find the maximum reading.
5. Set the test-receiver system to Peak or CISPR quasi-peak Detect Function with specified bandwidth under Maximum Hold Mode.
6. For emissions above 1GHz, use 1MHz VBW and 3MHz RBW for peak reading. Then 1MHz RBW and 1/T VBW for average reading in spectrum analyzer.
7. If the emissions level of the EUT in peak mode was 3 dB lower than the average limit specified, then testing will be stopped and peak values of EUT will be reported, otherwise, the emissions which do not have 3 dB margin will be repeated one by one using the quasi-peak method for below 1GHz.
8. For testing above 1GHz, the emissions level of the EUT in peak mode was lower than average limit (that means the emissions level in peak mode also complies with the limit in average mode), then testing will be stopped and peak values of EUT will be reported, otherwise, the emissions will be measured in average mode again and reported.
9. In case the emission is lower than 30MHz, loop antenna has to be used for measurement and the recorded data should be QP measured by receiver. High – Low scan is not required in this case.



#### 4.4.4. Test Setup Layout

For Radiated Emissions: Above 1GHz

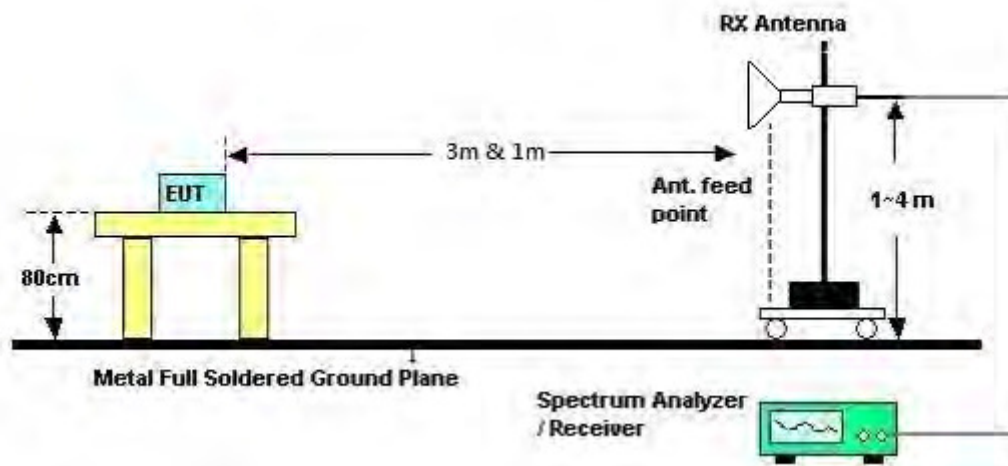

#### 4.4.5. Test Deviation

There is no deviation with the original standard.

#### 4.4.6. EUT Operation during Test

The EUT was programmed to be in continuously transmitting mode.

#### 4.4.7. Results for Radiated Emissions (1GHz~40GHz)

<b>Temperature</b>	25°C	<b>Humidity</b>	56%
<b>Test Engineer</b>	YC Chen	<b>Configurations</b>	IEEE 802.11n MCS0 5 MHz CH 36 / Chain 1 + Chain 2
<b>Test Date</b>	Aug. 15, 2014	<b>Test Mode</b>	Mode 1

##### Horizontal

	Freq	Level	Limit Line	Over Limit	Read Level	CableAntenna Loss	Antenna Factor	Preamp Factor	Remark	A/Pos	T/Pos	Pol/Phase
	MHz	dBuV/m	dBuV/m	dB	dBuV	dB	dB/m	dB		cm	deg	
1	15538.44	43.50	54.00	-10.50	34.09	6.13	38.45	35.17	Average	100	177	HORIZONTAL
2	15547.56	53.96	74.00	-20.04	44.57	6.13	38.43	35.17	Peak	100	177	HORIZONTAL

##### Vertical

	Freq	Level	Limit Line	Over Limit	Read Level	CableAntenna Loss	Antenna Factor	Preamp Factor	Remark	A/Pos	T/Pos	Pol/Phase
	MHz	dBuV/m	dBuV/m	dB	dBuV	dB	dB/m	dB		cm	deg	
1	15538.72	55.75	74.00	-18.25	46.34	6.13	38.45	35.17	Peak	100	13	VERTICAL
2	15541.32	41.60	54.00	-12.40	32.19	6.13	38.45	35.17	Average	100	13	VERTICAL



<b>Temperature</b>	25°C	<b>Humidity</b>	56%
<b>Test Engineer</b>	YC Chen	<b>Configurations</b>	IEEE 802.11n MCS0 5 MHz CH 42 / Chain 1 + Chain 2
<b>Test Date</b>	Aug. 19, 2014	<b>Test Mode</b>	Mode 1

**Horizontal**

	Freq	Level	Limit Line	Over Limit	Read Level	CableAntenna Loss	Antenna Factor	Preamp Factor	Remark	T/Pos	A/Pos	Pol/Phase
	MHz	dBuV/m	dBuV/m	dB	dBuV	dB	dB/m	dB		deg	cm	
1	15629.48	46.22	54.00	-7.78	34.55	7.89	38.59	34.81	Average	101	127	HORIZONTAL
2	15630.40	68.16	74.00	-5.84	56.49	7.89	38.59	34.81	Peak	101	127	HORIZONTAL

**Vertical**

	Freq	Level	Limit Line	Over Limit	Read Level	CableAntenna Loss	Antenna Factor	Preamp Factor	Remark	T/Pos	A/Pos	Pol/Phase
	MHz	dBuV/m	dBuV/m	dB	dBuV	dB	dB/m	dB		deg	cm	
1	15626.52	70.32	74.00	-3.68	58.65	7.88	38.60	34.81	Peak	219	117	VERTICAL
2	15631.20	47.02	54.00	-6.98	35.35	7.89	38.59	34.81	Average	219	117	VERTICAL



<b>Temperature</b>	25°C	<b>Humidity</b>	56%
<b>Test Engineer</b>	YC Chen	<b>Configurations</b>	IEEE 802.11n MCS0 5 MHz CH 48 / Chain 1 + Chain 2
<b>Test Date</b>	Aug. 15, 2014	<b>Test Mode</b>	Mode 1

**Horizontal**

	Freq	Level	Limit	Over	Read	Cable	Antenna	Preamp	Remark	A/Pos	T/Pos	Pol/Phase
	MHz	dBuV/m	dBuV/m	dB	dBuV	Loss	Factor	Factor		cm	deg	
1	15718.40	41.40	54.00	-12.60	32.28	6.14	38.19	35.21	Average	100	164	HORIZONTAL
2	15720.36	55.72	74.00	-18.28	46.60	6.14	38.19	35.21	Peak	100	164	HORIZONTAL

**Vertical**

	Freq	Level	Limit	Over	Read	Cable	Antenna	Preamp	Remark	A/Pos	T/Pos	Pol/Phase
	MHz	dBuV/m	dBuV/m	dB	dBuV	Loss	Factor	Factor		cm	deg	
1	15717.76	53.52	74.00	-20.48	44.40	6.14	38.19	35.21	Peak	100	230	VERTICAL
2	15720.60	41.23	54.00	-12.77	32.11	6.14	38.19	35.21	Average	100	230	VERTICAL



<b>Temperature</b>	25°C	<b>Humidity</b>	56%
<b>Test Engineer</b>	YC Chen	<b>Configurations</b>	IEEE 802.11n MCS0 10 MHz CH 36 / Chain 1 + Chain 2
<b>Test Date</b>	Aug. 15, 2014	<b>Test Mode</b>	Mode 1

**Horizontal**

	Freq	Level	Limit Line	Over Limit	Read Level	Cable Loss	Antenna Factor	Preamp Factor	Remark	A/Pos	T/Pos	Pol/Phase
	MHz	dBuV/m	dBuV/m	dB	dBuV	dB	dB/m	dB		cm	deg	
1	15537.96	44.04	54.00	-9.96	34.63	6.13	38.45	35.17	Average	100	310	HORIZONTAL
2	15540.72	58.72	74.00	-15.28	49.31	6.13	38.45	35.17	Peak	100	310	HORIZONTAL

**Vertical**

	Freq	Level	Limit Line	Over Limit	Read Level	Cable Loss	Antenna Factor	Preamp Factor	Remark	A/Pos	T/Pos	Pol/Phase
	MHz	dBuV/m	dBuV/m	dB	dBuV	dB	dB/m	dB		cm	deg	
1	15542.24	41.97	54.00	-12.03	32.56	6.13	38.45	35.17	Average	100	274	VERTICAL
2	15545.20	56.66	74.00	-17.34	47.27	6.13	38.43	35.17	Peak	100	274	VERTICAL



<b>Temperature</b>	25°C	<b>Humidity</b>	56%
<b>Test Engineer</b>	YC Chen	<b>Configurations</b>	IEEE 802.11n MCS0 10 MHz CH 42 / Chain 1 + Chain 2
<b>Test Date</b>	Aug. 19, 2014	<b>Test Mode</b>	Mode 1

**Horizontal**

	Freq	Level	Limit	Over	Read	CableAntenna	Preamp		T/Pos	A/Pos	Pol/Phase
	MHz	dBuV/m	dBuV/m	dB	dBuV	dB	dB/m	dB	deg	cm	
1	15629.08	43.89	54.00	-10.11	32.22	7.89	38.59	34.81	Average	331	100 HORIZONTAL
2	15631.32	58.14	74.00	-15.86	46.47	7.89	38.59	34.81	Peak	331	100 HORIZONTAL

**Vertical**

	Freq	Level	Limit	Over	Read	CableAntenna	Preamp		T/Pos	A/Pos	Pol/Phase
	MHz	dBuV/m	dBuV/m	dB	dBuV	dB	dB/m	dB	deg	cm	
1	15629.28	45.25	54.00	-8.75	33.58	7.89	38.59	34.81	Average	191	131 VERTICAL
2	15630.36	62.59	74.00	-11.41	50.92	7.89	38.59	34.81	Peak	191	131 VERTICAL



<b>Temperature</b>	25°C	<b>Humidity</b>	56%
<b>Test Engineer</b>	YC Chen	<b>Configurations</b>	IEEE 802.11n MCS0 10 MHz CH 48 / Chain 1 + Chain 2
<b>Test Date</b>	Aug. 15, 2014	<b>Test Mode</b>	Mode 1

**Horizontal**

	Freq	Level	Limit Line	Over Limit	Read Level	Cable Loss	Antenna Factor	Preamp Factor	Remark	A/Pos	T/Pos	Pol/Phase
	MHz	dBuV/m	dBuV/m	dB	dBuV	dB	dB/m	dB		cm	deg	
1	15718.28	56.31	74.00	-17.69	47.19	6.14	38.19	35.21	Peak	100	316	HORIZONTAL
2	15721.72	40.87	54.00	-13.13	31.75	6.14	38.19	35.21	Average	100	316	HORIZONTAL

**Vertical**

	Freq	Level	Limit Line	Over Limit	Read Level	Cable Loss	Antenna Factor	Preamp Factor	Remark	A/Pos	T/Pos	Pol/Phase
	MHz	dBuV/m	dBuV/m	dB	dBuV	dB	dB/m	dB		cm	deg	
1	15717.16	40.31	54.00	-13.69	31.19	6.14	38.19	35.21	Average	100	281	VERTICAL
2	15721.72	55.79	74.00	-18.21	46.67	6.14	38.19	35.21	Peak	100	281	VERTICAL



<b>Temperature</b>	25°C	<b>Humidity</b>	56%
<b>Test Engineer</b>	YC Chen	<b>Configurations</b>	IEEE 802.11n MCS0 20 MHz CH 36 / Chain 1 + Chain 2
<b>Test Date</b>	Aug. 15, 2014	<b>Test Mode</b>	Mode 1

**Horizontal**

	Freq	Level	Limit Line	Over Limit	Read Level	Cable Loss	Antenna Factor	Preamp Factor	Remark	A/Pos	T/Pos	Pol/Phase
	MHz	dBuV/m	dBuV/m	dB	dBuV	dB	dB/m	dB		cm	deg	
1	15537.48	54.02	74.00	-19.98	44.61	6.13	38.45	35.17	Peak	100	246	HORIZONTAL
2	15541.40	41.14	54.00	-12.86	31.73	6.13	38.45	35.17	Average	100	246	HORIZONTAL

**Vertical**

	Freq	Level	Limit Line	Over Limit	Read Level	Cable Loss	Antenna Factor	Preamp Factor	Remark	A/Pos	T/Pos	Pol/Phase
	MHz	dBuV/m	dBuV/m	dB	dBuV	dB	dB/m	dB		cm	deg	
1	15533.16	54.31	74.00	-19.69	44.90	6.13	38.45	35.17	Peak	100	332	VERTICAL
2	15535.84	41.13	54.00	-12.87	31.72	6.13	38.45	35.17	Average	100	332	VERTICAL





<b>Temperature</b>	25°C	<b>Humidity</b>	56%
<b>Test Engineer</b>	YC Chen	<b>Configurations</b>	IEEE 802.11n MCS0 20 MHz CH 40 / Chain 1 + Chain 2
<b>Test Date</b>	Aug. 15, 2014	<b>Test Mode</b>	Mode 1

**Horizontal**

	Freq	Level	Limit Line	Over Limit	Read Level	Cable Loss	Antenna Factor	Preamp Factor	Remark	A/Pos	T/Pos	Pol/Phase
	MHz	dBuV/m	dBuV/m	dB	dBuV	dB	dB/m	dB		cm	deg	
1	15598.44	41.67	54.00	-12.33	32.36	6.13	38.36	35.18	Average	100	56	HORIZONTAL
2	15609.20	53.81	74.00	-20.19	44.51	6.13	38.36	35.19	Peak	100	56	HORIZONTAL

**Vertical**

	Freq	Level	Limit Line	Over Limit	Read Level	Cable Loss	Antenna Factor	Preamp Factor	Remark	A/Pos	T/Pos	Pol/Phase
	MHz	dBuV/m	dBuV/m	dB	dBuV	dB	dB/m	dB		cm	deg	
1	15595.40	40.65	54.00	-13.35	31.34	6.13	38.36	35.18	Average	100	201	VERTICAL
2	15609.36	53.30	74.00	-20.70	44.00	6.13	38.36	35.19	Peak	100	201	VERTICAL



<b>Temperature</b>	25°C	<b>Humidity</b>	56%
<b>Test Engineer</b>	YC Chen	<b>Configurations</b>	IEEE 802.11n MCS0 20 MHz CH 48 / Chain 1 + Chain 2
<b>Test Date</b>	Aug. 15, 2014	<b>Test Mode</b>	Mode 1

**Horizontal**

	Freq	Level	Limit Line	Over Limit	Read Level	Cable Loss	Antenna Factor	Preamp Factor	Remark	A/Pos	T/Pos	Pol/Phase
	MHz	dBuV/m	dBuV/m	dB	dBuV	dB	dB/m	dB		cm	deg	
1	15710.88	53.45	74.00	-20.55	44.31	6.14	38.21	35.21	Peak	100	332	HORIZONTAL
2	15716.80	40.34	54.00	-13.66	31.22	6.14	38.19	35.21	Average	100	332	HORIZONTAL

**Vertical**

	Freq	Level	Limit Line	Over Limit	Read Level	Cable Loss	Antenna Factor	Preamp Factor	Remark	A/Pos	T/Pos	Pol/Phase
	MHz	dBuV/m	dBuV/m	dB	dBuV	dB	dB/m	dB		cm	deg	
1	15717.60	40.15	54.00	-13.85	31.03	6.14	38.19	35.21	Average	100	263	VERTICAL
2	15723.72	52.84	74.00	-21.16	43.72	6.14	38.19	35.21	Peak	100	263	VERTICAL



<b>Temperature</b>	25°C	<b>Humidity</b>	56%
<b>Test Engineer</b>	YC Chen	<b>Configurations</b>	IEEE 802.11n MCS0 40 MHz CH 38 / Chain 1 + Chain 2
<b>Test Date</b>	Aug. 15, 2014	<b>Test Mode</b>	Mode 1

**Horizontal**

	Freq	Level	Limit	Over	Read	Cable	Antenna	Preamp	Remark	A/Pos	T/Pos	Pol/Phase
	MHz	dBuV/m	dBuV/m	dB	dBuV	Loss	Factor	Factor		cm	deg	
1	15567.44	40.58	54.00	-13.42	31.22	6.13	38.40	35.17	Average	100	347	HORIZONTAL
2	15573.32	53.37	74.00	-20.63	44.02	6.13	38.40	35.18	Peak	100	347	HORIZONTAL

**Vertical**

	Freq	Level	Limit	Over	Read	Cable	Antenna	Preamp	Remark	A/Pos	T/Pos	Pol/Phase
	MHz	dBuV/m	dBuV/m	dB	dBuV	Loss	Factor	Factor		cm	deg	
1	15560.64	40.47	54.00	-13.53	31.11	6.13	38.40	35.17	Average	100	294	VERTICAL
2	15571.84	53.04	74.00	-20.96	43.68	6.13	38.40	35.17	Peak	100	294	VERTICAL



<b>Temperature</b>	25°C	<b>Humidity</b>	56%
<b>Test Engineer</b>	YC Chen	<b>Configurations</b>	IEEE 802.11n MCS0 40 MHz CH 46 / Chain 1 + Chain 2
<b>Test Date</b>	Aug. 15, 2014	<b>Test Mode</b>	Mode 1

**Horizontal**

	Freq	Level	Limit Line	Over Limit	Read Level	Cable Loss	Antenna Factor	Preamp Factor	Remark	A/Pos	T/Pos	Pol/Phase
	MHz	dBuV/m	dBuV/m	dB	dBuV	dB	dB/m	dB		cm	deg	
1	15683.92	53.06	74.00	-20.94	43.90	6.14	38.23	35.21	Peak	100	227	HORIZONTAL
2	15696.68	40.09	54.00	-13.91	30.95	6.14	38.21	35.21	Average	100	227	HORIZONTAL

**Vertical**

	Freq	Level	Limit Line	Over Limit	Read Level	Cable Loss	Antenna Factor	Preamp Factor	Remark	A/Pos	T/Pos	Pol/Phase
	MHz	dBuV/m	dBuV/m	dB	dBuV	dB	dB/m	dB		cm	deg	
1	15690.36	40.03	54.00	-13.97	30.87	6.14	38.23	35.21	Average	100	338	VERTICAL
2	15694.92	52.99	74.00	-21.01	43.83	6.14	38.23	35.21	Peak	100	338	VERTICAL



<b>Temperature</b>	25°C	<b>Humidity</b>	56%
<b>Test Engineer</b>	YC Chen	<b>Configurations</b>	IEEE 802.11a 5 MHz CH 36 / Chain 1 + Chain 2
<b>Test Date</b>	Aug. 15, 2014	<b>Test Mode</b>	Mode 1

**Horizontal**

	Freq	Level	Limit Line	Over Limit	Read Level	Cable Loss	Antenna Factor	Preamp Factor	Remark	A/Pos	T/Pos	Pol/Phase
	MHz	dBuV/m	dBuV/m	dB	dBuV	dB	dB/m	dB		cm	deg	
1	15537.12	64.87	74.00	-9.13	55.46	6.13	38.45	35.17	Peak	135	306	HORIZONTAL
2	15539.00	44.97	54.00	-9.03	35.56	6.13	38.45	35.17	Average	135	306	HORIZONTAL

**Vertical**

	Freq	Level	Limit Line	Over Limit	Read Level	Cable Loss	Antenna Factor	Preamp Factor	Remark	A/Pos	T/Pos	Pol/Phase
	MHz	dBuV/m	dBuV/m	dB	dBuV	dB	dB/m	dB		cm	deg	
1	15537.96	60.56	74.00	-13.44	51.15	6.13	38.45	35.17	Peak	100	204	VERTICAL
2	15540.28	42.71	54.00	-11.29	33.30	6.13	38.45	35.17	Average	100	204	VERTICAL



<b>Temperature</b>	25°C	<b>Humidity</b>	56%
<b>Test Engineer</b>	YC Chen	<b>Configurations</b>	IEEE 802.11a 5 MHz CH 42 / Chain 1 + Chain 2
<b>Test Date</b>	Aug. 19, 2014	<b>Test Mode</b>	Mode 1

**Horizontal**

	Freq	Level	Limit	Over	Read	CableAntenna	Preamp	Remark	T/Pos	A/Pos	Pol/Phase
	MHz	dBuV/m	dBuV/m	dB	dBuV	dB	dB/m	dB	deg	cm	
1	15627.48	67.19	74.00	-6.81	55.52	7.88	38.60	34.81	Peak	99	137 HORIZONTAL
2	15629.80	46.02	54.00	-7.98	34.35	7.89	38.59	34.81	Average	99	137 HORIZONTAL

**Vertical**

	Freq	Level	Limit	Over	Read	CableAntenna	Preamp	Remark	T/Pos	A/Pos	Pol/Phase
	MHz	dBuV/m	dBuV/m	dB	dBuV	dB	dB/m	dB	deg	cm	
1	15627.72	73.22	74.00	-0.78	61.55	7.88	38.60	34.81	Peak	218	139 VERTICAL
2	15629.64	48.22	54.00	-5.78	36.55	7.89	38.59	34.81	Average	218	139 VERTICAL



<b>Temperature</b>	25°C	<b>Humidity</b>	56%
<b>Test Engineer</b>	YC Chen	<b>Configurations</b>	IEEE 802.11a 5 MHz CH 48 / Chain 1 + Chain 2
<b>Test Date</b>	Aug. 15, 2014	<b>Test Mode</b>	Mode 1

**Horizontal**

	Freq	Level	Limit Line	Over Limit	Read Level	Cable Loss	Antenna Factor	Preamp Factor	Remark	A/Pos	T/Pos	Pol/Phase
	MHz	dBuV/m	dBuV/m	dB	dBuV	dB	dB/m	dB		cm	deg	
1	15718.24	56.40	74.00	-17.60	47.28	6.14	38.19	35.21	Peak	100	105	HORIZONTAL
2	15719.64	40.99	54.00	-13.01	31.87	6.14	38.19	35.21	Average	100	105	HORIZONTAL

**Vertical**

	Freq	Level	Limit Line	Over Limit	Read Level	Cable Loss	Antenna Factor	Preamp Factor	Remark	A/Pos	T/Pos	Pol/Phase
	MHz	dBuV/m	dBuV/m	dB	dBuV	dB	dB/m	dB		cm	deg	
1	15718.76	53.32	74.00	-20.68	44.20	6.14	38.19	35.21	Peak	100	348	VERTICAL
2	15721.64	41.02	54.00	-12.98	31.90	6.14	38.19	35.21	Average	100	348	VERTICAL



<b>Temperature</b>	25°C	<b>Humidity</b>	56%
<b>Test Engineer</b>	YC Chen	<b>Configurations</b>	IEEE 802.11a 10 MHz CH 36 / Chain 1 + Chain 2
<b>Test Date</b>	Aug. 15, 2014	<b>Test Mode</b>	Mode 1

**Horizontal**

	Freq	Level	Limit	Over	Read	Cable	Antenna	Preamp	Remark	A/Pos	T/Pos	Pol/Phase
	MHz	dBuV/m	dBuV/m	dB	dBuV	Loss	Factor	Factor		cm	deg	
1	15537.96	42.95	54.00	-11.05	33.54	6.13	38.45	35.17	Average	100	313	HORIZONTAL
2	15541.96	57.82	74.00	-16.18	48.41	6.13	38.45	35.17	Peak	100	313	HORIZONTAL

**Vertical**

	Freq	Level	Limit	Over	Read	Cable	Antenna	Preamp	Remark	A/Pos	T/Pos	Pol/Phase
	MHz	dBuV/m	dBuV/m	dB	dBuV	Loss	Factor	Factor		cm	deg	
1	15541.96	41.44	54.00	-12.56	32.03	6.13	38.45	35.17	Average	100	149	VERTICAL
2	15549.72	53.49	74.00	-20.51	44.10	6.13	38.43	35.17	Peak	100	149	VERTICAL





<b>Temperature</b>	25°C	<b>Humidity</b>	56%
<b>Test Engineer</b>	YC Chen	<b>Configurations</b>	IEEE 802.11a 10 MHz CH 42 / Chain 1 + Chain 2
<b>Test Date</b>	Aug. 19, 2014	<b>Test Mode</b>	Mode 1

**Horizontal**

	Freq	Level	Limit	Over	Read	CableAntenna	Preamp		T/Pos	A/Pos	Pol/Phase
	MHz	dBuV/m	dBuV/m	dB	dBuV	Loss	Factor	Factor	deg	cm	
1	15630.06	43.84	54.00	-10.16	32.17	7.89	38.59	34.81	64	100	HORIZONTAL
2	15632.41	58.09	74.00	-15.91	46.42	7.89	38.59	34.81	64	100	HORIZONTAL

**Vertical**

	Freq	Level	Limit	Over	Read	CableAntenna	Preamp		T/Pos	A/Pos	Pol/Phase
	MHz	dBuV/m	dBuV/m	dB	dBuV	Loss	Factor	Factor	deg	cm	
1	15628.98	47.18	54.00	-6.82	35.51	7.89	38.59	34.81	231	130	VERTICAL
2	15630.48	68.01	74.00	-5.99	56.34	7.89	38.59	34.81	231	130	VERTICAL



<b>Temperature</b>	25°C	<b>Humidity</b>	56%
<b>Test Engineer</b>	YC Chen	<b>Configurations</b>	IEEE 802.11a 10 MHz CH 48 / Chain 1 + Chain 2
<b>Test Date</b>	Aug. 15, 2014	<b>Test Mode</b>	Mode 1

**Horizontal**

	Freq	Level	Limit Line	Over Limit	Read Level	Cable Loss	Antenna Factor	Preamp Factor	Remark	A/Pos	T/Pos	Pol/Phase
	MHz	dBuV/m	dBuV/m	dB	dBuV	dB	dB/m	dB		cm	deg	
1	15719.88	40.27	54.00	-13.73	31.15	6.14	38.19	35.21	Average	100	280	HORIZONTAL
2	15720.80	53.56	74.00	-20.44	44.44	6.14	38.19	35.21	Peak	100	280	HORIZONTAL

**Vertical**

	Freq	Level	Limit Line	Over Limit	Read Level	Cable Loss	Antenna Factor	Preamp Factor	Remark	A/Pos	T/Pos	Pol/Phase
	MHz	dBuV/m	dBuV/m	dB	dBuV	dB	dB/m	dB		cm	deg	
1	15714.56	53.53	74.00	-20.47	44.41	6.14	38.19	35.21	Peak	100	151	VERTICAL
2	15722.44	40.26	54.00	-13.74	31.14	6.14	38.19	35.21	Average	100	151	VERTICAL



<b>Temperature</b>	25°C	<b>Humidity</b>	56%
<b>Test Engineer</b>	YC Chen	<b>Configurations</b>	IEEE 802.11a 20 MHz CH 36 / Chain 1 + Chain 2
<b>Test Date</b>	Aug. 15, 2014	<b>Test Mode</b>	Mode 1

**Horizontal**

	Freq	Level	Limit Line	Over Limit	Read Level	Cable Loss	Antenna Factor	Preamp Factor	Remark	A/Pos	T/Pos	Pol/Phase
	MHz	dBuV/m	dBuV/m	dB	dBuV	dB	dB/m	dB		cm	deg	
1	15535.20	41.04	54.00	-12.96	31.63	6.13	38.45	35.17	Average	100	22	HORIZONTAL
2	15546.96	53.46	74.00	-20.54	44.07	6.13	38.43	35.17	Peak	100	22	HORIZONTAL

**Vertical**

	Freq	Level	Limit Line	Over Limit	Read Level	Cable Loss	Antenna Factor	Preamp Factor	Remark	A/Pos	T/Pos	Pol/Phase
	MHz	dBuV/m	dBuV/m	dB	dBuV	dB	dB/m	dB		cm	deg	
1	15536.88	54.08	74.00	-19.92	44.67	6.13	38.45	35.17	Peak	100	44	VERTICAL
2	15539.36	40.94	54.00	-13.06	31.53	6.13	38.45	35.17	Average	100	44	VERTICAL



<b>Temperature</b>	25°C	<b>Humidity</b>	56%
<b>Test Engineer</b>	YC Chen	<b>Configurations</b>	IEEE 802.11a 20 MHz CH 40 / Chain 1 + Chain 2
<b>Test Date</b>	Aug. 15, 2014	<b>Test Mode</b>	Mode 1

**Horizontal**

	Freq	Level	Limit Line	Over Limit	Read Level	Cable Loss	Antenna Factor	Preamp Factor	Remark	A/Pos	T/Pos	Pol/Phase
	MHz	dBuV/m	dBuV/m	dB	dBuV	dB	dB/m	dB		cm	deg	
1	15592.84	41.05	54.00	-12.95	31.72	6.13	38.38	35.18	Average	100	347	HORIZONTAL
2	15606.12	52.26	74.00	-21.74	42.96	6.13	38.36	35.19	Peak	100	347	HORIZONTAL

**Vertical**

	Freq	Level	Limit Line	Over Limit	Read Level	Cable Loss	Antenna Factor	Preamp Factor	Remark	A/Pos	T/Pos	Pol/Phase
	MHz	dBuV/m	dBuV/m	dB	dBuV	dB	dB/m	dB		cm	deg	
1	15603.84	39.26	54.00	-14.74	29.96	6.13	38.36	35.19	Average	100	326	VERTICAL
2	15604.44	53.58	74.00	-20.42	44.28	6.13	38.36	35.19	Peak	100	326	VERTICAL



<b>Temperature</b>	25°C	<b>Humidity</b>	56%
<b>Test Engineer</b>	YC Chen	<b>Configurations</b>	IEEE 802.11a 20 MHz CH 48 / Chain 1 + Chain 2
<b>Test Date</b>	Aug. 15, 2014	<b>Test Mode</b>	Mode 1

**Horizontal**

	Freq	Level	Limit Line	Over Limit	Read Level	Cable Loss	Antenna Factor	Preamp Factor	Remark	A/Pos	T/Pos	Pol/Phase
	MHz	dBuV/m	dBuV/m	dB	dBuV	dB	dB/m	dB		cm	deg	
1	15721.60	53.00	74.00	-21.00	43.88	6.14	38.19	35.21	Peak	100	147	HORIZONTAL
2	15721.72	40.74	54.00	-13.26	31.62	6.14	38.19	35.21	Average	100	147	HORIZONTAL

**Vertical**

	Freq	Level	Limit Line	Over Limit	Read Level	Cable Loss	Antenna Factor	Preamp Factor	Remark	A/Pos	T/Pos	Pol/Phase
	MHz	dBuV/m	dBuV/m	dB	dBuV	dB	dB/m	dB		cm	deg	
1	15712.80	54.99	74.00	-19.01	45.85	6.14	38.21	35.21	Peak	100	123	VERTICAL
2	15722.32	40.07	54.00	-13.93	30.95	6.14	38.19	35.21	Average	100	123	VERTICAL

**Note:**

The amplitude of spurious emissions that are attenuated by more than 20dB below the permissible value has no need to be reported.

Emission level (dBuV/m) = 20 log Emission level (uV/m).

Corrected Reading: Antenna Factor + Cable Loss + Read Level - Preamp Factor = Level.



<b>Temperature</b>	25°C	<b>Humidity</b>	56%
<b>Test Engineer</b>	YC Chen	<b>Configurations</b>	IEEE 802.11n MCS0 5 MHz CH 36 / Chain 1 + Chain 2
<b>Test Date</b>	Aug. 12, 2014	<b>Test Mode</b>	Mode 2

**Horizontal**

	Freq	Level	Limit Line	Over Limit	Read Level	CableAntenna Loss	Antenna Factor	Preamp Factor	Remark	A/Pos	T/Pos	Pol/Phase
	MHz	dBuV/m	dBuV/m	dB	dBuV	dB	dB/m	dB		cm	deg	
1	15536.22	67.90	74.00	-6.10	58.49	6.13	38.45	35.17	Peak	100	310	HORIZONTAL
2	15540.64	53.94	54.00	-0.06	44.53	6.13	38.45	35.17	Average	100	310	HORIZONTAL

**Vertical**

	Freq	Level	Limit Line	Over Limit	Read Level	CableAntenna Loss	Antenna Factor	Preamp Factor	Remark	A/Pos	T/Pos	Pol/Phase
	MHz	dBuV/m	dBuV/m	dB	dBuV	dB	dB/m	dB		cm	deg	
1	15540.00	52.64	54.00	-1.36	43.23	6.13	38.45	35.17	Average	106	299	VERTICAL
2	15540.64	71.75	74.00	-2.25	62.34	6.13	38.45	35.17	Peak	106	299	VERTICAL



<b>Temperature</b>	25°C	<b>Humidity</b>	56%
<b>Test Engineer</b>	YC Chen	<b>Configurations</b>	IEEE 802.11n MCS0 5 MHz CH 42 / Chain 1 + Chain 2
<b>Test Date</b>	Aug. 18, 2014	<b>Test Mode</b>	Mode 2

**Horizontal**

	Freq	Level	Limit	Over	Read	CableAntenna	Preamp	Remark	T/Pos	A/Pos	Pol/Phase	
	MHz	dBuV/m	dBuV/m	dB	dBuV	dB	dB/m	dB	deg	cm		
1	15627.28	73.25	74.00	-0.75	61.58	7.88	38.60	34.81	Peak	340	154	HORIZONTAL
2	15630.80	53.93	54.00	-0.07	42.26	7.89	38.59	34.81	Average	340	154	HORIZONTAL

**Vertical**

	Freq	Level	Limit	Over	Read	CableAntenna	Preamp	Remark	T/Pos	A/Pos	Pol/Phase	
	MHz	dBuV/m	dBuV/m	dB	dBuV	dB	dB/m	dB	deg	cm		
1	15630.16	53.44	54.00	-0.56	41.77	7.89	38.59	34.81	Average	50	122	VERTICAL
2	15630.24	71.57	74.00	-2.43	59.90	7.89	38.59	34.81	Peak	50	122	VERTICAL



<b>Temperature</b>	25°C	<b>Humidity</b>	56%
<b>Test Engineer</b>	YC Chen	<b>Configurations</b>	IEEE 802.11n MCS0 5 MHz CH 48 / Chain 1 + Chain 2
<b>Test Date</b>	Aug. 12, 2014	<b>Test Mode</b>	Mode 2

**Horizontal**

	Freq	Level	Limit Line	Over Limit	Read Level	Cable Loss	Antenna Factor	Preamp Factor	Remark	A/Pos	T/Pos	Pol/Phase
	MHz	dBuV/m	dBuV/m	dB	dBuV	dB	dB/m	dB		cm	deg	
1	15719.87	53.86	54.00	-0.14	44.74	6.14	38.19	35.21	Average	100	306	HORIZONTAL
2	15722.53	72.24	74.00	-1.76	63.12	6.14	38.19	35.21	Peak	100	306	HORIZONTAL

**Vertical**

	Freq	Level	Limit Line	Over Limit	Read Level	Cable Loss	Antenna Factor	Preamp Factor	Remark	A/Pos	T/Pos	Pol/Phase
	MHz	dBuV/m	dBuV/m	dB	dBuV	dB	dB/m	dB		cm	deg	
1	15715.93	70.54	74.00	-3.46	61.42	6.14	38.19	35.21	Peak	100	297	VERTICAL
2	15718.46	53.02	54.00	-0.98	43.90	6.14	38.19	35.21	Average	100	297	VERTICAL





<b>Temperature</b>	25°C	<b>Humidity</b>	56%
<b>Test Engineer</b>	YC Chen	<b>Configurations</b>	IEEE 802.11n MCS0 10 MHz CH 36 / Chain 1 + Chain 2
<b>Test Date</b>	Aug. 15, 2014	<b>Test Mode</b>	Mode 2

**Horizontal**

	Freq	Level	Limit Line	Over Limit	Read Level	Cable Loss	Antenna Factor	Preamp Factor	Remark	A/Pos	T/Pos	Pol/Phase
	MHz	dBuV/m	dBuV/m	dB	dBuV	dB	dB/m	dB		cm	deg	
1	15538.12	50.89	54.00	-3.11	41.48	6.13	38.45	35.17	Average	100	352	HORIZONTAL
2	15538.12	59.90	74.00	-14.10	50.49	6.13	38.45	35.17	Peak	100	352	HORIZONTAL

**Vertical**

	Freq	Level	Limit Line	Over Limit	Read Level	Cable Loss	Antenna Factor	Preamp Factor	Remark	A/Pos	T/Pos	Pol/Phase
	MHz	dBuV/m	dBuV/m	dB	dBuV	dB	dB/m	dB		cm	deg	
1	15537.76	50.88	54.00	-3.12	41.47	6.13	38.45	35.17	Average	138	16	VERTICAL
2	15549.08	68.64	74.00	-5.36	59.25	6.13	38.43	35.17	Peak	138	16	VERTICAL



<b>Temperature</b>	25°C	<b>Humidity</b>	56%
<b>Test Engineer</b>	YC Chen	<b>Configurations</b>	IEEE 802.11n MCS0 10 MHz CH 42 / Chain 1 + Chain 2
<b>Test Date</b>	Aug. 18, 2014	<b>Test Mode</b>	Mode 2

**Horizontal**

	Freq	Level	Limit Line	Over Limit	Read Level	CableAntenna Loss	Antenna Factor	Preamp Factor	Remark	T/Pos	A/Pos	Pol/Phase
	MHz	dBuV/m	dBuV/m	dB	dBuV	dB	dB/m	dB		deg	cm	
1	15627.06	70.81	74.00	-3.19	59.14	7.88	38.60	34.81	Peak	341	100	HORIZONTAL
2	15628.14	53.77	54.00	-0.23	42.10	7.88	38.60	34.81	Average	341	100	HORIZONTAL

**Vertical**

	Freq	Level	Limit Line	Over Limit	Read Level	CableAntenna Loss	Antenna Factor	Preamp Factor	Remark	T/Pos	A/Pos	Pol/Phase
	MHz	dBuV/m	dBuV/m	dB	dBuV	dB	dB/m	dB		deg	cm	
1	15626.16	68.87	74.00	-5.13	57.20	7.88	38.60	34.81	Peak	46	120	VERTICAL
2	15630.00	51.56	54.00	-2.44	39.89	7.89	38.59	34.81	Average	46	120	VERTICAL



<b>Temperature</b>	25°C	<b>Humidity</b>	56%
<b>Test Engineer</b>	YC Chen	<b>Configurations</b>	IEEE 802.11n MCS0 10 MHz CH 48 / Chain 1 + Chain 2
<b>Test Date</b>	Aug. 15, 2014	<b>Test Mode</b>	Mode 2

**Horizontal**

	Freq	Level	Limit Line	Over Limit	Read Level	Cable Loss	Antenna Factor	Preamp Factor	Remark	A/Pos	T/Pos	Pol/Phase
	MHz	dBuV/m	dBuV/m	dB	dBuV	dB	dB/m	dB		cm	deg	
1	15721.52	49.67	54.00	-4.33	40.55	6.14	38.19	35.21	Average	117	36	HORIZONTAL
2	15722.00	66.45	74.00	-7.55	57.33	6.14	38.19	35.21	Peak	117	36	HORIZONTAL

**Vertical**

	Freq	Level	Limit Line	Over Limit	Read Level	Cable Loss	Antenna Factor	Preamp Factor	Remark	A/Pos	T/Pos	Pol/Phase
	MHz	dBuV/m	dBuV/m	dB	dBuV	dB	dB/m	dB		cm	deg	
1	15721.52	49.55	54.00	-4.45	40.43	6.14	38.19	35.21	Average	165	346	VERTICAL
2	15725.44	66.38	74.00	-7.62	57.26	6.14	38.19	35.21	Peak	165	346	VERTICAL



<b>Temperature</b>	25°C	<b>Humidity</b>	56%
<b>Test Engineer</b>	YC Chen	<b>Configurations</b>	IEEE 802.11n MCS0 20 MHz CH 36 / Chain 1 + Chain 2
<b>Test Date</b>	Aug. 14, 2014	<b>Test Mode</b>	Mode 2

**Horizontal**

	Freq	Level	Limit Line	Over Limit	Read Level	CableAntenna Loss	Antenna Factor	Preamp Factor	Remark	T/Pos	A/Pos	Pol/Phase
	MHz	dBuV/m	dBuV/m	dB	dBuV	dB	dB/m	dB		deg	cm	
1	15536.70	62.56	74.00	-11.44	50.76	7.85	38.67	34.72	Peak	345	100	HORIZONTAL
2	15537.50	45.81	54.00	-8.19	34.01	7.85	38.67	34.72	Average	345	100	HORIZONTAL

**Vertical**

	Freq	Level	Limit Line	Over Limit	Read Level	CableAntenna Loss	Antenna Factor	Preamp Factor	Remark	T/Pos	A/Pos	Pol/Phase
	MHz	dBuV/m	dBuV/m	dB	dBuV	dB	dB/m	dB		deg	cm	
1	15539.10	44.32	54.00	-9.68	32.52	7.85	38.67	34.72	Average	176	100	VERTICAL
2	15545.90	56.88	74.00	-17.12	45.08	7.86	38.66	34.72	Peak	176	100	VERTICAL



<b>Temperature</b>	25°C	<b>Humidity</b>	56%
<b>Test Engineer</b>	YC Chen	<b>Configurations</b>	IEEE 802.11n MCS0 20 MHz CH 40 / Chain 1 + Chain 2
<b>Test Date</b>	Aug. 14, 2014	<b>Test Mode</b>	Mode 2

**Horizontal**

	Freq	Level	Limit Line	Over Limit	Read Level	CableAntenna Loss	Antenna Factor	Preamp Factor	Remark	T/Pos	A/Pos	Pol/Phase
	MHz	dBuV/m	dBuV/m	dB	dBuV	dB	dB/m	dB		deg	cm	
1	15598.00	49.57	54.00	-4.43	37.84	7.88	38.62	34.77	Average	342	165	HORIZONTAL
2	15608.70	63.91	74.00	-10.09	52.20	7.88	38.62	34.79	Peak	342	165	HORIZONTAL

**Vertical**

	Freq	Level	Limit Line	Over Limit	Read Level	CableAntenna Loss	Antenna Factor	Preamp Factor	Remark	T/Pos	A/Pos	Pol/Phase
	MHz	dBuV/m	dBuV/m	dB	dBuV	dB	dB/m	dB		deg	cm	
1	15597.50	47.08	54.00	-6.92	35.35	7.88	38.62	34.77	Average	140	100	VERTICAL
2	15599.10	64.22	74.00	-9.78	52.51	7.88	38.62	34.79	Peak	140	100	VERTICAL



<b>Temperature</b>	25°C	<b>Humidity</b>	56%
<b>Test Engineer</b>	YC Chen	<b>Configurations</b>	IEEE 802.11n MCS0 20 MHz CH 48 / Chain 1 + Chain 2
<b>Test Date</b>	Aug. 14, 2014	<b>Test Mode</b>	Mode 2

**Horizontal**

	Freq	Level	Limit Line	Over Limit	Read Level	CableAntenna Loss	Antenna Factor	Preamp Factor	Remark	T/Pos	A/Pos	Pol/Phase
	MHz	dBuV/m	dBuV/m	dB	dBuV	dB	dB/m	dB		deg	cm	
1	15721.80	50.16	54.00	-3.84	38.60	7.92	38.52	34.88	Average	343	114	HORIZONTAL
2	15723.40	64.65	74.00	-9.35	53.09	7.92	38.52	34.88	Peak	343	114	HORIZONTAL

**Vertical**

	Freq	Level	Limit Line	Over Limit	Read Level	CableAntenna Loss	Antenna Factor	Preamp Factor	Remark	T/Pos	A/Pos	Pol/Phase
	MHz	dBuV/m	dBuV/m	dB	dBuV	dB	dB/m	dB		deg	cm	
1	15717.70	50.05	54.00	-3.95	38.49	7.92	38.52	34.88	Average	136	118	VERTICAL
2	15719.30	65.01	74.00	-8.99	53.45	7.92	38.52	34.88	Peak	136	118	VERTICAL



<b>Temperature</b>	25°C	<b>Humidity</b>	56%
<b>Test Engineer</b>	YC Chen	<b>Configurations</b>	IEEE 802.11n MCS0 40 MHz CH 38 / Chain 1 + Chain 2
<b>Test Date</b>	Aug. 14, 2014	<b>Test Mode</b>	Mode 2

**Horizontal**

	Freq	Level	Limit	Over	Read	CableAntenna	Preamp	Remark	T/Pos	A/Pos	Pol/Phase
	MHz	dBuV/m	dBuV/m	dB	dBuV	dB	dB/m	dB	deg	cm	
1	15549.90	43.85	54.00	-10.15	32.07	7.86	38.66	34.74	Average	145	100 HORIZONTAL
2	15556.40	56.85	74.00	-17.15	45.07	7.86	38.66	34.74	Peak	145	100 HORIZONTAL

**Vertical**

	Freq	Level	Limit	Over	Read	CableAntenna	Preamp	Remark	T/Pos	A/Pos	Pol/Phase
	MHz	dBuV/m	dBuV/m	dB	dBuV	dB	dB/m	dB	deg	cm	
1	15545.30	56.46	74.00	-17.54	44.66	7.86	38.66	34.72	Peak	327	100 VERTICAL
2	15546.90	43.95	54.00	-10.05	32.15	7.86	38.66	34.72	Average	327	100 VERTICAL



<b>Temperature</b>	25°C	<b>Humidity</b>	56%
<b>Test Engineer</b>	YC Chen	<b>Configurations</b>	IEEE 802.11n MCS0 40 MHz CH 46 / Chain 1 + Chain 2
<b>Test Date</b>	Aug. 14, 2014	<b>Test Mode</b>	Mode 2

**Horizontal**

	Freq	Level	Limit	Over	Read	CableAntenna	Preamp	Remark	T/Pos	A/Pos	Pol/Phase
	MHz	dBuV/m	dBuV/m	dB	dBuV	dB	dB/m	dB	deg	cm	
1	15679.70	60.29	74.00	-13.71	48.69	7.90	38.55	34.85 Peak	343	107	HORIZONTAL
2	15681.50	47.78	54.00	-6.22	36.18	7.90	38.55	34.85 Average	343	107	HORIZONTAL

**Vertical**

	Freq	Level	Limit	Over	Read	CableAntenna	Preamp	Remark	T/Pos	A/Pos	Pol/Phase
	MHz	dBuV/m	dBuV/m	dB	dBuV	dB	dB/m	dB	deg	cm	
1	15689.80	45.37	54.00	-8.63	33.77	7.90	38.55	34.85 Average	133	100	VERTICAL
2	15690.20	60.11	74.00	-13.89	48.51	7.90	38.55	34.85 Peak	133	100	VERTICAL





<b>Temperature</b>	25°C	<b>Humidity</b>	56%
<b>Test Engineer</b>	YC Chen	<b>Configurations</b>	IEEE 802.11a 5 MHz CH 36 / Chain 1 + Chain 2
<b>Test Date</b>	Aug. 12, 2014	<b>Test Mode</b>	Mode 2

**Horizontal**

	Freq	Level	Limit Line	Over Limit	Read Level	Cable Loss	Antenna Factor	Preamp Factor	Remark	A/Pos	T/Pos	Pol/Phase
	MHz	dBuV/m	dBuV/m	dB	dBuV	dB	dB/m	dB		cm	deg	
1	15539.26	52.21	54.00	-1.79	42.80	6.13	38.45	35.17	Average	100	253	HORIZONTAL
2	15540.00	69.45	74.00	-4.55	60.04	6.13	38.45	35.17	Peak	100	253	HORIZONTAL

**Vertical**

	Freq	Level	Limit Line	Over Limit	Read Level	Cable Loss	Antenna Factor	Preamp Factor	Remark	A/Pos	T/Pos	Pol/Phase
	MHz	dBuV/m	dBuV/m	dB	dBuV	dB	dB/m	dB		cm	deg	
1	15538.56	70.89	74.00	-3.11	61.48	6.13	38.45	35.17	Peak	138	298	VERTICAL
2	15540.35	53.23	54.00	-0.77	43.82	6.13	38.45	35.17	Average	138	298	VERTICAL



<b>Temperature</b>	25°C	<b>Humidity</b>	56%
<b>Test Engineer</b>	YC Chen	<b>Configurations</b>	IEEE 802.11a 5 MHz CH 42 / Chain 1 + Chain 2
<b>Test Date</b>	Aug. 18, 2014	<b>Test Mode</b>	Mode 2

**Horizontal**

	Freq	Level	Limit Line	Over Limit	Read Level	CableAntenna Loss	Antenna Factor	Preamp Factor	Remark	T/Pos	A/Pos	Pol/Phase
	MHz	dBuV/m	dBuV/m	dB	dBuV	dB	dB/m	dB		deg	cm	
1	15628.96	53.09	54.00	-0.91	41.42	7.89	38.59	34.81	Average	340	155	HORIZONTAL
2	15629.60	71.29	74.00	-2.71	59.62	7.89	38.59	34.81	Peak	340	155	HORIZONTAL

**Vertical**

	Freq	Level	Limit Line	Over Limit	Read Level	CableAntenna Loss	Antenna Factor	Preamp Factor	Remark	T/Pos	A/Pos	Pol/Phase
	MHz	dBuV/m	dBuV/m	dB	dBuV	dB	dB/m	dB		deg	cm	
1	15628.00	69.43	74.00	-4.57	57.76	7.88	38.60	34.81	Peak	257	117	VERTICAL
2	15629.28	53.42	54.00	-0.58	41.75	7.89	38.59	34.81	Average	257	117	VERTICAL



<b>Temperature</b>	25°C	<b>Humidity</b>	56%
<b>Test Engineer</b>	YC Chen	<b>Configurations</b>	IEEE 802.11a 5 MHz CH 48 / Chain 1 + Chain 2
<b>Test Date</b>	Aug. 12, 2014	<b>Test Mode</b>	Mode 2

**Horizontal**

	Freq	Level	Limit Line	Over Limit	Read Level	Cable Loss	Antenna Factor	Preamp Factor	Remark	A/Pos	T/Pos	Pol/Phase
	MHz	dBuV/m	dBuV/m	dB	dBuV	dB	dB/m	dB		cm	deg	
1	15719.23	67.28	74.00	-6.72	58.16	6.14	38.19	35.21	Peak	100	257	HORIZONTAL
2	15719.49	49.89	54.00	-4.11	40.77	6.14	38.19	35.21	Average	100	257	HORIZONTAL

**Vertical**

	Freq	Level	Limit Line	Over Limit	Read Level	Cable Loss	Antenna Factor	Preamp Factor	Remark	A/Pos	T/Pos	Pol/Phase
	MHz	dBuV/m	dBuV/m	dB	dBuV	dB	dB/m	dB		cm	deg	
1	15719.81	53.86	54.00	-0.14	44.74	6.14	38.19	35.21	Average	140	287	VERTICAL
2	15720.58	72.45	74.00	-1.55	63.33	6.14	38.19	35.21	Peak	140	287	VERTICAL



<b>Temperature</b>	25°C	<b>Humidity</b>	56%
<b>Test Engineer</b>	YC Chen	<b>Configurations</b>	IEEE 802.11a 10 MHz CH 36 / Chain 1 + Chain 2
<b>Test Date</b>	Aug. 12, 2014	<b>Test Mode</b>	Mode 2

**Horizontal**

	Freq	Level	Limit Line	Over Limit	Read Level	Cable Loss	Antenna Factor	Preamp Factor	Remark	A/Pos	T/Pos	Pol/Phase
	MHz	dBuV/m	dBuV/m	dB	dBuV	dB	dB/m	dB		cm	deg	
1	15538.78	53.56	54.00	-0.44	44.15	6.13	38.45	35.17	Average	101	312	HORIZONTAL
2	15542.50	68.99	74.00	-5.01	59.58	6.13	38.45	35.17	Peak	101	312	HORIZONTAL

**Vertical**

	Freq	Level	Limit Line	Over Limit	Read Level	Cable Loss	Antenna Factor	Preamp Factor	Remark	A/Pos	T/Pos	Pol/Phase
	MHz	dBuV/m	dBuV/m	dB	dBuV	dB	dB/m	dB		cm	deg	
1	15535.74	69.27	74.00	-4.73	59.86	6.13	38.45	35.17	Peak	125	298	VERTICAL
2	15539.01	51.92	54.00	-2.08	42.51	6.13	38.45	35.17	Average	125	298	VERTICAL



<b>Temperature</b>	25°C	<b>Humidity</b>	56%
<b>Test Engineer</b>	YC Chen	<b>Configurations</b>	IEEE 802.11a 10 MHz CH 42 / Chain 1 + Chain 2
<b>Test Date</b>	Aug. 18, 2014	<b>Test Mode</b>	Mode 2

**Horizontal**

	Freq	Level	Limit	Over	Read	CableAntenna	Preamp	Remark	T/Pos	A/Pos	Pol/Phase
	MHz	dBuV/m	dBuV/m	dB	dBuV	dB	dB/m	dB	deg	cm	
1	15626.46	71.14	74.00	-2.86	59.47	7.88	38.60	34.81	Peak	342	100 HORIZONTAL
2	15628.86	53.80	54.00	-0.20	42.13	7.89	38.59	34.81	Average	342	100 HORIZONTAL

**Vertical**

	Freq	Level	Limit	Over	Read	CableAntenna	Preamp	Remark	T/Pos	A/Pos	Pol/Phase
	MHz	dBuV/m	dBuV/m	dB	dBuV	dB	dB/m	dB	deg	cm	
1	15628.92	69.06	74.00	-4.94	57.39	7.89	38.59	34.81	Peak	259	116 VERTICAL
2	15631.32	52.64	54.00	-1.36	40.97	7.89	38.59	34.81	Average	259	116 VERTICAL



<b>Temperature</b>	25°C	<b>Humidity</b>	56%
<b>Test Engineer</b>	YC Chen	<b>Configurations</b>	IEEE 802.11a 10 MHz CH 48 / Chain 1 + Chain 2
<b>Test Date</b>	Aug. 12, 2014	<b>Test Mode</b>	Mode 2

**Horizontal**

	Freq	Level	Limit	Over	Read	Cable	Antenna	Preamp	Remark	A/Pos	T/Pos	Pol/Phase
	MHz	dBuV/m	dBuV/m	dB	dBuV	Loss	Factor	Factor		cm	deg	
1	15720.51	51.93	54.00	-2.07	42.81	6.14	38.19	35.21	Average	100	315	HORIZONTAL
2	15720.74	68.02	74.00	-5.98	58.90	6.14	38.19	35.21	Peak	100	315	HORIZONTAL

**Vertical**

	Freq	Level	Limit	Over	Read	Cable	Antenna	Preamp	Remark	A/Pos	T/Pos	Pol/Phase
	MHz	dBuV/m	dBuV/m	dB	dBuV	Loss	Factor	Factor		cm	deg	
1	15720.67	48.99	54.00	-5.01	39.87	6.14	38.19	35.21	Average	100	302	VERTICAL
2	15722.69	64.47	74.00	-9.53	55.35	6.14	38.19	35.21	Peak	100	302	VERTICAL



<b>Temperature</b>	25°C	<b>Humidity</b>	56%
<b>Test Engineer</b>	YC Chen	<b>Configurations</b>	IEEE 802.11a 20 MHz CH 36 / Chain 1 + Chain 2
<b>Test Date</b>	Aug. 14, 2014	<b>Test Mode</b>	Mode 2

**Horizontal**

	Freq	Level	Limit	Over	Read	CableAntenna	Preamp		T/Pos	A/Pos	Pol/Phase
	MHz	dBuV/m	dBuV/m	dB	dBuV	dB	dB/m	dB	deg	cm	
1	15537.50	44.48	54.00	-9.52	32.68	7.85	38.67	34.72	Average	47	100 HORIZONTAL
2	15544.70	60.02	74.00	-13.98	48.22	7.86	38.66	34.72	Peak	47	100 HORIZONTAL

**Vertical**

	Freq	Level	Limit	Over	Read	CableAntenna	Preamp		T/Pos	A/Pos	Pol/Phase
	MHz	dBuV/m	dBuV/m	dB	dBuV	dB	dB/m	dB	deg	cm	
1	15537.80	45.15	54.00	-8.85	33.35	7.85	38.67	34.72	Average	346	100 VERTICAL
2	15541.10	61.70	74.00	-12.30	49.90	7.85	38.67	34.72	Peak	346	100 VERTICAL



<b>Temperature</b>	25°C	<b>Humidity</b>	56%
<b>Test Engineer</b>	YC Chen	<b>Configurations</b>	IEEE 802.11a 20 MHz CH 40 / Chain 1 + Chain 2
<b>Test Date</b>	Aug. 14, 2014	<b>Test Mode</b>	Mode 2

**Horizontal**

	Freq	Level	Limit	Over	Read	CableAntenna	Preamp	Remark	T/Pos	A/Pos	Pol/Phase
	MHz	dBuV/m	dBuV/m	dB	dBuV	dB	dB/m	dB	deg	cm	
1	15597.60	50.89	54.00	-3.11	39.16	7.88	38.62	34.77 Average	343	164	HORIZONTAL
2	15603.00	63.66	74.00	-10.34	51.95	7.88	38.62	34.79 Peak	343	164	HORIZONTAL

**Vertical**

	Freq	Level	Limit	Over	Read	CableAntenna	Preamp	Remark	T/Pos	A/Pos	Pol/Phase
	MHz	dBuV/m	dBuV/m	dB	dBuV	dB	dB/m	dB	deg	cm	
1	15575.10	44.39	54.00	-9.61	32.66	7.86	38.64	34.77 Average	312	100	VERTICAL
2	15587.00	57.23	74.00	-16.77	45.50	7.87	38.63	34.77 Peak	312	100	VERTICAL



<b>Temperature</b>	25°C	<b>Humidity</b>	56%
<b>Test Engineer</b>	YC Chen	<b>Configurations</b>	IEEE 802.11a 20 MHz CH 48 / Chain 1 + Chain 2
<b>Test Date</b>	Aug. 14, 2014	<b>Test Mode</b>	Mode 2

#### Horizontal

	Freq	Level	Limit	Over	Read	CableAntenna	Preamp	Remark	T/Pos	A/Pos	Pol/Phase
	MHz	dBuV/m	dBuV/m	dB	dBuV	dB	dB/m	dB	deg	cm	
1	15714.30	62.22	74.00	-11.78	50.66	7.92	38.52	34.88	Peak	344	107 HORIZONTAL
2	15715.00	48.89	54.00	-5.11	37.33	7.92	38.52	34.88	Average	344	107 HORIZONTAL

#### Vertical

	Freq	Level	Limit	Over	Read	CableAntenna	Preamp	Remark	T/Pos	A/Pos	Pol/Phase
	MHz	dBuV/m	dBuV/m	dB	dBuV	dB	dB/m	dB	deg	cm	
1	15719.50	50.01	54.00	-3.99	38.45	7.92	38.52	34.88	Average	137	125 VERTICAL
2	15727.60	65.08	74.00	-8.92	53.54	7.92	38.52	34.90	Peak	137	125 VERTICAL

#### Note:

The amplitude of spurious emissions that are attenuated by more than 20dB below the permissible value has no need to be reported.

Emission level (dBuV/m) = 20 log Emission level (uV/m).

Corrected Reading: Antenna Factor + Cable Loss + Read Level - Preamp Factor = Level.



<b>Temperature</b>	25°C	<b>Humidity</b>	56%
<b>Test Engineer</b>	YC Chen	<b>Configurations</b>	IEEE 802.11n MCS0 5 MHz CH 36 / Chain 1 + Chain 2
<b>Test Date</b>	Aug. 08, 2014	<b>Test Mode</b>	Mode 3

**Horizontal**

	Freq	Level	Limit Line	Over Limit	Read Level	CableAntenna Loss	Antenna Factor	Preamp Factor	Remark	A/Pos	T/Pos	Pol/Phase
	MHz	dBuV/m	dBuV/m	dB	dBuV	dB	dB/m	dB		cm	deg	
1	15538.21	64.91	74.00	-9.09	51.61	10.77	38.12	35.59	Peak	142	243	HORIZONTAL
2	15538.81	50.79	54.00	-3.21	37.49	10.77	38.12	35.59	Average	142	243	HORIZONTAL

**Vertical**

	Freq	Level	Limit Line	Over Limit	Read Level	CableAntenna Loss	Antenna Factor	Preamp Factor	Remark	A/Pos	T/Pos	Pol/Phase
	MHz	dBuV/m	dBuV/m	dB	dBuV	dB	dB/m	dB		cm	deg	
1	15538.94	53.75	54.00	-0.25	40.45	10.77	38.12	35.59	Average	118	61	VERTICAL
2	15541.40	69.11	74.00	-4.89	55.81	10.77	38.12	35.59	Peak	118	61	VERTICAL



<b>Temperature</b>	25°C	<b>Humidity</b>	56%
<b>Test Engineer</b>	YC Chen	<b>Configurations</b>	IEEE 802.11n MCS0 5 MHz CH 42 / Chain 1 + Chain 2
<b>Test Date</b>	Aug. 18, 2014	<b>Test Mode</b>	Mode 3

**Horizontal**

	Freq	Level	Limit Line	Over Limit	Read Level	CableAntenna Loss	Antenna Factor	Preamp Factor	Remark	T/Pos	A/Pos	Pol/Phase
	MHz	dBuV/m	dBuV/m	dB	dBuV	dB	dB/m	dB		deg	cm	
1	15629.90	51.77	54.00	-2.23	40.10	7.89	38.59	34.81	Average	61	191	HORIZONTAL
2	15634.20	62.97	74.00	-11.03	51.30	7.89	38.59	34.81	Peak	61	191	HORIZONTAL

**Vertical**

	Freq	Level	Limit Line	Over Limit	Read Level	CableAntenna Loss	Antenna Factor	Preamp Factor	Remark	T/Pos	A/Pos	Pol/Phase
	MHz	dBuV/m	dBuV/m	dB	dBuV	dB	dB/m	dB		deg	cm	
1	15629.60	53.98	54.00	-0.02	42.31	7.89	38.59	34.81	Average	238	129	VERTICAL
2	15634.10	71.61	74.00	-2.39	59.94	7.89	38.59	34.81	Peak	238	129	VERTICAL



<b>Temperature</b>	25°C	<b>Humidity</b>	56%
<b>Test Engineer</b>	YC Chen	<b>Configurations</b>	IEEE 802.11n MCS0 5 MHz CH 48 / Chain 1 + Chain 2
<b>Test Date</b>	Aug. 08, 2014	<b>Test Mode</b>	Mode 3

**Horizontal**

	Freq	Level	Limit Line	Over Limit	Read Level	Cable Loss	Antenna Factor	Preamp Factor	Remark	A/Pos	T/Pos	Pol/Phase
	MHz	dBuV/m	dBuV/m	dB	dBuV	dB	dB/m	dB		cm	deg	
1	15719.47	69.91	74.00	-4.09	56.83	10.79	37.85	35.56	Peak	141	17	HORIZONTAL
2	15720.07	52.96	54.00	-1.04	39.88	10.79	37.85	35.56	Average	141	17	HORIZONTAL

**Vertical**

	Freq	Level	Limit Line	Over Limit	Read Level	Cable Loss	Antenna Factor	Preamp Factor	Remark	A/Pos	T/Pos	Pol/Phase
	MHz	dBuV/m	dBuV/m	dB	dBuV	dB	dB/m	dB		cm	deg	
1	15720.04	53.47	54.00	-0.53	40.39	10.79	37.85	35.56	Average	100	252	VERTICAL
2	15720.24	71.10	74.00	-2.90	58.02	10.79	37.85	35.56	Peak	100	252	VERTICAL



<b>Temperature</b>	25°C	<b>Humidity</b>	56%
<b>Test Engineer</b>	YC Chen	<b>Configurations</b>	IEEE 802.11n MCS0 10 MHz CH 36 / Chain 1 + Chain 2
<b>Test Date</b>	Aug. 11, 2014	<b>Test Mode</b>	Mode 3

**Horizontal**

	Freq	Level	Limit Line	Over Limit	Read Level	CableAntenna Loss	Antenna Factor	Preamp Factor	Pol/Phase	A/Pos	T/Pos	Remark
	MHz	dBuV/m	dBuV/m	dB	dBuV	dB	dB/m	dB		cm	deg	
1	15537.78	65.16	74.00	-8.84	53.36	7.85	38.67	34.72	HORIZONTAL	104	74	Peak
2	15539.46	51.14	54.00	-2.86	39.34	7.85	38.67	34.72	HORIZONTAL	104	74	Average

**Vertical**

	Freq	Level	Limit Line	Over Limit	Read Level	CableAntenna Loss	Antenna Factor	Preamp Factor	Pol/Phase	A/Pos	T/Pos	Remark
	MHz	dBuV/m	dBuV/m	dB	dBuV	dB	dB/m	dB		cm	deg	
1	15535.78	69.38	74.00	-4.62	57.58	7.85	38.67	34.72	VERTICAL	174	331	Peak
2	15540.24	53.57	54.00	-0.43	41.77	7.85	38.67	34.72	VERTICAL	174	331	Average



<b>Temperature</b>	25°C	<b>Humidity</b>	56%
<b>Test Engineer</b>	YC Chen	<b>Configurations</b>	IEEE 802.11n MCS0 10 MHz CH 42 / Chain 1 + Chain 2
<b>Test Date</b>	Aug. 18, 2014	<b>Test Mode</b>	Mode 3

**Horizontal**

	Freq	Level	Limit	Over	Read	CableAntenna	Preamp	Remark	T/Pos	A/Pos	Pol/Phase	
	MHz	dBuV/m	dBuV/m	dB	dBuV	dB	dB/m	dB	deg	cm		
1	15642.20	68.14	74.00	-5.86	56.47	7.89	38.59	34.81	Peak	14	134	HORIZONTAL
2	15642.40	51.58	54.00	-2.42	39.91	7.89	38.59	34.81	Average	14	134	HORIZONTAL

**Vertical**

	Freq	Level	Limit	Over	Read	CableAntenna	Preamp	Remark	T/Pos	A/Pos	Pol/Phase	
	MHz	dBuV/m	dBuV/m	dB	dBuV	dB	dB/m	dB	deg	cm		
1	15644.60	53.44	54.00	-0.56	41.77	7.89	38.59	34.81	Average	244	131	VERTICAL
2	15650.20	72.99	74.00	-1.01	61.35	7.89	38.58	34.83	Peak	244	131	VERTICAL



<b>Temperature</b>	25°C	<b>Humidity</b>	56%
<b>Test Engineer</b>	YC Chen	<b>Configurations</b>	IEEE 802.11n MCS0 10 MHz CH 48 / Chain 1 + Chain 2
<b>Test Date</b>	Aug. 11, 2014	<b>Test Mode</b>	Mode 3

**Horizontal**

	Freq	Level	Limit Line	Over Limit	Read Level	CableAntenna Loss	Antenna Factor	Preamp Factor	Pol/Phase	A/Pos	T/Pos	Remark
	MHz	dBuV/m	dBuV/m	dB	dBuV	dB	dB/m	dB		cm	deg	
1	15719.32	52.98	54.00	-1.02	41.42	7.92	38.52	34.88	HORIZONTAL	159	26	Average
2	15723.36	65.89	74.00	-8.11	54.33	7.92	38.52	34.88	HORIZONTAL	159	26	Peak

**Vertical**

	Freq	Level	Limit Line	Over Limit	Read Level	CableAntenna Loss	Antenna Factor	Preamp Factor	Pol/Phase	A/Pos	T/Pos	Remark
	MHz	dBuV/m	dBuV/m	dB	dBuV	dB	dB/m	dB		cm	deg	
1	15719.28	53.53	54.00	-0.47	41.97	7.92	38.52	34.88	VERTICAL	160	290	Average
2	15724.92	66.97	74.00	-7.03	55.41	7.92	38.52	34.88	VERTICAL	160	290	Peak



<b>Temperature</b>	25°C	<b>Humidity</b>	56%
<b>Test Engineer</b>	YC Chen	<b>Configurations</b>	IEEE 802.11n MCS0 20 MHz CH 36 / Chain 1 + Chain 2
<b>Test Date</b>	Aug. 12, 2014	<b>Test Mode</b>	Mode 3

**Horizontal**

	Freq	Level	Limit Line	Over Limit	Read Level	Cable Loss	Antenna Factor	Preamp Factor	Remark	A/Pos	T/Pos	Pol/Phase
	MHz	dBuV/m	dBuV/m	dB	dBuV	dB	dB/m	dB		cm	deg	
1	15536.51	42.20	54.00	-11.80	32.79	6.13	38.45	35.17	Average	100	340	HORIZONTAL
2	15547.02	58.00	74.00	-16.00	48.61	6.13	38.43	35.17	Peak	100	340	HORIZONTAL

**Vertical**

	Freq	Level	Limit Line	Over Limit	Read Level	Cable Loss	Antenna Factor	Preamp Factor	Remark	A/Pos	T/Pos	Pol/Phase
	MHz	dBuV/m	dBuV/m	dB	dBuV	dB	dB/m	dB		cm	deg	
1	15533.94	42.68	54.00	-11.32	33.27	6.13	38.45	35.17	Average	100	63	VERTICAL
2	15537.05	55.22	74.00	-18.78	45.81	6.13	38.45	35.17	Peak	100	63	VERTICAL





<b>Temperature</b>	25°C	<b>Humidity</b>	56%
<b>Test Engineer</b>	YC Chen	<b>Configurations</b>	IEEE 802.11n MCS0 20 MHz CH 40 / Chain 1 + Chain 2
<b>Test Date</b>	Aug. 12, 2014	<b>Test Mode</b>	Mode 3

**Horizontal**

	Freq	Level	Limit Line	Over Limit	Read Level	Cable Loss	Antenna Factor	Preamp Factor	Remark	A/Pos	T/Pos	Pol/Phase
	MHz	dBuV/m	dBuV/m	dB	dBuV	dB	dB/m	dB		cm	deg	
1	15602.12	48.93	54.00	-5.07	39.63	6.13	38.36	35.19	Average	160	116	HORIZONTAL
2	15602.66	63.76	74.00	-10.24	54.46	6.13	38.36	35.19	Peak	160	116	HORIZONTAL

**Vertical**

	Freq	Level	Limit Line	Over Limit	Read Level	Cable Loss	Antenna Factor	Preamp Factor	Remark	A/Pos	T/Pos	Pol/Phase
	MHz	dBuV/m	dBuV/m	dB	dBuV	dB	dB/m	dB		cm	deg	
1	15604.42	49.56	54.00	-4.44	40.26	6.13	38.36	35.19	Average	149	337	VERTICAL
2	15604.55	62.12	74.00	-11.88	52.82	6.13	38.36	35.19	Peak	149	337	VERTICAL



<b>Temperature</b>	25°C	<b>Humidity</b>	56%
<b>Test Engineer</b>	YC Chen	<b>Configurations</b>	IEEE 802.11n MCS0 20 MHz CH 48 / Chain 1 + Chain 2
<b>Test Date</b>	Aug. 12, 2014	<b>Test Mode</b>	Mode 3

**Horizontal**

	Freq	Level	Limit Line	Over Limit	Read Level	Cable Loss	Antenna Factor	Preamp Factor	Remark	A/Pos	T/Pos	Pol/Phase
	MHz	dBuV/m	dBuV/m	dB	dBuV	dB	dB/m	dB		cm	deg	
1	15720.48	64.80	74.00	-9.20	55.68	6.14	38.19	35.21	Peak	152	298	HORIZONTAL
2	15720.80	50.73	54.00	-3.27	41.61	6.14	38.19	35.21	Average	152	298	HORIZONTAL

**Vertical**

	Freq	Level	Limit Line	Over Limit	Read Level	Cable Loss	Antenna Factor	Preamp Factor	Remark	A/Pos	T/Pos	Pol/Phase
	MHz	dBuV/m	dBuV/m	dB	dBuV	dB	dB/m	dB		cm	deg	
1	15718.72	65.84	74.00	-8.16	56.72	6.14	38.19	35.21	Peak	100	76	VERTICAL
2	15721.31	51.02	54.00	-2.98	41.90	6.14	38.19	35.21	Average	100	76	VERTICAL



<b>Temperature</b>	25°C	<b>Humidity</b>	56%
<b>Test Engineer</b>	YC Chen	<b>Configurations</b>	IEEE 802.11n MCS0 40 MHz CH 38 / Chain 1 + Chain 2
<b>Test Date</b>	Aug. 12, 2014	<b>Test Mode</b>	Mode 3

**Horizontal**

	Freq	Level	Limit	Over	Read	Cable	Antenna	Preamp	Remark	A/Pos	T/Pos	Pol/Phase
	MHz	dBuV/m	dBuV/m	dB	dBuV	Loss	Factor	Factor		cm	deg	
1	15569.55	38.33	54.00	-15.67	28.97	6.13	38.40	35.17	Average	100	306	HORIZONTAL
2	15569.62	52.21	74.00	-21.79	42.85	6.13	38.40	35.17	Peak	100	306	HORIZONTAL

**Vertical**

	Freq	Level	Limit	Over	Read	Cable	Antenna	Preamp	Remark	A/Pos	T/Pos	Pol/Phase
	MHz	dBuV/m	dBuV/m	dB	dBuV	Loss	Factor	Factor		cm	deg	
1	15559.87	39.51	54.00	-14.49	30.12	6.13	38.43	35.17	Average	100	329	VERTICAL
2	15578.21	51.85	74.00	-22.15	42.52	6.13	38.38	35.18	Peak	100	329	VERTICAL



<b>Temperature</b>	25°C	<b>Humidity</b>	56%
<b>Test Engineer</b>	YC Chen	<b>Configurations</b>	IEEE 802.11n MCS0 40 MHz CH 46 / Chain 1 + Chain 2
<b>Test Date</b>	Aug. 12, 2014	<b>Test Mode</b>	Mode 3

**Horizontal**

	Freq	Level	Limit Line	Over Limit	Read Level	Cable Loss	Antenna Factor	Preamp Factor	Remark	A/Pos	T/Pos	Pol/Phase
	MHz	dBuV/m	dBuV/m	dB	dBuV	dB	dB/m	dB		cm	deg	
1	15688.40	47.59	54.00	-6.41	38.43	6.14	38.23	35.21	Average	142	118	HORIZONTAL
2	15688.40	61.07	74.00	-12.93	51.91	6.14	38.23	35.21	Peak	142	118	HORIZONTAL

**Vertical**

	Freq	Level	Limit Line	Over Limit	Read Level	Cable Loss	Antenna Factor	Preamp Factor	Remark	A/Pos	T/Pos	Pol/Phase
	MHz	dBuV/m	dBuV/m	dB	dBuV	dB	dB/m	dB		cm	deg	
1	15694.68	46.23	54.00	-7.77	37.07	6.14	38.23	35.21	Average	100	59	VERTICAL
2	15705.19	60.41	74.00	-13.59	51.27	6.14	38.21	35.21	Peak	100	59	VERTICAL



<b>Temperature</b>	25°C	<b>Humidity</b>	56%
<b>Test Engineer</b>	YC Chen	<b>Configurations</b>	IEEE 802.11a 5 MHz CH 36 / Chain 1 + Chain 2
<b>Test Date</b>	Aug. 08, 2014	<b>Test Mode</b>	Mode 3

**Horizontal**

	Freq	Level	Limit Line	Over Limit	Read Level	Cable Loss	Antenna Factor	Preamp Factor	Remark	A/Pos	T/Pos	Pol/Phase
	MHz	dBuV/m	dBuV/m	dB	dBuV	dB	dB/m	dB		cm	deg	
1	15539.37	70.44	74.00	-3.56	57.14	10.77	38.12	35.59	Peak	142	242	HORIZONTAL
2	15539.39	50.55	54.00	-3.45	37.25	10.77	38.12	35.59	Average	142	242	HORIZONTAL

**Vertical**

	Freq	Level	Limit Line	Over Limit	Read Level	Cable Loss	Antenna Factor	Preamp Factor	Remark	A/Pos	T/Pos	Pol/Phase
	MHz	dBuV/m	dBuV/m	dB	dBuV	dB	dB/m	dB		cm	deg	
1	15538.73	71.74	74.00	-2.26	58.44	10.77	38.12	35.59	Peak	100	252	VERTICAL
2	15539.38	53.21	54.00	-0.79	39.91	10.77	38.12	35.59	Average	100	252	VERTICAL



<b>Temperature</b>	25°C	<b>Humidity</b>	56%
<b>Test Engineer</b>	YC Chen	<b>Configurations</b>	IEEE 802.11a 5 MHz CH 42 / Chain 1 + Chain 2
<b>Test Date</b>	Aug. 18, 2014	<b>Test Mode</b>	Mode 3

**Horizontal**

	Freq	Level	Limit	Over	Read	CableAntenna	Preamp	Remark	T/Pos	A/Pos	Pol/Phase	
	MHz	dBuV/m	dBuV/m	dB	dBuV	dB	dB/m	dB	deg	cm		
1	15627.60	67.31	74.00	-6.69	55.64	7.88	38.60	34.81	Peak	42	188	HORIZONTAL
2	15630.00	49.46	54.00	-4.54	37.79	7.89	38.59	34.81	Average	42	188	HORIZONTAL

**Vertical**

	Freq	Level	Limit	Over	Read	CableAntenna	Preamp	Remark	T/Pos	A/Pos	Pol/Phase	
	MHz	dBuV/m	dBuV/m	dB	dBuV	dB	dB/m	dB	deg	cm		
1	15629.60	72.14	74.00	-1.86	60.47	7.89	38.59	34.81	Peak	253	133	VERTICAL
2	15629.90	53.78	54.00	-0.22	42.11	7.89	38.59	34.81	Average	253	133	VERTICAL



<b>Temperature</b>	25°C	<b>Humidity</b>	56%
<b>Test Engineer</b>	YC Chen	<b>Configurations</b>	IEEE 802.11a 5 MHz CH 48 / Chain 1 + Chain 2
<b>Test Date</b>	Aug. 08, 2014	<b>Test Mode</b>	Mode 3

**Horizontal**

	Freq	Level	Limit Line	Over Limit	Read Level	Cable Loss	Antenna Factor	Preamp Factor	Remark	A/Pos	T/Pos	Pol/Phase
	MHz	dBuV/m	dBuV/m	dB	dBuV	dB	dB/m	dB		cm	deg	
1	15719.87	53.62	54.00	-0.38	40.54	10.79	37.85	35.56	Average	118	242	HORIZONTAL
2	15720.71	72.21	74.00	-1.79	59.13	10.79	37.85	35.56	Peak	118	242	HORIZONTAL

**Vertical**

	Freq	Level	Limit Line	Over Limit	Read Level	Cable Loss	Antenna Factor	Preamp Factor	Remark	A/Pos	T/Pos	Pol/Phase
	MHz	dBuV/m	dBuV/m	dB	dBuV	dB	dB/m	dB		cm	deg	
1	15720.32	53.75	54.00	-0.25	40.67	10.79	37.85	35.56	Average	100	71	VERTICAL
2	15721.61	70.71	74.00	-3.29	57.63	10.79	37.85	35.56	Peak	100	71	VERTICAL



<b>Temperature</b>	25°C	<b>Humidity</b>	56%
<b>Test Engineer</b>	YC Chen	<b>Configurations</b>	IEEE 802.11a 10 MHz CH 36 / Chain 1 + Chain 2
<b>Test Date</b>	Aug. 08, 2014	<b>Test Mode</b>	Mode 3

**Horizontal**

	Freq	Level	Limit Line	Over Limit	Read Level	CableAntenna Loss Factor	Preamp Factor	Remark	A/Pos	T/Pos	Pol/Phase
	MHz	dBuV/m	dBuV/m	dB	dBuV	dB	dB/m	dB	cm	deg	
1	15535.09	67.69	74.00	-6.31	54.36	10.77	38.15	35.59 Peak	157	115	HORIZONTAL
2	15540.09	51.70	54.00	-2.30	38.40	10.77	38.12	35.59 Average	157	115	HORIZONTAL

**Vertical**

	Freq	Level	Limit Line	Over Limit	Read Level	CableAntenna Loss Factor	Preamp Factor	Remark	A/Pos	T/Pos	Pol/Phase
	MHz	dBuV/m	dBuV/m	dB	dBuV	dB	dB/m	dB	cm	deg	
1	15540.51	53.26	54.00	-0.74	39.96	10.77	38.12	35.59 Average	100	274	VERTICAL
2	15541.87	68.97	74.00	-5.03	55.67	10.77	38.12	35.59 Peak	100	274	VERTICAL





<b>Temperature</b>	25°C	<b>Humidity</b>	56%
<b>Test Engineer</b>	YC Chen	<b>Configurations</b>	IEEE 802.11a 10 MHz CH 42 / Chain 1 + Chain 2
<b>Test Date</b>	Aug. 18, 2014	<b>Test Mode</b>	Mode 3

**Horizontal**

	Freq	Level	Limit Line	Over Limit	Read Level	CableAntenna Loss	Antenna Factor	Preamp Factor	Remark	T/Pos	A/Pos	Pol/Phase
	MHz	dBuV/m	dBuV/m	dB	dBuV	dB	dB/m	dB		deg	cm	
1	15628.70	67.50	74.00	-6.50	55.83	7.89	38.59	34.81	Peak	44	143	HORIZONTAL
2	15629.90	52.45	54.00	-1.55	40.78	7.89	38.59	34.81	Average	44	143	HORIZONTAL

**Vertical**

	Freq	Level	Limit Line	Over Limit	Read Level	CableAntenna Loss	Antenna Factor	Preamp Factor	Remark	T/Pos	A/Pos	Pol/Phase
	MHz	dBuV/m	dBuV/m	dB	dBuV	dB	dB/m	dB		deg	cm	
1	15630.70	53.93	54.00	-0.07	42.26	7.89	38.59	34.81	Average	262	149	VERTICAL
2	15632.30	71.18	74.00	-2.82	59.51	7.89	38.59	34.81	Peak	262	149	VERTICAL



<b>Temperature</b>	25°C	<b>Humidity</b>	56%
<b>Test Engineer</b>	YC Chen	<b>Configurations</b>	IEEE 802.11a 10 MHz CH 48 / Chain 1 + Chain 2
<b>Test Date</b>	Aug. 08, 2014	<b>Test Mode</b>	Mode 3

**Horizontal**

	Freq	Level	Limit Line	Over Limit	Read Level	Cable Loss	Antenna Factor	Preamp Factor	Remark	A/Pos	T/Pos	Pol/Phase
	MHz	dBuV/m	dBuV/m	dB	dBuV	dB	dB/m	dB		cm	deg	
1	15718.96	69.22	74.00	-4.78	56.14	10.79	37.85	35.56	Peak	150	15	HORIZONTAL
2	15720.14	52.99	54.00	-1.01	39.91	10.79	37.85	35.56	Average	150	15	HORIZONTAL

**Vertical**

	Freq	Level	Limit Line	Over Limit	Read Level	Cable Loss	Antenna Factor	Preamp Factor	Remark	A/Pos	T/Pos	Pol/Phase
	MHz	dBuV/m	dBuV/m	dB	dBuV	dB	dB/m	dB		cm	deg	
1	15720.32	69.70	74.00	-4.30	56.62	10.79	37.85	35.56	Peak	100	254	VERTICAL
2	15720.41	53.89	54.00	-0.11	40.81	10.79	37.85	35.56	Average	100	254	VERTICAL



<b>Temperature</b>	25°C	<b>Humidity</b>	56%
<b>Test Engineer</b>	YC Chen	<b>Configurations</b>	IEEE 802.11a 20 MHz CH 36 / Chain 1 + Chain 2
<b>Test Date</b>	Aug. 11, 2014	<b>Test Mode</b>	Mode 3

**Horizontal**

	Freq	Level	Limit Line	Over Limit	Read Level	CableAntenna Loss	Antenna Factor	Preamp Factor	Pol/Phase	A/Pos	T/Pos	Remark
	MHz	dBuV/m	dBuV/m	dB	dBuV	dB	dB/m	dB		cm	deg	
1	15536.32	61.60	74.00	-12.40	49.80	7.85	38.67	34.72	HORIZONTAL	128	237	Peak
2	15537.20	49.04	54.00	-4.96	37.24	7.85	38.67	34.72	HORIZONTAL	128	237	Average

**Vertical**

	Freq	Level	Limit Line	Over Limit	Read Level	CableAntenna Loss	Antenna Factor	Preamp Factor	Pol/Phase	A/Pos	T/Pos	Remark
	MHz	dBuV/m	dBuV/m	dB	dBuV	dB	dB/m	dB		cm	deg	
1	15534.96	53.03	54.00	-0.97	41.23	7.85	38.67	34.72	VERTICAL	141	247	Average
2	15537.48	67.04	74.00	-6.96	55.24	7.85	38.67	34.72	VERTICAL	141	247	Peak



<b>Temperature</b>	25°C	<b>Humidity</b>	56%
<b>Test Engineer</b>	YC Chen	<b>Configurations</b>	IEEE 802.11a 20 MHz CH 40 / Chain 1 + Chain 2
<b>Test Date</b>	Aug. 11, 2014	<b>Test Mode</b>	Mode 3

**Horizontal**

	Freq	Level	Limit Line	Over Limit	Read Level	CableAntenna Loss	Antenna Factor	Preamp Factor	Pol/Phase	A/Pos	T/Pos	Remark
	MHz	dBuV/m	dBuV/m	dB	dBuV	dB	dB/m	dB		cm	deg	
1	15597.40	63.78	74.00	-10.22	52.05	7.88	38.62	34.77	HORIZONTAL	134	224	Peak
2	15598.20	51.58	54.00	-2.42	39.85	7.88	38.62	34.77	HORIZONTAL	134	224	Average

**Vertical**

	Freq	Level	Limit Line	Over Limit	Read Level	CableAntenna Loss	Antenna Factor	Preamp Factor	Pol/Phase	A/Pos	T/Pos	Remark
	MHz	dBuV/m	dBuV/m	dB	dBuV	dB	dB/m	dB		cm	deg	
1	15594.50	66.19	74.00	-7.81	54.46	7.87	38.63	34.77	VERTICAL	161	287	Peak
2	15601.50	53.18	54.00	-0.82	41.47	7.88	38.62	34.79	VERTICAL	161	287	Average

<b>Temperature</b>	25°C	<b>Humidity</b>	56%
<b>Test Engineer</b>	YC Chen	<b>Configurations</b>	IEEE 802.11a 20 MHz CH 48 / Chain 1 + Chain 2
<b>Test Date</b>	Aug. 11, 2014	<b>Test Mode</b>	Mode 3

#### Horizontal

	Freq	Level	Limit Line	Over Limit	Read Level	CableAntenna Loss	Antenna Factor	Preamp Factor	Pol/Phase	A/Pos	T/Pos	Remark
	MHz	dBuV/m	dBuV/m	dB	dBuV	dB	dB/m	dB		cm	deg	
1	15721.20	51.07	54.00	-2.93	39.51	7.92	38.52	34.88	HORIZONTAL	140	229	Average
2	15730.50	63.63	74.00	-10.37	52.09	7.92	38.52	34.90	HORIZONTAL	140	229	Peak

#### Vertical

	Freq	Level	Limit Line	Over Limit	Read Level	CableAntenna Loss	Antenna Factor	Preamp Factor	Pol/Phase	A/Pos	T/Pos	Remark
	MHz	dBuV/m	dBuV/m	dB	dBuV	dB	dB/m	dB		cm	deg	
1	15716.30	65.94	74.00	-8.06	54.38	7.92	38.52	34.88	VERTICAL	142	238	Peak
2	15720.40	53.41	54.00	-0.59	41.85	7.92	38.52	34.88	VERTICAL	142	238	Average

#### Note:

The amplitude of spurious emissions that are attenuated by more than 20dB below the permissible value has no need to be reported.

Emission level (dBuV/m) = 20 log Emission level (uV/m).

Corrected Reading: Antenna Factor + Cable Loss + Read Level - Preamp Factor = Level.

## 4.5. Band Edge Emissions Measurement

### 4.5.1. Limit

For transmitters operating in the 5.15-5.25 GHz band: all emissions outside of the 5.15-5.25 GHz band shall not exceed an e.i.r.p. of  $-27$  dBm/MHz.

In addition, In case the emission fall within the restricted band specified on 15.205(a), then the 15.209(a) limit in the table below has to be followed.

Frequencies (MHz)	Field Strength (microvolts/meter)	Measurement Distance (meters)
0.009~0.490	2400/F(kHz)	300
0.490~1.705	24000/F(kHz)	30
1.705~30.0	30	30
30~88	100	3
88~216	150	3
216~960	200	3
Above 960	500	3

### 4.5.2. Measuring Instruments and Setting

Please refer to section 5 of equipments list in this report. The following table is the setting of the spectrum analyzer.

Spectrum Parameter	Setting
Attenuation	Auto
Span Frequency	100 MHz
RBW / VBW (Emission in restricted band)	1 MHz / 3MHz for Peak, 1 MHz / 1/T for Average
RBW / VBW (Emission in non-restricted band)	1 MHz / 3MHz for Peak

### 4.5.3. Test Procedures

- The test procedure is the same as section 4.4.3, only the frequency range investigated is limited to 100MHz around bandedges.

### 4.5.4. Test Setup Layout

This test setup layout is the same as that shown in section 4.4.4.

### 4.5.5. Test Deviation

There is no deviation with the original standard.

### 4.5.6. EUT Operation during Test

The EUT was programmed to be in continuously transmitting mode.

#### 4.5.7. Test Result of Band Edge and Fundamental Emissions

<b>Temperature</b>	25°C	<b>Humidity</b>	56%
<b>Test Engineer</b>	YC Chen	<b>Configurations</b>	IEEE 802.11n MCS0 5 MHz CH 36, 42, 48 / Chain 1 + Chain 2
<b>Test Date</b>	Aug. 15, 2014 ~ Aug. 19, 2014	<b>Test Mode</b>	Mode 1

##### Channel 36

	Freq	Level	Limit Line	Over Limit	Read Level	Cable Loss	Antenna Factor	Preamp Factor	Remark	A/Pos	T/Pos	Pol/Phase
	MHz	dBuV/m	dBuV/m	dB	dBuV	dB	dB/m	dB		cm	deg	
1	5008.00	51.53	54.00	-2.47	49.12	3.39	33.92	34.90	Average	100	17	VERTICAL
2	5102.00	64.16	74.00	-9.84	61.60	3.42	34.04	34.90	Peak	100	17	VERTICAL
3	5178.00	108.13			105.44	3.44	34.16	34.91	Average	100	17	VERTICAL
4	5182.00	118.44			115.75	3.44	34.16	34.91	Peak	100	17	VERTICAL

Item 3, 4 are the fundamental frequency at 5180 MHz.

##### Channel 42

	Freq	Level	Limit Line	Over Limit	Read Level	Cable Loss	Antenna Factor	Preamp Factor	Remark	T/Pos	A/Pos	Pol/Phase
	MHz	dBuV/m	dBuV/m	dB	dBuV	dB	dB/m	dB		deg	cm	
1	4990.00	66.40	74.00	-7.60	63.80	4.24	32.90	34.54	Peak	3	121	HORIZONTAL
2	5078.00	53.24	54.00	-0.76	50.44	4.30	33.03	34.53	Average	3	121	HORIZONTAL
3	5208.00	111.59			108.49	4.38	33.25	34.53	Average	3	121	HORIZONTAL
4	5210.00	120.89			117.79	4.38	33.25	34.53	Peak	3	121	HORIZONTAL
5	5394.00	52.81	54.00	-1.19	49.34	4.49	33.51	34.53	Average	3	121	HORIZONTAL
6	5420.00	66.07	74.00	-7.93	62.51	4.52	33.57	34.53	Peak	3	121	HORIZONTAL

Item 3, 4 are the fundamental frequency at 5210 MHz.

##### Channel 48

	Freq	Level	Limit Line	Over Limit	Read Level	Cable Loss	Antenna Factor	Preamp Factor	Remark	A/Pos	T/Pos	Pol/Phase
	MHz	dBuV/m	dBuV/m	dB	dBuV	dB	dB/m	dB		cm	deg	
1	4920.00	51.62	54.00	-2.38	49.42	3.35	33.76	34.91	Average	119	8	HORIZONTAL
2	5150.00	60.86	74.00	-13.14	58.23	3.43	34.11	34.91	Peak	119	8	HORIZONTAL
3	5240.00	108.67			105.89	3.46	34.23	34.91	Average	119	8	HORIZONTAL
4	5242.00	122.05			119.25	3.46	34.25	34.91	Peak	119	8	HORIZONTAL
5	5386.00	65.14	74.00	-8.86	62.12	3.50	34.44	34.92	Peak	119	8	HORIZONTAL
6	5402.00	52.35	54.00	-1.65	49.30	3.51	34.46	34.92	Average	119	8	HORIZONTAL

Item 3, 4 are the fundamental frequency at 5240 MHz.

<b>Temperature</b>	25°C	<b>Humidity</b>	56%
<b>Test Engineer</b>	YC Chen	<b>Configurations</b>	IEEE 802.11n MCS0 10 MHz CH 36, 42, 48 / Chain 1 + Chain 2
<b>Test Date</b>	Aug. 15, 2014 ~ Aug. 19, 2014	<b>Test Mode</b>	Mode 1

### Channel 36

	Freq	Level	Limit Line	Over Limit	Read Level	Cable Loss	Antenna Factor	Preamp Factor	Remark	A/Pos	T/Pos	Pol/Phase
	MHz	dBuV/m	dBuV/m	dB	dBuV	dB	dB/m	dB		cm	deg	
1	4920.00	52.09	54.00	-1.91	49.89	3.35	33.76	34.91	Average	127	10	HORIZONTAL
2	4998.00	63.38	74.00	-10.62	60.99	3.39	33.90	34.90	Peak	127	10	HORIZONTAL
3	5242.00	105.00			102.20	3.46	34.25	34.91	Average	127	10	HORIZONTAL
4	5244.00	116.67			113.87	3.46	34.25	34.91	Peak	127	10	HORIZONTAL
5	5384.00	64.05	74.00	-9.95	61.03	3.50	34.44	34.92	Peak	127	10	HORIZONTAL
6	5402.00	52.23	54.00	-1.77	49.18	3.51	34.46	34.92	Average	127	10	HORIZONTAL

Item 3, 4 are the fundamental frequency at 5180 MHz.

### Channel 42

	Freq	Level	Limit Line	Over Limit	Read Level	Cable Loss	Antenna Factor	Preamp Factor	Remark	T/Pos	A/Pos	Pol/Phase
	MHz	dBuV/m	dBuV/m	dB	dBuV	dB	dB/m	dB		deg	cm	
1	4990.00	67.30	74.00	-6.70	64.70	4.24	32.90	34.54	Peak	4	119	HORIZONTAL
2	5086.00	53.26	54.00	-0.74	50.46	4.30	33.03	34.53	Average	4	119	HORIZONTAL
3	5206.00	109.58			106.52	4.37	33.22	34.53	Average	4	119	HORIZONTAL
4	5212.00	120.60			117.50	4.38	33.25	34.53	Peak	4	119	HORIZONTAL
5	5396.00	66.32	74.00	-7.68	62.81	4.50	33.54	34.53	Peak	4	119	HORIZONTAL
6	5402.00	53.16	54.00	-0.84	49.65	4.50	33.54	34.53	Average	4	119	HORIZONTAL

Item 3, 4 are the fundamental frequency at 5210 MHz.

### Channel 48

	Freq	Level	Limit Line	Over Limit	Read Level	Cable Loss	Antenna Factor	Preamp Factor	Remark	A/Pos	T/Pos	Pol/Phase
	MHz	dBuV/m	dBuV/m	dB	dBuV	dB	dB/m	dB		cm	deg	
1	4920.00	52.23	54.00	-1.77	50.03	3.35	33.76	34.91	Average	126	8	HORIZONTAL
2	4940.00	63.71	74.00	-10.29	61.45	3.37	33.80	34.91	Peak	126	8	HORIZONTAL
3	5178.00	116.22			113.53	3.44	34.16	34.91	Peak	126	8	HORIZONTAL
4	5180.00	104.97			102.28	3.44	34.16	34.91	Average	126	8	HORIZONTAL

Item 3, 4 are the fundamental frequency at 5240 MHz.



<b>Temperature</b>	25°C	<b>Humidity</b>	56%
<b>Test Engineer</b>	YC Chen	<b>Configurations</b>	IEEE 802.11n MCS0 20 MHz CH 36, 40, 48 / Chain 1 + Chain 2
<b>Test Date</b>	Aug. 15, 2014	<b>Test Mode</b>	Mode 1

**Channel 36**

	Freq	Level	Limit Line	Over Limit	Read Level	Cable Loss	Antenna Factor	Preamp Factor	Remark	A/Pos	T/Pos	Pol/Phase
	MHz	dBuV/m	dBuV/m	dB	dBuV	dB	dB/m	dB		cm	deg	
1	4920.00	53.07	54.00	-0.93	50.87	3.35	33.76	34.91	Average	125	4	HORIZONTAL
2	4920.00	64.01	74.00	-9.99	61.81	3.35	33.76	34.91	Peak	125	4	HORIZONTAL
3	5172.00	102.07			99.41	3.44	34.13	34.91	Average	125	4	HORIZONTAL
4	5174.00	112.36			109.67	3.44	34.16	34.91	Peak	125	4	HORIZONTAL

Item 3, 4 are the fundamental frequency at 5180 MHz.

**Channel 40**

	Freq	Level	Limit Line	Over Limit	Read Level	Cable Loss	Antenna Factor	Preamp Factor	Remark	A/Pos	T/Pos	Pol/Phase
	MHz	dBuV/m	dBuV/m	dB	dBuV	dB	dB/m	dB		cm	deg	
1	4894.00	63.43	74.00	-10.57	61.31	3.34	33.69	34.91	Peak	121	6	HORIZONTAL
2	4920.00	52.44	54.00	-1.56	50.24	3.35	33.76	34.91	Average	121	6	HORIZONTAL
3	5192.00	102.00			99.29	3.44	34.18	34.91	Average	121	6	HORIZONTAL
4	5194.00	112.30			109.59	3.44	34.18	34.91	Peak	121	6	HORIZONTAL

Item 3, 4 are the fundamental frequency at 5200 MHz.

**Channel 48**

	Freq	Level	Limit Line	Over Limit	Read Level	Cable Loss	Antenna Factor	Preamp Factor	Remark	A/Pos	T/Pos	Pol/Phase
	MHz	dBuV/m	dBuV/m	dB	dBuV	dB	dB/m	dB		cm	deg	
1	4918.00	65.72	74.00	-8.28	63.55	3.35	33.73	34.91	Peak	126	360	HORIZONTAL
2	4920.00	52.90	54.00	-1.10	50.70	3.35	33.76	34.91	Average	126	360	HORIZONTAL
3	5242.00	103.49			100.69	3.46	34.25	34.91	Average	126	360	HORIZONTAL
4	5248.00	113.65			110.85	3.46	34.25	34.91	Peak	126	360	HORIZONTAL
5	5402.00	52.37	54.00	-1.63	49.32	3.51	34.46	34.92	Average	126	360	HORIZONTAL
6	5402.00	61.37	74.00	-12.63	58.32	3.51	34.46	34.92	Peak	126	360	HORIZONTAL

Item 3, 4 are the fundamental frequency at 5240 MHz.

<b>Temperature</b>	25°C	<b>Humidity</b>	56%
<b>Test Engineer</b>	YC Chen	<b>Configurations</b>	IEEE 802.11n MCS0 40 MHz CH 38, 46 / Chain 1 + Chain 2
<b>Test Date</b>	Aug. 15, 2014	<b>Test Mode</b>	Mode 1

**Channel 38**

	Freq	Level	Limit Line	Over Limit	Read Level	Cable Loss	Antenna Factor	Preamp Factor	Remark	A/Pos	T/Pos	Pol/Phase
	MHz	dBuV/m	dBuV/m	dB	dBuV	dB	dB/m	dB		cm	deg	
1	5140.00	66.17	74.00	-7.83	63.54	3.43	34.11	34.91	Peak	125	3	HORIZONTAL
2	5150.00	53.96	54.00	-0.04	51.33	3.43	34.11	34.91	Average	125	3	HORIZONTAL
3	5188.00	96.46			93.77	3.44	34.16	34.91	Average	125	3	HORIZONTAL
4	5198.00	106.89			104.17	3.45	34.18	34.91	Peak	125	3	HORIZONTAL

Item 3, 4 are the fundamental frequency at 5190 MHz.

**Channel 46**

	Freq	Level	Limit Line	Over Limit	Read Level	Cable Loss	Antenna Factor	Preamp Factor	Remark	A/Pos	T/Pos	Pol/Phase
	MHz	dBuV/m	dBuV/m	dB	dBuV	dB	dB/m	dB		cm	deg	
1	4920.00	52.14	54.00	-1.86	49.94	3.35	33.76	34.91	Average	126	6	HORIZONTAL
2	4988.00	63.88	74.00	-10.12	61.50	3.38	33.90	34.90	Peak	126	6	HORIZONTAL
3	5242.00	99.09			96.29	3.46	34.25	34.91	Average	126	6	HORIZONTAL
4	5246.00	109.63			106.83	3.46	34.25	34.91	Peak	126	6	HORIZONTAL
5	5390.00	52.75	54.00	-1.25	49.73	3.50	34.44	34.92	Average	126	6	HORIZONTAL
6	5390.00	64.75	74.00	-9.25	61.73	3.50	34.44	34.92	Peak	126	6	HORIZONTAL

Item 3, 4 are the fundamental frequency at 5230 MHz.

<b>Temperature</b>	25°C	<b>Humidity</b>	56%
<b>Test Engineer</b>	YC Chen	<b>Configurations</b>	IEEE 802.11a 5 MHz CH 36, 42, 48 / Chain 1 + Chain 2
<b>Test Date</b>	Aug. 15, 2014 ~ Aug. 19, 2014	<b>Test Mode</b>	Mode 1

### Channel 36

	Freq	Level	Limit Line	Over Limit	Read Level	Cable Loss	Antenna Factor	Preamp Factor	Remark	A/Pos	T/Pos	Pol/Phase
	MHz	dBuV/m	dBuV/m	dB	dBuV	dB	dB/m	dB		cm	deg	
1	4920.00	51.57	54.00	-2.43	49.37	3.35	33.76	34.91	Average	123	6	HORIZONTAL
2	4996.00	62.87	74.00	-11.13	60.48	3.39	33.90	34.90	Peak	123	6	HORIZONTAL
3	5180.00	118.69			116.00	3.44	34.16	34.91	Peak	123	6	HORIZONTAL
4	5182.00	108.00			105.31	3.44	34.16	34.91	Average	123	6	HORIZONTAL

Item 3, 4 are the fundamental frequency at 5180 MHz.

### Channel 42

	Freq	Level	Limit Line	Over Limit	Read Level	Cable Loss	Antenna Factor	Preamp Factor	Remark	T/Pos	A/Pos	Pol/Phase
	MHz	dBuV/m	dBuV/m	dB	dBuV	dB	dB/m	dB		deg	cm	
1	5086.00	66.11	74.00	-7.89	63.31	4.30	33.03	34.53	Peak	4	120	HORIZONTAL
2	5086.00	53.17	54.00	-0.83	50.37	4.30	33.03	34.53	Average	4	120	HORIZONTAL
3	5210.00	113.12			110.02	4.38	33.25	34.53	Average	4	120	HORIZONTAL
4	5212.00	120.25			117.15	4.38	33.25	34.53	Peak	4	120	HORIZONTAL
5	5400.00	53.06	54.00	-0.94	49.55	4.50	33.54	34.53	Average	4	120	HORIZONTAL
6	5408.00	67.09	74.00	-6.91	63.58	4.50	33.54	34.53	Peak	4	120	HORIZONTAL

Item 3, 4 are the fundamental frequency at 5210 MHz.

### Channel 48

	Freq	Level	Limit Line	Over Limit	Read Level	Cable Loss	Antenna Factor	Preamp Factor	Remark	A/Pos	T/Pos	Pol/Phase
	MHz	dBuV/m	dBuV/m	dB	dBuV	dB	dB/m	dB		cm	deg	
1	4920.00	51.74	54.00	-2.26	49.54	3.35	33.76	34.91	Average	128	6	HORIZONTAL
2	5104.00	61.76	74.00	-12.24	59.20	3.42	34.04	34.90	Peak	128	6	HORIZONTAL
3	5240.00	108.60			105.82	3.46	34.23	34.91	Average	128	6	HORIZONTAL
4	5242.00	120.05			117.25	3.46	34.25	34.91	Peak	128	6	HORIZONTAL
5	5402.00	52.39	54.00	-1.61	49.34	3.51	34.46	34.92	Average	128	6	HORIZONTAL
6	5402.00	65.39	74.00	-8.61	62.34	3.51	34.46	34.92	Peak	128	6	HORIZONTAL

Item 3, 4 are the fundamental frequency at 5240 MHz.

<b>Temperature</b>	25°C	<b>Humidity</b>	56%
<b>Test Engineer</b>	YC Chen	<b>Configurations</b>	IEEE 802.11a 10 MHz CH 36, 42, 48 / Chain 1 + Chain 2
<b>Test Date</b>	Aug. 15, 2014 ~ Aug. 19, 2014	<b>Test Mode</b>	Mode 1

### Channel 36

	Freq	Level	Limit	Over	Read	Cable	Antenna	Preamp	Remark	A/Pos	T/Pos	Pol/Phase
	MHz	dBuV/m	dBuV/m	dB	dBuV	Loss	Factor	Factor		cm	deg	
1	4920.00	52.21	54.00	-1.79	50.01	3.35	33.76	34.91	Average	122	6	HORIZONTAL
2	4956.00	63.62	74.00	-10.38	61.33	3.37	33.83	34.91	Peak	122	6	HORIZONTAL
3	5178.00	116.22			113.53	3.44	34.16	34.91	Peak	122	6	HORIZONTAL
4	5182.00	105.56			102.87	3.44	34.16	34.91	Average	122	6	HORIZONTAL

Item 3, 4 are the fundamental frequency at 5180 MHz.

### Channel 42

	Freq	Level	Limit	Over	Read	Cable	Antenna	Preamp	Remark	T/Pos	A/Pos	Pol/Phase
	MHz	dBuV/m	dBuV/m	dB	dBuV	Loss	Factor	Factor		deg	cm	
1	5004.00	65.46	74.00	-8.54	62.81	4.25	32.93	34.53	Peak	4	118	HORIZONTAL
2	5082.00	53.09	54.00	-0.91	50.29	4.30	33.03	34.53	Average	4	118	HORIZONTAL
3	5212.00	120.05			116.95	4.38	33.25	34.53	Peak	4	118	HORIZONTAL
4	5212.00	109.06			105.96	4.38	33.25	34.53	Average	4	118	HORIZONTAL
5	5364.00	65.23	74.00	-8.77	61.79	4.48	33.49	34.53	Peak	4	118	HORIZONTAL
6	5398.00	52.92	54.00	-1.08	49.41	4.50	33.54	34.53	Average	4	118	HORIZONTAL

Item 3, 4 are the fundamental frequency at 5210 MHz.

### Channel 48

	Freq	Level	Limit	Over	Read	Cable	Antenna	Preamp	Remark	A/Pos	T/Pos	Pol/Phase
	MHz	dBuV/m	dBuV/m	dB	dBuV	Loss	Factor	Factor		cm	deg	
1	4920.00	51.69	54.00	-2.31	49.49	3.35	33.76	34.91	Average	129	9	HORIZONTAL
2	4980.00	62.96	74.00	-11.04	60.61	3.38	33.87	34.90	Peak	129	9	HORIZONTAL
3	5242.00	105.23			102.43	3.46	34.25	34.91	Average	129	9	HORIZONTAL
4	5244.00	116.53			113.73	3.46	34.25	34.91	Peak	129	9	HORIZONTAL
5	5390.00	64.84	74.00	-9.16	61.82	3.50	34.44	34.92	Peak	129	9	HORIZONTAL
6	5402.00	52.48	54.00	-1.52	49.43	3.51	34.46	34.92	Average	129	9	HORIZONTAL

Item 3, 4 are the fundamental frequency at 5240 MHz.

<b>Temperature</b>	25°C	<b>Humidity</b>	56%
<b>Test Engineer</b>	YC Chen	<b>Configurations</b>	IEEE 802.11a 20 MHz CH 36, 40, 48 / Chain 1 + Chain 2
<b>Test Date</b>	Aug. 15, 2014	<b>Test Mode</b>	Mode 1

### Channel 36

	Freq	Level	Limit Line	Over Limit	Read Level	Cable Loss	Antenna Factor	Preamp Factor	Remark	A/Pos	T/Pos	Pol/Phase
	MHz	dBuV/m	dBuV/m	dB	dBuV	dB	dB/m	dB		cm	deg	
1	4920.00	52.09	54.00	-1.91	49.89	3.35	33.76	34.91	Average	127	10	HORIZONTAL
2	4998.00	63.38	74.00	-10.62	60.99	3.39	33.90	34.90	Peak	127	10	HORIZONTAL
3	5242.00	105.00			102.20	3.46	34.25	34.91	Average	127	10	HORIZONTAL
4	5244.00	116.67			113.87	3.46	34.25	34.91	Peak	127	10	HORIZONTAL
5	5384.00	64.05	74.00	-9.95	61.03	3.50	34.44	34.92	Peak	127	10	HORIZONTAL
6	5402.00	52.23	54.00	-1.77	49.18	3.51	34.46	34.92	Average	127	10	HORIZONTAL

Item 3, 4 are the fundamental frequency at 5180 MHz.

### Channel 40

	Freq	Level	Limit Line	Over Limit	Read Level	Cable Loss	Antenna Factor	Preamp Factor	Remark	T/Pos	A/Pos	Pol/Phase
	MHz	dBuV/m	dBuV/m	dB	dBuV	dB	dB/m	dB		deg	cm	
1	4990.00	67.30	74.00	-6.70	64.70	4.24	32.90	34.54	Peak	4	119	HORIZONTAL
2	5086.00	53.26	54.00	-0.74	50.46	4.30	33.03	34.53	Average	4	119	HORIZONTAL
3	5206.00	109.58			106.52	4.37	33.22	34.53	Average	4	119	HORIZONTAL
4	5212.00	120.60			117.50	4.38	33.25	34.53	Peak	4	119	HORIZONTAL
5	5396.00	66.32	74.00	-7.68	62.81	4.50	33.54	34.53	Peak	4	119	HORIZONTAL
6	5402.00	53.16	54.00	-0.84	49.65	4.50	33.54	34.53	Average	4	119	HORIZONTAL

Item 3, 4 are the fundamental frequency at 5200 MHz.

### Channel 48

	Freq	Level	Limit Line	Over Limit	Read Level	Cable Loss	Antenna Factor	Preamp Factor	Remark	A/Pos	T/Pos	Pol/Phase
	MHz	dBuV/m	dBuV/m	dB	dBuV	dB	dB/m	dB		cm	deg	
1	4920.00	52.23	54.00	-1.77	50.03	3.35	33.76	34.91	Average	126	8	HORIZONTAL
2	4940.00	63.71	74.00	-10.29	61.45	3.37	33.80	34.91	Peak	126	8	HORIZONTAL
3	5178.00	116.22			113.53	3.44	34.16	34.91	Peak	126	8	HORIZONTAL
4	5180.00	104.97			102.28	3.44	34.16	34.91	Average	126	8	HORIZONTAL

Item 3, 4 are the fundamental frequency at 5240 MHz.

Note:

Emission level (dBuV/m) = 20 log Emission level (uV/m)

Corrected Reading: Antenna Factor + Cable Loss + Read Level - Preamp Factor = Level



<b>Temperature</b>	25°C	<b>Humidity</b>	56%
<b>Test Engineer</b>	YC Chen	<b>Configurations</b>	IEEE 802.11n MCS0 5 MHz CH 36, 42, 48 / Chain 1 + Chain 2
<b>Test Date</b>	Aug. 12, 2014 ~ Aug. 18, 2014	<b>Test Mode</b>	Mode 2

**Channel 36**

	Freq	Level	Limit Line	Over Limit	Read Level	Cable Loss	Antenna Factor	Preamp Factor	Remark	A/Pos	T/Pos	Pol/Phase
	MHz	dBuV/m	dBuV/m	dB	dBuV	dB	dB/m	dB		cm	deg	
1	4925.64	65.00	74.00	-9.00	62.80	3.35	33.76	34.91	Peak	118	349	VERTICAL
2	4928.85	52.26	54.00	-1.74	50.06	3.35	33.76	34.91	Average	118	349	VERTICAL
3	5178.40	124.31			121.62	3.44	34.16	34.91	Peak	118	349	VERTICAL
4	5181.60	112.70			110.01	3.44	34.16	34.91	Average	118	349	VERTICAL
5	5372.44	64.36	74.00	-9.64	61.37	3.49	34.41	34.91	Peak	118	349	VERTICAL
6	5426.92	52.43	54.00	-1.57	49.35	3.52	34.48	34.92	Average	118	349	VERTICAL

Item 3, 4 are the fundamental frequency at 5180 MHz.

**Channel 42**

	Freq	Level	Limit Line	Over Limit	Read Level	Cable Loss	Antenna Factor	Preamp Factor	Remark	T/Pos	A/Pos	Pol/Phase
	MHz	dBuV/m	dBuV/m	dB	dBuV	dB	dB/m	dB		deg	cm	
1	5056.00	53.02	54.00	-0.98	50.26	4.28	33.01	34.53	Average	6	160	HORIZONTAL
2	5064.00	66.88	74.00	-7.12	64.12	4.28	33.01	34.53	Peak	6	160	HORIZONTAL
3	5210.00	119.43			116.33	4.38	33.25	34.53	Peak	6	160	HORIZONTAL
4	5212.00	111.57			108.47	4.38	33.25	34.53	Average	6	160	HORIZONTAL
5	5408.00	65.96	74.00	-8.04	62.45	4.50	33.54	34.53	Peak	6	160	HORIZONTAL
6	5410.00	53.44	54.00	-0.56	49.93	4.50	33.54	34.53	Average	6	160	HORIZONTAL

Item 3, 4 are the fundamental frequency at 5210 MHz.

**Channel 48**

	Freq	Level	Limit Line	Over Limit	Read Level	Cable Loss	Antenna Factor	Preamp Factor	Remark	A/Pos	T/Pos	Pol/Phase
	MHz	dBuV/m	dBuV/m	dB	dBuV	dB	dB/m	dB		cm	deg	
1	4957.69	51.94	54.00	-2.06	49.65	3.37	33.83	34.91	Average	120	350	VERTICAL
2	4976.92	65.40	74.00	-8.60	63.05	3.38	33.87	34.90	Peak	120	350	VERTICAL
3	5241.60	112.97			110.17	3.46	34.25	34.91	Average	120	350	VERTICAL
4	5241.60	124.77			121.97	3.46	34.25	34.91	Peak	120	350	VERTICAL
5	5390.06	52.59	54.00	-1.41	49.57	3.50	34.44	34.92	Average	120	350	VERTICAL
6	5406.09	65.65	74.00	-8.35	62.60	3.51	34.46	34.92	Peak	120	350	VERTICAL

Item 3, 4 are the fundamental frequency at 5240 MHz.

<b>Temperature</b>	25°C	<b>Humidity</b>	56%
<b>Test Engineer</b>	YC Chen	<b>Configurations</b>	IEEE 802.11n MCS0 10 MHz CH 36, 42, 48 / Chain 1 + Chain 2
<b>Test Date</b>	Aug. 12, 2014 ~ Aug. 18, 2014	<b>Test Mode</b>	Mode 2

**Channel 36**

	Freq	Level	Limit Line	Over Limit	Read Level	Cable Loss	Antenna Factor	Preamp Factor	Remark	A/Pos	T/Pos	Pol/Phase
	MHz	dBuV/m	dBuV/m	dB	dBuV	dB	dB/m	dB		cm	deg	
1	4920.83	52.18	54.00	-1.82	49.98	3.35	33.76	34.91	Average	119	351	VERTICAL
2	4973.72	65.13	74.00	-8.87	62.78	3.38	33.87	34.90	Peak	119	351	VERTICAL
3	5178.40	109.40			106.71	3.44	34.16	34.91	Average	119	351	VERTICAL
4	5183.21	120.40			117.71	3.44	34.16	34.91	Peak	119	351	VERTICAL
5	5364.42	65.15	74.00	-8.85	62.16	3.49	34.41	34.91	Peak	119	351	VERTICAL
6	5431.73	52.48	54.00	-1.52	49.37	3.52	34.51	34.92	Average	119	351	VERTICAL

Item 3, 4 are the fundamental frequency at 5180 MHz.

**Channel 42**

	Freq	Level	Limit Line	Over Limit	Read Level	Cable Loss	Antenna Factor	Preamp Factor	Remark	T/Pos	A/Pos	Pol/Phase
	MHz	dBuV/m	dBuV/m	dB	dBuV	dB	dB/m	dB		deg	cm	
1	5066.00	65.64	74.00	-8.36	62.88	4.28	33.01	34.53	Peak	6	146	HORIZONTAL
2	5078.00	52.86	54.00	-1.14	50.06	4.30	33.03	34.53	Average	6	146	HORIZONTAL
3	5206.00	119.24			116.18	4.37	33.22	34.53	Peak	6	146	HORIZONTAL
4	5206.00	109.85			106.79	4.37	33.22	34.53	Average	6	146	HORIZONTAL
5	5388.00	66.15	74.00	-7.85	62.68	4.49	33.51	34.53	Peak	6	146	HORIZONTAL
6	5420.00	53.03	54.00	-0.97	49.47	4.52	33.57	34.53	Average	6	146	HORIZONTAL

Item 3, 4 are the fundamental frequency at 5210 MHz.

**Channel 48**

	Freq	Level	Limit Line	Over Limit	Read Level	Cable Loss	Antenna Factor	Preamp Factor	Remark	A/Pos	T/Pos	Pol/Phase
	MHz	dBuV/m	dBuV/m	dB	dBuV	dB	dB/m	dB		cm	deg	
1	4919.23	52.18	54.00	-1.82	49.98	3.35	33.76	34.91	Average	106	351	VERTICAL
2	4988.14	64.58	74.00	-9.42	62.20	3.38	33.90	34.90	Peak	106	351	VERTICAL
3	5236.80	109.50			106.72	3.46	34.23	34.91	Average	106	351	VERTICAL
4	5236.80	120.43			117.65	3.46	34.23	34.91	Peak	106	351	VERTICAL
5	5402.89	64.94	74.00	-9.06	61.89	3.51	34.46	34.92	Peak	106	351	VERTICAL
6	5434.94	52.66	54.00	-1.34	49.55	3.52	34.51	34.92	Average	106	351	VERTICAL

Item 3, 4 are the fundamental frequency at 5240 MHz.

<b>Temperature</b>	25°C	<b>Humidity</b>	56%
<b>Test Engineer</b>	YC Chen	<b>Configurations</b>	IEEE 802.11n MCS0 20 MHz CH 36, 40, 48 / Chain 1 + Chain 2
<b>Test Date</b>	Aug. 12, 2014	<b>Test Mode</b>	Mode 2

### Channel 36

	Freq	Level	Limit Line	Over Limit	Read Level	CableAntenna Loss	Antenna Factor	Preamp Factor	Remark	A/Pos	T/Pos	Pol/Phase
	MHz	dBuV/m	dBuV/m	dB	dBuV	dB	dB/m	dB		cm	deg	
1	5148.40	70.91	74.00	-3.09	68.28	3.43	34.11	34.91	Peak	112	356	VERTICAL
2	5150.00	53.16	54.00	-0.84	50.53	3.43	34.11	34.91	Average	112	356	VERTICAL
3	5174.55	113.14			110.45	3.44	34.16	34.91	Peak	112	356	VERTICAL
4	5175.83	102.18			99.49	3.44	34.16	34.91	Average	112	356	VERTICAL

Item 3, 4 are the fundamental frequency at 5180 MHz.

### Channel 40

	Freq	Level	Limit Line	Over Limit	Read Level	CableAntenna Loss	Antenna Factor	Preamp Factor	Remark	A/Pos	T/Pos	Pol/Phase
	MHz	dBuV/m	dBuV/m	dB	dBuV	dB	dB/m	dB		cm	deg	
1	4919.23	52.42	54.00	-1.58	50.22	3.35	33.76	34.91	Average	118	349	VERTICAL
2	4962.50	66.07	74.00	-7.93	63.78	3.37	33.83	34.91	Peak	118	349	VERTICAL
3	5191.99	106.53			103.82	3.44	34.18	34.91	Average	118	349	VERTICAL
4	5196.80	116.12			113.40	3.45	34.18	34.91	Peak	118	349	VERTICAL
5	5436.54	52.48	54.00	-1.52	49.37	3.52	34.51	34.92	Average	118	349	VERTICAL
6	5436.54	65.07	74.00	-8.93	61.96	3.52	34.51	34.92	Peak	118	349	VERTICAL

Item 3, 4 are the fundamental frequency at 5200 MHz.

### Channel 48

	Freq	Level	Limit Line	Over Limit	Read Level	CableAntenna Loss	Antenna Factor	Preamp Factor	Remark	A/Pos	T/Pos	Pol/Phase
	MHz	dBuV/m	dBuV/m	dB	dBuV	dB	dB/m	dB		cm	deg	
1	4919.23	52.04	54.00	-1.96	49.84	3.35	33.76	34.91	Average	120	354	VERTICAL
2	4919.23	65.11	74.00	-8.89	62.91	3.35	33.76	34.91	Peak	120	354	VERTICAL
3	5233.59	105.78			103.00	3.46	34.23	34.91	Average	120	354	VERTICAL
4	5244.81	116.22			113.42	3.46	34.25	34.91	Peak	120	354	VERTICAL
5	5425.32	52.19	54.00	-1.81	49.11	3.52	34.48	34.92	Average	120	354	VERTICAL
6	5425.32	64.13	74.00	-9.87	61.05	3.52	34.48	34.92	Peak	120	354	VERTICAL

Item 3, 4 are the fundamental frequency at 5240 MHz.



<b>Temperature</b>	25°C	<b>Humidity</b>	56%
<b>Test Engineer</b>	YC Chen	<b>Configurations</b>	IEEE 802.11n MCS0 40 MHz CH 38, 46 / Chain 1 + Chain 2
<b>Test Date</b>	Aug. 12, 2014	<b>Test Mode</b>	Mode 2

**Channel 38**

	Freq	Level	Limit Line	Over Limit	Read Level	CableAntenna Loss	Antenna Factor	Preamp Factor	Remark	A/Pos	T/Pos	Pol/Phase
	MHz	dBuV/m	dBuV/m	dB	dBuV	dB	dB/m	dB		cm	deg	
1	5150.00	53.34	54.00	-0.66	50.71	3.43	34.11	34.91	Average	120	353	VERTICAL
2	5150.00	73.49	74.00	-0.51	70.86	3.43	34.11	34.91	Peak	120	353	VERTICAL
3	5173.65	107.40			104.71	3.44	34.16	34.91	Peak	120	353	VERTICAL
4	5194.81	96.28			93.56	3.45	34.18	34.91	Average	120	353	VERTICAL

Item 3, 4 are the fundamental frequency at 5190 MHz.

**Channel 46**

	Freq	Level	Limit Line	Over Limit	Read Level	CableAntenna Loss	Antenna Factor	Preamp Factor	Remark	A/Pos	T/Pos	Pol/Phase
	MHz	dBuV/m	dBuV/m	dB	dBuV	dB	dB/m	dB		cm	deg	
1	4927.24	52.32	54.00	-1.68	50.12	3.35	33.76	34.91	Average	116	353	VERTICAL
2	5145.19	66.63	74.00	-7.37	64.00	3.43	34.11	34.91	Peak	116	353	VERTICAL
3	5218.78	102.60			99.86	3.45	34.20	34.91	Average	116	353	VERTICAL
4	5390.06	52.95	54.00	-1.05	49.93	3.50	34.44	34.92	Average	116	353	VERTICAL
5	5422.12	65.68	74.00	-8.32	62.61	3.51	34.48	34.92	Peak	116	353	VERTICAL

Item 3 are the fundamental frequency at 5230 MHz.

<b>Temperature</b>	25°C	<b>Humidity</b>	56%
<b>Test Engineer</b>	YC Chen	<b>Configurations</b>	IEEE 802.11a 5 MHz CH 36, 42, 48 / Chain 1 + Chain 2
<b>Test Date</b>	Aug. 12, 2014 ~ Aug. 18, 2014	<b>Test Mode</b>	Mode 2

**Channel 36**

	Freq	Level	Limit Line	Over Limit	Read Level	Cable Loss	Antenna Factor	Preamp Factor	Remark	A/Pos	T/Pos	Pol/Phase
	MHz	dBuV/m	dBuV/m	dB	dBuV	dB	dB/m	dB		cm	deg	
1	4919.23	52.54	54.00	-1.46	50.34	3.35	33.76	34.91	Average	117	350	VERTICAL
2	4992.95	64.49	74.00	-9.51	62.10	3.39	33.90	34.90	Peak	117	350	VERTICAL
3	5180.00	113.06			110.37	3.44	34.16	34.91	Average	117	350	VERTICAL
4	5181.60	124.15			121.46	3.44	34.16	34.91	Peak	117	350	VERTICAL
5	5428.53	66.23	74.00	-7.77	63.12	3.52	34.51	34.92	Peak	117	350	VERTICAL
6	5431.73	52.64	54.00	-1.36	49.53	3.52	34.51	34.92	Average	117	350	VERTICAL

Item 3, 4 are the fundamental frequency at 5180 MHz.

**Channel 42**

	Freq	Level	Limit Line	Over Limit	Read Level	Cable Loss	Antenna Factor	Preamp Factor	Remark	T/Pos	A/Pos	Pol/Phase
	MHz	dBuV/m	dBuV/m	dB	dBuV	dB	dB/m	dB		deg	cm	
1	5046.00	65.80	74.00	-8.20	63.08	4.27	32.98	34.53	Peak	5	157	HORIZONTAL
2	5080.00	52.82	54.00	-1.18	50.02	4.30	33.03	34.53	Average	5	157	HORIZONTAL
3	5210.00	119.46			116.36	4.38	33.25	34.53	Peak	5	157	HORIZONTAL
4	5210.00	112.16			109.06	4.38	33.25	34.53	Average	5	157	HORIZONTAL
5	5388.00	65.47	74.00	-8.53	62.00	4.49	33.51	34.53	Peak	5	157	HORIZONTAL
6	5410.00	53.04	54.00	-0.96	49.53	4.50	33.54	34.53	Average	5	157	HORIZONTAL

Item 3, 4 are the fundamental frequency at 5210 MHz.

**Channel 48**

	Freq	Level	Limit Line	Over Limit	Read Level	Cable Loss	Antenna Factor	Preamp Factor	Remark	A/Pos	T/Pos	Pol/Phase
	MHz	dBuV/m	dBuV/m	dB	dBuV	dB	dB/m	dB		cm	deg	
1	4962.50	52.53	54.00	-1.47	50.24	3.37	33.83	34.91	Average	114	346	VERTICAL
2	4992.95	64.68	74.00	-9.32	62.29	3.39	33.90	34.90	Peak	114	346	VERTICAL
3	5240.00	113.14			110.36	3.46	34.23	34.91	Average	114	346	VERTICAL
4	5241.60	124.15			121.35	3.46	34.25	34.91	Peak	114	346	VERTICAL
5	5386.86	53.27	54.00	-0.73	50.25	3.50	34.44	34.92	Average	114	346	VERTICAL
6	5402.89	65.95	74.00	-8.05	62.90	3.51	34.46	34.92	Peak	114	346	VERTICAL

Item 3, 4 are the fundamental frequency at 5240 MHz.

<b>Temperature</b>	25°C	<b>Humidity</b>	56%
<b>Test Engineer</b>	YC Chen	<b>Configurations</b>	IEEE 802.11a 10 MHz CH 36, 42, 48 / Chain 1 + Chain 2
<b>Test Date</b>	Aug. 12, 2014 ~ Aug. 18, 2014	<b>Test Mode</b>	Mode 2

**Channel 36**

	Freq	Level	Limit Line	Over Limit	Read Level	Cable Loss	Antenna Factor	Preamp Factor	Remark	A/Pos	T/Pos	Pol/Phase
	MHz	dBuV/m	dBuV/m	dB	dBuV	dB	dB/m	dB		cm	deg	
1	4964.10	52.27	54.00	-1.73	49.98	3.37	33.83	34.91	Average	120	349	VERTICAL
2	5042.63	64.24	74.00	-9.76	61.77	3.40	33.97	34.90	Peak	120	349	VERTICAL
3	5176.80	110.33			107.64	3.44	34.16	34.91	Average	120	349	VERTICAL
4	5399.68	65.88	74.00	-8.12	62.83	3.51	34.46	34.92	Peak	120	349	VERTICAL
5	5436.54	52.94	54.00	-1.06	49.83	3.52	34.51	34.92	Average	120	349	VERTICAL

Item 3 are the fundamental frequency at 5180 MHz.

**Channel 42**

	Freq	Level	Limit Line	Over Limit	Read Level	Cable Loss	Antenna Factor	Preamp Factor	Remark	T/Pos	A/Pos	Pol/Phase
	MHz	dBuV/m	dBuV/m	dB	dBuV	dB	dB/m	dB		deg	cm	
1	5062.00	66.85	74.00	-7.15	64.09	4.28	33.01	34.53	Peak	6	160	HORIZONTAL
2	5082.00	53.82	54.00	-0.18	51.02	4.30	33.03	34.53	Average	6	160	HORIZONTAL
3	5208.00	111.28			108.18	4.38	33.25	34.53	Average	6	160	HORIZONTAL
4	5210.00	120.31			117.21	4.38	33.25	34.53	Peak	6	160	HORIZONTAL
5	5396.00	66.83	74.00	-7.17	63.32	4.50	33.54	34.53	Peak	6	160	HORIZONTAL
6	5410.00	53.94	54.00	-0.06	50.43	4.50	33.54	34.53	Average	6	160	HORIZONTAL

Item 3, 4 are the fundamental frequency at 5210 MHz.

**Channel 48**

	Freq	Level	Limit Line	Over Limit	Read Level	Cable Loss	Antenna Factor	Preamp Factor	Remark	A/Pos	T/Pos	Pol/Phase
	MHz	dBuV/m	dBuV/m	dB	dBuV	dB	dB/m	dB		cm	deg	
1	4912.82	63.83	74.00	-10.17	61.67	3.34	33.73	34.91	Peak	115	346	VERTICAL
2	4919.23	52.59	54.00	-1.41	50.39	3.35	33.76	34.91	Average	115	346	VERTICAL
3	5243.21	110.40			107.60	3.46	34.25	34.91	Average	115	346	VERTICAL
4	5243.21	120.74			117.94	3.46	34.25	34.91	Peak	115	346	VERTICAL
5	5388.46	52.91	54.00	-1.09	49.89	3.50	34.44	34.92	Average	115	346	VERTICAL
6	5390.06	65.60	74.00	-8.40	62.58	3.50	34.44	34.92	Peak	115	346	VERTICAL

Item 3, 4 are the fundamental frequency at 5240 MHz.

<b>Temperature</b>	25°C	<b>Humidity</b>	56%
<b>Test Engineer</b>	YC Chen	<b>Configurations</b>	IEEE 802.11a 10 MHz CH 36, 42, 48 / Chain 1 + Chain 2
<b>Test Date</b>	Aug. 12, 2014	<b>Test Mode</b>	Mode 2

### Channel 36

	Freq	Level	Limit Line	Over Limit	Read Level	Cable Loss	Antenna Factor	Preamp Factor	Remark	A/Pos	T/Pos	Pol/Phase
	MHz	dBuV/m	dBuV/m	dB	dBuV	dB	dB/m	dB		cm	deg	
1	5149.68	72.00	74.00	-2.00	69.37	3.43	34.11	34.91	Peak	121	349	VERTICAL
2	5150.00	53.18	54.00	-0.82	50.55	3.43	34.11	34.91	Average	121	349	VERTICAL
3	5176.80	103.48			100.79	3.44	34.16	34.91	Average	121	349	VERTICAL
4	5184.17	113.98			111.29	3.44	34.16	34.91	Peak	121	349	VERTICAL

Item 3, 4 are the fundamental frequency at 5180 MHz.

### Channel 40

	Freq	Level	Limit Line	Over Limit	Read Level	Cable Loss	Antenna Factor	Preamp Factor	Remark	A/Pos	T/Pos	Pol/Phase
	MHz	dBuV/m	dBuV/m	dB	dBuV	dB	dB/m	dB		cm	deg	
1	4964.90	52.55	54.00	-1.45	50.26	3.37	33.83	34.91	Average	114	352	VERTICAL
2	4964.90	66.16	74.00	-7.84	63.87	3.37	33.83	34.91	Peak	114	352	VERTICAL
3	5193.27	106.12			103.41	3.44	34.18	34.91	Average	114	352	VERTICAL
4	5193.27	116.35			113.64	3.44	34.18	34.91	Peak	114	352	VERTICAL
5	5387.02	65.83	74.00	-8.17	62.81	3.50	34.44	34.92	Peak	114	352	VERTICAL
6	5390.39	52.79	54.00	-1.21	49.77	3.50	34.44	34.92	Average	114	352	VERTICAL

Item 3, 4 are the fundamental frequency at 5200 MHz.

### Channel 48

	Freq	Level	Limit Line	Over Limit	Read Level	Cable Loss	Antenna Factor	Preamp Factor	Remark	A/Pos	T/Pos	Pol/Phase
	MHz	dBuV/m	dBuV/m	dB	dBuV	dB	dB/m	dB		cm	deg	
1	4919.23	52.36	54.00	-1.64	50.16	3.35	33.76	34.91	Average	117	349	VERTICAL
2	4980.13	65.32	74.00	-8.68	62.97	3.38	33.87	34.90	Peak	117	349	VERTICAL
3	5243.21	106.98			104.18	3.46	34.25	34.91	Average	117	349	VERTICAL
4	5246.41	117.00			114.20	3.46	34.25	34.91	Peak	117	349	VERTICAL
5	5383.65	65.80	74.00	-8.20	62.78	3.50	34.44	34.92	Peak	117	349	VERTICAL
6	5436.00	53.37	54.00	-0.63	50.26	3.52	34.51	34.92	Average	117	349	VERTICAL

Item 3, 4 are the fundamental frequency at 5240 MHz.

Note:

Emission level (dBuV/m) = 20 log Emission level (uV/m)

Corrected Reading: Antenna Factor + Cable Loss + Read Level - Preamp Factor = Level

<b>Temperature</b>	25°C	<b>Humidity</b>	56%
<b>Test Engineer</b>	YC Chen	<b>Configurations</b>	IEEE 802.11n MCS0 5 MHz CH 36, 42, 48 / Chain 1 + Chain 2
<b>Test Date</b>	Aug. 08, 2014 ~ Aug. 18, 2014	<b>Test Mode</b>	Mode 3

**Channel 36**

	Freq	Level	Limit Line	Over Limit	Read Level	CableAntenna Loss	Antenna Factor	Preamp Factor	Remark	A/Pos	T/Pos	Pol/Phase
	MHz	dBuV/m	dBuV/m	dB	dBuV	dB	dB/m	dB		cm	deg	
1	5135.53	65.07	74.00	-8.93	60.17	6.12	33.98	35.20	Peak	187	160	VERTICAL
2	5149.71	52.17	54.00	-1.83	47.23	6.13	34.01	35.20	Average	187	160	VERTICAL
3	5178.55	113.94			108.91	6.15	34.08	35.20	Average	187	160	VERTICAL
4	5179.42	124.46			119.43	6.15	34.08	35.20	Peak	187	160	VERTICAL

Item 3, 4 are the fundamental frequency at 5180 MHz.

**Channel 42**

	Freq	Level	Limit Line	Over Limit	Read Level	CableAntenna Loss	Antenna Factor	Preamp Factor	Remark	T/Pos	A/Pos	Pol/Phase
	MHz	dBuV/m	dBuV/m	dB	dBuV	dB	dB/m	dB		deg	cm	
1	5150.00	61.22	74.00	-12.78	58.27	4.34	33.14	34.53	Peak	290	179	VERTICAL
2	5150.00	49.17	54.00	-4.83	46.22	4.34	33.14	34.53	Average	290	179	VERTICAL
3	5209.00	125.06			121.96	4.38	33.25	34.53	Peak	290	179	VERTICAL
4	5209.00	112.64			109.54	4.38	33.25	34.53	Average	290	179	VERTICAL

Item 3, 4 are the fundamental frequency at 5210 MHz.

**Channel 48**

	Freq	Level	Limit Line	Over Limit	Read Level	CableAntenna Loss	Antenna Factor	Preamp Factor	Remark	A/Pos	T/Pos	Pol/Phase
	MHz	dBuV/m	dBuV/m	dB	dBuV	dB	dB/m	dB		cm	deg	
1	5139.15	49.41	54.00	-4.59	44.51	6.12	33.98	35.20	Average	190	321	VERTICAL
2	5144.36	62.91	74.00	-11.09	57.97	6.13	34.01	35.20	Peak	190	321	VERTICAL
3	5239.13	112.31			107.15	6.18	34.18	35.20	Average	190	321	VERTICAL
4	5239.13	124.21			119.05	6.18	34.18	35.20	Peak	190	321	VERTICAL
5	5353.04	50.81	54.00	-3.19	45.33	6.26	34.42	35.20	Average	190	321	VERTICAL
6	5354.34	63.50	74.00	-10.50	58.02	6.26	34.42	35.20	Peak	190	321	VERTICAL

Item 3, 4 are the fundamental frequency at 5240 MHz.



<b>Temperature</b>	25°C	<b>Humidity</b>	56%
<b>Test Engineer</b>	YC Chen	<b>Configurations</b>	IEEE 802.11n MCS0 10 MHz CH 36, 42, 48 / Chain 1 + Chain 2
<b>Test Date</b>	Aug. 11, 2014 ~ Aug. 18, 2014	<b>Test Mode</b>	Mode 3

**Channel 36**

	Freq	Level	Limit Line	Over Limit	Read Level	CableAntenna Loss	Antenna Factor	Preamp Factor	Pol/Phase	A/Pos	T/Pos	Remark
	MHz	dBuV/m	dBuV/m	dB	dBuV	dB	dB/m	dB		cm	deg	
1	5149.20	66.11	74.00	-7.89	63.16	4.34	33.14	34.53	VERTICAL	162	286	Peak
2	5150.00	48.13	54.00	-5.87	45.18	4.34	33.14	34.53	VERTICAL	162	286	Average
3	5181.60	116.09			113.07	4.36	33.19	34.53	VERTICAL	162	286	Peak
4	5183.20	104.59			101.57	4.36	33.19	34.53	VERTICAL	162	286	Average

Item 3, 4 are the fundamental frequency at 5180 MHz.

**Channel 42**

	Freq	Level	Limit Line	Over Limit	Read Level	CableAntenna Loss	Antenna Factor	Preamp Factor	Remark	T/Pos	A/Pos	Pol/Phase
	MHz	dBuV/m	dBuV/m	dB	dBuV	dB	dB/m	dB		deg	cm	
1	5147.00	62.23	74.00	-11.77	59.28	4.34	33.14	34.53	Peak	274	173	VERTICAL
2	5150.00	48.22	54.00	-5.78	45.27	4.34	33.14	34.53	Average	274	173	VERTICAL
3	5213.00	107.53			104.43	4.38	33.25	34.53	Average	274	173	VERTICAL
4	5214.00	119.28			116.18	4.38	33.25	34.53	Peak	274	173	VERTICAL

Item 3, 4 are the fundamental frequency at 5210 MHz.

**Channel 48**

	Freq	Level	Limit Line	Over Limit	Read Level	CableAntenna Loss	Antenna Factor	Preamp Factor	Pol/Phase	A/Pos	T/Pos	Remark
	MHz	dBuV/m	dBuV/m	dB	dBuV	dB	dB/m	dB		cm	deg	
1	5145.80	59.47	74.00	-14.53	56.52	4.34	33.14	34.53	VERTICAL	192	322	Peak
2	5148.20	45.03	54.00	-8.97	42.08	4.34	33.14	34.53	VERTICAL	192	322	Average
3	5243.00	117.93			114.76	4.40	33.30	34.53	VERTICAL	192	322	Peak
4	5243.60	105.51			102.34	4.40	33.30	34.53	VERTICAL	192	322	Average
5	5351.20	61.78	74.00	-12.22	58.38	4.47	33.46	34.53	VERTICAL	192	322	Peak
6	5351.20	48.42	54.00	-5.58	45.02	4.47	33.46	34.53	VERTICAL	192	322	Average

Item 3, 4 are the fundamental frequency at 5240 MHz.

<b>Temperature</b>	25°C	<b>Humidity</b>	56%
<b>Test Engineer</b>	YC Chen	<b>Configurations</b>	IEEE 802.11n MCS0 20 MHz CH 36, 40, 48 / Chain 1 + Chain 2
<b>Test Date</b>	Aug. 12, 2014	<b>Test Mode</b>	Mode 3

**Channel 36**

	Freq	Level	Limit Line	Over Limit	Read Level	Cable Loss	Antenna Factor	Preamp Factor	Remark	A/Pos	T/Pos	Pol/Phase
	MHz	dBuV/m	dBuV/m	dB	dBuV	dB	dB/m	dB		cm	deg	
1	5149.36	71.39	74.00	-2.61	68.76	3.43	34.11	34.91	Peak	198	300	VERTICAL
2	5150.00	53.14	54.00	-0.86	50.51	3.43	34.11	34.91	Average	198	300	VERTICAL
3	5174.55	103.09			100.40	3.44	34.16	34.91	Average	198	300	VERTICAL
4	5175.19	113.78			111.09	3.44	34.16	34.91	Peak	198	300	VERTICAL

Item 3, 4 are the fundamental frequency at 5180 MHz.

**Channel 40**

	Freq	Level	Limit Line	Over Limit	Read Level	Cable Loss	Antenna Factor	Preamp Factor	Remark	A/Pos	T/Pos	Pol/Phase
	MHz	dBuV/m	dBuV/m	dB	dBuV	dB	dB/m	dB		cm	deg	
1	5150.00	50.76	54.00	-3.24	48.13	3.43	34.11	34.91	Average	203	299	VERTICAL
2	5150.00	67.16	74.00	-6.84	64.53	3.43	34.11	34.91	Peak	203	299	VERTICAL
3	5191.99	115.82			113.11	3.44	34.18	34.91	Peak	203	299	VERTICAL
4	5204.81	104.79			102.07	3.45	34.18	34.91	Average	203	299	VERTICAL
5	5382.05	66.96	74.00	-7.04	63.94	3.50	34.44	34.92	Peak	203	299	VERTICAL
6	5397.28	53.29	54.00	-0.71	50.25	3.50	34.46	34.92	Average	203	299	VERTICAL

Item 3, 4 are the fundamental frequency at 5200 MHz.

**Channel 48**

	Freq	Level	Limit Line	Over Limit	Read Level	Cable Loss	Antenna Factor	Preamp Factor	Remark	A/Pos	T/Pos	Pol/Phase
	MHz	dBuV/m	dBuV/m	dB	dBuV	dB	dB/m	dB		cm	deg	
1	5097.60	51.08	54.00	-2.92	48.52	3.42	34.04	34.90	Average	207	83	VERTICAL
2	5100.00	64.62	74.00	-9.38	62.06	3.42	34.04	34.90	Peak	207	83	VERTICAL
3	5235.19	104.53			101.75	3.46	34.23	34.91	Average	207	83	VERTICAL
4	5237.60	116.51			113.73	3.46	34.23	34.91	Peak	207	83	VERTICAL
5	5364.90	52.08	54.00	-1.92	49.09	3.49	34.41	34.91	Average	207	83	VERTICAL
6	5366.83	64.77	74.00	-9.23	61.78	3.49	34.41	34.91	Peak	207	83	VERTICAL

Item 3, 4 are the fundamental frequency at 5240 MHz.

<b>Temperature</b>	25°C	<b>Humidity</b>	56%
<b>Test Engineer</b>	YC Chen	<b>Configurations</b>	IEEE 802.11n MCS0 40 MHz CH 38, 46 / Chain 1 + Chain 2
<b>Test Date</b>	Aug. 12, 2014	<b>Test Mode</b>	Mode 3

**Channel 38**

	Freq	Level	Limit Line	Over Limit	Read Level	Cable Loss	Antenna Factor	Preamp Factor	Remark	A/Pos	T/Pos	Pol/Phase
	MHz	dBuV/m	dBuV/m	dB	dBuV	dB	dB/m	dB		cm	deg	
1	5138.78	67.54	74.00	-6.46	64.93	3.43	34.09	34.91	Peak	197	299	VERTICAL
2	5150.00	52.50	54.00	-1.50	49.87	3.43	34.11	34.91	Average	197	299	VERTICAL
3	5176.38	95.34			92.65	3.44	34.16	34.91	Average	197	299	VERTICAL
4	5177.18	106.64			103.95	3.44	34.16	34.91	Peak	197	299	VERTICAL

Item 3, 4 are the fundamental frequency at 5190 MHz.

**Channel 46**

	Freq	Level	Limit Line	Over Limit	Read Level	Cable Loss	Antenna Factor	Preamp Factor	Remark	A/Pos	T/Pos	Pol/Phase
	MHz	dBuV/m	dBuV/m	dB	dBuV	dB	dB/m	dB		cm	deg	
1	5150.00	52.50	54.00	-1.50	49.87	3.43	34.11	34.91	Average	196	295	VERTICAL
2	5150.00	69.52	74.00	-4.48	66.89	3.43	34.11	34.91	Peak	196	295	VERTICAL
3	5214.78	100.58			97.84	3.45	34.20	34.91	Average	196	295	VERTICAL
4	5218.78	114.30			111.56	3.45	34.20	34.91	Peak	196	295	VERTICAL
5	5369.23	52.76	54.00	-1.24	49.77	3.49	34.41	34.91	Average	196	295	VERTICAL
6	5370.83	67.46	74.00	-6.54	64.47	3.49	34.41	34.91	Peak	196	295	VERTICAL

Item 3, 4 are the fundamental frequency at 5230 MHz.



<b>Temperature</b>	25°C	<b>Humidity</b>	56%
<b>Test Engineer</b>	YC Chen	<b>Configurations</b>	IEEE 802.11a 5 MHz CH 36, 42, 48 / Chain 1 + Chain 2
<b>Test Date</b>	Aug. 08, 2014 ~ Aug. 18, 2014	<b>Test Mode</b>	Mode 3

**Channel 36**

	Freq	Level	Limit Line	Over Limit	Read Level	CableAntenna Loss	Antenna Factor	Preamp Factor	Remark	A/Pos	T/Pos	Pol/Phase
	MHz	dBuV/m	dBuV/m	dB	dBuV	dB	dB/m	dB		cm	deg	
1	5105.80	52.94	54.00	-1.06	48.12	6.11	33.91	35.20	Average	188	317	VERTICAL
2	5145.66	66.42	74.00	-7.58	61.48	6.13	34.01	35.20	Peak	188	317	VERTICAL
3	5180.87	113.82			108.79	6.15	34.08	35.20	Average	188	317	VERTICAL
4	5181.45	124.09			119.06	6.15	34.08	35.20	Peak	188	317	VERTICAL

Item 3, 4 are the fundamental frequency at 5180 MHz.

**Channel 42**

	Freq	Level	Limit Line	Over Limit	Read Level	CableAntenna Loss	Antenna Factor	Preamp Factor	Remark	T/Pos	A/Pos	Pol/Phase
	MHz	dBuV/m	dBuV/m	dB	dBuV	dB	dB/m	dB		deg	cm	
1	5145.00	63.07	74.00	-10.93	60.12	4.34	33.14	34.53	Peak	290	178	VERTICAL
2	5150.00	49.87	54.00	-4.13	46.92	4.34	33.14	34.53	Average	290	178	VERTICAL
3	5208.00	111.23			108.13	4.38	33.25	34.53	Average	290	178	VERTICAL
4	5211.00	122.68			119.58	4.38	33.25	34.53	Peak	290	178	VERTICAL

Item 3, 4 are the fundamental frequency at 5210 MHz.

**Channel 48**

	Freq	Level	Limit Line	Over Limit	Read Level	CableAntenna Loss	Antenna Factor	Preamp Factor	Remark	A/Pos	T/Pos	Pol/Phase
	MHz	dBuV/m	dBuV/m	dB	dBuV	dB	dB/m	dB		cm	deg	
1	5109.20	49.81	54.00	-4.19	44.99	6.11	33.91	35.20	Average	192	321	VERTICAL
2	5138.28	62.99	74.00	-11.01	58.09	6.12	33.98	35.20	Peak	192	321	VERTICAL
3	5238.70	112.95			107.79	6.18	34.18	35.20	Average	192	321	VERTICAL
4	5240.87	124.38			119.22	6.18	34.18	35.20	Peak	192	321	VERTICAL
5	5352.20	52.28	54.00	-1.72	46.80	6.26	34.42	35.20	Average	192	321	VERTICAL
6	5353.04	60.08	74.00	-13.92	54.60	6.26	34.42	35.20	Peak	192	321	VERTICAL

Item 3, 4 are the fundamental frequency at 5240 MHz.

<b>Temperature</b>	25°C	<b>Humidity</b>	56%
<b>Test Engineer</b>	YC Chen	<b>Configurations</b>	IEEE 802.11a 10 MHz CH 36, 42, 48 / Chain 1 + Chain 2
<b>Test Date</b>	Aug. 08, 2014 ~ Aug. 18, 2014	<b>Test Mode</b>	Mode 3

### Channel 36

	Freq	Level	Limit	Over	Read	Cable	Antenna	Preamp	Remark	A/Pos	T/Pos	Pol/Phase
	MHz	dBuV/m	dBuV/m	dB	dBuV	dB	dB/m	dB		cm	deg	
1	5137.84	50.96	54.00	-3.04	46.06	6.12	33.98	35.20	Average	187	321	VERTICAL
2	5138.13	64.59	74.00	-9.41	59.69	6.12	33.98	35.20	Peak	187	321	VERTICAL
3	5180.87	122.04			117.01	6.15	34.08	35.20	Peak	187	321	VERTICAL
4	5183.18	110.25			105.22	6.15	34.08	35.20	Average	187	321	VERTICAL

Item 3, 4 are the fundamental frequency at 5180 MHz.

### Channel 42

	Freq	Level	Limit	Over	Read	Cable	Antenna	Preamp	Remark	T/Pos	A/Pos	Pol/Phase
	MHz	dBuV/m	dBuV/m	dB	dBuV	dB	dB/m	dB		deg	cm	
1	5150.00	61.53	74.00	-12.47	58.58	4.34	33.14	34.53	Peak	289	169	VERTICAL
2	5150.00	49.32	54.00	-4.68	46.37	4.34	33.14	34.53	Average	289	169	VERTICAL
3	5208.00	119.76			116.66	4.38	33.25	34.53	Peak	289	169	VERTICAL
4	5213.00	108.42			105.32	4.38	33.25	34.53	Average	289	169	VERTICAL

Item 3, 4 are the fundamental frequency at 5210 MHz.

### Channel 48

	Freq	Level	Limit	Over	Read	Cable	Antenna	Preamp	Remark	A/Pos	T/Pos	Pol/Phase
	MHz	dBuV/m	dBuV/m	dB	dBuV	dB	dB/m	dB		cm	deg	
1	5108.89	50.72	54.00	-3.28	45.90	6.11	33.91	35.20	Average	203	340	VERTICAL
2	5140.45	64.76	74.00	-9.24	59.85	6.13	33.98	35.20	Peak	203	340	VERTICAL
3	5236.96	109.47			104.31	6.18	34.18	35.20	Average	203	340	VERTICAL
4	5237.40	121.23			116.07	6.18	34.18	35.20	Peak	203	340	VERTICAL
5	5377.35	51.28	54.00	-2.72	45.75	6.27	34.46	35.20	Average	203	340	VERTICAL
6	5378.22	64.82	74.00	-9.18	59.28	6.28	34.46	35.20	Peak	203	340	VERTICAL

Item 3, 4 are the fundamental frequency at 5240 MHz.

<b>Temperature</b>	25°C	<b>Humidity</b>	56%
<b>Test Engineer</b>	YC Chen	<b>Configurations</b>	IEEE 802.11a 20 MHz CH 36, 40, 48 / Chain 1 + Chain 2
<b>Test Date</b>	Aug. 11, 2014	<b>Test Mode</b>	Mode 3

**Channel 36**

	Freq	Level	Limit Line	Over Limit	Read Level	Cable Loss	Antenna Factor	Preamp Factor	Pol/Phase	A/Pos	T/Pos	Remark
	MHz	dBuV/m	dBuV/m	dB	dBuV	dB	dB/m	dB		cm	deg	
1	5149.60	70.25	74.00	-3.75	67.30	4.34	33.14	34.53	VERTICAL	199	156	Peak
2	5149.60	53.25	54.00	-0.75	50.30	4.34	33.14	34.53	VERTICAL	199	156	Average
3	5184.40	110.37			107.35	4.36	33.19	34.53	VERTICAL	199	156	Peak
4	5184.40	99.79			96.77	4.36	33.19	34.53	VERTICAL	199	156	Average

Item 3, 4 are the fundamental frequency at 5180 MHz.

**Channel 40**

	Freq	Level	Limit Line	Over Limit	Read Level	Cable Loss	Antenna Factor	Preamp Factor	Pol/Phase	A/Pos	T/Pos	Remark
	MHz	dBuV/m	dBuV/m	dB	dBuV	dB	dB/m	dB		cm	deg	
1	5148.40	59.55	74.00	-14.45	56.60	4.34	33.14	34.53	VERTICAL	176	288	Peak
2	5150.00	47.02	54.00	-6.98	44.07	4.34	33.14	34.53	VERTICAL	176	288	Average
3	5195.20	114.25			111.19	4.37	33.22	34.53	VERTICAL	176	288	Peak
4	5198.40	103.77			100.71	4.37	33.22	34.53	VERTICAL	176	288	Average

Item 3, 4 are the fundamental frequency at 5200 MHz.

**Channel 48**

	Freq	Level	Limit Line	Over Limit	Read Level	Cable Loss	Antenna Factor	Preamp Factor	Pol/Phase	A/Pos	T/Pos	Remark
	MHz	dBuV/m	dBuV/m	dB	dBuV	dB	dB/m	dB		cm	deg	
1	5150.00	56.83	74.00	-17.17	53.88	4.34	33.14	34.53	VERTICAL	187	352	Peak
2	5150.00	45.40	54.00	-8.60	42.45	4.34	33.14	34.53	VERTICAL	187	352	Average
3	5241.80	100.05			96.88	4.40	33.30	34.53	VERTICAL	187	352	Average
4	5244.80	110.79			107.62	4.40	33.30	34.53	VERTICAL	187	352	Peak
5	5351.80	60.28	74.00	-13.72	56.88	4.47	33.46	34.53	VERTICAL	187	352	Peak
6	5368.00	48.82	54.00	-5.18	45.38	4.48	33.49	34.53	VERTICAL	187	352	Average

Item 3, 4 are the fundamental frequency at 5240 MHz.

Note:

Emission level (dBuV/m) = 20 log Emission level (uV/m)

Corrected Reading: Antenna Factor + Cable Loss + Read Level - Preamp Factor = Level

## 4.6. Frequency Stability Measurement

### 4.6.1. Limit

In-band emission is maintained within the band of operation under all conditions of normal operation as specified in the user's manual.

The transmitter center frequency tolerance shall be  $\pm 20$  ppm maximum for the 5 GHz band (IEEE 802.11n specification).

### 4.6.2. Measuring Instruments and Setting

Please refer to section 5 of equipments list in this report. The following table is the setting of the spectrum analyzer.

Spectrum Parameter	Setting
Attenuation	Auto
Span Frequency	Entire absence of modulation emissions bandwidth
RBW	10 kHz
VBW	10 kHz
Sweep Time	Auto

### 4.6.3. Test Procedures

1. The transmitter output (antenna port) was connected to the spectrum analyzer.
2. EUT have transmitted absence of modulation signal and fixed channelize.
3. Set the spectrum analyzer span to view the entire absence of modulation emissions bandwidth.
4. Set RBW = 10 kHz, VBW = 10 kHz with peak detector and maxhold settings.
5.  $f_c$  is declaring of channel frequency. Then the frequency error formula is  $(f_c - f)/f_c \times 10^6$  ppm and the limit is less than  $\pm 20$  ppm (IEEE 802.11n specification).
6. The test extreme voltage is to change the primary supply voltage from 85 to 115 percent of the nominal value
7. Extreme temperature is  $-40^\circ\text{C} \sim 60^\circ\text{C}$ .

### 4.6.4. Test Setup Layout

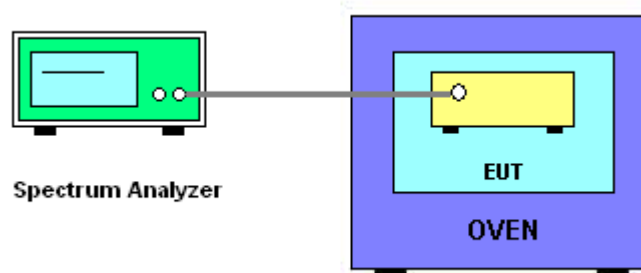

#### 4.6.5. Test Deviation

There is no deviation with the original standard.

#### 4.6.6. EUT Operation during Test

The EUT was programmed to be in continuously un-modulation transmitting mode.

#### 4.6.7. Test Result of Frequency Stability

<b>Temperature</b>	26°C	<b>Humidity</b>	63%
<b>Test Engineer</b>	Jim Huang	<b>Test Date</b>	Aug. 21, 2014

#### Voltage vs. Frequency Stability

Voltage	Measurement Frequency (MHz)
(V)	5200 MHz
126.50	5199.9712
110.00	5199.9720
93.50	5199.9736
Max. Deviation (MHz)	0.028800
Max. Deviation (ppm)	5.54

#### Temperature vs. Frequency Stability

Temperature	Measurement Frequency (MHz)
(°C)	5200 MHz
-40	5199.9762
-30	5199.9750
-20	5199.9738
-10	5199.9722
0	5199.9732
10	5199.9728
20	5199.9720
30	5199.9722
40	5199.9712
50	5199.9706
60	5199.9700
Max. Deviation (MHz)	0.030000
Max. Deviation (ppm)	5.77

## 4.7. Antenna Requirements

### 4.7.1. Limit

Except for special regulations, the Low-power Radio-frequency Devices must not be equipped with any jacket for installing an antenna with extension cable. An intentional radiator shall be designed to ensure that no antenna other than that furnished by the responsible party shall be used with the device. The use of a permanently attached antenna or of an antenna that uses a unique coupling to the intentional radiator shall be considered sufficient to comply with the provisions of this Section. The manufacturer may design the unit so that the user can replace a broken antenna, but the use of a standard antenna jack or electrical connector is prohibited. Further, this requirement does not apply to intentional radiators that must be professionally installed.

### 4.7.2. Antenna Connector Construction

Please refer to section 3.3 in this test report; antenna connector complied with the requirements.

## 5. LIST OF MEASURING EQUIPMENTS

Instrument	Manufacturer	Model No.	Serial No.	Characteristics	Calibration Date	Remark
Horn Antenna	EMCO	3115	00075790	750MHz~18GHz	Nov. 01, 2013	Radiation (03CH01-CB)
Horn Antenna	Schwarzbeck	BBHA 9170	BBHA9170252	15GHz ~ 40GHz	Dec. 17, 2013	Radiation (03CH01-CB)
Pre-Amplifier	Agilent	8449B	3008A02310	1GHz ~ 26.5GHz	Dec. 16, 2013	Radiation (03CH01-CB)
Pre-Amplifier	WM	TF-130N-R1	923365	26GHz ~ 40GHz	Oct. 23, 2013	Radiation (03CH01-CB)
Spectrum analyzer	R&S	FSP40	100019	9kHz~40GHz	Dec. 02, 2013	Radiation (03CH01-CB)
Turn Table	INN CO	CO 2000	N/A	0 ~ 360 degree	N.C.R.	Radiation (03CH01-CB)
Antenna Mast	INN CO	CO 2000	N/A	1 m - 4 m	N.C.R.	Radiation (03CH01-CB)
RF Cable-high	Woken	High Cable-3	N/A	1 GHz - 40 GHz	Nov. 17, 2013	Radiation (03CH01-CB)
RF Cable-high	Woken	High Cable-4	N/A	1 GHz - 40 GHz	Nov. 17, 2013	Radiation (03CH01-CB)
Signal analyzer	R&S	FSV40	100979	9kHz~40GHz	Nov. 29, 2013	Conducted (TH01-CB)
Temp. and Humidity Chamber	Ten Billion	TTH-D3SP	TBN-931011	-30~100 degree	Jun. 03, 2014	Conducted (TH01-CB)
Signal Generator	R&S	SMR40	100302	10MHz-40GHz	Dec. 02, 2013	Conducted (TH01-CB)
RF Power Divider	Woken	2 Way	0120A02056002D	2GHz ~ 18GHz	Nov. 17, 2013	Conducted (TH01-CB)
RF Power Divider	Woken	3 Way	MDC2366	2GHz ~ 18GHz	Nov. 17, 2013	Conducted (TH01-CB)
RF Power Divider	Woken	4 Way	0120A04056002D	2GHz ~ 18GHz	Nov. 17, 2013	Conducted (TH01-CB)
Signal generator	R&S	SMU200A	102782	25MHz-6GHz	Nov. 15, 2013	Conducted (TH01-CB)
Horn Antenna	EMCO	3115	00075790	750MHz~18GHz	Nov. 01, 2013	Conducted (TH01-CB)
Horn Antenna	COM-POWER	AH-118	071042	1GHz ~ 18GHz	Nov. 20, 2013	Conducted (TH01-CB)
RF Cable-high	Woken	High Cable-7	-	1 GHz ~ 26.5 GHz	Nov. 17, 2013	Conducted (TH01-CB)
RF Cable-high	Woken	High Cable-8	-	1 GHz ~ 26.5 GHz	Nov. 17, 2013	Conducted (TH01-CB)
RF Cable-high	Woken	High Cable-9	-	1 GHz ~ 26.5 GHz	Nov. 17, 2013	Conducted (TH01-CB)
RF Cable-high	Woken	High Cable-10	-	1 GHz ~ 26.5 GHz	Nov. 17, 2013	Conducted (TH01-CB)



Instrument	Manufacturer	Model No.	Serial No.	Characteristics	Calibration Date	Remark
RF Cable-high	Woken	High Cable-11	-	1 GHz – 26.5 GHz	Nov. 17, 2013	Conducted (TH01-CB)
Power Sensor	Anritsu	MA2411B	0917223	300MHz~40GHz	Sep. 18, 2013	Conducted (TH01-CB)
Power Meter	Anritsu	ML2495A	1035008	300MHz~40GHz	Sep. 18, 2013	Conducted (TH01-CB)

Note: Calibration Interval of instruments listed above is one year.

“\*” Calibration Interval of instruments listed above is two years.

NCR means Non-Calibration required.



## 6. MEASUREMENT UNCERTAINTY

Test Items	Uncertainty	Remark
Radiated Emission (30MHz ~ 1,000MHz)	3.6 dB	Confidence levels of 95%
Radiated Emission (1GHz ~ 18GHz)	3.7 dB	Confidence levels of 95%
Radiated Emission (18GHz ~ 40GHz)	3.5 dB	Confidence levels of 95%
Conducted Emission	1.7 dB	Confidence levels of 95%

## Appendix A. Test Photos

## 1. Photographs of Radiated Emissions Test Configuration

Test Configuration: Above 1GHz / Mode 1. EUT + Ant. 1

FRONT VIEW

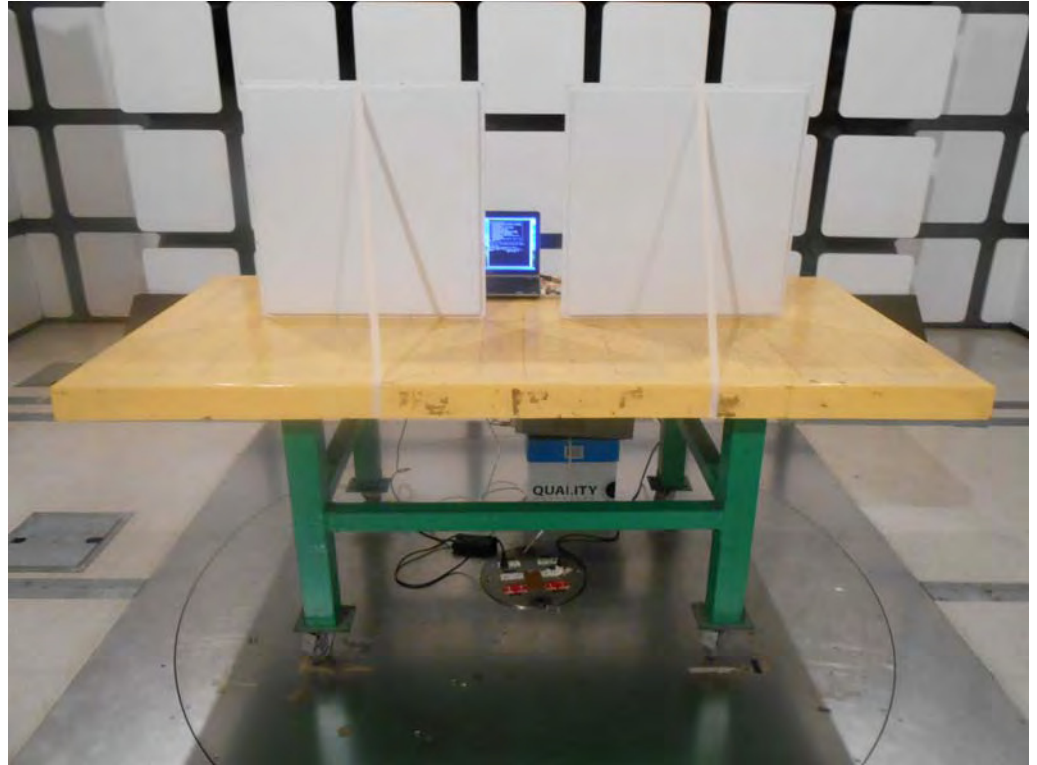

REAR VIEW

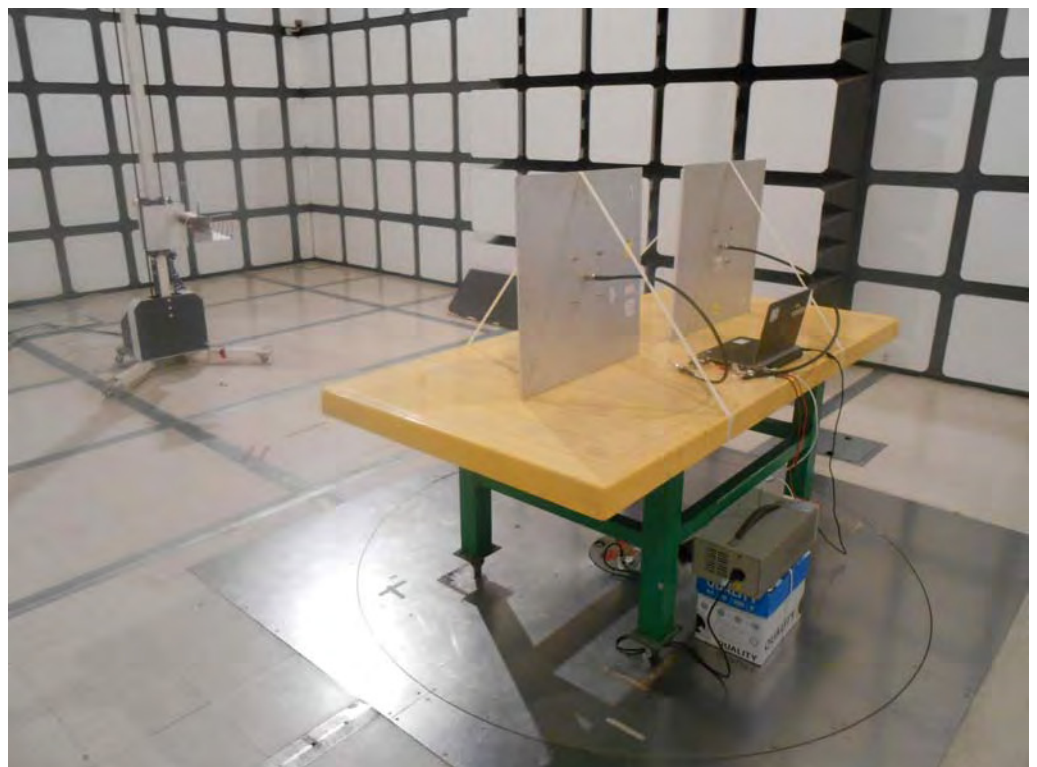

SIDE VIEW



Mode 2. EUT + Ant. 2

FRONT VIEW

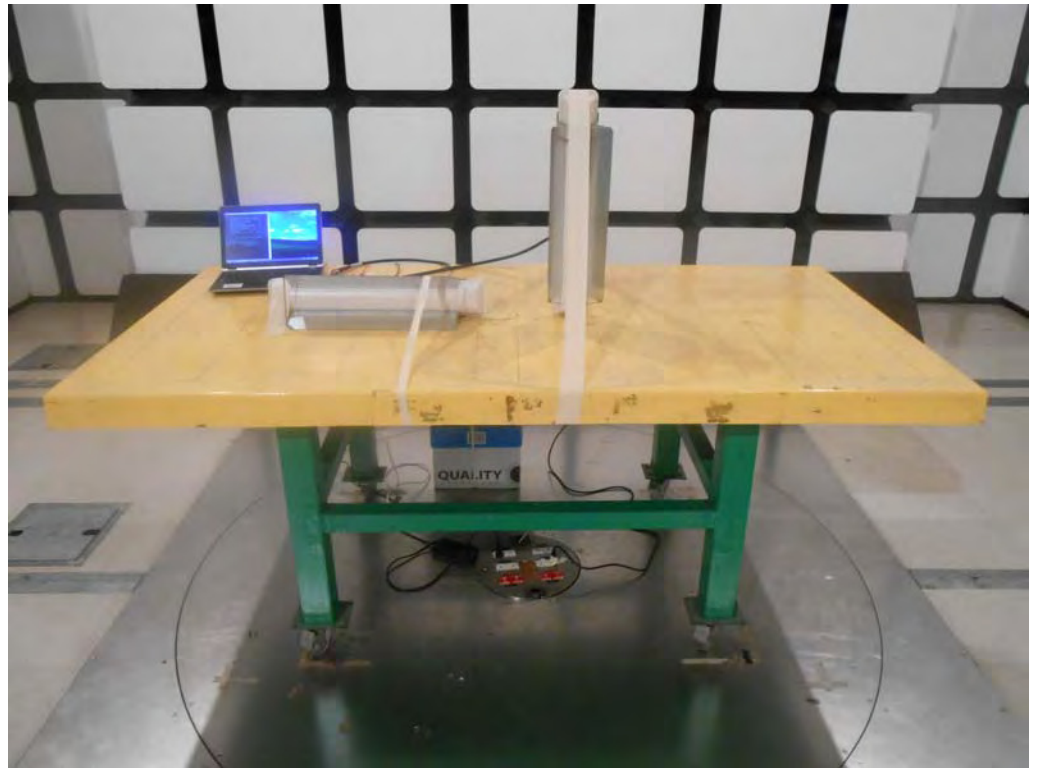

REAR VIEW





SIDE VIEW



Mode 3. EUT + Ant. 3

FRONT VIEW

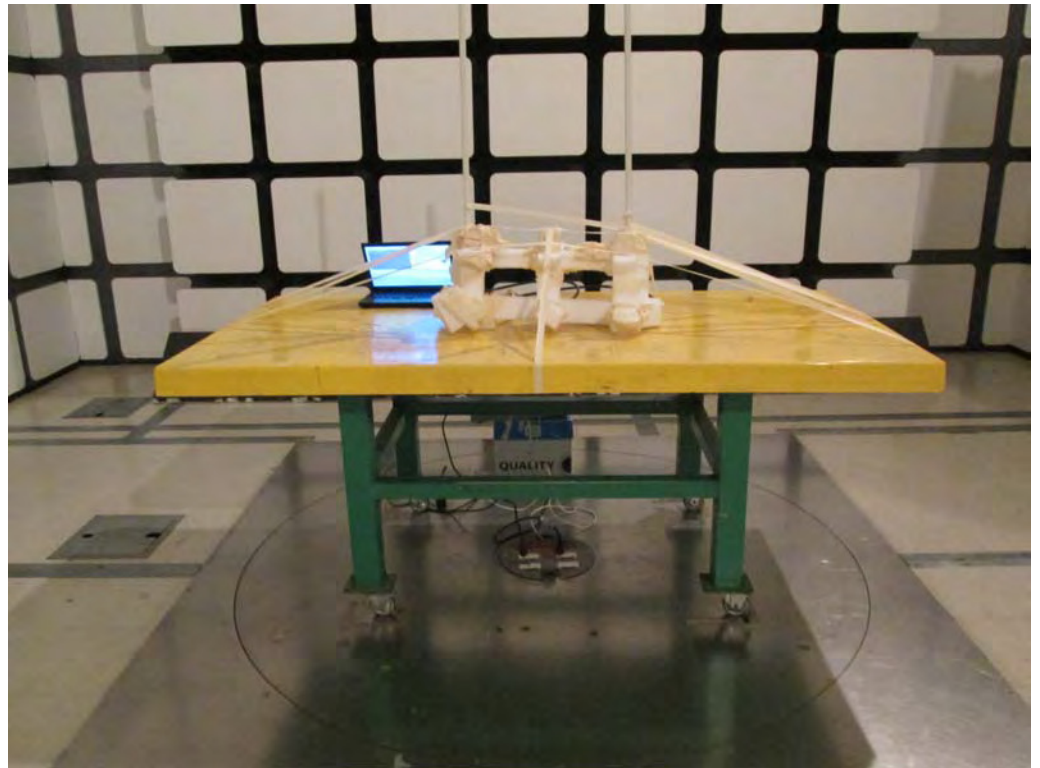

REAR VIEW

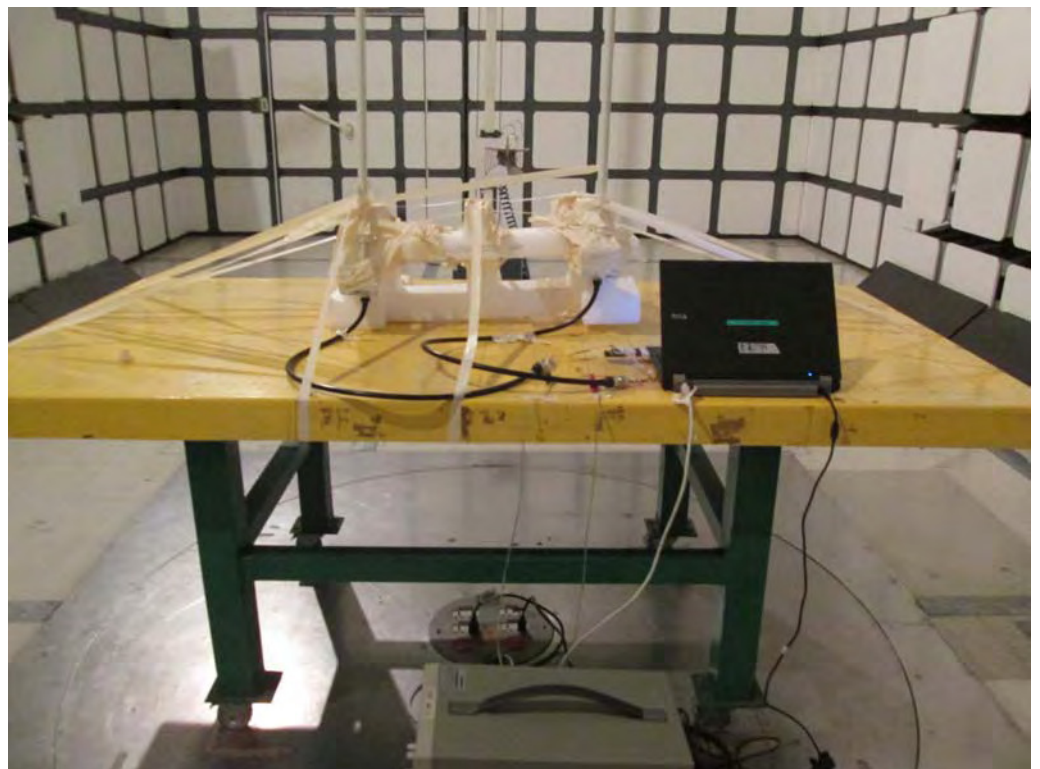

SIDE VIEW





## Appendix B. Maximum Permissible Exposure

## 1. Maximum Permissible Exposure

### 1.1. Applicable Standard

Systems operating under the provisions of this section shall be operated in a manner that ensures that the public is not exposed to radio frequency energy levels in excess limit for maximum permissible exposure. In accordance with 47 CFR FCC Part 2 Subpart J, section 2.1091 this device has been defined as a mobile device whereby a distance of 0.2 m normally can be maintained between the user and the device.

(A) Limits for Occupational / Controlled Exposure

Frequency Range (MHz)	Electric Field Strength (E) (V/m)	Magnetic Field Strength (H) (A/m)	Power Density (S) (mW/ cm <sup>2</sup> )	Averaging Time  E  <sup>2</sup> ,  H  <sup>2</sup> or S (minutes)
0.3-3.0	614	1.63	(100)*	6
3.0-30	1842 / f	4.89 / f	(900 / f)*	6
30-300	61.4	0.163	1.0	6
300-1500			F/300	6
1500-100,000			5	6

(B) Limits for General Population / Uncontrolled Exposure

Frequency Range (MHz)	Electric Field Strength (E) (V/m)	Magnetic Field Strength (H) (A/m)	Power Density (S) (mW/ cm <sup>2</sup> )	Averaging Time  E  <sup>2</sup> ,  H  <sup>2</sup> or S (minutes)
0.3-1.34	614	1.63	(100)*	30
1.34-30	824/f	2.19/f	(180/f)*	30
30-300	27.5	0.073	0.2	30
300-1500			F/1500	30
1500-100,000			1.0	30

Note: f = frequency in MHz ; \*Plane-wave equivalent power density

### 1.2. MPE Calculation Method

$$E \text{ (V/m)} = \frac{\sqrt{30 \times P \times G}}{d} \quad \text{Power Density: } Pd \text{ (W/m}^2\text{)} = \frac{E^2}{377}$$

**E** = Electric field (V/m)

**P** = Average RF output power (W)

**G** = EUT Antenna numeric gain (numeric)

**d** = Separation distance between radiator and human body (m)

The formula can be changed to

$$Pd = \frac{30 \times P \times G}{377 \times d^2}$$

From the EUT RF output power, the minimum mobile separation distance, d=0.2m, as well as the gain of the used antenna, the RF power density can be obtained.

### 1.3. Calculated Result and Limit

Exposure Environment: General Population / Uncontrolled Exposure

For 5GHz UNII Band:

Antenna Type : Panel Antenna

Conducted Power for IEEE 802.11n MCS0 5MHz : 17.26 dBm

Distance (m)	Antenna Gain (dBi)	Antenna Gain (numeric)	The maximum combined Average Output Power		Power Density (S) (mW/cm <sup>2</sup> )	Limit of Power Density (S) (mW/cm <sup>2</sup> )	Test Result
			(dBm)	(mW)			
0.2	16	39.8107	17.2588	53.1964	0.421534	1	Complies

## Appendix C. Maximum e.i.r.p. at any elevation angle above 30 degrees

## 1. Maximum e.i.r.p. at any elevation angle above 30 degrees

Antenna Type : Panel Antenna (Ant. 1)

Mode	Bandwidth (MHz)	Frequency (MHz)	Setting	Maximum Conducted Output Power (dBm)	Attenuator (dB)	Cable loss (dB)	Elevation angle above 30° Max gain (dBi)	Elevation angle above 30° Max EIRP (dBm)	Limit (dBm)	Complies
Configuration IEEE 802.11a	5	5180	9	14.38	20.00	2.00	4.046	-3.57	21	Pass
		5210	9	14.40	20.00	2.00	4.046	-3.55	21	Pass
		5240	9	14.40	20.00	2.00	4.046	-3.56	21	Pass
Configuration IEEE 802.11n	5	5180	9	14.42	20.00	2.00	4.046	-3.53	21	Pass
		5210	9	14.36	20.00	2.00	4.046	-3.59	21	Pass
		5240	9	14.28	20.00	2.00	4.046	-3.67	21	Pass
Configuration IEEE 802.11a	10	5180	11	16.90	20.00	2.00	4.046	-1.05	21	Pass
		5210	11.5	17.14	20.00	2.00	4.046	-0.81	21	Pass
		5240	11	16.41	20.00	2.00	4.046	-1.55	21	Pass
Configuration IEEE 802.11n	10	5180	11	16.79	20.00	2.00	4.046	-1.16	21	Pass
		5210	11.5	17.12	20.00	2.00	4.046	-0.84	21	Pass
		5240	11.5	16.76	20.00	2.00	4.046	-1.19	21	Pass
Configuration IEEE 802.11a	20	5180	11.5	17.22	20.00	2.00	4.046	-0.73	21	Pass
		5200	11.5	17.04	20.00	2.00	4.046	-0.92	21	Pass
		5240	12	17.16	20.00	2.00	4.046	-0.80	21	Pass
Configuration IEEE 802.11n	20	5180	11	16.75	20.00	2.00	4.046	-1.20	21	Pass
		5200	11.5	17.09	20.00	2.00	4.046	-0.87	21	Pass
		5240	12	17.13	20.00	2.00	4.046	-0.83	21	Pass
Configuration IEEE 802.11n	40	5190	8	13.90	20.00	2.00	4.046	-4.05	21	Pass
		5230	10.5	16.93	20.00	2.00	4.046	-1.02	21	Pass

## Antenna Type : Sector Antenna (Ant. 2)

Mode	Bandwidth (MHz)	Frequency (MHz)	Setting	Maximum Conducted Output Power (dBm)	Attenuator (dB)	Cable loss (dB)	Elevation angle above 30° Max gain (dBi)	Elevation angle above 30° Max EIRP (dBm)	Limit (dBm)	Complies
Configuration IEEE 802.11a	5	5180	15	20.81	10.00	2.00	-1.589	7.22	21	Pass
		5210	15	20.67	10.00	2.00	-1.589	7.08	21	Pass
		5240	16	21.35	10.00	2.00	-1.589	7.76	21	Pass
Configuration IEEE 802.11n	5	5180	14.5	20.38	10.00	2.00	-1.589	6.79	21	Pass
		5210	14.5	20.27	10.00	2.00	-1.589	6.69	21	Pass
		5240	16.5	21.87	10.00	2.00	-1.589	8.28	21	Pass
Configuration IEEE 802.11a	10	5180	16	21.66	10.00	2.00	-1.589	8.07	21	Pass
		5210	16	21.65	10.00	2.00	-1.589	8.06	21	Pass
		5240	16.5	21.64	10.00	2.00	-1.589	8.05	21	Pass
Configuration IEEE 802.11n	10	5180	16	21.56	10.00	2.00	-1.589	7.97	21	Pass
		5210	15.5	20.88	10.00	2.00	-1.589	7.29	21	Pass
		5240	16.5	21.71	10.00	2.00	-1.589	8.12	21	Pass
Configuration IEEE 802.11a	20	5180	13.5	19.11	10.00	2.00	-1.589	5.53	21	Pass
		5200	16	21.31	10.00	2.00	-1.589	7.72	21	Pass
		5240	16.5	21.73	10.00	2.00	-1.589	8.14	21	Pass
Configuration IEEE 802.11n	20	5180	13	18.54	10.00	2.00	-1.589	4.96	21	Pass
		5200	16.5	21.90	10.00	2.00	-1.589	8.31	21	Pass
		5240	16.5	21.73	10.00	2.00	-1.589	8.14	21	Pass
Configuration IEEE 802.11n	40	5190	9	15.12	10.00	2.00	-1.589	1.53	21	Pass
		5230	14.5	21.01	10.00	2.00	-1.589	7.42	21	Pass

**Antenna Type : Omni Antenna (Ant. 3)**

Mode	Bandwidth (MHz)	Frequency (MHz)	Setting	Maximum Conducted Output Power (dBm)	Attenuator (dB)	Cable loss (dB)	Elevation angle above 30° Max gain (dBi)	Elevation angle above 30° Max EIRP (dBm)	Limit (dBm)	Complies
Configuration IEEE 802.11a	5	5180	13.5	19.33	0.00	2.00	-2.725	14.60	21	Pass
		5210	13.5	19.27	0.00	2.00	-2.725	14.55	21	Pass
		5240	14	19.21	0.00	2.00	-2.725	14.48	21	Pass
Configuration IEEE 802.11n	5	5180	13.5	19.25	0.00	2.00	-2.725	14.52	21	Pass
		5210	13.5	19.31	0.00	2.00	-2.725	14.59	21	Pass
		5240	14	19.20	0.00	2.00	-2.725	14.48	21	Pass
Configuration IEEE 802.11a	10	5180	16	21.66	0.00	2.00	-2.725	16.93	21	Pass
		5210	15	20.57	0.00	2.00	-2.725	15.84	21	Pass
		5240	16	21.30	0.00	2.00	-2.725	16.58	21	Pass
Configuration IEEE 802.11n	10	5180	16.5	22.23	0.00	2.00	-2.725	17.50	21	Pass
		5210	14.5	19.96	0.00	2.00	-2.725	15.24	21	Pass
		5240	17	22.17	0.00	2.00	-2.725	17.44	21	Pass
Configuration IEEE 802.11a	20	5180	15.5	21.09	0.00	2.00	-2.725	16.36	21	Pass
		5200	15.5	20.97	0.00	2.00	-2.725	16.24	21	Pass
		5240	18.5	22.95	0.00	2.00	-2.725	18.23	21	Pass
Configuration IEEE 802.11n	20	5180	13.5	18.95	0.00	2.00	-2.725	14.23	21	Pass
		5200	16.5	21.90	0.00	2.00	-2.725	17.18	21	Pass
		5240	18.5	22.91	0.00	2.00	-2.725	18.19	21	Pass
Configuration IEEE 802.11n	40	5190	9.5	15.77	0.00	2.00	-2.725	11.04	21	Pass
		5230	15	21.47	0.00	2.00	-2.725	16.74	21	Pass

## Antenna Type : Panel Antenna (Ant. 4)

Mode	Bandwidth (MHz)	Frequency (MHz)	Setting	Maximum Conducted Output Power (dBm)	Attenuator (dB)	Cable loss (dB)	Elevation angle above 30° Max gain (dBi)	Elevation angle above 30° Max EIRP (dBm)	Limit (dBm)	Complies
Configuration IEEE 802.11a	5	5180	9	14.38	0.00	0.00	2.146	16.53	21	Pass
		5210	9	14.40	0.00	0.00	2.146	16.55	21	Pass
		5240	9	14.40	0.00	0.00	2.146	16.54	21	Pass
Configuration IEEE 802.11n	5	5180	9	14.42	0.00	0.00	2.146	16.57	21	Pass
		5210	9	14.36	0.00	0.00	2.146	16.51	21	Pass
		5240	9	14.28	0.00	0.00	2.146	16.43	21	Pass
Configuration IEEE 802.11a	10	5180	11	16.90	0.00	0.00	2.146	19.05	21	Pass
		5210	11.5	17.14	0.00	0.00	2.146	19.29	21	Pass
		5240	11	16.41	0.00	0.00	2.146	18.55	21	Pass
Configuration IEEE 802.11n	10	5180	11	16.79	0.00	0.00	2.146	18.94	21	Pass
		5210	11.5	17.12	0.00	0.00	2.146	19.26	21	Pass
		5240	11.5	16.76	0.00	0.00	2.146	18.91	21	Pass
Configuration IEEE 802.11a	20	5180	11.5	17.22	0.00	0.00	2.146	19.37	21	Pass
		5200	11.5	17.04	0.00	0.00	2.146	19.18	21	Pass
		5240	12	17.16	0.00	0.00	2.146	19.30	21	Pass
Configuration IEEE 802.11n	20	5180	11	16.75	0.00	0.00	2.146	18.90	21	Pass
		5200	11.5	17.09	0.00	0.00	2.146	19.23	21	Pass
		5240	12	17.13	0.00	0.00	2.146	19.27	21	Pass
Configuration IEEE 802.11n	40	5190	8	13.90	0.00	0.00	2.146	16.05	21	Pass
		5230	10.5	16.93	0.00	0.00	2.146	19.08	21	Pass