

Intertek Testing Services

APPLICATION FOR FCC CERTIFICATION **U-NII Device**

Glenayre Western Multiplex
Model: 27710

FCC ID: HZB-U58/45

Job # J99014962
Report #J99014962d

Number of Pages: 17 pp. + Supporting Data and Documents

Date of Report: June 21, 1999

This report shall not be reproduced except in full, without written approval of Intertek Testing Services.

This report must not be used to claim product endorsement by NVLAP or any agency of the U.S. Government.

The results contained in this report were derived from measurements performed on the identified test samples. Any implied performance of other samples on this report is dependent on the representative of the samples tested.



Table of Contents

1.0	<u>SUMMARY OF TESTS</u>	1
2.0	<u>GENERAL DESCRIPTION</u>	2
2.1	PRODUCT DESCRIPTION	2
2.2	RELATED SUBMITTAL(S) GRANTS	2
2.3	TEST METHODOLOGY	3
2.4	TEST FACILITY	3
3.0	<u>SYSTEM TEST CONFIGURATION</u>	4
3.1	SUPPORT EQUIPMENT.....	4
3.2	BLOCK DIAGRAM OF TEST SETUP	4
3.3	JUSTIFICATION	5
3.4	SOFTWARE EXERCISE PROGRAM	5
3.5	MODE OF OPERATION DURING TEST	5
3.6	MODIFICATIONS REQUIRED FOR COMPLIANCE.....	5
3.7	ADDITIONS, DEVIATIONS AND EXCLUSIONS FROM STANDARDS	5
4.0	<u>MEASUREMENT RESULTS</u>	6
4.1	MAXIMUM CONDUCTED OUTPUT POWER AT ANTENNA TERMINALS	6
4.2	MINIMUM 6 dB RF BANDWIDTH	7
4.3	MAXIMUM POWER DENSITY READING	8
4.4	OUT OF BAND CONDUCTED EMISSIONS	9
4.5	TRANSMITTER RADIATED EMISSIONS IN RESTRICTED BANDS	10
4.6	AC LINE CONDUCTED EMISSION	12
4.7	RADIATED EMISSIONS FROM DIGITAL SECTION OF TRANSCEIVER (TRANSMITTER),.....	13
4.8	RADIATED EMISSIONS FROM RECEIVER SECTION OF TRANSCEIVER (L. O. RADIATION),.....	13
4.9	TRANSMITTER DUTY CYCLE CALCULATION AND MEASUREMENTS	15
5.0	<u>LIST OF EXHIBITS</u>	16

Glenayre Western Multiplex, U-NII Radio
FCC ID: HZB-U58/45

Date of Test: June 3-10, 1999

1.0 Summary of Tests

Glenayre Western Multiplex - MODEL: 27710
FCC ID: HZB-U58/45

TEST	REFERENCE	RESULTS
Max. Output power	15.407 (a)	Pass
26 dB Bandwidth	15.407 (a)	Not Applicable
Max. Power Density	15.407 (a) (5)	Pass
Out of Band Emissions	15.407 (b)	Pass
Radiated Emission in Restricted Bands	15.407 (b) (6), 15.205	Pass
AC Conducted Emission	15.407 (b) (5), 15.207	Pass
Radiated Emission from Digital Part	15.407 (b) (5), 15.209	Pass
Radiated Emission from Receiver L.O.	15.209	Not Applicable
Antenna Requirement	15.203	Pass

Test Engineer: Xi-Ming Yang
Xi-Ming Yang

Date: 7-15-99

EMC Site Manager: David Chernomordik
David Chernomordik

Date: 7/15/99

Glenayre Western Multiplex, U-NII Radio
FCC ID: HZB-U58/45

Date of Test: June 3-10, 1999

2.0 General Description

2.1 Product Description

The Model No.: 27710 is a U-NII Single Band Radio in the frequency range: 5.725-5.825 GHz.

A pre-production version of the sample was received on June 3, 1998 in good condition.

Overview of the product

Applicant	Glenayre Western Multiplex
Trade Name & Model No.	27710
FCC Identifier	HZB-U58/45
Use of Product	Point-to-point fixed wireless interconnect
Manufacturer	Glenayre Western Multiplex
Type of Transmission	QPSK
Rated RF Output (mW)	295 mW
Frequency Range (MHz)	5.725 – 5.825 GHz
Number of Channel(s)	2
Antenna(s) & Gain, dBi	23 dBi
Antenna Requirement	<input type="checkbox"/> The EUT uses a permanently connected antenna. <input type="checkbox"/> The antenna is affixed to the EUT using a unique connector which allows for replacement of a broken antenna, but DOES NOT use a standard antenna jack or electrical connector. <input checked="" type="checkbox"/> The EUT requires professional installation (attach supporting documentation if using this option).
Manufacturer name & address	Glenayre Western Multiplex 1196 Borregas Avenue Sunnyvale, California 94089

2.2 Related Submittal(s) Grants

None.

2.3 Test Methodology

Both AC mains line-conducted and radiated emissions measurements were performed according to the procedures in ANSI C63.4 (1992). Radiated tests were performed at an antenna to EUT distance of 3 meters, unless stated otherwise in the "**Data Sheet**" of this Application. All other measurements were made in accordance with the procedures in part 2 of CFR 47.

2.4 Test Facility

The open area test site and conducted measurement facility used to collect the radiated data is site 1. This test facility and site measurement data have been fully placed on file with the FCC and NVLAP accredited.

3.0 System Test Configuration

3.1 Support Equipment and description

The FCC ID's for all equipment used in the tested system (included inserted cards, which have grants) are:

Item #	Description	Model No.	Serial No.	FCC ID
1	EXTEH Power Supply	EP-3003	N/A	N/A
2	Telephone	M7100	N/A	N/A
3	Gabriel Antenna	DFP	N/A	N/A

3.2 Block Diagram of Test Setup

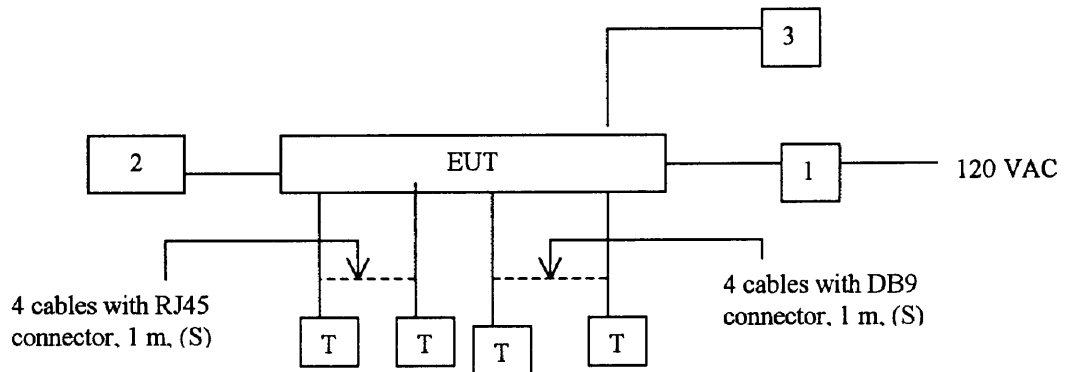

* = EUT

** = No ferrites on video cable

S = Shielded,

U = Unshielded

F = With Ferrite

T = Termination

3.3 Justification

For emission testing, the equipment under test (EUT) was configured for testing in a typical fashion (as a customer would normally use it). During testing, all cables were manipulated to produce worst case emissions.

For radiated emission measurements, the EUT is attached to a cardboard box (if necessary) and placed on the wooden turntable. If the EUT attaches to peripherals, they are connected and operational (as typical as possible). The EUT is wired to transmit full power without modulation.

The signal is maximized through rotation and placement in the three orthogonal axes. The antenna height and polarization are varied during the search for maximum signal level. The antenna height is varied from 1 to 4 meters. Detector function is in peak mode. Radiated emissions are taken at three meters unless the signal level is too low for measurement at that distance. If necessary, a pre-amplifier is used and/or the test is conducted at a closer distance.

All readings are extrapolated back to the equivalent three meter reading using inverse scaling with distance.

3.4 Software Exercise Program

The EUT exercise program used during radiated and conducted testing was designed to exercise the various system components in a manner similar to a typical use. For emissions testing, the units were setup to transmit continuously to simplify the measurement methodology. Care was taken to ensure proper power supply voltages during testing.

3.5 Mode of Operation during Test

Transmitting signal on low and high frequencies.

3.6 Modifications Required for Compliance

The following modifications were installed during compliance testing in order to bring the product into compliance (Please note that this list does not include changes made specifically by Glenayre Western Multiplex prior to compliance testing):

No modifications were made to the EUT by Intertek Testing Services.

3.7 Additions, deviations and exclusions from standards

No additions, deviations or exclusion have been made from standard.

4.0 Measurement Results

4.1 Maximum Conducted Output Power at Antenna Terminals, FCC Rules 15.407(a):

Requirement:

For fixed point-to-point U-NII devices operating in 5.725-5.825 GHz band, the peak transmit power shall not exceed the lesser of 30 dBm or $17 \text{ dBm} + 10 \text{Log}(B)$ where B is the 26dB emission bandwidth in MHz (for antenna gain up to 23 dBi).

Test Procedure

The antenna port of the EUT was connected to the input of a power meter. Power was read directly and cable loss correction was added to the reading to obtain power at the EUT antenna terminals.

Test Result

Band 5.725-5.825 GHz, Max. antenna gain = 23 dBi			
Frequency (MHz)	Output in dBm	Output in mW	Limit in mW
Low Channel: 5756.0	24.7	295.1	1000
High Channel: 5794.1	23.4	218.8	1000

Cable loss: 0 dB

External Attenuation: 0 dB

Cable loss, external attenuation: is included in OFFSET function

4.2 Minimum 26 dB RF Bandwidth, FCC Rule 15.407(a): (for calculation only)

Test Procedure

The antenna port of the EUT was connected to the input of a spectrum analyzer. Analyzer RES BW was set to 100 kHz. For each RF output channel investigated, the spectrum analyzer center frequency was set to the channel carrier. A PEAK output reading was taken, a DISPLAY line was drawn 26 dB lower than PEAK level. The 26 dB bandwidth was determined from where the channel output spectrum intersected the display line.

Test Result

Frequency (MHz)	26 dB Bandwidth (MHz)
5756.0	40.7
5794.1	40.1

Refer to the following plots for 26 dB bandwidth:

Plot 2c: 5.725-5.825 GHz band, Low Channel, 26 dB RF Bandwidth

Plot 2d: 5.725-5.825 GHz band, High Channel, 26 dB RF Bandwidth

MKR Δ 40.73 MHz
0.20 dB

Plot ZC

ATTEN 30 dB

REF 20.6 dBm

hp

10 dB/

OFFSET
0.6
dB

DL
-14.6
dBm

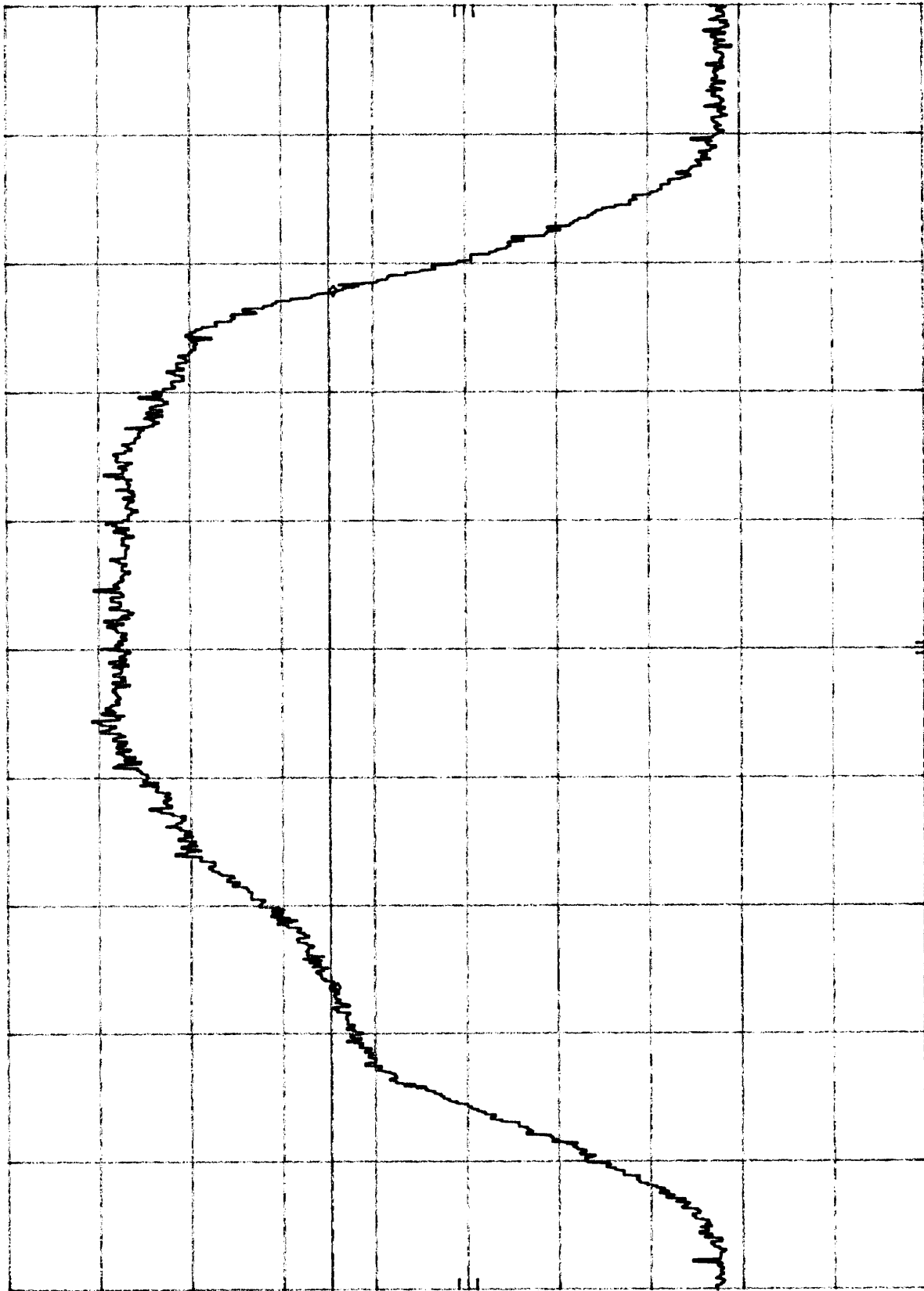

SPAN 75.0 MHz

SWP 22.5 msec

VBW 100 kHz

RES BW 100 kHz

CENTER 5.7529 GHz

MKR Δ 40.13 MHz
-0.20 dB

Plot 2d

ATTEN 20 dB

REF 10.6 dBm

hp

10 dB/

OFFSET
0.6
dB

DL
-16.8
dBm

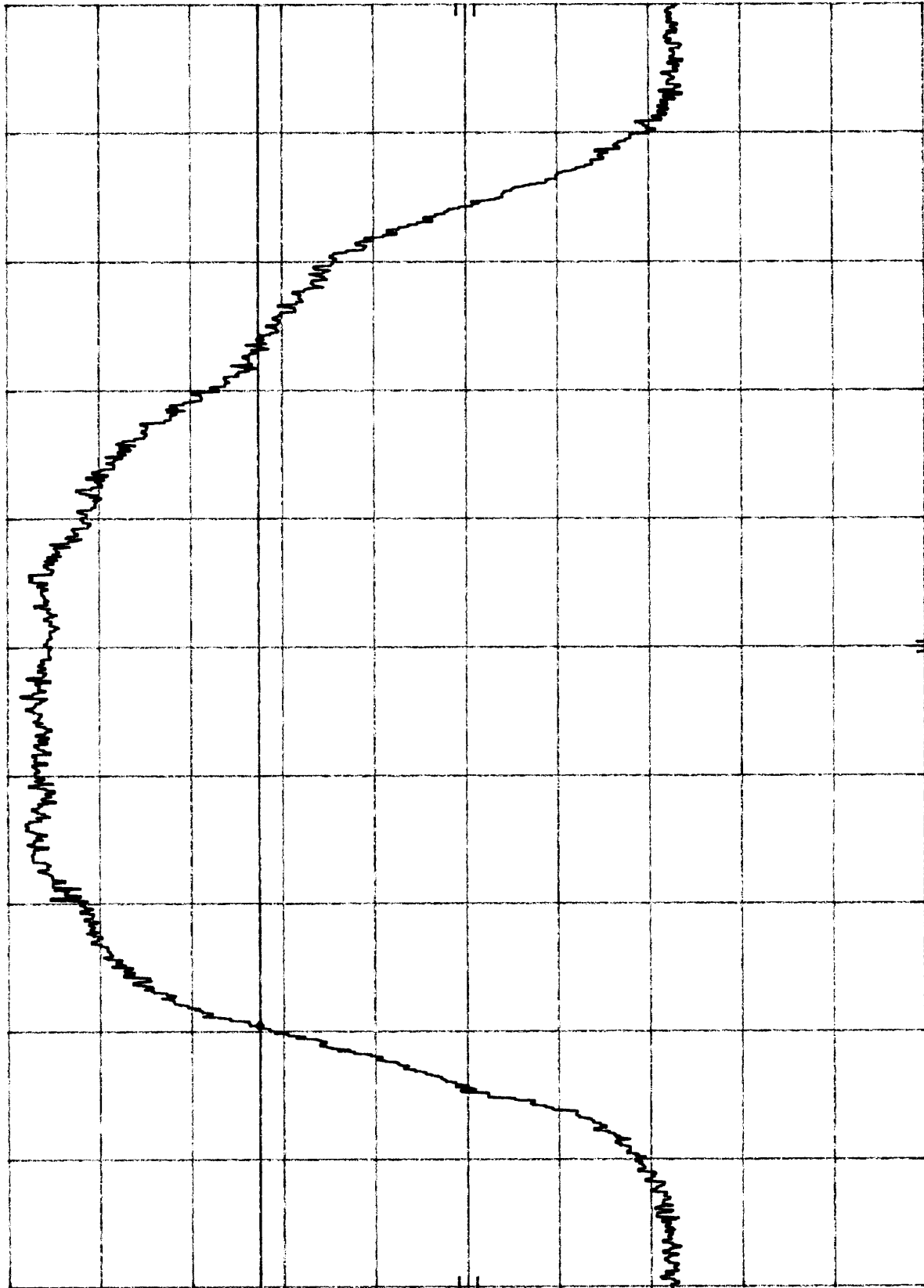

SPAN 75.0 MHz
SWP 22.5 msec

VBW 100 kHz

RES BW 100 kHz

CENTER 5.799 0 GHz

4.3 Maximum Power Density, FCC Rule 15.407(a)(3):

Requirement:

For fixed point-to-point U-NII devices operating in 5.725-5.825 GHz band the peak power spectral density shall not exceed 17 dBm in any 1 MHz band for antenna gain up to 23 dBi.

Test Procedure

Antenna output of the EUT was coupled directly to spectrum analyzer; if an external attenuator and/or cable was used, these losses are compensated for with the analyzer OFFSET function.

The spectrum analyzer Resolution and Video Bandwidths were set to 1 MHz. The START and STOP frequencies were set to the band edges of the maximum output passband. The spectrum analyzer was set to video average, 100 sweeps were used. Maximum peak-power spectral density reading was recorded.

Test Result

Frequency (MHz)	Power Density (dBm)	Limit (dBm)
5756.0	8.9	17
5794.1	8.3	17

Refer to the following plots for Power Density data:

Plot 3c: 5.725-5.825 GHz band, Low Channel Power Density

Plot 3d: 5.725-5.825 GHz band, High Channel Power Density

Plot Sc

MKR 5.750 33 GHz
8.90 dBm

ATTEN 30 dB

REF 20.6 dBm

hp

10 dB/

SAMPLE

OFFSET

0.6
dB

DL

-6.8
dBm

VID AVG

100

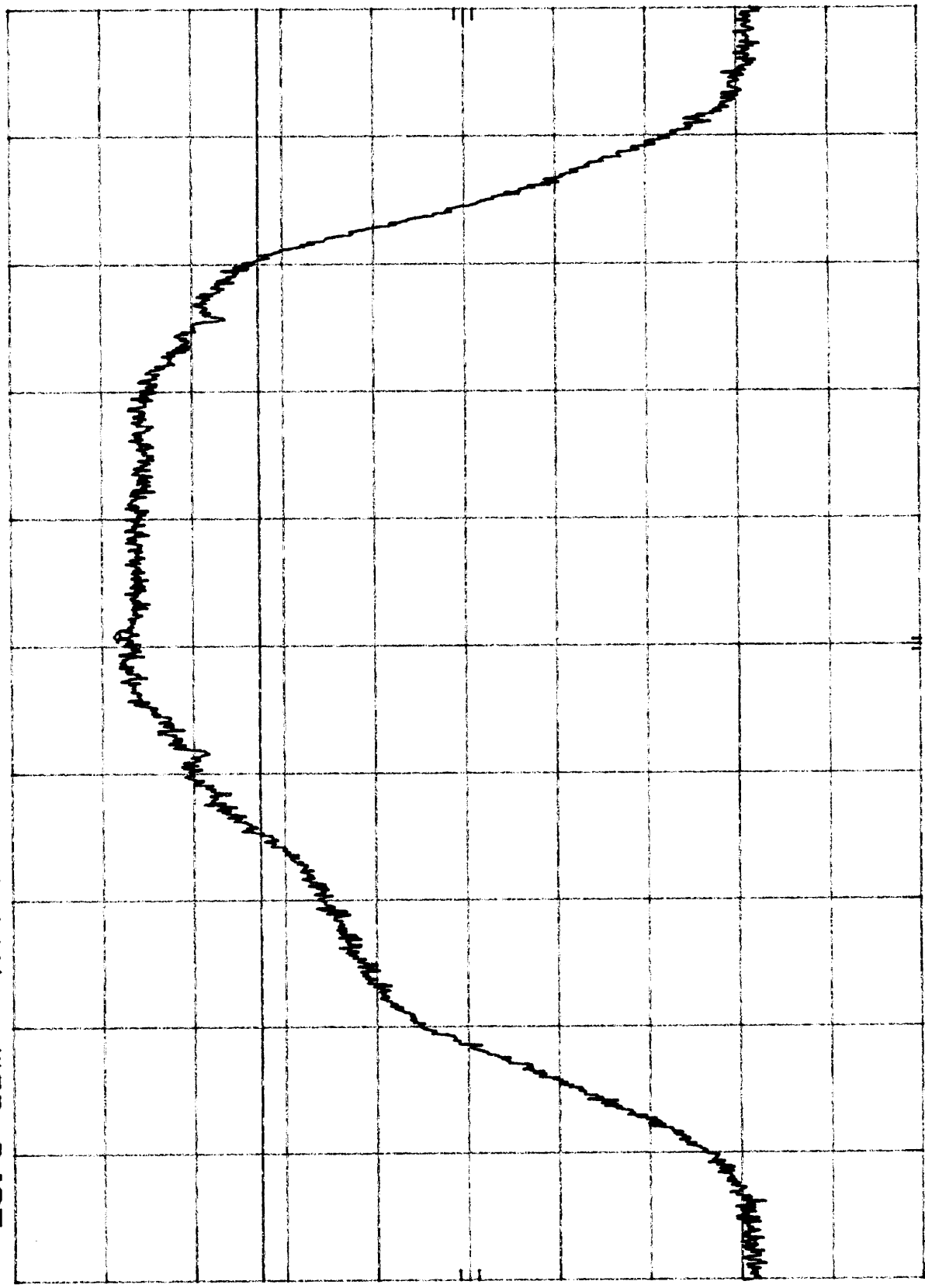

SPAN 75.0 MHz
SWP 20.0 msec

VBW 1 MHz

CENTER 5.749 8 GHz
RES BW 1 MHz

Plot 3d

MKR 5.788 13 GHz
8.30 dBm

ATTEN 30 dB

REF 20.6 dBm

hp

10 dB/

SAMPLE

OFFSET

0.6
dB

VID AVG
100

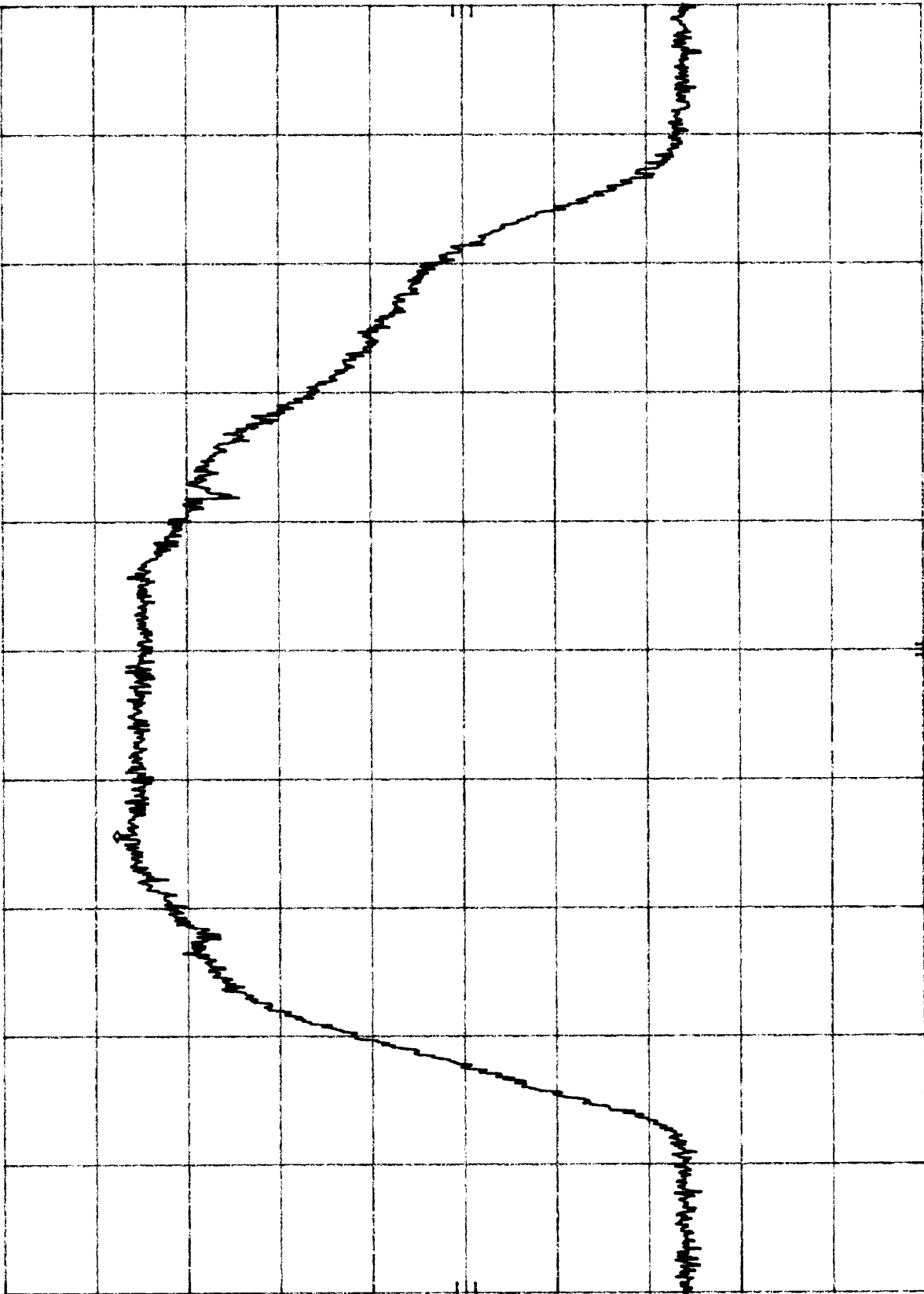

CENTER 5.799 0 GHz
RES BW 1 MHz

VBW 1 MHz

SPAN 75.0 MHz
SWP 20.0 msec

4.4 Out of Band Conducted Emissions, FCC Rule 15.407(b):

Requirement:

For transmitters operating in the 5.725-5.825 GHz band: all emissions within the frequency range from the band edge to 10 MHz above or below the band edge shall not exceed an EIRP of -17 dBm/MHz: for frequencies 10 MHz or greater above or below the band edge, emissions shall not exceed an EIRP of -27 dBm/MHz.

Test Procedure

The emission measurements shall be performed using a minimum resolution bandwidth of 1 MHz. A lower resolution bandwidth may be employed near the band edge, when necessary, provided the measured energy is integrated to show the total power over 1 MHz.

Test Result

Refer to the following plots for out of band conducted emissions data:

Plot 4c1 – 4c10: 5.725-5.825 GHz band, Low Channel Emissions

Plot 4d1 – 4d9: 5.725-5.825 GHz band, High Channel Emissions

Plot Yc1

MKR 51.69 MHz
-54.30 dBm

ATTEN 30 dB

REF 20.6 dBm

hp

10 dB/

OFFSET

0.6
dB

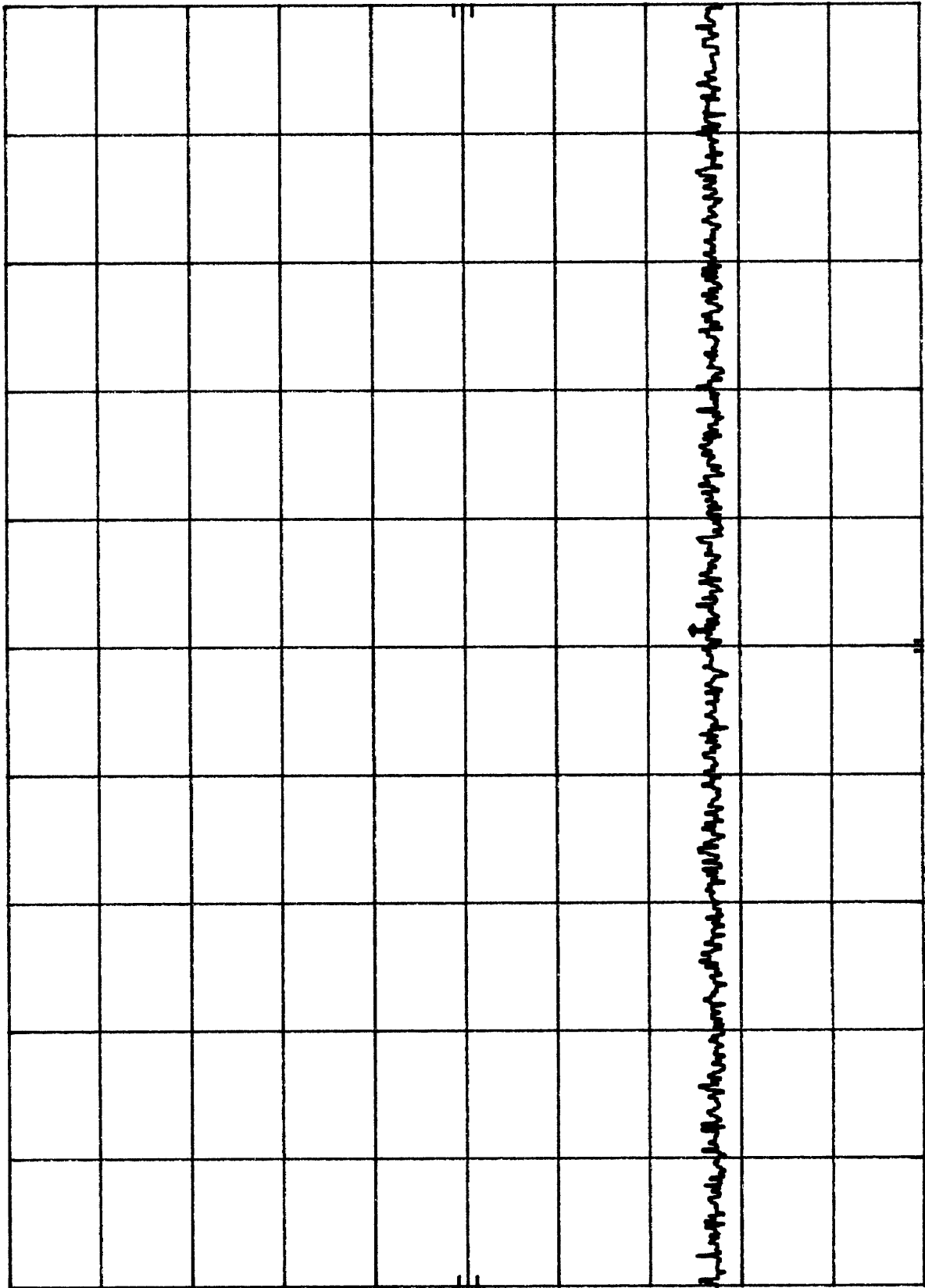

STOP 100.0 MHz
SWP 29.7 msec

VBW 100 kHz

RES BW 100 kHz

START 1.0 MHz

Plot Yc2

MKR 397.0 MHz
-54.40 dBm

REF 20.6 dBm ATTEN 30 dB

hp

10 dB/

OFFSET
0.6
dB

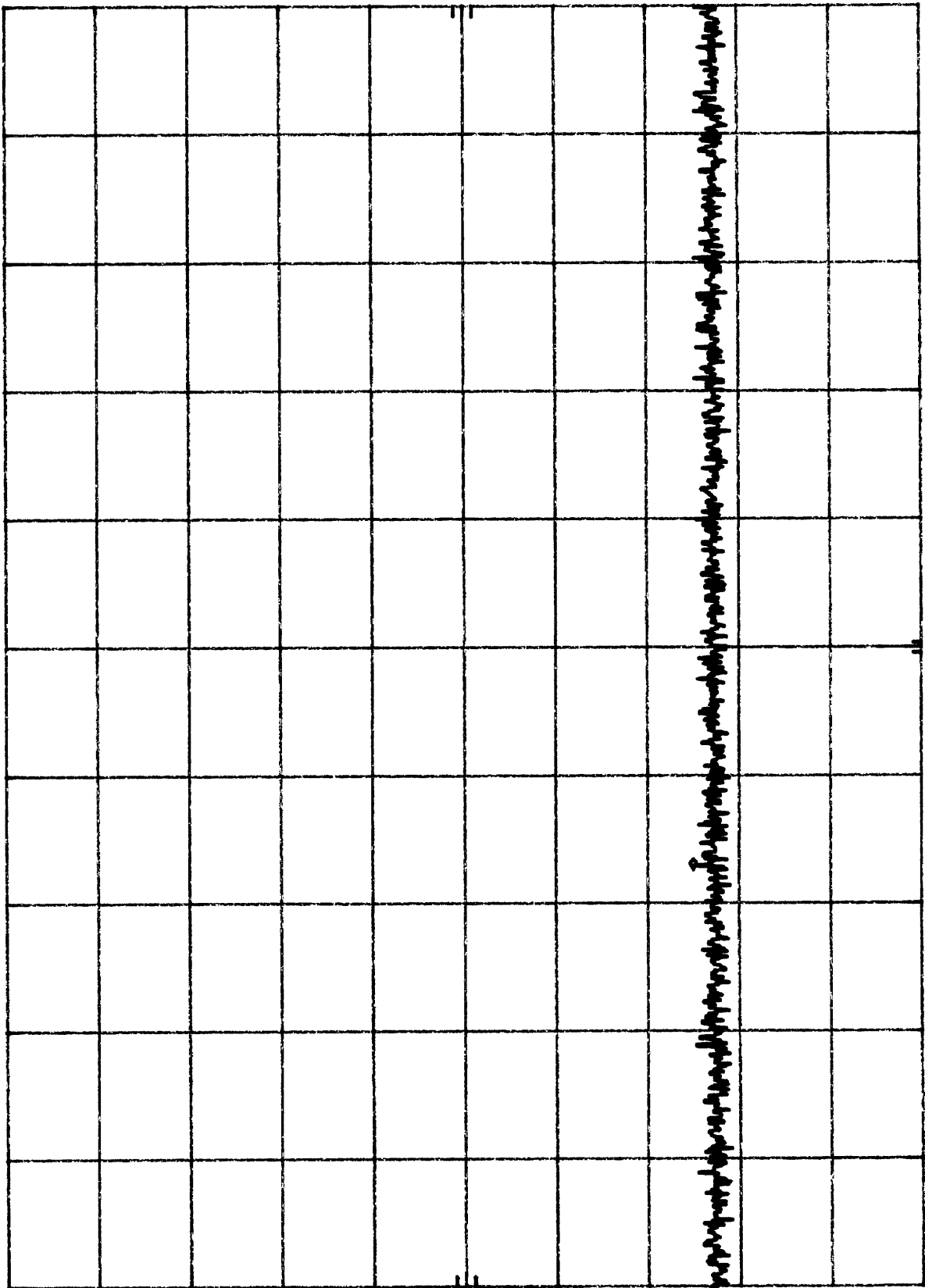

START 100 MHz RES BW 100 kHz VBW 100 kHz STOP 1.000 GHz
SWP 270 msec

MKR 2.287 GHz
-45.90 dBm

Plot YCS

ATTEN 30 dB

REF 20.6 dBm

hp

10 dB/

OFFSET
0.6
dB

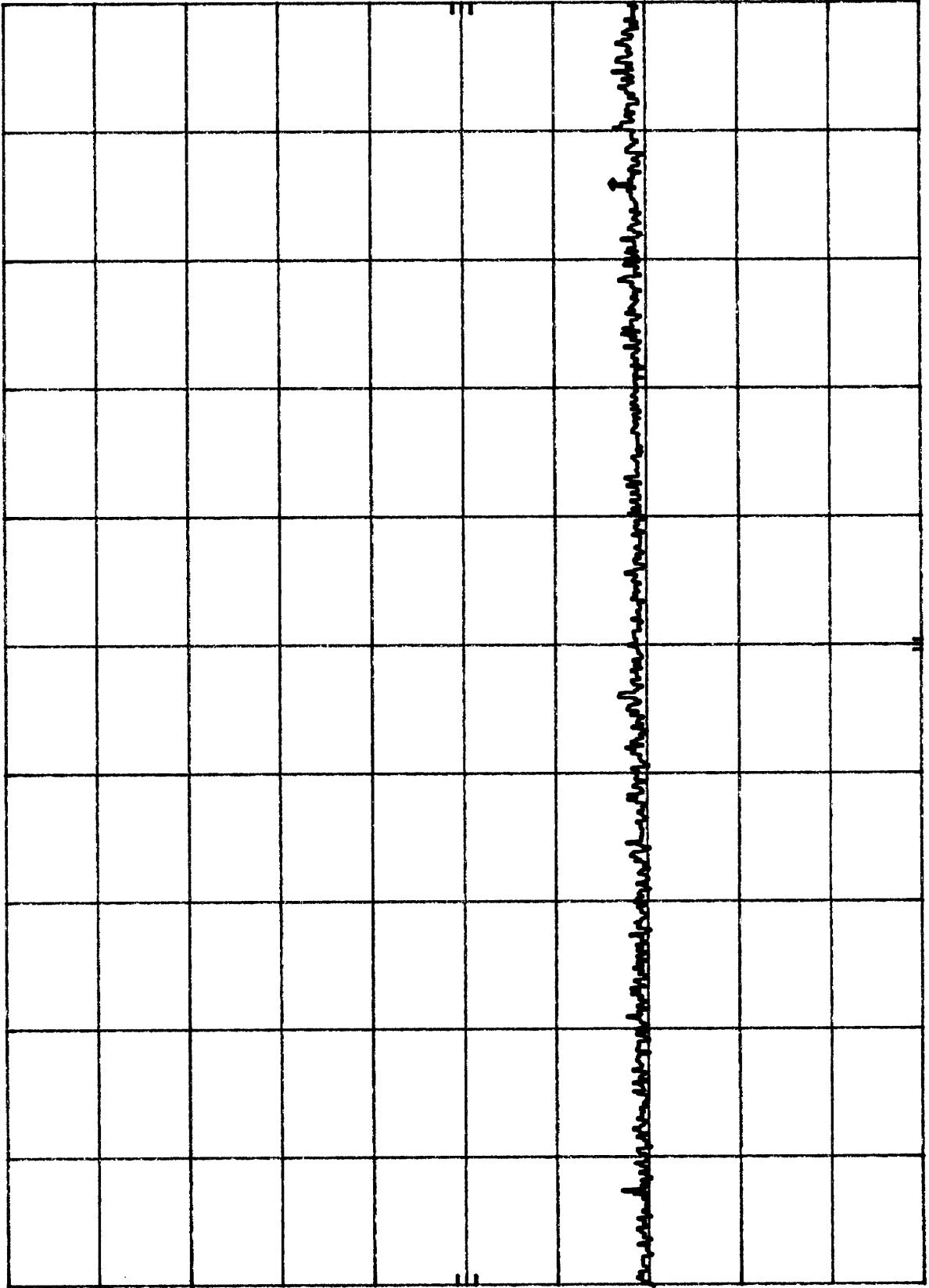

START 1.00 GHz RES BW 1 MHz VBW 1 MHz STOP 2.50 GHz
SWP 37.5 msec

Plot Yc 4

MKR 3.092 GHz
-46.60 dBm

ATTEN 30 dB

REF 20.6 dBm

hp

10 dB/

OFFSET
0.6
dB

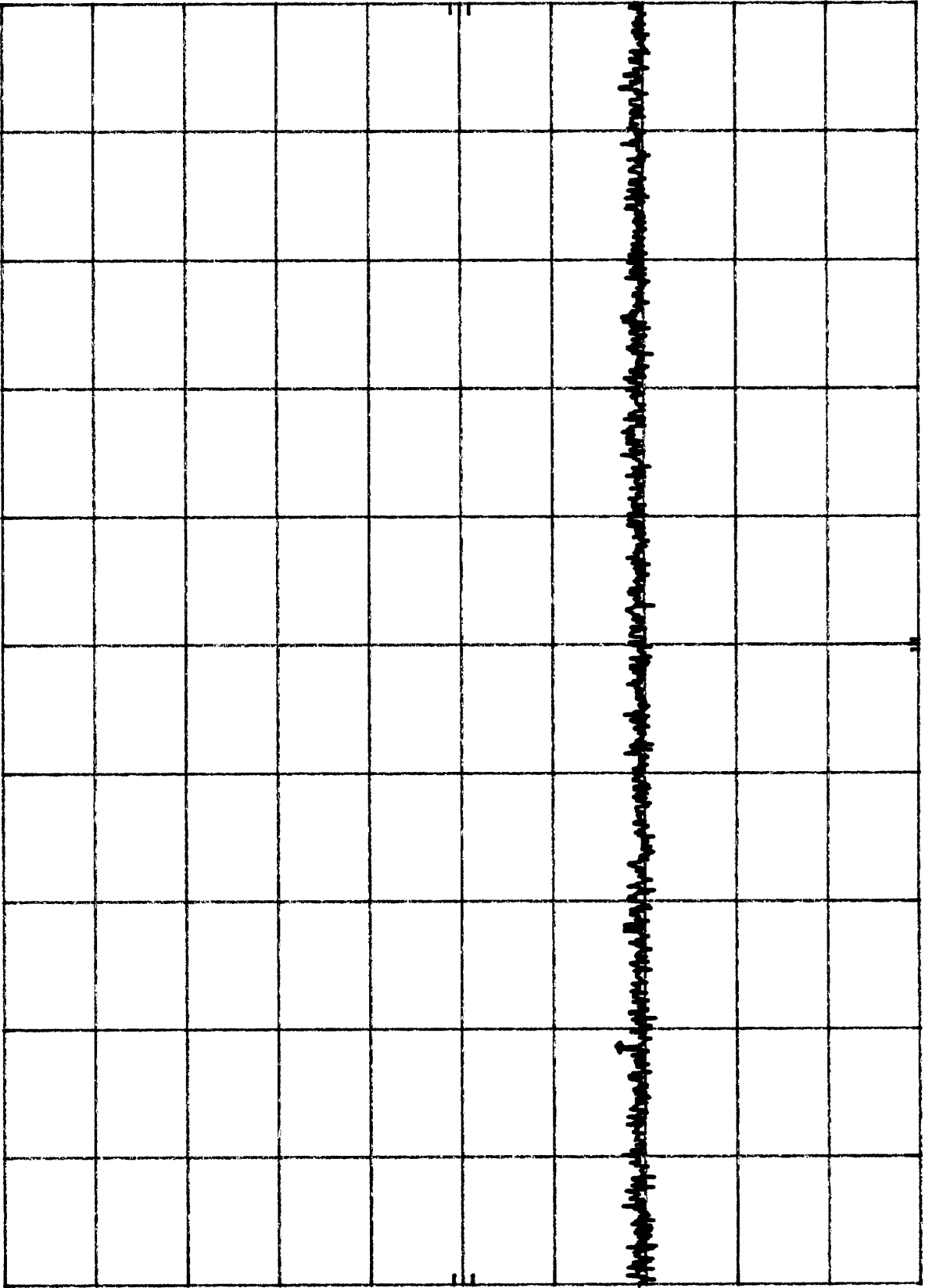

START 2.50 GHz RES BW 1 MHz VBW 1 MHz STOP 5.70 GHz
SWP 80.0 msec

MKR 5.715 00 GHz
-48.70 dBm

Plot Yes

ATTEN 30 dB

REF 20.6 dBm

hp

10 dB/

OFFSET
0.6
dB

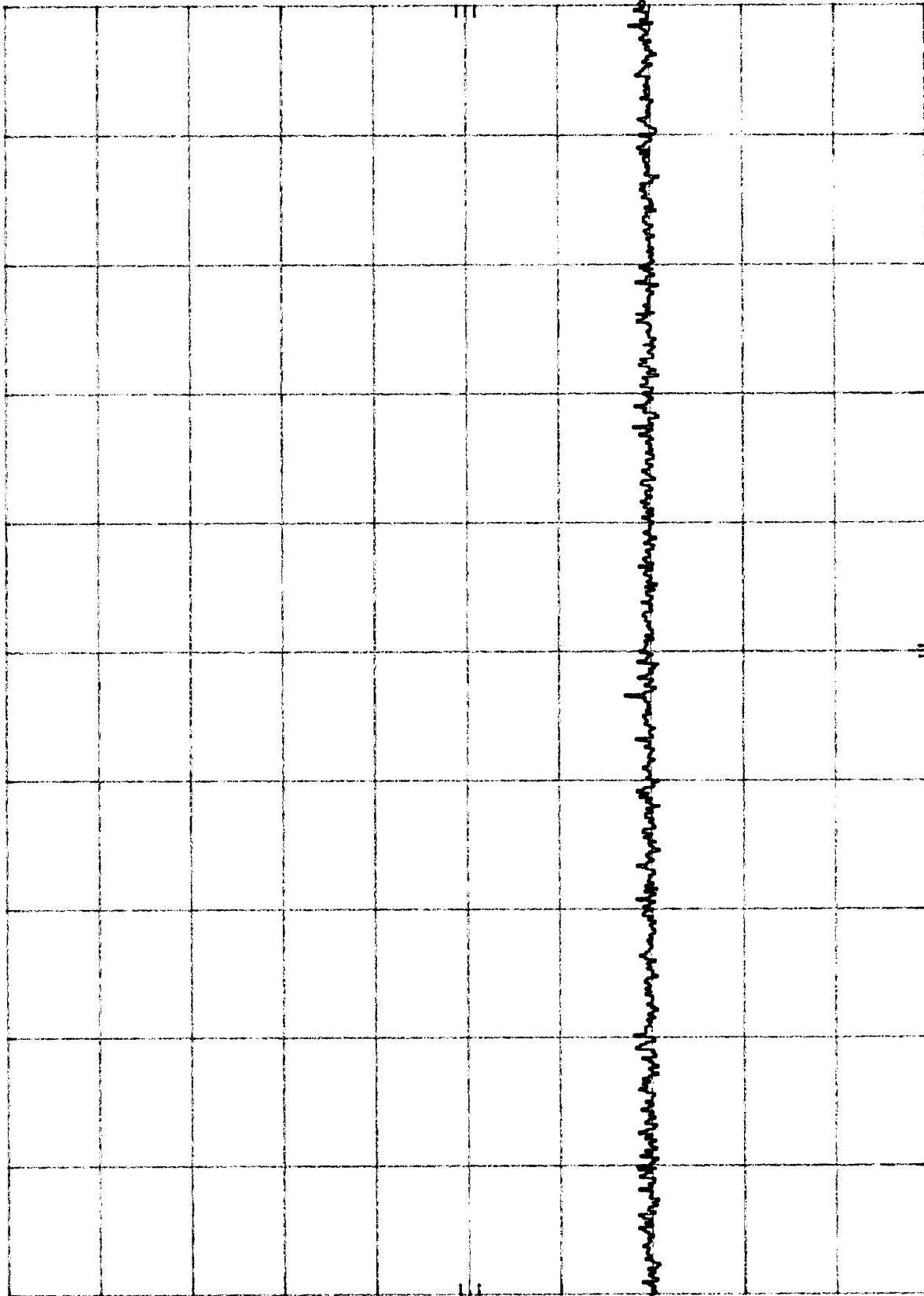

STOP 5.715 0 GHz
SWP 20.0 msec

VBW 1 MHz

START 5.700 0 GHz
RES BW 1 MHz

Plot Y.c 6

MKR 5.715 0 GHz
-41.90 dBm

ATTEN 30 dB

REF 20.6 dBm

hp

10 dB/

OFFSET

0.6 dB

DL

-6.8 dBm

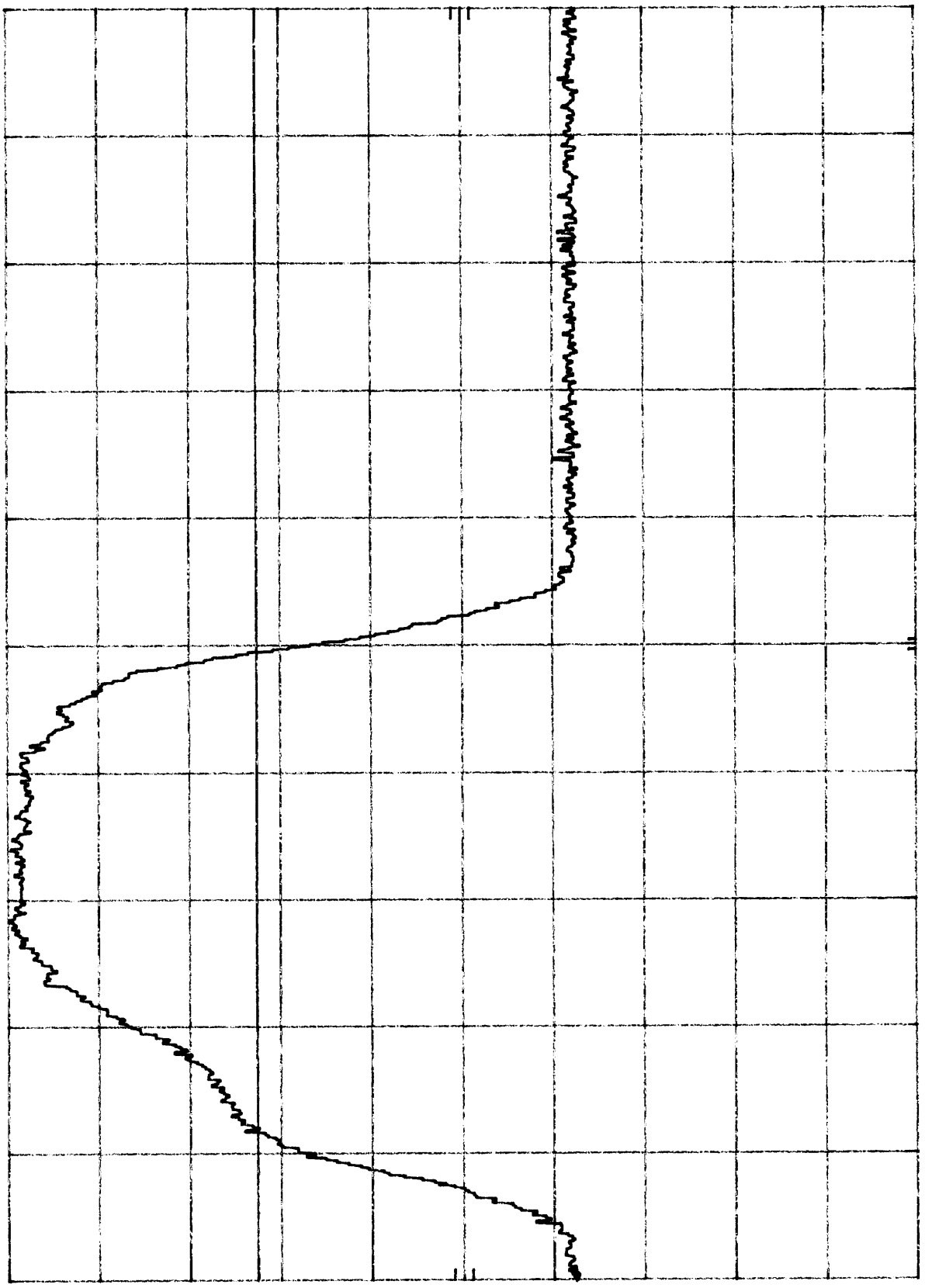

STOP 5.835 GHz
SWP 20.0 msec

VBW 1 MHz

RES BW 1 MHz

START 5.715 GHz

Plot 4.c 7

MKR 5.725 0 GHz
-23.90 dBm

HP
10 dB/

OFFSET
0.6
dB

DL
-6.8
dBm

REF 20.6 dBm
ATTEN 30 dB

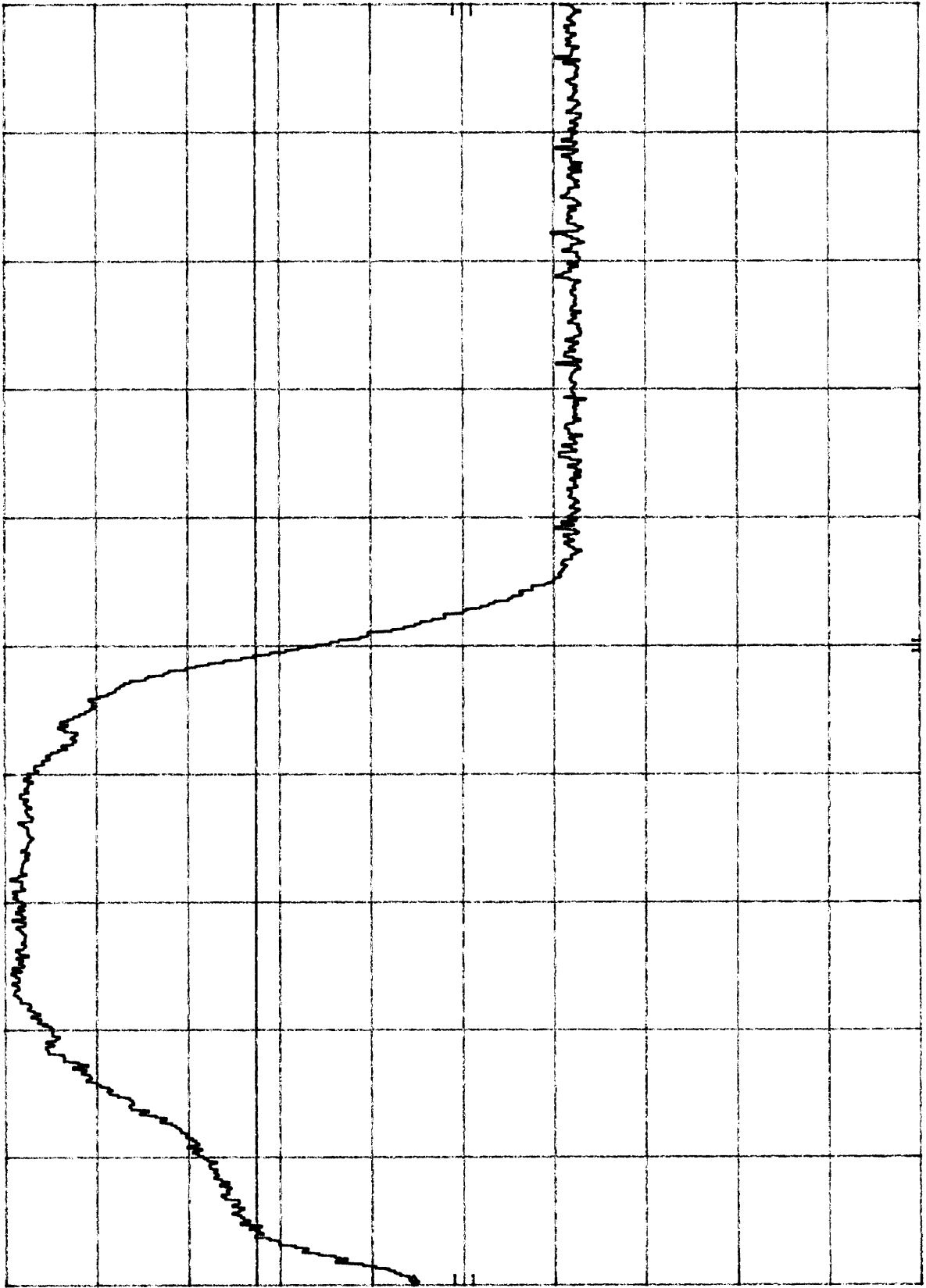

START 5.725 GHz
RES BW 1 MHz

STOP 5.825 GHz
SWP 20.0 msec

VBW 1 MHz

MKR 5.900 GHz
-40.10 dBm

Plot Yc 8

ATTEN 30 dB

REF 20.6 dBm

hp

10 dB/

OFFSET
0.6
dB

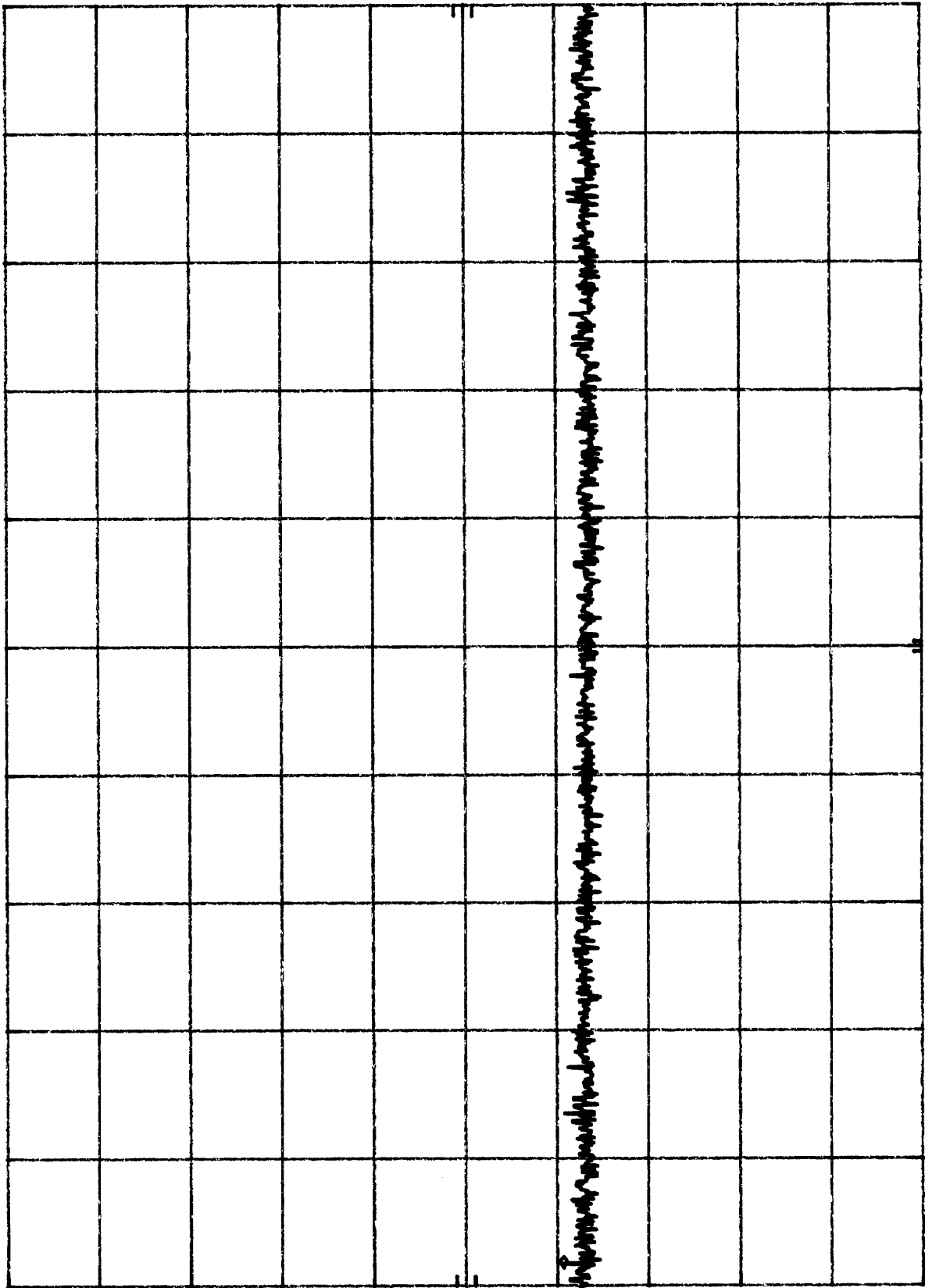

STOP 10.00 GHz
SWP 104 msec

VBW 1 MHz

RES BW 1 MHz

START 5.82 GHz

Plot Yc9

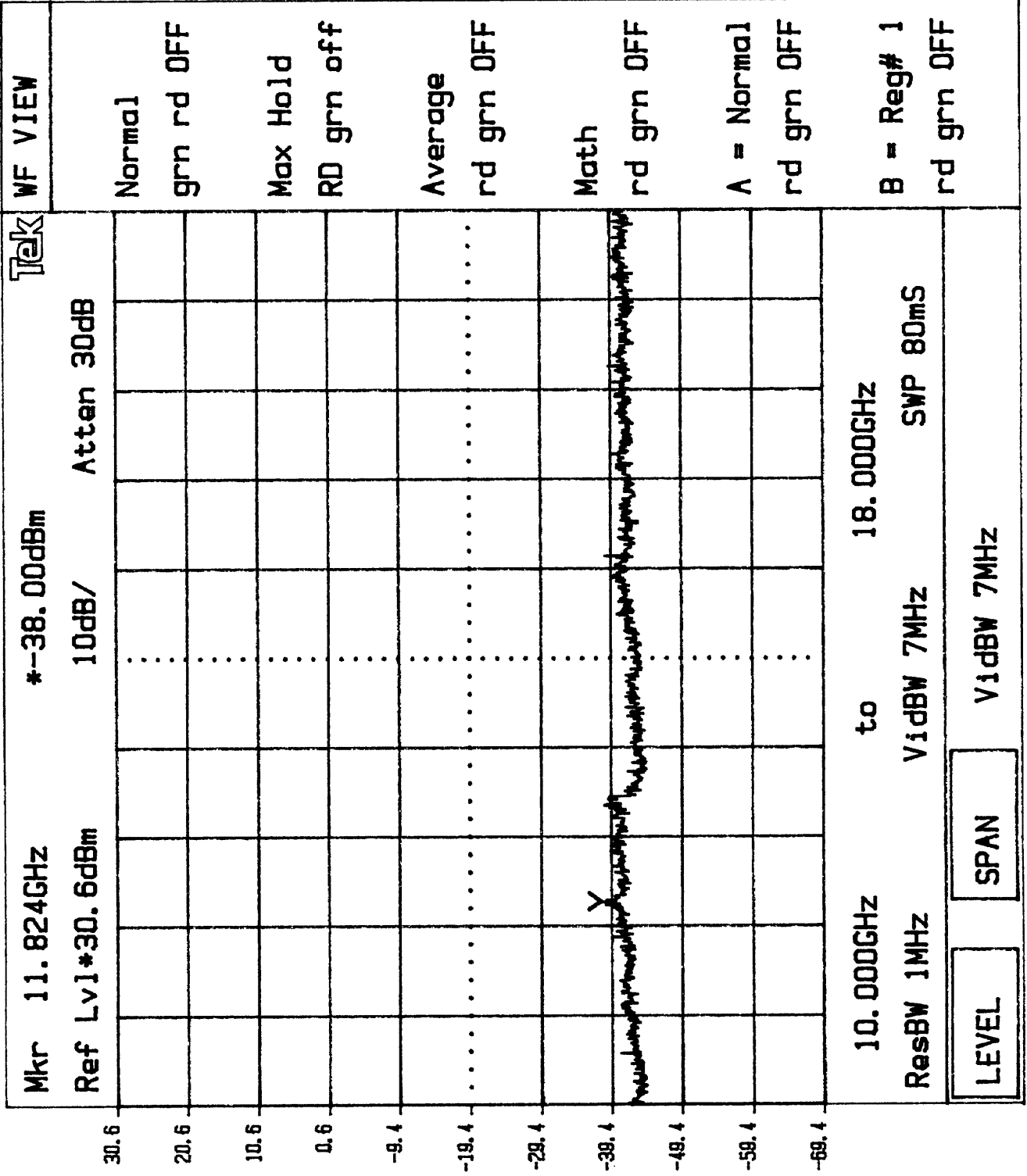

Plot 4e10

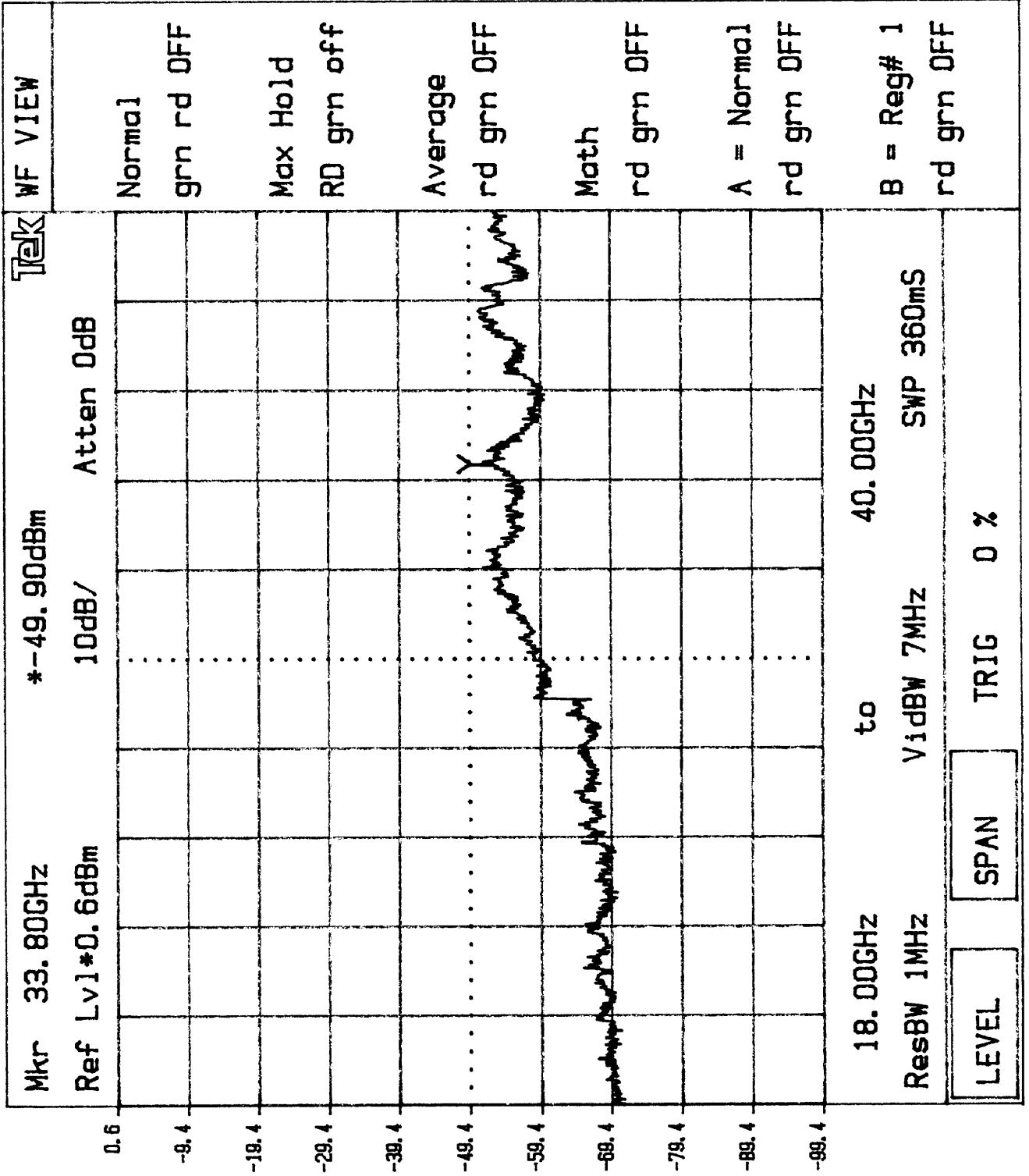

Plot 4d1

MKR 63.77 MHz
-54.40 dBm

REF 20.6 dBm ATTEN 30 dB

10 dB/

10 dB/

OFFSET
0.6
dB

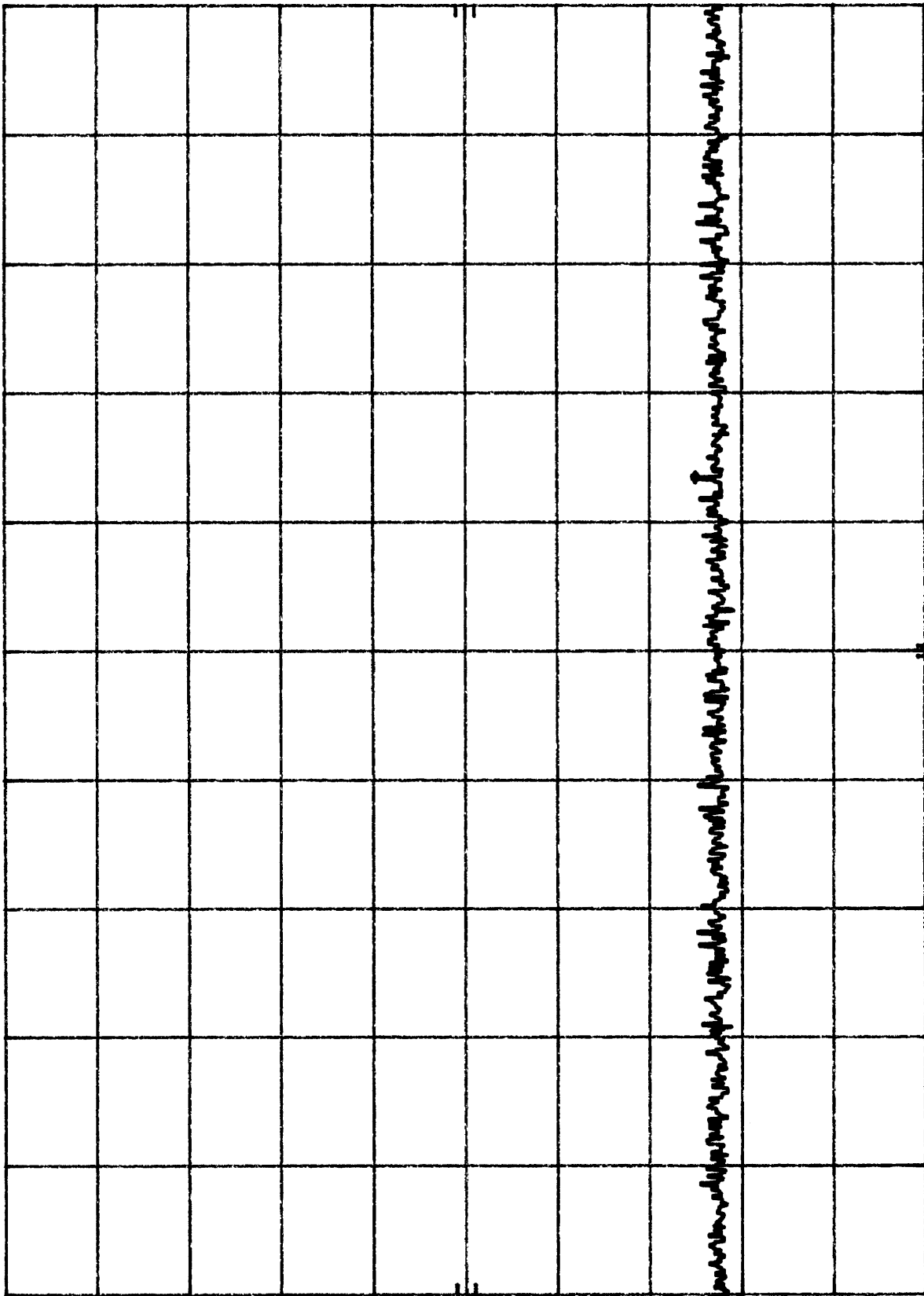

START 1.0 MHz RES BW 100 kHz VBW 100 kHz STOP 100.0 MHz
SWP 29.7 msec

Plot Y d 2

MKR 630.1 MHz
-54.10 dBm

REF 20.6 dBm ATTEN 30 dB

70

10 dB/

OFFSET
0.6
dB

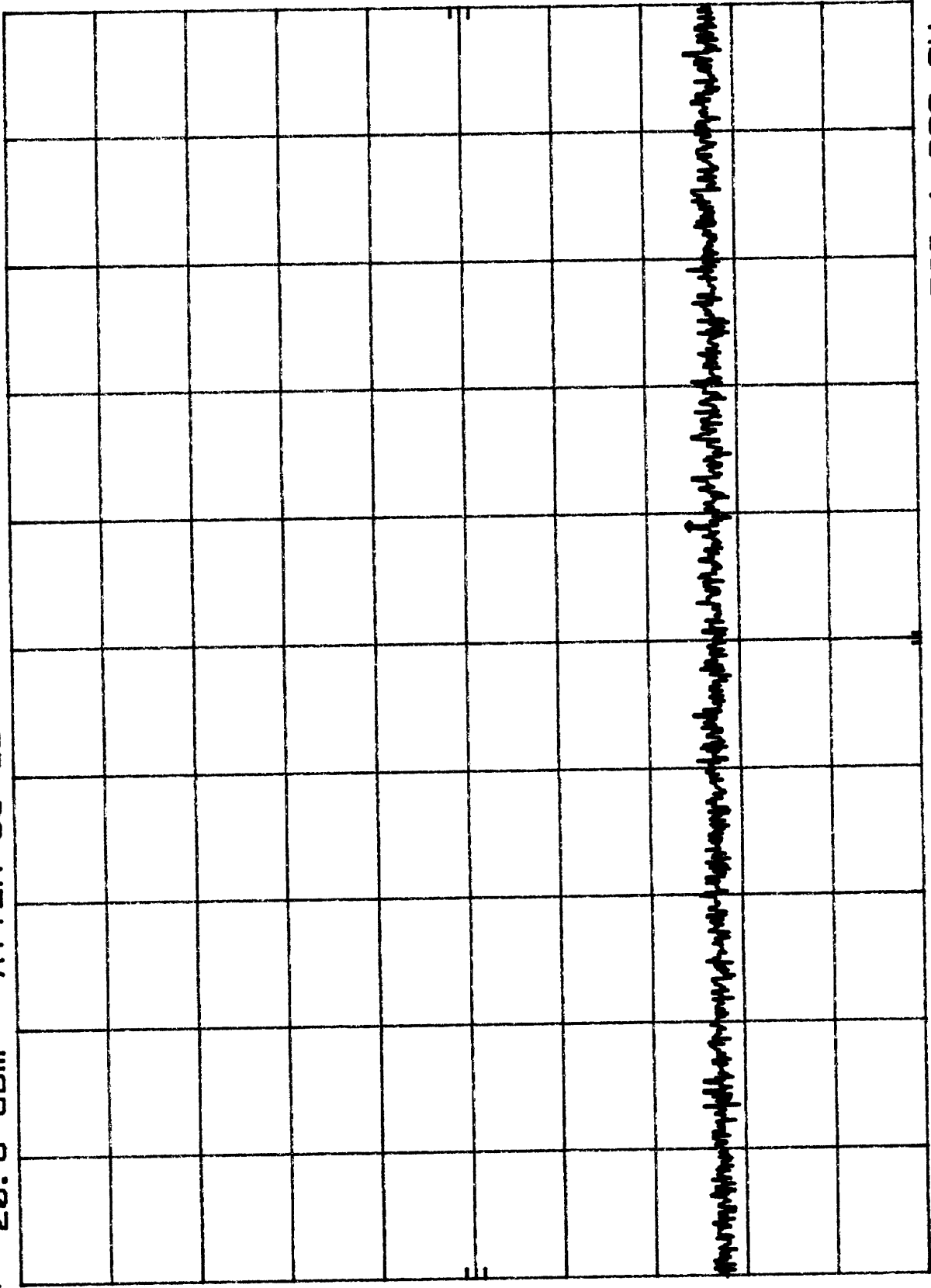

START 100 MHz RES BW 100 KHZ
STOP 1.000 GHz SWP 270 msec
VBW 100 KHZ

Plot 4d3
MKR 2.368 GHz
-45.90 dBm

hp
10 dB/
ATTEN 30 dB

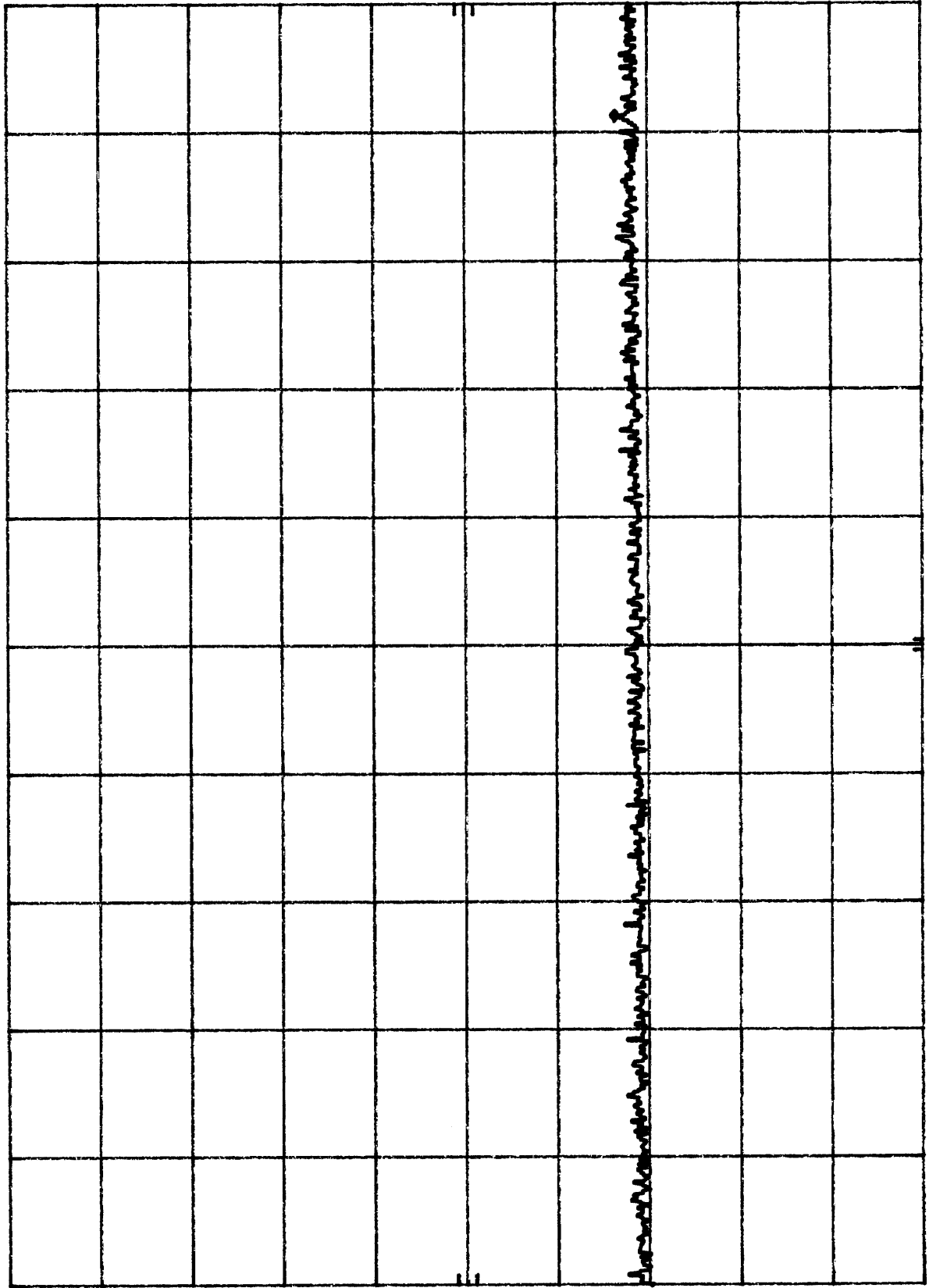

OFFSET
0.6
dB

START 1.00 GHz
RES BW 1 MHz
STOP 2.50 GHz
SWP 37.5 msec
VBW 1 MHz

Plot Y.dY
MKR 4.864 GHz
-46.30 dBm

HP REF 20.6 dBm ATTEN 30 dB

10 dB/

OFFSET
0.6
dB

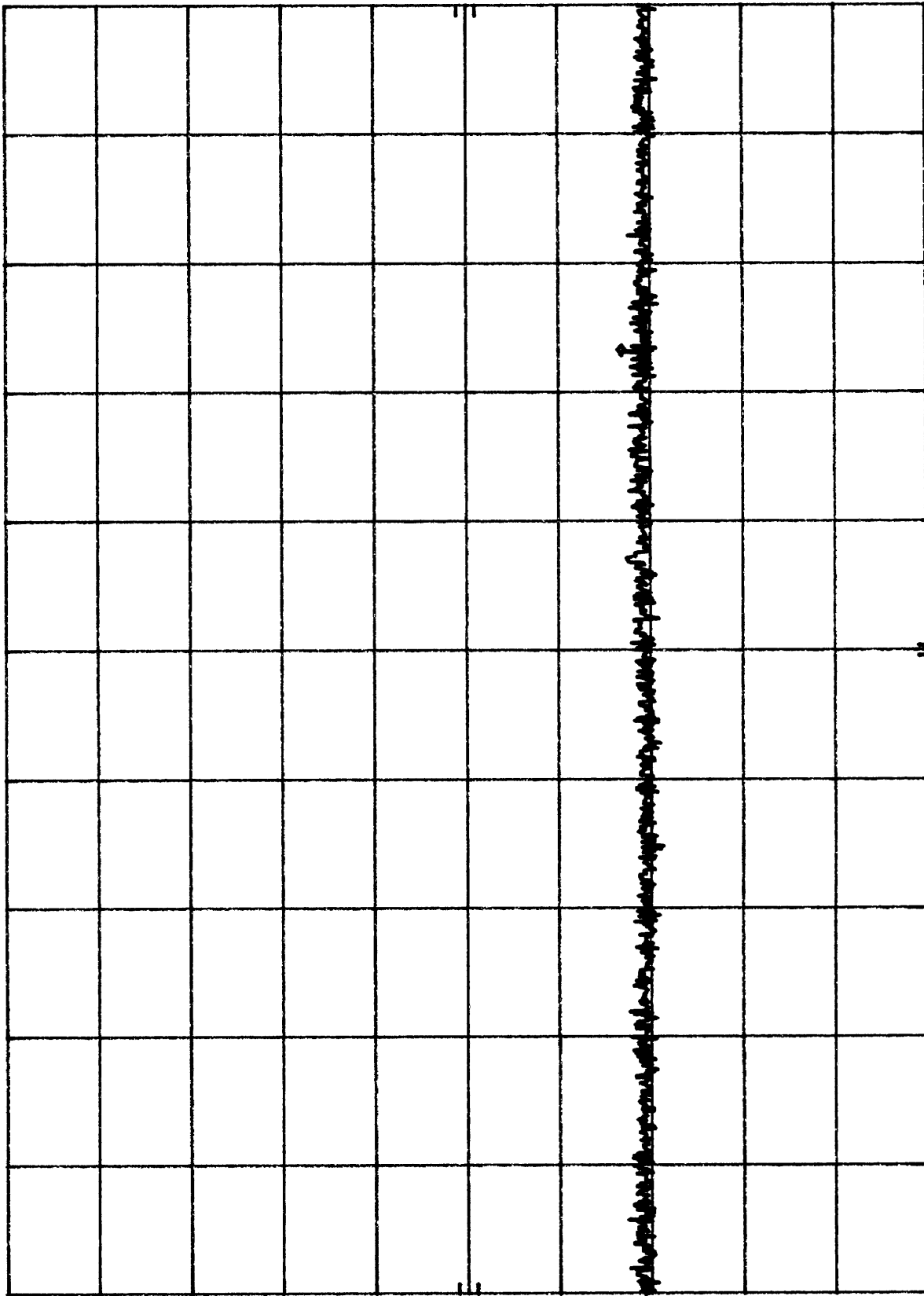

START 2.50 GHz RES BW 1 MHz VBW 1 MHz STOP 5.73 GHz
SWP 80.8 msec

MKR 5.825 0 GHz
-28.80 dBm

Plot 4d5

ATTEN 30 dB

REF 20.6 dBm

hp

10 dB/

OFFSET
0.6
dB

DL
-6.8
dBm

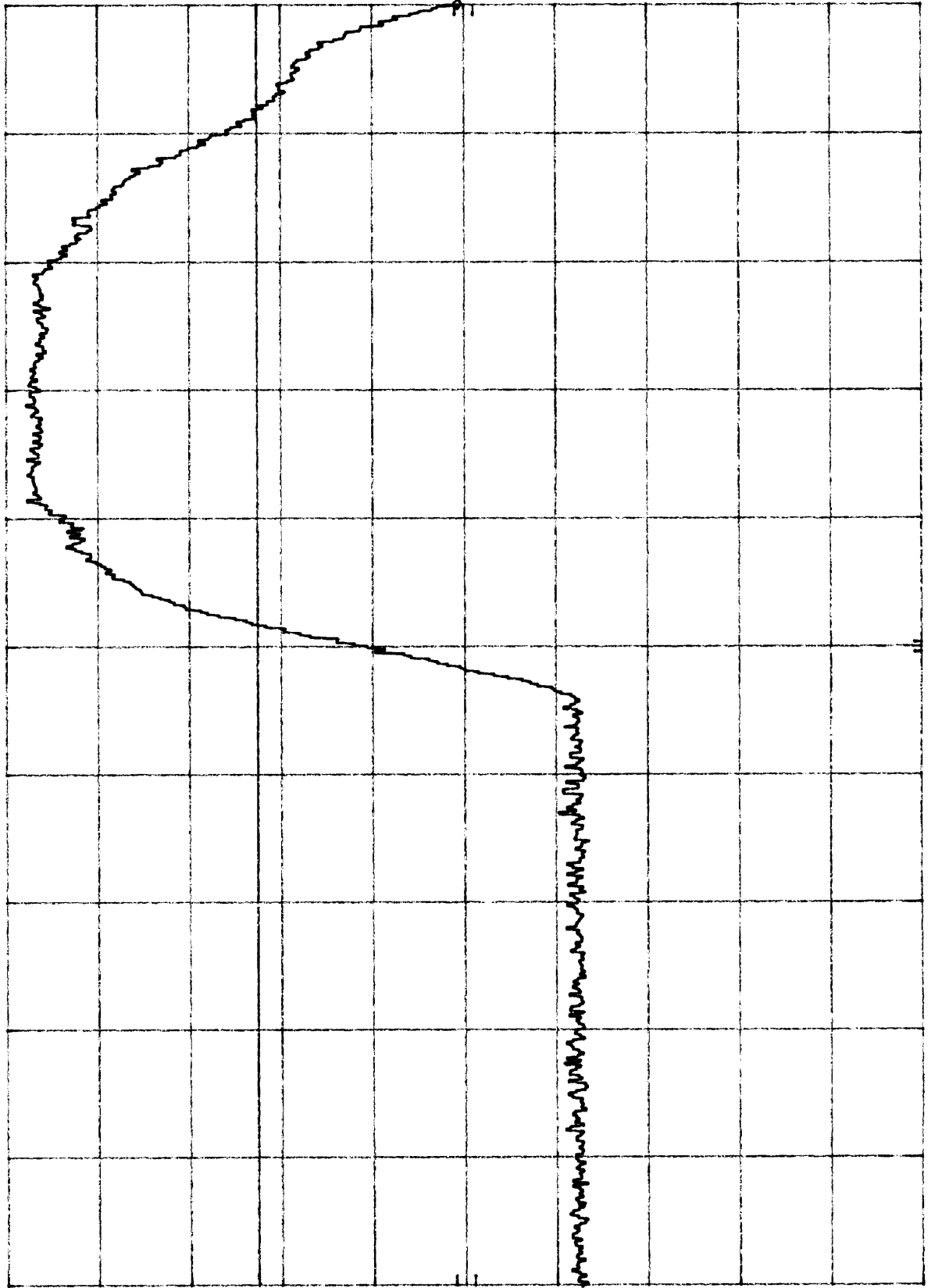

STOP 5.825 GHz
SWP 20.0 msec

VBW 1 MHz

RES BW 1 MHz

START 5.725 GHz

Plot 4d6 MKR 5.835 0 GHz
-42.50 dBm

Plot 4d6

ATTEN 30 dB

REF 20.6 dBm

hp

10 dB/

OFFSET

0.6
dB

DL

-6.8
dBm

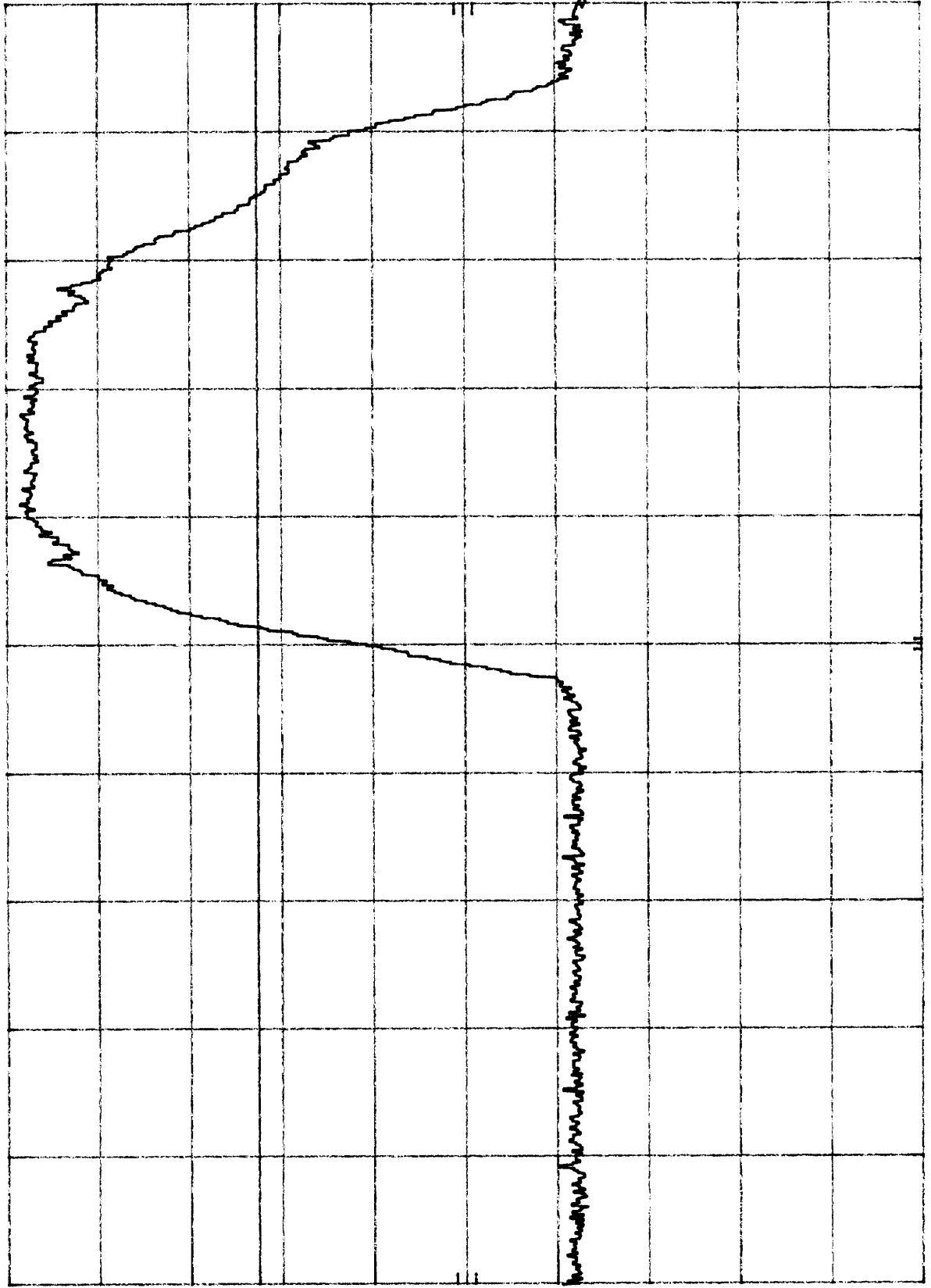

STOP 5.835 GHz
SWP 20.0 msec

VBW 1 MHz

RES BW 1 MHz

START 5.715 GHz

Plot Yd 7

MKR 6.547 GHz
-38.60 dBm

ATTEN 30 dB

REF 20.6 dBm

hp

10 dB/

OFFSET
0.6
dB

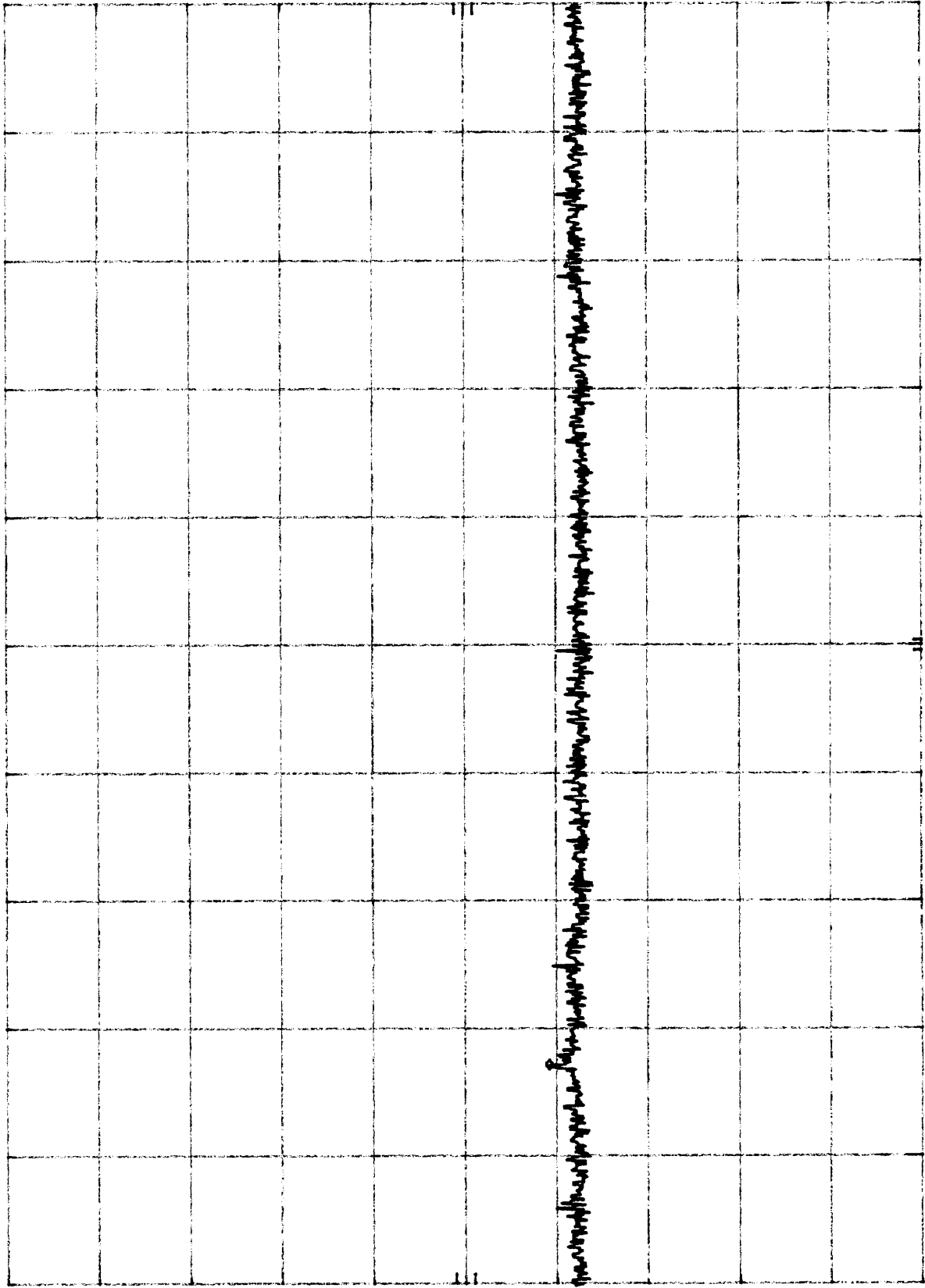

STOP 10.00 GHz
SWP 104 msec

VBW 1 MHz

RES BW 1 MHz

START 5.83 GHz

Plot 4.d8

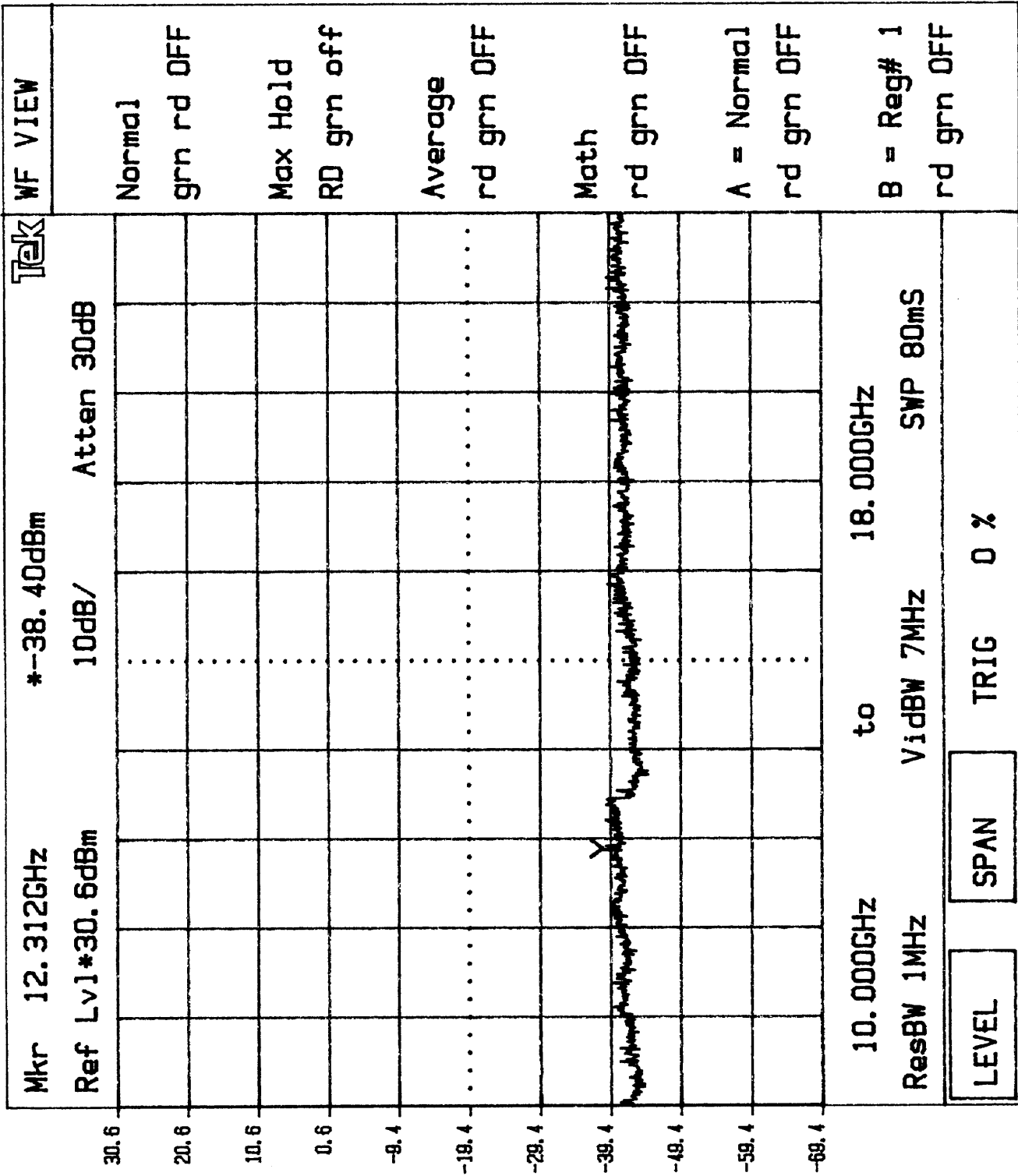

Plot 4d9

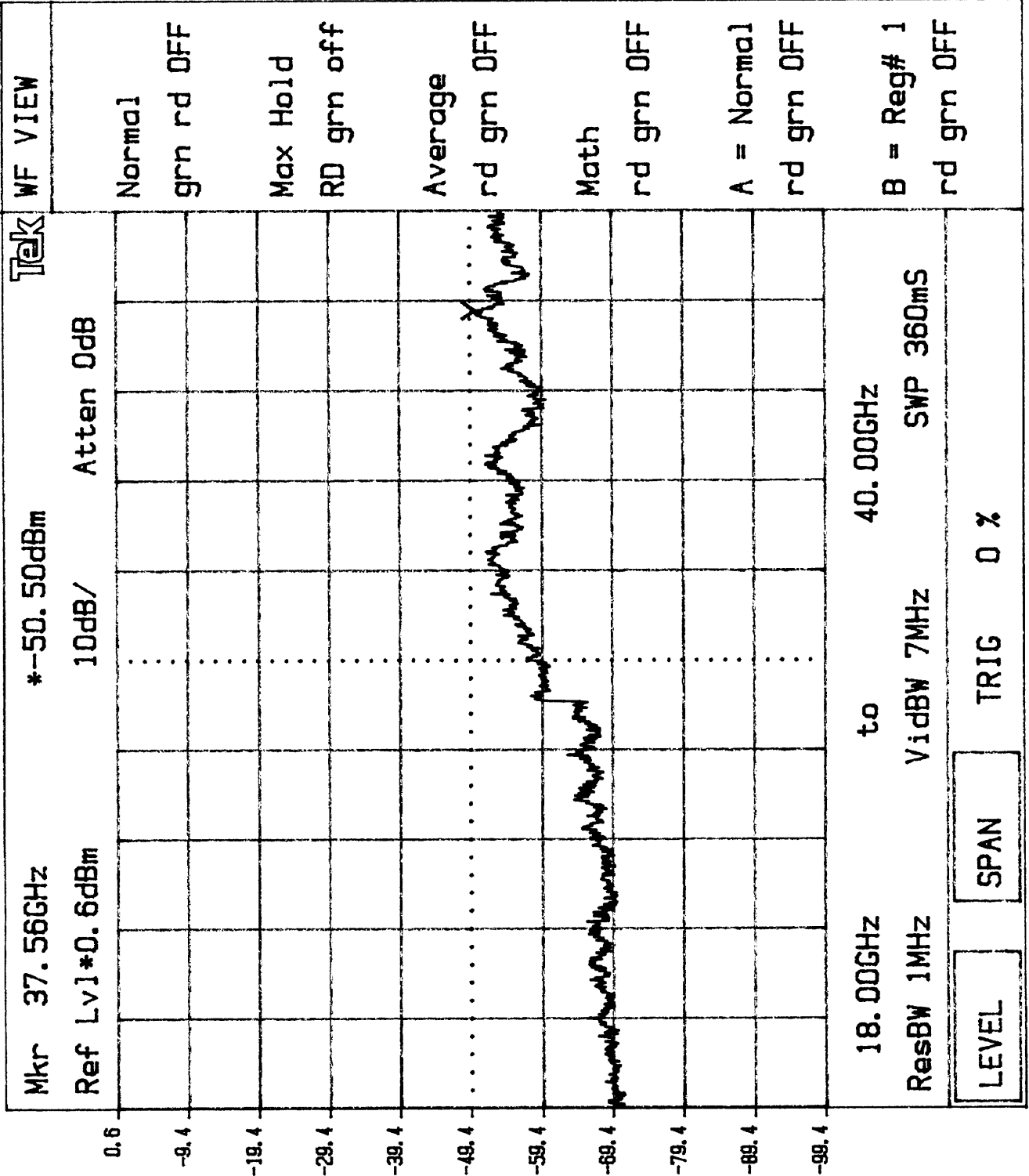

4.5 Transmitter Radiated Emissions in Restricted Bands, FCC Rule 15.205:

Radiated emission measurements were performed from 30 MHz to 40,000 MHz. Analyzer resolution is 100 kHz or greater for 30 MHz to 1000 MHz, 1 MHz for frequencies above 1000 MHz.

Data is included of the worst case configuration (the configuration which resulted in the highest emission levels). A sample calculation, configuration photographs and data tables of the emissions are included. Above 1000 MHz measurements were performed with peak and average detection.

The data on the following pages list the significant emission frequencies, the limit and the margin of compliance..

To show compliance at the band-edges frequencies, the “delta” method was used.

Glenayre Western Multiplex, U-NII Radio
 FCC ID: HZB-U58/45

Date of Test: June 3-10, 1999

Company: Glenayre Western Multiplex
Project #: J99014962
Model: 27710
Engineer: Xi-Ming Yang
Date of test: June 7, 1999

FCC 15.407 Radiated Emissions

5.725-5.825 GHz Band, High Channel 5794.1 MHz

Frequency	Antenna	Reading	Antenna	Cable	Pre-amp	Distance	Duty cycle	Corrected	Limit	Margin
	Polarity		Factor	Loss		Factor		Reading		
MHz	H/V	dB(uV)	dB/m	dB	dB	dB	dB	dB(uV/m)	dB(uV/m)	dB
11588.2	V	42.6	41.2	5.1	39.7	0.0	0.0	49.2*	74.0	-24.8
11588.2	V	34.1	41.2	5.1	39.7	0.0	0.0	40.7	54.0	-13.3

5.725-5.825 GHz Band, Low Channel 5756 MHz

Frequency	Antenna	Reading	Antenna	Cable	Pre-amp	Distance	Duty cycle	Corrected	Limit	Margin
	Polarity		Factor	Loss		Factor		Reading		
MHz	H/V	dB(uV)	dB/m	dB	dB	dB	dB	dB(uV/m)	dB(uV/m)	dB
11512.0	V	42.5	41.2	5.1	39.7	0.0	0.0	49.1*	74.0	-24.9
11512.0	V	34.0	41.2	5.1	39.7	0.0	0.0	40.6	54.0	-13.4
23024.0	V	42.6	40.4	7.5	24.2	-9.5	0.0	56.8*	74.0	-17.2
23024.0	V	33.8	40.4	7.5	24.2	-9.5	0.0	48.0	54.0	-6.0

- Note:
1. All readings were taken at 3 m, except for 23 GHz, which was taken at 1 m.
 2. Negative signs (-) in the margin column signify levels below the limit.
 3. Readings with (*) are peak readings, all others are average.

4.6 AC Line Conducted Emission, FCC Rule 15.207:

Not required; battery operation only

Test data attached

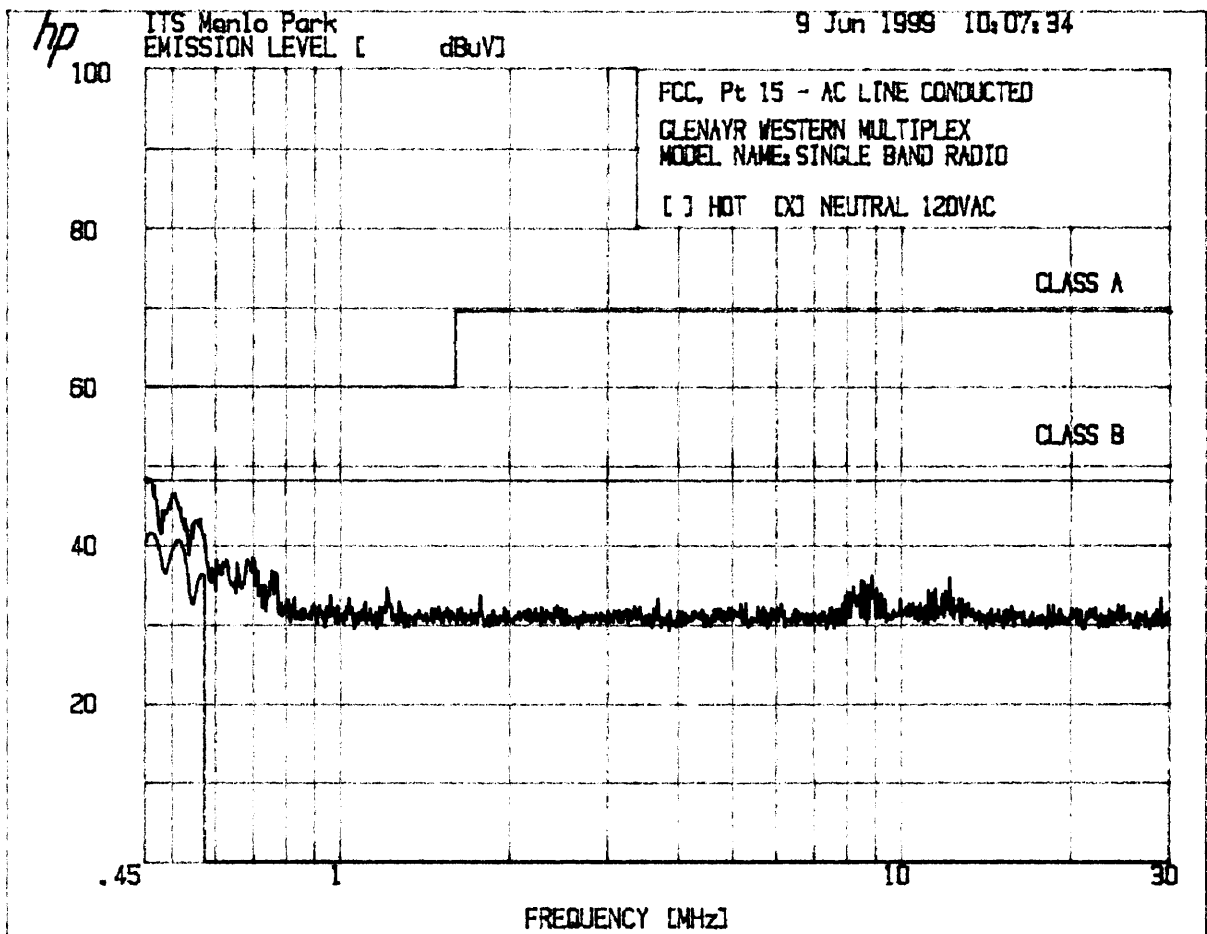
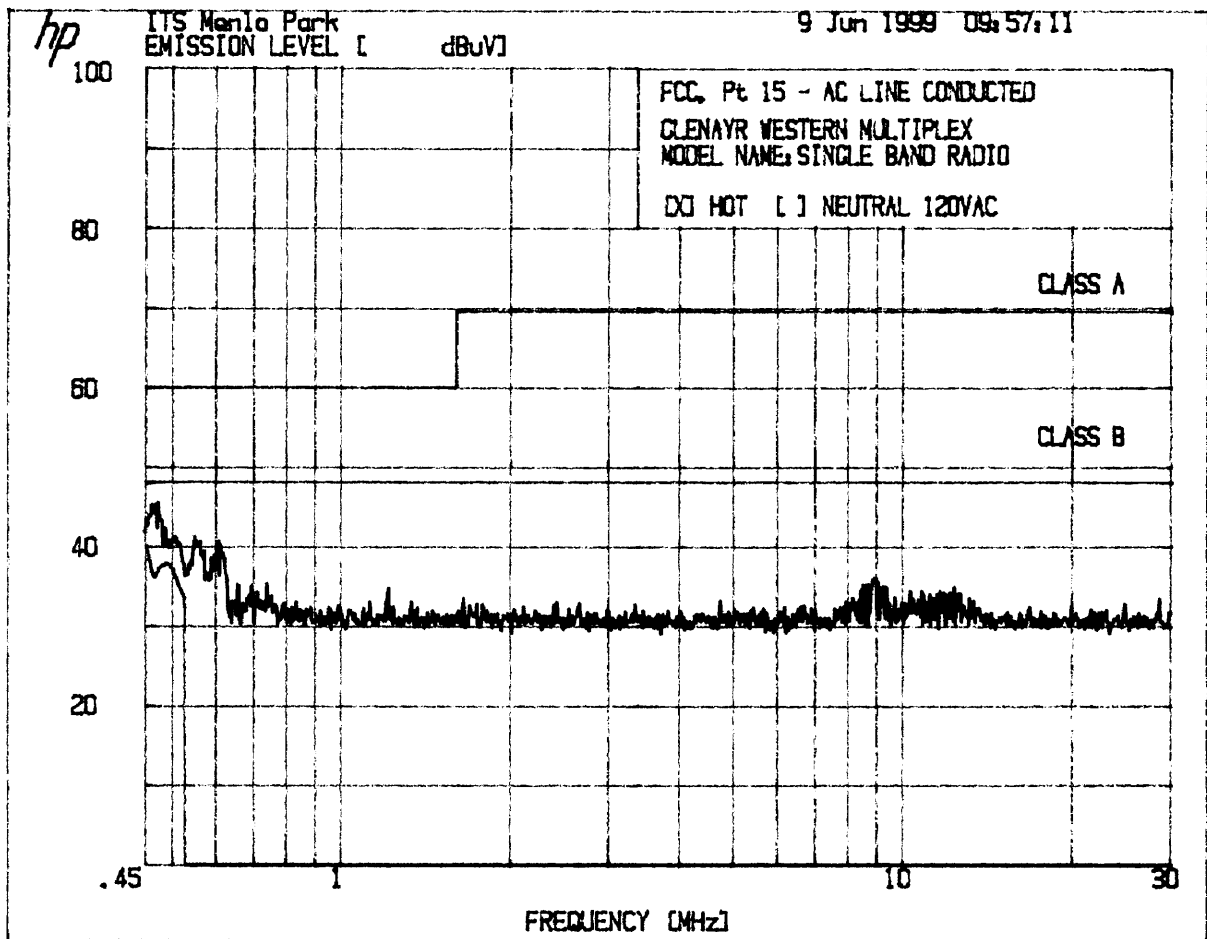

=====

ITS Menlo Park 9 Jun 1999 10:07:34

=====

3. FCC CFR 47, Pt 15
3.1 FCC, Pt 15 - AC LINE CONDUCTED

=====

GLENAYR WESTERN MULTIPLEX
MODEL NAME: SINGLE BAND RADIO

[] HOT [X] NEUTRAL 120VAC

PEAKS FOUND ABOVE 36 dBuV

PEAK#	FREQ (MHz)	AMPL (dBuV)
1	.5125	46.5
2	.5692	43.3
3	.6087	38.2
4	.6620	37.6
5	.7050	38.5
6	.7635	36.8
7	8.924	36.2

=====
ITS Menlo Park 9 Jun 1999 09:57:11
=====

3. FCC CFR 47, Pt 15
3.1 FCC, Pt 15 - AC LINE CONDUCTED
=====

GLENAYR WESTERN MULTIPLEX
MODEL NAME:SINGLE BAND RADIO

[X] HOT [] NEUTRAL 120VAC

PEAKS FOUND ABOVE 36 dBuV

PEAK#	FREQ (MHz)	AMPL (dBuV)
1	.4732	45.4
2	.4772	45.6
3	.5550	41.3
4	.6113	40.7
5	.6164	40.3
6	8.961	36.1

4.7 Radiated Emissions from Digital Section of Transceiver (Transmitter), FCC Ref: 15.109

- Not required - No digital part
- Test results are attached
- Included in the separate DOC report.

4.8 Radiated Emissions from Receiver Section of Transceiver (L.O. Radiation), FCC Ref: 15.109, 15.111

- Not required - EUT operation above 960 MHz only
- Not required - EUT is transmitter only
- Not performed; exempt until June 1999
- Test results are attached

Glenayre Western Multiplex, U-NII Radio
FCC ID: HZB-U58/45

Date of Test: June 3-10, 1999

Company: Glenayre Western Multiplex
Project #: J99014962
Model: 27710
Engineer: Xi-Ming Yang
Date of test: June 7, 1999

FCC 15.407 Radiated Emissions

Frequency	Antenna	Reading	Antenna	Cable	Pre-amp	Distance	Duty	Corrected	Limit	Margin
	Polarity		Factor	Loss		Factor	cycle	Reading		
MHz	H/V	dB(uV)	dB/m	dB	dB	dB	dB	dB(uV/m)	dB(uV/m)	dB
50.0	V	26.0	7.2	0.5	0.0	0.0	0.0	33.7	40.0	-6.3
80.0	V	26.0	6.5	0.5	0.0	0.0	0.0	33.0	40.0	-7.0
100.0	V	32.0	7.9	0.5	0.0	0.0	0.0	40.4	43.5	-3.1
160.0	V	27.8	9.8	0.5	0.0	0.0	0.0	38.1	43.5	-5.4
165.1	V	24.8	9.5	0.5	0.0	0.0	0.0	34.8	43.5	-8.7
175.0	V	27.0	9.7	0.5	0.0	0.0	0.0	37.2	43.5	-6.3
185.8	V	27.0	9.6	0.6	0.0	0.0	0.0	37.2	43.5	-6.3
200.0	V	27.0	10.5	0.6	0.0	0.0	0.0	38.1	43.5	-5.4
275.0	H	17.0	13.0	0.6	0.0	0.0	0.0	30.6	46.0	-15.4
300.0	H	27.5	14.4	0.7	0.0	0.0	0.0	42.6	46.0	-3.4
350.0	H	21.9	16.3	0.7	0.0	0.0	0.0	38.9	46.0	-7.1
375.0	H	25.0	16.2	0.7	0.0	0.0	0.0	41.9	46.0	-4.1
400.0	H	24.0	16.9	0.7	0.0	0.0	0.0	41.6	46.0	-4.4
507.9	H	23.0	18.5	0.7	0.0	0.0	0.0	42.2	46.0	-3.8
525.0	H	22.6	19.3	0.7	0.0	0.0	0.0	42.6	46.0	-3.4

- Note: 1. All measurements were made at 3 meters.
2. Negative signs (-) in the margin column signify levels below the limit.

4.9 Transmitter Duty Cycle Calculation and Measurements, FCC Rule 15.35(b), (c)

The EUT antenna output port was connected to the input of the spectrum analyzer. The analyzer center frequency was set to EUT RF channel carrier. The SWEEP function on the analyzer was set to ZERO SPAN. The transmitter ON time was determined from the resultant time-amplitude display:

Duty cycle = Maximum ON time in 100 msec/100

Duty cycle correction, dB = 20 * log(DC)

	See attached spectrum analyzer chart(s) for transmitter timing
	See transmitter timing diagram provided by manufacturer
X	Not applicable.

5.0 List of Exhibits

- Exhibit 1* **ID Label Format**
- Exhibit 2* **ID Label Location**
- Exhibit 3* **Equipment Photographs**
- Exhibit 4* **Block Diagram**
- Exhibit 5* **Circuit Diagram**
- Exhibit 6* **Test Setup Photos**
- Exhibit 7* **Theory of Operation**
- Exhibit 8* **Instruction Manual**
- Exhibit 9* **Antenna Information**