



FCC PART 15.407
RSS-247, ISSUE 2, FEBRUARY 2017
DYNAMIC FREQUENCY SELECTION
TEST REPORT

For

Proxim Wireless Corporation

2114 Ringwood Ave, San Jose, CA 95131, USA

FCC ID: HZB-NGPLC
IC: 1856A-NGPLC

Report Type: Original Report	Product Type: NGP LC 5 GHz radio
Report Number:	RDG200805002-00D
Report Date:	2021-02-25
Reviewed By:	Ivan Cao Assistant Manager 
Test Laboratory:	Bay Area Compliance Laboratories Corp. (Dongguan) No.12, Pulong East 1 st Road, Tangxia Town, Dongguan, Guangdong, China Tel: +86-769-86858888 Fax: +86-769-86858891 www.baclcorp.com.cn

TABLE OF CONTENTS

GENERAL INFORMATION.....	3
PRODUCT DESCRIPTION FOR EQUIPMENT UNDER TEST (EUT).....	3
OBJECTIVE	3
TEST METHODOLOGY	4
TEST FACILITY	4
DECLARATIONS.....	4
SYSTEM TEST CONFIGURATION.....	5
DESCRIPTION OF TEST CONFIGURATION	5
EUT EXERCISE SOFTWARE	5
EQUIPMENT MODIFICATIONS	5
SUPPORT EQUIPMENT LIST AND DETAILS	5
EXTERNAL CABLE.....	5
SUMMARY OF TEST RESULTS	6
APPLICABLE STANDARDS.....	7
DFS REQUIREMENT	7
DFS MEASUREMENT SYSTEM.....	11
SYSTEM BLOCK DIAGRAM.....	11
CONDUCTED METHOD	12
RADIATED METHOD.....	13
TEST PROCEDURE	13
TEST RESULTS.....	14
DESCRIPTION OF EUT	14
TEST EQUIPMENT LIST AND DETAILS.....	14
RADAR WAVEFORM CALIBRATION	15
TEST ENVIRONMENTAL CONDITIONS	15
CHANNEL AVAILABILITY CHECK TIME (CAC).....	21
TEST PROCEDURE	21
CHANNEL MOVE TIME AND CHANNEL CLOSING TRANSMISSION TIME	24
TEST PROCEDURE	24
TEST RESULTS	24
NON-OCCUPANCY PERIOD.....	27
TEST PROCEDURE	27
TEST RESULT	27
DETECTION BANDWIDTH.....	28
TEST PROCEDURE	28
TEST RESULT	29
STATISTICAL PERFORMANCE CHECK	33
BRIDGE AND/OR MESH MODE.....	128

GENERAL INFORMATION

Product Description for Equipment under Test (EUT)

EUT Name:	NGP LC 5 GHz radio
EUT Model:	FCC: MP-1015-CPE-US IC: MP-1025-CPE-WD
Multiple Models:	AB-CCCCD-XXX-YYY-ZZ - Refer to the DOS letter for details
Model Difference:	AB-CCCCD-XXX-YYY-ZZ - Refer to the DOS letter for details
FCC Operation Frequency:	5150-5250 MHz, 5250-5350 MHz, 5470-5725MHz, 5725-5850 MHz
IC Operation Frequency:	5250-5350 MHz,5470-5600MHz&5650-5725MHz,5725- 5850 MHz
Maximum Average Output Power (Conducted):	5150-5250 MHz:28.28 dBm 5250-5350 MHz:12.79 dBm 5470-5725 MHz:14.27 dBm 5725-5850 MHz: 24.94 dBm
Modulation Type:	OFDM
Rated Input Voltage:	DC 56.0V from PoE
Serial Number:	RDG200805002-RF-S1
EUT Received Date:	2020.08.07
EUT Received Status:	Good

Note: the devices intend for outdoor use, 5150-5250MHz and 5600-5650 MHz bands was disabled by software for Canada Market.

Optional Antenna Kit Accessory Information For 5G Band▲:

Manufacturer	Model	Antenna Type	input impedance (Ohm)	Antenna Gain /Used Frequency Range
ARC Wireless	ARC-OA5813SD1	Dual Pol Omni Antenna	50	13 dBi/ 5.15-5.85GHz
ARC Wireless	ARC-VS5821SD1	Dual Polarization Variable Beamwidth Sector Antenna	50	21 dBi/ 5.15-5.85GHz
Proxim	PA5-0530-DP	High Gain Dual Polarized/Dual Slant Antenna	50	29.5 dBi/ 5.15-5.85GHz
UBIQUITI Networks	RD-5G34	2x2 PtP Bridge Dish Antenna	50	34 dBi/ 5.15-5.25G&5.725-5.85GHz

Note: ARC-OA5813SD1 was tested for DFS.

PA5-0530-DP should be installed with the accessory 10dB Attenuators when Frequency setting for 5250-5350MHz or 5470-5725 MHz bands.

Objective

This report is prepared on behalf of **Proxim Wireless Corporation** in accordance with Part 2-Subpart J, Part 15-Subparts E of the Federal Communications Commission's rules, and RSS-247, Issue 2, February 2017 of the Innovation, Science and Economic Development Canada.

The objective is to determine compliance with Dynamic Frequency Selection (DFS) of the FCC Part 15, Subpart E, section 15.407 and and RSS-247, Issue 2, February 2017 of the Innovation, Science and Economic Development Canada.

Test Methodology

FCC KDB 905462 D02 UNII DFS Compliance Procedures New Rules v02.

Test Facility

The Test site used by Bay Area Compliance Laboratories Corp. (Dongguan) to collect test data is located on the No.12, Pulong East 1st Road, Tangxia Town, Dongguan, Guangdong, China.

The lab has been recognized as the FCC accredited lab under the KDB 974614 D01 and is listed in the FCC Public Access Link (PAL) database, FCC Registration No. : 897218, the FCC Designation No. : CN1220.

The lab has been recognized by Innovation, Science and Economic Development Canada to test to Canadian radio equipment requirements, the CAB identifier: CN0022.

Declarations

BACL is not responsible for the authenticity of any test data provided by the applicant. Data included from the applicant that may affect test results are marked with a triangle symbol “▲”. Customer model name, addresses, names, trademarks etc. are not considered data.

Unless otherwise stated the results shown in this test report refer only to the sample(s) tested.

This report cannot be reproduced except in full, without prior written approval of the Company.

This report is valid only with a valid digital signature. The digital signature may be available only under the Adobe software above version 7.0.

This report may contain data that are not covered by the accreditation scope and shall be marked with an asterisk “★”.

SYSTEM TEST CONFIGURATION

Description of Test Configuration

The EUT was configured for testing in an engineering mode which was provided by the manufacturer.

EUT Exercise Software

The test was performed under: 'Iperf.exe', which was provided by the manufacturer.

Equipment Modifications

N/A

Support Equipment List and Details

Manufacturer	Description	Model	Serial Number
Dell	Laptop	E6410	00426-OEM-8992662-00497
Dell	Laptop	E6410	00426-OEM-7854469-404555

External Cable

Cable Description	Shielding Type	Ferrite Core	Length (m)	From Port	To
RJ45	NO	NO	10	EUT	Laptop
RJ45	NO	NO	2	PoE Adapter	EUT

SUMMARY OF TEST RESULTS

The following result table represents the list of measurements required under the CFR §47 Part 15.407(h) and RSS-247, Issue 2, February 2017, KDB: 905462 D02 UNII DFS Compliance Procedures New Rules v02

Items	Description of Test	Result
Detection Bandwidth	UNII Detection Bandwidth	Compliance
Performance Requirements Check	Initial Channel Availability Check Time (CAC)	Compliance
	Radar Burst at the Beginning of the CAC	Compliance
	Radar Burst at the End of the CAC	Compliance
In-Service Monitoring	Channel Move Time	Compliance
	Channel Closing Transmission Time	Compliance
	Non-Occupancy Period	Compliance
Radar Detection	Statistical Performance Check	Compliance

APPLICABLE STANDARDS

DFS Requirement

CFR §47 Part 15.407(h)& RSS-247, Issue 2, February 2017

FCC KDB 905462 D02 UNII DFS Compliance Procedures New Rules v02

Table 1: Applicability of DFS Requirements Prior to Use of a Channel

Requirement	Operational Mode		
	Master	Client Without Radar Detection	Client With Radar Detection
<i>Non-Occupancy Period</i>	Yes	Not required	Yes
<i>DFS Detection Threshold</i>	Yes	Not required	Yes
<i>Channel Availability Check Time</i>	Yes	Not required	Not required
<i>U-NII Detection Bandwidth</i>	Yes	Not required	Yes

Table 2: Applicability of DFS requirements during normal operation

Requirement	Operational Mode	
	Master Device or Client with Radar Detection	Client Without Radar Detection
<i>DFS Detection Threshold</i>	Yes	Not required
<i>Channel Closing Transmission Time</i>	Yes	Yes
<i>Channel Move Time</i>	Yes	Yes
<i>U-NII Detection Bandwidth</i>	Yes	Not required

Additional requirements for devices with multiple bandwidth modes	Master Device or Client with Radar Detection	Client Without Radar Detection
<i>U-NII Detection Bandwidth and Statistical Performance Check</i>	All BW modes must be tested	Not required
<i>Channel Move Time and Channel Closing Transmission Time</i>	Test using widest BW mode available	Test using the widest BW mode available for the link
<i>All other tests</i>	Any single BW mode	Not required
Note: Frequencies selected for statistical performance check (Section 7.8.4) should include several frequencies within the radar detection bandwidth and frequencies near the edge of the radar detection bandwidth. For 802.11 devices it is suggested to select frequencies in each of the bonded 20 MHz channels and the channel center frequency.		

Table 3: DFS Detection Thresholds for Master Devices and Client Devices With Radar Detection

Maximum Transmit Power	Value (See Notes 1, 2, and 3)
EIRP \geq 200 milliwatt	-64 dBm
EIRP < 200 milliwatt and power spectral density < 10 dBm/MHz	-62 dBm
EIRP < 200 milliwatt that do not meet the power spectral density requirement	-64 dBm
<p>Note 1: This is the level at the input of the receiver assuming a 0 dBi receive antenna.</p> <p>Note 2: Throughout these test procedures an additional 1 dB has been added to the amplitude of the test transmission waveforms to account for variations in measurement equipment. This will ensure that the test signal is at or above the detection threshold level to trigger a DFS response.</p> <p>Note 3: EIRP is based on the highest antenna gain. For MIMO devices refer to KDB Publication 662911 D01.</p>	

Table 4: DFS Response Requirement Values

Parameter	Value
<i>Non-occupancy period</i>	Minimum 30 minutes
<i>Channel Availability Check Time</i>	60 seconds
<i>Channel Move Time</i>	10 seconds See Note 1.
<i>Channel Closing Transmission Time</i>	200 milliseconds + an aggregate of 60 milliseconds over remaining 10 second period. See Notes 1 and 2.
<i>U-NII Detection Bandwidth</i>	Minimum 100% of the U-NII 99% transmission power bandwidth. See Note 3.
<p>Note 1: <i>Channel Move Time</i> and the <i>Channel Closing Transmission Time</i> should be performed with Radar Type 0. The measurement timing begins at the end of the Radar Type 0 burst.</p> <p>Note 2: The <i>Channel Closing Transmission Time</i> is comprised of 200 milliseconds starting at the beginning of the <i>Channel Move Time</i> plus any additional intermittent control signals required to facilitate a <i>Channel</i> move (an aggregate of 60 milliseconds) during the remainder of the 10 second period. The aggregate duration of control signals will not count quiet periods in between transmissions.</p> <p>Note 3: During the <i>U-NII Detection Bandwidth</i> detection test, radar type 0 should be used. For each frequency step the minimum percentage of detection is 90 percent. Measurements are performed with no data traffic.</p>	

Table 5 – Short Pulse Radar Test Waveforms

Radar Type	Pulse Width (μsec)	PRI (μsec)	Number of Pulses	Minimum Percentage of Successful Detection	Minimum Number of Trials
0	1	1428	18	See Note 1	See Note 1
1	1	Test A: 15 unique PRI values randomly selected from the list of 23 PRI values in Table 5a	Roundup $\left\{ \left(\frac{1}{360} \right) \cdot \left(\frac{19 \cdot 10^6}{PRI_{\mu sec}} \right) \right\}$	60%	30
		Test B: 15 unique PRI values randomly selected within the range of 518-3066 μsec, with a minimum increment of 1 μsec, excluding PRI values selected in Test A			
2	1-5	150-230	23-29	60%	30
3	6-10	200-500	16-18	60%	30
4	11-20	200-500	12-16	60%	30
Aggregate (Radar Types 1-4)				80%	120
Note 1: Short Pulse Radar Type 0 should be used for the detection bandwidth test, channel move time, and channel closing time tests.					

A minimum of 30 unique waveforms are required for each of the Short Pulse Radar Types 2 through 4. If more than 30 waveforms are used for Short Pulse Radar Types 2 through 4, then each additional waveform must also be unique and not repeated from the previous waveforms. If more than 30 waveforms are used for Short Pulse Radar Type 1, then each additional waveform is generated with Test B and must also be unique and not repeated from the previous waveforms in Tests A or B.

For example if in Short Pulse Radar Type 1 Test B a PRI of 3066 usec is selected, the number of pulses

would be $Roundup \left\{ \left(\frac{1}{360} \right) \cdot \left(\frac{19 \cdot 10^6}{3066} \right) \right\} = Roundup \{17.2\} = 18.$

Table 5a - Pulse Repetition Intervals Values for Test A

Pulse Repetition Frequency Number	Pulse Repetition Frequency (Pulses Per Second)	Pulse Repetition Interval (Microseconds)
1	1930.5	518
2	1858.7	538
3	1792.1	558
4	1730.1	578
5	1672.2	598
6	1618.1	618
7	1567.4	638
8	1519.8	658
9	1474.9	678
10	1432.7	698
11	1392.8	718
12	1355	738
13	1319.3	758
14	1285.3	778
15	1253.1	798
16	1222.5	818
17	1193.3	838
18	1165.6	858
19	1139	878
20	1113.6	898
21	1089.3	918
22	1066.1	938
23	326.2	3066

The aggregate is the average of the percentage of successful detections of Short Pulse Radar Types 1-4. For example, the following table indicates how to compute the aggregate of percentage of successful detections.

Radar Type	Number of Trials	Number of Successful Detections	Minimum Percentage of Successful Detection
1	35	29	82.9%
2	30	18	60%
3	30	27	90%
4	50	44	88%
Aggregate $(82.9\% + 60\% + 90\% + 88\%)/4 = 80.2\%$			

Table 6 – Long Pulse Radar Test Waveform

Radar Type	Pulse Width (μsec)	Chirp Width (MHz)	PRI (μsec)	Number of Pulses per <i>Burst</i>	Number of <i>Bursts</i>	Minimum Percentage of Successful Detection	Minimum Number of Trials
5	50-100	5-20	1000-2000	1-3	8-20	80%	30

Table 7 – Frequency Hopping Radar Test Waveform

Radar Type	Pulse Width (μsec)	PRI (μsec)	Pulses per Hop	Hopping Rate (kHz)	Hopping Sequence Length (msec)	Minimum Percentage of Successful Detection	Minimum Number of Trials
6	1	333	9	0.333	300	70%	30

DFS Measurement System

BACL DFS measurement system consists of two subsystems: (1) The radar signal generating subsystem and (2) the traffic monitoring subsystem.

System Block Diagram

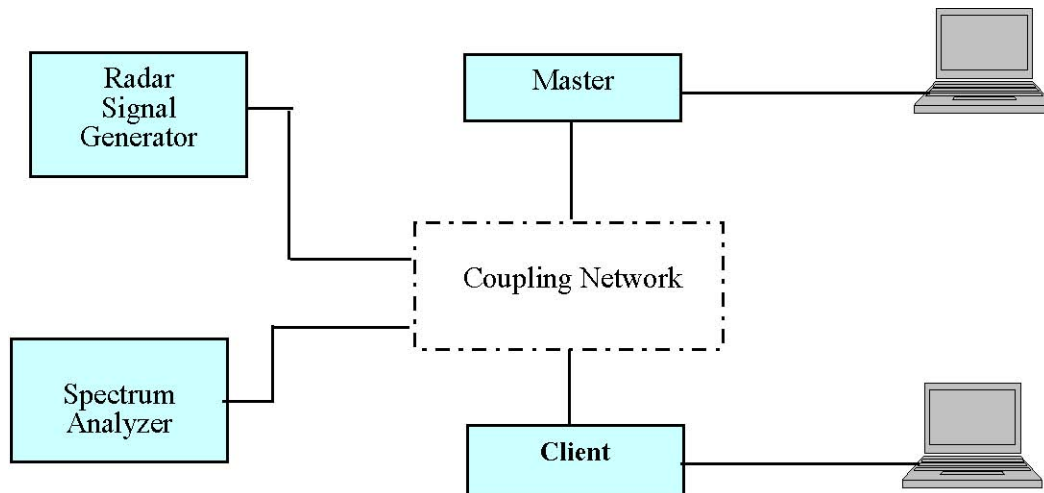

Conducted Method

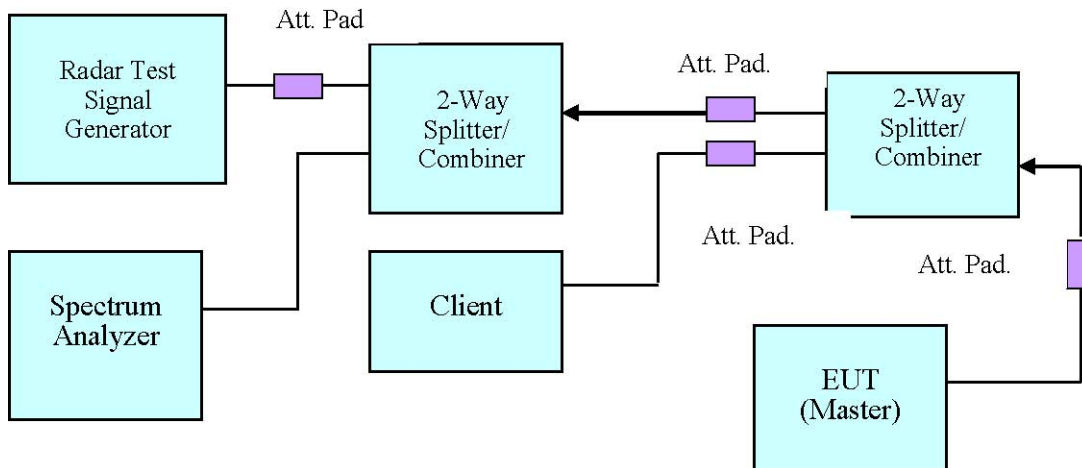

Setup for Master with injection at the Master

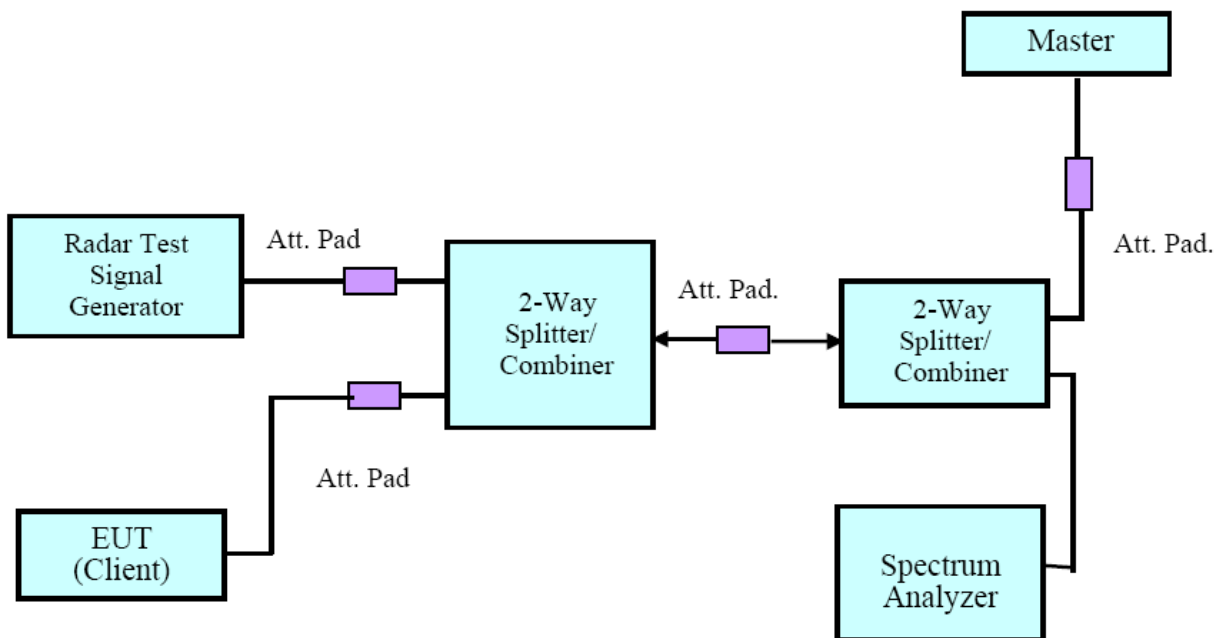

Setup for Client with injection at the Master

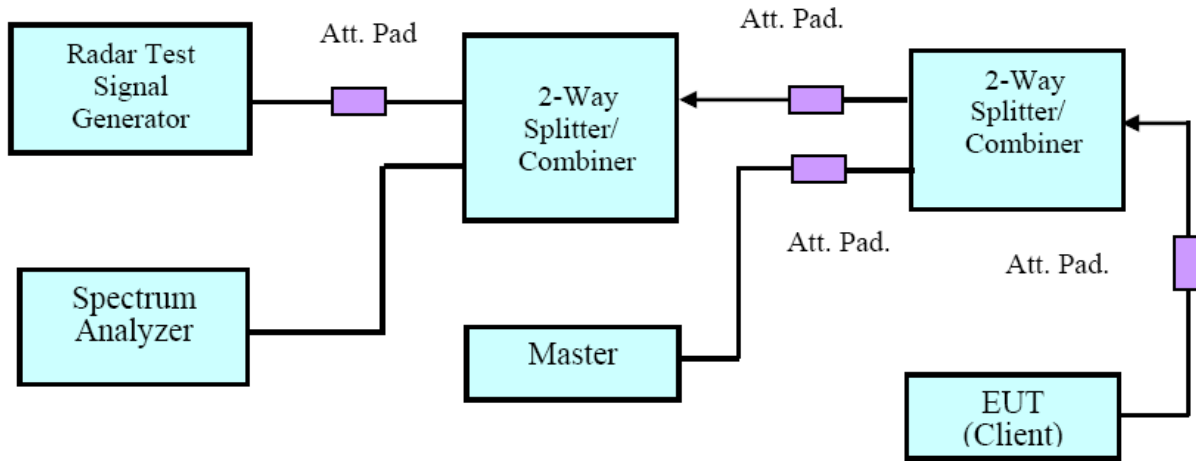

Setup for Client with injection at the Client

Radiated Method

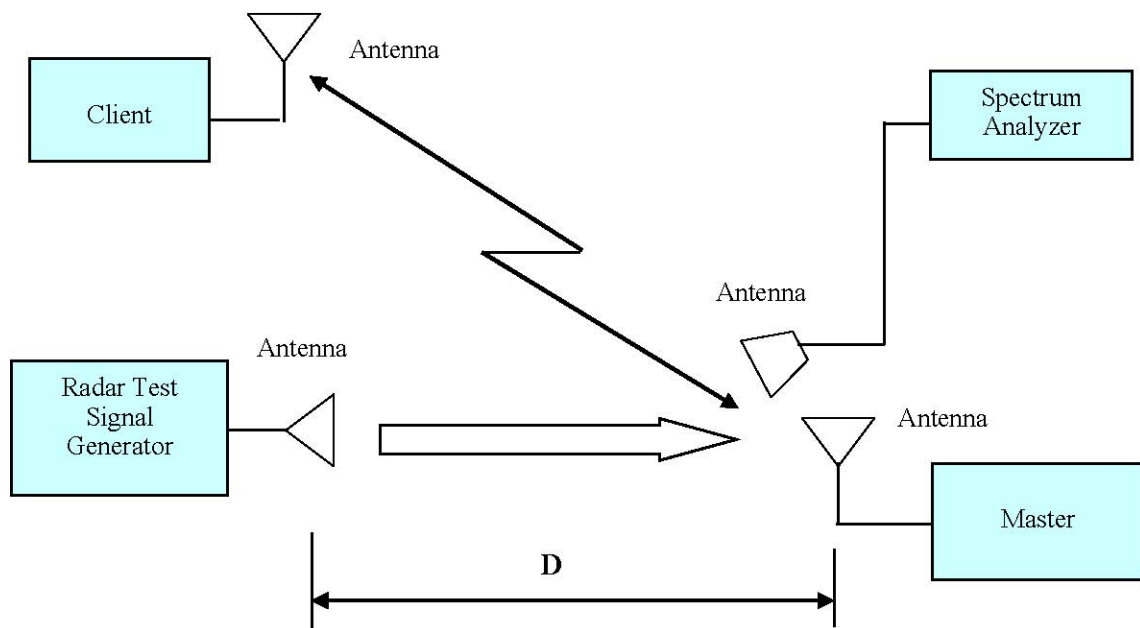

Test Procedure

A spectrum analyzer is used as a monitor verifies that the EUT status including Channel Closing Transmission Time and Channel Move Time, and does not transmit on a Channel during the Non-Occupancy Period after the diction and Channel move. It is also used to monitor EUT transmissions during the Channel Availability Check Time.

TEST RESULTS

Description of EUT

The EUT EIRP > 23dBm, the calibrated radiated DFS detection threshold level is set to -64 dBm is more stringent.

WLAN traffic is generated by streaming the video file TestFile.mpg, this file is used by IP and Frame based systems for loading the test channel during the In-service compliance testing of the U-NII device. The file is streamed from the Access Point to the Client in full motion video mode using the media player with the V2.61 Codec package.

Test Equipment List and Details

Manufacturer	Description	Model	Serial Number	Calibration Date	Calibration Due Date
National Instruments	NI PXI-1042 8-Slot chassis	PXI-1042	VOBX40FBD	N/A	N/A
National Instruments	Arbitrary Waveform Generator	PXI-5421	N/A	N/A	N/A
National Instruments	RF Upconverter	PXI-5610	N/A	N/A	N/A
ASCOR	Upconverter	AS-7202	N/A	N/A	N/A
Agilent	Spectrum Analyzer	E4440A	SG43360054	2020-07-07	2021-07-07
Ditorn	Splitter/Combiner	D3C4080	SN2244	N/A	N/A
TDK RF	Horn Antenna	HRN-0118	130 084	2018-10-12	2021-10-12
ETS-Lindgren	Horn Antenna	3115	000 527 35	2018-10-12	2021-10-12

* **Statement of Traceability:** Bay Area Compliance Laboratories Corp. (Dongguan) attests that all calibrations have been performed, traceable to National Primary Standards and International System of Units (SI).

Radar Waveform Calibration

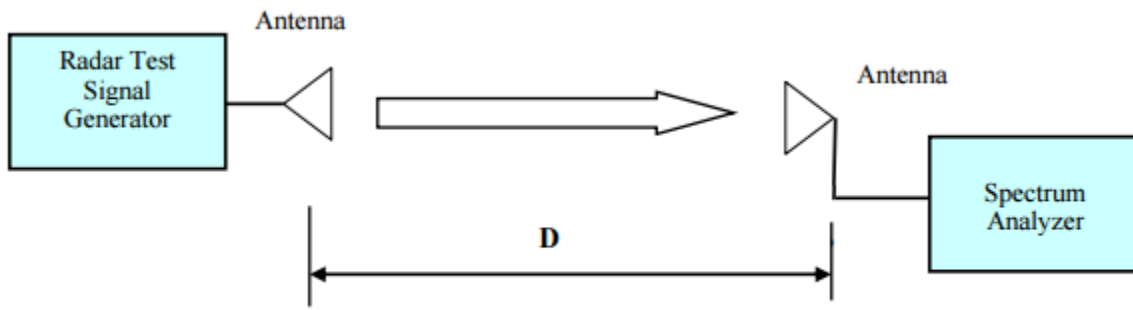

Radiated Calibration Setup Block Diagram

Test Environmental Conditions

Temperature:	17~26.3 °C
Relative Humidity:	27~44 %
ATM Pressure:	100.8~102.8 kPa
Tester:	Chris Mo
Test Date:	2020-12-16~2021-02-25

Plots of Radar Waveforms

5530 MHz:

Radar Type 1A

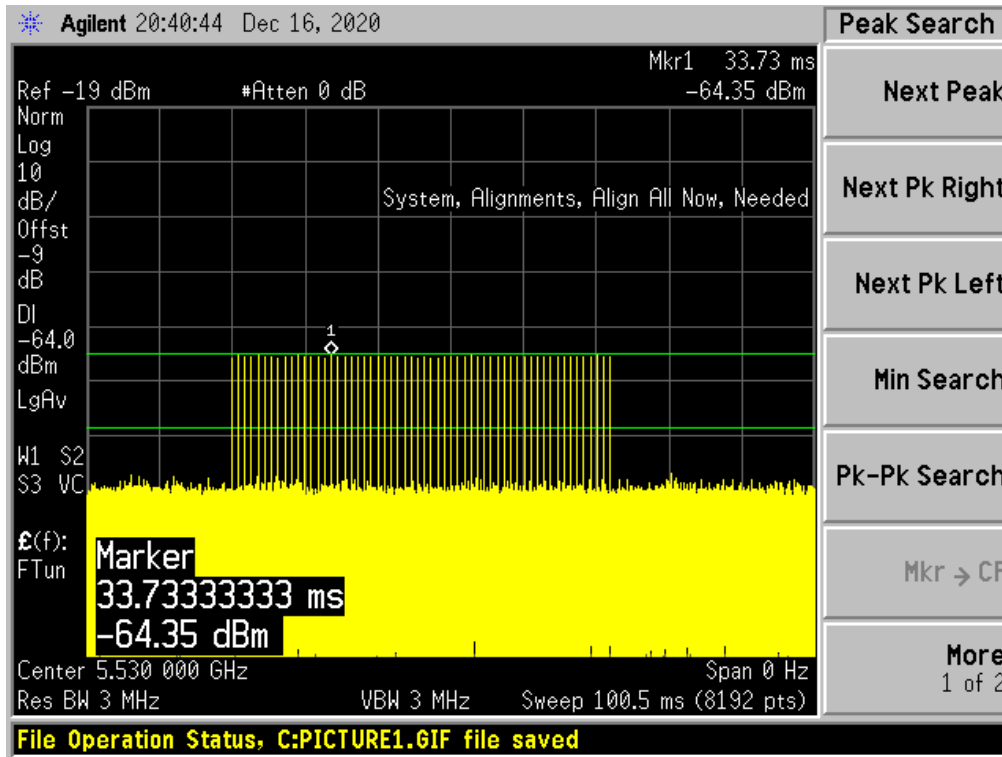

Radar Type 1B

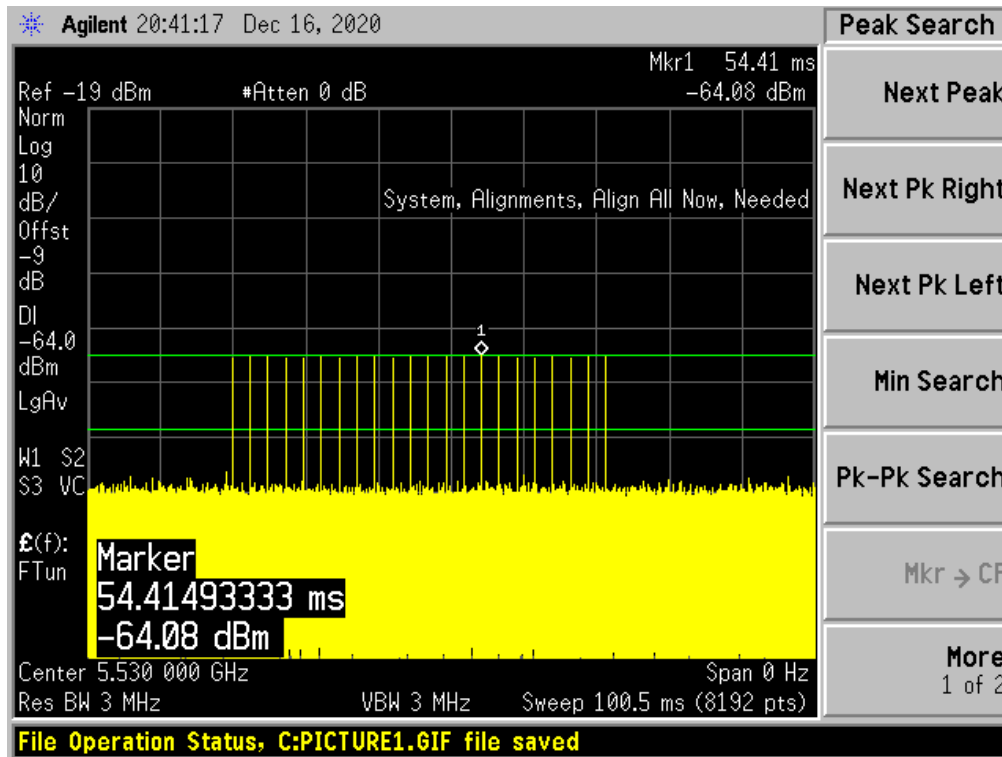

Radar Type 2

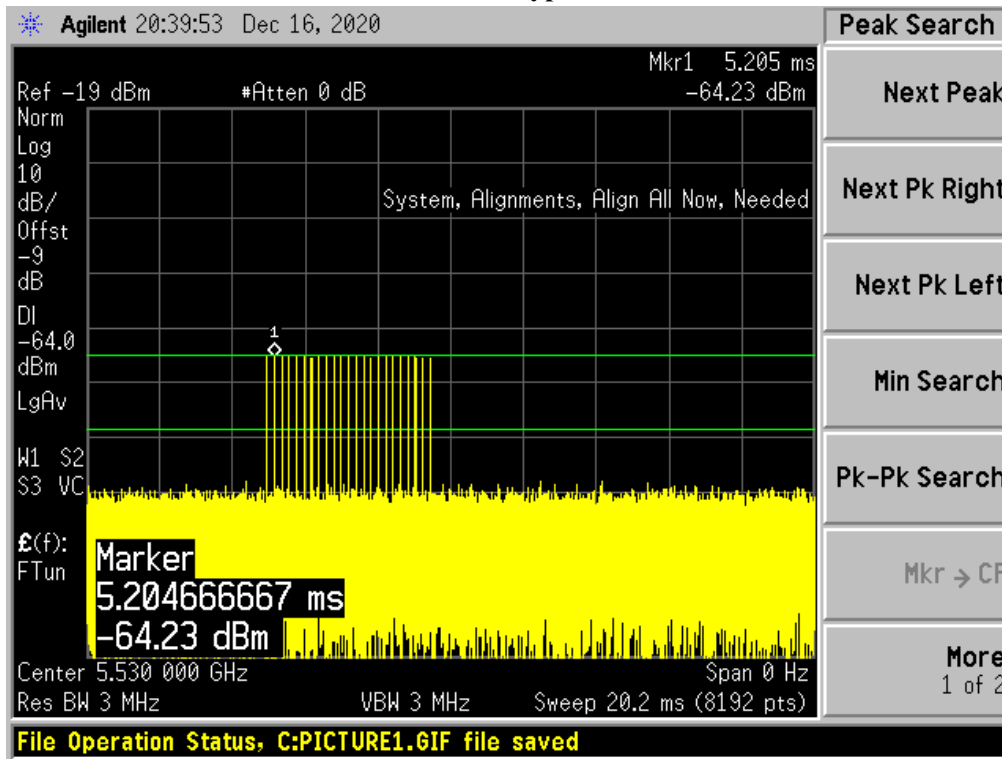

Radar Type 3

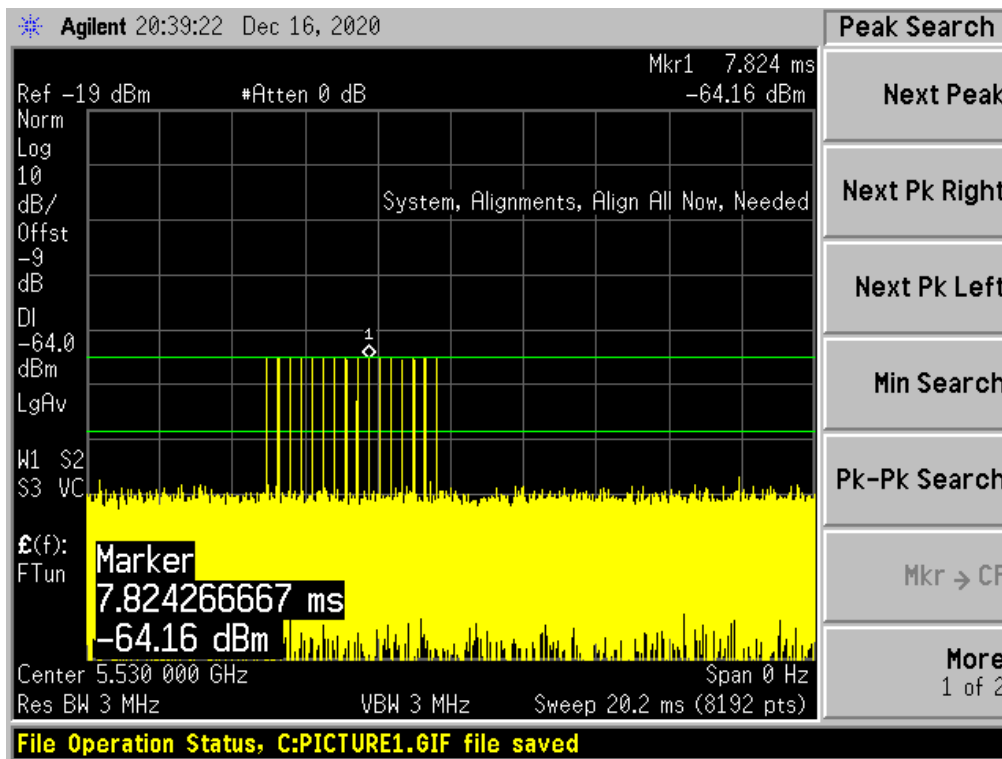

Radar Type 4

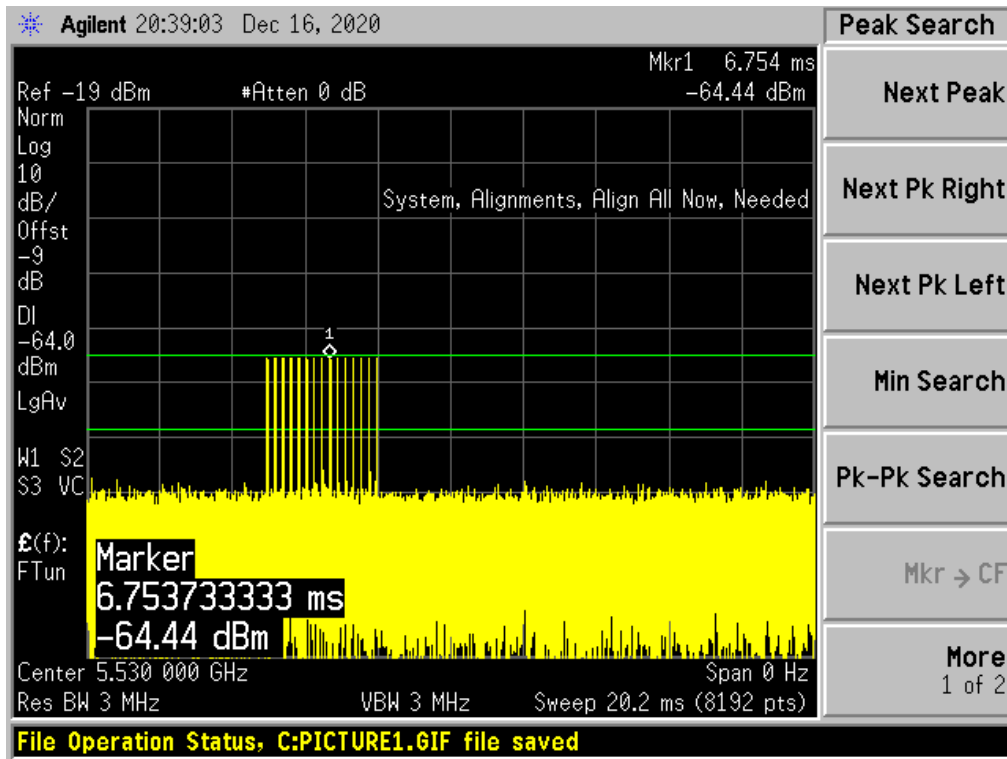

Radar Type 5 Case 1

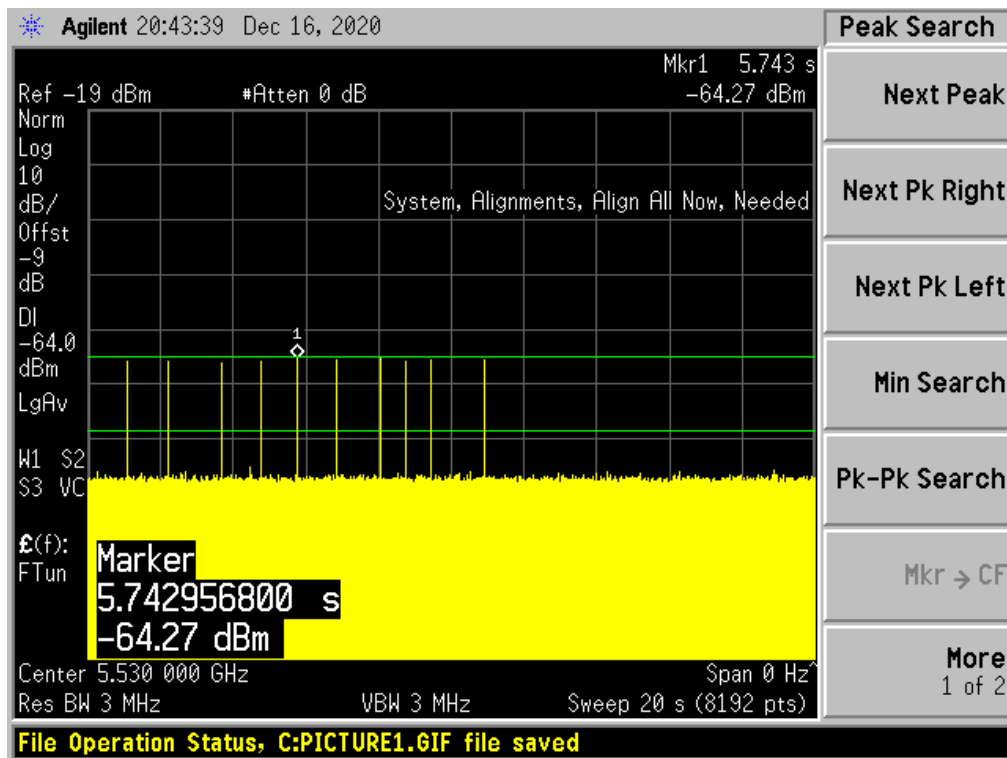

Radar Type 5 Case 2

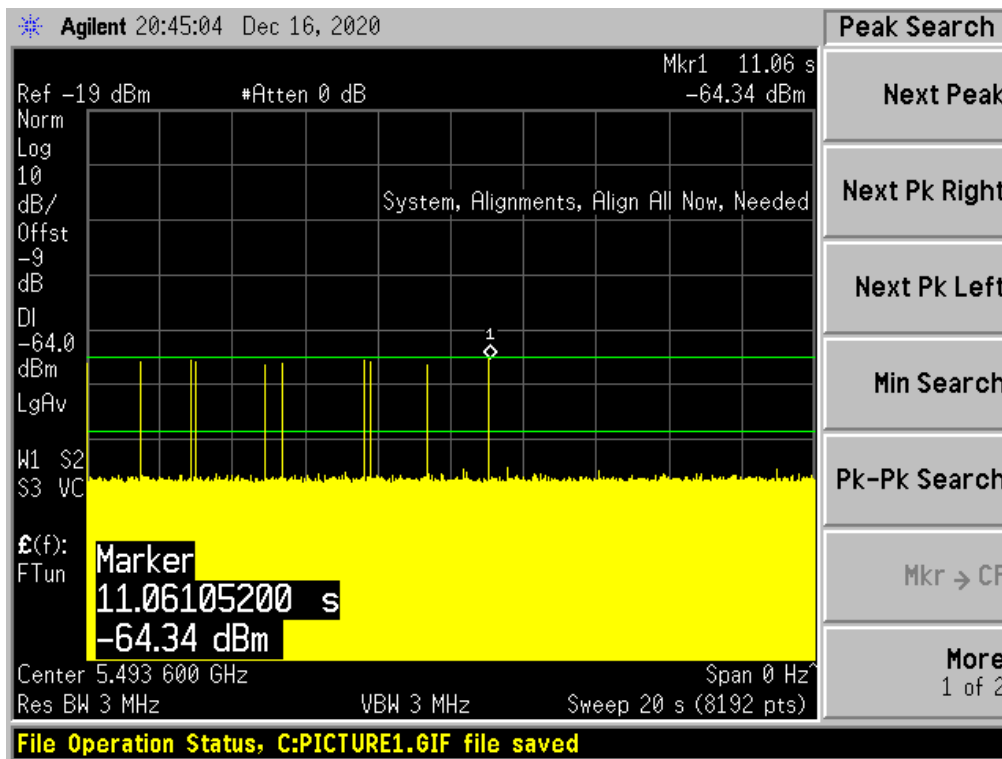

Radar Type 5 Case 3

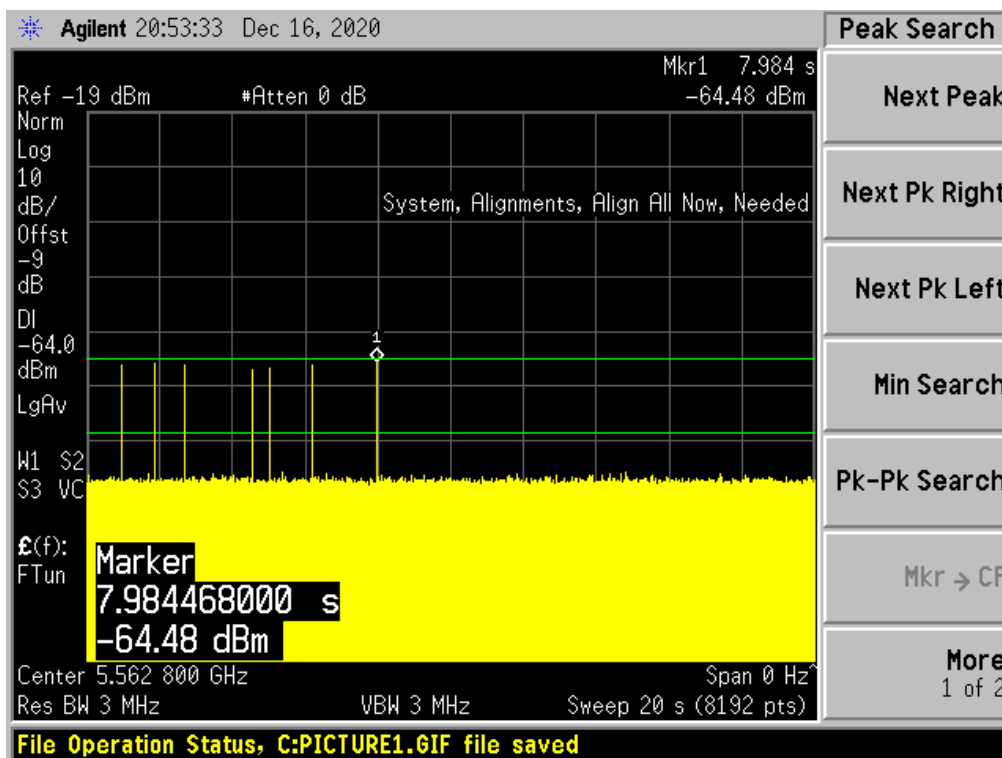

Radar Type 6

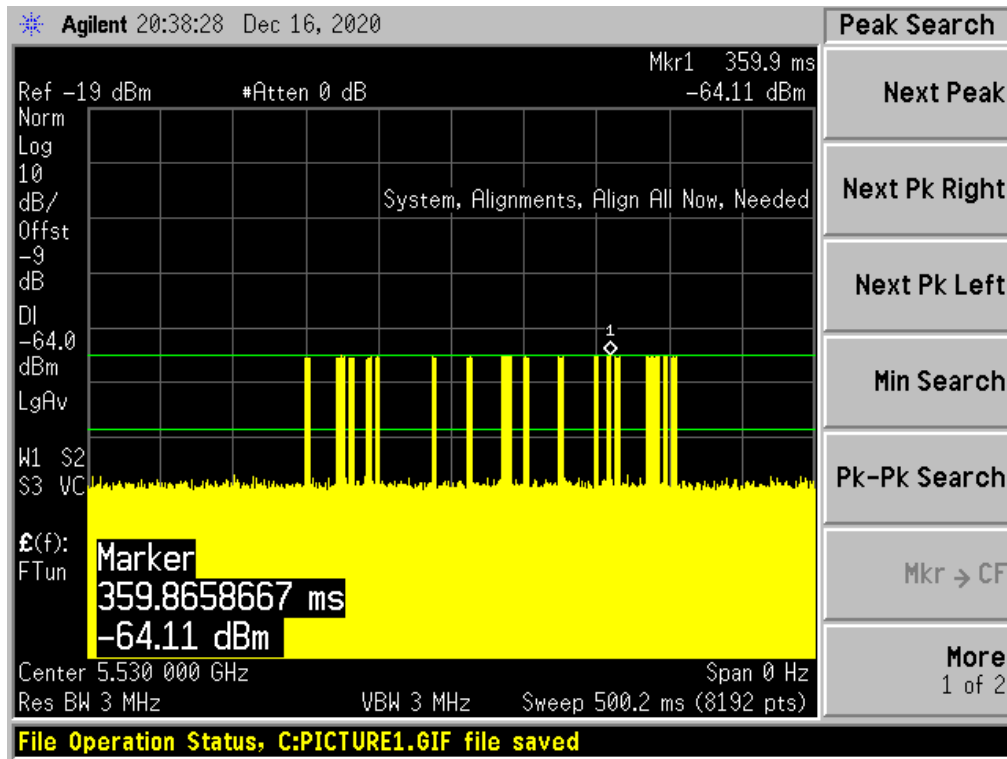

Radar Type 0

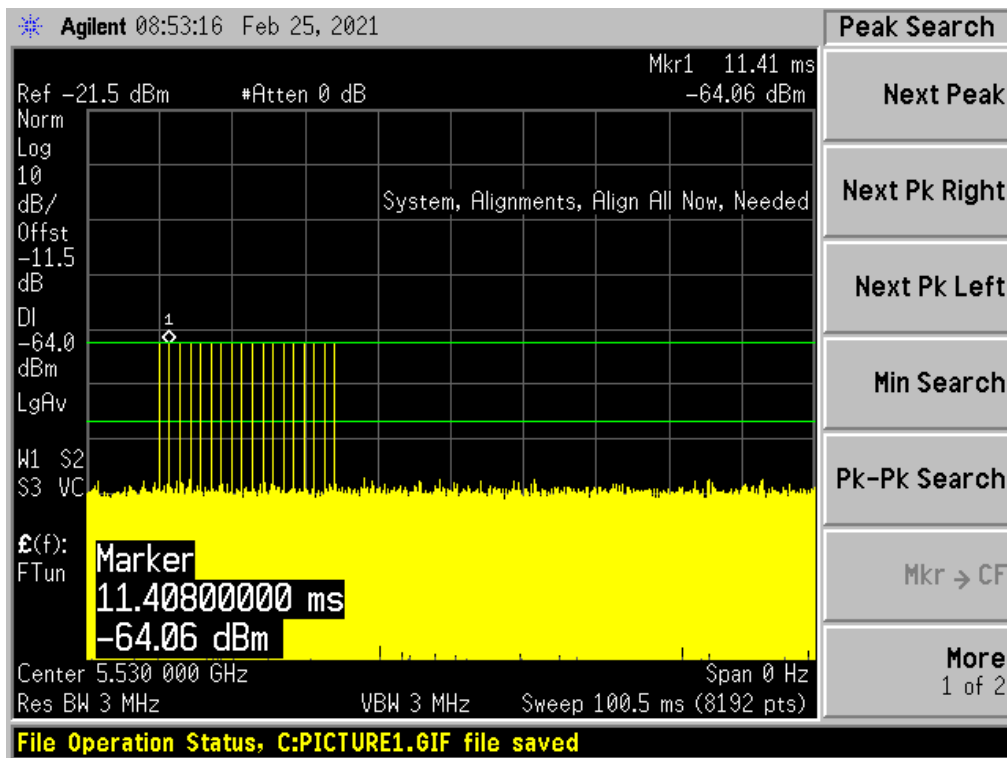

CHANNEL AVAILABILITY CHECK TIME (CAC)

Test Procedure

- 1) Channel Availability Check Time (CAC)
- 2) With link established on channel, apply a radar signal within 0~6 seconds after the initial power-up period; monitor the transmissions on channel from the spectrum analyzer.
- 3) Reboot EUT, with a link established on channel, apply a radar signal within 54~60 seconds after the initial power-up period, and monitor the transmission on channel from the spectrum analyzer.

EUT Initial power-up Cycle Time

Test Frequency (MHz)	EUT initial Power-up cycle (Second)
5530	143.3

Results:

Timing of Radar Burst	Spectrum Analyzer Display
No Radar Triggered	Transmission begin after power-up cycle +60 seconds CAC
Within 6 seconds of the CAC starting	No transmission
Within the last 6 seconds of the CAC	No transmission

Please refer to the following plots.

Plot of without Radar signal applied

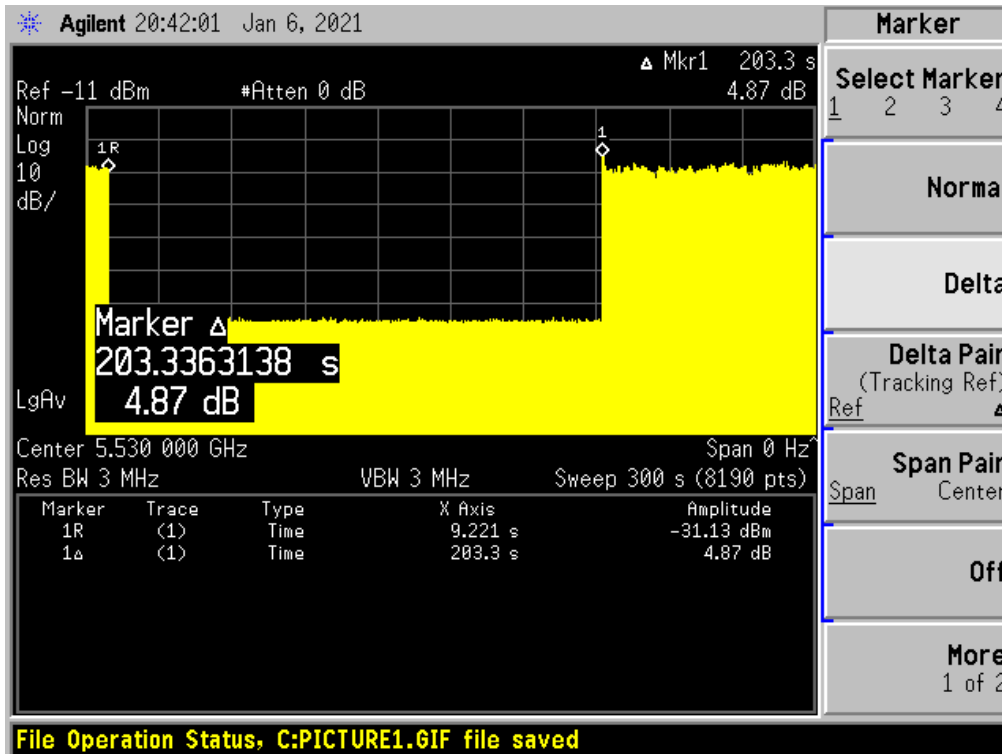

Note: The power-up cycle is 143.3 seconds.

Plot of Radar signal applied within 6 seconds of start of CAC

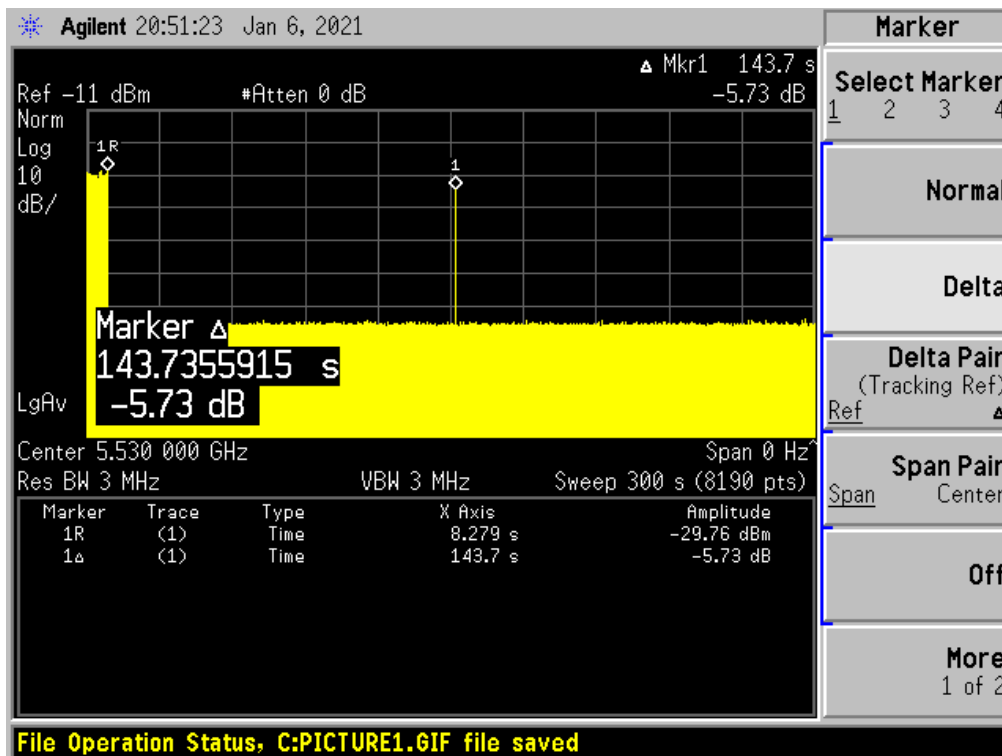

No transmissions found after radar signal applied.

Plot of Radar signal applied at the end of 6 seconds of CAC

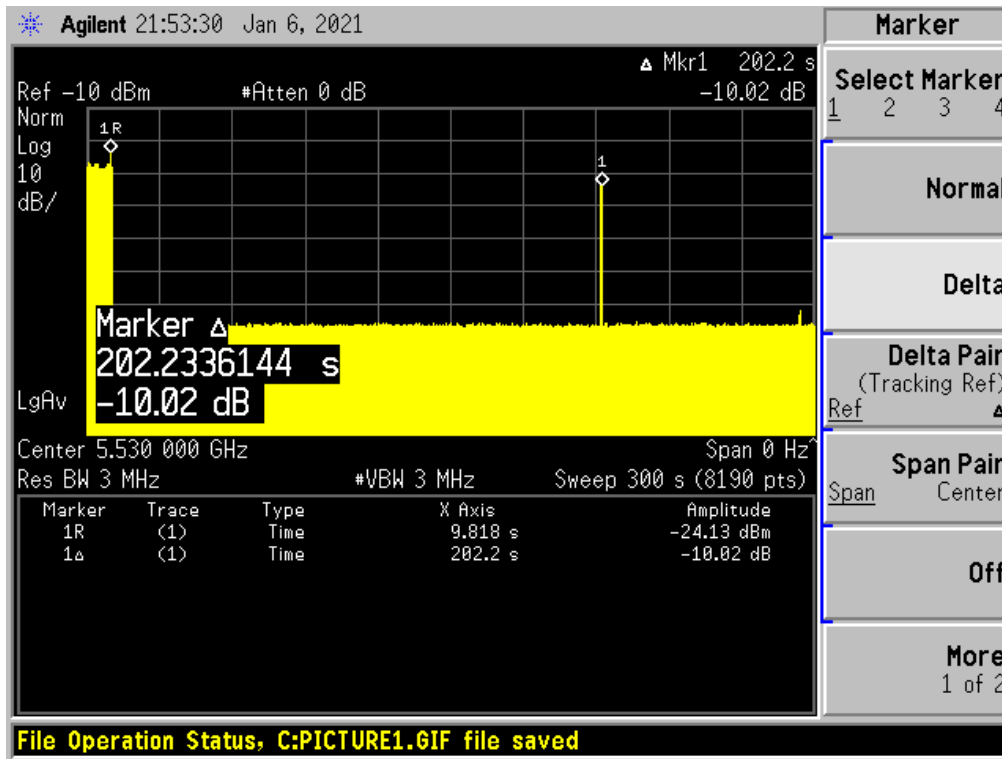

No transmissions found after radar signal applied.

CHANNEL MOVE TIME AND CHANNEL CLOSING TRANSMISSION TIME

Test Procedure

Perform type 0 short pulse radar waveform, repeat using a long pulse radar type5 waveform.
The aggregate channel closing transmission time is calculated as follows:

Aggregate Transmission Time = N*Dwell Time

N is the number of spectrum analyzer bins showing a device transmission Dwell Time is the dwell time per bin (i.e. Dwell Time = S/B, S is the sweep time and B is the number of bin, i.e. 8192)

Test Results

Frequency (MHz)	Bandwidth (MHz)	Radar Type	Results
5530	80	Type 0	Compliant

Please refer to the following tables and plots.

5530 MHz

Type 0 radar channel move time result:

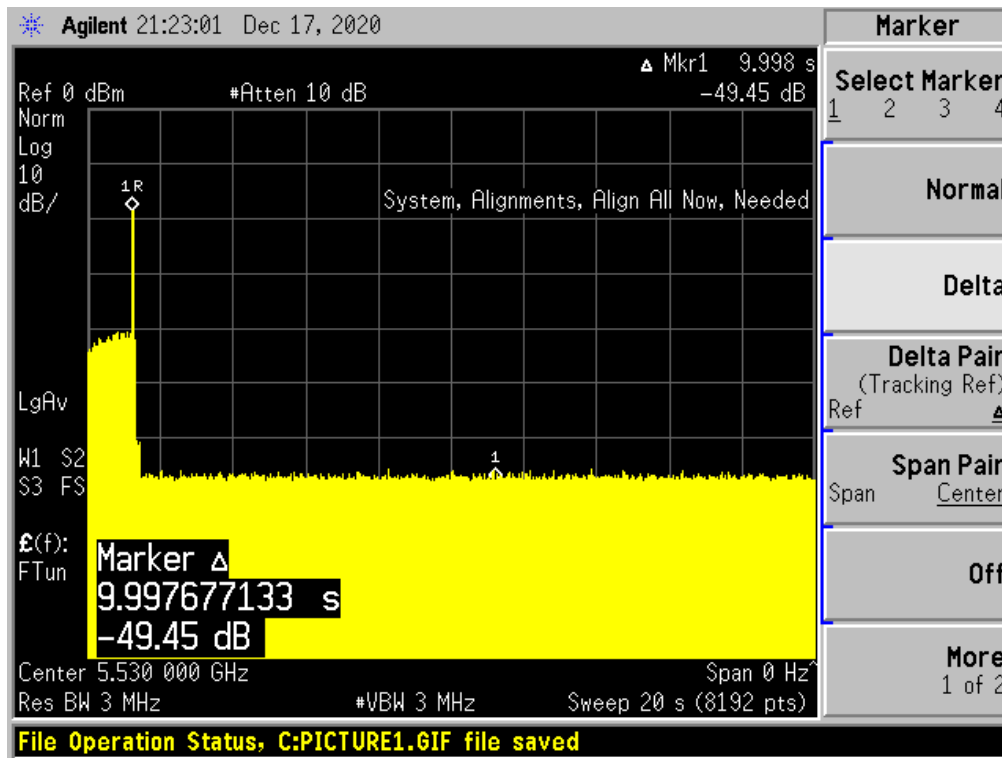

Type0 radar channel closing transmission time result:

Transmission After 200ms	Aggregate Transmission Time After 200ms Delay (ms)	Limit for Aggregate Transmission Time After 200ms Delay (ms)	Result
No	0	60	Pass

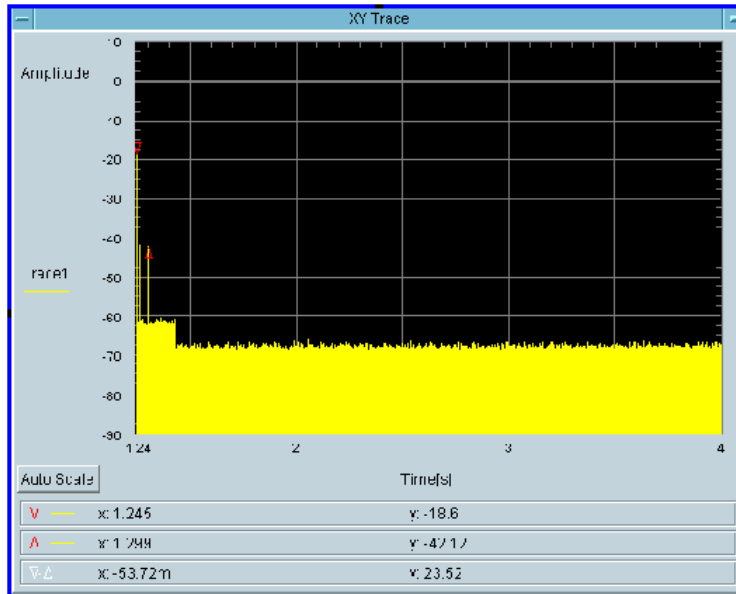

Total On Time [s]
9.766m

Total On Time After Delay [s]

NON-OCCUPANCY PERIOD

Test Procedure

Measure the EUT for more than 30 minutes following the channel close/move time to verify that the EUT does not resume any transmissions on this channel. Provide one plot to demonstrate no transmission on the channel for the non-occupancy period (30 minutes observation time)

Test Result

Frequency(MHz)	Bandwidth (MHz)	Spectrum Analyzer Display
5530	80	No transmission within 30 minutes

Please refer to the following plots.

5530 MHz

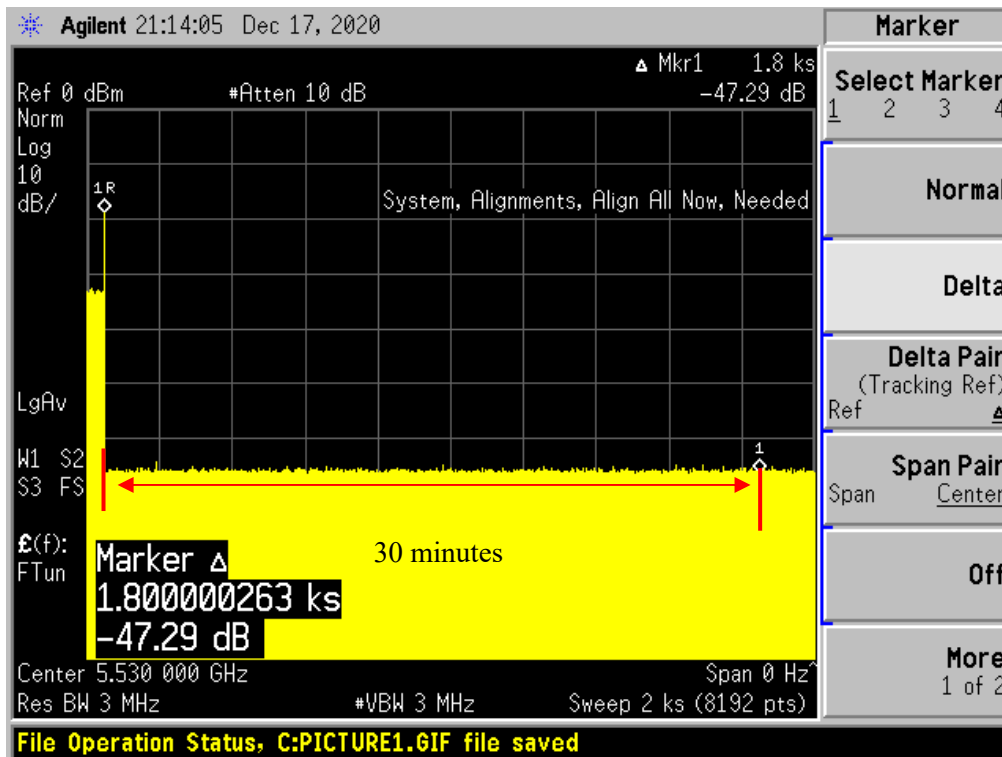

DETECTION BANDWIDTH

Test Procedure

Performed with Type 0 radar waveforms

Starting at the center frequency of the UUT operating *Channel*, increase the radar frequency in 5 MHz steps, repeating the above test sequence, until the detection rate falls below the *U-NII Detection Bandwidth* criterion specified in **Table 4**. Repeat this measurement in 1MHz steps at frequencies 5 MHz below where the detection rate begins to fall. Record the highest frequency (denote as F_H) at which detection is greater than or equal to the *U-NII Detection Bandwidth* criterion. Recording the detection rate at frequencies above F_H is not required to demonstrate compliance.

Starting at the center frequency of the UUT operating *Channel*, decrease the radar frequency in 5 MHz steps, repeating the above test sequence, until the detection rate falls below the *U-NII Detection Bandwidth* criterion specified in **Table 4**. Repeat this measurement in 1MHz steps at frequencies 5 MHz above where the detection rate begins to fall. Record the lowest frequency (denote as F_L) at which detection is greater than or equal to the *U-NII Detection Bandwidth* criterion. Recording the detection rate at frequencies below F_L is not required to demonstrate compliance.

The *U-NII Detection Bandwidth* is calculated as follows:

$$U-NII\ Detection\ Bandwidth = F_H - F_L$$

The *U-NII Detection Bandwidth* must meet the *U-NII Detection Bandwidth* criterion specified in **Table 4**. Otherwise, the UUT does not comply with DFS requirements. This is essential to ensure that the UUT is capable of detecting *Radar Waveforms* across the same frequency spectrum that contains the significant energy from the system. In the case that the *U-NII Detection Bandwidth* is greater than or equal to the 99 percent power bandwidth for the measured F_H and F_L , the test can be truncated and the *U-NII Detection Bandwidth* can be reported as the measured F_H and F_L .

Test Result

Frequency (MHz)	Bandwidth Systems (MHz)	F_L (MHz)	F_H (MHz)	Detection Bandwidth (MHz)	99% Occupied Bandwidth (MHz)	Minimum Limit	Result
5520	20	5510	5530	20	18.16	100%	Compliance
5550	40	5491	5529	38	37.28	100%	Compliance
5530	80	5491	5569	78	76.80	100%	Compliance

Please refer to the following tables.

Results of Detection Bandwidth:

20MHz Bandwidth, EUT Frequency = 5520MHz											
DFS Detection Trials (1 = Detected, 0 = No Detected)											
Radar Frequency (MHz)	1	2	3	4	5	6	7	8	9	10	Detection Rate (%)
5510(F _L)	1	1	1	1	1	1	1	1	1	1	100 %
5511	1	1	1	1	1	1	1	1	1	1	100 %
5512	1	1	1	1	1	1	1	1	1	1	100 %
5513	1	1	1	1	1	1	1	1	1	1	100 %
5514	1	1	1	1	1	1	1	1	1	1	100 %
5515	1	1	1	1	1	1	1	1	1	1	100 %
5520	1	1	1	1	1	1	1	1	1	1	100 %
5525	1	1	1	1	1	1	1	1	1	1	100 %
5526	1	1	1	1	1	1	1	1	1	1	100 %
5527	1	1	1	1	1	1	1	1	1	1	100 %
5528	1	1	1	1	1	1	1	1	1	1	100 %
5529	1	1	1	1	1	1	1	1	1	1	100 %
5530(F_H)	1	1	1	1	1	1	1	1	1	1	100 %
Detection Bandwidth = F _H - F _L = 5530-5510 = 20 MHz											
EUT 99% BW = 18.16 MHz;											Result: Pass

40MHz Bandwidth, EUT Frequency = 5510 MHz											
DFS Detection Trials (1 = Detected, 0 = No Detected)											
Radar Frequency (MHz)	1	2	3	4	5	6	7	8	9	10	Detection Rate (%)
5491(F_L)	1	1	1	1	1	1	1	1	1	1	100 %
5492	1	1	1	1	1	1	1	1	1	1	100 %
5493	1	1	1	1	1	1	1	1	1	1	100 %
5494	1	1	1	1	1	1	1	1	1	1	100 %
5495	1	1	1	1	1	1	1	1	1	1	100 %
5500	1	1	1	1	1	1	1	1	1	1	100 %
5505	1	1	1	1	1	1	1	1	1	1	100 %
5510	1	1	1	1	1	1	1	1	1	1	100 %
5515	1	1	1	1	1	1	1	1	1	1	100 %
5520	1	1	1	1	1	1	1	1	1	1	100 %
5525	1	1	1	1	1	1	1	1	1	1	100 %
5526	1	1	1	1	1	1	1	1	1	1	100 %
5527	1	1	1	1	1	1	1	1	1	1	100 %
5528	1	1	1	1	1	1	1	1	1	1	100 %
5529(F_H)	1	1	1	1	1	1	1	1	1	1	100 %
Detection Bandwidth = F _H – F _L = 5529-5491 =38 MHz											
EUT 99% BW = 37.28 MHz;										Result: Pass	

80MHz Bandwidth, EUT Frequency = 5530 MHz											
DFS Detection Trials (1 = Detected, 0 = No Detected)											
Radar Frequency (MHz)	1	2	3	4	5	6	7	8	9	10	Detection Rate (%)
5491(F _L)	1	1	1	1	1	1	1	1	1	1	100 %
5492	1	1	1	1	1	1	1	1	1	1	100 %
5493	1	1	1	1	1	1	1	1	1	1	100 %
5494	1	1	1	1	1	1	1	1	1	1	100 %
5495	1	1	1	1	1	1	1	1	1	1	100 %
5500	1	1	1	1	1	1	1	1	1	1	100 %
5505	1	1	1	1	1	1	1	1	1	1	100 %
5510	1	1	1	1	1	1	1	1	1	1	100 %
5515	1	1	1	1	1	1	1	1	1	1	100 %
5520	1	1	1	1	1	1	1	1	1	1	100 %
5525	1	1	1	1	1	1	1	1	1	1	100 %
5530	1	1	1	1	1	1	1	1	1	1	100 %
5535	1	1	1	1	1	1	1	1	1	1	100 %
5540	1	1	1	1	1	1	1	1	1	1	100 %
5545	1	1	1	1	1	1	1	1	1	1	100 %
5550	1	1	1	1	1	1	1	1	1	1	100 %
5555	1	1	1	1	1	1	1	1	1	1	100 %
5560	1	1	1	1	1	1	1	1	1	1	100 %
5565	1	1	1	1	1	1	1	1	1	1	100 %
5566	1	1	1	1	1	1	1	1	1	1	100 %
5567	1	1	1	1	1	1	1	1	1	1	100 %
5568	1	1	1	1	1	1	1	1	1	1	100 %
5569(F _H)	1	1	1	1	1	1	1	1	1	1	100 %
Detection Bandwidth = F _H - F _L = 5569-5491 = 78 MHz											
EUT 99% BW = 76.80 MHz;										Result: Pass	

STATISTICAL PERFORMANCE CHECK

Procedure:

The steps below define the procedure to determine the minimum percentage of successful detection requirements found in **Tables 5-7** when a radar burst with a level equal to the *DFS Detection Threshold + 1dB* is generated on the *Operating Channel* of the U-NII device (*In- Service Monitoring*).

- a) One frequency will be chosen from the *Operating Channels* of the UUT within the 5250-5350 MHz or 5470-5725 MHz bands.
- b) In case the UUT is a U-NII device operating as a Client Device (with or without Radar Detection), a U-NII device operating as a Master Device will be used to allow the UUT (Client device) to Associate with the Master Device. In case the UUT is a Master Device, a U-NII device operating as a Client Device will be used and it is assumed that the Client will Associate with the UUT (Master). In both cases for conducted tests, the Radar Waveform generator will be connected to the Master Device. For radiated tests, the emissions of the Radar Waveform generator will be directed towards the Master Device. If the Master Device has antenna gain, the main beam of the antenna will be directed toward the radar emitter. Vertical polarization is used for testing.
- c) Stream the channel loading test file from the *Master Device* to the Client Device on the test *Channel* for the entire period of the test.
- d) At time T_0 the *Radar Waveform* generator sends the individual waveform for each of the Radar Types 1- 6 in **Tables 5-7**, at levels defined in **Table 3**, on the *Operating Channel*. An additional 1 dB is added to the radar test signal to ensure it is at or above the *DFS Detection Threshold*, accounting for equipment variations/errors.
- e) Observe the transmissions of the UUT at the end of the Burst on the *Operating Channel* for duration greater than 10 seconds for Radar Type 0 to ensure detection occurs.
- f) Observe the transmissions of the UUT at the end of the Burst on the *Operating Channel* for duration greater than 22 seconds for Long Pulse Radar Type 5 to ensure detection occurs.
- g) In case the UUT is a U-NII device operating as a *Client Device* with *In-Service Monitoring*, perform steps a) to f).

Result:**20MHz**

Radar SignalType	Waveform/Trial Number	Detection (%)	Limit (%)	Pass/Fail
Type 1A	15	100%	60%	pass
Type 1B	15	100%	60%	pass
Type 2	30	96.7 %	60%	Pass
Type 3	30	96.7 %	60%	Pass
Type 4	30	100 %	60%	Pass
Aggregate(Type1 to 4)	120	98.33 %	80%	Pass
Type 5	30	100 %	80%	Pass
Type 6	30	100 %	70%	Pass

Please refer to the following statistical tables:

5520MHz**Radar Type 1A Statistical Performance**

Trial #	Fc (MHz)	Pulse/Burst	Pulse Width (μ S)	PRI (μ s)	Detection (1:yes; 0:no)
1	5520	70	1	758	1
2	5520	89	1	598	1
3	5520	81	1	658	1
4	5520	86	1	618	1
5	5520	62	1	858	1
6	5520	74	1	718	1
7	5520	83	1	638	1
8	5520	61	1	878	1
9	5520	67	1	798	1
10	5520	72	1	738	1
11	5520	57	1	938	1
12	5520	78	1	678	1
13	5520	92	1	578	1
14	5520	99	1	538	1
15	5520	76	1	698	1
Detection Percentage: 100 % (>60%)					

Radar Type 1B Statistical Performance

Trial #	Fc (MHz)	Pulse/Burst	Pulse Width (μ S)	PRI (μ s)	Detection (1:yes; 0:no)
1	5520	31	1	1754	1
2	5520	28	1	1909	1
3	5520	32	1	1690	1
4	5520	21	1	2560	1
5	5520	19	1	2926	1
6	5520	40	1	1330	1
7	5520	49	1	1096	1
8	5520	21	1	2553	1
9	5520	23	1	2348	1
10	5520	18	1	3007	1
11	5520	44	1	1222	1
12	5520	29	1	1882	1
13	5520	19	1	2928	1
14	5520	20	1	2724	1
15	5520	32	1	1696	1
Detection Percentage: 100 % (>60%)					

Radar Type 2 Statistical Performance

Trial #	Fc (MHz)	Pulse/Burst	Pulse Width (μS)	PRI (μs)	Detection (1:yes; 0:no)
1	5520	24	2.9	215	1
2	5520	26	1.8	229	1
3	5520	23	3.1	175	1
4	5520	27	1.3	150	1
5	5520	26	3.2	182	1
6	5520	27	4.1	156	1
7	5520	26	3	230	1
8	5520	23	2.7	200	1
9	5520	23	1.6	180	1
10	5520	28	4.6	167	1
11	5520	25	4.2	155	1
12	5520	29	3.4	218	1
13	5520	24	1.8	191	1
14	5520	27	4.9	219	1
15	5520	24	4.4	193	1
16	5520	25	2.5	220	1
17	5520	28	3.3	227	1
18	5520	25	2.8	222	1
19	5520	25	4.7	195	1
20	5520	24	4.3	171	1
21	5520	24	1.6	192	1
22	5520	24	1.5	224	1
23	5520	24	3.1	208	1
24	5520	27	4.9	211	1
25	5520	25	4.6	206	1
26	5520	27	3	175	1
27	5520	24	3.9	189	0
28	5520	28	1.9	158	1
29	5520	26	1.5	225	1
30	5520	29	3	197	1
Detection Percentage: 96.7 % (>60%)					

Radar Type 3 Statistical Performance

Trial #	Fc (MHz)	Pulse/Burst	Pulse Width (μS)	PRI (μs)	Detection (1:yes; 0:no)
1	5520	17	6.7	354	1
2	5520	17	8.9	390	1
3	5520	17	7.1	457	1
4	5520	18	6.9	417	1
5	5520	18	6.4	468	1
6	5520	16	6.1	307	1
7	5520	16	8.2	332	1
8	5520	18	6.3	364	1
9	5520	16	8.7	264	1
10	5520	17	8.7	309	1
11	5520	18	7.7	262	1
12	5520	18	7.2	249	1
13	5520	17	7.2	307	1
14	5520	16	6	244	0
15	5520	17	6.5	337	1
16	5520	18	7.7	279	1
17	5520	17	7.1	310	1
18	5520	18	7.6	474	1
19	5520	17	7.1	341	1
20	5520	16	9.2	226	1
21	5520	17	8.9	277	1
22	5520	18	7.7	333	1
23	5520	17	9.7	381	1
24	5520	17	8.6	302	1
25	5520	18	8.5	246	1
26	5520	16	6.6	338	1
27	5520	18	9.6	300	1
28	5520	16	8.7	467	1
29	5520	18	7.2	207	1
30	5520	18	6.2	331	1
Detection Percentage: 96.7 % (>60%)					

Radar Type 4 Statistical Performance

Trial #	Fc (MHz)	Pulse/Burst	Pulse Width (µS)	PRI (µs)	Detection (1:yes; 0:no)
1	5520	16	18.3	258	1
2	5520	15	19.9	203	1
3	5520	12	18.8	406	1
4	5520	16	14.8	316	1
5	5520	13	12.9	206	1
6	5520	13	11.1	291	1
7	5520	16	11	412	1
8	5520	13	19	371	1
9	5520	13	16.8	417	1
10	5520	14	12.9	370	1
11	5520	15	13	479	1
12	5520	14	11.6	217	1
13	5520	16	13.1	234	1
14	5520	12	12.5	316	1
15	5520	14	16.5	414	1
16	5520	14	15.1	287	1
17	5520	12	18.8	489	1
18	5520	13	15.2	347	1
19	5520	16	13.2	497	1
20	5520	16	15.3	200	1
21	5520	15	11.8	394	1
22	5520	15	14.1	391	1
23	5520	16	16.9	258	1
24	5520	15	15.4	215	1
25	5520	13	13.4	352	1
26	5520	13	18.9	211	1
27	5520	15	18.5	266	1
28	5520	14	17.6	498	1
29	5520	13	16.8	217	1
30	5520	15	11	234	1
Detection Percentage: 100 % (>60%)					

Radar Type 5 Case 1 Statistical Performance

Statistics 1 (ChirpCenter Frequency: 5520.0MHz)

Trial #	Pulse	Chirp(MHz)	Pulse Width (μS)	Pulse 1-2 spacing(μS)	Pulse 2-3 spacing(μS)	Pulse Start(S)	Detection (1:yes;0:no)
0	2	12	94.2	1265		0.717703	1
1	2	12	72	1190		1.317542	
2	1	12	77			1.941881	
3	2	12	71.9	1179		2.892175	
4	3	12	82.8	1632	1566	4.450837	
5	2	12	71.4	1534		5.086843	
6	3	12	86.9	1123	1227	5.687594	
7	1	12	52.9			6.538584	
8	2	12	96.3	1122		7.564147	
9	2	12	54.7	1131		8.750837	
10	2	12	77.8	1093		9.870981	
11	2	12	87.2	1830		10.157652	
12	2	12	60	1166		11.590281	

Statistics 2 (ChirpCenter Frequency: 5520.0 MHz)

Trial #	Pulse	Chirp(MHz)	Pulse Width (μS)	Pulse 1-2 spacing(μS)	Pulse 2-3 spacing(μS)	Pulse Start(S)	Detection (1:yes;0:no)
0	3	12	63.8	1482	1553	0.522754	1
1	2	12	93.3	1808		1.437802	
2	1	12	78.2			2.021488	
3	1	12	74.2			2.896216	
4	3	12	63.5	1380	1675	3.447529	
5	3	12	54.6	1379	1043	4.671471	
6	1	12	53.7			5.282650	
7	1	12	96			6.713684	
8	1	12	96.4			7.486606	
9	3	12	52.8	1111	1396	8.413572	
10	1	12	73.6			8.651309	
11	2	12	68.5	1672		10.182429	
12	2	12	55.3	1468		10.581151	
13	2	12	64.9	1206		11.178970	

Statistics 3 (ChirpCenter Frequency: 5520.0 MHz)

Trial #	Pulse	Chirp(MHz)	Pulse Width (μS)	Pulse 1-2 spacing(μS)	Pulse 2-3 spacing(μS)	Pulse Start(S)	Detection (1:yes;0:no)
0	3	14	69.8	1067	1061	0.819973	1
1	3	14	89.5	1872	1894	1.788954	
2	1	14	80.4			2.677604	
3	3	14	62.4	1661	1413	3.155513	
4	1	14	52.2			4.305835	
5	2	14	56.1	1952		5.489453	
6	3	14	73.1	1689	1263	5.944076	
7	1	14	68.6			7.077192	
8	1	14	68.4			7.488238	
9	2	14	51.6	1892		8.793583	
10	2	14	90	1115		9.918317	
11	2	14	71.1	1856		10.499853	
12	3	14	54.7	1128	1503	11.361998	

Statistics 4 (ChirpCenter Frequency: 5520.0 MHz)

Trial #	Pulse	Chirp(MHz)	Pulse Width (μS)	Pulse 1-2 spacing(μS)	Pulse 2-3 spacing(μS)	Pulse Start(S)	Detection (1:yes;0:no)
0	2	15	66.7	1536		0.038547	1
1	3	15	99	1028	1655	1.241462	
2	1	15	71.5			1.422220	
3	2	15	96.6	1517		2.354264	
4	2	15	74.4	1680		2.839146	
5	3	15	81.5	1741	1485	3.233111	
6	3	15	69.1	1490	1670	3.844136	
7	1	15	76.9			4.644434	
8	3	15	74.2	1144	1554	5.274739	
9	1	15	65.1			5.796278	
10	2	15	89.5	1033		6.409662	
11	2	15	71.6	1606		7.064174	
12	3	15	86.8	1120	1061	7.944371	
13	2	15	53.9	1637		8.251429	
14	2	15	96	1701		8.866769	
15	1	15	71			9.696889	
16	1	15	62.8			10.433541	
17	2	15	55.9	1996		11.019018	
18	2	15	75.3	1528		11.574651	

Statistics 5(ChirpCenter Frequency: 5520.0 MHz)

Trial #	Pulse	Chirp(MHz)	Pulse Width (μS)	Pulse 1-2 spacing(μS)	Pulse 2-3 spacing(μS)	Pulse Start(S)	Detection (1:yes;0:no)
0	2	10	54.8	1938		0.380226	1
1	2	10	50.4	1505		1.396771	
2	1	10	99.7			2.177920	
3	1	10	75.5			3.166905	
4	2	10	69.9	1669		3.739159	
5	2	10	88	1267		4.171741	
6	3	10	70.4	1259	1256	5.593974	
7	2	10	66.3	1025		6.255314	
8	1	10	85.2			6.629884	
9	2	10	91.7	1110		7.611494	
10	1	10	75.2			8.656585	
11	2	10	92.9	1835		9.304177	
12	2	10	82.1	1479		10.326345	
13	1	10	60.5			10.565224	
14	2	10	67.2	1031		11.427757	

Statistics 6 (ChirpCenter Frequency: 5520.0 MHz)

Trial #	Pulse	Chirp(MHz)	Pulse Width (μS)	Pulse 1-2 spacing(μS)	Pulse 2-3 spacing(μS)	Pulse Start(S)	Detection (1:yes;0:no)
0	2	12	51.6	1960		1.098696	1
1	2	12	96.4	1116		1.803460	
2	2	12	99.1	1617		3.710129	
3	1	12	81.5			5.162150	
4	1	12	50.5			5.483139	
5	1	12	51.9			6.714204	
6	1	12	97.1			8.679752	
7	2	12	60.8	1337		10.527214	
8	2	12	67	1887		10.988105	

Statistics 7(ChirpCenter Frequency: 5520.0 MHz)

Trial #	Pulse	Chirp(MHz)	Pulse Width (μS)	Pulse 1-2 spacing(μS)	Pulse 2-3 spacing(μS)	Pulse Start(S)	Detection (1:yes;0:no)
0	3	16	73.8	1792	1151	0.146181	1
1	3	16	88.6	1906	1248	1.157805	
2	2	16	75.6	1555		2.053000	
3	3	16	66.7	1072	1379	2.822964	
4	2	16	66.8	1151		3.006768	
5	3	16	82.5	1641	1564	4.174529	
6	1	16	73.8			4.797740	
7	2	16	59.3	1308		5.634158	
8	2	16	78	1598		6.484785	
9	3	16	96.6	1667	1724	7.096030	
10	2	16	58.1	1884		8.117112	
11	2	16	81.5	1722		8.640664	
12	1	16	66.5			9.470302	
13	2	16	88.2	1496		10.392509	
14	2	16	87.7	1319		10.778906	
15	3	16	76.7	1515	1718	11.730534	

Statistics 8 (ChirpCenter Frequency: 5520.0 MHz)

Trial #	Pulse	Chirp(MHz)	Pulse Width (μS)	Pulse 1-2 spacing(μS)	Pulse 2-3 spacing(μS)	Pulse Start(S)	Detection (1:yes;0:no)
0	2	10	87	1428		0.871449	1
1	2	10	57.6	1497		1.531321	
2	1	10	74.4			2.737454	
3	2	10	84.7	1173		3.664894	
4	3	10	84.6	1565	1576	5.142918	
5	2	10	87.2	1556		6.255144	
6	1	10	99.1			7.434338	
7	3	10	87.1	1971	1274	8.243263	
8	2	10	77.5	1956		9.757816	
9	1	10	67.6			10.862977	
10	2	10	85.1	1192		11.617506	

Statistics 9 (ChirpCenter Frequency: 5520.0 MHz)

Trial #	Pulse	Chirp(MHz)	Pulse Width (μS)	Pulse 1-2 spacing(μS)	Pulse 2-3 spacing(μS)	Pulse Start(S)	Detection (1:yes;0:no)
0	2	12	70.4	1799		0.275335	1
1	1	12	86.1			1.330798	
2	1	12	72.4			3.017491	
3	2	12	50.5	1399		3.663836	
4	2	12	85.4	1064		4.999006	
5	2	12	63.2	1450		6.416839	
6	3	12	74.2	1789	1585	6.769819	
7	2	12	63.9	1048		8.052279	
8	2	12	82.8	1286		9.519201	
9	3	12	75.7	1352	1230	10.899807	
10	1	12	98.1			11.455517	

Statistics 10 (ChirpCenter Frequency: 5520.0 MHz)

Trial #	Pulse	Chirp(MHz)	Pulse Width (μS)	Pulse 1-2 spacing(μS)	Pulse 2-3 spacing(μS)	Pulse Start(S)	Detection (1:yes;0:no)
0	1	10	59.5			0.496959	1
1	1	10	88.7			1.754032	
2	2	10	98.5	1127		2.131901	
3	3	10	94.6	1404	1382	3.539639	
4	2	10	75.6	1109		4.758291	
5	2	10	58.4	1190		5.469902	
6	2	10	56.7	1188		6.194989	
7	1	10	95.6			7.528372	
8	2	10	68.8	1150		8.775446	
9	2	10	94.2	1328		9.125345	
10	3	10	60.9	1573	1814	10.238542	
11	2	10	75.7	1908		11.493871	

Radar Type 5 Case 2 Statistical Performance

Statistics 1 (ChirpCenter Frequency: 5518.0 MHz)

Trial #	Pulse	Chirp(MHz)	Pulse Width (μS)	Pulse 1-2 spacing(μS)	Pulse 2-3 spacing(μS)	Pulse Start(S)	Detection (1:yes;0:no)
0	2	19	89.6	1164		0.425203	1
1	1	19	71.5			1.693364	
2	2	19	66.2	1245		3.004273	
3	2	19	58	1347		3.738565	
4	1	19	83.4			5.075675	
5	3	19	68.5	1670	1802	5.683156	
6	2	19	66.9	1458		7.628094	
7	1	19	93.7			7.760454	
8	2	19	72.7	1449		8.832987	
9	1	19	63.9			10.78672	
10	2	19	55.3	1106		11.91016	

Statistics 2 (ChirpCenter Frequency: 5516.0 MHz)

Trial #	Pulse	Chirp(MHz)	Pulse Width (μS)	Pulse 1-2 spacing(μS)	Pulse 2-3 spacing(μS)	Pulse Start(S)	Detection (1:yes;0:no)
0	3	14	65.2	1862	1133	0.638089	1
1	3	14	51.1	1859	1421	0.982837	
2	3	14	90.6	1658	1188	1.69383	
3	3	14	82.2	1279	1086	2.587735	
4	2	14	96.4	1429		3.539445	
5	2	14	93.7	1724		3.796977	
6	2	14	53.3	1470		4.893501	
7	3	14	96	1784	1907	5.550644	
8	1	14	51.1			6.037364	
9	1	14	68.4			7.004178	
10	3	14	71.9	1457	1041	7.551276	
11	1	14	57.2			8.792728	
12	1	14	59.6			9.426215	
13	3	14	88.4	1697	1432	10.30968	
14	2	14	67.3	1501		10.59869	
15	2	14	81	1599		11.50996	

Statistics 3 (ChirpCenter Frequency: 5516.0 MHz)

Trial #	Pulse	Chirp(MHz)	Pulse Width (μS)	Pulse 1-2 spacing(μS)	Pulse 2-3 spacing(μS)	Pulse Start(S)	Detection (1:yes;0:no)
0	2	15	67.9	1692		0.083847	1
1	3	15	78.7	1821	1388	1.066741	
2	1	15	81.8			1.962582	
3	2	15	71.6	1006		2.49301	
4	3	15	68.5	1925	1726	3.154962	
5	2	15	94.3	1664		4.407012	
6	2	15	72.4	1843		4.809649	
7	1	15	58.4			5.69091	
8	3	15	79.4	1107	1410	6.737911	
9	2	15	57.1	1283		6.789061	
10	2	15	93.2	1861		7.514479	
11	1	15	71.9			8.517042	
12	1	15	74.1			9.095396	
13	2	15	93	1069		10.28108	
14	2	15	61.4	1167		10.55043	
15	3	15	81.4	1151	1456	11.50917	

Statistics 4 (ChirpCenter Frequency: 5515.0 MHz)

Trial #	Pulse	Chirp(MHz)	Pulse Width (μS)	Pulse 1-2 spacing(μS)	Pulse 2-3 spacing(μS)	Pulse Start(S)	Detection (1:yes;0:no)
0	1	13	86.4			0.161167	1
1	2	13	74.9	1932		1.558022	
2	2	13	74.5	1549		3.560699	
3	3	13	90.5	1440	1992	3.832568	
4	2	13	76.1	1499		5.291452	
5	2	13	61.7	1185		6.751036	
6	3	13	76.3	1552	1697	8.308752	
7	1	13	74.2			9.129475	
8	1	13	86.1			10.64315	
9	3	13	95.7	1317	1949	11.87361	

Statistics 5 (ChirpCenter Frequency: 5516.0 MHz)

Trial #	Pulse	Chirp(MHz)	Pulse Width (μS)	Pulse 1-2 spacing(μS)	Pulse 2-3 spacing(μS)	Pulse Start(S)	Detection (1:yes;0:no)
0	3	14	83.2	1132	1110	0.221486	1
1	2	14	54.9	1967		1.295998	
2	1	14	71.3			2.066847	
3	3	14	95.1	1011	1461	2.127353	
4	2	14	79.1	1082		3.081917	
5	3	14	81.2	1519	1498	4.187785	
6	1	14	82.2			4.416416	
7	3	14	54.9	1228	1425	5.336543	
8	3	14	78.4	1744	1619	6.071929	
9	3	14	99.3	1862	1046	6.587036	
10	3	14	56.4	1138	1443	7.660363	
11	2	14	59.1	1180		7.937711	
12	1	14	87.7			8.764764	
13	3	14	50.3	1293	1034	9.471903	
14	2	14	99.9	1558		10.096608	
15	3	14	69.2	1434	1999	10.726109	
16	1	14	59.3			11.917047	

Statistics 6 (ChirpCenter Frequency: 5513.0 MHz)

Trial #	Pulse	Chirp(MHz)	Pulse Width (μS)	Pulse 1-2 spacing(μS)	Pulse 2-3 spacing(μS)	Pulse Start(S)	Detection (1:yes;0:no)
0	2	7	93.1	1396		0.729756	1
1	2	7	65.4	1299		0.95323	
2	2	7	96.3	1387		2.008822	
3	2	7	89.2	1641		2.963085	
4	3	7	75.9	1308	1316	3.556348	
5	3	7	73.5	1134	1996	3.844855	
6	3	7	74.5	1776	1816	5.039184	
7	2	7	81.5	1305		5.572125	
8	2	7	97.9	1300		6.698011	
9	1	7	84.9			7.080337	
10	3	7	57.7	1359	1809	7.611225	
11	2	7	60	1706		8.297389	
12	2	7	85.6	1672		9.469074	
13	3	7	62	1663	1949	10.0242	
14	2	7	66.8	1204		10.92153	
15	3	7	61.3	1691	1703	11.25857	

Statistics 7 (ChirpCenter Frequency: 5516.0 MHz)

Trial #	Pulse	Chirp(MHz)	Pulse Width (μS)	Pulse 1-2 spacing(μS)	Pulse 2-3 spacing(μS)	Pulse Start(S)	Detection (1:yes;0:no)
0	2	16	73	1086		0.470967	1
1	2	16	72.7	1665		0.678868	
2	2	16	76.1	1756		1.281323	
3	1	16	75.4			1.915219	
4	2	16	90.6	1986		3.078711	
5	3	16	50.2	1169	1549	3.746638	
6	2	16	79.2	1601		3.962205	
7	2	16	87.2	1404		4.936486	
8	1	16	76.1			5.552953	
9	2	16	57.3	1432		6.049696	
10	2	16	78.8	1549		6.491244	
11	2	16	88.8	1307		7.378304	
12	2	16	92.3	1232		7.921029	
13	3	16	74.7	1140	1219	8.596342	
14	1	16	73.4			9.301182	
15	2	16	72	1916		9.622142	
16	1	16	76.9			10.39684	
17	1	16	61.8			10.77757	
18	3	16	83.6	1210	1970	11.85899	

Statistics 8 (ChirpCenter Frequency: 5516.0 MHz)

Trial #	Pulse	Chirp(MHz)	Pulse Width (μS)	Pulse 1-2 spacing(μS)	Pulse 2-3 spacing(μS)	Pulse Start(S)	Detection (1:yes;0:no)
0	1	14	81.3			0.521952	1
1	1	14	73.5			1.599832	
2	2	14	54.8	1538		2.282248	
3	1	14	73.7			2.978951	
4	2	14	60.1	1289		4.607471	
5	2	14	87.8	1047		4.988554	
6	2	14	94.8	1370		5.807191	
7	2	14	89.7	1324		7.221756	
8	1	14	85.8			8.291337	
9	2	14	97.6	1441		8.963877	
10	2	14	70.1	1674		10.11441	
11	2	14	78.4	1029		10.74736	
12	2	14	81.3	1856		11.28799	

Statistics 9 (ChirpCenter Frequency: 5517.0 MHz)

Trial #	Pulse	Chirp(MHz)	Pulse Width (μS)	Pulse 1-2 spacing(μS)	Pulse 2-3 spacing(μS)	Pulse Start(S)	Detection (1:yes;0:no)
0	3	17	94.5	1918	1023	0.977188	1
1	3	17	52.5	1271	1101	2.518789	
2	2	17	50.7	1032		4.217153	
3	2	17	78.6	1451		5.124259	
4	2	17	81.3	1095		6.542494	
5	2	17	67.9	1566		8.626818	
6	1	17	85.8			9.768471	
7	3	17	52.1	1322	1738	10.57336	

Statistics 10 (ChirpCenter Frequency: 5513.0 MHz)

Trial #	Pulse	Chirp(MHz)	Pulse Width (μS)	Pulse 1-2 spacing(μS)	Pulse 2-3 spacing(μS)	Pulse Start(S)	Detection (1:yes;0:no)
0	3	8	63.2	1535	1421	0.153947	1
1	2	8	73	1111		1.908069	
2	3	8	55.9	1819	1070	2.82919	
3	2	8	72.4	1984		3.967226	
4	2	8	88.5	1790		5.444711	
5	3	8	90.6	1737	1467	6.677497	
6	2	8	93.1	1274		7.836099	
7	2	8	94.4	1053		9.498841	
8	1	8	63.5			10.439705	
9	3	8	61.7	1993	1733	11.389001	

Radar Type 5 Case 3 Statistical Performance

Statistics 1 (ChirpCenter Frequency: 5523.0 MHz)

Trial #	Pulse	Chirp(MHz)	Pulse Width (μS)	Pulse 1-2 spacing(μS)	Pulse 2-3 spacing(μS)	Pulse Start(S)	Detection (1:yes;0:no)
0	2	17	90.2	1195		0.461189	1
1	3	17	78.4	1520	1415	1.276384	
2	1	17	63.3			1.689219	
3	2	17	93.1	1643		2.426385	
4	3	17	98.2	1007	1621	3.727453	
5	2	17	72.4	1485		4.781867	
6	2	17	85.4	1423		5.276545	
7	2	17	76	1213		6.106136	
8	3	17	80.8	1832	1746	7.099936	
9	3	17	64	1023	1073	7.655717	
10	2	17	59.4	1250		8.162366	
11	3	17	87.6	1140	1970	9.362036	
12	2	17	54.4	1662		9.765173	
13	2	17	55.2	1826		11.06825	
14	2	17	73.9	1620		11.59217	

Statistics 2 (ChirpCenter Frequency: 5524.0 MHz)

Trial #	Pulse	Chirp(MHz)	Pulse Width (μS)	Pulse 1-2 spacing(μS)	Pulse 2-3 spacing(μS)	Pulse Start(S)	Detection (1:yes;0:no)
0	1	14	89.3			0.108928	1
1	2	14	59.3	1789		0.97993	
2	2	14	62.2	1250		1.826917	
3	2	14	68.8	1897		2.366029	
4	2	14	64.2	1177		3.404861	
5	1	14	55.3			4.036516	
6	1	14	51.7			4.568373	
7	2	14	66.8	1213		5.359615	
8	2	14	63.4	1592		6.190812	
9	3	14	65.9	1492	1221	6.517563	
10	2	14	98.1	1279		7.442057	
11	2	14	84	1011		8.228294	
12	2	14	75.6	1712		9.136004	
13	2	14	71	1852		9.300775	
14	3	14	90.6	1527	1322	10.35214	
15	2	14	58	1924		10.95289	
16	3	14	79.2	1803	1845	11.94291	

Statistics 3 (ChirpCenter Frequency: 5527.0 MHz)

Trial #	Pulse	Chirp(MHz)	Pulse Width (μS)	Pulse 1-2 spacing(μS)	Pulse 2-3 spacing(μS)	Pulse Start(S)	Detection (1:yes;0:no)
0	2	8	97.6	1414		0.653042	1
1	2	8	89.9	1790		0.84856	
2	2	8	84.8	1862		1.67281	
3	2	8	64.2	1824		2.409099	
4	1	8	64.3			3.032977	
5	3	8	68	1878	1383	3.937696	
6	3	8	65.6	1679	1659	4.572182	
7	2	8	85.2	1379		4.669925	
8	1	8	62.1			5.986134	
9	2	8	78	1527		6.518644	
10	1	8	94.4			6.900612	
11	2	8	50.1	1956		7.702079	
12	2	8	68.2	1323		8.101949	
13	2	8	64.1	1368		9.157717	
14	2	8	87.2	1716		9.381667	
15	2	8	81.9	1620		10.072874	
16	1	8	63.1			11.021854	
17	1	8	68.1			11.774238	

Statistics 4 (ChirpCenter Frequency: 5525.0 MHz)

Trial #	Pulse	Chirp(MHz)	Pulse Width (μS)	Pulse 1-2 spacing(μS)	Pulse 2-3 spacing(μS)	Pulse Start(S)	Detection (1:yes;0:no)
0	3	13	52.8	1026	1745	0.676324	1
1	2	13	67.2	1840		2.75775	
2	3	13	86.2	1235	1823	3.812858	
3	3	13	61.5	1247	1639	4.989952	
4	3	13	69.9	1778	1391	6.655834	
5	2	13	58.3	1334		7.832199	
6	1	13	61.1			9.945837	
7	2	13	63.6	1854		11.504107	

Statistics 5 (ChirpCenter Frequency: 5526.0 MHz)

Trial #	Pulse	Chirp(MHz)	Pulse Width (μS)	Pulse 1-2 spacing(μS)	Pulse 2-3 spacing(μS)	Pulse Start(S)	Detection (1:yes;0:no)
0	3	9	87	1138	1157	0.803522	1
1	2	9	70.4	1193		1.091913	
2	2	9	56.6	1846		2.703748	
3	2	9	99.2	1731		3.416245	
4	2	9	75.3	1531		4.568009	
5	1	9	88.2			5.672067	
6	2	9	81.5	1832		6.151699	
7	3	9	91.6	1105	1510	7.758125	
8	3	9	75.7	1708	1744	8.303002	
9	3	9	71.6	1372	1358	9.873527	
10	2	9	63.4	1845		10.361047	
11	2	9	98.1	1192		11.637119	

Statistics 6 (ChirpCenter Frequency: 5525.0 MHz)

Trial #	Pulse	Chirp(MHz)	Pulse Width (μS)	Pulse 1-2 spacing(μS)	Pulse 2-3 spacing(μS)	Pulse Start(S)	Detection (1:yes;0:no)
0	2	12	51.5	1972		0.050506	1
1	3	12	97.3	1773	1606	1.236376	
2	2	12	85.4	1924		1.503422	
3	1	12	69.2			2.367941	
4	3	12	79.8	1815	1727	3.61643	
5	2	12	52.8	1149		4.484898	
6	1	12	94.7			4.704273	
7	2	12	70.3	1860		5.366454	
8	2	12	60.5	1123		6.234959	
9	2	12	58.1	1804		7.439828	
10	1	12	73.9			7.597464	
11	3	12	75	1507	1733	8.339363	
12	3	12	52	1804	1023	9.541207	
13	3	12	65.1	1728	1610	10.050352	
14	2	12	74.6	1485		10.880405	
15	1	12	60.2			11.990596	

Statistics 7 (ChirpCenter Frequency: 5523.0 MHz)

Trial #	Pulse	Chirp(MHz)	Pulse Width (μS)	Pulse 1-2 spacing(μS)	Pulse 2-3 spacing(μS)	Pulse Start(S)	Detection (1:yes;0:no)
0	2	17	64	1002		0.082784	1
1	2	17	53.2	1050		0.863402	
2	1	17	64.4			1.866072	
3	3	17	59.5	1691	1568	3.058634	
4	1	17	82.5			3.355955	
5	2	17	60.8	1122		4.532392	
6	2	17	62.5	1898		5.078052	
7	1	17	85.1			5.974601	
8	2	17	78.4	1602		6.799239	
9	3	17	54	1601	1205	7.937122	
10	2	17	90.1	1559		8.447974	
11	2	17	71	1363		9.30566	
12	2	17	51.3	1811		9.904562	
13	2	17	99.2	1377		11.027842	
14	3	17	77.4	1095	1333	11.923809	

Statistics 8 (ChirpCenter Frequency: 5527.0 MHz)

Trial #	Pulse	Chirp(MHz)	Pulse Width (μS)	Pulse 1-2 spacing(μS)	Pulse 2-3 spacing(μS)	Pulse Start(S)	Detection (1:yes;0:no)
0	2	8	87.2	1048		0.488256	1
1	2	8	90.8	1867		1.277741	
2	2	8	93.5	1375		2.029298	
3	2	8	52.2	1894		3.012462	
4	2	8	73.2	1129		4.209277	
5	2	8	88.7	1085		4.715237	
6	1	8	94.5			5.993167	
7	1	8	57			6.547394	
8	1	8	76.9			7.413522	
9	1	8	81.9			7.828153	
10	1	8	89.5			8.635547	
11	2	8	52.6	1505		9.897409	
12	1	8	56.6			10.972894	
13	1	8	53.2			11.904279	

Statistics 9 (ChirpCenter Frequency: 5527.0 MHz)

Trial #	Pulse	Chirp(MHz)	Pulse Width (μS)	Pulse 1-2 spacing(μS)	Pulse 2-3 spacing(μS)	Pulse Start(S)	Detection (1:yes;0:no)
0	3	7	84.1	1287	1991	0.1004	1
1	3	7	58.1	1117	1564	1.375093	
2	1	7	86.6			2.139515	
3	1	7	82.2			2.633976	
4	2	7	79.2	1010		3.291624	
5	3	7	51.8	1885	1108	3.761021	
6	2	7	55.9	1821		5.19812	
7	3	7	86.9	1447	1957	5.443093	
8	2	7	87.3	1112		6.155465	
9	3	7	59.7	1329	1544	6.928191	
10	2	7	55.1	1777		7.88783	
11	1	7	80.4			8.422708	
12	1	7	96.2			9.109373	
13	2	7	67.9	1603		10.341785	
14	1	7	52.3			10.756498	
15	3	7	77.2	1621	1915	11.400023	

Statistics 10 (ChirpCenter Frequency: 5525.0 MHz)

Trial #	Pulse	Chirp(MHz)	Pulse Width (μS)	Pulse 1-2 spacing(μS)	Pulse 2-3 spacing(μS)	Pulse Start(S)	Detection (1:yes;0:no)
0	2	13	63	1692		0.446087	1
1	3	13	66.2	1933	1909	1.120504	
2	3	13	96.4	1957	1561	2.403353	
3	2	13	68.8	1265		3.434471	
4	3	13	99.6	1006	1602	4.940472	
5	2	13	70.9	1281		5.831648	
6	3	13	72.2	1307	1951	6.34677	
7	3	13	63.3	1442	1194	7.178421	
8	3	13	50.4	1092	1215	8.650305	
9	3	13	72.6	1401	1165	9.714253	
10	3	13	90.5	1945	1429	10.925823	
11	1	13	61.5			11.87269	

Radar Type 6 Statistical Performance

Trial #	Fc (MHz)	Pulse /Burst	Pulse Width (µS)	PRI (µs)	Detection (1:yes; 0:no)	Hopping Sequence (MHz)
1	5520	9	1	333	1	5465.0, 5321.0, 5282.0, 5702.0, 5459.0, 5676.0, 5561.0, 5493.0, 5276.0, 5720.0, 5265.0, 5697.0, 5316.0, 5682.0, 5434.0, 5268.0, 5547.0, 5558.0, 5628.0, 5631.0, 5600.0, 5435.0, 5708.0, 5665.0, 5408.0, 5287.0, 5456.0, 5365.0, 5301.0, 5436.0, 5371.0, 5696.0, 5400.0, 5692.0, 5514.0, 5346.0, 5379.0, 5722.0, 5439.0, 5545.0, 5713.0, 5304.0, 5608.0, 5588.0, 5630.0, 5610.0, 5701.0, 5457.0, 5579.0, 5576.0, 5428.0, 5421.0, 5549.0, 5378.0, 5273.0, 5411.0, 5694.0, 5540.0, 5335.0, 5406.0, 5367.0, 5376.0, 5585.0, 5498.0, 5650.0, 5670.0, 5267.0, 5657.0, 5295.0, 5513.0, 5412.0, 5582.0, 5418.0, 5604.0, 5497.0, 5445.0, 5602.0, 5491.0, 5340.0, 5417.0, 5661.0, 5374.0, 5528.0, 5647.0, 5481.0, 5704.0, 5318.0, 5469.0, 5413.0, 5567.0, 5409.0, 5460.0, 5343.0, 5483.0, 5642.0, 5280.0, 5397.0, 5431.0, 5317.0, 5327.0
2	5520	9	1	333	1	5693.0, 5309.0, 5281.0, 5614.0, 5425.0, 5700.0, 5466.0, 5638.0, 5303.0, 5551.0, 5623.0, 5327.0, 5265.0, 5406.0, 5310.0, 5514.0, 5252.0, 5255.0, 5483.0, 5465.0, 5414.0, 5330.0, 5711.0, 5519.0, 5697.0, 5347.0, 5290.0, 5331.0, 5453.0, 5298.0, 5487.0, 5431.0, 5434.0, 5557.0, 5368.0, 5492.0, 5501.0, 5355.0, 5534.0, 5358.0, 5604.0, 5289.0, 5274.0, 5335.0, 5558.0, 5631.0, 5403.0, 5313.0, 5460.0, 5489.0, 5606.0, 5494.0, 5662.0, 5271.0, 5637.0, 5311.0, 5439.0, 5579.0, 5301.0, 5607.0, 5455.0, 5692.0, 5520.0, 5291.0, 5661.0, 5682.0, 5548.0, 5679.0, 5392.0, 5495.0, 5446.0, 5578.0, 5681.0, 5684.0, 5427.0, 5696.0, 5552.0, 5278.0, 5713.0, 5533.0, 5695.0, 5570.0, 5253.0, 5268.0, 5402.0, 5663.0, 5645.0, 5610.0, 5419.0, 5583.0, 5664.0, 5596.0, 5704.0, 5250.0, 5503.0, 5423.0, 5589.0, 5651.0, 5567.0, 5531.0
3	5520	9	1	333	1	5279.0, 5253.0, 5384.0, 5292.0, 5350.0, 5630.0, 5365.0, 5627.0, 5406.0, 5395.0, 5269.0, 5632.0, 5348.0, 5364.0, 5569.0, 5698.0, 5717.0, 5342.0, 5340.0, 5500.0, 5310.0, 5694.0, 5331.0, 5685.0, 5294.0, 5533.0, 5640.0, 5387.0, 5497.0, 5343.0, 5312.0, 5309.0, 5267.0, 5673.0, 5441.0, 5664.0, 5618.0, 5671.0, 5590.0, 5373.0, 5283.0, 5541.0, 5407.0, 5458.0, 5423.0, 5318.0, 5715.0, 5386.0, 5349.0, 5306.0, 5503.0, 5505.0, 5610.0, 5307.0, 5622.0, 5714.0, 5524.0, 5510.0, 5511.0, 5405.0, 5375.0, 5527.0, 5486.0, 5291.0, 5665.0

						5472.0, 5555.0, 5481.0, 5363.0, 5647.0, 5547.0, 5593.0, 5635.0, 5701.0, 5565.0, 5606.0, 5571.0, 5581.0, 5566.0, 5513.0, 5614.0, 5637.0, 5424.0, 5369.0, 5489.0, 5332.0, 5604.0, 5336.0, 5434.0, 5412.0, 5512.0, 5367.0, 5631.0, 5475.0, 5574.0, 5706.0, 5438.0, 5425.0, 5616.0, 5464.0
4	5520	9	1	333	1	5518.0, 5413.0, 5692.0, 5304.0, 5352.0, 5525.0, 5592.0, 5688.0, 5299.0, 5627.0, 5376.0, 5476.0, 5528.0, 5271.0, 5386.0, 5522.0, 5546.0, 5604.0, 5636.0, 5475.0, 5381.0, 5389.0, 5279.0, 5457.0, 5399.0, 5508.0, 5532.0, 5667.0, 5374.0, 5682.0, 5481.0, 5287.0, 5687.0, 5716.0, 5353.0, 5491.0, 5657.0, 5420.0, 5291.0, 5596.0, 5417.0, 5351.0, 5324.0, 5601.0, 5270.0, 5472.0, 5366.0, 5385.0, 5711.0, 5526.0, 5312.0, 5659.0, 5252.0, 5453.0, 5473.0, 5630.0, 5579.0, 5320.0, 5465.0, 5388.0, 5534.0, 5707.0, 5609.0, 5269.0, 5548.0, 5418.0, 5356.0, 5360.0, 5480.0, 5283.0, 5461.0, 5362.0, 5674.0, 5306.0, 5421.0, 5382.0, 5436.0, 5302.0, 5565.0, 5547.0, 5638.0, 5405.0, 5345.0, 5256.0, 5471.0, 5265.0, 5435.0, 5617.0, 5474.0, 5577.0, 5580.0, 5257.0, 5705.0, 5452.0, 5455.0, 5582.0, 5668.0, 5322.0, 5298.0, 5492.0
5	5520	9	1	333	1	5694.0, 5720.0, 5289.0, 5642.0, 5641.0, 5269.0, 5627.0, 5444.0, 5683.0, 5680.0, 5602.0, 5554.0, 5378.0, 5658.0, 5546.0, 5308.0, 5661.0, 5411.0, 5597.0, 5272.0, 5459.0, 5585.0, 5622.0, 5563.0, 5670.0, 5540.0, 5676.0, 5463.0, 5407.0, 5643.0, 5723.0, 5711.0, 5397.0, 5629.0, 5501.0, 5333.0, 5679.0, 5278.0, 5315.0, 5610.0, 5484.0, 5721.0, 5443.0, 5300.0, 5561.0, 5558.0, 5301.0, 5274.0, 5544.0, 5514.0, 5583.0, 5520.0, 5486.0, 5499.0, 5432.0, 5412.0, 5462.0, 5612.0, 5681.0, 5339.0, 5647.0, 5365.0, 5456.0, 5698.0, 5409.0, 5699.0, 5510.0, 5353.0, 5536.0, 5391.0, 5302.0, 5512.0, 5351.0, 5360.0, 5256.0, 5368.0, 5423.0, 5648.0, 5571.0, 5562.0, 5595.0, 5298.0, 5606.0, 5537.0, 5678.0, 5491.0, 5327.0, 5559.0, 5637.0, 5530.0, 5370.0, 5625.0, 5451.0, 5634.0, 5290.0, 5508.0, 5375.0, 5356.0, 5473.0, 5589.0
6	5520	9	1	333	1	5495.0, 5642.0, 5530.0, 5661.0, 5272.0, 5270.0, 5659.0, 5686.0, 5464.0, 5263.0, 5588.0, 5449.0, 5520.0, 5283.0, 5719.0, 5503.0, 5564.0, 5397.0, 5608.0, 5438.0, 5536.0, 5641.0, 5584.0, 5377.0, 5508.0, 5529.0, 5357.0, 5527.0, 5453.0, 5450.0, 5518.0, 5481.0, 5466.0, 5681.0, 5281.0, 5493.0, 5267.0, 5383.0, 5342.0, 5639.0, 5635.0, 5402.0, 5295.0, 5593.0, 5687.0, 5451.0, 5697.0, 5706.0, 5285.0, 5532.0, 5256.0, 5523.0, 5559.0, 5594.0, 5620.0, 5695.0, 5510.0, 5410.0, 5364.0, 5648.0, 5254.0, 5467.0, 5426.0, 5673.0, 5700.0

						5617.0, 5299.0, 5396.0, 5654.0, 5526.0, 5612.0, 5386.0, 5502.0, 5615.0, 5643.0, 5674.0, 5498.0, 5538.0, 5253.0, 5519.0, 5393.0, 5714.0, 5324.0, 5653.0, 5355.0, 5499.0, 5360.0, 5407.0, 5707.0, 5374.0, 5521.0, 5631.0, 5668.0, 5576.0, 5328.0, 5411.0, 5282.0, 5712.0, 5562.0, 5440.0
7	5520	9	1	333	1	5574.0, 5324.0, 5533.0, 5647.0, 5583.0, 5562.0, 5578.0, 5552.0, 5707.0, 5528.0, 5497.0, 5292.0, 5479.0, 5582.0, 5704.0, 5506.0, 5255.0, 5619.0, 5621.0, 5283.0, 5344.0, 5426.0, 5571.0, 5424.0, 5388.0, 5684.0, 5594.0, 5630.0, 5473.0, 5688.0, 5484.0, 5442.0, 5637.0, 5440.0, 5614.0, 5340.0, 5275.0, 5369.0, 5680.0, 5572.0, 5598.0, 5706.0, 5683.0, 5445.0, 5487.0, 5651.0, 5661.0, 5371.0, 5587.0, 5446.0, 5686.0, 5717.0, 5337.0, 5476.0, 5294.0, 5556.0, 5681.0, 5329.0, 5570.0, 5448.0, 5585.0, 5609.0, 5682.0, 5281.0, 5342.0, 5252.0, 5348.0, 5430.0, 5297.0, 5509.0, 5723.0, 5403.0, 5603.0, 5664.0, 5478.0, 5475.0, 5494.0, 5412.0, 5705.0, 5653.0, 5268.0, 5254.0, 5332.0, 5389.0, 5613.0, 5628.0, 5291.0, 5701.0, 5663.0, 5629.0, 5592.0, 5410.0, 5579.0, 5502.0, 5636.0, 5568.0, 5359.0, 5318.0, 5309.0, 5406.0
8	5520	9	1	333	1	5675.0, 5384.0, 5293.0, 5583.0, 5423.0, 5359.0, 5593.0, 5648.0, 5558.0, 5561.0, 5368.0, 5341.0, 5302.0, 5564.0, 5658.0, 5476.0, 5391.0, 5686.0, 5606.0, 5319.0, 5471.0, 5354.0, 5666.0, 5715.0, 5325.0, 5457.0, 5283.0, 5587.0, 5481.0, 5470.0, 5556.0, 5445.0, 5534.0, 5660.0, 5441.0, 5629.0, 5328.0, 5684.0, 5284.0, 5317.0, 5419.0, 5315.0, 5334.0, 5346.0, 5430.0, 5369.0, 5375.0, 5265.0, 5600.0, 5579.0, 5310.0, 5386.0, 5376.0, 5258.0, 5366.0, 5394.0, 5404.0, 5356.0, 5413.0, 5460.0, 5695.0, 5469.0, 5311.0, 5711.0, 5466.0, 5655.0, 5673.0, 5392.0, 5385.0, 5485.0, 5365.0, 5618.0, 5678.0, 5685.0, 5352.0, 5267.0, 5344.0, 5303.0, 5307.0, 5256.0, 5361.0, 5617.0, 5621.0, 5519.0, 5654.0, 5625.0, 5282.0, 5259.0, 5717.0, 5705.0, 5696.0, 5710.0, 5403.0, 5412.0, 5628.0, 5333.0, 5622.0, 5295.0, 5701.0, 5637.0
9	5520	9	1	333	1	5719.0, 5458.0, 5451.0, 5604.0, 5509.0, 5325.0, 5369.0, 5540.0, 5278.0, 5395.0, 5450.0, 5261.0, 5464.0, 5512.0, 5329.0, 5546.0, 5555.0, 5519.0, 5446.0, 5623.0, 5649.0, 5400.0, 5372.0, 5707.0, 5646.0, 5492.0, 5366.0, 5672.0, 5413.0, 5723.0, 5521.0, 5715.0, 5571.0, 5268.0, 5674.0, 5617.0, 5526.0, 5513.0, 5536.0, 5572.0, 5295.0, 5522.0, 5639.0, 5255.0, 5311.0, 5434.0, 5614.0, 5607.0, 5599.0, 5643.0, 5312.0, 5610.0, 5256.0, 5460.0, 5471.0, 5496.0, 5582.0, 5289.0, 5667.0, 5593.0, 5274.0, 5416.0, 5300.0, 5362.0, 5699.0

						5711.0, 5321.0, 5561.0, 5692.0, 5658.0, 5409.0, 5282.0, 5530.0, 5288.0, 5270.0, 5442.0, 5588.0, 5689.0, 5250.0, 5263.0, 5635.0, 5621.0, 5437.0, 5542.0, 5710.0, 5277.0, 5687.0, 5668.0, 5680.0, 5545.0, 5609.0, 5303.0, 5483.0, 5374.0, 5663.0, 5441.0, 5659.0, 5481.0, 5714.0, 5704.0
10	5520	9	1	333	1	5406.0, 5647.0, 5722.0, 5619.0, 5414.0, 5616.0, 5327.0, 5659.0, 5503.0, 5381.0, 5320.0, 5358.0, 5374.0, 5537.0, 5339.0, 5639.0, 5351.0, 5476.0, 5585.0, 5306.0, 5573.0, 5348.0, 5555.0, 5549.0, 5660.0, 5361.0, 5250.0, 5256.0, 5308.0, 5417.0, 5662.0, 5282.0, 5581.0, 5458.0, 5516.0, 5609.0, 5472.0, 5395.0, 5515.0, 5502.0, 5529.0, 5399.0, 5391.0, 5536.0, 5562.0, 5626.0, 5531.0, 5354.0, 5588.0, 5538.0, 5364.0, 5577.0, 5499.0, 5513.0, 5292.0, 5274.0, 5559.0, 5276.0, 5469.0, 5421.0, 5477.0, 5392.0, 5307.0, 5582.0, 5640.0, 5261.0, 5465.0, 5346.0, 5344.0, 5618.0, 5558.0, 5715.0, 5630.0, 5564.0, 5275.0, 5390.0, 5672.0, 5596.0, 5627.0, 5652.0, 5353.0, 5423.0, 5569.0, 5436.0, 5621.0, 5575.0, 5612.0, 5286.0, 5350.0, 5654.0, 5382.0, 5362.0, 5651.0, 5416.0, 5383.0, 5369.0, 5463.0, 5628.0, 5255.0, 5470.0
11	5520	9	1	333	1	5573.0, 5611.0, 5504.0, 5634.0, 5693.0, 5518.0, 5369.0, 5263.0, 5337.0, 5498.0, 5650.0, 5613.0, 5449.0, 5632.0, 5571.0, 5592.0, 5398.0, 5707.0, 5636.0, 5394.0, 5464.0, 5700.0, 5494.0, 5711.0, 5558.0, 5273.0, 5426.0, 5364.0, 5708.0, 5517.0, 5436.0, 5332.0, 5670.0, 5341.0, 5699.0, 5604.0, 5423.0, 5268.0, 5585.0, 5590.0, 5305.0, 5530.0, 5521.0, 5409.0, 5629.0, 5691.0, 5471.0, 5430.0, 5413.0, 5331.0, 5339.0, 5381.0, 5557.0, 5578.0, 5302.0, 5493.0, 5395.0, 5317.0, 5370.0, 5595.0, 5309.0, 5474.0, 5653.0, 5610.0, 5470.0, 5435.0, 5549.0, 5536.0, 5579.0, 5705.0, 5490.0, 5469.0, 5628.0, 5524.0, 5458.0, 5663.0, 5481.0, 5422.0, 5428.0, 5506.0, 5315.0, 5508.0, 5676.0, 5367.0, 5484.0, 5376.0, 5350.0, 5254.0, 5637.0, 5657.0, 5375.0, 5399.0, 5689.0, 5608.0, 5519.0, 5713.0, 5462.0, 5513.0, 5655.0, 5266.0
12	5520	9	1	333	1	5718.0, 5527.0, 5578.0, 5467.0, 5382.0, 5714.0, 5690.0, 5551.0, 5563.0, 5684.0, 5664.0, 5402.0, 5661.0, 5687.0, 5386.0, 5575.0, 5615.0, 5478.0, 5307.0, 5425.0, 5341.0, 5414.0, 5694.0, 5275.0, 5510.0, 5320.0, 5496.0, 5430.0, 5398.0, 5311.0, 5583.0, 5354.0, 5380.0, 5290.0, 5344.0, 5423.0, 5624.0, 5560.0, 5649.0, 5537.0, 5566.0, 5469.0, 5466.0, 5350.0, 5392.0, 5599.0, 5403.0, 5483.0, 5502.0, 5497.0, 5263.0, 5415.0, 5686.0, 5613.0, 5352.0, 5373.0, 5440.0, 5328.0, 5435.0, 5604.0, 5698.0, 5531.0, 5700.0, 5678.0, 5593.0

						5503.0, 5695.0, 5711.0, 5715.0, 5253.0, 5367.0, 5411.0, 5346.0, 5418.0, 5454.0, 5356.0, 5429.0, 5585.0, 5697.0, 5463.0, 5554.0, 5685.0, 5391.0, 5289.0, 5623.0, 5476.0, 5601.0, 5651.0, 5417.0, 5338.0, 5617.0, 5257.0, 5691.0, 5511.0, 5363.0, 5298.0, 5351.0, 5602.0, 5460.0, 5548.0
13	5520	9	1	333	1	5634.0, 5711.0, 5318.0, 5611.0, 5667.0, 5447.0, 5599.0, 5460.0, 5517.0, 5527.0, 5722.0, 5463.0, 5451.0, 5505.0, 5267.0, 5484.0, 5346.0, 5659.0, 5425.0, 5255.0, 5304.0, 5382.0, 5270.0, 5406.0, 5361.0, 5291.0, 5609.0, 5652.0, 5426.0, 5512.0, 5644.0, 5457.0, 5372.0, 5365.0, 5660.0, 5523.0, 5468.0, 5676.0, 5701.0, 5320.0, 5597.0, 5693.0, 5336.0, 5264.0, 5643.0, 5707.0, 5681.0, 5349.0, 5424.0, 5362.0, 5297.0, 5398.0, 5540.0, 5541.0, 5351.0, 5488.0, 5420.0, 5452.0, 5543.0, 5574.0, 5619.0, 5364.0, 5526.0, 5482.0, 5494.0, 5528.0, 5338.0, 5556.0, 5586.0, 5444.0, 5723.0, 5570.0, 5605.0, 5303.0, 5285.0, 5456.0, 5490.0, 5455.0, 5373.0, 5647.0, 5387.0, 5591.0, 5673.0, 5491.0, 5661.0, 5610.0, 5592.0, 5628.0, 5518.0, 5568.0, 5664.0, 5462.0, 5716.0, 5583.0, 5331.0, 5430.0, 5334.0, 5692.0, 5434.0, 5327.0
14	5520	9	1	333	1	5606.0, 5289.0, 5573.0, 5499.0, 5496.0, 5642.0, 5495.0, 5268.0, 5297.0, 5657.0, 5685.0, 5288.0, 5342.0, 5340.0, 5558.0, 5321.0, 5302.0, 5647.0, 5362.0, 5299.0, 5643.0, 5325.0, 5668.0, 5682.0, 5611.0, 5272.0, 5689.0, 5278.0, 5347.0, 5536.0, 5314.0, 5330.0, 5379.0, 5574.0, 5614.0, 5599.0, 5424.0, 5659.0, 5406.0, 5469.0, 5490.0, 5367.0, 5621.0, 5581.0, 5688.0, 5317.0, 5380.0, 5363.0, 5564.0, 5344.0, 5280.0, 5260.0, 5542.0, 5352.0, 5408.0, 5603.0, 5262.0, 5450.0, 5442.0, 5350.0, 5426.0, 5263.0, 5338.0, 5641.0, 5257.0, 5548.0, 5285.0, 5251.0, 5578.0, 5455.0, 5665.0, 5519.0, 5580.0, 5619.0, 5459.0, 5449.0, 5576.0, 5298.0, 5579.0, 5529.0, 5546.0, 5681.0, 5345.0, 5666.0, 5261.0, 5680.0, 5511.0, 5616.0, 5598.0, 5364.0, 5667.0, 5607.0, 5452.0, 5334.0, 5276.0, 5656.0, 5508.0, 5460.0, 5277.0, 5438.0
15	5520	9	1	333	1	5576.0, 5250.0, 5656.0, 5379.0, 5357.0, 5524.0, 5641.0, 5459.0, 5274.0, 5581.0, 5673.0, 5674.0, 5692.0, 5584.0, 5376.0, 5255.0, 5622.0, 5387.0, 5315.0, 5299.0, 5583.0, 5263.0, 5469.0, 5388.0, 5298.0, 5520.0, 5667.0, 5280.0, 5716.0, 5611.0, 5435.0, 5358.0, 5539.0, 5455.0, 5659.0, 5628.0, 5678.0, 5682.0, 5282.0, 5333.0, 5403.0, 5634.0, 5369.0, 5289.0, 5545.0, 5561.0, 5715.0, 5635.0, 5657.0, 5699.0, 5399.0, 5664.0, 5265.0, 5642.0, 5567.0, 5551.0, 5522.0, 5521.0, 5662.0, 5668.0, 5276.0, 5717.0, 5638.0, 5477.0, 5598.0

						5450.0, 5465.0, 5269.0, 5491.0, 5639.0, 5284.0, 5519.0, 5447.0, 5317.0, 5655.0, 5305.0, 5573.0, 5433.0, 5614.0, 5340.0, 5578.0, 5448.0, 5400.0, 5354.0, 5349.0, 5531.0, 5310.0, 5625.0, 5417.0, 5351.0, 5412.0, 5527.0, 5685.0, 5429.0, 5705.0, 5499.0, 5485.0, 5497.0, 5483.0, 5590.0
16	5520	9	1	333	1	5619.0, 5721.0, 5693.0, 5464.0, 5421.0, 5444.0, 5655.0, 5516.0, 5715.0, 5560.0, 5432.0, 5320.0, 5341.0, 5492.0, 5478.0, 5354.0, 5661.0, 5622.0, 5504.0, 5660.0, 5710.0, 5581.0, 5293.0, 5703.0, 5302.0, 5631.0, 5347.0, 5467.0, 5708.0, 5625.0, 5530.0, 5561.0, 5267.0, 5716.0, 5353.0, 5532.0, 5527.0, 5562.0, 5568.0, 5554.0, 5538.0, 5446.0, 5389.0, 5573.0, 5558.0, 5424.0, 5494.0, 5690.0, 5382.0, 5654.0, 5455.0, 5319.0, 5719.0, 5316.0, 5447.0, 5409.0, 5576.0, 5371.0, 5643.0, 5658.0, 5513.0, 5711.0, 5479.0, 5430.0, 5448.0, 5386.0, 5683.0, 5646.0, 5670.0, 5463.0, 5417.0, 5441.0, 5692.0, 5525.0, 5632.0, 5495.0, 5627.0, 5583.0, 5312.0, 5480.0, 5390.0, 5633.0, 5629.0, 5349.0, 5450.0, 5652.0, 5542.0, 5651.0, 5515.0, 5408.0, 5491.0, 5657.0, 5704.0, 5299.0, 5411.0, 5438.0, 5328.0, 5326.0, 5307.0, 5544.0
17	5520	9	1	333	1	5564.0, 5670.0, 5313.0, 5690.0, 5451.0, 5296.0, 5636.0, 5320.0, 5370.0, 5658.0, 5411.0, 5512.0, 5650.0, 5459.0, 5540.0, 5515.0, 5500.0, 5466.0, 5472.0, 5264.0, 5460.0, 5281.0, 5577.0, 5383.0, 5702.0, 5429.0, 5549.0, 5537.0, 5675.0, 5612.0, 5312.0, 5700.0, 5588.0, 5258.0, 5464.0, 5576.0, 5386.0, 5461.0, 5272.0, 5721.0, 5686.0, 5376.0, 5435.0, 5664.0, 5444.0, 5505.0, 5683.0, 5656.0, 5516.0, 5357.0, 5344.0, 5533.0, 5421.0, 5401.0, 5457.0, 5723.0, 5703.0, 5295.0, 5340.0, 5371.0, 5524.0, 5694.0, 5479.0, 5485.0, 5346.0, 5715.0, 5568.0, 5708.0, 5641.0, 5712.0, 5292.0, 5511.0, 5252.0, 5339.0, 5322.0, 5488.0, 5282.0, 5696.0, 5456.0, 5303.0, 5463.0, 5590.0, 5519.0, 5494.0, 5596.0, 5261.0, 5379.0, 5314.0, 5255.0, 5290.0, 5508.0, 5434.0, 5689.0, 5412.0, 5419.0, 5481.0, 5643.0, 5603.0, 5352.0, 5423.0
18	5520	9	1	333	1	5576.0, 5615.0, 5313.0, 5418.0, 5338.0, 5440.0, 5500.0, 5647.0, 5407.0, 5613.0, 5578.0, 5545.0, 5522.0, 5278.0, 5251.0, 5414.0, 5431.0, 5428.0, 5637.0, 5452.0, 5503.0, 5294.0, 5367.0, 5274.0, 5676.0, 5471.0, 5696.0, 5540.0, 5467.0, 5575.0, 5349.0, 5526.0, 5665.0, 5401.0, 5485.0, 5479.0, 5497.0, 5443.0, 5648.0, 5340.0, 5368.0, 5299.0, 5524.0, 5496.0, 5693.0, 5450.0, 5514.0, 5612.0, 5283.0, 5528.0, 5507.0, 5581.0, 5640.0, 5617.0, 5675.0, 5657.0, 5281.0, 5391.0, 5379.0, 5491.0, 5582.0, 5435.0, 5358.0, 5558.0, 5433.0

						5325.0, 5266.0, 5305.0, 5306.0, 5420.0, 5605.0, 5348.0, 5453.0, 5357.0, 5601.0, 5531.0, 5457.0, 5483.0, 5351.0, 5541.0, 5563.0, 5419.0, 5304.0, 5505.0, 5636.0, 5621.0, 5317.0, 5678.0, 5451.0, 5624.0, 5378.0, 5330.0, 5345.0, 5470.0, 5282.0, 5363.0, 5410.0, 5462.0, 5659.0, 5319.0
19	5520	9	1	333	1	5556.0, 5303.0, 5566.0, 5674.0, 5385.0, 5669.0, 5480.0, 5464.0, 5315.0, 5611.0, 5337.0, 5533.0, 5333.0, 5476.0, 5276.0, 5516.0, 5281.0, 5339.0, 5490.0, 5393.0, 5672.0, 5416.0, 5686.0, 5622.0, 5252.0, 5721.0, 5351.0, 5636.0, 5529.0, 5580.0, 5537.0, 5484.0, 5521.0, 5491.0, 5399.0, 5645.0, 5551.0, 5553.0, 5467.0, 5665.0, 5545.0, 5660.0, 5709.0, 5282.0, 5438.0, 5554.0, 5448.0, 5596.0, 5719.0, 5522.0, 5664.0, 5348.0, 5614.0, 5707.0, 5557.0, 5275.0, 5478.0, 5655.0, 5459.0, 5579.0, 5286.0, 5517.0, 5405.0, 5604.0, 5511.0, 5508.0, 5724.0, 5371.0, 5430.0, 5420.0, 5635.0, 5710.0, 5439.0, 5380.0, 5388.0, 5280.0, 5271.0, 5569.0, 5328.0, 5688.0, 5713.0, 5455.0, 5302.0, 5426.0, 5401.0, 5571.0, 5327.0, 5563.0, 5366.0, 5429.0, 5397.0, 5413.0, 5637.0, 5590.0, 5296.0, 5290.0, 5414.0, 5633.0, 5626.0, 5482.0
20	5520	9	1	333	1	5293.0, 5398.0, 5287.0, 5372.0, 5555.0, 5514.0, 5592.0, 5455.0, 5623.0, 5311.0, 5647.0, 5427.0, 5465.0, 5412.0, 5284.0, 5673.0, 5678.0, 5333.0, 5659.0, 5534.0, 5433.0, 5294.0, 5549.0, 5470.0, 5451.0, 5429.0, 5620.0, 5700.0, 5637.0, 5704.0, 5462.0, 5653.0, 5403.0, 5684.0, 5438.0, 5556.0, 5267.0, 5458.0, 5444.0, 5320.0, 5525.0, 5331.0, 5507.0, 5671.0, 5638.0, 5562.0, 5720.0, 5328.0, 5339.0, 5461.0, 5332.0, 5443.0, 5361.0, 5385.0, 5274.0, 5377.0, 5693.0, 5345.0, 5430.0, 5351.0, 5384.0, 5546.0, 5271.0, 5524.0, 5619.0, 5660.0, 5528.0, 5428.0, 5442.0, 5531.0, 5319.0, 5439.0, 5591.0, 5392.0, 5523.0, 5581.0, 5447.0, 5404.0, 5633.0, 5285.0, 5419.0, 5634.0, 5346.0, 5696.0, 5405.0, 5408.0, 5666.0, 5600.0, 5670.0, 5358.0, 5475.0, 5609.0, 5497.0, 5571.0, 5505.0, 5686.0, 5559.0, 5545.0, 5632.0, 5503.0
21	5520	9	1	333	1	5332.0, 5678.0, 5264.0, 5487.0, 5364.0, 5398.0, 5569.0, 5582.0, 5442.0, 5297.0, 5502.0, 5646.0, 5310.0, 5335.0, 5265.0, 5262.0, 5401.0, 5611.0, 5345.0, 5467.0, 5349.0, 5545.0, 5389.0, 5558.0, 5324.0, 5710.0, 5509.0, 5720.0, 5679.0, 5379.0, 5596.0, 5435.0, 5272.0, 5560.0, 5342.0, 5432.0, 5362.0, 5450.0, 5618.0, 5497.0, 5689.0, 5485.0, 5631.0, 5508.0, 5622.0, 5293.0, 5337.0, 5606.0, 5486.0, 5701.0, 5663.0, 5330.0, 5418.0, 5400.0, 5630.0, 5407.0, 5377.0, 5532.0, 5360.0, 5632.0, 5498.0, 5572.0, 5526.0, 5515.0, 5494.0

						5251.0, 5285.0, 5327.0, 5522.0, 5659.0, 5543.0, 5491.0, 5288.0, 5496.0, 5492.0, 5307.0, 5344.0, 5570.0, 5365.0, 5371.0, 5640.0, 5609.0, 5573.0, 5424.0, 5323.0, 5383.0, 5261.0, 5436.0, 5635.0, 5551.0, 5451.0, 5723.0, 5328.0, 5338.0, 5464.0, 5445.0, 5529.0, 5449.0, 5396.0, 5540.0
22	5520	9	1	333	1	5663.0, 5359.0, 5612.0, 5371.0, 5450.0, 5275.0, 5478.0, 5640.0, 5353.0, 5432.0, 5377.0, 5636.0, 5685.0, 5453.0, 5581.0, 5272.0, 5374.0, 5560.0, 5273.0, 5392.0, 5337.0, 5670.0, 5448.0, 5446.0, 5544.0, 5652.0, 5351.0, 5520.0, 5429.0, 5711.0, 5287.0, 5318.0, 5532.0, 5482.0, 5347.0, 5421.0, 5597.0, 5508.0, 5314.0, 5456.0, 5426.0, 5406.0, 5718.0, 5346.0, 5262.0, 5535.0, 5447.0, 5469.0, 5628.0, 5555.0, 5678.0, 5250.0, 5702.0, 5303.0, 5598.0, 5689.0, 5703.0, 5574.0, 5331.0, 5342.0, 5269.0, 5445.0, 5615.0, 5393.0, 5443.0, 5327.0, 5338.0, 5276.0, 5263.0, 5518.0, 5422.0, 5433.0, 5293.0, 5335.0, 5471.0, 5423.0, 5340.0, 5697.0, 5301.0, 5660.0, 5467.0, 5364.0, 5344.0, 5488.0, 5461.0, 5434.0, 5375.0, 5695.0, 5552.0, 5545.0, 5468.0, 5341.0, 5591.0, 5425.0, 5295.0, 5620.0, 5485.0, 5411.0, 5304.0, 5571.0
23	5520	9	1	333	1	5657.0, 5665.0, 5611.0, 5346.0, 5642.0, 5455.0, 5637.0, 5279.0, 5253.0, 5697.0, 5686.0, 5627.0, 5423.0, 5590.0, 5582.0, 5267.0, 5658.0, 5323.0, 5348.0, 5520.0, 5699.0, 5315.0, 5283.0, 5478.0, 5434.0, 5296.0, 5307.0, 5558.0, 5288.0, 5422.0, 5488.0, 5555.0, 5333.0, 5691.0, 5688.0, 5585.0, 5426.0, 5553.0, 5287.0, 5704.0, 5475.0, 5399.0, 5581.0, 5682.0, 5594.0, 5494.0, 5623.0, 5258.0, 5375.0, 5635.0, 5275.0, 5266.0, 5358.0, 5608.0, 5505.0, 5612.0, 5430.0, 5284.0, 5544.0, 5535.0, 5621.0, 5614.0, 5671.0, 5325.0, 5429.0, 5519.0, 5510.0, 5411.0, 5370.0, 5495.0, 5460.0, 5285.0, 5644.0, 5560.0, 5537.0, 5318.0, 5457.0, 5690.0, 5265.0, 5508.0, 5675.0, 5379.0, 5579.0, 5615.0, 5618.0, 5350.0, 5413.0, 5667.0, 5407.0, 5606.0, 5529.0, 5274.0, 5526.0, 5550.0, 5477.0, 5580.0, 5605.0, 5365.0, 5398.0, 5543.0
24	5520	9	1	333	1	5601.0, 5457.0, 5549.0, 5705.0, 5695.0, 5493.0, 5448.0, 5368.0, 5602.0, 5627.0, 5256.0, 5520.0, 5279.0, 5413.0, 5365.0, 5495.0, 5359.0, 5358.0, 5522.0, 5594.0, 5649.0, 5484.0, 5322.0, 5452.0, 5707.0, 5586.0, 5626.0, 5648.0, 5441.0, 5393.0, 5499.0, 5507.0, 5498.0, 5338.0, 5647.0, 5611.0, 5539.0, 5686.0, 5655.0, 5623.0, 5376.0, 5575.0, 5644.0, 5412.0, 5339.0, 5676.0, 5514.0, 5259.0, 5629.0, 5454.0, 5386.0, 5719.0, 5585.0, 5262.0, 5375.0, 5283.0, 5387.0, 5694.0, 5438.0, 5321.0, 5473.0, 5615.0, 5356.0, 5399.0, 5592.0

						5723.0, 5524.0, 5512.0, 5511.0, 5593.0, 5542.0, 5445.0, 5639.0, 5260.0, 5617.0, 5490.0, 5314.0, 5461.0, 5325.0, 5472.0, 5355.0, 5405.0, 5460.0, 5669.0, 5673.0, 5650.0, 5685.0, 5298.0, 5284.0, 5597.0, 5562.0, 5618.0, 5406.0, 5693.0, 5534.0, 5557.0, 5513.0, 5600.0, 5401.0, 5645.0
25	5520	9	1	333	1	5590.0, 5395.0, 5342.0, 5663.0, 5399.0, 5639.0, 5330.0, 5442.0, 5300.0, 5636.0, 5431.0, 5517.0, 5583.0, 5422.0, 5361.0, 5526.0, 5625.0, 5409.0, 5278.0, 5544.0, 5556.0, 5293.0, 5667.0, 5380.0, 5724.0, 5509.0, 5588.0, 5608.0, 5390.0, 5523.0, 5566.0, 5397.0, 5320.0, 5460.0, 5719.0, 5290.0, 5404.0, 5507.0, 5308.0, 5701.0, 5461.0, 5664.0, 5331.0, 5377.0, 5263.0, 5684.0, 5414.0, 5538.0, 5493.0, 5299.0, 5256.0, 5262.0, 5548.0, 5316.0, 5445.0, 5521.0, 5712.0, 5459.0, 5489.0, 5312.0, 5582.0, 5696.0, 5498.0, 5571.0, 5351.0, 5376.0, 5446.0, 5284.0, 5363.0, 5512.0, 5612.0, 5518.0, 5270.0, 5367.0, 5386.0, 5679.0, 5430.0, 5597.0, 5473.0, 5444.0, 5547.0, 5384.0, 5450.0, 5710.0, 5655.0, 5419.0, 5634.0, 5482.0, 5434.0, 5268.0, 5344.0, 5477.0, 5467.0, 5662.0, 5328.0, 5327.0, 5686.0, 5427.0, 5258.0, 5321.0
26	5520	9	1	333	1	5401.0, 5442.0, 5375.0, 5535.0, 5623.0, 5362.0, 5336.0, 5445.0, 5454.0, 5631.0, 5278.0, 5310.0, 5319.0, 5332.0, 5612.0, 5430.0, 5650.0, 5670.0, 5610.0, 5577.0, 5309.0, 5578.0, 5625.0, 5403.0, 5640.0, 5410.0, 5294.0, 5443.0, 5349.0, 5357.0, 5274.0, 5684.0, 5627.0, 5500.0, 5418.0, 5258.0, 5496.0, 5370.0, 5393.0, 5488.0, 5263.0, 5438.0, 5611.0, 5506.0, 5642.0, 5397.0, 5474.0, 5509.0, 5422.0, 5701.0, 5601.0, 5699.0, 5373.0, 5356.0, 5289.0, 5286.0, 5318.0, 5541.0, 5587.0, 5284.0, 5508.0, 5507.0, 5476.0, 5262.0, 5514.0, 5661.0, 5323.0, 5634.0, 5564.0, 5423.0, 5329.0, 5651.0, 5547.0, 5339.0, 5439.0, 5559.0, 5666.0, 5313.0, 5275.0, 5390.0, 5338.0, 5707.0, 5466.0, 5527.0, 5652.0, 5671.0, 5583.0, 5412.0, 5433.0, 5326.0, 5416.0, 5667.0, 5557.0, 5598.0, 5698.0, 5534.0, 5639.0, 5691.0, 5517.0, 5457.0
27	5520	9	1	333	1	5266.0, 5673.0, 5503.0, 5469.0, 5583.0, 5443.0, 5426.0, 5446.0, 5324.0, 5470.0, 5410.0, 5371.0, 5540.0, 5547.0, 5683.0, 5289.0, 5403.0, 5315.0, 5596.0, 5424.0, 5678.0, 5639.0, 5517.0, 5674.0, 5570.0, 5630.0, 5390.0, 5317.0, 5710.0, 5535.0, 5612.0, 5280.0, 5336.0, 5282.0, 5379.0, 5529.0, 5302.0, 5291.0, 5411.0, 5635.0, 5537.0, 5577.0, 5337.0, 5501.0, 5613.0, 5661.0, 5253.0, 5438.0, 5433.0, 5259.0, 5262.0, 5665.0, 5356.0, 5292.0, 5258.0, 5625.0, 5687.0, 5675.0, 5399.0, 5430.0, 5473.0, 5680.0, 5316.0, 5484.0, 5582.0,

						5556.0, 5381.0, 5627.0, 5702.0, 5440.0, 5707.0, 5267.0, 5522.0, 5472.0, 5521.0, 5415.0, 5527.0, 5273.0, 5449.0, 5363.0, 5513.0, 5573.0, 5643.0, 5477.0, 5533.0, 5392.0, 5595.0, 5354.0, 5432.0, 5447.0, 5342.0, 5309.0, 5590.0, 5693.0, 5486.0, 5544.0, 5459.0, 5645.0, 5374.0, 5334.0
28	5520	9	1	333	1	5303.0, 5548.0, 5388.0, 5284.0, 5552.0, 5353.0, 5292.0, 5272.0, 5278.0, 5472.0, 5639.0, 5690.0, 5333.0, 5588.0, 5607.0, 5339.0, 5528.0, 5369.0, 5265.0, 5415.0, 5668.0, 5654.0, 5604.0, 5599.0, 5461.0, 5300.0, 5506.0, 5638.0, 5298.0, 5680.0, 5501.0, 5573.0, 5474.0, 5450.0, 5567.0, 5498.0, 5563.0, 5437.0, 5463.0, 5516.0, 5631.0, 5597.0, 5598.0, 5507.0, 5438.0, 5428.0, 5251.0, 5309.0, 5670.0, 5722.0, 5401.0, 5402.0, 5619.0, 5675.0, 5473.0, 5533.0, 5413.0, 5589.0, 5262.0, 5577.0, 5713.0, 5374.0, 5708.0, 5622.0, 5558.0, 5317.0, 5640.0, 5614.0, 5282.0, 5442.0, 5325.0, 5593.0, 5562.0, 5293.0, 5351.0, 5523.0, 5263.0, 5393.0, 5485.0, 5287.0, 5616.0, 5610.0, 5430.0, 5676.0, 5524.0, 5365.0, 5702.0, 5378.0, 5628.0, 5545.0, 5283.0, 5367.0, 5288.0, 5279.0, 5646.0, 5386.0, 5480.0, 5462.0, 5582.0, 5583.0
29	5520	9	1	333	1	5709.0, 5511.0, 5510.0, 5675.0, 5717.0, 5532.0, 5456.0, 5285.0, 5699.0, 5282.0, 5507.0, 5545.0, 5722.0, 5299.0, 5293.0, 5294.0, 5349.0, 5405.0, 5406.0, 5455.0, 5697.0, 5390.0, 5475.0, 5603.0, 5260.0, 5369.0, 5706.0, 5551.0, 5370.0, 5502.0, 5344.0, 5286.0, 5525.0, 5590.0, 5582.0, 5658.0, 5566.0, 5615.0, 5614.0, 5577.0, 5404.0, 5321.0, 5268.0, 5262.0, 5527.0, 5259.0, 5493.0, 5710.0, 5433.0, 5558.0, 5380.0, 5613.0, 5606.0, 5254.0, 5720.0, 5355.0, 5386.0, 5273.0, 5659.0, 5462.0, 5457.0, 5573.0, 5447.0, 5667.0, 5647.0, 5657.0, 5465.0, 5312.0, 5622.0, 5283.0, 5715.0, 5361.0, 5466.0, 5389.0, 5500.0, 5430.0, 5605.0, 5382.0, 5537.0, 5469.0, 5714.0, 5422.0, 5504.0, 5411.0, 5317.0, 5538.0, 5277.0, 5611.0, 5633.0, 5489.0, 5552.0, 5501.0, 5470.0, 5332.0, 5687.0, 5372.0, 5638.0, 5300.0, 5666.0, 5384.0
30	5520	9	1	333	1	5346.0, 5407.0, 5623.0, 5700.0, 5338.0, 5522.0, 5702.0, 5602.0, 5344.0, 5572.0, 5529.0, 5299.0, 5506.0, 5345.0, 5419.0, 5603.0, 5701.0, 5375.0, 5341.0, 5409.0, 5613.0, 5691.0, 5544.0, 5385.0, 5494.0, 5332.0, 5573.0, 5476.0, 5653.0, 5442.0, 5371.0, 5652.0, 5530.0, 5655.0, 5645.0, 5399.0, 5258.0, 5496.0, 5666.0, 5499.0, 5272.0, 5553.0, 5306.0, 5557.0, 5638.0, 5420.0, 5404.0, 5358.0, 5333.0, 5512.0, 5321.0, 5304.0, 5508.0, 5707.0, 5311.0, 5408.0, 5712.0, 5487.0, 5317.0, 5378.0, 5475.0, 5340.0, 5615.0, 5608.0, 5649.0

						5611.0, 5624.0, 5703.0, 5376.0, 5505.0, 5441.0, 5411.0, 5578.0, 5377.0, 5326.0, 5366.0, 5542.0, 5646.0, 5663.0, 5679.0, 5576.0, 5534.0, 5329.0, 5551.0, 5434.0, 5380.0, 5486.0, 5517.0, 5684.0, 5252.0, 5386.0, 5360.0, 5532.0, 5628.0, 5592.0, 5490.0, 5359.0, 5391.0, 5390.0, 5382.0
--	--	--	--	--	--	--

40MHz

Radar SignalType	Waveform/Trial Number	Detection (%)	Limit (%)	Pass/Fail
Type 1A	15	100%	60%	pass
Type 1B	15	100%	60%	pass
Type 2	30	100 %	60%	Pass
Type 3	30	100 %	60%	Pass
Type 4	30	100 %	60%	Pass
Aggregate (Type1 to 4)	120	100 %	80%	Pass
Type 5	30	100 %	80%	Pass
Type 6	30	100 %	70%	Pass

Please refer to the following statistical tables:

5510MHz**Radar Type 1A Statistical Performance**

Trial #	Fc (MHz)	Pulse/Burst	Pulse Width (μS)	PRI (μs)	Detection (1:yes; 0:no)
1	5510	83	1	638	1
2	5510	89	1	598	1
3	5510	70	1	758	1
4	5510	67	1	798	1
5	5510	99	1	538	1
6	5510	95	1	558	1
7	5510	86	1	618	1
8	5510	92	1	578	1
9	5510	65	1	818	1
10	5510	76	1	698	1
11	5510	74	1	718	1
12	5510	59	1	898	1
13	5510	58	1	918	1
14	5510	61	1	878	1
15	5510	62	1	858	1
Detection Percentage: 100 % (>60%)					

Radar Type 1B Statistical Performance

Trial #	Fc (MHz)	Pulse/Burst	Pulse Width (μS)	PRI (μs)	Detection (1:yes; 0:no)
1	5510	50	1	1057	1
2	5510	23	1	2355	1
3	5510	32	1	1655	1
4	5510	26	1	2058	1
5	5510	65	1	815	1
6	5510	33	1	1618	1
7	5510	25	1	2132	1
8	5510	20	1	2704	1
9	5510	97	1	545	1
10	5510	75	1	712	1
11	5510	23	1	2345	1
12	5510	44	1	1227	1
13	5510	21	1	2589	1
14	5510	49	1	1096	1
15	5510	21	1	2623	1
Detection Percentage: 100 % (>60%)					

Radar Type 2 Statistical Performance

Trial #	Fc (MHz)	Pulse/Burst	Pulse Width (μS)	PRI (μs)	Detection (1:yes; 0:no)
1	5510	26	1.8	174	1
2	5510	28	4.6	211	1
3	5510	27	2.9	200	1
4	5510	28	2.3	189	1
5	5510	25	4.9	183	1
6	5510	26	1.3	215	1
7	5510	27	1.6	169	1
8	5510	26	1.9	192	1
9	5510	27	2.3	172	1
10	5510	26	1.8	215	1
11	5510	29	3.5	188	1
12	5510	26	1.8	225	1
13	5510	26	4.2	225	1
14	5510	23	4.6	230	1
15	5510	24	1.9	156	1
16	5510	29	1	222	1
17	5510	28	4.6	215	1
18	5510	26	2.8	211	1
19	5510	27	4	183	1
20	5510	27	5	202	1
21	5510	26	3.8	220	1
22	5510	23	4.7	211	1
23	5510	23	1	199	1
24	5510	26	4.4	161	1
25	5510	25	3.3	219	1
26	5510	26	3	164	1
27	5510	28	5	170	1
28	5510	27	1.3	150	1
29	5510	26	3.2	154	1
30	5510	25	4.9	211	1
Detection Percentage: 100 % (>60%)					

Radar Type 3 Statistical Performance

Trial #	Fc (MHz)	Pulse/Burst	Pulse Width (μS)	PRI (μs)	Detection (1:yes; 0:no)
1	5510	16	9.3	407	1
2	5510	16	9.2	273	1
3	5510	17	8.5	279	1
4	5510	17	9.4	227	1
5	5510	16	8.8	482	1
6	5510	18	7.7	333	1
7	5510	18	7.4	470	1
8	5510	17	7	416	1
9	5510	16	9.1	449	1
10	5510	17	8.2	268	1
11	5510	16	6.4	474	1
12	5510	16	9.6	204	1
13	5510	18	6.3	309	1
14	5510	17	6.9	334	1
15	5510	18	8	424	1
16	5510	17	6.1	330	1
17	5510	16	7.4	387	1
18	5510	16	9.5	418	1
19	5510	18	8	374	1
20	5510	16	7.5	459	1
21	5510	18	8.2	449	1
22	5510	18	7.2	491	1
23	5510	17	8.9	240	1
24	5510	16	6.1	364	1
25	5510	17	6.4	470	1
26	5510	16	6.6	436	1
27	5510	16	9.3	381	1
28	5510	16	6.7	276	1
29	5510	16	7.5	438	1
30	5510	18	7.5	407	1
Detection Percentage: 100 % (>60%)					

Radar Type 4 Statistical Performance

Trial #	Fc (MHz)	Pulse/Burst	Pulse Width (μS)	PRI (μs)	Detection (1:yes; 0:no)
1	5510	14	17.9	367	1
2	5510	12	12.2	371	1
3	5510	15	15.5	418	1
4	5510	13	15.1	477	1
5	5510	14	11.6	245	1
6	5510	16	18.8	251	1
7	5510	14	17.1	244	1
8	5510	15	16.8	339	1
9	5510	15	15	466	1
10	5510	14	17.9	315	1
11	5510	12	18.7	472	1
12	5510	14	11.6	469	1
13	5510	16	19.1	392	1
14	5510	14	18.1	280	1
15	5510	14	17.9	382	1
16	5510	12	19.5	256	1
17	5510	12	13.4	201	1
18	5510	16	11.4	409	1
19	5510	15	16.3	484	1
20	5510	15	15.2	203	1
21	5510	13	16.2	452	1
22	5510	14	16.2	263	1
23	5510	16	16.3	280	1
24	5510	15	14.1	353	1
25	5510	14	13.6	467	1
26	5510	16	12.9	379	1
27	5510	16	15.7	420	1
28	5510	12	11.7	234	1
29	5510	13	18.6	352	1
30	5510	13	18.6	453	1
Detection Percentage: 100 % (>60%)					

Radar Type 5 Case 1 Statistical Performance

Statistics 1 (ChirpCenter Frequency: 5510.0MHz)

Trial #	Pulse	Chirp(MHz)	Pulse Width (μS)	Pulse 1-2 spacing(μS)	Pulse 2-3 spacing(μS)	Pulse Start(S)	Detection (1:yes;0:no)
0	2	14	87.5	1242		0.047220	1
1	2	14	74.4	1949		0.914963	
2	3	14	57.9	1839	1307	2.352883	
3	3	14	92.4	1139	1742	2.943321	
4	3	14	94.1	1297	1071	4.182768	
5	1	14	66.7			4.318834	
6	2	14	96.5	1957		5.909739	
7	3	14	79.3	1982	1602	6.411971	
8	2	14	66.1	1047		7.446129	
9	1	14	80.8			8.459637	
10	1	14	51.7			8.711340	
11	1	14	75.4			9.780795	
12	2	14	86.8	1546		10.303480	
13	2	14	95.8	1700		11.504770	

Statistics 2 (ChirpCenter Frequency: 5510.0 MHz)

Trial #	Pulse	Chirp(MHz)	Pulse Width (μS)	Pulse 1-2 spacing(μS)	Pulse 2-3 spacing(μS)	Pulse Start(S)	Detection (1:yes;0:no)
0	1	7	61.5			0.399883	1
1	2	7	63.4	1733		1.258823	
2	3	7	61	1813	1533	1.734493	
3	2	7	62.4	1249		2.292884	
4	2	7	74.6	1596		2.955427	
5	3	7	75.1	1526	1520	3.765446	
6	3	7	72.6	1180	1625	4.903159	
7	3	7	56.3	1409	1131	5.070947	
8	1	7	96.7			6.159854	
9	2	7	58.7	1937		6.895676	
10	3	7	50.4	1164	1319	7.210970	
11	2	7	86.7	1694		8.265039	
12	1	7	61.9			8.615612	
13	1	7	87.8			9.369081	
14	2	7	70.9	1829		9.994464	
15	2	7	51.4	1145		10.752049	
16	2	7	94.3	1392		11.870870	

Statistics 3 (ChirpCenter Frequency: 5510.0 MHz)

Trial #	Pulse	Chirp(MHz)	Pulse Width (μS)	Pulse 1-2 spacing(μS)	Pulse 2-3 spacing(μS)	Pulse Start(S)	Detection (1:yes;0:no)
0	2	16	82.6	1597		0.279802	1
1	2	16	85.5	1331		1.894794	
2	3	16	92.2	1954	1044	2.762961	
3	2	16	86.2	1434		3.547935	
4	1	16	56.4			5.413963	
5	3	16	62.8	1571	1951	6.018124	
6	2	16	93.5	1416		7.253998	
7	3	16	88.6	1435	1940	8.597433	
8	2	16	82.5	1773		9.567237	
9	2	16	87.3	1550		9.903950	
10	2	16	87.2	1801		11.512430	

Statistics 4 (ChirpCenter Frequency: 5510.0 MHz)

Trial #	Pulse	Chirp(MHz)	Pulse Width (μS)	Pulse 1-2 spacing(μS)	Pulse 2-3 spacing(μS)	Pulse Start(S)	Detection (1:yes;0:no)
0	3	10	80.5	1024	1447	0.702369	1
1	1	10	85.8			1.740764	
2	2	10	65.8	1512		2.686921	
3	3	10	72.5	1315	1543	3.104572	
4	2	10	52.1	1933		3.880832	
5	2	10	67.5	1320		5.456266	
6	1	10	76.6			6.418260	
7	1	10	61.2			6.679619	
8	3	10	74.4	1139	1887	7.523452	
9	1	10	82			9.000163	
10	3	10	66.3	1136	1605	10.138362	
11	1	10	51.6			10.882175	
12	2	10	82.6	1002		11.726366	

Statistics 5(ChirpCenter Frequency: 5510.0 MHz)

Trial #	Pulse	Chirp(MHz)	Pulse Width (μS)	Pulse 1-2 spacing(μS)	Pulse 2-3 spacing(μS)	Pulse Start(S)	Detection (1:yes;0:no)
0	2	10	69.4	1392		0.761905	1
1	2	10	89.8	1564		1.048260	
2	1	10	54.1			2.572974	
3	1	10	51.1			3.165704	
4	2	10	74.8	1818		3.793339	
5	2	10	98.9	1903		4.841111	
6	3	10	77.4	1215	1816	6.081917	
7	1	10	83.6			6.483747	
8	2	10	73.2	1375		8.055549	
9	3	10	62.7	1869	1234	9.195164	
10	2	10	50.2	1339		9.340751	
11	2	10	70.3	1061		10.170052	
12	1	10	91.9			11.623464	

Statistics 6 (ChirpCenter Frequency: 5510.0 MHz)

Trial #	Pulse	Chirp(MHz)	Pulse Width (μS)	Pulse 1-2 spacing(μS)	Pulse 2-3 spacing(μS)	Pulse Start(S)	Detection (1:yes;0:no)
0	2	11	88.4	1869		0.047420	1
1	3	11	55.2	1242	1943	1.283343	
2	3	11	97.8	1921	1452	3.150592	
3	3	11	72.2	1705	1863	4.210936	
4	2	11	69.3	1399		5.892641	
5	2	11	60.5	1349		7.041711	
6	3	11	88.1	1742	1535	8.011398	
7	2	11	88.7	1207		8.959229	
8	2	11	85.8	1557		10.484533	
9	2	11	51.6	1845		11.091892	

Statistics 7(ChirpCenter Frequency: 5510.0 MHz)

Trial #	Pulse	Chirp(MHz)	Pulse Width (μS)	Pulse 1-2 spacing(μS)	Pulse 2-3 spacing(μS)	Pulse Start(S)	Detection (1:yes;0:no)
0	3	12	71.1	1980	1400	0.187923	1
1	1	12	79.4			0.985948	
2	1	12	57.3			1.516653	
3	1	12	91.8			2.228121	
4	2	12	82.3	1666		2.984809	
5	2	12	95.5	1779		3.925014	
6	2	12	77.5	1422		4.489686	
7	2	12	72.6	1069		4.868439	
8	3	12	79.7	1602	1528	5.910998	
9	2	12	74.7	1468		6.376134	
10	2	12	89.3	1705		7.325775	
11	3	12	91.8	1704	1492	7.529675	
12	1	12	58.8			8.464832	
13	3	12	84.6	1418	1633	9.159840	
14	2	12	65.1	1865		9.427614	
15	2	12	77.4	1827		10.312519	
16	1	12	89.8			11.101246	
17	2	12	64.4	1021		11.816267	

Statistics 8 (ChirpCenter Frequency: 5510.0 MHz)

Trial #	Pulse	Chirp(MHz)	Pulse Width (μS)	Pulse 1-2 spacing(μS)	Pulse 2-3 spacing(μS)	Pulse Start(S)	Detection (1:yes;0:no)
0	3	5	58.2	1706	1405	0.463580	1
1	2	5	52.2	1427		0.797212	
2	2	5	65.9	1159		1.290968	
3	3	5	81.4	1888	1440	2.385376	
4	3	5	70.9	1300	1741	3.101134	
5	2	5	55.5	1075		3.435172	
6	2	5	92.7	1894		4.198652	
7	1	5	55.8			4.594210	
8	2	5	70	1810		5.410512	
9	1	5	50.7			5.970853	
10	2	5	89.5	1850		6.917036	
11	2	5	81.9	1732		7.281621	
12	3	5	59.5	1850	1126	8.069928	
13	2	5	65.4	1518		8.504481	
14	2	5	73.8	1884		9.234192	
15	3	5	50.9	1667	1771	9.756742	
16	1	5	81.4			10.196413	
17	3	5	95.5	1452	1959	11.203399	
18	2	5	54.8	1982		11.440729	

Statistics 9 (ChirpCenter Frequency: 5510.0 MHz)

Trial #	Pulse	Chirp(MHz)	Pulse Width (μS)	Pulse 1-2 spacing(μS)	Pulse 2-3 spacing(μS)	Pulse Start(S)	Detection (1:yes;0:no)
0	2	6	64.5	1337		0.257425	1
1	2	6	81.9	1678		2.910568	
2	3	6	88.7	1795	1740	3.560442	
3	2	6	86.8	1870		5.264289	
4	1	6	70.4			6.004841	
5	1	6	97.9			7.511940	
6	3	6	95.6	1188	1327	9.522626	
7	3	6	76.5	1525	1505	11.448618	

Statistics 10 (ChirpCenter Frequency: 5510.0 MHz)

Trial #	Pulse	Chirp(MHz)	Pulse Width (μS)	Pulse 1-2 spacing(μS)	Pulse 2-3 spacing(μS)	Pulse Start(S)	Detection (1:yes;0:no)
0	1	12	95.2			0.157191	1
1	2	12	93.5	1420		1.652574	
2	2	12	90.2	1385		1.895878	
3	3	12	71	1623	1590	3.166997	
4	2	12	93.8	1720		3.960887	
5	2	12	61.6	1366		4.546246	
6	1	12	74.8			5.176199	
7	3	12	91.6	1963	1979	6.697383	
8	1	12	57.7			7.702318	
9	1	12	82.2			7.905973	
10	2	12	94.7	1305		8.973924	
11	2	12	75.3	1010		9.751682	
12	2	12	80.1	1758		10.678056	
13	2	12	82.4	1479		11.846284	

Radar Type 5 Case 2 Statistical Performance

Statistics 1 (ChirpCenter Frequency: 5495.0MHz)

Trial #	Pulse	Chirp(MHz)	Pulse Width (μS)	Pulse 1-2 spacing(μS)	Pulse 2-3 spacing(μS)	Pulse Start(S)	Detection (1:yes;0:no)
0	3	13	56.8	1690	1581	0.134663	1
1	2	13	82	1561		1.256444	
2	1	13	99.5			1.634299	
3	3	13	67.3	1213	1200	2.454570	
4	3	13	51.7	1622	1716	3.199805	
5	1	13	76.6			3.629474	
6	2	13	80.4	1481		4.871826	
7	2	13	96.4	1123		5.469735	
8	1	13	54.8			5.835526	
9	3	13	99.2	1650	1506	6.902434	
10	3	13	81.4	1731	1819	7.153222	
11	2	13	93.9	1952		7.999958	
12	2	13	75	1152		8.740785	
13	2	13	53.2	1358		9.359243	
14	2	13	88.7	1331		10.188045	
15	3	13	67.1	1176	1469	10.713451	
16	2	13	94.4	1027		11.779063	

Statistics 2 (ChirpCenter Frequency: 5494.0 MHz)

Trial #	Pulse	Chirp(MHz)	Pulse Width (μS)	Pulse 1-2 spacing(μS)	Pulse 2-3 spacing(μS)	Pulse Start(S)	Detection (1:yes;0:no)
0	1	11	71.7			0.242157	1
1	2	11	64.6	1994		2.142175	
2	2	11	80.9	1250		3.497386	
3	2	11	94	1666		4.790503	
4	2	11	75.5	1533		5.468040	
5	2	11	77.9	1357		6.253888	
6	2	11	79.5	1352		8.361500	
7	2	11	96.1	1558		9.223891	
8	2	11	95.1	1975		10.236307	
9	3	11	59.9	1473	1379	11.545186	

Statistics 3 (ChirpCenter Frequency: 5494.0 MHz)

Trial #	Pulse	Chirp(MHz)	Pulse Width (μS)	Pulse 1-2 spacing(μS)	Pulse 2-3 spacing(μS)	Pulse Start(S)	Detection (1:yes;0:no)
0	2	9	59.3	1380		0.404269	1
1	3	9	90.5	1296	1540	0.923759	
2	1	9	50.8			1.538682	
3	2	9	60.8	1511		2.699502	
4	2	9	85.4	1701		3.065231	
5	1	9	75			4.368894	
6	1	9	91			4.814366	
7	1	9	73.4			5.460493	
8	2	9	98.8	1867		6.599391	
9	2	9	69.5	1614		7.470132	
10	3	9	69.8	1354	1310	7.690262	
11	2	9	97	1207		8.676174	
12	3	9	95.9	1926	1418	9.368678	
13	1	9	89.8			10.163367	
14	2	9	60.1	1358		10.958723	
15	2	9	70.1	1179		11.995219	

Statistics 4 (ChirpCenter Frequency: 5496.0 MHz)

Trial #	Pulse	Chirp(MHz)	Pulse Width (μS)	Pulse 1-2 spacing(μS)	Pulse 2-3 spacing(μS)	Pulse Start(S)	Detection (1:yes;0:no)
0	3	16	90.4	1036	1835	0.028437	1
1	2	16	56.8	1144		1.097733	
2	2	16	83.1	1846		1.731662	
3	2	16	84.6	1757		2.205965	
4	2	16	71.7	1967		3.196059	
5	2	16	67	1353		3.881873	
6	1	16	57.6			4.546757	
7	2	16	55.4	1115		5.133694	
8	1	16	78.7			5.816695	
9	1	16	59.6			6.470398	
10	3	16	84.9	1130	1038	7.128408	
11	3	16	58.8	1558	1480	7.501935	
12	2	16	81.3	1688		8.461967	
13	2	16	92.2	1388		9.220595	
14	2	16	83.3	1954		9.976516	
15	2	16	100	1428		10.328955	
16	3	16	70.6	1833	1597	11.159207	
17	1	16	83.3			11.935033	

Statistics 5(ChirpCenter Frequency: 5498.0 MHz)

Trial #	Pulse	Chirp(MHz)	Pulse Width (μS)	Pulse 1-2 spacing(μS)	Pulse 2-3 spacing(μS)	Pulse Start(S)	Detection (1:yes;0:no)
0	3	19	86.3	1387	1799	0.678459	1
1	1	19	83			0.804334	
2	2	19	74.5	1363		2.330181	
3	3	19	53.1	1910	1883	2.549972	
4	3	19	64.6	1257	1065	3.340041	
5	1	19	79.3			4.576837	
6	2	19	52.3	1560		5.233350	
7	2	19	82	1485		5.899843	
8	3	19	61.2	1387	1645	6.822707	
9	3	19	90.1	1712	1148	7.902090	
10	3	19	69.5	1162	1064	8.103761	
11	3	19	88.3	1517	1741	8.923436	
12	3	19	74	1398	1012	10.281779	
13	3	19	85.5	1548	1516	10.824278	
14	2	19	59.4	1061		11.592090	

Statistics 6 (ChirpCenter Frequency: 5498.0 MHz)

Trial #	Pulse	Chirp(MHz)	Pulse Width (μS)	Pulse 1-2 spacing(μS)	Pulse 2-3 spacing(μS)	Pulse Start(S)	Detection (1:yes;0:no)
0	2	20	62.6	1998		0.719999	1
1	2	20	54.4	1774		0.927657	
2	1	20	78.3			2.244443	
3	3	20	85.8	1893	1276	3.207189	
4	2	20	79	1620		4.085945	
5	1	20	96.1			4.411460	
6	1	20	88.1			5.714609	
7	1	20	91.1			6.841243	
8	2	20	73.3	1354		7.324630	
9	1	20	76.8			8.103509	
10	2	20	99.9	1827		9.174759	
11	2	20	90.6	1931		9.941650	
12	2	20	66.8	1721		10.559835	
13	3	20	95.5	1604	1727	11.146678	

Statistics 7(ChirpCenter Frequency: 5496.0 MHz)

Trial #	Pulse	Chirp(MHz)	Pulse Width (μS)	Pulse 1-2 spacing(μS)	Pulse 2-3 spacing(μS)	Pulse Start(S)	Detection (1:yes;0:no)
0	1	14	77.6			0.452733	1
1	2	14	54.3	1041		1.094089	
2	2	14	64.1	1648		1.736181	
3	3	14	87.1	1782	1599	2.401289	
4	2	14	64.5	1335		3.20157	
5	2	14	58.1	1340		3.376904	
6	2	14	86.3	1882		4.493951	
7	1	14	68.1			5.100795	
8	1	14	81.4			5.497356	
9	2	14	65.2	1290		6.070636	
10	2	14	65	1220		7.269008	
11	3	14	97.3	1699	1132	7.885952	
12	2	14	84.7	1018		8.322198	
13	2	14	74.1	1579		9.139064	
14	3	14	76.1	1626	1344	9.742837	
15	1	14	85			10.54965	
16	1	14	92.3			10.85422	
17	2	14	62.2	1189		11.91156	

Statistics 8 (ChirpCenter Frequency: 5493.0 MHz)

Trial #	Pulse	Chirp(MHz)	Pulse Width (μS)	Pulse 1-2 spacing(μS)	Pulse 2-3 spacing(μS)	Pulse Start(S)	Detection (1:yes;0:no)
0	3	8	59.3	1792	1112	0.610278	1
1	2	8	56	1353		1.077003	
2	1	8	69.7			2.549054	
3	3	8	65.1	1573	1047	3.007839	
4	3	8	73.7	1231	1310	4.454463	
5	2	8	92.7	1765		4.960814	
6	2	8	73.5	1444		5.617253	
7	2	8	61.5	1309		6.766278	
8	3	8	88.8	1813	1605	7.951182	
9	1	8	86.7			9.226903	
10	2	8	58.4	1462		9.479521	
11	3	8	79.4	1814	1793	10.44792	
12	1	8	62.3			11.92152	

Statistics 9 (ChirpCenter Frequency: 5496.0 MHz)

Trial #	Pulse	Chirp(MHz)	Pulse Width (μS)	Pulse 1-2 spacing(μS)	Pulse 2-3 spacing(μS)	Pulse Start(S)	Detection (1:yes;0:no)
1	3	14	64.3	1379	1346	0.136348	1
2	2	14	59.2	1420		1.488286	
3	3	14	95.1	1362	1608	2.564754	
4	3	14	52.8	1359	1644	3.143236	
5	1	14	95.6			4.484671	
6	1	14	57.9			5.992010	
7	2	14	61.2	1938		6.169031	
8	2	14	86.4	1795		7.033694	
9	1	14	96.2			8.995497	
10	2	14	78.2	1401		9.529385	
11	3	14	58.1	1717	1461	10.306579	

Statistics 10 (ChirpCenter Frequency: 5498.0 MHz)

Trial #	Pulse	Chirp(MHz)	Pulse Width (μS)	Pulse 1-2 spacing(μS)	Pulse 2-3 spacing(μS)	Pulse Start(S)	Detection (1:yes;0:no)
0	2	19	62	1105		0.383800	1
1	2	19	84.1	1589		1.574620	
2	1	19	87.8			1.763655	
3	3	19	53.9	1432	1734	3.242520	
4	1	19	53.7			3.447706	
5	2	19	58.4	1954		5.106898	
6	2	19	53.1	1528		5.830961	
7	3	19	75.9	1385	1831	6.479554	
8	2	19	57	1925		7.554074	
9	2	19	86.4	1292		8.536613	
10	1	19	68.4			8.666971	
11	2	19	83	1312		9.809532	
12	2	19	71.3	1668		10.748097	
13	1	19	97.1			11.958020	

Radar Type 5 Case 3 Statistical Performance

Statistics 1 (ChirpCenter Frequency: 5526.0MHz)

Trial #	Pulse	Chirp(MHz)	Pulse Width (μS)	Pulse 1-2 spacing(μS)	Pulse 2-3 spacing(μS)	Pulse Start(S)	Detection (1:yes;0:no)
0	3	11	79.1	1590	1232	0.325159	1
1	3	11	59.1	1778	1571	0.667607	
2	2	11	61.9	1467		1.530328	
3	2	11	51.3	1865		2.347415	
4	3	11	88.3	1344	1005	2.922011	
5	2	11	50.9	1337		3.220825	
6	2	11	53.3	1918		3.658049	
7	1	11	73.3			4.228032	
8	2	11	76	1400		5.250232	
9	2	11	90.3	1470		5.640123	
10	2	11	85.3	1235		6.485987	
11	3	11	60.2	1749	1892	6.839438	
12	2	11	85.7	1929		7.418457	
13	1	11	86.7			8.171258	
14	2	11	95.6	1665		8.669296	
15	2	11	86.1	1459		9.590787	
16	1	11	75.8			10.173059	
17	2	11	50.9	1680		10.732852	
18	2	11	74.1	1541		11.072787	
19	2	11	86	1721		11.562240	

Statistics 2 (ChirpCenter Frequency: 5522.0 MHz)

Trial #	Pulse	Chirp(MHz)	Pulse Width (μS)	Pulse 1-2 spacing(μS)	Pulse 2-3 spacing(μS)	Pulse Start(S)	Detection (1:yes;0:no)
0	3	19	86.5	1453	1930	0.025798	1
1	2	19	52.6	1807		1.836905	
2	3	19	54	1860	1146	2.828635	
3	1	19	98.7			3.877203	
4	1	19	58.8			4.819515	
5	1	19	90.2			5.664805	
6	3	19	77.8	1361	1150	6.334431	
7	3	19	85.2	1250	1120	7.921842	
8	2	19	69.8	1421		8.644033	
9	2	19	85.7	1433		9.182577	
10	1	19	73			10.065337	
11	1	19	54.7			11.829721	

Statistics 3 (ChirpCenter Frequency: 5525.0 MHz)

Trial #	Pulse	Chirp(MHz)	Pulse Width (μS)	Pulse 1-2 spacing(μS)	Pulse 2-3 spacing(μS)	Pulse Start(S)	Detection (1:yes;0:no)
0	2	12	96.1	1711		1.247022	1
1	2	12	53.3	1087		2.658585	
2	2	12	94.6	1269		3.764360	
3	1	12	77			4.841991	
4	2	12	50.2	1758		6.032065	
5	2	12	66.8	1007		8.269269	
6	1	12	64			10.395733	
7	2	12	97	1817		11.242601	

Statistics 4 (ChirpCenter Frequency: 5524.0 MHz)

Trial #	Pulse	Chirp(MHz)	Pulse Width (μS)	Pulse 1-2 spacing(μS)	Pulse 2-3 spacing(μS)	Pulse Start(S)	Detection (1:yes;0:no)
0	1	16	71.5			0.315241	1
1	1	16	51.2			1.117807	
2	2	16	83.6	1212		1.951428	
3	2	16	53	1464		2.792023	
4	3	16	54.3	1012	1752	3.112158	
5	2	16	76.2	1520		3.856651	
6	3	16	63.6	1326	1052	4.552781	
7	2	16	69.8	1360		5.085194	
8	1	16	97.5			5.659950	
9	2	16	75.7	1513		6.758507	
10	2	16	78	1059		7.161090	
11	3	16	87.7	1467	1484	8.174528	
12	2	16	68.9	1143		8.662896	
13	2	16	51.5	1456		9.320160	
14	2	16	93.1	1705		10.582233	
15	1	16	67.7			11.172893	
16	2	16	87.8	1824		11.861152	

Statistics 5(ChirpCenter Frequency: 5523.0 MHz)

Trial #	Pulse	Chirp(MHz)	Pulse Width (μS)	Pulse 1-2 spacing(μS)	Pulse 2-3 spacing(μS)	Pulse Start(S)	Detection (1:yes;0:no)
0	2	18	82.9	1064		0.104177	1
1	1	18	79.4			0.937297	
2	3	18	77.2	1096	1890	2.101743	
3	2	18	68.5	1566		2.897804	
4	2	18	58.1	1995		3.292989	
5	3	18	55.3	1831	1154	4.287869	
6	2	18	78.1	1812		4.896300	
7	1	18	83.9			6.032785	
8	2	18	93.4	1497		7.123728	
9	3	18	62.5	1633	1324	7.633382	
10	3	18	65	1377	1476	8.687453	
11	3	18	72.1	1534	1904	9.147274	
12	2	18	96.4	1993		10.130528	
13	2	18	58.9	1616		10.500971	
14	1	18	83.3			11.948700	

Statistics 6 (ChirpCenter Frequency: 5522.0 MHz)

Trial #	Pulse	Chirp(MHz)	Pulse Width (μS)	Pulse 1-2 spacing(μS)	Pulse 2-3 spacing(μS)	Pulse Start(S)	Detection (1:yes;0:no)
0	2	19	64.9	1601		0.156728	1
1	3	19	54.5	1461	1660	1.209941	
2	2	19	83	1543		1.845161	
3	3	19	85.5	1643	1067	2.289988	
4	1	19	83.2			3.233771	
5	1	19	71.4			3.796830	
6	1	19	66			4.978178	
7	2	19	52.9	1688		5.570793	
8	3	19	73.1	1573	1991	6.376452	
9	1	19	94.6			6.976030	
10	3	19	96.8	1934	1632	7.661041	
11	3	19	58.5	1756	1250	8.431874	
12	2	19	95.7	1941		9.600883	
13	2	19	80.8	1780		10.453490	
14	2	19	90.1	1335		11.115197	
15	3	19	87.1	1520	1101	11.354227	

Statistics 7(ChirpCenter Frequency: 5522.0 MHz)

Trial #	Pulse	Chirp(MHz)	Pulse Width (μS)	Pulse 1-2 spacing(μS)	Pulse 2-3 spacing(μS)	Pulse Start(S)	Detection (1:yes;0:no)
0	1	19	75.6			0.734735	1
1	1	19	75			1.099131	
2	3	19	55	1844	1736	2.186336	
3	3	19	88.8	1799	1481	2.697809	
4	2	19	64.6	1122		4.116711	
5	2	19	97.5	1045		4.446334	
6	2	19	79	1543		5.554882	
7	2	19	57.2	1496		6.208826	
8	1	19	72.9			7.570025	
9	2	19	55.4	1248		7.940014	
10	2	19	98.6	1482		9.049689	
11	3	19	85.4	1904	1348	10.162919	
12	3	19	54.9	1656	1478	10.861409	
13	2	19	88.4	1823		11.616614	

Statistics 8 (ChirpCenter Frequency: 5525.0 MHz)

Trial #	Pulse	Chirp(MHz)	Pulse Width (μS)	Pulse 1-2 spacing(μS)	Pulse 2-3 spacing(μS)	Pulse Start(S)	Detection (1:yes;0:no)
0	2	12	56.6	1125		1.147018	1
1	3	12	65.6	1519	1309	1.990776	
2	3	12	63.7	1291	1298	2.622105	
3	1	12	59.1			4.706395	
4	3	12	56.8	1489	1294	5.879313	
5	1	12	78.1			6.109600	
6	2	12	84.4	1138		8.093530	
7	3	12	56.9	1277	1941	9.178384	
8	2	12	71.3	1172		10.614071	
9	1	12	96.4			10.836053	

Statistics 9 (ChirpCenter Frequency: 5524.0 MHz)

Trial #	Pulse	Chirp(MHz)	Pulse Width (μS)	Pulse 1-2 spacing(μS)	Pulse 2-3 spacing(μS)	Pulse Start(S)	Detection (1:yes;0:no)
0	3	15	74.1	1625	1052	0.669272	1
1	3	15	82.5	1237	1717	0.903884	
2	2	15	77.5	1476		1.714154	
3	3	15	97	1179	1156	2.487946	
4	2	15	55.1	1096		2.950849	
5	2	15	94.6	1002		3.979276	
6	2	15	69.2	1771		4.471023	
7	2	15	60.5	1566		5.406105	
8	2	15	87.1	1580		6.237258	
9	3	15	95	1528	1122	7.018875	
10	2	15	92.3	1945		7.326258	
11	1	15	77.2			7.863715	
12	2	15	73.2	1247		9.064610	
13	3	15	81	1815	1856	9.733966	
14	3	15	83.8	1942	1542	10.209443	
15	3	15	50.5	1969	1395	10.966667	
16	2	15	57.9	1132		11.579948	

Statistics 10 (ChirpCenter Frequency: 5524.0 MHz)

Trial #	Pulse	Chirp(MHz)	Pulse Width (μS)	Pulse 1-2 spacing(μS)	Pulse 2-3 spacing(μS)	Pulse Start(S)	Detection (1:yes;0:no)
0	3	10	94.7	1948	1391	0.018502	1
1	2	10	96.5	1988		1.287628	
2	2	10	85.8	1384		1.974969	
3	3	10	51.6	1483	1876	2.619578	
4	1	10	61.8			3.026279	
5	1	10	56.9			3.650436	
6	2	10	77.5	1349		4.288575	
7	3	10	67.8	1593	1932	5.283176	
8	1	10	66.5			5.543001	
9	2	10	74.5	1774		6.587910	
10	2	10	65.4	1159		6.836011	
11	2	10	61.9	1388		7.962549	
12	2	10	58.3	1198		8.391357	
13	3	10	73.9	1698	1019	9.153813	
14	2	10	89.3	1197		9.345612	
15	3	10	58.9	1894	1346	10.340248	
16	2	10	62.5	1918		11.222325	
17	1	10	62.3			11.374140	

Radar Type 6 Statistical Performance

Trial #	Fc (MHz)	Pulse /Burst	Pulse Width (µS)	PRI (µs)	Detection (1:yes; 0:no)	Hopping Sequence (MHz)
1	5510	9	1	333	1	5303.0, 5481.0, 5319.0, 5471.0, 5599.0, 5567.0, 5470.0, 5625.0, 5373.0, 5549.0, 5351.0, 5259.0, 5541.0, 5539.0, 5384.0, 5720.0, 5628.0, 5423.0, 5479.0, 5504.0, 5577.0, 5644.0, 5610.0, 5310.0, 5476.0, 5467.0, 5260.0, 5276.0, 5346.0, 5586.0, 5484.0, 5424.0, 5278.0, 5525.0, 5531.0, 5676.0, 5431.0, 5684.0, 5657.0, 5320.0, 5673.0, 5366.0, 5663.0, 5696.0, 5472.0, 5682.0, 5313.0, 5613.0, 5289.0, 5269.0, 5540.0, 5414.0, 5534.0, 5724.0, 5377.0, 5433.0, 5457.0, 5547.0, 5672.0, 5258.0, 5670.0, 5263.0, 5325.0, 5635.0, 5419.0, 5425.0, 5533.0, 5352.0, 5324.0, 5564.0, 5713.0, 5652.0, 5443.0, 5461.0, 5608.0, 5694.0, 5565.0, 5446.0, 5580.0, 5618.0, 5357.0, 5570.0, 5576.0, 5634.0, 5705.0, 5426.0, 5588.0, 5511.0, 5643.0, 5323.0, 5506.0, 5631.0, 5499.0, 5641.0, 5410.0, 5646.0, 5436.0, 5465.0, 5412.0, 5312.0
2	5510	9	1	333	1	5680.0, 5580.0, 5686.0, 5582.0, 5722.0, 5324.0, 5460.0, 5380.0, 5328.0, 5719.0, 5297.0, 5286.0, 5439.0, 5420.0, 5549.0, 5494.0, 5487.0, 5718.0, 5513.0, 5720.0, 5646.0, 5649.0, 5367.0, 5348.0, 5587.0, 5425.0, 5708.0, 5251.0, 5497.0, 5577.0, 5374.0, 5276.0, 5518.0, 5331.0, 5505.0, 5263.0, 5495.0, 5550.0, 5289.0, 5669.0, 5257.0, 5473.0, 5565.0, 5560.0, 5339.0, 5626.0, 5613.0, 5287.0, 5507.0, 5443.0, 5446.0, 5370.0, 5714.0, 5559.0, 5602.0, 5338.0, 5294.0, 5400.0, 5657.0, 5556.0, 5332.0, 5461.0, 5623.0, 5555.0, 5271.0, 5315.0, 5475.0, 5387.0, 5598.0, 5619.0, 5309.0, 5627.0, 5608.0, 5574.0, 5691.0, 5336.0, 5658.0, 5591.0, 5707.0, 5405.0, 5334.0, 5694.0, 5502.0, 5589.0, 5462.0, 5454.0, 5585.0, 5611.0, 5293.0, 5677.0, 5688.0, 5291.0, 5378.0, 5511.0, 5396.0, 5480.0, 5678.0, 5440.0, 5668.0, 5452.0
3	5510	9	1	333	1	5334.0, 5274.0, 5298.0, 5622.0, 5409.0, 5411.0, 5702.0, 5640.0, 5631.0, 5397.0, 5624.0, 5439.0, 5255.0, 5399.0, 5589.0, 5557.0, 5653.0, 5459.0, 5337.0, 5642.0, 5535.0, 5587.0, 5424.0, 5304.0, 5421.0, 5478.0, 5712.0, 5330.0, 5521.0, 5606.0, 5524.0, 5605.0, 5433.0, 5462.0, 5569.0, 5279.0, 5636.0, 5265.0, 5558.0, 5466.0, 5426.0, 5420.0, 5306.0, 5328.0, 5431.0, 5389.0, 5574.0, 5250.0, 5403.0, 5336.0, 5571.0, 5324.0, 5329.0, 5660.0, 5294.0, 5266.0, 5428.0, 5270.0, 5621.0, 5479.0, 5599.0, 5542.0, 5262.0, 5287.0, 5308.0

						5630.0, 5567.0, 5448.0, 5381.0, 5256.0, 5445.0, 5373.0, 5422.0, 5331.0, 5464.0, 5550.0, 5637.0, 5609.0, 5319.0, 5482.0, 5681.0, 5519.0, 5503.0, 5473.0, 5358.0, 5687.0, 5263.0, 5341.0, 5556.0, 5379.0, 5290.0, 5325.0, 5359.0, 5682.0, 5438.0, 5594.0, 5401.0, 5701.0, 5395.0, 5532.0
4	5510	9	1	333	1	5272.0, 5482.0, 5478.0, 5279.0, 5359.0, 5316.0, 5572.0, 5674.0, 5343.0, 5453.0, 5534.0, 5351.0, 5465.0, 5555.0, 5361.0, 5260.0, 5614.0, 5346.0, 5499.0, 5306.0, 5374.0, 5317.0, 5605.0, 5305.0, 5335.0, 5507.0, 5574.0, 5693.0, 5294.0, 5633.0, 5337.0, 5523.0, 5680.0, 5271.0, 5435.0, 5573.0, 5466.0, 5536.0, 5495.0, 5651.0, 5571.0, 5712.0, 5601.0, 5458.0, 5719.0, 5615.0, 5644.0, 5699.0, 5422.0, 5310.0, 5411.0, 5621.0, 5312.0, 5432.0, 5648.0, 5602.0, 5626.0, 5517.0, 5498.0, 5579.0, 5575.0, 5331.0, 5638.0, 5553.0, 5645.0, 5547.0, 5349.0, 5352.0, 5642.0, 5328.0, 5384.0, 5610.0, 5717.0, 5665.0, 5398.0, 5416.0, 5339.0, 5533.0, 5451.0, 5302.0, 5479.0, 5501.0, 5490.0, 5714.0, 5617.0, 5623.0, 5509.0, 5253.0, 5535.0, 5673.0, 5700.0, 5655.0, 5284.0, 5350.0, 5480.0, 5488.0, 5307.0, 5688.0, 5334.0, 5634.0
5	5510	9	1	333	1	5547.0, 5294.0, 5666.0, 5273.0, 5426.0, 5311.0, 5386.0, 5646.0, 5394.0, 5568.0, 5697.0, 5684.0, 5645.0, 5436.0, 5657.0, 5434.0, 5445.0, 5309.0, 5506.0, 5523.0, 5647.0, 5388.0, 5498.0, 5345.0, 5290.0, 5299.0, 5501.0, 5553.0, 5491.0, 5589.0, 5517.0, 5373.0, 5469.0, 5588.0, 5315.0, 5266.0, 5429.0, 5254.0, 5653.0, 5719.0, 5563.0, 5496.0, 5500.0, 5395.0, 5326.0, 5575.0, 5300.0, 5669.0, 5347.0, 5296.0, 5321.0, 5521.0, 5279.0, 5301.0, 5505.0, 5408.0, 5507.0, 5539.0, 5691.0, 5370.0, 5661.0, 5698.0, 5610.0, 5432.0, 5435.0, 5302.0, 5650.0, 5375.0, 5430.0, 5578.0, 5638.0, 5703.0, 5282.0, 5623.0, 5362.0, 5560.0, 5403.0, 5487.0, 5555.0, 5722.0, 5707.0, 5692.0, 5493.0, 5338.0, 5411.0, 5570.0, 5622.0, 5483.0, 5477.0, 5677.0, 5333.0, 5528.0, 5318.0, 5715.0, 5592.0, 5558.0, 5378.0, 5482.0, 5607.0, 5632.0
6	5510	9	1	333	1	5538.0, 5692.0, 5723.0, 5671.0, 5406.0, 5323.0, 5493.0, 5347.0, 5361.0, 5515.0, 5384.0, 5722.0, 5434.0, 5497.0, 5654.0, 5672.0, 5410.0, 5309.0, 5429.0, 5652.0, 5610.0, 5377.0, 5542.0, 5714.0, 5350.0, 5585.0, 5547.0, 5432.0, 5267.0, 5425.0, 5316.0, 5494.0, 5259.0, 5532.0, 5437.0, 5273.0, 5535.0, 5353.0, 5297.0, 5578.0, 5288.0, 5701.0, 5646.0, 5658.0, 5615.0, 5313.0, 5261.0, 5656.0, 5587.0, 5366.0, 5541.0, 5504.0, 5673.0, 5500.0, 5403.0, 5307.0, 5636.0, 5333.0, 5299.0, 5394.0, 5443.0, 5453.0, 5647.0, 5475.0, 5262.0

						5342.0, 5614.0, 5395.0, 5449.0, 5659.0, 5643.0, 5706.0, 5635.0, 5555.0, 5527.0, 5524.0, 5619.0, 5592.0, 5571.0, 5662.0, 5664.0, 5284.0, 5490.0, 5562.0, 5252.0, 5317.0, 5606.0, 5702.0, 5283.0, 5704.0, 5386.0, 5533.0, 5675.0, 5359.0, 5401.0, 5582.0, 5573.0, 5256.0, 5411.0, 5519.0
7	5510	9	1	333	1	5368.0, 5334.0, 5331.0, 5268.0, 5303.0, 5590.0, 5440.0, 5661.0, 5407.0, 5291.0, 5253.0, 5265.0, 5446.0, 5278.0, 5708.0, 5710.0, 5394.0, 5554.0, 5409.0, 5578.0, 5606.0, 5463.0, 5388.0, 5527.0, 5369.0, 5565.0, 5261.0, 5396.0, 5341.0, 5685.0, 5276.0, 5467.0, 5508.0, 5319.0, 5623.0, 5677.0, 5650.0, 5503.0, 5399.0, 5698.0, 5352.0, 5383.0, 5263.0, 5634.0, 5286.0, 5545.0, 5601.0, 5636.0, 5695.0, 5481.0, 5356.0, 5515.0, 5485.0, 5307.0, 5681.0, 5537.0, 5675.0, 5719.0, 5444.0, 5434.0, 5490.0, 5551.0, 5691.0, 5460.0, 5269.0, 5658.0, 5562.0, 5688.0, 5671.0, 5408.0, 5375.0, 5585.0, 5317.0, 5339.0, 5484.0, 5424.0, 5605.0, 5287.0, 5493.0, 5340.0, 5597.0, 5518.0, 5570.0, 5627.0, 5402.0, 5330.0, 5497.0, 5505.0, 5300.0, 5389.0, 5470.0, 5405.0, 5566.0, 5700.0, 5534.0, 5282.0, 5296.0, 5660.0, 5523.0, 5646.0
8	5510	9	1	333	1	5549.0, 5466.0, 5426.0, 5555.0, 5546.0, 5695.0, 5578.0, 5567.0, 5354.0, 5686.0, 5537.0, 5392.0, 5472.0, 5332.0, 5436.0, 5463.0, 5635.0, 5284.0, 5363.0, 5594.0, 5458.0, 5526.0, 5323.0, 5364.0, 5685.0, 5331.0, 5419.0, 5433.0, 5643.0, 5344.0, 5639.0, 5322.0, 5664.0, 5510.0, 5688.0, 5495.0, 5671.0, 5327.0, 5351.0, 5580.0, 5708.0, 5518.0, 5682.0, 5525.0, 5407.0, 5455.0, 5700.0, 5492.0, 5452.0, 5418.0, 5514.0, 5280.0, 5606.0, 5401.0, 5681.0, 5607.0, 5437.0, 5658.0, 5328.0, 5592.0, 5647.0, 5636.0, 5467.0, 5460.0, 5461.0, 5288.0, 5302.0, 5611.0, 5399.0, 5471.0, 5511.0, 5651.0, 5599.0, 5306.0, 5361.0, 5374.0, 5723.0, 5595.0, 5262.0, 5439.0, 5600.0, 5289.0, 5499.0, 5531.0, 5313.0, 5621.0, 5360.0, 5398.0, 5693.0, 5335.0, 5502.0, 5522.0, 5320.0, 5598.0, 5575.0, 5488.0, 5684.0, 5622.0, 5294.0, 5539.0
9	5510	9	1	333	1	5548.0, 5305.0, 5644.0, 5345.0, 5534.0, 5291.0, 5664.0, 5424.0, 5526.0, 5328.0, 5491.0, 5503.0, 5519.0, 5662.0, 5604.0, 5506.0, 5712.0, 5403.0, 5677.0, 5343.0, 5579.0, 5334.0, 5552.0, 5626.0, 5679.0, 5286.0, 5313.0, 5666.0, 5337.0, 5393.0, 5426.0, 5633.0, 5496.0, 5719.0, 5281.0, 5703.0, 5500.0, 5457.0, 5498.0, 5585.0, 5594.0, 5515.0, 5361.0, 5675.0, 5362.0, 5329.0, 5344.0, 5569.0, 5551.0, 5322.0, 5531.0, 5461.0, 5380.0, 5459.0, 5417.0, 5256.0, 5669.0, 5338.0, 5467.0, 5373.0, 5454.0, 5339.0, 5614.0, 5656.0, 5564.0

						5475.0, 5431.0, 5527.0, 5610.0, 5558.0, 5309.0, 5509.0, 5684.0, 5575.0, 5476.0, 5340.0, 5265.0, 5288.0, 5639.0, 5615.0, 5637.0, 5525.0, 5647.0, 5372.0, 5352.0, 5590.0, 5678.0, 5336.0, 5441.0, 5321.0, 5545.0, 5259.0, 5280.0, 5720.0, 5650.0, 5269.0, 5437.0, 5472.0, 5271.0, 5645.0
10	5510	9	1	333	1	5633.0, 5337.0, 5622.0, 5627.0, 5666.0, 5503.0, 5654.0, 5329.0, 5698.0, 5656.0, 5554.0, 5322.0, 5303.0, 5284.0, 5278.0, 5584.0, 5390.0, 5332.0, 5280.0, 5718.0, 5564.0, 5345.0, 5501.0, 5363.0, 5559.0, 5301.0, 5582.0, 5547.0, 5566.0, 5319.0, 5381.0, 5634.0, 5410.0, 5471.0, 5612.0, 5662.0, 5340.0, 5400.0, 5276.0, 5692.0, 5440.0, 5491.0, 5395.0, 5568.0, 5331.0, 5685.0, 5523.0, 5569.0, 5417.0, 5495.0, 5281.0, 5255.0, 5356.0, 5500.0, 5485.0, 5659.0, 5361.0, 5423.0, 5265.0, 5358.0, 5572.0, 5377.0, 5669.0, 5310.0, 5625.0, 5374.0, 5372.0, 5392.0, 5641.0, 5441.0, 5695.0, 5583.0, 5515.0, 5367.0, 5275.0, 5649.0, 5562.0, 5421.0, 5394.0, 5379.0, 5681.0, 5264.0, 5326.0, 5383.0, 5273.0, 5455.0, 5426.0, 5711.0, 5406.0, 5628.0, 5481.0, 5700.0, 5488.0, 5330.0, 5637.0, 5497.0, 5544.0, 5708.0, 5344.0, 5407.0
11	5510	9	1	333	1	5431.0, 5346.0, 5444.0, 5632.0, 5356.0, 5328.0, 5448.0, 5449.0, 5391.0, 5635.0, 5338.0, 5371.0, 5477.0, 5572.0, 5475.0, 5269.0, 5466.0, 5469.0, 5618.0, 5550.0, 5441.0, 5334.0, 5616.0, 5556.0, 5419.0, 5304.0, 5351.0, 5343.0, 5683.0, 5705.0, 5377.0, 5675.0, 5364.0, 5316.0, 5517.0, 5654.0, 5629.0, 5271.0, 5376.0, 5592.0, 5529.0, 5552.0, 5624.0, 5468.0, 5430.0, 5608.0, 5667.0, 5372.0, 5579.0, 5352.0, 5607.0, 5349.0, 5424.0, 5307.0, 5429.0, 5503.0, 5490.0, 5679.0, 5353.0, 5610.0, 5653.0, 5434.0, 5596.0, 5281.0, 5392.0, 5339.0, 5438.0, 5464.0, 5423.0, 5680.0, 5531.0, 5312.0, 5549.0, 5384.0, 5519.0, 5497.0, 5451.0, 5677.0, 5693.0, 5537.0, 5609.0, 5699.0, 5425.0, 5670.0, 5580.0, 5698.0, 5672.0, 5682.0, 5622.0, 5562.0, 5450.0, 5276.0, 5292.0, 5305.0, 5491.0, 5708.0, 5285.0, 5418.0, 5436.0, 5561.0
12	5510	9	1	333	1	5438.0, 5694.0, 5584.0, 5382.0, 5607.0, 5267.0, 5715.0, 5443.0, 5635.0, 5619.0, 5357.0, 5621.0, 5314.0, 5690.0, 5581.0, 5291.0, 5622.0, 5554.0, 5713.0, 5258.0, 5509.0, 5633.0, 5566.0, 5343.0, 5386.0, 5634.0, 5702.0, 5535.0, 5333.0, 5544.0, 5269.0, 5368.0, 5482.0, 5585.0, 5270.0, 5668.0, 5380.0, 5467.0, 5280.0, 5272.0, 5575.0, 5549.0, 5455.0, 5507.0, 5528.0, 5499.0, 5345.0, 5645.0, 5611.0, 5389.0, 5340.0, 5490.0, 5253.0, 5324.0, 5689.0, 5254.0, 5372.0, 5447.0, 5672.0, 5492.0, 5671.0, 5630.0, 5657.0, 5692.0, 5669.0,

						5505.0, 5367.0, 5572.0, 5483.0, 5617.0, 5445.0, 5561.0, 5292.0, 5454.0, 5285.0, 5592.0, 5312.0, 5486.0, 5661.0, 5589.0, 5257.0, 5717.0, 5356.0, 5711.0, 5510.0, 5342.0, 5327.0, 5373.0, 5496.0, 5383.0, 5485.0, 5508.0, 5361.0, 5294.0, 5302.0, 5606.0, 5504.0, 5436.0, 5656.0, 5412.0
13	5510	9	1	333	1	5404.0, 5470.0, 5400.0, 5498.0, 5695.0, 5694.0, 5345.0, 5588.0, 5377.0, 5475.0, 5346.0, 5484.0, 5480.0, 5670.0, 5714.0, 5260.0, 5447.0, 5398.0, 5255.0, 5705.0, 5393.0, 5344.0, 5471.0, 5494.0, 5615.0, 5369.0, 5418.0, 5580.0, 5722.0, 5302.0, 5521.0, 5433.0, 5598.0, 5374.0, 5571.0, 5549.0, 5505.0, 5659.0, 5432.0, 5463.0, 5452.0, 5263.0, 5305.0, 5543.0, 5262.0, 5547.0, 5428.0, 5469.0, 5551.0, 5707.0, 5365.0, 5479.0, 5438.0, 5553.0, 5472.0, 5300.0, 5313.0, 5600.0, 5257.0, 5559.0, 5282.0, 5318.0, 5337.0, 5355.0, 5363.0, 5467.0, 5555.0, 5676.0, 5522.0, 5299.0, 5591.0, 5303.0, 5712.0, 5538.0, 5617.0, 5611.0, 5309.0, 5642.0, 5711.0, 5710.0, 5516.0, 5620.0, 5690.0, 5715.0, 5319.0, 5628.0, 5256.0, 5270.0, 5391.0, 5699.0, 5349.0, 5578.0, 5292.0, 5327.0, 5544.0, 5271.0, 5546.0, 5448.0, 5442.0, 5431.0
14	5510	9	1	333	1	5378.0, 5419.0, 5423.0, 5562.0, 5356.0, 5705.0, 5304.0, 5589.0, 5483.0, 5352.0, 5366.0, 5359.0, 5277.0, 5553.0, 5544.0, 5338.0, 5405.0, 5314.0, 5457.0, 5688.0, 5332.0, 5410.0, 5612.0, 5617.0, 5335.0, 5258.0, 5548.0, 5593.0, 5722.0, 5440.0, 5564.0, 5556.0, 5452.0, 5552.0, 5459.0, 5700.0, 5609.0, 5701.0, 5684.0, 5693.0, 5477.0, 5351.0, 5399.0, 5450.0, 5608.0, 5308.0, 5540.0, 5252.0, 5706.0, 5615.0, 5535.0, 5542.0, 5464.0, 5317.0, 5509.0, 5559.0, 5601.0, 5703.0, 5518.0, 5640.0, 5449.0, 5677.0, 5696.0, 5301.0, 5398.0, 5631.0, 5484.0, 5350.0, 5253.0, 5386.0, 5456.0, 5429.0, 5302.0, 5537.0, 5291.0, 5420.0, 5494.0, 5602.0, 5441.0, 5353.0, 5574.0, 5565.0, 5343.0, 5666.0, 5406.0, 5391.0, 5315.0, 5417.0, 5501.0, 5558.0, 5355.0, 5664.0, 5691.0, 5298.0, 5649.0, 5623.0, 5720.0, 5297.0, 5588.0, 5546.0
15	5510	9	1	333	1	5545.0, 5506.0, 5508.0, 5724.0, 5298.0, 5552.0, 5615.0, 5386.0, 5704.0, 5720.0, 5687.0, 5567.0, 5697.0, 5703.0, 5553.0, 5656.0, 5698.0, 5440.0, 5274.0, 5581.0, 5339.0, 5413.0, 5420.0, 5582.0, 5601.0, 5515.0, 5696.0, 5548.0, 5694.0, 5690.0, 5666.0, 5546.0, 5250.0, 5399.0, 5712.0, 5270.0, 5348.0, 5667.0, 5282.0, 5353.0, 5512.0, 5325.0, 5472.0, 5659.0, 5613.0, 5311.0, 5430.0, 5636.0, 5345.0, 5268.0, 5722.0, 5570.0, 5449.0, 5569.0, 5710.0, 5384.0, 5681.0, 5564.0, 5317.0, 5503.0, 5266.0, 5431.0, 5620.0, 5441.0, 5312.0,

						5458.0, 5468.0, 5448.0, 5592.0, 5335.0, 5288.0, 5537.0, 5663.0, 5684.0, 5485.0, 5547.0, 5412.0, 5494.0, 5257.0, 5293.0, 5363.0, 5396.0, 5427.0, 5492.0, 5626.0, 5624.0, 5344.0, 5488.0, 5607.0, 5535.0, 5369.0, 5716.0, 5520.0, 5585.0, 5490.0, 5284.0, 5389.0, 5314.0, 5337.0, 5289.0
16	5510	9	1	333	1	5486.0, 5449.0, 5629.0, 5456.0, 5560.0, 5684.0, 5375.0, 5432.0, 5517.0, 5672.0, 5256.0, 5336.0, 5578.0, 5618.0, 5505.0, 5430.0, 5572.0, 5287.0, 5478.0, 5300.0, 5331.0, 5657.0, 5564.0, 5658.0, 5274.0, 5335.0, 5609.0, 5707.0, 5345.0, 5417.0, 5562.0, 5554.0, 5299.0, 5258.0, 5332.0, 5611.0, 5667.0, 5531.0, 5277.0, 5366.0, 5476.0, 5422.0, 5582.0, 5622.0, 5589.0, 5681.0, 5697.0, 5367.0, 5561.0, 5351.0, 5550.0, 5679.0, 5600.0, 5688.0, 5408.0, 5690.0, 5484.0, 5257.0, 5448.0, 5518.0, 5387.0, 5396.0, 5493.0, 5371.0, 5521.0, 5309.0, 5325.0, 5678.0, 5293.0, 5502.0, 5365.0, 5461.0, 5253.0, 5352.0, 5514.0, 5296.0, 5294.0, 5553.0, 5349.0, 5445.0, 5338.0, 5390.0, 5490.0, 5255.0, 5270.0, 5362.0, 5369.0, 5339.0, 5646.0, 5682.0, 5655.0, 5532.0, 5489.0, 5535.0, 5388.0, 5348.0, 5602.0, 5264.0, 5687.0, 5583.0
17	5510	9	1	333	1	5467.0, 5576.0, 5479.0, 5330.0, 5523.0, 5313.0, 5290.0, 5610.0, 5724.0, 5253.0, 5392.0, 5398.0, 5276.0, 5332.0, 5710.0, 5698.0, 5335.0, 5597.0, 5613.0, 5640.0, 5436.0, 5507.0, 5516.0, 5260.0, 5452.0, 5672.0, 5579.0, 5256.0, 5540.0, 5533.0, 5334.0, 5596.0, 5542.0, 5684.0, 5381.0, 5675.0, 5557.0, 5546.0, 5667.0, 5650.0, 5465.0, 5270.0, 5580.0, 5697.0, 5500.0, 5263.0, 5384.0, 5432.0, 5478.0, 5388.0, 5344.0, 5485.0, 5405.0, 5458.0, 5444.0, 5337.0, 5690.0, 5355.0, 5526.0, 5425.0, 5707.0, 5296.0, 5649.0, 5472.0, 5490.0, 5681.0, 5413.0, 5624.0, 5325.0, 5578.0, 5666.0, 5435.0, 5285.0, 5524.0, 5712.0, 5322.0, 5412.0, 5323.0, 5326.0, 5317.0, 5715.0, 5617.0, 5499.0, 5662.0, 5713.0, 5630.0, 5455.0, 5431.0, 5539.0, 5447.0, 5354.0, 5629.0, 5304.0, 5401.0, 5422.0, 5528.0, 5567.0, 5419.0, 5299.0, 5496.0
18	5510	9	1	333	1	5351.0, 5256.0, 5324.0, 5696.0, 5455.0, 5348.0, 5598.0, 5313.0, 5498.0, 5525.0, 5668.0, 5318.0, 5356.0, 5570.0, 5251.0, 5456.0, 5390.0, 5326.0, 5672.0, 5630.0, 5452.0, 5590.0, 5255.0, 5388.0, 5386.0, 5443.0, 5258.0, 5577.0, 5352.0, 5560.0, 5719.0, 5465.0, 5706.0, 5657.0, 5530.0, 5476.0, 5722.0, 5547.0, 5684.0, 5262.0, 5374.0, 5459.0, 5687.0, 5385.0, 5276.0, 5543.0, 5497.0, 5371.0, 5355.0, 5491.0, 5379.0, 5723.0, 5397.0, 5542.0, 5633.0, 5698.0, 5593.0, 5504.0, 5541.0, 5404.0, 5297.0, 5573.0, 5540.0, 5488.0, 5517.0,

						5350.0, 5340.0, 5544.0, 5515.0, 5365.0, 5261.0, 5665.0, 5705.0, 5597.0, 5565.0, 5336.0, 5663.0, 5269.0, 5436.0, 5358.0, 5523.0, 5283.0, 5423.0, 5529.0, 5680.0, 5332.0, 5399.0, 5584.0, 5287.0, 5579.0, 5279.0, 5509.0, 5363.0, 5591.0, 5683.0, 5702.0, 5563.0, 5475.0, 5604.0, 5469.0
19	5510	9	1	333	1	5722.0, 5462.0, 5479.0, 5648.0, 5693.0, 5647.0, 5291.0, 5388.0, 5597.0, 5361.0, 5451.0, 5543.0, 5697.0, 5311.0, 5664.0, 5518.0, 5283.0, 5252.0, 5453.0, 5381.0, 5536.0, 5428.0, 5633.0, 5446.0, 5434.0, 5572.0, 5304.0, 5539.0, 5339.0, 5424.0, 5579.0, 5679.0, 5497.0, 5485.0, 5250.0, 5680.0, 5338.0, 5685.0, 5513.0, 5488.0, 5610.0, 5308.0, 5658.0, 5486.0, 5407.0, 5399.0, 5345.0, 5561.0, 5336.0, 5257.0, 5443.0, 5556.0, 5370.0, 5691.0, 5653.0, 5699.0, 5327.0, 5505.0, 5350.0, 5432.0, 5254.0, 5314.0, 5363.0, 5349.0, 5405.0, 5516.0, 5310.0, 5344.0, 5514.0, 5659.0, 5366.0, 5357.0, 5564.0, 5554.0, 5625.0, 5640.0, 5463.0, 5500.0, 5710.0, 5411.0, 5317.0, 5438.0, 5563.0, 5645.0, 5704.0, 5309.0, 5694.0, 5321.0, 5559.0, 5472.0, 5624.0, 5383.0, 5593.0, 5460.0, 5354.0, 5668.0, 5464.0, 5590.0, 5491.0, 5671.0
20	5510	9	1	333	1	5404.0, 5551.0, 5685.0, 5636.0, 5583.0, 5558.0, 5392.0, 5702.0, 5495.0, 5602.0, 5357.0, 5461.0, 5343.0, 5684.0, 5581.0, 5407.0, 5457.0, 5447.0, 5391.0, 5314.0, 5335.0, 5333.0, 5630.0, 5552.0, 5543.0, 5414.0, 5531.0, 5370.0, 5311.0, 5590.0, 5512.0, 5318.0, 5280.0, 5390.0, 5271.0, 5521.0, 5326.0, 5505.0, 5341.0, 5255.0, 5550.0, 5418.0, 5576.0, 5288.0, 5348.0, 5642.0, 5619.0, 5724.0, 5470.0, 5569.0, 5570.0, 5400.0, 5708.0, 5597.0, 5416.0, 5574.0, 5722.0, 5411.0, 5361.0, 5677.0, 5422.0, 5587.0, 5273.0, 5409.0, 5659.0, 5716.0, 5450.0, 5267.0, 5482.0, 5477.0, 5474.0, 5303.0, 5650.0, 5299.0, 5530.0, 5367.0, 5274.0, 5467.0, 5385.0, 5536.0, 5440.0, 5399.0, 5678.0, 5603.0, 5626.0, 5484.0, 5491.0, 5525.0, 5402.0, 5666.0, 5434.0, 5705.0, 5580.0, 5627.0, 5699.0, 5709.0, 5532.0, 5445.0, 5490.0, 5681.0
21	5510	9	1	333	1	5411.0, 5690.0, 5720.0, 5278.0, 5517.0, 5357.0, 5439.0, 5266.0, 5527.0, 5422.0, 5431.0, 5642.0, 5475.0, 5315.0, 5530.0, 5381.0, 5504.0, 5688.0, 5298.0, 5250.0, 5573.0, 5590.0, 5448.0, 5587.0, 5273.0, 5398.0, 5482.0, 5600.0, 5508.0, 5579.0, 5389.0, 5340.0, 5611.0, 5268.0, 5451.0, 5342.0, 5485.0, 5287.0, 5563.0, 5464.0, 5457.0, 5535.0, 5662.0, 5394.0, 5570.0, 5311.0, 5661.0, 5343.0, 5355.0, 5321.0, 5524.0, 5374.0, 5707.0, 5596.0, 5506.0, 5362.0, 5671.0, 5525.0, 5468.0, 5487.0, 5710.0, 5476.0, 5547.0, 5312.0, 5391.0,

						5714.0, 5555.0, 5304.0, 5572.0, 5584.0, 5308.0, 5449.0, 5533.0, 5324.0, 5638.0, 5664.0, 5333.0, 5474.0, 5629.0, 5258.0, 5541.0, 5495.0, 5658.0, 5260.0, 5352.0, 5519.0, 5295.0, 5631.0, 5399.0, 5492.0, 5679.0, 5562.0, 5715.0, 5655.0, 5656.0, 5388.0, 5619.0, 5716.0, 5610.0, 5516.0
22	5510	9	1	333	1	5571.0, 5515.0, 5382.0, 5334.0, 5456.0, 5443.0, 5589.0, 5711.0, 5389.0, 5552.0, 5420.0, 5607.0, 5400.0, 5322.0, 5581.0, 5363.0, 5653.0, 5437.0, 5304.0, 5521.0, 5578.0, 5359.0, 5630.0, 5303.0, 5526.0, 5402.0, 5282.0, 5596.0, 5446.0, 5606.0, 5466.0, 5700.0, 5435.0, 5703.0, 5361.0, 5366.0, 5662.0, 5325.0, 5438.0, 5281.0, 5704.0, 5555.0, 5663.0, 5371.0, 5709.0, 5441.0, 5263.0, 5296.0, 5385.0, 5655.0, 5575.0, 5613.0, 5493.0, 5401.0, 5637.0, 5290.0, 5467.0, 5449.0, 5523.0, 5671.0, 5722.0, 5323.0, 5288.0, 5580.0, 5724.0, 5333.0, 5292.0, 5519.0, 5372.0, 5480.0, 5478.0, 5394.0, 5409.0, 5563.0, 5529.0, 5482.0, 5536.0, 5464.0, 5641.0, 5648.0, 5348.0, 5483.0, 5414.0, 5535.0, 5574.0, 5457.0, 5398.0, 5624.0, 5390.0, 5393.0, 5344.0, 5279.0, 5683.0, 5362.0, 5425.0, 5261.0, 5684.0, 5505.0, 5545.0, 5309.0
23	5510	9	1	333	1	5302.0, 5542.0, 5274.0, 5518.0, 5583.0, 5250.0, 5641.0, 5504.0, 5570.0, 5534.0, 5409.0, 5690.0, 5598.0, 5331.0, 5656.0, 5615.0, 5282.0, 5467.0, 5561.0, 5720.0, 5702.0, 5305.0, 5395.0, 5314.0, 5441.0, 5525.0, 5263.0, 5371.0, 5719.0, 5663.0, 5633.0, 5380.0, 5524.0, 5535.0, 5483.0, 5657.0, 5401.0, 5611.0, 5321.0, 5649.0, 5528.0, 5551.0, 5550.0, 5283.0, 5669.0, 5451.0, 5346.0, 5645.0, 5261.0, 5272.0, 5251.0, 5575.0, 5342.0, 5638.0, 5404.0, 5403.0, 5564.0, 5356.0, 5586.0, 5623.0, 5536.0, 5683.0, 5640.0, 5489.0, 5469.0, 5461.0, 5724.0, 5613.0, 5327.0, 5329.0, 5619.0, 5408.0, 5660.0, 5600.0, 5521.0, 5680.0, 5345.0, 5363.0, 5661.0, 5312.0, 5588.0, 5376.0, 5352.0, 5347.0, 5300.0, 5388.0, 5271.0, 5372.0, 5721.0, 5349.0, 5627.0, 5381.0, 5486.0, 5485.0, 5674.0, 5427.0, 5303.0, 5374.0, 5696.0, 5559.0
24	5510	9	1	333	1	5594.0, 5472.0, 5264.0, 5473.0, 5455.0, 5572.0, 5666.0, 5317.0, 5528.0, 5542.0, 5406.0, 5644.0, 5426.0, 5581.0, 5323.0, 5414.0, 5450.0, 5331.0, 5410.0, 5665.0, 5466.0, 5482.0, 5458.0, 5335.0, 5655.0, 5349.0, 5345.0, 5272.0, 5321.0, 5534.0, 5310.0, 5723.0, 5529.0, 5573.0, 5522.0, 5546.0, 5511.0, 5286.0, 5543.0, 5363.0, 5663.0, 5269.0, 5493.0, 5531.0, 5518.0, 5550.0, 5540.0, 5526.0, 5646.0, 5503.0, 5373.0, 5613.0, 5478.0, 5377.0, 5680.0, 5445.0, 5568.0, 5490.0, 5383.0, 5693.0, 5325.0, 5622.0, 5303.0, 5454.0, 5428.0

						5448.0, 5508.0, 5541.0, 5492.0, 5365.0, 5309.0, 5652.0, 5564.0, 5263.0, 5605.0, 5267.0, 5697.0, 5279.0, 5273.0, 5624.0, 5401.0, 5479.0, 5669.0, 5287.0, 5600.0, 5324.0, 5416.0, 5355.0, 5398.0, 5255.0, 5578.0, 5298.0, 5513.0, 5710.0, 5278.0, 5565.0, 5674.0, 5525.0, 5628.0, 5637.0
25	5510	9	1	333	1	5285.0, 5488.0, 5429.0, 5520.0, 5396.0, 5312.0, 5422.0, 5673.0, 5326.0, 5400.0, 5620.0, 5633.0, 5623.0, 5441.0, 5638.0, 5618.0, 5300.0, 5294.0, 5447.0, 5388.0, 5664.0, 5550.0, 5536.0, 5632.0, 5417.0, 5353.0, 5440.0, 5359.0, 5693.0, 5468.0, 5674.0, 5639.0, 5275.0, 5259.0, 5341.0, 5592.0, 5691.0, 5329.0, 5473.0, 5543.0, 5686.0, 5707.0, 5433.0, 5467.0, 5463.0, 5389.0, 5356.0, 5598.0, 5317.0, 5434.0, 5585.0, 5609.0, 5630.0, 5699.0, 5392.0, 5402.0, 5304.0, 5318.0, 5628.0, 5689.0, 5303.0, 5646.0, 5647.0, 5399.0, 5461.0, 5278.0, 5514.0, 5288.0, 5677.0, 5682.0, 5474.0, 5457.0, 5330.0, 5603.0, 5277.0, 5309.0, 5654.0, 5483.0, 5655.0, 5315.0, 5594.0, 5670.0, 5517.0, 5305.0, 5297.0, 5675.0, 5339.0, 5719.0, 5252.0, 5580.0, 5465.0, 5368.0, 5687.0, 5257.0, 5554.0, 5301.0, 5430.0, 5412.0, 5371.0, 5493.0
26	5510	9	1	333	1	5541.0, 5354.0, 5339.0, 5348.0, 5712.0, 5565.0, 5590.0, 5650.0, 5557.0, 5575.0, 5433.0, 5460.0, 5450.0, 5526.0, 5493.0, 5686.0, 5648.0, 5289.0, 5445.0, 5522.0, 5588.0, 5696.0, 5400.0, 5523.0, 5724.0, 5660.0, 5651.0, 5596.0, 5385.0, 5389.0, 5304.0, 5376.0, 5320.0, 5652.0, 5707.0, 5322.0, 5543.0, 5597.0, 5692.0, 5333.0, 5559.0, 5718.0, 5300.0, 5278.0, 5251.0, 5644.0, 5299.0, 5688.0, 5594.0, 5504.0, 5553.0, 5716.0, 5560.0, 5698.0, 5455.0, 5355.0, 5343.0, 5623.0, 5432.0, 5598.0, 5411.0, 5537.0, 5363.0, 5384.0, 5488.0, 5603.0, 5655.0, 5632.0, 5500.0, 5404.0, 5638.0, 5693.0, 5487.0, 5419.0, 5394.0, 5461.0, 5528.0, 5609.0, 5330.0, 5413.0, 5345.0, 5479.0, 5534.0, 5434.0, 5496.0, 5311.0, 5711.0, 5332.0, 5591.0, 5595.0, 5540.0, 5674.0, 5579.0, 5542.0, 5554.0, 5478.0, 5266.0, 5529.0, 5502.0, 5319.0
27	5510	9	1	333	1	5591.0, 5286.0, 5365.0, 5349.0, 5523.0, 5277.0, 5357.0, 5366.0, 5273.0, 5654.0, 5328.0, 5476.0, 5364.0, 5413.0, 5493.0, 5718.0, 5679.0, 5367.0, 5507.0, 5449.0, 5479.0, 5362.0, 5581.0, 5291.0, 5300.0, 5347.0, 5467.0, 5558.0, 5670.0, 5471.0, 5330.0, 5710.0, 5549.0, 5473.0, 5417.0, 5610.0, 5658.0, 5420.0, 5585.0, 5402.0, 5409.0, 5408.0, 5566.0, 5554.0, 5538.0, 5629.0, 5608.0, 5352.0, 5342.0, 5422.0, 5565.0, 5632.0, 5299.0, 5579.0, 5599.0, 5498.0, 5500.0, 5275.0, 5649.0, 5294.0, 5580.0, 5462.0, 5597.0, 5537.0, 5624.0,

						5705.0, 5394.0, 5531.0, 5574.0, 5383.0, 5602.0, 5683.0, 5644.0, 5457.0, 5495.0, 5256.0, 5568.0, 5651.0, 5372.0, 5494.0, 5708.0, 5339.0, 5358.0, 5474.0, 5516.0, 5438.0, 5636.0, 5511.0, 5633.0, 5672.0, 5407.0, 5561.0, 5637.0, 5577.0, 5575.0, 5404.0, 5519.0, 5552.0, 5656.0, 5667.0
28	5510	9	1	333	1	5390.0, 5406.0, 5661.0, 5722.0, 5700.0, 5473.0, 5483.0, 5624.0, 5409.0, 5656.0, 5301.0, 5435.0, 5593.0, 5576.0, 5526.0, 5445.0, 5398.0, 5440.0, 5340.0, 5588.0, 5662.0, 5497.0, 5613.0, 5596.0, 5352.0, 5272.0, 5502.0, 5337.0, 5271.0, 5605.0, 5280.0, 5625.0, 5667.0, 5518.0, 5375.0, 5626.0, 5385.0, 5606.0, 5347.0, 5415.0, 5402.0, 5491.0, 5395.0, 5358.0, 5564.0, 5307.0, 5472.0, 5426.0, 5696.0, 5468.0, 5386.0, 5363.0, 5559.0, 5689.0, 5630.0, 5590.0, 5566.0, 5336.0, 5447.0, 5579.0, 5589.0, 5611.0, 5290.0, 5351.0, 5482.0, 5524.0, 5342.0, 5511.0, 5353.0, 5664.0, 5252.0, 5284.0, 5364.0, 5369.0, 5651.0, 5346.0, 5578.0, 5615.0, 5333.0, 5338.0, 5261.0, 5303.0, 5316.0, 5382.0, 5404.0, 5297.0, 5361.0, 5670.0, 5676.0, 5424.0, 5457.0, 5523.0, 5690.0, 5530.0, 5629.0, 5527.0, 5282.0, 5522.0, 5374.0, 5380.0
29	5510	9	1	333	1	5596.0, 5697.0, 5489.0, 5644.0, 5343.0, 5709.0, 5608.0, 5379.0, 5362.0, 5536.0, 5540.0, 5691.0, 5411.0, 5256.0, 5538.0, 5553.0, 5477.0, 5490.0, 5687.0, 5476.0, 5306.0, 5642.0, 5312.0, 5661.0, 5407.0, 5532.0, 5295.0, 5482.0, 5393.0, 5487.0, 5324.0, 5597.0, 5652.0, 5564.0, 5300.0, 5284.0, 5485.0, 5484.0, 5629.0, 5586.0, 5255.0, 5657.0, 5496.0, 5542.0, 5501.0, 5353.0, 5504.0, 5589.0, 5703.0, 5318.0, 5429.0, 5511.0, 5567.0, 5426.0, 5491.0, 5594.0, 5582.0, 5350.0, 5405.0, 5561.0, 5432.0, 5495.0, 5599.0, 5377.0, 5645.0, 5638.0, 5328.0, 5290.0, 5274.0, 5602.0, 5360.0, 5500.0, 5581.0, 5543.0, 5296.0, 5367.0, 5665.0, 5499.0, 5611.0, 5497.0, 5558.0, 5707.0, 5264.0, 5340.0, 5483.0, 5410.0, 5334.0, 5531.0, 5304.0, 5355.0, 5278.0, 5556.0, 5508.0, 5559.0, 5486.0, 5606.0, 5705.0, 5339.0, 5635.0, 5636.0
30	5510	9	1	333	1	5502.0, 5548.0, 5517.0, 5393.0, 5697.0, 5259.0, 5454.0, 5598.0, 5334.0, 5651.0, 5647.0, 5471.0, 5631.0, 5399.0, 5265.0, 5349.0, 5372.0, 5584.0, 5320.0, 5445.0, 5619.0, 5575.0, 5685.0, 5453.0, 5257.0, 5358.0, 5408.0, 5346.0, 5270.0, 5555.0, 5693.0, 5706.0, 5420.0, 5526.0, 5583.0, 5587.0, 5348.0, 5451.0, 5539.0, 5588.0, 5618.0, 5368.0, 5340.0, 5322.0, 5560.0, 5383.0, 5271.0, 5398.0, 5499.0, 5321.0, 5577.0, 5458.0, 5319.0, 5302.0, 5388.0, 5344.0, 5567.0, 5709.0, 5672.0, 5475.0, 5427.0, 5644.0, 5481.0, 5665.0, 5482.0,

						5277.0, 5371.0, 5604.0, 5668.0, 5553.0, 5571.0, 5673.0, 5425.0, 5662.0, 5364.0, 5664.0, 5307.0, 5295.0, 5515.0, 5652.0, 5712.0, 5491.0, 5355.0, 5628.0, 5719.0, 5530.0, 5418.0, 5480.0, 5441.0, 5424.0, 5659.0, 5541.0, 5680.0, 5533.0, 5438.0, 5351.0, 5369.0, 5284.0, 5711.0, 5407.0
--	--	--	--	--	--	--

80MHz

Radar SignalType	Waveform/Trial Number	Detection (%)	Limit (%)	Pass/Fail
Type 1A	15	93.33%	60%	pass
Type 1B	15	100%	60%	pass
Type 2	30	96.7 %	60%	Pass
Type 3	30	100 %	60%	Pass
Type 4	30	100 %	60%	Pass
Aggregate(Type1 to 4)	120	98.33 %	80%	Pass
Type 5	30	100 %	80%	Pass
Type 6	30	100 %	70%	Pass

Please refer to the following statistical tables:

5530MHz**Radar Type 1A Statistical Performance**

Trial #	Fc (MHz)	Pulse/Burst	Pulse Width (μS)	PRI (μs)	Detection (1:yes; 0:no)
1	5530	99	1	538	1
2	5530	58	1	918	1
3	5530	86	1	618	1
4	5530	95	1	558	1
5	5530	65	1	818	1
6	5530	62	1	858	1
7	5530	83	1	638	1
8	5530	61	1	878	1
9	5530	92	1	578	1
10	5530	102	1	518	1
11	5530	74	1	718	1
12	5530	57	1	938	1
13	5530	63	1	838	1
14	5530	78	1	678	0
15	5530	67	1	798	1
Detection Percentage: 93.3% (>60%)					

Radar Type 1B Statistical Performance

Trial #	Fc (MHz)	Pulse/Burst	Pulse Width (μS)	PRI (μs)	Detection (1:yes; 0:no)
1	5530	64	1	828	1
2	5530	27	1	1980	1
3	5530	23	1	2320	1
4	5530	22	1	2495	1
5	5530	18	1	3028	1
6	5530	23	1	2331	1
7	5530	33	1	1640	1
8	5530	20	1	2647	1
9	5530	38	1	1403	1
10	5530	32	1	1698	1
11	5530	18	1	3051	1
12	5530	32	1	1696	1
13	5530	75	1	709	1
14	5530	23	1	2355	1
15	5530	35	1	1524	1
Detection Percentage: 100 % (>60%)					

Radar Type 2 Statistical Performance

Trial #	Fc (MHz)	Pulse/Burst	Pulse Width (μS)	PRI (μs)	Detection (1:yes; 0:no)
1	5530	24	3.8	156	1
2	5530	23	4.4	165	1
3	5530	25	1.9	207	1
4	5530	26	3.5	224	1
5	5530	26	4.7	168	1
6	5530	23	2.6	188	1
7	5530	26	4.1	210	1
8	5530	28	2.6	186	1
9	5530	27	3.9	195	1
10	5530	23	2.1	214	1
11	5530	23	4	182	1
12	5530	25	3.8	179	1
13	5530	27	2.7	212	1
14	5530	25	3.6	163	1
15	5530	26	4.2	227	1
16	5530	25	2	183	0
17	5530	24	3.8	219	1
18	5530	24	1.4	215	1
19	5530	23	2.3	196	1
20	5530	26	4.9	217	1
21	5530	26	1.9	205	1
22	5530	28	1.2	193	1
23	5530	29	5	189	1
24	5530	23	1.7	174	1
25	5530	25	3.1	180	1
26	5530	23	4.4	170	1
27	5530	26	1.3	180	1
28	5530	23	3.6	230	1
29	5530	26	1.9	227	1
30	5530	29	1.3	157	1
Detection Percentage: 96.7 % (>60%)					

Radar Type 3 Statistical Performance

Trial #	Fc (MHz)	Pulse/Burst	Pulse Width (μS)	PRI (μs)	Detection (1:yes; 0:no)
1	5530	16	8.1	410	1
2	5530	16	9.2	414	1
3	5530	16	7.1	271	1
4	5530	16	7.9	408	1
5	5530	16	6.6	284	1
6	5530	17	8.8	277	1
7	5530	16	6.6	355	1
8	5530	16	9.7	465	1
9	5530	17	8.2	495	1
10	5530	17	8.8	445	1
11	5530	17	8.7	498	1
12	5530	18	9.6	234	1
13	5530	17	8.2	229	1
14	5530	17	10	216	1
15	5530	18	8.4	341	1
16	5530	17	6.6	398	1
17	5530	18	8.9	431	1
18	5530	18	7.9	238	1
19	5530	18	7.4	500	1
20	5530	18	6	207	1
21	5530	17	7.2	490	1
22	5530	16	7.6	353	1
23	5530	16	6.1	322	1
24	5530	18	6.2	214	1
25	5530	17	8.7	312	1
26	5530	16	9.2	297	1
27	5530	16	6.7	351	1
28	5530	17	8.5	350	1
29	5530	17	7.3	260	1
30	5530	18	8.6	210	1
Detection Percentage: 100 % (>60%)					

Radar Type 4 Statistical Performance

Trial #	Fc (MHz)	Pulse/Burst	Pulse Width (µS)	PRI (µs)	Detection (1:yes; 0:no)
1	5530	16	13.6	250	1
2	5530	13	14	213	1
3	5530	12	17.5	404	1
4	5530	15	12.4	441	1
5	5530	13	14.3	445	1
6	5530	12	14.1	494	1
7	5530	13	14.4	473	1
8	5530	16	14	376	1
9	5530	12	12.6	428	1
10	5530	12	12.3	232	1
11	5530	14	15	329	1
12	5530	15	16.3	241	1
13	5530	12	15.5	434	1
14	5530	14	19.2	259	1
15	5530	15	19.1	496	1
16	5530	16	19.1	306	1
17	5530	16	12	500	1
18	5530	13	17.4	465	1
19	5530	15	19	356	1
20	5530	16	13.1	372	1
21	5530	15	16.6	362	1
22	5530	16	15.2	216	1
23	5530	15	13	298	1
24	5530	15	12.4	241	1
25	5530	12	14.5	481	1
26	5530	12	18.3	274	1
27	5530	16	18.9	392	1
28	5530	13	14.9	347	1
29	5530	15	16.1	381	1
30	5530	16	16.1	290	1
Detection Percentage: 100 % (>60%)					

Radar Type 5 Case 1 Statistical Performance

Statistics 1 (ChirpCenter Frequency: 5530.0MHz)

Trial #	Pulse	Chirp(MHz)	Pulse Width (μS)	Pulse 1-2 spacing(μS)	Pulse 2-3 spacing(μS)	Pulse Start(S)	Detection (1:yes;0:no)
0	1	12	96.8			0.705155	1
1	3	12	87.5	1294	1049	1.586493	
2	2	12	86.8	1340		2.589456	
3	3	12	77.2	1607	1589	3.559892	
4	2	12	69.4	1323		3.811755	
5	2	12	58.6	1534		5.229347	
6	3	12	65	1603	1164	6.006998	
7	2	12	51.9	1008		6.873600	
8	3	12	76.2	1525	1297	7.992545	
9	3	12	82.4	1249	1661	9.067799	
10	1	12	72.2			9.376760	
11	3	12	91.2	1187	1950	11.012661	
12	2	12	94	1495		11.913913	

Statistics 2 (ChirpCenter Frequency: 5530.0 MHz)

Trial #	Pulse	Chirp(MHz)	Pulse Width (μS)	Pulse 1-2 spacing(μS)	Pulse 2-3 spacing(μS)	Pulse Start(S)	Detection (1:yes;0:no)
0	1	10	59.2			0.509651	1
1	2	10	57.6	1649		0.856674	
2	3	10	94.1	1872	1637	1.939207	
3	3	10	85.3	1424	1865	2.587067	
4	2	10	69.6	1927		3.449426	
5	3	10	75.8	1259	1665	4.065529	
6	2	10	98.4	1426		4.431470	
7	1	10	75.9			5.162175	
8	2	10	53.7	1951		5.902145	
9	2	10	84.2	1379		6.365627	
10	3	10	85.5	1595	1868	7.359794	
11	3	10	54.3	1157	1312	7.982258	
12	1	10	74.5			8.798718	
13	3	10	89.8	1702	1389	9.681220	
14	2	10	75.6	1212		10.394278	
15	2	10	54.8	1812		10.853531	
16	2	10	56	1375		11.896890	

Statistics 3 (ChirpCenter Frequency: 5530.0 MHz)

Trial #	Pulse	Chirp(MHz)	Pulse Width (μS)	Pulse 1-2 spacing(μS)	Pulse 2-3 spacing(μS)	Pulse Start(S)	Detection (1:yes;0:no)
0	2	10	70.6	1600		0.064544	1
1	3	10	72.5	1056	1409	1.628211	
2	1	10	96.7			2.757698	
3	2	10	68.3	1743		3.097415	
4	3	10	69.2	1276	1825	3.742417	
5	2	10	66.5	1385		5.332779	
6	2	10	78.2	1435		6.291190	
7	2	10	94.4	1176		7.210270	
8	2	10	67	1352		7.965619	
9	2	10	89.9	1011		8.568182	
10	3	10	70.2	1754	1287	9.466292	
11	3	10	75.1	1035	1926	10.311867	
12	3	10	55.9	1775	1801	11.342191	

Statistics 4 (ChirpCenter Frequency: 5530.0 MHz)

Trial #	Pulse	Chirp(MHz)	Pulse Width (μS)	Pulse 1-2 spacing(μS)	Pulse 2-3 spacing(μS)	Pulse Start(S)	Detection (1:yes;0:no)
0	2	7	81.6	1795		1.065325	1
1	2	7	73.8	1801		2.059018	
2	1	7	63.9			2.460822	
3	3	7	92	1534	1984	3.575568	
4	2	7	55.3	1038		5.246118	
5	2	7	55.4	1255		6.146286	
6	2	7	78.2	1204		7.341535	
7	1	7	62.7			8.615493	
8	1	7	53.3			8.829800	
9	2	7	90.5	1434		10.521664	
10	2	7	93.4	1592		11.586444	

Statistics 5(ChirpCenter Frequency: 5530.0 MHz)

Trial #	Pulse	Chirp(MHz)	Pulse Width (μS)	Pulse 1-2 spacing(μS)	Pulse 2-3 spacing(μS)	Pulse Start(S)	Detection (1:yes;0:no)
0	2	14	97.5	1014		0.275778	1
1	3	14	77.9	1811	1994	0.896720	
2	1	14	87.1			1.657603	
3	2	14	88.7	1603		2.139914	
4	2	14	78.4	1914		2.430198	
5	1	14	55.6			3.032318	
6	3	14	59.1	1795	1406	3.897505	
7	3	14	78.2	1520	1963	4.367691	
8	2	14	61.9	1638		5.273288	
9	1	14	96.5			5.952996	
10	2	14	80.5	1591		6.594715	
11	1	14	51.5			7.145044	
12	1	14	85.5			7.244332	
13	1	14	55.9			7.990067	
14	2	14	69.2	1602		8.874519	
15	2	14	71.9	1336		9.498261	
16	3	14	78.9	1819	1720	9.941963	
17	2	14	84.4	1833		10.514691	
18	3	14	94.2	1707	1853	10.826934	
19	2	14	78.4	1726		11.666329	

Statistics 6 (ChirpCenter Frequency: 5530.0 MHz)

Trial #	Pulse	Chirp(MHz)	Pulse Width (μS)	Pulse 1-2 spacing(μS)	Pulse 2-3 spacing(μS)	Pulse Start(S)	Detection (1:yes;0:no)
0	2	10	69.2	1843		0.014819	1
1	1	10	59.7			0.843511	
2	1	10	70.6			1.833808	
3	2	10	81.4	1826		2.601763	
4	2	10	80.2	1508		2.920889	
5	2	10	87.2	1601		3.990110	
6	3	10	63.1	1831	1091	4.326822	
7	1	10	61.5			5.604548	
8	2	10	54.7	1059		6.201402	
9	2	10	50.2	1989		6.384111	
10	3	10	77	1463	1179	7.726694	
11	1	10	52.2			7.911141	
12	1	10	61.7			8.944334	
13	2	10	70.5	1343		9.396525	
14	2	10	91.9	1876		9.987649	
15	2	10	91.7	1828		10.613307	
16	3	10	86.9	1045	1006	11.622849	

Statistics 7(ChirpCenter Frequency: 5530.0 MHz)

Trial #	Pulse	Chirp(MHz)	Pulse Width (μS)	Pulse 1-2 spacing(μS)	Pulse 2-3 spacing(μS)	Pulse Start(S)	Detection (1:yes;0:no)
0	3	6	78	1595	1063	0.146323	1
1	2	6	98.8	1881		1.165785	
2	1	6	55.2			2.029924	
3	1	6	72.4			2.590702	
4	1	6	83.6			3.150540	
5	1	6	63.7			4.169116	
6	2	6	89.3	1192		4.613149	
7	1	6	55.6			5.676955	
8	2	6	68.3	1904		6.534820	
9	3	6	88.7	1682	1533	7.069332	
10	2	6	58.8	1841		7.678896	
11	1	6	53.4			8.367880	
12	1	6	73.1			9.565842	
13	2	6	85.2	1152		9.873346	
14	3	6	74.7	1130	1443	11.095805	
15	2	6	100	1386		11.613359	

Statistics 8 (ChirpCenter Frequency: 5530.0 MHz)

Trial #	Pulse	Chirp(MHz)	Pulse Width (μS)	Pulse 1-2 spacing(μS)	Pulse 2-3 spacing(μS)	Pulse Start(S)	Detection (1:yes;0:no)
0	2	7	94.5	1001		0.594600	1
1	3	7	63.3	1491	1608	1.113863	
2	3	7	84.2	1065	1229	1.757456	
3	1	7	99.4			2.328272	
4	1	7	63.7			2.719233	
5	1	7	91.7			3.734543	
6	2	7	64.1	1703		4.391908	
7	1	7	78.5			5.026863	
8	3	7	79.3	1455	1521	5.397131	
9	2	7	58.8	1709		6.286347	
10	2	7	86.5	1036		6.991115	
11	2	7	80.4	1726		7.780763	
12	2	7	87.9	1937		8.621895	
13	2	7	69.5	1918		9.308007	
14	3	7	88.2	1584	1661	9.783546	
15	3	7	74.3	1157	1384	10.529428	
16	2	7	69.5	1549		10.961388	
17	3	7	77.3	1110	1948	11.957847	

Statistics 9 (ChirpCenter Frequency: 5530.0 MHz)

Trial #	Pulse	Chirp(MHz)	Pulse Width (μS)	Pulse 1-2 spacing(μS)	Pulse 2-3 spacing(μS)	Pulse Start(S)	Detection (1:yes;0:no)
0	2	16	62.4	1759		0.701381	1
1	2	16	53	1883		1.827010	
2	2	16	52.3	1345		2.071435	
3	3	16	62.4	1194	1227	3.344705	
4	2	16	62.5	1846		4.068445	
5	2	16	51.9	1487		4.800831	
6	2	16	93.3	1823		6.223534	
7	3	16	58.5	1917	1074	6.740010	
8	1	16	98.8			7.812825	
9	3	16	99.1	1352	1424	8.629377	
10	2	16	93.1	1320		9.297863	
11	2	16	94.1	1107		10.476830	
12	2	16	66.1	1560		11.510677	

Statistics 10 (ChirpCenter Frequency: 5530.0 MHz)

Trial #	Pulse	Chirp(MHz)	Pulse Width (μS)	Pulse 1-2 spacing(μS)	Pulse 2-3 spacing(μS)	Pulse Start(S)	Detection (1:yes;0:no)
0	3	8	69.7	1317	1145	0.259604	1
1	3	8	80.8	1469	1443	1.319435	
2	1	8	72.2			1.812717	
3	3	8	59.6	1645	1404	2.422205	
4	2	8	80.5	1308		2.949888	
5	3	8	68.7	1754	1266	3.895485	
6	2	8	90.8	1513		4.875674	
7	3	8	79.5	1565	1372	5.343340	
8	1	8	95.7			6.039333	
9	2	8	57.8	1196		6.623120	
10	3	8	90.4	1545	1510	7.201198	
11	1	8	79.2			8.376285	
12	3	8	85.4	1951	1081	8.838208	
13	1	8	93.8			9.786552	
14	2	8	50.8	1965		10.031059	
15	3	8	63.5	1328	1310	10.972980	
16	3	8	80	1852	1892	11.967507	

Radar Type 5 Case 2 Statistical Performance

Statistics 1 (ChirpCenter Frequency: 5493.0 MHz)

Trial #	Pulse	Chirp(MHz)	Pulse Width (μS)	Pulse 1-2 spacing(μS)	Pulse 2-3 spacing(μS)	Pulse Start(S)	Detection (1:yes;0:no)
0	3	8	91.5	1201	1757	0.282215	1
1	2	8	99.7	1609		2.093911	
2	1	8	97.3			2.837515	
3	2	8	57.7	1998		3.938392	
4	3	8	82.2	1378	1518	4.703321	
5	2	8	68.2	1199		5.638628	
6	2	8	87.4	1831		7.377964	
7	3	8	89.3	1577	1285	8.324523	
8	3	8	50.9	1501	1630	8.760835	
9	1	8	76.3			10.673636	
10	3	8	82.3	1610	1445	11.266969	

Statistics 2 (ChirpCenter Frequency: 5494.0 MHz)

Trial #	Pulse	Chirp(MHz)	Pulse Width (μS)	Pulse 1-2 spacing(μS)	Pulse 2-3 spacing(μS)	Pulse Start(S)	Detection (1:yes;0:no)
0	3	11	55.5	1423	1942	0.757666	1
1	1	11	74.9			1.100353	
2	2	11	88.7	1186		3.227973	
3	2	11	98.4	1981		3.892345	
4	2	11	96.4	1724		4.696695	
5	2	11	54	1964		5.899320	
6	2	11	85.1	1529		7.164417	
7	2	11	53.5	1887		8.156356	
8	3	11	51.4	1889	1031	9.432625	
9	2	11	50.6	1254		10.689476	
10	1	11	57.9			11.854261	

Statistics 3 (ChirpCenter Frequency: 5498.0 MHz)

Trial #	Pulse	Chirp(MHz)	Pulse Width (μS)	Pulse 1-2 spacing(μS)	Pulse 2-3 spacing(μS)	Pulse Start(S)	Detection (1:yes;0:no)
0	2	19	70.9	1677		0.499577	1
1	3	19	92.2	1300	1899	0.776676	
2	2	19	93.4	1048		1.542082	
3	2	19	76.3	1630		2.346401	
4	1	19	66			2.747760	
5	2	19	99	1895		3.230089	
6	1	19	85.8			3.933314	
7	1	19	89.3			4.203020	
8	1	19	58.9			5.044873	
9	2	19	87.6	1050		5.911761	
10	1	19	80.5			6.593339	
11	3	19	81.2	1756	1960	6.625489	
12	1	19	92.6			7.317576	
13	2	19	86.3	1117		8.073356	
14	2	19	62.4	1409		8.739379	
15	2	19	75.9	1218		9.318235	
16	1	19	84.4			10.086460	
17	3	19	54.2	1896	1486	10.274376	
18	3	19	51.5	1855	1402	11.210144	
19	3	19	58.2	1246	1280	11.957521	

Statistics 4 (ChirpCenter Frequency: 5495.0 MHz)

Trial #	Pulse	Chirp(MHz)	Pulse Width (μS)	Pulse 1-2 spacing(μS)	Pulse 2-3 spacing(μS)	Pulse Start(S)	Detection (1:yes;0:no)
0	3	13	64.2	1202	1847	0.433489	1
1	1	13	67.5			0.758463	
2	2	13	94.9	1226		1.420832	
3	3	13	65.2	1391	1850	2.788668	
4	1	13	61.4			3.352252	
5	2	13	56.4	1905		4.225739	
6	2	13	73	1501		4.926372	
7	3	13	74	1226	1258	5.532867	
8	3	13	81.1	1061	1708	5.697641	
9	3	13	86	1301	1808	6.882302	
10	1	13	56.9			7.366959	
11	2	13	91	1661		7.871097	
12	1	13	84.4			8.564112	
13	2	13	63.7	1033		9.824956	
14	2	13	60.8	1691		10.134665	
15	2	13	83.6	1785		11.021824	
16	1	13	82.4			11.948240	

Statistics 5 (ChirpCenter Frequency: 5493.0 MHz)

Trial #	Pulse	Chirp(MHz)	Pulse Width (μS)	Pulse 1-2 spacing(μS)	Pulse 2-3 spacing(μS)	Pulse Start(S)	Detection (1:yes;0:no)
0	2	8	50	1087		0.846980	1
1	2	8	75.2	1384		1.260354	
2	1	8	93.6			2.950057	
3	1	8	92.8			4.134116	
4	2	8	63.6	1296		5.345605	
5	1	8	94.8			6.753261	
6	2	8	72.8	1326		8.140771	
7	2	8	82.2	1495		8.517959	
8	2	8	99.7	1385		10.362649	
9	2	8	63.5	1749		11.104835	

Statistics 6 (ChirpCenter Frequency: 5494.0 MHz)

Trial #	Pulse	Chirp(MHz)	Pulse Width (μS)	Pulse 1-2 spacing(μS)	Pulse 2-3 spacing(μS)	Pulse Start(S)	Detection (1:yes;0:no)
0	3	10	73.6	1245	1906	0.153816	1
1	3	10	58	1749	1488	1.107835	
2	3	10	51	1114	1765	1.756732	
3	3	10	56.6	1259	1658	2.298931	
4	2	10	82.8	1292		3.003357	
5	2	10	98.7	1105		3.652648	
6	1	10	98.2			4.530203	
7	3	10	51.4	1176	1790	4.763725	
8	2	10	57.8	1194		5.348798	
9	2	10	55.9	1347		6.652024	
10	2	10	89.8	1386		6.722529	
11	2	10	71.8	1406		7.340910	
12	2	10	54	1092		8.572369	
13	2	10	53.7	1276		9.149388	
14	2	10	55.2	1179		9.927069	
15	1	10	56.7			10.514632	
16	1	10	81.1			11.217597	
17	3	10	94.1	1061	1326	11.871888	

Statistics 7 (ChirpCenter Frequency: 5496.0 MHz)

Trial #	Pulse	Chirp(MHz)	Pulse Width (μS)	Pulse 1-2 spacing(μS)	Pulse 2-3 spacing(μS)	Pulse Start(S)	Detection (1:yes;0:no)
0	2	14	88	1668		0.422398	1
1	1	14	86.6			1.432082	
2	1	14	53.8			2.479117	
3	1	14	57.1			3.656501	
4	3	14	88.5	1660	1134	4.882746	
5	1	14	64.3			5.203404	
6	3	14	86	1528	1047	6.554714	
7	2	14	81.9	1616		7.729919	
8	2	14	84.7	1644		8.531980	
9	2	14	60.9	1873		9.598149	
10	2	14	76.4	1844		10.303237	
11	1	14	91.2			11.991372	

Statistics 8 (ChirpCenter Frequency: 5493.0 MHz)

Trial #	Pulse	Chirp(MHz)	Pulse Width (μS)	Pulse 1-2 spacing(μS)	Pulse 2-3 spacing(μS)	Pulse Start(S)	Detection (1:yes;0:no)
0	2	7	91.5	1812		0.023887	1
1	2	7	86.4	1026		0.922904	
2	3	7	88.7	1929	1715	2.304566	
3	3	7	88.8	1291	1684	3.262000	
4	2	7	74.3	1648		4.097917	
5	2	7	95.2	1391		5.053691	
6	2	7	62.5	1608		5.554297	
7	1	7	64.5			6.792720	
8	1	7	79.4			7.633760	
9	2	7	73.8	1822		8.184111	
10	3	7	87.7	1995	1764	8.907106	
11	3	7	94.8	1689	1130	9.698628	
12	2	7	71.4	1465		10.696275	
13	1	7	83.2			11.294017	

Statistics 9 (ChirpCenter Frequency: 5494.0 MHz)

Trial #	Pulse	Chirp(MHz)	Pulse Width (μS)	Pulse 1-2 spacing(μS)	Pulse 2-3 spacing(μS)	Pulse Start(S)	Detection (1:yes;0:no)
0	1	10	67.8			1.225812	1
1	3	10	82.9	1214	1399	1.517264	
2	2	10	62.3	1988		3.237278	
3	1	10	78.3			4.527155	
4	3	10	74.4	1527	1160	5.818627	
5	2	10	87	1412		7.149235	
6	2	10	79	1018		8.164029	
7	2	10	84.4	1563		10.380890	
8	3	10	63.7	1486	1079	11.472573	

Statistics 10 (ChirpCenter Frequency: 5495.0 MHz)

Trial #	Pulse	Chirp(MHz)	Pulse Width (μS)	Pulse 1-2 spacing(μS)	Pulse 2-3 spacing(μS)	Pulse Start(S)	Detection (1:yes;0:no)
0	2	13	99.5	1158		0.787670	1
1	3	13	84.4	1321	1104	1.348582	
2	3	13	82.1	1387	1696	1.945870	
3	2	13	52.8	1493		2.482687	
4	1	13	73.5			3.518205	
5	3	13	52.9	1369	1112	4.120872	
6	3	13	92.1	1823	1314	5.283581	
7	2	13	81.4	1748		5.764147	
8	3	13	69.8	1144	1799	6.494078	
9	3	13	56.1	1985	1226	7.405022	
10	2	13	95.5	1311		8.133089	
11	3	13	69.2	1370	1016	9.458234	
12	2	13	77.2	1853		9.800321	
13	2	13	73.7	1254		10.870678	
14	1	13	58.3			11.611614	

Radar Type 5 Case 3 Statistical Performance

Statistics 1 (ChirpCenter Frequency: 5564.0 MHz)

Trial #	Pulse	Chirp(MHz)	Pulse Width (μS)	Pulse 1-2 spacing(μS)	Pulse 2-3 spacing(μS)	Pulse Start(S)	Detection (1:yes;0:no)
0	2	15	52.3	1604		0.857582	1
1	1	15	92.1			1.280511	
2	3	15	86.6	1882	1334	1.921538	
3	2	15	50.3	1032		3.163417	
4	2	15	84.6	1324		4.089201	
5	3	15	95.1	1449	1286	4.651907	
6	1	15	78.7			6.326305	
7	1	15	85.2			6.916204	
8	2	15	77	1178		7.816955	
9	2	15	78.6	1696		8.416799	
10	2	15	77.3	1862		9.395389	
11	2	15	56.9	1397		10.201282	
12	1	15	51.8			11.935827	

Statistics 2 (ChirpCenter Frequency: 5563.0 MHz)

Trial #	Pulse	Chirp(MHz)	Pulse Width (μS)	Pulse 1-2 spacing(μS)	Pulse 2-3 spacing(μS)	Pulse Start(S)	Detection (1:yes;0:no)
0	2	18	85.4	1365		0.443512	1
1	1	18	99.8			1.311352	
2	2	18	73.4	1102		1.378501	
3	3	18	68.5	1513	1604	2.639043	
4	2	18	77.5	1437		3.283959	
5	3	18	55.5	1290	1063	3.809332	
6	3	18	85.2	1034	1134	4.111478	
7	3	18	79.2	1758	1827	4.912052	
8	2	18	91.2	1928		5.837572	
9	2	18	61.8	1770		6.402018	
10	2	18	54.1	1350		6.793911	
11	2	18	59.3	1747		7.339117	
12	1	18	68.7			8.550382	
13	2	18	74.3	1847		8.777003	
14	2	18	85.1	1581		9.800209	
15	2	18	53.6	1573		10.532032	
16	3	18	79	1164	1900	10.750058	
17	3	18	68.1	1297	1379	11.841156	

Statistics 3 (ChirpCenter Frequency: 5568.0 MHz)

Trial #	Pulse	Chirp(MHz)	Pulse Width (μS)	Pulse 1-2 spacing(μS)	Pulse 2-3 spacing(μS)	Pulse Start(S)	Detection (1:yes;0:no)
0	2	6	78	1606		0.397290	1
1	3	6	80.1	1518	1504	1.987628	
2	3	6	90.5	1256	1068	2.423174	
3	2	6	95.5	1376		4.233573	
4	3	6	54.9	1657	1245	5.793631	
5	1	6	84.8			6.342414	
6	1	6	79.4			7.996520	
7	2	6	57	1191		8.889458	
8	2	6	71.9	1981		9.984160	
9	3	6	96.7	1726	1225	11.866912	

Statistics 4 (ChirpCenter Frequency: 5568.0 MHz)

Trial #	Pulse	Chirp(MHz)	Pulse Width (μS)	Pulse 1-2 spacing(μS)	Pulse 2-3 spacing(μS)	Pulse Start(S)	Detection (1:yes;0:no)
0	1	6	68.1			1.113103	1
1	2	6	78.7	1052		1.788416	
2	2	6	59.2	1738		2.738830	
3	1	6	94.2			3.714251	
4	1	6	77.2			5.953842	
5	2	6	55.6	1256		6.863200	
6	2	6	56.2	1490		7.521140	
7	1	6	87.7			8.726800	
8	1	6	84.1			9.849170	
9	2	6	56.6	1324		10.879937	

Statistics 5 (ChirpCenter Frequency: 5565.0 MHz)

Trial #	Pulse	Chirp(MHz)	Pulse Width (μS)	Pulse 1-2 spacing(μS)	Pulse 2-3 spacing(μS)	Pulse Start(S)	Detection (1:yes;0:no)
0	2	13	52	1915		0.170450	1
1	3	13	90.2	1124	1269	0.858506	
2	1	13	63.5			1.424220	
3	3	13	96.3	1144	1957	2.154879	
4	1	13	74.2			2.966346	
5	2	13	69.9	1755		3.761576	
6	3	13	63.1	1322	1137	4.206855	
7	2	13	84.6	1353		4.900985	
8	2	13	80	1965		5.427760	
9	2	13	91.8	1159		6.082906	
10	2	13	82.8	1754		6.859937	
11	3	13	69.8	1972	1857	7.080158	
12	2	13	52.2	1348		7.975701	
13	3	13	76.1	1122	1068	8.580725	
14	2	13	70	1997		9.408971	
15	1	13	51.4			10.001916	
16	2	13	87.8	1114		10.504084	
17	2	13	94.3	1881		11.018882	
18	2	13	61.3	1578		11.912970	

Statistics 6 (ChirpCenter Frequency: 5564.0 MHz)

Trial #	Pulse	Chirp(MHz)	Pulse Width (μS)	Pulse 1-2 spacing(μS)	Pulse 2-3 spacing(μS)	Pulse Start(S)	Detection (1:yes;0:no)
0	3	15	62.4	1570	1651	0.491302	1
1	2	15	59.4	1012		1.060237	
2	3	15	98.9	1186	1597	2.232610	
3	2	15	51.3	1628		2.428373	
4	1	15	78.3			3.692193	
5	2	15	60	1764		4.036411	
6	2	15	67.5	1824		4.997698	
7	2	15	72.5	1331		5.398538	
8	3	15	54.1	1314	1941	6.320971	
9	1	15	91.9			6.921927	
10	3	15	80.8	1365	1913	7.743042	
11	2	15	86	1436		8.314166	
12	2	15	75.9	1650		9.692782	
13	1	15	69.1			10.439522	
14	1	15	98.7			10.960584	
15	3	15	53.8	1139	1782	11.766045	

Statistics 7 (ChirpCenter Frequency: 5567.0 MHz)

Trial #	Pulse	Chirp(MHz)	Pulse Width (μS)	Pulse 1-2 spacing(μS)	Pulse 2-3 spacing(μS)	Pulse Start(S)	Detection (1:yes;0:no)
0	1	8	53.7			0.797056	1
1	2	8	74	1765		2.313306	
2	2	8	83.3	1905		3.654311	
3	2	8	75.6	1263		4.856836	
4	2	8	73.8	1253		6.223533	
5	2	8	84.3	1634		7.610036	
6	2	8	94.5	1849		8.721173	
7	3	8	59.4	1641	1264	9.355219	
8	1	8	73.2			10.782358	

Statistics 8 (ChirpCenter Frequency: 5566.0 MHz)

Trial #	Pulse	Chirp(MHz)	Pulse Width (μS)	Pulse 1-2 spacing(μS)	Pulse 2-3 spacing(μS)	Pulse Start(S)	Detection (1:yes;0:no)
0	2	11	67.2	1073		0.835448	1
1	2	11	97.7	1297		1.744610	
2	2	11	73.9	1675		2.179922	
3	2	11	68.1	1365		3.522055	
4	2	11	90.6	1633		3.871585	
5	2	11	86.6	1511		4.678803	
6	3	11	69.2	1868	1158	5.804965	
7	2	11	54.2	1508		6.675301	
8	2	11	95.4	1834		7.596799	
9	3	11	76.3	1826	1589	9.065504	
10	2	11	87.5	1449		10.086279	
11	1	11	76.1			10.750042	
12	2	11	55.5	1264		11.482938	

Statistics 9 (ChirpCenter Frequency: 5565.0 MHz)

Trial #	Pulse	Chirp(MHz)	Pulse Width (μS)	Pulse 1-2 spacing(μS)	Pulse 2-3 spacing(μS)	Pulse Start(S)	Detection (1:yes;0:no)
0	2	12	53.3	1380		0.585689	1
1	1	12	84.4			0.718207	
2	3	12	64.5	1699	1990	1.918390	
3	3	12	95.7	1164	1194	2.455037	
4	1	12	76.1			2.838670	
5	2	12	60.9	1685		3.387754	
6	2	12	94.7	1207		4.482326	
7	2	12	70.5	1096		4.895327	
8	1	12	74.5			5.589263	
9	2	12	56	1663		6.404830	
10	3	12	77.4	1699	1119	6.963726	
11	1	12	76.1			7.447255	
12	2	12	94.4	1971		8.262468	
13	1	12	88.2			9.255538	
14	1	12	89.7			9.371589	
15	1	12	96.3			10.566397	
16	2	12	60.6	1207		10.764853	
17	1	12	91.7			11.499885	

Statistics 10 (ChirpCenter Frequency: 5565.0 MHz)

Trial #	Pulse	Chirp(MHz)	Pulse Width (μS)	Pulse 1-2 spacing(μS)	Pulse 2-3 spacing(μS)	Pulse Start(S)	Detection (1:yes;0:no)
0	2	13	66.6	1073		0.215675	1
1	3	13	72.5	1625	1581	1.096358	
2	2	13	67.6	1649		2.087602	
3	1	13	62.2			2.793198	
4	2	13	84.9	1653		3.508950	
5	2	13	77.3	1783		4.458635	
6	2	13	91.4	1249		5.000405	
7	3	13	59.2	1119	1979	6.226269	
8	3	13	95.5	1361	1238	7.015336	
9	3	13	69.2	1755	1744	7.629973	
10	3	13	51.1	1103	1877	8.555763	
11	2	13	51.9	1965		9.274128	
12	1	13	91.9			9.831376	
13	2	13	89.3	1755		11.180597	
14	2	13	65.1	1996		11.269830	

Radar Type 6 Statistical Performance

Trial #	Fc (MHz)	Pulse /Burst	Pulse Width (µS)	PRI (µs)	Detection (1:yes; 0:no)	Hopping Sequence (MHz)
1	5530	9	1	333	1	5492.0, 5385.0, 5693.0, 5343.0, 5254.0, 5722.0, 5420.0, 5481.0, 5660.0, 5395.0, 5265.0, 5532.0, 5441.0, 5322.0, 5636.0, 5711.0, 5252.0, 5655.0, 5612.0, 5368.0, 5386.0, 5708.0, 5593.0, 5585.0, 5405.0, 5597.0, 5579.0, 5323.0, 5408.0, 5674.0, 5694.0, 5508.0, 5542.0, 5392.0, 5509.0, 5285.0, 5264.0, 5337.0, 5482.0, 5695.0, 5495.0, 5339.0, 5333.0, 5434.0, 5314.0, 5400.0, 5284.0, 5263.0, 5640.0, 5354.0, 5291.0, 5703.0, 5480.0, 5651.0, 5268.0, 5517.0, 5649.0, 5712.0, 5720.0, 5421.0, 5563.0, 5402.0, 5299.0, 5483.0, 5286.0, 5554.0, 5701.0, 5496.0, 5377.0, 5678.0, 5670.0, 5557.0, 5620.0, 5680.0, 5629.0, 5321.0, 5565.0, 5575.0, 5276.0, 5282.0, 5538.0, 5309.0, 5546.0, 5661.0, 5513.0, 5435.0, 5519.0, 5588.0, 5696.0, 5577.0, 5633.0, 5388.0, 5430.0, 5531.0, 5406.0, 5654.0, 5518.0, 5653.0, 5605.0, 5312.0
2	5530	9	1	333	1	5710.0, 5374.0, 5504.0, 5381.0, 5680.0, 5612.0, 5275.0, 5640.0, 5289.0, 5716.0, 5258.0, 5675.0, 5391.0, 5367.0, 5335.0, 5661.0, 5561.0, 5461.0, 5379.0, 5565.0, 5358.0, 5628.0, 5515.0, 5430.0, 5586.0, 5417.0, 5517.0, 5293.0, 5575.0, 5486.0, 5599.0, 5524.0, 5636.0, 5456.0, 5536.0, 5389.0, 5478.0, 5579.0, 5468.0, 5682.0, 5384.0, 5491.0, 5487.0, 5312.0, 5470.0, 5719.0, 5435.0, 5286.0, 5330.0, 5594.0, 5568.0, 5427.0, 5587.0, 5411.0, 5445.0, 5553.0, 5355.0, 5652.0, 5522.0, 5424.0, 5423.0, 5318.0, 5601.0, 5642.0, 5444.0, 5616.0, 5306.0, 5304.0, 5331.0, 5340.0, 5265.0, 5387.0, 5621.0, 5292.0, 5398.0, 5393.0, 5386.0, 5373.0, 5633.0, 5555.0, 5576.0, 5708.0, 5542.0, 5418.0, 5272.0, 5338.0, 5260.0, 5520.0, 5465.0, 5426.0, 5718.0, 5336.0, 5467.0, 5584.0, 5283.0, 5315.0, 5295.0, 5544.0, 5597.0, 5677.0
3	5530	9	1	333	1	5536.0, 5676.0, 5577.0, 5295.0, 5710.0, 5580.0, 5447.0, 5299.0, 5308.0, 5406.0, 5588.0, 5655.0, 5489.0, 5607.0, 5380.0, 5673.0, 5397.0, 5415.0, 5436.0, 5503.0, 5398.0, 5250.0, 5547.0, 5260.0, 5687.0, 5595.0, 5378.0, 5387.0, 5282.0, 5262.0, 5706.0, 5307.0, 5337.0, 5555.0, 5511.0, 5716.0, 5442.0, 5319.0, 5263.0, 5624.0, 5275.0, 5349.0, 5294.0, 5653.0, 5628.0, 5631.0, 5697.0, 5361.0, 5405.0, 5266.0, 5502.0, 5407.0, 5470.0, 5395.0, 5712.0, 5376.0, 5381.0, 5360.0, 5482.0, 5637.0, 5259.0, 5347.0, 5366.0, 5495.0, 5659.0, 5399.0, 5410.0, 5553.0, 5292.0, 5385.0

						5394.0, 5667.0, 5280.0, 5691.0, 5605.0, 5340.0, 5273.0, 5560.0, 5513.0, 5365.0, 5491.0, 5545.0, 5306.0, 5344.0, 5418.0, 5512.0, 5645.0, 5375.0, 5604.0, 5521.0, 5613.0, 5619.0, 5421.0, 5353.0, 5461.0, 5483.0, 5300.0, 5683.0, 5572.0, 5590.0
4	5530	9	1	333	1	5350.0, 5431.0, 5570.0, 5461.0, 5530.0, 5313.0, 5274.0, 5548.0, 5424.0, 5390.0, 5584.0, 5415.0, 5261.0, 5690.0, 5327.0, 5294.0, 5301.0, 5393.0, 5621.0, 5611.0, 5493.0, 5509.0, 5543.0, 5604.0, 5650.0, 5653.0, 5331.0, 5491.0, 5538.0, 5660.0, 5262.0, 5343.0, 5695.0, 5688.0, 5288.0, 5421.0, 5437.0, 5603.0, 5697.0, 5524.0, 5675.0, 5544.0, 5314.0, 5605.0, 5291.0, 5323.0, 5286.0, 5360.0, 5702.0, 5368.0, 5663.0, 5687.0, 5277.0, 5283.0, 5699.0, 5445.0, 5692.0, 5578.0, 5405.0, 5562.0, 5275.0, 5643.0, 5476.0, 5495.0, 5280.0, 5537.0, 5477.0, 5475.0, 5340.0, 5719.0, 5436.0, 5322.0, 5299.0, 5590.0, 5511.0, 5364.0, 5658.0, 5669.0, 5722.0, 5608.0, 5531.0, 5693.0, 5434.0, 5285.0, 5486.0, 5287.0, 5303.0, 5258.0, 5617.0, 5500.0, 5634.0, 5417.0, 5642.0, 5450.0, 5441.0, 5341.0, 5668.0, 5300.0, 5279.0, 5420.0
5	5530	9	1	333	1	5554.0, 5632.0, 5572.0, 5270.0, 5558.0, 5277.0, 5294.0, 5700.0, 5495.0, 5701.0, 5577.0, 5681.0, 5477.0, 5648.0, 5304.0, 5544.0, 5667.0, 5289.0, 5291.0, 5456.0, 5564.0, 5715.0, 5596.0, 5610.0, 5310.0, 5437.0, 5649.0, 5526.0, 5440.0, 5669.0, 5498.0, 5312.0, 5627.0, 5322.0, 5283.0, 5354.0, 5543.0, 5331.0, 5624.0, 5515.0, 5712.0, 5638.0, 5505.0, 5567.0, 5402.0, 5392.0, 5452.0, 5379.0, 5467.0, 5615.0, 5679.0, 5468.0, 5605.0, 5317.0, 5465.0, 5519.0, 5645.0, 5403.0, 5377.0, 5288.0, 5548.0, 5714.0, 5522.0, 5276.0, 5718.0, 5427.0, 5706.0, 5384.0, 5341.0, 5628.0, 5506.0, 5536.0, 5517.0, 5309.0, 5393.0, 5518.0, 5661.0, 5327.0, 5685.0, 5674.0, 5389.0, 5704.0, 5251.0, 5578.0, 5576.0, 5612.0, 5721.0, 5353.0, 5334.0, 5252.0, 5673.0, 5723.0, 5499.0, 5358.0, 5431.0, 5412.0, 5348.0, 5663.0, 5657.0, 5630.0
6	5530	9	1	333	1	5413.0, 5555.0, 5398.0, 5319.0, 5683.0, 5338.0, 5594.0, 5631.0, 5532.0, 5505.0, 5358.0, 5267.0, 5394.0, 5661.0, 5469.0, 5308.0, 5473.0, 5595.0, 5280.0, 5508.0, 5581.0, 5301.0, 5630.0, 5626.0, 5346.0, 5457.0, 5658.0, 5372.0, 5474.0, 5335.0, 5304.0, 5648.0, 5433.0, 5724.0, 5459.0, 5439.0, 5388.0, 5717.0, 5477.0, 5255.0, 5582.0, 5382.0, 5552.0, 5450.0, 5516.0, 5423.0, 5476.0, 5462.0, 5369.0, 5431.0, 5397.0, 5463.0, 5544.0, 5418.0, 5525.0, 5542.0, 5509.0, 5707.0, 5325.0, 5373.0, 5695.0, 5692.0, 5487.0, 5697.0, 5646.0, 5321.0, 5616.0, 5680.0, 5464.0, 5405.0

						5341.0, 5514.0, 5696.0, 5402.0, 5289.0, 5650.0, 5531.0, 5578.0, 5644.0, 5501.0, 5720.0, 5306.0, 5406.0, 5253.0, 5587.0, 5258.0, 5718.0, 5293.0, 5668.0, 5486.0, 5681.0, 5465.0, 5586.0, 5347.0, 5387.0, 5579.0, 5299.0, 5649.0, 5361.0, 5592.0
7	5530	9	1	333	1	5602.0, 5660.0, 5434.0, 5571.0, 5588.0, 5463.0, 5623.0, 5650.0, 5423.0, 5404.0, 5474.0, 5327.0, 5334.0, 5530.0, 5537.0, 5251.0, 5616.0, 5462.0, 5333.0, 5394.0, 5526.0, 5542.0, 5290.0, 5468.0, 5485.0, 5595.0, 5311.0, 5578.0, 5416.0, 5649.0, 5381.0, 5538.0, 5668.0, 5717.0, 5635.0, 5360.0, 5508.0, 5437.0, 5457.0, 5612.0, 5418.0, 5531.0, 5690.0, 5412.0, 5461.0, 5527.0, 5500.0, 5504.0, 5641.0, 5541.0, 5566.0, 5721.0, 5597.0, 5352.0, 5567.0, 5662.0, 5594.0, 5618.0, 5521.0, 5708.0, 5443.0, 5607.0, 5279.0, 5545.0, 5692.0, 5647.0, 5428.0, 5277.0, 5599.0, 5399.0, 5680.0, 5377.0, 5397.0, 5342.0, 5514.0, 5346.0, 5307.0, 5501.0, 5683.0, 5587.0, 5364.0, 5350.0, 5383.0, 5671.0, 5480.0, 5686.0, 5407.0, 5301.0, 5490.0, 5652.0, 5386.0, 5655.0, 5427.0, 5548.0, 5308.0, 5703.0, 5469.0, 5458.0, 5663.0, 5553.0
8	5530	9	1	333	1	5716.0, 5714.0, 5605.0, 5476.0, 5382.0, 5566.0, 5432.0, 5327.0, 5369.0, 5654.0, 5527.0, 5581.0, 5398.0, 5353.0, 5475.0, 5428.0, 5549.0, 5322.0, 5338.0, 5719.0, 5458.0, 5268.0, 5525.0, 5550.0, 5563.0, 5393.0, 5496.0, 5700.0, 5484.0, 5615.0, 5450.0, 5357.0, 5282.0, 5626.0, 5286.0, 5344.0, 5272.0, 5631.0, 5331.0, 5468.0, 5253.0, 5701.0, 5463.0, 5494.0, 5628.0, 5298.0, 5270.0, 5551.0, 5259.0, 5502.0, 5720.0, 5418.0, 5255.0, 5348.0, 5400.0, 5300.0, 5589.0, 5313.0, 5305.0, 5597.0, 5419.0, 5332.0, 5433.0, 5690.0, 5390.0, 5643.0, 5672.0, 5279.0, 5630.0, 5712.0, 5667.0, 5269.0, 5266.0, 5489.0, 5465.0, 5297.0, 5649.0, 5693.0, 5250.0, 5663.0, 5613.0, 5498.0, 5467.0, 5426.0, 5421.0, 5698.0, 5310.0, 5347.0, 5368.0, 5524.0, 5621.0, 5435.0, 5485.0, 5617.0, 5399.0, 5516.0, 5632.0, 5443.0, 5666.0, 5479.0
9	5530	9	1	333	1	5703.0, 5427.0, 5314.0, 5355.0, 5616.0, 5393.0, 5359.0, 5458.0, 5442.0, 5357.0, 5704.0, 5340.0, 5568.0, 5691.0, 5627.0, 5563.0, 5326.0, 5583.0, 5611.0, 5656.0, 5545.0, 5643.0, 5403.0, 5534.0, 5444.0, 5480.0, 5577.0, 5431.0, 5557.0, 5603.0, 5509.0, 5707.0, 5341.0, 5562.0, 5532.0, 5352.0, 5566.0, 5336.0, 5252.0, 5682.0, 5657.0, 5481.0, 5414.0, 5486.0, 5489.0, 5264.0, 5276.0, 5375.0, 5360.0, 5513.0, 5450.0, 5700.0, 5575.0, 5358.0, 5617.0, 5455.0, 5270.0, 5370.0, 5579.0, 5253.0, 5582.0, 5626.0, 5574.0, 5287.0, 5601.0, 5306.0, 5273.0, 5476.0, 5699.0, 5274.0

						5429.0, 5385.0, 5304.0, 5472.0, 5402.0, 5565.0, 5665.0, 5459.0, 5619.0, 5519.0, 5664.0, 5529.0, 5294.0, 5445.0, 5332.0, 5297.0, 5390.0, 5267.0, 5337.0, 5683.0, 5349.0, 5552.0, 5266.0, 5518.0, 5295.0, 5420.0, 5515.0, 5637.0, 5506.0, 5454.0
10	5530	9	1	333	1	5499.0, 5671.0, 5360.0, 5396.0, 5644.0, 5313.0, 5269.0, 5307.0, 5521.0, 5300.0, 5388.0, 5537.0, 5711.0, 5487.0, 5327.0, 5259.0, 5423.0, 5308.0, 5543.0, 5437.0, 5519.0, 5381.0, 5409.0, 5638.0, 5411.0, 5569.0, 5656.0, 5431.0, 5359.0, 5608.0, 5358.0, 5661.0, 5546.0, 5254.0, 5676.0, 5625.0, 5639.0, 5646.0, 5280.0, 5401.0, 5258.0, 5389.0, 5340.0, 5591.0, 5693.0, 5407.0, 5583.0, 5322.0, 5689.0, 5459.0, 5282.0, 5489.0, 5271.0, 5664.0, 5452.0, 5643.0, 5342.0, 5310.0, 5283.0, 5475.0, 5507.0, 5349.0, 5275.0, 5274.0, 5279.0, 5336.0, 5302.0, 5680.0, 5674.0, 5610.0, 5331.0, 5264.0, 5348.0, 5527.0, 5502.0, 5681.0, 5558.0, 5285.0, 5584.0, 5714.0, 5552.0, 5368.0, 5451.0, 5364.0, 5446.0, 5631.0, 5252.0, 5303.0, 5253.0, 5461.0, 5400.0, 5533.0, 5525.0, 5481.0, 5405.0, 5442.0, 5595.0, 5484.0, 5593.0, 5377.0
11	5530	9	1	333	1	5330.0, 5696.0, 5254.0, 5680.0, 5505.0, 5458.0, 5356.0, 5607.0, 5342.0, 5693.0, 5661.0, 5266.0, 5397.0, 5616.0, 5363.0, 5344.0, 5712.0, 5668.0, 5631.0, 5722.0, 5540.0, 5268.0, 5477.0, 5440.0, 5306.0, 5564.0, 5412.0, 5658.0, 5421.0, 5426.0, 5637.0, 5640.0, 5701.0, 5406.0, 5689.0, 5461.0, 5492.0, 5312.0, 5327.0, 5329.0, 5423.0, 5293.0, 5601.0, 5588.0, 5361.0, 5715.0, 5545.0, 5694.0, 5655.0, 5432.0, 5528.0, 5623.0, 5456.0, 5359.0, 5717.0, 5430.0, 5532.0, 5310.0, 5697.0, 5381.0, 5353.0, 5562.0, 5608.0, 5468.0, 5597.0, 5436.0, 5287.0, 5455.0, 5469.0, 5284.0, 5473.0, 5366.0, 5610.0, 5566.0, 5583.0, 5269.0, 5659.0, 5281.0, 5283.0, 5449.0, 5509.0, 5495.0, 5522.0, 5708.0, 5271.0, 5407.0, 5270.0, 5651.0, 5315.0, 5553.0, 5582.0, 5613.0, 5286.0, 5570.0, 5291.0, 5250.0, 5447.0, 5724.0, 5420.0, 5592.0
12	5530	9	1	333	1	5258.0, 5265.0, 5253.0, 5310.0, 5571.0, 5508.0, 5710.0, 5335.0, 5525.0, 5577.0, 5526.0, 5439.0, 5645.0, 5644.0, 5377.0, 5461.0, 5595.0, 5522.0, 5690.0, 5324.0, 5288.0, 5391.0, 5551.0, 5580.0, 5325.0, 5567.0, 5694.0, 5514.0, 5395.0, 5675.0, 5444.0, 5533.0, 5495.0, 5268.0, 5384.0, 5618.0, 5537.0, 5615.0, 5639.0, 5327.0, 5438.0, 5502.0, 5343.0, 5556.0, 5360.0, 5687.0, 5270.0, 5654.0, 5305.0, 5399.0, 5284.0, 5680.0, 5651.0, 5647.0, 5342.0, 5449.0, 5633.0, 5465.0, 5698.0, 5676.0, 5648.0, 5582.0, 5696.0, 5492.0, 5566.0, 5370.0, 5630.0, 5604.0, 5607.0, 5685.0

						5273.0, 5402.0, 5274.0, 5387.0, 5364.0, 5714.0, 5477.0, 5672.0, 5427.0, 5481.0, 5281.0, 5586.0, 5536.0, 5356.0, 5519.0, 5332.0, 5512.0, 5308.0, 5408.0, 5428.0, 5393.0, 5560.0, 5362.0, 5371.0, 5624.0, 5267.0, 5569.0, 5704.0, 5256.0, 5420.0
13	5530	9	1	333	1	5661.0, 5671.0, 5441.0, 5574.0, 5707.0, 5308.0, 5431.0, 5623.0, 5382.0, 5491.0, 5315.0, 5706.0, 5696.0, 5719.0, 5699.0, 5478.0, 5525.0, 5561.0, 5381.0, 5666.0, 5408.0, 5272.0, 5362.0, 5384.0, 5385.0, 5277.0, 5716.0, 5251.0, 5487.0, 5514.0, 5621.0, 5263.0, 5503.0, 5288.0, 5269.0, 5558.0, 5392.0, 5594.0, 5606.0, 5401.0, 5627.0, 5325.0, 5317.0, 5432.0, 5513.0, 5354.0, 5660.0, 5511.0, 5323.0, 5723.0, 5662.0, 5270.0, 5560.0, 5464.0, 5404.0, 5364.0, 5687.0, 5367.0, 5607.0, 5463.0, 5718.0, 5296.0, 5352.0, 5439.0, 5556.0, 5534.0, 5453.0, 5370.0, 5257.0, 5533.0, 5684.0, 5256.0, 5377.0, 5598.0, 5697.0, 5291.0, 5570.0, 5635.0, 5475.0, 5386.0, 5422.0, 5593.0, 5522.0, 5584.0, 5670.0, 5471.0, 5388.0, 5438.0, 5348.0, 5433.0, 5280.0, 5314.0, 5551.0, 5494.0, 5612.0, 5546.0, 5518.0, 5435.0, 5705.0, 5505.0
14	5530	9	1	333	1	5700.0, 5702.0, 5312.0, 5276.0, 5577.0, 5552.0, 5506.0, 5392.0, 5444.0, 5547.0, 5432.0, 5588.0, 5624.0, 5443.0, 5587.0, 5424.0, 5516.0, 5569.0, 5578.0, 5252.0, 5433.0, 5686.0, 5358.0, 5625.0, 5666.0, 5533.0, 5404.0, 5585.0, 5251.0, 5655.0, 5298.0, 5570.0, 5341.0, 5403.0, 5657.0, 5265.0, 5319.0, 5391.0, 5259.0, 5724.0, 5354.0, 5348.0, 5644.0, 5357.0, 5468.0, 5608.0, 5542.0, 5326.0, 5427.0, 5664.0, 5648.0, 5475.0, 5331.0, 5688.0, 5369.0, 5339.0, 5498.0, 5574.0, 5703.0, 5580.0, 5600.0, 5281.0, 5308.0, 5351.0, 5532.0, 5504.0, 5289.0, 5260.0, 5597.0, 5661.0, 5525.0, 5361.0, 5293.0, 5458.0, 5370.0, 5628.0, 5376.0, 5541.0, 5315.0, 5637.0, 5654.0, 5662.0, 5495.0, 5668.0, 5554.0, 5557.0, 5473.0, 5555.0, 5548.0, 5456.0, 5333.0, 5484.0, 5472.0, 5701.0, 5653.0, 5719.0, 5626.0, 5573.0, 5343.0, 5523.0
15	5530	9	1	333	1	5403.0, 5596.0, 5469.0, 5687.0, 5265.0, 5316.0, 5575.0, 5541.0, 5327.0, 5482.0, 5312.0, 5630.0, 5295.0, 5410.0, 5308.0, 5317.0, 5495.0, 5394.0, 5412.0, 5506.0, 5648.0, 5460.0, 5427.0, 5456.0, 5357.0, 5678.0, 5292.0, 5395.0, 5577.0, 5612.0, 5715.0, 5376.0, 5315.0, 5659.0, 5682.0, 5364.0, 5426.0, 5388.0, 5713.0, 5522.0, 5661.0, 5608.0, 5591.0, 5479.0, 5562.0, 5439.0, 5549.0, 5371.0, 5500.0, 5565.0, 5527.0, 5353.0, 5679.0, 5691.0, 5566.0, 5260.0, 5496.0, 5627.0, 5642.0, 5570.0, 5332.0, 5581.0, 5258.0, 5697.0, 5475.0, 5607.0, 5278.0, 5599.0, 5625.0, 5452.0

						5616.0, 5547.0, 5513.0, 5550.0, 5545.0, 5643.0, 5620.0, 5605.0, 5368.0, 5415.0, 5564.0, 5551.0, 5280.0, 5617.0, 5448.0, 5487.0, 5381.0, 5685.0, 5574.0, 5407.0, 5502.0, 5594.0, 5417.0, 5680.0, 5505.0, 5325.0, 5554.0, 5667.0, 5369.0, 5396.0
16	5530	9	1	333	1	5679.0, 5543.0, 5281.0, 5572.0, 5374.0, 5257.0, 5340.0, 5502.0, 5396.0, 5278.0, 5341.0, 5311.0, 5333.0, 5320.0, 5394.0, 5262.0, 5429.0, 5456.0, 5471.0, 5507.0, 5612.0, 5314.0, 5506.0, 5342.0, 5472.0, 5307.0, 5455.0, 5717.0, 5407.0, 5414.0, 5308.0, 5441.0, 5687.0, 5350.0, 5636.0, 5400.0, 5295.0, 5611.0, 5644.0, 5683.0, 5420.0, 5656.0, 5389.0, 5699.0, 5593.0, 5415.0, 5481.0, 5567.0, 5442.0, 5253.0, 5588.0, 5652.0, 5659.0, 5511.0, 5603.0, 5581.0, 5353.0, 5303.0, 5631.0, 5607.0, 5596.0, 5467.0, 5703.0, 5673.0, 5618.0, 5371.0, 5418.0, 5547.0, 5446.0, 5286.0, 5362.0, 5395.0, 5381.0, 5557.0, 5538.0, 5562.0, 5452.0, 5518.0, 5360.0, 5668.0, 5369.0, 5331.0, 5574.0, 5310.0, 5280.0, 5674.0, 5283.0, 5291.0, 5403.0, 5317.0, 5344.0, 5627.0, 5495.0, 5649.0, 5671.0, 5358.0, 5398.0, 5443.0, 5478.0, 5260.0
17	5530	9	1	333	1	5701.0, 5650.0, 5317.0, 5330.0, 5339.0, 5435.0, 5642.0, 5287.0, 5462.0, 5716.0, 5652.0, 5560.0, 5577.0, 5582.0, 5721.0, 5363.0, 5676.0, 5482.0, 5356.0, 5297.0, 5290.0, 5491.0, 5319.0, 5362.0, 5254.0, 5688.0, 5627.0, 5520.0, 5488.0, 5351.0, 5605.0, 5430.0, 5575.0, 5263.0, 5375.0, 5632.0, 5336.0, 5683.0, 5518.0, 5543.0, 5470.0, 5630.0, 5705.0, 5475.0, 5323.0, 5315.0, 5466.0, 5333.0, 5346.0, 5423.0, 5525.0, 5355.0, 5256.0, 5602.0, 5454.0, 5640.0, 5555.0, 5673.0, 5281.0, 5434.0, 5636.0, 5587.0, 5274.0, 5308.0, 5417.0, 5546.0, 5532.0, 5279.0, 5329.0, 5695.0, 5428.0, 5637.0, 5447.0, 5311.0, 5666.0, 5357.0, 5639.0, 5367.0, 5389.0, 5331.0, 5276.0, 5687.0, 5461.0, 5703.0, 5398.0, 5563.0, 5382.0, 5553.0, 5501.0, 5490.0, 5589.0, 5722.0, 5516.0, 5686.0, 5453.0, 5527.0, 5316.0, 5657.0, 5712.0, 5402.0
18	5530	9	1	333	1	5625.0, 5409.0, 5577.0, 5440.0, 5394.0, 5687.0, 5570.0, 5329.0, 5655.0, 5660.0, 5588.0, 5479.0, 5312.0, 5289.0, 5320.0, 5429.0, 5582.0, 5627.0, 5639.0, 5464.0, 5512.0, 5501.0, 5373.0, 5714.0, 5417.0, 5624.0, 5441.0, 5576.0, 5287.0, 5277.0, 5581.0, 5702.0, 5438.0, 5675.0, 5332.0, 5519.0, 5699.0, 5355.0, 5398.0, 5718.0, 5365.0, 5524.0, 5526.0, 5679.0, 5422.0, 5414.0, 5424.0, 5482.0, 5364.0, 5580.0, 5513.0, 5674.0, 5486.0, 5705.0, 5536.0, 5368.0, 5428.0, 5516.0, 5708.0, 5550.0, 5616.0, 5716.0, 5374.0, 5406.0, 5326.0, 5262.0, 5310.0, 5427.0, 5420.0, 5348.0

						5260.0, 5275.0, 5634.0, 5382.0, 5432.0, 5439.0, 5292.0, 5444.0, 5390.0, 5661.0, 5463.0, 5454.0, 5642.0, 5453.0, 5709.0, 5253.0, 5379.0, 5619.0, 5538.0, 5575.0, 5331.0, 5493.0, 5272.0, 5506.0, 5583.0, 5691.0, 5321.0, 5333.0, 5612.0, 5488.0
19	5530	9	1	333	1	5364.0, 5718.0, 5554.0, 5664.0, 5469.0, 5368.0, 5463.0, 5499.0, 5345.0, 5520.0, 5598.0, 5556.0, 5427.0, 5308.0, 5541.0, 5551.0, 5706.0, 5560.0, 5667.0, 5269.0, 5331.0, 5567.0, 5413.0, 5464.0, 5524.0, 5272.0, 5665.0, 5273.0, 5704.0, 5721.0, 5377.0, 5303.0, 5605.0, 5293.0, 5357.0, 5462.0, 5350.0, 5642.0, 5253.0, 5333.0, 5250.0, 5703.0, 5318.0, 5271.0, 5435.0, 5588.0, 5676.0, 5513.0, 5282.0, 5394.0, 5617.0, 5557.0, 5335.0, 5629.0, 5287.0, 5279.0, 5376.0, 5625.0, 5474.0, 5445.0, 5518.0, 5652.0, 5472.0, 5332.0, 5643.0, 5610.0, 5521.0, 5540.0, 5660.0, 5406.0, 5251.0, 5425.0, 5491.0, 5693.0, 5257.0, 5687.0, 5265.0, 5424.0, 5691.0, 5398.0, 5584.0, 5568.0, 5362.0, 5622.0, 5713.0, 5290.0, 5534.0, 5682.0, 5313.0, 5536.0, 5297.0, 5504.0, 5305.0, 5391.0, 5666.0, 5278.0, 5387.0, 5440.0, 5656.0, 5476.0
20	5530	9	1	333	1	5272.0, 5541.0, 5625.0, 5379.0, 5657.0, 5491.0, 5638.0, 5700.0, 5646.0, 5518.0, 5681.0, 5516.0, 5563.0, 5486.0, 5569.0, 5459.0, 5655.0, 5382.0, 5718.0, 5395.0, 5690.0, 5268.0, 5383.0, 5355.0, 5407.0, 5695.0, 5509.0, 5412.0, 5546.0, 5538.0, 5587.0, 5574.0, 5349.0, 5488.0, 5352.0, 5686.0, 5281.0, 5348.0, 5278.0, 5336.0, 5402.0, 5345.0, 5580.0, 5545.0, 5399.0, 5597.0, 5534.0, 5421.0, 5462.0, 5411.0, 5530.0, 5593.0, 5598.0, 5388.0, 5666.0, 5594.0, 5504.0, 5403.0, 5416.0, 5592.0, 5485.0, 5307.0, 5656.0, 5266.0, 5422.0, 5542.0, 5525.0, 5705.0, 5601.0, 5439.0, 5283.0, 5531.0, 5427.0, 5694.0, 5318.0, 5432.0, 5498.0, 5630.0, 5381.0, 5253.0, 5463.0, 5661.0, 5552.0, 5308.0, 5444.0, 5328.0, 5568.0, 5701.0, 5362.0, 5415.0, 5289.0, 5280.0, 5715.0, 5650.0, 5703.0, 5286.0, 5356.0, 5474.0, 5633.0, 5668.0
21	5530	9	1	333	1	5349.0, 5340.0, 5399.0, 5366.0, 5270.0, 5446.0, 5268.0, 5538.0, 5344.0, 5545.0, 5465.0, 5450.0, 5528.0, 5572.0, 5445.0, 5668.0, 5316.0, 5648.0, 5636.0, 5482.0, 5290.0, 5456.0, 5558.0, 5552.0, 5530.0, 5575.0, 5495.0, 5343.0, 5455.0, 5500.0, 5321.0, 5544.0, 5723.0, 5610.0, 5437.0, 5424.0, 5370.0, 5372.0, 5721.0, 5427.0, 5389.0, 5323.0, 5599.0, 5504.0, 5596.0, 5489.0, 5313.0, 5416.0, 5511.0, 5529.0, 5297.0, 5408.0, 5570.0, 5622.0, 5484.0, 5302.0, 5623.0, 5620.0, 5418.0, 5463.0, 5358.0, 5339.0, 5292.0, 5534.0, 5314.0, 5664.0, 5436.0, 5276.0, 5675.0, 5252.0,

						5342.0, 5458.0, 5647.0, 5394.0, 5470.0, 5554.0, 5608.0, 5714.0, 5326.0, 5286.0, 5373.0, 5705.0, 5413.0, 5523.0, 5517.0, 5324.0, 5377.0, 5642.0, 5536.0, 5360.0, 5364.0, 5310.0, 5617.0, 5431.0, 5535.0, 5669.0, 5524.0, 5501.0, 5485.0, 5600.0
22	5530	9	1	333	1	5270.0, 5322.0, 5272.0, 5450.0, 5539.0, 5720.0, 5253.0, 5718.0, 5702.0, 5376.0, 5665.0, 5394.0, 5708.0, 5641.0, 5505.0, 5690.0, 5599.0, 5590.0, 5700.0, 5579.0, 5422.0, 5362.0, 5611.0, 5629.0, 5338.0, 5512.0, 5315.0, 5709.0, 5277.0, 5606.0, 5636.0, 5570.0, 5369.0, 5610.0, 5662.0, 5424.0, 5439.0, 5301.0, 5653.0, 5293.0, 5317.0, 5372.0, 5278.0, 5703.0, 5448.0, 5252.0, 5299.0, 5389.0, 5445.0, 5290.0, 5383.0, 5602.0, 5431.0, 5412.0, 5594.0, 5582.0, 5587.0, 5585.0, 5687.0, 5462.0, 5580.0, 5722.0, 5471.0, 5461.0, 5569.0, 5677.0, 5666.0, 5576.0, 5421.0, 5638.0, 5713.0, 5670.0, 5479.0, 5563.0, 5300.0, 5628.0, 5280.0, 5388.0, 5704.0, 5515.0, 5382.0, 5598.0, 5657.0, 5458.0, 5262.0, 5405.0, 5286.0, 5691.0, 5564.0, 5339.0, 5504.0, 5645.0, 5508.0, 5626.0, 5550.0, 5574.0, 5506.0, 5409.0, 5649.0, 5686.0
23	5530	9	1	333	1	5605.0, 5672.0, 5651.0, 5440.0, 5308.0, 5490.0, 5688.0, 5507.0, 5673.0, 5698.0, 5656.0, 5620.0, 5544.0, 5565.0, 5595.0, 5637.0, 5310.0, 5570.0, 5548.0, 5677.0, 5415.0, 5351.0, 5463.0, 5498.0, 5650.0, 5645.0, 5709.0, 5531.0, 5272.0, 5296.0, 5302.0, 5273.0, 5581.0, 5301.0, 5357.0, 5278.0, 5396.0, 5541.0, 5696.0, 5442.0, 5433.0, 5255.0, 5661.0, 5398.0, 5590.0, 5612.0, 5285.0, 5406.0, 5583.0, 5714.0, 5304.0, 5706.0, 5671.0, 5475.0, 5718.0, 5556.0, 5592.0, 5653.0, 5606.0, 5254.0, 5417.0, 5305.0, 5441.0, 5560.0, 5523.0, 5604.0, 5459.0, 5647.0, 5353.0, 5293.0, 5282.0, 5464.0, 5326.0, 5432.0, 5298.0, 5547.0, 5704.0, 5450.0, 5355.0, 5707.0, 5252.0, 5354.0, 5486.0, 5385.0, 5693.0, 5287.0, 5629.0, 5519.0, 5359.0, 5546.0, 5271.0, 5627.0, 5602.0, 5689.0, 5720.0, 5420.0, 5557.0, 5501.0, 5496.0, 5522.0
24	5530	9	1	333	1	5412.0, 5504.0, 5545.0, 5279.0, 5626.0, 5394.0, 5502.0, 5716.0, 5251.0, 5374.0, 5510.0, 5613.0, 5348.0, 5539.0, 5542.0, 5398.0, 5647.0, 5457.0, 5531.0, 5572.0, 5646.0, 5501.0, 5405.0, 5491.0, 5319.0, 5454.0, 5444.0, 5330.0, 5359.0, 5435.0, 5614.0, 5698.0, 5290.0, 5362.0, 5604.0, 5451.0, 5720.0, 5297.0, 5655.0, 5637.0, 5459.0, 5696.0, 5586.0, 5608.0, 5264.0, 5709.0, 5715.0, 5592.0, 5340.0, 5711.0, 5507.0, 5547.0, 5644.0, 5395.0, 5577.0, 5453.0, 5662.0, 5384.0, 5583.0, 5518.0, 5327.0, 5355.0, 5524.0, 5575.0, 5257.0, 5364.0, 5277.0, 5718.0, 5481.0, 5333.0

						5484.0, 5580.0, 5574.0, 5495.0, 5419.0, 5342.0, 5581.0, 5492.0, 5353.0, 5341.0, 5694.0, 5660.0, 5331.0, 5276.0, 5526.0, 5360.0, 5373.0, 5628.0, 5306.0, 5261.0, 5411.0, 5554.0, 5703.0, 5691.0, 5410.0, 5636.0, 5535.0, 5256.0, 5633.0, 5328.0
25	5530	9	1	333	1	5413.0, 5452.0, 5296.0, 5694.0, 5309.0, 5653.0, 5258.0, 5696.0, 5591.0, 5363.0, 5357.0, 5375.0, 5403.0, 5435.0, 5379.0, 5288.0, 5522.0, 5707.0, 5487.0, 5705.0, 5460.0, 5472.0, 5266.0, 5470.0, 5301.0, 5276.0, 5463.0, 5547.0, 5618.0, 5270.0, 5359.0, 5261.0, 5719.0, 5412.0, 5714.0, 5551.0, 5664.0, 5491.0, 5710.0, 5704.0, 5646.0, 5286.0, 5509.0, 5465.0, 5404.0, 5560.0, 5565.0, 5656.0, 5588.0, 5361.0, 5345.0, 5534.0, 5295.0, 5599.0, 5323.0, 5550.0, 5274.0, 5716.0, 5458.0, 5600.0, 5303.0, 5489.0, 5640.0, 5390.0, 5632.0, 5590.0, 5567.0, 5285.0, 5401.0, 5388.0, 5720.0, 5637.0, 5549.0, 5571.0, 5623.0, 5566.0, 5324.0, 5320.0, 5581.0, 5474.0, 5562.0, 5467.0, 5377.0, 5518.0, 5561.0, 5517.0, 5409.0, 5684.0, 5402.0, 5679.0, 5658.0, 5594.0, 5553.0, 5649.0, 5292.0, 5408.0, 5485.0, 5394.0, 5486.0, 5650.0
26	5530	9	1	333	1	5545.0, 5474.0, 5261.0, 5319.0, 5607.0, 5596.0, 5718.0, 5706.0, 5621.0, 5385.0, 5337.0, 5478.0, 5598.0, 5547.0, 5608.0, 5360.0, 5665.0, 5616.0, 5518.0, 5617.0, 5595.0, 5579.0, 5534.0, 5686.0, 5654.0, 5652.0, 5332.0, 5499.0, 5516.0, 5404.0, 5555.0, 5447.0, 5328.0, 5721.0, 5501.0, 5300.0, 5705.0, 5492.0, 5283.0, 5277.0, 5438.0, 5313.0, 5666.0, 5455.0, 5294.0, 5336.0, 5322.0, 5295.0, 5424.0, 5615.0, 5263.0, 5403.0, 5541.0, 5422.0, 5632.0, 5645.0, 5365.0, 5566.0, 5505.0, 5405.0, 5443.0, 5613.0, 5522.0, 5683.0, 5593.0, 5649.0, 5679.0, 5292.0, 5578.0, 5432.0, 5704.0, 5572.0, 5352.0, 5287.0, 5253.0, 5567.0, 5581.0, 5420.0, 5602.0, 5469.0, 5630.0, 5663.0, 5519.0, 5453.0, 5410.0, 5309.0, 5318.0, 5636.0, 5406.0, 5693.0, 5339.0, 5569.0, 5619.0, 5252.0, 5310.0, 5542.0, 5559.0, 5353.0, 5380.0, 5369.0
27	5530	9	1	333	1	5359.0, 5652.0, 5484.0, 5582.0, 5470.0, 5609.0, 5651.0, 5663.0, 5628.0, 5535.0, 5578.0, 5481.0, 5405.0, 5402.0, 5364.0, 5697.0, 5532.0, 5633.0, 5308.0, 5342.0, 5689.0, 5331.0, 5398.0, 5266.0, 5478.0, 5353.0, 5376.0, 5443.0, 5659.0, 5380.0, 5588.0, 5399.0, 5417.0, 5360.0, 5622.0, 5522.0, 5457.0, 5639.0, 5640.0, 5345.0, 5288.0, 5332.0, 5475.0, 5568.0, 5251.0, 5253.0, 5441.0, 5587.0, 5536.0, 5693.0, 5576.0, 5666.0, 5554.0, 5442.0, 5303.0, 5695.0, 5678.0, 5544.0, 5631.0, 5473.0, 5267.0, 5384.0, 5672.0, 5518.0, 5299.0, 5259.0, 5468.0, 5312.0, 5567.0, 5388.0,

						5720.0, 5685.0, 5285.0, 5438.0, 5694.0, 5523.0, 5311.0, 5656.0, 5260.0, 5688.0, 5337.0, 5358.0, 5349.0, 5556.0, 5344.0, 5691.0, 5598.0, 5289.0, 5553.0, 5335.0, 5670.0, 5613.0, 5350.0, 5711.0, 5572.0, 5477.0, 5446.0, 5397.0, 5415.0, 5723.0
28	5530	9	1	333	1	5528.0, 5359.0, 5541.0, 5251.0, 5716.0, 5334.0, 5524.0, 5448.0, 5648.0, 5577.0, 5457.0, 5366.0, 5266.0, 5682.0, 5487.0, 5383.0, 5342.0, 5350.0, 5424.0, 5472.0, 5488.0, 5416.0, 5635.0, 5632.0, 5539.0, 5318.0, 5501.0, 5259.0, 5532.0, 5476.0, 5653.0, 5721.0, 5437.0, 5462.0, 5625.0, 5499.0, 5427.0, 5449.0, 5598.0, 5666.0, 5525.0, 5367.0, 5283.0, 5485.0, 5470.0, 5605.0, 5643.0, 5425.0, 5545.0, 5618.0, 5664.0, 5253.0, 5556.0, 5627.0, 5467.0, 5311.0, 5690.0, 5340.0, 5652.0, 5497.0, 5661.0, 5516.0, 5265.0, 5422.0, 5686.0, 5502.0, 5471.0, 5413.0, 5426.0, 5697.0, 5461.0, 5273.0, 5658.0, 5660.0, 5474.0, 5581.0, 5522.0, 5454.0, 5274.0, 5506.0, 5353.0, 5619.0, 5288.0, 5349.0, 5688.0, 5323.0, 5493.0, 5639.0, 5411.0, 5377.0, 5572.0, 5387.0, 5258.0, 5414.0, 5631.0, 5268.0, 5374.0, 5544.0, 5313.0, 5269.0
29	5530	9	1	333	1	5334.0, 5453.0, 5286.0, 5613.0, 5503.0, 5602.0, 5586.0, 5600.0, 5537.0, 5598.0, 5270.0, 5340.0, 5605.0, 5476.0, 5517.0, 5620.0, 5522.0, 5644.0, 5497.0, 5316.0, 5385.0, 5648.0, 5291.0, 5458.0, 5548.0, 5623.0, 5491.0, 5516.0, 5697.0, 5484.0, 5514.0, 5681.0, 5533.0, 5255.0, 5651.0, 5281.0, 5253.0, 5467.0, 5604.0, 5658.0, 5278.0, 5610.0, 5425.0, 5355.0, 5444.0, 5594.0, 5700.0, 5568.0, 5711.0, 5468.0, 5435.0, 5557.0, 5302.0, 5416.0, 5699.0, 5508.0, 5504.0, 5311.0, 5409.0, 5400.0, 5500.0, 5464.0, 5294.0, 5335.0, 5527.0, 5550.0, 5621.0, 5432.0, 5674.0, 5312.0, 5405.0, 5309.0, 5561.0, 5526.0, 5573.0, 5486.0, 5636.0, 5565.0, 5485.0, 5507.0, 5318.0, 5339.0, 5287.0, 5263.0, 5429.0, 5428.0, 5611.0, 5369.0, 5327.0, 5323.0, 5457.0, 5701.0, 5430.0, 5551.0, 5317.0, 5380.0, 5529.0, 5328.0, 5580.0, 5391.0
30	5530	9	1	333	1	5403.0, 5351.0, 5481.0, 5680.0, 5613.0, 5537.0, 5262.0, 5450.0, 5340.0, 5440.0, 5282.0, 5656.0, 5476.0, 5482.0, 5683.0, 5446.0, 5632.0, 5578.0, 5508.0, 5666.0, 5267.0, 5322.0, 5579.0, 5342.0, 5419.0, 5722.0, 5254.0, 5393.0, 5621.0, 5494.0, 5260.0, 5432.0, 5277.0, 5585.0, 5618.0, 5534.0, 5344.0, 5686.0, 5568.0, 5695.0, 5366.0, 5693.0, 5431.0, 5592.0, 5329.0, 5412.0, 5425.0, 5599.0, 5276.0, 5489.0, 5682.0, 5576.0, 5640.0, 5259.0, 5314.0, 5255.0, 5315.0, 5399.0, 5584.0, 5549.0, 5289.0, 5608.0, 5500.0, 5266.0, 5676.0, 5487.0, 5358.0, 5460.0, 5327.0, 5270.0

						5531.0, 5463.0, 5253.0, 5616.0, 5525.0, 5499.0, 5505.0, 5510.0, 5675.0, 5572.0, 5437.0, 5296.0, 5498.0, 5524.0, 5311.0, 5442.0, 5355.0, 5361.0, 5352.0, 5430.0, 5604.0, 5433.0, 5554.0, 5658.0, 5448.0, 5492.0, 5606.0, 5652.0, 5477.0, 5356.0
--	--	--	--	--	--	---

BRIDGE AND/OR MESH MODE

Test Standard:

Networks Access Points with Bridge and/or MESH modes of operation are permitted to operate in the DFS bands but must employ a DFS function. The functionality of the Bridge mode as specified in §15.403(a) must be validated in the DFS test report. Devices operating as relays where they act as master and client must also employ DFS function for the master. The method used to validate the functionality must be documented and validation data must be documented. Bridge mode can be validated by performing a test statistical performance check (Section 7.8.4) on any one of the radar types. This is an abbreviated test to verify DFS functionality. MESH mode operational methodology must be submitted in the application for certification for evaluation by the FCC.

Test Result:**Test Mode: Bridge**

Compliance, please refer the the below data.

5520MHz**Radar Type 2 Statistical Performance**

Trial #	Fc (MHz)	Pulse/Burst	Pulse Width (μS)	PRI (μs)	Detection (1:yes; 0:no)
1	5520	24	4.4	193	1
2	5520	25	2.5	220	0
3	5520	28	3.3	227	1
4	5520	27	3	175	1
5	5520	26	3.2	182	1
6	5520	24	2.9	215	1
7	5520	26	1.8	229	1
8	5520	23	3.1	175	1
9	5520	27	1.3	150	1
10	5520	28	4.6	167	1
11	5520	25	4.2	155	1
12	5520	29	3.4	218	1
13	5520	24	1.8	191	1
14	5520	27	4.9	219	1
15	5520	24	1.6	192	1
16	5520	24	1.5	224	1
17	5520	24	3.1	208	1
18	5520	27	4.9	211	1
19	5520	25	4.7	195	1
20	5520	24	4.3	171	1
21	5520	28	1.9	158	1
22	5520	26	1.5	225	1
23	5520	29	3	197	1
24	5520	24	3.9	189	1
25	5520	25	4.6	206	1
26	5520	27	4.1	156	1
27	5520	26	3	230	1
28	5520	23	2.7	200	1
29	5520	23	1.6	180	1
30	5520	24	4.3	171	1
Detection Percentage: 96.7 % (>60%)					

******* END OF REPORT *******