

FCC PART 15.247 & 15.407



EMI MEASUREMENT AND TEST REPORT

For

Proxim Corporation

935 Stewart Drive, Sunnyvale,
CA 94085, USA

FCC ID: HZB-MP11R-ABG

This Report Concerns: <input checked="" type="checkbox"/> Original Report	Equipment Type: 802.11a/b/g Wireless Access Point
Test Engineer:  Ming Jing / Ling Zhang	
Report No.: R0407141	
Report Date: 2004-09-24	
Reviewed By: Hang Tan 	
Prepared By: Bay Area Compliance Laboratory Corporation (BACL) 230 Commercial Street Sunnyvale, CA 94085 Tel: (408) 732-9162 Fax: (408) 732 9164	

Note: The test report is specially limited to the use of the above client company and the product model only. It may not be duplicated without prior written consent of Bay Area Compliance Laboratory Corporation. This report **must not** be used by the client to claim product certification, approval, or endorsement by NVLAP, NIST or any agency of the U.S. Government.

TABLE OF CONTENTS

FCC PART 15.247 & 15.407	1
GENERAL INFORMATION.....	4
PRODUCT DESCRIPTION FOR EQUIPMENT UNDER TEST (EUT)	4
OBJECTIVE	4
RELATED SUBMITTAL(S)/GRANT(S).....	4
TEST METHODOLOGY	4
TEST FACILITY	4
SYSTEM TEST CONFIGURATION.....	6
JUSTIFICATION	6
EUT EXERCISE SOFTWARE.....	6
SPECIAL ACCESSORIES.....	6
SCHEMATICS / BLOCK DIAGRAM	6
EQUIPMENT MODIFICATIONS	6
SUPPORT EQUIPMENT LIST AND DETAILS	6
EXTERNAL I/O CABLING LIST AND DETAILS	6
POWER SUPPLY INFORMATION.....	6
CONFIGURATION OF TEST SYSTEM	7
TEST SETUP BLOCK DIAGRAM.....	7
SUMMARY OF TEST RESULTS	8
§15.203 - ANTENNA REQUIREMENT.....	9
STANDARD APPLICABLE	9
§15.205, §15.209(A), §15.407(B)(5), §15.407(B)(6) - SPURIOUS RADIATED EMISSION.....	10
MEASUREMENT UNCERTAINTY	10
EUT SETUP.....	11
SPECTRUM ANALYZER SETUP	11
TEST EQUIPMENT LIST AND DETAILS.....	11
TEST PROCEDURE	12
CORRECTED AMPLITUDE & MARGIN CALCULATION	12
SUMMARY OF TEST RESULTS	12
2.4GHZ TEST DATA WITH ANTENNA 2415LT.....	19
2.4GHZ TEST DATA WITH ANTENNA Z483	23
2.4GHZ TEST DATA WITH ANTENNA 26WT-2400F.....	27
2.4GHZ TEST DATA WITH ANTENNA 2443LT.....	31
2.4GHZ TEST DATA WITH ANTENNA 2449LT.....	35
5.25 – 5.35GHZ ONLY, TEST DATA WITH ANTENNA 523360	39
5.725 – 5.825GHZ ONLY, TEST DATA WITH ANTENNA 583360	41
5GHZ TEST DATA WITH ANTENNA FPA5350D24-N	43
5GHZ TEST DATA WITH ANTENNA R0320-100	47
5GHZ TEST DATA WITH ANTENNA R0320-101	51
5GHZ TEST DATA WITH ANTENNA P3F-52.....	55
5GHZ TEST DATA WITH ANTENNA MA-WA58-1X.....	59
2.4 GHZ TEST DATA WITH ANTENNA MA-WA24-1XP.....	63
§15.207(A) - CONDUCTED EMISSIONS.....	67
MEASUREMENT UNCERTAINTY	67
EUT SETUP.....	67
SPECTRUM ANALYZER SETUP	67
TEST EQUIPMENT LIST AND DETAILS.....	67
TEST PROCEDURE	67
SUMMARY OF TEST RESULTS	68
CONDUCTED EMISSIONS TEST DATA	68
PLOT OF CONDUCTED EMISSIONS TEST DATA	68

§15.209(A) - SPURIOUS EMISSION71
 STANDARD APPLICABLE71
 MEASUREMENT PROCEDURE.....71
 EQUIPMENT LISTS71
 MEASUREMENT RESULT72

§15.247(A)(2) & §15.407 – 6 DB BANDWIDTH AND 26 DB BANDWIDTH.....87
 STANDARD APPLICABLE87
 MEASUREMENT PROCEDURE.....87
 EQUIPMENT LISTS87
 MEASUREMENT RESULT87

§15.247(B)(3), §15.407(A)(2) - RF OUTPUT POWER MEASUREMENT95
 STANDARD APPLICABLE95
 MEASUREMENT PROCEDURE.....95
 EQUIPMENT LISTS95
 MEASUREMENT RESULT96

§15.247(C) - 100 KHZ BANDWIDTH OF BAND EDGES98
 STANDARD APPLICABLE98
 MEASUREMENT PROCEDURE.....98
 EQUIPMENT LISTS98
 MEASURE RESULTS.....99

§15.247(D) & §15.407(A)(2) - POWER SPECTRAL DENSITY105
 STANDARD APPLICABLE105
 MEASUREMENT PROCEDURE.....105
 EQUIPMENT LISTS105
 MEASUREMENT RESULTS.....106

§15.407(A)(6) - PEAK EXCURSION TO AVERAGE RATIO114
 STANDARD APPLICABLE114
 TEST PROCEDURE114
 EQUIPMENT LISTS114
 TEST RESULT FOR114

§15.407(B) - OUT OF BAND EMISSION117
 STANDARD APPLICABLE117
 TEST PROCEDURE117
 EQUIPMENT LISTS117
 TEST RESULT117

15.407(C) - DISCONTINUE TRANSMITTING WITH ABSENCE OF DATA OR OPERATIONAL FAILURE119

§15.407(G) - FREQUENCY STABILITY120
 STANDARD APPLICABLE120
 TEST EQUIPMENT LIST AND DETAILS.....120
 MEASUREMENT RESULT120

GENERAL INFORMATION

Product Description for Equipment Under Test (EUT)

The *Proxim Corporation's*, FCC ID: *HZB-MP11R-ABG*, model number: *5054-XXXX-XXX-XXXXX; 2411-XXXX-XXX-XXXXX; 2454-XXXX-XXX-XXXXX* ['X' fields used to designate product type (Base Station/BSU, Subscriber Unit/SU, or Residential Subscriber Unit/RSU), and country SKUs.] or the "EUT" as referred to in this report is a Tsunami MP .11x Outdoor Wireless OFDM Point To Multi Point System. The EUT is a composite device of DTS and NII. For the DTS part (802.11a/b/g), the frequency range is 2412.00 – 2462.00 MHz (for 802.11b/g), maximum output power is 102.8mW & 5745.00 – 5850.00 MHz (for 802.11a), maximum output power is 71.61mW. For the NII part (802.11a), the frequency range is 5280.00 – 5320.00 MHz, maximum output power is 39.99mW.

** The test data gathered are from production sample, serial number: 00022, provided by the manufacturer.*

Objective

This type approval report is prepared on behalf of *Proxim Corporation* in accordance with Part 2, Subpart J, Part 15, Subparts A, C, and E of the Federal Communication Commissions rules.

The objective of the manufacturer is to demonstrate compliance with FCC rules for Output Power, Antenna Requirements, 6 dB Bandwidth and 26 dB Bandwidth, power spectral density, 100 kHz Bandwidth of Band Edges Measurement, Out of Band Emission, Spurious Emission, Conducted and Spurious Radiated Emission, Discontinue Transmitting with Absence of Data or Operational Failure, Peak Excursion to Average Ratio and Frequency Stability.

Related Submittal(s)/Grant(s)

No Related Submittals.

Test Methodology

All measurements contained in this report were conducted with ANSI C63.4-2001, American National Standard for Methods of Measurement of Radio-Noise Emissions from Low-Voltage Electrical and Electronic Equipment in the range of 9 kHz to 40 GHz.

All radiated and conducted emissions measurement was performed at Bay Area Compliance Laboratory, Corp. The radiated testing was performed at an antenna-to-EUT distance of 3 meters.

Test Facility

The Open Area Test site used by BACL to collect radiated and conducted emission measurement data is located in the back parking lot of the building at 230 Commercial Street, Sunnyvale, California, USA.

Test site at BACL has been fully described in reports submitted to the Federal Communication Commission (FCC) and Voluntary Control Council for Interference (VCCI). The details of these reports has been found to be in compliance with the requirements of Section 2.948 of the FCC Rules on February 11 and December 10, 1997 and Article 8 of the VCCI regulations on December 25, 1997. The facility also complies with the radiated and AC line conducted test site criteria set forth in ANSI C63.4-2001.

The Federal Communications Commission and Voluntary Control Council for Interference has the reports on file and is listed under FCC file 31040/SIT 1300F2 and VCCI Registration No.: C-1298 and R-1234. The test site has been approved by the FCC and VCCI for public use and is listed in the FCC Public Access Link (PAL) database.

Additionally, BACL is a National Institute of Standards and Technology (NIST) accredited laboratory, under the National Voluntary Laboratory Accredited Program (Lab Code 200167-0). The scope of the accreditation covers the FCC Method – 47 CFR Part – Digital Devices, CISPER 22: 1997: Electromagnetic Interference – Limits and Methods of Measurement of Information Technology Equipment test methods.

SYSTEM TEST CONFIGURATION

Justification

The host system was configured for testing according to ANSI C63.4-2001.

The EUT was tested in the normal (native) operating mode to represent *worst-case* results during the final qualification test.

EUT Exercise Software

The EUT exercise program used during radiated and conducted testing was designed to exercise the system components in a manner similar to a typical use. The test software, provided by the customer, is started the Windows terminal program under the Windows 98/2000/ME/XP operating system.

Once loaded, set the Tx channel to low, mid and high for testing.

Special Accessories

As shown in following test setup block diagram, all interface cables used for compliance testing are shielded. The host PC and the peripherals featured shielded metal connectors.

Schematics / Block Diagram

Please refer to Appendix A.

Equipment Modifications

No modifications were made to the EUT.

Support Equipment List and Details

Manufacturer	Description	Model	Serial Number	FCC ID
Dell	Laptop PC	PP05	N/A	N/A

External I/O Cabling List and Details

Cable Description	Length (M)	Port/From	To
Shield Cable	1.0	RJ45 Port / EUT	RJ45 Port / Laptop PC
Shield Cable	1.0	RS232 Port / EUT	RS232 Port / Laptop PC
Shield RF Cable	1.0	RF Port / EUT	Antenna

Power Supply Information

Manufacturer	Description	Model	Serial Number	FCC ID
Proxim	AC/DC Adaptor	DSA0151F	None	None

Configuration of Test System

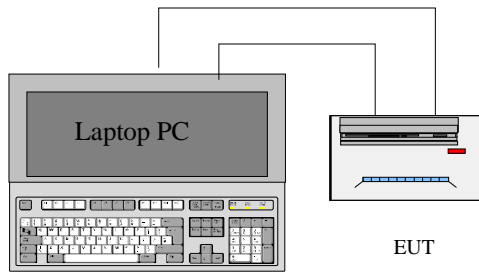

Test Setup Block Diagram

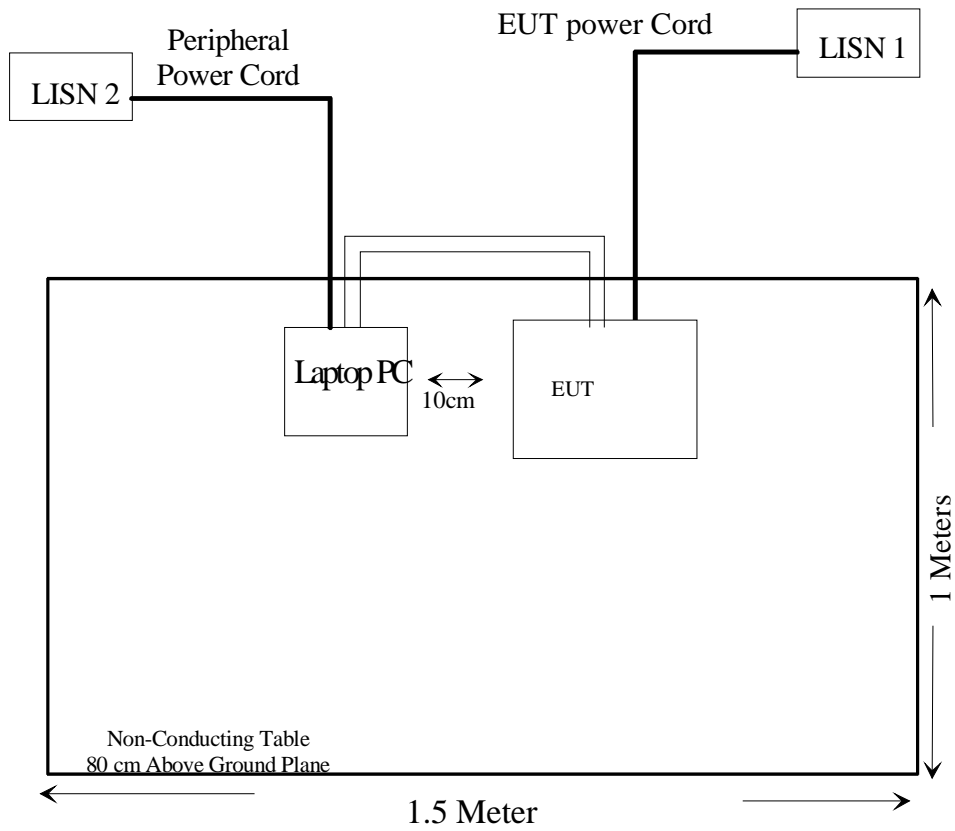

SUMMARY OF TEST RESULTS

Results reported relate only to the product tested, serial number: 00012.

FCC RULES	DESCRIPTION OF TEST	RESULT
§2.1093, §15.247(b)(4), §15.407 (f)	RF Exposure Requirement	Compliant
§15.203	Antenna Requirement	Compliant
§ 15.205, §15.209(a), §15.407(b)(5), §15.407(b)(6)	Restricted Bands, Radiated Emission	Compliant
§ 15.207(a)	AC Line Conduction	Compliant
§15.247(a)(2), §15.407	6 dB Bandwidth & 26 dB Bandwidth	Compliant
§15.247(b)(3), §15.407(a)(2)	RF Output Power	Compliant
§ 15.247(c)	100 kHz Bandwidth of Frequency Band Edge	Compliant
§15.247(d), §15.407(a)(2)	Peak Power Spectral Density	Compliant
§15.407(a)(6)	Peak Excursion	Compliant
§15.407(b)	Out of Band Emission	Compliant
§15.407(c)	Discontinue Transmitting with Absence of Data or Operational Failure	Compliant
§ 15.407(g)	Frequency Stability	Compliant

§15.203 - ANTENNA REQUIREMENT

Standard Applicable

For intentional device, according to § 15.203, an intentional radiator shall be designed to ensure that no antenna other than that furnished by the responsible party shall be used with the device.

And according to § 15.247 (1), if transmitting antennas of directional gain greater than 6 dBi are used the power shall be reduced by the amount in dB that the directional gain of the antenna exceeds 6 dBi.

There are 13 antennas tested with the EUT to represent the worst case. They are listed as follows:

Frequency	Type	Gain (dBi)	Model
2.4GHz	Omni	5	2449LT
	Omni	10	Z483
	Yagi	14	2415LT
	Parabol	24	26WT-2400F
	Panel	12	2443LT
	Integrated Panel	17	MA-WA24-1XP
5G Hz	Omni (5250 – 5350 MHz)	13	523360
	Omni (5725 – 5875 MHz)	13	583360
	Panel	28.2	FPA5350D24-N
	Sector	17	R0320-100
	Omni	8	R0320-101
	Parabol	33.4	P3F-52
	Integrated Panel	23	MA-WA58-1X

§15.205, §15.209(a), §15.407(b)(5), §15.407(b)(6) - SPURIOUS RADIATED EMISSION

Measurement Uncertainty

All measurements involve certain levels of uncertainties. The factors contributing to uncertainties are spectrum analyzer, cable loss, antenna factor calibration, antenna directivity, antenna factor variation with height, antenna phase center variation, antenna factor frequency interpolation, measurement distance variation, site imperfections, mismatch (average), and system repeatability.

Based on NIS 81, The Treatment of Uncertainty in EMC Measurements, the best estimate of the uncertainty of a radiation emissions measurement at BA CL is ± 4.0 dB.

According to §15.205, except as shown in paragraph (d) of this section, only spurious emissions are permitted in any of the frequency bands listed below:

MHz	MHz	MHz	GHz
0.090 – 0.110	16.42 – 16.423	399.9 – 410	4.5 – 5.15
¹ 0.495 – 0.505	16.69475 – 16.69525	608 – 614	5.35 – 5.46
2.1735 – 2.1905	16.80425 – 16.80475	960 – 1240	7.25 – 7.75
4.125 – 4.128	25.5 – 25.67	1300 – 1427	8.025 – 8.5
4.17725 – 4.17775	37.5 – 38.25	1435 – 1626.5	9.0 – 9.2
4.20725 – 4.20775	73 – 74.6	1645.5 – 1646.5	9.3 – 9.5
6.215 – 6.218	74.8 – 75.2	1660 – 1710	10.6 – 12.7
6.26775 – 6.26825	108 – 121.94	1718.8 – 1722.2	13.25 – 13.4
6.31175 – 6.31225	123 – 138	2200 – 2300	14.47 – 14.5
8.291 – 8.294	149.9 – 150.05	2310 – 2390	15.35 – 16.2
8.362 – 8.366	156.52475 – 156.52525	2483.5 – 2500	17.7 – 21.4
8.37625 – 8.38675	156.7 – 156.9	2655 – 2900	22.01 – 23.12
8.41425 – 8.41475	162.0125 – 167.17	3260 – 3267	23.6 – 24.0
12.29 – 12.293	167.72 – 173.2	3332 – 3339	31.2 – 31.8
12.51975 – 12.57725	240 – 285	3345.8 – 3358	36.43 – 36.5
13.36 – 13.41	322 – 335.4	3600 – 4400	(²)

¹ Until February 1, 1999, this restricted band shall be 0.490-0.510MHz

² Above 38.6

Except as provided in paragraph (d) and (e), the filed strength of emissions appearing within these frequency bands shall not exceed the limits shown in Section 15.209. At frequencies equal to or less than 1000MHz, compliance with the limits in Section 15.209 shall be demonstrated using measurement instrumentation employing a CISPR quasi-peak detector. Above 1000MHz, compliance with the emission limits in Section 15.209 shall be demonstrated based on the average value of the measured emissions. The provisions in Section 15.35 apply to these measurements.

According to §15.209, the device shall meet radiated emission general requirements.

Except for Class A device, the filed strength of radiated emissions from unintentional radiators at a distance of 3 meters shall not exceed the following values:

Frequency of Emission (MHz)	Field Strength (Microvolts/meter)	dB (dB μ V/meter)
30 - 88	100	40
88 - 216	150	43.5
216 - 960	200	46
Above 960	500	54

EUT Setup

The radiated emission tests were performed in the open area 3-meter test site, using the setup in accordance with ANSI C63.4-2001. The specification used was the FCC 15 Subpart C limits.

The spacing between the peripherals was 10 centimeters.

External I/O cables were draped along the edge of the test table and bundle as required.

The host PC system was connected with 120Vac/60Hz power source.

Spectrum Analyzer Setup

According to FCC CFR 47, Section 15.31, the EUT was tested to 40GHz.

During the radiated emission test, the spectrum analyzer was set with the following configurations:

<i>Frequency Range</i>	<i>RBW</i>	<i>Video B/W</i>
Below 30MHz	10kHz	10kHz
30 – 1000MHz	100kHz	100kHz
Above 1000MHz	1MHz	1MHz

Test Equipment List and Details

Manufacturer	Description	Model	Serial Number	Cal. Date
HP	Adapter, Quasi-Peak	85650A	3019A05393	6/13/2004
HP	Analyzer, Spectrum , RF	8568B	2601A02165,	7/7/2004
HP	Analyzer, Spectrum, Display	85662A	2542A12015	7/7/2004
HP	Analyzer, Spectrum	8565EC	3946A00131	6/30/2004
Agilent	Amplifier, Pre	8447D	2944A10187	9/23/2004
HP	Amplifier, Pre, microwave	8449B	3147A00400	3/14/2004
EMCO	Antenna, Biconical	3110B	9309-1165	10/11/2003
EMCO	Antenna, Logperiodic	3146	2101	11/8/2003
A. H. Systems	Antenna, Horn, DRG	SAS-200/571	2455-261	8/1/2004

* **Statement of Traceability: BACL Corp.** attests that all calibrations have been performed per the NVLAP requirements, traceable to the NIST.

Test Procedure

For the radiated emissions test, the PC system power cord was connected to the AC floor outlet since the power supply used in the EUT did not provide an accessory power outlet.

Maximizing procedure was performed on the six (6) highest emissions to ensure EUT compliance is with all installation combinations. All data was recorded in the peak detection mode. Quasi-peak readings was performed only when an emission was found to be marginal (within -4 dB μ V of specification limits), and are distinguished with a "Qp" in the data table.

For average measurement, the spectrum analyzer was set as RBW = 1MHz, VBW = 10Hz.

Corrected Amplitude & Margin Calculation

The Corrected Amplitude is calculated by adding the Antenna Factor and Cable Factor, and subtracting the Amplifier Gain from the Amplitude reading. The basic equation is as follows:

$$\text{Corr. Ampl.} = \text{Indicated Reading} + \text{Antenna Factor} + \text{Cable Factor} - \text{Amplifier Gain}$$

The "**Margin**" column of the following data tables indicates the degree of compliance with the applicable limit. For example, a margin of -7dB μ V means the emission is 7dB μ V below the maximum limit for Subpart C. The equation for margin calculation is as follows:

$$\text{Margin} = \text{Corr. Ampl.} - \text{Subpart C Limit}$$

Summary of Test Results

Environmental Conditions

Temperature:	28° C
Relative Humidity:	37%
ATM Pressure:	1032 mbar

The testing was performed by Ming Jing on 2004-08-21.

According to the data in following tables, the EUT complied with the FCC Title 47, Part 15, Subpart C, section 15.205, 15.207 and 15.247, and had the worst margin of:

2.4GHz Antenna 2415LT

802.11b, 15.247

-14.5 dB at 4824.00 MHz in the **Vertical** polarization, Low Channel

-14.6 dB at 4884.00 MHz in the **Vertical** polarization, Middle Channel

-16.8 dB at 2485.00 MHz in the **Vertical** polarization, High Channel

-7.1 dB at 80.52 MHz in the **Horizontal** polarization, unintentional emission

802.11g, 15.247

-13.3 dB at 2390.00 MHz in the **Vertical** polarization, Low Channel

-14.5 dB at 4884.00 MHz in the **Vertical** polarization, Middle Channel

-15.5 dB at **2485.00 MHz** in the **Vertical** polarization, High Channel

-7.3 dB at **80.52 MHz** in the **Horizontal** polarization, unintentional emission

2.4GHz Antenna Z483

802.11b, 15.247

-14.3 dB at **4824.00 MHz** in the **Vertical** polarization, Low Channel

-14.5 dB at **4884.00 MHz** in the **Vertical** polarization, Middle Channel

-14.4 dB at **4924.00 MHz** in the **Vertical** polarization, High Channel

-7.0 dB at **80.52 MHz** in the **Horizontal** polarization, unintentional emission

802.11g, 15.247

-9.6 dB at **2390.00 MHz** in the **Vertical** polarization, Low Channel

-13.9 dB at **4884.00 MHz** in the **Vertical** polarization, Middle Channel

-12.4 dB at **2485.00 MHz** in the **Vertical** polarization, High Channel

-7.3 dB at **80.52 MHz** in the **Horizontal** polarization, unintentional emission

2.4GHz Antenna 26WT-2400F

802.11b, 15.247

-0.6 dB at **2390.00 MHz** in the **Vertical** polarization, Low Channel

-13.6 dB at **4884.00 MHz** in the **Vertical** polarization, Middle Channel

-1.6 dB at **2487.00 MHz** in the **Vertical** polarization, High Channel

-6.9 dB at **80.52 MHz** in the **Horizontal** polarization, unintentional emission

802.11g, 15.247

-0.5 dB at **2390.00 MHz** in the **Vertical** polarization, Low Channel

-13.2 dB at **4884.00 MHz** in the **Vertical** polarization, Middle Channel

-0.6 dB at **2484.00 MHz** in the **Vertical** polarization, High Channel

-6.9 dB at **80.52 MHz** in the **Horizontal** polarization, unintentional emission

2.4GHz Antenna 2443LT*802.11b, 15.247*

- 12.2 dB at 2390.00 MHz in the **Vertical** polarization, Low Channel
- 14.5 dB at 4884.00 MHz in the **Vertical** polarization, Middle Channel
- 12.6 dB at 2484.00 MHz in the **Vertical** polarization, High Channel
- 7.3 dB at 80.52 MHz in the **Horizontal** polarization, unintentional emission

802.11g, 15.247

- 9.1 dB at 2390.00 MHz in the **Vertical** polarization, Low Channel
- 14.5 dB at 4884.00 MHz in the **Vertical** polarization, Middle Channel
- 9.3 dB at 2484.10 MHz in the **Vertical** polarization, High Channel
- 7.3 dB at 80.52 MHz in the **Horizontal** polarization, unintentional emission

2.4GHz Antenna 2449LT*802.11b, 15.247*

- 12.9 dB at 2390.00 MHz in the **Vertical** polarization, Low Channel
- 15.7 dB at 4884.00 MHz in the **Vertical** polarization, Middle Channel
- 15.9 dB at 4924.00 MHz in the **Vertical** polarization, High Channel
- 7.2 dB at 80.52 MHz in the **Horizontal** polarization, unintentional emission

802.11g, 15.247

- 10.8 dB at 2390.00 MHz in the **Vertical** polarization, Low Channel
- 15.9 dB at 4884.00 MHz in the **Vertical** polarization, Middle Channel
- 9.1 dB at 2484.10 MHz in the **Vertical** polarization, High Channel
- 7.2 dB at 80.52 MHz in the **Horizontal** polarization, unintentional emission

5.25 – 5.35GHz Antenna 523360*802.11a, Low Band, 15.407*

- 0.9 dB at 5351.00 MHz in the **Vertical** polarization, Low Channel
- 18.1 dB at 10600.00 MHz in the **Vertical** polarization, Middle Channel
- 0.8 dB at 5351.00 MHz in the **Vertical** polarization, High Channel
- 7.3 dB at 80.52 MHz in the **Horizontal** polarization, unintentional emission

802.11a, High Band, 15.247

- 6.1 dB at 5711.60 MHz in the **Vertical** polarization, Low Channel
- 15.4 dB at 11570.00 MHz in the **Vertical** polarization, Middle Channel
- 8.1 dB at 5836.40 MHz in the **Vertical** polarization, High Channel
- 7.1 dB at 80.52 MHz in the **Horizontal** polarization, unintentional emission

5GHz Antenna FPA5350D24-N*802.11a, Low Band, 15.407*

- 5.1 dB at 5250.00 MHz in the **Vertical** polarization, Low Channel
- 15.6 dB at 10600.00 MHz in the **Vertical** polarization, Middle Channel
- 1.1 dB at 5351.00 MHz in the **Vertical** polarization, High Channel
- 7.0 dB at 80.52 MHz in the **Horizontal** polarization, unintentional emission

802.11a, High Band, 15.247

- 1.2 dB at 5711.60 MHz in the **Vertical** polarization, Low Channel
- 14.9 dB at 11570.00 MHz in the **Vertical** polarization, Middle Channel
- 4.9 dB at 5850.00 MHz in the **Vertical** polarization, High Channel
- 7.2 dB at 80.52 MHz in the **Horizontal** polarization, unintentional emission

5GHz Antenna R0320-100*802.11a, Low Band, 15.407*

- 2.5 dB at 5250.00 MHz in the **Vertical** polarization, Low Channel
- 17.5 dB at 10600.00 MHz in the **Vertical** polarization, Middle Channel
- 1.0 dB at 5351.00 MHz in the **Vertical** polarization, High Channel
- 7.6 dB at 80.52 MHz in the **Horizontal** polarization, unintentional emission

802.11a, High Band, 15.247

- 4.0 dB at 5725.00 MHz in the **Vertical** polarization, Low Channel
- 16.3 dB at 11570.00 MHz in the **Vertical** polarization, Middle Channel
- 4.5 dB at 5836.40 MHz in the **Vertical** polarization, High Channel
- 7.5 dB at 80.52 MHz in the **Horizontal** polarization, unintentional emission

5GHz Antenna R0320-101*802.11a, Low Band, 15.407*

- 7.3 dB at 5250.00 MHz in the **Vertical** polarization, Low Channel
- 17.1 dB at 10600.00 MHz in the **Vertical** polarization, Middle Channel
- 2.6 dB at 5351.00 MHz in the **Vertical** polarization, High Channel
- 7.5 dB at 80.52 MHz in the **Horizontal** polarization, unintentional emission

802.11a, High Band, 15.247

- 5.9 dB at 5711.60 MHz in the **Vertical** polarization, Low Channel
- 15.6 dB at 11570.00 MHz in the **Vertical** polarization, Middle Channel
- 8.5 dB at 5836.40 MHz in the **Vertical** polarization, High Channel
- 7.7 dB at 80.52 MHz in the **Horizontal** polarization, unintentional emission

5GHz Antenna P3F-52*802.11a, Low Band, 15.407*

- 4.3 dB at 5250.00 MHz in the **Vertical** polarization, Low Channel
- 15.6 dB at 10600.00 MHz in the **Vertical** polarization, Middle Channel
- 1.0 dB at 5351.00 MHz in the **Vertical** polarization, High Channel
- 7.1 dB at 80.52 MHz in the **Horizontal** polarization, unintentional emission

802.11a, High Band, 15.247

- 1.2 dB at 5711.60 MHz in the **Vertical** polarization, Low Channel
- 14.9 dB at 11570.00 MHz in the **Vertical** polarization, Middle Channel
- 4.9 dB at 5850.00 MHz in the **Vertical** polarization, High Channel
- 7.1 dB at 80.52 MHz in the **Horizontal** polarization, unintentional emission

5GHz Antenna MA-WA58-1X*802.11a, Low Band, 15.407*

- 2.9 dB at 5250.00 MHz in the **Vertical** polarization, Low Channel
- 17.2 dB at 10600.00 MHz in the **Vertical** polarization, Middle Channel
- 3.1 dB at 5351.00 MHz in the **Vertical** polarization, High Channel
- 6.9 dB at 80.52 MHz in the **Horizontal** polarization, unintentional emission

802.11a, High Band, 15.247

- 4.4 dB at 5725.00 MHz in the **Vertical** polarization, Low Channel
- 17.2 dB at 11570.00 MHz in the **Vertical** polarization, Middle Channel
- 4.7 dB at 5836.40 MHz in the **Vertical** polarization, High Channel
- 6.9 dB at 80.52 MHz in the **Horizontal** polarization, unintentional emission

2.4GHz Antenna MA-WA24-1XP*802.11b, 15.247*

- 15.4 dB** at **4824.00 MHz** in the **Vertical** polarization, Low Channel
- 15.6 dB** at **4884.00 MHz** in the **Vertical** polarization, Middle Channel
- 15.5 dB** at **4924.00 MHz** in the **Vertical** polarization, High Channel
- 7.1 dB** at **80.52 MHz** in the **Horizontal** polarization, unintentional emission

802.11g, 15.247

- 13.5 dB** at **2390.00 MHz** in the **Vertical** polarization, Low Channel
- 15.6 dB** at **4884.00 MHz** in the **Vertical** polarization, Middle Channel
- 15.7 dB** at **2485.00 MHz** in the **Vertical** polarization, High Channel
- 7.1 dB** at **80.52 MHz** in the **Horizontal** polarization, unintentional emission

2.4GHz Test Data with Antenna 2415LT**802.11b (15.247)**

INDICATED			TABLE	ANTENNA		CORRECTION FACTOR			CORRECTED AMPLITUDE	FCC 15 SUBPART C	
Frequency	Ampl.	Comments	Angle	Height	Polar	Antenna	Cable	Amp.	Corr. Ampl.	Limit	Margin
MHz	dB μ V/m		Degree	Meter	H/V	dB μ V/m	DB	DB	dB μ V/m	dB μ V/m	dB
Low Channel, 1-25GHz											
2412.00	99.4	Fund/Peak	0	1.5	v	28.1	2.0	35.5	94.0		
2412.00	80.7	Fund/Peak	0	1.5	h	28.1	2.0	35.5	75.3		
2412.00	89.5	Fund/Ave.	0	1.5	v	28.1	2.0	35.5	84.1		
2412.00	71.8	Fund/Ave.	0	1.5	h	28.1	2.0	35.5	66.4		
4824.00	38.5	Ave.	180	1.6	v	32.5	3.1	34.6	39.5	54	-14.5
2390.00	43.5	Ave.	0	1.5	v	28.1	2.0	35.5	38.1	54	-15.9
4824.00	32.2	Ave.	310	1.5	h	32.5	3.1	34.6	33.2	54	-20.8
2390.00	37.4	Ave.	0	1.2	h	28.1	2.0	35.5	32.0	54	-22.0
2390.00	54.7	Peak	0	1.5	v	28.1	2.0	35.5	49.3	74	-24.7
4824.00	45.7	Peak	180	1.6	v	32.5	3.1	34.6	46.7	74	-27.3
2390.00	49.3	Peak	0	1.2	h	28.1	2.0	35.5	43.9	74	-30.1
4824.00	39.1	Peak	310	1.5	h	32.5	3.1	34.6	40.1	74	-33.9
Middle Channel, 1-25GHz											
2442.00	98.2	Fund/Peak	0	1.5	v	28.1	2.0	35.2	93.1		
2442.00	81.3	Fund/Peak	0	1.5	h	28.1	2.0	35.2	76.2		
2442.00	88.9	Fund/Ave.	0	1.5	v	28.1	2.0	35.2	83.8		
2442.00	72.5	Fund/Ave.	0	1.5	h	28.1	2.0	35.2	67.4		
4884.00	38.4	Ave.	210	1.5	v	32.5	3.1	34.6	39.4	54	-14.6
4884.00	31.7	Ave.	230	1.5	h	32.5	3.1	34.6	32.7	54	-21.3
4884.00	45.7	Peak	210	1.5	v	32.5	3.1	34.6	46.7	74	-27.3
4884.00	38.9	Peak	230	1.5	h	32.5	3.1	34.6	39.9	74	-34.1

INDICATED			TABLE	ANTENNA		CORRECTION FACTOR			CORRECTED AMPLITUDE	FCC 15 SUBPART C	
Frequency	Ampl.	Comments	Angle	Height	Polar	Antenna	Cable	Amp.	Corr. Ampl.	Limit	Margin
MHz	dB μ V/ m		Degree	Meter	H/V	dB μ V/m	DB	DB	dB μ V/m	dB μ V/m	dB
High Channel, 1-25GHz											
2462.00	98.8	Fund/Peak	0	1.8	v	28.1	2.0	35.2	93.7		
2462.00	80.5	Fund/Peak	0	1.5	h	28.1	2.0	35.2	75.4		
2462.00	89.6	Fund/Ave.	0	1.8	v	28.1	2.0	35.2	84.5		
2462.00	71.3	Fund/Ave.	0	1.5	h	28.1	2.0	35.2	66.2		
2485.00	42.3	Ave.	0	1.8	v	28.1	2.0	35.2	37.2	54	-16.8
4924.00	33.4	Ave.	270	1.2	v	32.5	3.1	34.6	34.4	54	-19.6
2485.00	39.5	Ave.	0	1.6	h	28.1	2.0	35.2	34.4	54	-19.6
4924.00	30.5	Ave.	310	1.5	h	32.5	3.1	34.6	31.5	54	-22.5
4924.00	45.5	Peak	270	1.2	v	32.5	3.1	34.6	46.5	74	-27.5
2485.00	51.4	Peak	0	1.8	v	28.1	2.0	35.2	46.3	74	-27.7
4924.00	42.3	Peak	310	1.5	h	32.5	3.1	34.6	43.3	74	-30.7
2485.00	48.2	Peak	0	1.6	h	28.1	2.0	35.2	43.1	74	-30.9

Note:

FUND = Fundamental

AVG = average

Unintentional Emission

Indicated			Table	Antenna		Correction Factor			FCC 15 Subpart B	
Frequency	Ampl.	Direction	Height	Polar	Antenna	Cable Loss	Amp.	Corr. Ampl.	Limit	Margin
MHz	dB μ V/m	Degree	Meter	H/V	dB μ V/m	dB μ V/m	dB	dB μ V/m	dB μ V/m	dB
80.52	47.3	330	1.8	h	11.8	2.2	28.4	32.9	40	-7.1
73.20	46.6	60	1.2	v	11.8	2.2	28.8	31.8	40	-8.2
143.10	47.1	15	1.5	v	13.7	2.1	28.1	34.8	43.5	-8.7
190.30	44.5	180	1.5	v	13.7	2.1	27.9	32.4	43.5	-11.1
880.23	47.3	270	1.5	v	11.8	2.2	28.8	32.5	46	-13.5
328.45	46.6	60	1.2	v	11.8	2.2	28.8	31.8	46	-14.2
249.22	43.3	60	1.2	v	11.8	2.2	28.8	28.5	46	-17.5
228.85	42.9	0	1.5	v	11.8	2.2	28.8	28.1	46	-17.9
40.30	36.5	270	1.5	h	11.5	2.2	28.9	21.3	40	-18.7
270.04	39.8	120	1.2	h	11.8	2.2	28.8	25.0	46	-21.0

802.11g (15.247)

INDICATED			TABLE	ANTENNA		CORRECTION FACTOR			CORRECTED AMPLITUDE	FCC 15 SUBPART C	
Frequency	Ampl.	Comments	Angle	Height	Polar	Antenna	Cable	Amp.	Corr. Ampl.	Limit	Margin
MHz	dB μ V/m		Degree	Meter	H/V	dB μ V/m	DB	DB	dB μ V/m	dB μ V/m	dB
Low Channel, 1-25GHz											
2412.00	99.2	Fund/Peak	0	1.5	v	28.1	2.0	35.5	93.8		
2412.00	80.7	Fund/Peak	0	1.5	h	28.1	2.0	35.5	75.3		
2412.00	89.6	Fund/Ave.	0	1.5	v	28.1	2.0	35.5	84.2		
2412.00	71.9	Fund/Ave.	0	1.5	h	28.1	2.0	35.5	66.5		
2390.00	46.1	Ave.	0	1.5	v	28.1	2.0	35.5	40.7	54	-13.3
4824.00	38.7	Ave.	180	1.6	v	32.5	3.1	34.6	39.7	54	-14.3
2390.00	61.3	Peak	0	1.5	v	28.1	2.0	35.5	55.9	74	-18.1
4824.00	32.1	Ave.	310	1.5	h	32.5	3.1	34.6	33.1	54	-20.9
2390.00	36.7	Ave.	0	1.2	h	28.1	2.0	35.5	31.3	54	-22.7
4824.00	45.8	Peak	180	1.6	v	32.5	3.1	34.6	46.8	74	-27.2
2390.00	48.2	Peak	0	1.2	h	28.1	2.0	35.5	42.8	74	-31.2
4824.00	39.2	Peak	310	1.5	h	32.5	3.1	34.6	40.2	74	-33.8
Middle Channel, 1-25GHz											
2442.00	97.9	Fund/Peak	0	1.5	v	28.1	2.0	35.2	92.8		
2442.00	81.1	Fund/Peak	0	1.5	h	28.1	2.0	35.2	76.0		
2442.00	88.7	Fund/Ave.	0	1.5	v	28.1	2.0	35.2	83.6		
2442.00	72.3	Fund/Ave.	0	1.5	h	28.1	2.0	35.2	67.2		
4884.00	38.5	Ave.	210	1.5	v	32.5	3.1	34.6	39.5	54	-14.5
4884.00	31.9	Ave.	230	1.5	h	32.5	3.1	34.6	32.9	54	-21.1
4884.00	45.6	Peak	210	1.5	v	32.5	3.1	34.6	46.6	74	-27.4
4884.00	39.1	Peak	230	1.5	h	32.5	3.1	34.6	40.1	74	-33.9

INDICATED			TABLE	ANTENNA		CORRECTION FACTOR			CORRECTED AMPLITUDE	FCC 15 SUBPART C	
Frequency	Ampl.	Comments	Angle	Height	Polar	Antenna	Cable	Amp.	Corr. Ampl.	Limit	Margin
MHz	dB μ V/m		Degree	Meter	H/V	dB μ V/m	DB	DB	dB μ V/m	dB μ V/m	dB
High Channel, 1-25GHz											
2462.00	98.7	Fund/Peak	0	1.8	v	28.1	2.0	35.2	93.6		
2462.00	80.3	Fund/Peak	0	1.5	h	28.1	2.0	35.2	75.2		
2462.00	89.4	Fund/Ave.	0	1.8	v	28.1	2.0	35.2	84.3		
2462.00	71.1	Fund/Ave.	0	1.5	h	28.1	2.0	35.2	66.0		
2485.00	43.6	Ave.	0	1.8	v	28.1	2.0	35.2	38.5	54	-15.5
2485.00	62.5	Peak	0	1.8	v	28.1	2.0	35.2	57.4	74	-16.6
4924.00	33.1	Ave.	270	1.2	v	32.5	3.1	34.6	34.1	54	-19.9
2485.00	36.7	Ave.	0	1.6	h	28.1	2.0	35.2	31.6	54	-22.4
4924.00	30.2	Ave.	310	1.5	h	32.5	3.1	34.6	31.2	54	-22.8
4924.00	45.3	Peak	270	1.2	v	32.5	3.1	34.6	46.3	74	-27.7
2485.00	48.9	Peak	0	1.6	h	28.1	2.0	35.2	43.8	74	-30.2
4924.00	42.2	Peak	310	1.5	h	32.5	3.1	34.6	43.2	74	-30.8

Note:

FUND = Fundamental

AVG = average

Unintentional Emission

Indicated			Table	Antenna			Correction Factor			FCC 15 Subpart B	
Frequency	Ampl.	Direction	Height	Polar	Antenna	Cable Loss	Amp.	Corr. Ampl.	Limit	Margin	
MHz	dB μ V/m	Degree	Meter	H/V	dB μ V/m	dB μ V/m	dB	dB μ V/m	dB μ V/m	dB	
80.52	47.1	330	1.6	h	11.8	2.2	28.4	32.7	40	-7.3	
73.20	46.8	60	1.5	v	11.8	2.2	28.8	32.0	40	-8.0	
143.10	46.9	15	1.2	v	13.7	2.1	28.1	34.6	43.5	-8.9	
190.30	44.2	180	1.5	v	13.7	2.1	27.9	32.1	43.5	-11.4	
880.23	47.1	270	1.5	v	11.8	2.2	28.8	32.3	46	-13.7	
328.45	46.8	60	1.5	v	11.8	2.2	28.8	32.0	46	-14.0	
249.22	43.7	60	1.2	v	11.8	2.2	28.8	28.9	46	-17.1	
228.85	42.5	0	1.5	v	11.8	2.2	28.8	27.7	46	-18.3	
40.30	36.3	270	1.5	h	11.5	2.2	28.9	21.1	40	-18.9	
270.04	39.6	120	1.2	h	11.8	2.2	28.8	24.8	46	-21.2	

2.4GHz Test Data with Antenna Z483**802.11b (15.247)**

INDICATED			TABLE	ANTENNA		CORRECTION FACTOR			CORRECTED AMPLITUDE	FCC 15 SUBPART C	
Frequency	Ampl.	Comments	Angle	Height	Polar	Antenna	Cable	Amp.	Corr. Ampl.	Limit	Margin
MHz	dB μ V/m		Degree	Meter	H/V	dB μ V/m	DB	DB	dB μ V/m	dB μ V/m	dB
Low Channel, 1-25GHz											
2412.00	104.3	Fund/Peak	15	1.5	v	28.1	2.0	35.5	98.9		
2412.00	86.1	Fund/Peak	30	1.5	h	28.1	2.0	35.5	80.7		
2412.00	101.7	Fund/Ave.	15	1.5	v	28.1	2.0	35.5	96.3		
2412.00	83.3	Fund/Ave.	30	1.5	h	28.1	2.0	35.5	77.9		
4824.00	38.7	Ave.	90	1.5	v	32.5	3.1	34.6	39.7	54	-14.3
2390.00	43.7	Ave.	180	1.8	v	28.1	2.0	35.5	38.3	54	-15.7
4824.00	32.5	Ave.	210	1.8	h	32.5	3.1	34.6	33.5	54	-20.5
2390.00	37.6	Ave.	120	1.2	h	28.1	2.0	35.5	32.2	54	-21.8
2390.00	54.9	Peak	180	1.8	v	28.1	2.0	35.5	49.5	74	-24.5
4824.00	45.9	Peak	90	1.5	v	32.5	3.1	34.6	46.9	74	-27.1
2390.00	49.5	Peak	120	1.2	h	28.1	2.0	35.5	44.1	74	-29.9
4824.00	40.2	Peak	210	1.8	h	32.5	3.1	34.6	41.2	74	-32.8
Middle Channel, 1-25GHz											
2442.00	103.1	Fund/Peak	0	1.2	v	28.1	2.0	35.5	97.7		
2442.00	85.8	Fund/Peak	270	1.5	h	28.1	2.0	35.5	80.4		
2442.00	100.9	Fund/Ave.	0	1.2	v	28.1	2.0	35.5	95.5		
2442.00	82.5	Fund/Ave.	270	1.5	h	28.1	2.0	35.5	77.1		
4884.00	38.5	Ave.	30	1.2	v	32.5	3.1	34.6	39.5	54	-14.5
4884.00	32.3	Ave.	270	1.8	h	32.5	3.1	34.6	33.3	54	-20.7
4884.00	45.6	Peak	30	1.2	v	32.5	3.1	34.6	46.6	74	-27.4
4884.00	40.0	Peak	270	1.8	h	32.5	3.1	34.6	41.0	74	-33.0

INDICATED			TABLE Angle Degree	ANTENNA		CORRECTION FACTOR			CORRECTED AMPLITUDE Corr. Ampl. dBμV/m	FCC 15 SUBPART C	
Frequency MHz	Ampl. dBμV/ m	Comments		Height Meter	Polar H/V	Antenna dBμV/m	Cable DB	Amp. DB		Limit dBμV/m	Margin dB
High Channel, 1-25GHz											
2462.00	103.8	Fund/Peak	0	1.6	v	28.1	2.0	35.5	98.4		
2462.00	85.9	Fund/Peak	270	1.8	h	28.1	2.0	35.5	80.5		
2462.00	101.3	Fund/Ave.	0	1.6	v	28.1	2.0	35.5	95.9		
2462.00	83.2	Fund/Ave.	270	1.8	h	28.1	2.0	35.5	77.8		
4924.00	38.6	Ave.	110	1.2	v	32.5	3.1	34.6	39.6	54	-14.4
2484.10	40.2	Ave.	180	1.5	v	28.1	2.0	35.5	34.8	54	-19.2
4924.00	32.4	Ave.	30	1.5	h	32.5	3.1	34.6	33.4	54	-20.6
2484.10	37.4	Ave.	0	1.2	h	28.1	2.0	35.5	32.0	54	-22.0
4924.00	45.7	Peak	110	1.2	v	32.5	3.1	34.6	46.7	74	-27.3
2484.10	51.9	Peak	180	1.5	v	28.1	2.0	35.5	46.5	74	-27.5
2484.10	46.7	Peak	0	1.2	h	28.1	2.0	35.5	41.3	74	-32.7
4924.00	40.1	Peak	30	1.5	h	32.5	3.1	34.6	41.1	74	-32.9

Note:

FUND = Fundamental

AVG = average

Unintentional Emission

Frequency MHz	Indicated		Table Height Meter	Antenna		Correction Factor			FCC 15 Subpart B	
	Ampl. dBμV/m	Direction Degree		Polar H/V	Antenna dBμV/m	Cable Loss dBμV/m	Amp. dB	Corr. Ampl. dBμV/m	Limit dBμV/m	Margin dB
80.52	47.4	330	1.8	h	11.8	2.2	28.4	33.0	40	-7.0
73.20	46.2	60	1.2	v	11.8	2.2	28.8	31.4	40	-8.6
143.10	47.2	15	1.5	v	13.7	2.1	28.1	34.9	43.5	-8.6
190.30	44.3	180	1.6	v	13.7	2.1	27.9	32.2	43.5	-11.3
880.23	47.2	270	1.5	v	11.8	2.2	28.8	32.4	46	-13.6
328.45	46.6	60	1.2	v	11.8	2.2	28.8	31.8	46	-14.2
249.22	43.8	60	1.2	v	11.8	2.2	28.8	29.0	46	-17.0
228.85	42.5	0	1.5	v	11.8	2.2	28.8	27.7	46	-18.3
40.30	36.1	270	1.5	h	11.5	2.2	28.9	20.9	40	-19.1
270.04	39.7	120	1.5	h	11.8	2.2	28.8	24.9	46	-21.1

802.11g (15.247)

INDICATED			TABLE	ANTENNA		CORRECTION FACTOR			CORRECTED AMPLITUDE	FCC 15 SUBPART C	
Frequency	Ampl.	Comments	Angle	Height	Polar	Antenna	Cable	Amp.	Corr. Ampl.	Limit	Margin
MHz	dB μ V/m		Degree	Meter	H/V	dB μ V/m	DB	DB	dB μ V/m	dB μ V/m	dB
Low Channel, 1-25GHz											
2412.00	102.7	Fund/Peak	30	1.5	v	28.1	2.0	35.5	97.3		
2412.00	84.1	Fund/Peak	90	1.5	h	28.1	2.0	35.5	78.7		
2412.00	94.4	Fund/Ave.	30	1.5	v	28.1	2.0	35.5	89.0		
2412.00	78.5	Fund/Ave.	90	1.5	h	28.1	2.0	35.5	73.1		
2390.00	49.8	Ave.	30	1.5	v	28.1	2.0	35.5	44.4	54	-9.6
4824.00	38.9	Ave.	180	1.6	v	32.5	3.1	34.6	39.9	54	-14.1
2390.00	62.4	Peak	30	1.5	v	28.1	2.0	35.5	57.0	74	-17.0
4824.00	32.7	Ave.	310	1.5	h	32.5	3.1	34.6	33.7	54	-20.3
2390.00	38.5	Ave.	90	1.2	h	28.1	2.0	35.5	33.1	54	-20.9
4824.00	46.2	Peak	180	1.6	v	32.5	3.1	34.6	47.2	74	-26.8
2390.00	50.3	Peak	90	1.2	h	28.1	2.0	35.5	44.9	74	-29.1
4824.00	40.5	Peak	310	1.5	h	32.5	3.1	34.6	41.5	74	-32.5
Middle Channel, 1-25GHz											
2442.00	103.3	Fund/Peak	0	1.5	v	28.1	2.0	35.2	98.2		
2442.00	85.2	Fund/Peak	0	1.5	h	28.1	2.0	35.2	80.1		
2442.00	96.6	Fund/Ave.	0	1.5	v	28.1	2.0	35.2	91.5		
2442.00	79.4	Fund/Ave.	0	1.5	h	28.1	2.0	35.2	74.3		
4884.00	39.1	Ave.	210	1.5	v	32.5	3.1	34.6	40.1	54	-13.9
4884.00	32.8	Ave.	230	1.5	h	32.5	3.1	34.6	33.8	54	-20.2
4884.00	46.4	Peak	210	1.5	v	32.5	3.1	34.6	47.4	74	-26.6
4884.00	40.7	Peak	230	1.5	h	32.5	3.1	34.6	41.7	74	-32.3

INDICATED			TABLE	ANTENNA		CORRECTION FACTOR			CORRECTED AMPLITUDE	FCC 15 SUBPART C	
Frequency	Ampl.	Comments	Angle	Height	Polar	Antenna	Cable	Amp.	Corr. Ampl.	Limit	Margin
MHz	dB μ V/m		Degree	Meter	H/V	dB μ V/m	DB	DB	dB μ V/m	dB μ V/m	dB
High Channel, 1-25GHz											
2462.00	102.9	Fund/Peak	0	1.8	v	28.1	2.0	35.2	97.8		
2462.00	84.6	Fund/Peak	30	1.5	h	28.1	2.0	35.2	79.5		
2462.00	94.7	Fund/Ave.	0	1.8	v	28.1	2.0	35.2	89.6		
2462.00	78.8	Fund/Ave.	30	1.5	h	28.1	2.0	35.2	73.7		
2485.00	46.7	Ave.	0	1.8	v	28.1	2.0	35.2	41.6	54	-12.4
4924.00	39.0	Ave.	270	1.2	v	32.5	3.1	34.6	40.0	54	-14.0
2485.00	63.5	Peak	0	1.8	v	28.1	2.0	35.2	58.4	74	-15.6
4924.00	32.7	Ave.	310	1.5	h	32.5	3.1	34.6	33.7	54	-20.3
4924.00	46.3	Peak	270	1.2	v	32.5	3.1	34.6	47.3	74	-26.7
2485.00	31.5	Ave.	30	1.6	h	28.1	2.0	35.2	26.4	54	-27.6
2485.00	48.6	Peak	30	1.6	h	28.1	2.0	35.2	43.5	74	-30.5
4924.00	40.5	Peak	310	1.5	h	32.5	3.1	34.6	41.5	74	-32.5

Note:

FUND = Fundamental

AVG = average

Unintentional Emission

Indicated			Table	Antenna		Correction Factor			FCC 15 Subpart B	
Frequency	Ampl.	Direction	Height	Polar	Antenna	Cable Loss	Amp.	Corr. Ampl.	Limit	Margin
MHz	dB μ V/m	Degree	Meter	H/V	dB μ V/m	dB μ V/m	dB	dB μ V/m	dB μ V/m	dB
80.52	47.1	330	1.6	h	11.8	2.2	28.4	32.7	40	-7.3
73.20	46.3	60	1.5	v	11.8	2.2	28.8	31.5	40	-8.5
143.10	46.7	15	1.5	v	13.7	2.1	28.1	34.4	43.5	-9.1
190.30	44.2	180	1.5	v	13.7	2.1	27.9	32.1	43.5	-11.4
880.23	47.5	270	1.5	v	11.8	2.2	28.8	32.7	46	-13.3
328.45	46.4	60	1.5	v	11.8	2.2	28.8	31.6	46	-14.4
249.22	43.7	60	1.2	v	11.8	2.2	28.8	28.9	46	-17.1
228.85	42.5	0	1.5	v	11.8	2.2	28.8	27.7	46	-18.3
40.30	36.8	270	1.2	h	11.5	2.2	28.9	21.6	40	-18.4
270.04	39.6	120	1.2	h	11.8	2.2	28.8	24.8	46	-21.2

2.4GHz Test Data with Antenna 26WT-2400F**802.11b (15.247)**

INDICATED			TABLE	ANTENNA		CORRECTION FACTOR			CORRECTED AMPLITUDE	FCC 15 SUBPART C	
Frequency	Ampl.	Comments		Angle	Height	Polar	Antenna	Cable		Amp.	Corr. Ampl.
MHz	dB μ V/m			Degree	Meter	H/V	dB μ V/m	DB	DB	dB μ V/m	dB μ V/m
Low Channel, 1-25GHz											
2412.00	114.4	Fund/Peak	0	1.8	v	28.1	2.0	35.5	109.0		
2412.00	89.5	Fund/Peak	0	1.8	h	28.1	2.0	35.5	84.1		
2412.00	111.5	Fund/Ave.	0	1.8	v	28.1	2.0	35.5	106.1		
2412.00	86.2	Fund/Ave.	0	1.8	h	28.1	2.0	35.5	80.8		
2390.00	58.8	Ave.	0	1.8	v	28.1	2.0	35.5	53.4	54	-0.6
2390.00	49.8	Ave.	0	1.8	h	28.1	2.0	35.5	44.4	54	-9.6
4824.00	39.2	Ave.	90	1.5	v	32.5	3.1	34.6	40.2	54	-13.8
2390.00	65.1	Peak	0	1.8	v	28.1	2.0	35.5	59.7	74	-14.3
4824.00	32.8	Ave.	210	1.8	h	32.5	3.1	34.6	33.8	54	-20.2
2390.00	56.5	Peak	0	1.8	h	28.1	2.0	35.5	51.1	74	-22.9
4824.00	46.3	Peak	90	1.5	v	32.5	3.1	34.6	47.3	74	-26.7
4824.00	40.5	Peak	210	1.8	h	32.5	3.1	34.6	41.5	74	-32.5
Middle Channel, 1-25GHz											
2442.00	114.6	Fund/Peak	0	1.8	v	28.1	2.0	35.5	109.2		
2442.00	89.4	Fund/Peak	0	1.5	h	28.1	2.0	35.5	84.0		
2442.00	111.5	Fund/Ave.	0	1.8	v	28.1	2.0	35.5	106.1		
2442.00	86.1	Fund/Ave.	0	1.5	h	28.1	2.0	35.5	80.7		
4884.00	39.4	Ave.	30	1.2	v	32.5	3.1	34.6	40.4	54	-13.6
4884.00	32.9	Ave.	270	1.8	h	32.5	3.1	34.6	33.9	54	-20.1
4884.00	46.5	Peak	30	1.2	v	32.5	3.1	34.6	47.5	74	-26.5
4884.00	40.7	Peak	270	1.8	h	32.5	3.1	34.6	41.7	74	-32.3

INDICATED			TABLE	ANTENNA		CORRECTION FACTOR			CORRECTED AMPLITUDE	FCC 15 SUBPART C	
Frequency	Ampl.	Comments	Angle	Height	Polar	Antenna	Cable	Amp.	Corr. Ampl.	Limit	Margin
MHz	dB μ V/ m		Degree	Meter	H/V	dB μ V/m	DB	DB	dB μ V/m	dB μ V/m	dB
High Channel, 1-25GHz											
2462.00	114.9	Fund/Peak	0	1.6	v	28.1	2.0	35.5	109.5		
2462.00	89.2	Fund/Peak	0	1.8	h	28.1	2.0	35.5	83.8		
2462.00	111.7	Fund/Ave.	0	1.6	v	28.1	2.0	35.5	106.3		
2462.00	86.0	Fund/Ave.	0	1.8	h	28.1	2.0	35.5	80.6		
2487.00	57.8	Ave.	0	1.6	v	28.1	2.0	35.5	52.4	54	-1.6
2487.00	49.6	Ave.	0	1.8	h	28.1	2.0	35.5	44.2	54	-9.8
4924.00	39.5	Ave.	110	1.2	v	32.5	3.1	34.6	40.5	54	-13.5
2487.00	63.4	Peak	0	1.6	v	28.1	2.0	35.5	58.0	74	-16.0
4924.00	32.7	Ave.	30	1.5	h	32.5	3.1	34.6	33.7	54	-20.3
2487.00	56.1	Peak	0	1.8	h	28.1	2.0	35.5	50.7	74	-23.3
4924.00	46.6	Peak	110	1.2	v	32.5	3.1	34.6	47.6	74	-26.4
4924.00	40.9	Peak	30	1.5	h	32.5	3.1	34.6	41.9	74	-32.1

Note:

FUND = Fundamental

AVG = average

Unintentional Emission

Frequency	Indicated		Table	Antenna		Correction Factor			FCC 15 Subpart B	
	Ampl.	Direction		Height	Polar	Antenna	Cable	Amp.	Corr.	Limit
MHz	dB μ V/m	Degree	Meter	H/V	dB μ V/m	dB μ V/m	dB	dB μ V/m	dB μ V/m	dB
80.52	47.5	330	1.5	h	11.8	2.2	28.4	33.1	40	-6.9
73.20	46.2	60	1.6	v	11.8	2.2	28.8	31.4	40	-8.6
143.10	47.2	15	1.5	v	13.7	2.1	28.1	34.9	43.5	-8.6
190.30	44.1	180	1.2	v	13.7	2.1	27.9	32.0	43.5	-11.5
880.23	47.4	270	1.5	v	11.8	2.2	28.8	32.6	46	-13.4
328.45	46.5	60	1.2	v	11.8	2.2	28.8	31.7	46	-14.3
249.22	43.6	60	1.5	v	11.8	2.2	28.8	28.8	46	-17.2
228.85	42.7	0	1.5	v	11.8	2.2	28.8	27.9	46	-18.1
40.30	36.6	270	1.5	h	11.5	2.2	28.9	21.4	40	-18.6
270.04	39.4	120	1.2	h	11.8	2.2	28.8	24.6	46	-21.4

802.11g (15.247)

INDICATED			TABLE	ANTENNA		CORRECTION FACTOR			CORRECTED AMPLITUDE	FCC 15 SUBPART C	
Frequency	Ampl.	Comments	Angle	Height	Polar	Antenna	Cable	Amp.	Corr. Ampl.	Limit	Margin
MHz	dB μ V/m		Degree	Meter	H/V	dB μ V/m	DB	DB	dB μ V/m	dB μ V/m	dB
Low Channel, 1-25GHz											
2412.00	112.8	Fund/Peak	0	1.8	v	28.1	2.0	35.5	107.4		
2412.00	82.4	Fund/Peak	0	1.8	h	28.1	2.0	35.5	77.0		
2412.00	105.6	Fund/Ave.	0	1.8	v	28.1	2.0	35.5	100.2		
2412.00	75.6	Fund/Ave.	0	1.8	h	28.1	2.0	35.5	70.2		
2390.00	58.9	Ave.	0	1.8	v	28.1	2.0	35.5	53.5	54	-0.5
2390.00	71.2	Peak	0	1.8	v	28.1	2.0	35.5	65.8	74	-8.2
2390.00	49.6	Ave.	0	1.8	h	28.1	2.0	35.5	44.2	54	-9.8
4824.00	38.7	Ave.	90	1.5	v	32.5	3.1	34.6	39.7	54	-14.3
4824.00	33.5	Ave.	210	1.8	h	32.5	3.1	34.6	34.5	54	-19.5
2390.00	56.3	Peak	0	1.8	h	28.1	2.0	35.5	50.9	74	-23.1
4824.00	45.9	Peak	90	1.5	v	32.5	3.1	34.6	46.9	74	-27.1
4824.00	40.1	Peak	210	1.8	h	32.5	3.1	34.6	41.1	74	-32.9
Middle Channel, 1-25GHz											
2442.00	113.7	Fund/Peak	0	1.8	v	28.1	2.0	35.5	108.3		
2442.00	82.2	Fund/Peak	0	1.5	h	28.1	2.0	35.5	76.8		
2442.00	105.9	Fund/Ave.	0	1.8	v	28.1	2.0	35.5	100.5		
2442.00	75.3	Fund/Ave.	0	1.5	h	28.1	2.0	35.5	69.9		
4884.00	39.8	Ave.	30	1.2	v	32.5	3.1	34.6	40.8	54	-13.2
4884.00	33.2	Ave.	270	1.8	h	32.5	3.1	34.6	34.2	54	-19.8
4884.00	46.7	Peak	30	1.2	v	32.5	3.1	34.6	47.7	74	-26.3
4884.00	40.9	Peak	270	1.8	h	32.5	3.1	34.6	41.9	74	-32.1

INDICATED			TABLE	ANTENNA		CORRECTION FACTOR			CORRECTED AMPLITUDE	FCC 15 SUBPART C	
Frequency	Ampl.	Comments	Angle	Height	Polar	Antenna	Cable	Amp.	Corr. Ampl.	Limit	Margin
MHz	dB μ V/m		Degree	Meter	H/V	dB μ V/m	DB	DB	dB μ V/m	dB μ V/m	dB
High Channel, 1-25GHz											
2462.00	113.9	Fund/Peak	0	1.6	v	28.1	2.0	35.5	108.5		
2462.00	82.1	Fund/Peak	0	1.8	h	28.1	2.0	35.5	76.7		
2462.00	106.1	Fund/Ave.	0	1.6	v	28.1	2.0	35.5	100.7		
2462.00	75.2	Fund/Ave.	0	1.8	h	28.1	2.0	35.5	69.8		
2484.00	58.8	Ave.	0	1.6	v	28.1	2.0	35.5	53.4	54	-0.6
2484.00	69.8	Peak	0	1.6	v	28.1	2.0	35.5	64.4	74	-9.6
2484.00	48.5	Ave.	0	1.8	h	28.1	2.0	35.5	43.1	54	-10.9
4924.00	39.9	Ave.	110	1.2	v	32.5	3.1	34.6	40.9	54	-13.1
4924.00	33.1	Ave.	30	1.5	h	32.5	3.1	34.6	34.1	54	-19.9
2484.00	55.6	Peak	0	1.8	h	28.1	2.0	35.5	50.2	74	-23.8
4924.00	46.8	Peak	110	1.2	v	32.5	3.1	34.6	47.8	74	-26.2
4924.00	40.7	Peak	30	1.5	h	32.5	3.1	34.6	41.7	74	-32.3

Note:

FUND = Fundamental

AVG = average

Unintentional Emission

Indicated			Table	Antenna		Correction Factor			FCC 15 Subpart B	
Frequency	Ampl.	Direction	Height	Polar	Antenna	Cable Loss	Amp.	Corr. Ampl.	Limit	Margin
MHz	dB μ V/m	Degree	Meter	H/V	dB μ V/m	dB μ V/m	dB	dB μ V/m	dB μ V/m	dB
80.52	47.5	330	1.8	h	11.8	2.2	28.4	33.1	40	-6.9
73.20	46.7	60	1.2	v	11.8	2.2	28.8	31.9	40	-8.1
143.10	47.3	15	1.5	v	13.7	2.1	28.1	35.0	43.5	-8.5
190.30	44.2	180	1.5	v	13.7	2.1	27.9	32.1	43.5	-11.4
880.23	47.3	270	1.5	v	11.8	2.2	28.8	32.5	46	-13.5
328.45	46.5	60	1.2	v	11.8	2.2	28.8	31.7	46	-14.3
249.22	43.1	60	1.2	v	11.8	2.2	28.8	28.3	46	-17.7
40.30	36.8	270	1.5	h	11.5	2.2	28.9	21.6	40	-18.4
228.85	42.3	0	1.5	v	11.8	2.2	28.8	27.5	46	-18.5
270.04	40.1	120	1.2	h	11.8	2.2	28.8	25.3	46	-20.7

2.4GHz Test Data with Antenna 2443LT**802.11b (15.247)**

INDICATED			TABLE	ANTENNA		CORRECTION FACTOR			CORRECTED AMPLITUDE	FCC 15 SUBPART C	
Frequency	Ampl.	Comments	Angle	Height	Polar	Antenna	Cable	Amp.	Corr. Ampl.	Limit	Margin
MHz	dB μ V/m		Degree	Meter	H/V	dB μ V/m	DB	DB	dB μ V/m	dB μ V/m	dB
Low Channel, 1-25GHz											
2412.00	103.8	Fund/Peak	0	1.6	v	28.1	2.0	35.5	98.4		
2412.00	87.1	Fund/Peak	0	1.5	h	28.1	2.0	35.5	81.7		
2412.00	101.0	Fund/Ave.	0	1.6	v	28.1	2.0	35.5	95.6		
2412.00	84.2	Fund/Ave.	0	1.5	h	28.1	2.0	35.5	78.8		
2390.00	47.2	Ave.	0	1.8	v	28.1	2.0	35.5	41.8	54	-12.2
4824.00	38.7	Ave.	90	1.5	v	32.5	3.1	34.6	39.7	54	-14.3
2390.00	44.9	Ave.	0	1.2	h	28.1	2.0	35.5	39.5	54	-14.5
4824.00	32.5	Ave.	210	1.8	h	32.5	3.1	34.6	33.5	54	-20.5
2390.00	57.8	Peak	0	1.8	v	28.1	2.0	35.5	52.4	74	-21.6
2390.00	55.3	Peak	0	1.2	h	28.1	2.0	35.5	49.9	74	-24.1
4824.00	45.9	Peak	90	1.5	v	32.5	3.1	34.6	46.9	74	-27.1
4824.00	40.2	Peak	210	1.8	h	32.5	3.1	34.6	41.2	74	-32.8
Middle Channel, 1-25GHz											
2442.00	103.4	Fund/Peak	0	1.2	v	28.1	2.0	35.5	98.0		
2442.00	86.8	Fund/Peak	0	1.5	h	28.1	2.0	35.5	81.4		
2442.00	100.9	Fund/Ave.	0	1.2	v	28.1	2.0	35.5	95.5		
2442.00	84.1	Fund/Ave.	0	1.5	h	28.1	2.0	35.5	78.7		
4884.00	38.5	Ave.	30	1.2	v	32.5	3.1	34.6	39.5	54	-14.5
4884.00	32.3	Ave.	270	1.8	h	32.5	3.1	34.6	33.3	54	-20.7
4884.00	45.7	Peak	30	1.2	v	32.5	3.1	34.6	46.7	74	-27.3
4884.00	40.0	Peak	270	1.8	h	32.5	3.1	34.6	41.0	74	-33.0

INDICATED			TABLE Angle Degree	ANTENNA		CORRECTION FACTOR			CORRECTED AMPLITUDE Corr. Ampl. dBμV/m	FCC 15 SUBPART C	
Frequency MHz	Ampl. dBμV/ m	Comments		Height Meter	Polar H/V	Antenna dBμV/m	Cable DB	Amp. DB		Limit dBμV/m	Margin dB
High Channel, 1-25GHz											
2462.00	104.2	Fund/Peak	0	1.6	v	28.1	2.0	35.5	98.8		
2462.00	87.3	Fund/Peak	0	1.8	h	28.1	2.0	35.5	81.9		
2462.00	101.4	Fund/Ave.	0	1.6	v	28.1	2.0	35.5	96.0		
2462.00	84.5	Fund/Ave.	0	1.8	h	28.1	2.0	35.5	79.1		
2484.10	46.8	Ave.	0	1.5	v	28.1	2.0	35.5	41.4	54	-12.6
4924.00	38.9	Ave.	110	1.2	v	32.5	3.1	34.6	39.9	54	-14.1
2484.10	44.3	Ave.	0	1.2	h	28.1	2.0	35.5	38.9	54	-15.1
4924.00	32.7	Ave.	30	1.5	h	32.5	3.1	34.6	33.7	54	-20.3
2484.10	57.2	Peak	0	1.5	v	28.1	2.0	35.5	51.8	74	-22.2
2484.10	54.6	Peak	0	1.2	h	28.1	2.0	35.5	49.2	74	-24.8
4924.00	46.3	Peak	110	1.2	v	32.5	3.1	34.6	47.3	74	-26.7
4924.00	40.5	Peak	30	1.5	h	32.5	3.1	34.6	41.5	74	-32.5

Note:

FUND = Fundamental
AVG = average

Unintentional Emission

Frequency MHz	Indicated		Table Height Meter	Antenna		Correction Factor			FCC 15 Subpart B	
	Ampl. dBμV/m	Direction Degree		Polar H/V	Antenna dBμV/m	Cable Loss dBμV/m	Amp. dB	Corr. Ampl. dBμV/m	Limit dBμV/m	Margin dB
80.52	47.1	330	1.6	h	11.8	2.2	28.4	32.7	40	-7.3
73.20	46.3	60	1.3	v	11.8	2.2	28.8	31.5	40	-8.5
143.10	46.8	15	1.5	v	13.7	2.1	28.1	34.5	43.5	-9.0
190.30	44.3	180	1.2	v	13.7	2.1	27.9	32.2	43.5	-11.3
880.23	46.9	270	1.5	v	11.8	2.2	28.8	32.1	46	-13.9
328.45	46.2	60	1.2	v	11.8	2.2	28.8	31.4	46	-14.6
249.22	43.1	60	1.2	v	11.8	2.2	28.8	28.3	46	-17.7
228.85	42.5	0	1.5	v	11.8	2.2	28.8	27.7	46	-18.3
40.30	36.2	270	1.5	h	11.5	2.2	28.9	21.0	40	-19.0
270.04	39.4	120	1.5	h	11.8	2.2	28.8	24.6	46	-21.4

802.11g (15.247)

INDICATED			TABLE	ANTENNA		CORRECTION FACTOR			CORRECTED AMPLITUDE	FCC 15 SUBPART C	
Frequency	Ampl.	Comments	Angle	Height	Polar	Antenna	Cable	Amp.	Corr. Ampl.	Limit	Margin
MHz	dB μ V/m		Degree	Meter	H/V	dB μ V/m	DB	DB	dB μ V/m	dB μ V/m	dB
Low Channel, 1-25GHz											
2412.00	102.7	Fund/Peak	0	1.6	v	28.1	2.0	35.5	97.3		
2412.00	86.1	Fund/Peak	0	1.5	h	28.1	2.0	35.5	80.7		
2412.00	93.6	Fund/Ave.	0	1.6	v	28.1	2.0	35.5	88.2		
2412.00	80.3	Fund/Ave.	0	1.5	h	28.1	2.0	35.5	74.9		
2390.00	50.3	Ave.	0	1.8	v	28.1	2.0	35.5	44.9	54	-9.1
2390.00	44.8	Ave.	0	1.2	h	28.1	2.0	35.5	39.4	54	-14.6
4824.00	38.2	Ave.	90	1.5	v	32.5	3.1	34.6	39.2	54	-14.8
2390.00	61.5	Peak	0	1.8	v	28.1	2.0	35.5	56.1	74	-17.9
4824.00	32.1	Ave.	210	1.8	h	32.5	3.1	34.6	33.1	54	-20.9
2390.00	55.6	Peak	0	1.2	h	28.1	2.0	35.5	50.2	74	-23.8
4824.00	45.5	Peak	90	1.5	v	32.5	3.1	34.6	46.5	74	-27.5
4824.00	39.9	Peak	210	1.8	h	32.5	3.1	34.6	40.9	74	-33.1
Middle Channel, 1-25GHz											
2442.00	103.1	Fund/Peak	0	1.2	v	28.1	2.0	35.5	97.7		
2442.00	86.5	Fund/Peak	0	1.5	h	28.1	2.0	35.5	81.1		
2442.00	93.8	Fund/Ave.	0	1.2	v	28.1	2.0	35.5	88.4		
2442.00	80.6	Fund/Ave.	0	1.5	h	28.1	2.0	35.5	75.2		
4884.00	38.5	Ave.	30	1.2	v	32.5	3.1	34.6	39.5	54	-14.5
4884.00	32.3	Ave.	270	1.8	h	32.5	3.1	34.6	33.3	54	-20.7
4884.00	45.7	Peak	30	1.2	v	32.5	3.1	34.6	46.7	74	-27.3
4884.00	40.1	Peak	270	1.8	h	32.5	3.1	34.6	41.1	74	-32.9

INDICATED			TABLE	ANTENNA		CORRECTION FACTOR			CORRECTED AMPLITUDE	FCC 15 SUBPART C	
Frequency	Ampl.	Comments	Angle	Height	Polar	Antenna	Cable	Amp.	Corr. Ampl.	Limit	Margin
MHz	dBµV/m		Degree	Meter	H/V	dBµV/m	DB	DB	dBµV/m	dBµV/m	dB
High Channel, 1-25GHz											
2462.00	102.9	Fund/Peak	0	1.6	v	28.1	2.0	35.5	97.5		
2462.00	86.3	Fund/Peak	0	1.8	h	28.1	2.0	35.5	80.9		
2462.00	93.6	Fund/Ave.	0	1.6	v	28.1	2.0	35.5	88.2		
2462.00	80.5	Fund/Ave.	0	1.8	h	28.1	2.0	35.5	75.1		
2484.10	50.1	Ave.	0	1.5	v	28.1	2.0	35.5	44.7	54	-9.3
2484.10	65.3	Peak	0	1.5	v	28.1	2.0	35.5	59.9	74	-14.1
4924.00	38.3	Ave.	110	1.2	v	32.5	3.1	34.6	39.3	54	-14.7
2484.10	40.4	Ave.	0	1.2	h	28.1	2.0	35.5	35.0	54	-19.0
4924.00	32.2	Ave.	30	1.5	h	32.5	3.1	34.6	33.2	54	-20.8
2484.10	55.9	Peak	0	1.2	h	28.1	2.0	35.5	50.5	74	-23.5
4924.00	45.6	Peak	110	1.2	v	32.5	3.1	34.6	46.6	74	-27.4
4924.00	40.0	Peak	30	1.5	h	32.5	3.1	34.6	41.0	74	-33.0

Note:

FUND = Fundamental

AVG = average

Unintentional Emission

Indicated			Table	Antenna		Correction Factor			FCC 15 Subpart B	
Frequency	Ampl.	Direction	Height	Polar	Antenna	Cable Loss	Amp.	Corr. Ampl.	Limit	Margin
MHz	dBµV/m	Degree	Meter	H/V	dBµV/m	dBµV/m	dB	dBµV/m	dBµV/m	dB
80.52	47.1	330	1.6	h	11.8	2.2	28.4	32.7	40	-7.3
73.20	46.3	60	1.3	v	11.8	2.2	28.8	31.5	40	-8.5
143.10	46.8	15	1.5	v	13.7	2.1	28.1	34.5	43.5	-9.0
190.30	44.3	180	1.2	v	13.7	2.1	27.9	32.2	43.5	-11.3
880.23	46.9	270	1.5	v	11.8	2.2	28.8	32.1	46	-13.9
328.45	46.2	60	1.2	v	11.8	2.2	28.8	31.4	46	-14.6
249.22	43.1	60	1.2	v	11.8	2.2	28.8	28.3	46	-17.7
228.85	42.5	0	1.5	v	11.8	2.2	28.8	27.7	46	-18.3
40.30	36.2	270	1.5	h	11.5	2.2	28.9	21.0	40	-19.0
270.04	39.4	120	1.5	h	11.8	2.2	28.8	24.6	46	-21.4

2.4GHz Test Data with Antenna 2449LT**802.11b (15.247)**

INDICATED			TABLE	ANTENNA		CORRECTION FACTOR			CORRECTED AMPLITUDE	FCC 15 SUBPART C	
Frequency	Ampl.	Comments	Angle	Height	Polar	Antenna	Cable	Amp.	Corr. Ampl.	Limit	Margin
MHz	dB μ V/m		Degree	Meter	H/V	dB μ V/m	DB	DB	dB μ V/m	dB μ V/m	dB
Low Channel, 1-25GHz											
2412.00	101.6	Fund/Peak	15	1.6	v	28.1	2.0	35.5	96.2		
2412.00	82.3	Fund/Peak	180	1.5	h	28.1	2.0	35.5	76.9		
2412.00	98.4	Fund/Ave.	15	1.6	v	28.1	2.0	35.5	93.0		
2412.00	78.9	Fund/Ave.	180	1.5	h	28.1	2.0	35.5	73.5		
2390.00	46.5	Ave.	15	1.8	v	28.1	2.0	35.5	41.1	54	-12.9
2390.00	44.1	Ave.	180	1.2	h	28.1	2.0	35.5	38.7	54	-15.3
4824.00	37.4	Ave.	90	1.5	v	32.5	3.1	34.6	38.4	54	-15.6
2390.00	57.1	Peak	15	1.8	v	28.1	2.0	35.5	51.7	74	-22.3
4824.00	30.6	Ave.	210	1.8	h	32.5	3.1	34.6	31.6	54	-22.4
2390.00	54.6	Peak	180	1.2	h	28.1	2.0	35.5	49.2	74	-24.8
4824.00	45.3	Peak	90	1.5	v	32.5	3.1	34.6	46.3	74	-27.7
4824.00	38.8	Peak	210	1.8	h	32.5	3.1	34.6	39.8	74	-34.2
Middle Channel, 1-25GHz											
2442.00	101.5	Fund/Peak	210	1.2	v	28.1	2.0	35.5	96.1		
2442.00	82.4	Fund/Peak	30	1.5	h	28.1	2.0	35.5	77.0		
2442.00	98.6	Fund/Ave.	210	1.2	v	28.1	2.0	35.5	93.2		
2442.00	78.8	Fund/Ave.	30	1.5	h	28.1	2.0	35.5	73.4		
4884.00	37.3	Ave.	90	1.2	v	32.5	3.1	34.6	38.3	54	-15.7
4884.00	30.4	Ave.	0	1.8	h	32.5	3.1	34.6	31.4	54	-22.6
4884.00	45.1	Peak	90	1.2	v	32.5	3.1	34.6	46.1	74	-27.9
4884.00	38.6	Peak	0	1.8	h	32.5	3.1	34.6	39.6	74	-34.4

INDICATED			TABLE Angle Degree	ANTENNA		CORRECTION FACTOR			CORRECTED AMPLITUDE Corr. Ampl. dB μ V/m	FCC 15 SUBPART C	
Frequency MHz	Ampl. dB μ V/ m	Comments		Height Meter	Polar H/V	Antenna dB μ V/m	Cable DB	Amp. DB		Limit dB μ V/m	Margin dB
High Channel, 1-25GHz											
2462.00	101.3	Fund/Peak	270	1.6	v	28.1	2.0	35.5	95.9		
2462.00	82.1	Fund/Peak	210	1.8	h	28.1	2.0	35.5	76.7		
2462.00	98.3	Fund/Ave.	270	1.6	v	28.1	2.0	35.5	92.9		
2462.00	78.5	Fund/Ave.	210	1.8	h	28.1	2.0	35.5	73.1		
4924.00	37.1	Ave.	0	1.2	v	32.5	3.1	34.6	38.1	54	-15.9
4924.00	30.2	Ave.	30	1.5	h	32.5	3.1	34.6	31.2	54	-22.8
4924.00	44.9	Peak	0	1.2	v	32.5	3.1	34.6	45.9	74	-28.1
4924.00	38.4	Peak	30	1.5	h	32.5	3.1	34.6	39.4	74	-34.6

Note:

FUND = Fundamental

AVG = average

Unintentional Emission

Indicated			Table Height Meter	Antenna		Correction Factor			FCC 15 Subpart B	
Frequency MHz	Ampl. dB μ V/m	Direction Degree		Polar H/V	Antenna dB μ V/m	Cable Loss dB μ V/m	Amp. dB	Corr. Ampl. dB μ V/m	Limit dB μ V/m	Margin dB
80.52	47.2	330	1.6	h	11.8	2.2	28.4	32.8	40	-7.2
73.20	46.5	60	1.3	v	11.8	2.2	28.8	31.7	40	-8.3
143.10	46.4	15	1.5	v	13.7	2.1	28.1	34.1	43.5	-9.4
190.30	44.1	180	1.2	v	13.7	2.1	27.9	32.0	43.5	-11.5
880.23	46.7	270	1.5	v	11.8	2.2	28.8	31.9	46	-14.1
328.45	46.1	60	1.2	v	11.8	2.2	28.8	31.3	46	-14.7
249.22	42.9	60	1.2	v	11.8	2.2	28.8	28.1	46	-17.9
228.85	42.3	0	1.5	v	11.8	2.2	28.8	27.5	46	-18.5
40.30	36.1	270	1.5	h	11.5	2.2	28.9	20.9	40	-19.1
270.04	39.2	120	1.5	h	11.8	2.2	28.8	24.4	46	-21.6

802.11g (15.247)

INDICATED			TABLE	ANTENNA		CORRECTION FACTOR			CORRECTED AMPLITUDE	FCC 15 SUBPART C	
Frequency	Ampl.	Comments	Angle	Height	Polar	Antenna	Cable	Amp.	Corr. Ampl.	Limit	Margin
MHz	dB μ V/m		Degree	Meter	H/V	dB μ V/m	DB	DB	dB μ V/m	dB μ V/m	dB
Low Channel, 1-25GHz											
2412.00	98.4	Fund/Peak	270	1.6	v	28.1	2.0	35.5	93.0		
2412.00	86.3	Fund/Peak	180	1.5	h	28.1	2.0	35.5	80.9		
2412.00	89.3	Fund/Ave.	270	1.6	v	28.1	2.0	35.5	83.9		
2412.00	77.1	Fund/Ave.	180	1.5	h	28.1	2.0	35.5	71.7		
2390.00	48.6	Ave.	270	1.8	v	28.1	2.0	35.5	43.2	54	-10.8
2390.00	45.8	Ave.	180	1.2	h	28.1	2.0	35.5	40.4	54	-13.6
4824.00	37.3	Ave.	90	1.5	v	32.5	3.1	34.6	38.3	54	-15.7
2390.00	59.7	Peak	270	1.8	v	28.1	2.0	35.5	54.3	74	-19.7
4824.00	30.5	Ave.	210	1.8	h	32.5	3.1	34.6	31.5	54	-22.5
2390.00	56.2	Peak	180	1.2	h	28.1	2.0	35.5	50.8	74	-23.2
4824.00	45.1	Peak	90	1.5	v	32.5	3.1	34.6	46.1	74	-27.9
4824.00	38.6	Peak	210	1.8	h	32.5	3.1	34.6	39.6	74	-34.4
Middle Channel, 1-25GHz											
2442.00	98.2	Fund/Peak	270	1.2	v	28.1	2.0	35.5	92.8		
2442.00	86.1	Fund/Peak	210	1.5	h	28.1	2.0	35.5	80.7		
2442.00	88.9	Fund/Ave.	270	1.2	v	28.1	2.0	35.5	83.5		
2442.00	77.0	Fund/Ave.	210	1.5	h	28.1	2.0	35.5	71.6		
4884.00	37.1	Ave.	90	1.2	v	32.5	3.1	34.6	38.1	54	-15.9
4884.00	30.4	Ave.	0	1.8	h	32.5	3.1	34.6	31.4	54	-22.6
4884.00	44.9	Peak	90	1.2	v	32.5	3.1	34.6	45.9	74	-28.1
4884.00	38.5	Peak	0	1.8	h	32.5	3.1	34.6	39.5	74	-34.5

INDICATED			TABLE	ANTENNA		CORRECTION FACTOR			CORRECTED AMPLITUDE	FCC 15 SUBPART C	
Frequency	Ampl.	Comments	Angle	Height	Polar	Antenna	Cable	Amp.	Corr. Ampl.	Limit	Margin
MHz	dB μ V/m		Degree	Meter	H/V	dB μ V/m	DB	DB	dB μ V/m	dB μ V/m	dB
High Channel, 1-25GHz											
2462.00	98.0	Fund/Peak	15	1.6	v	28.1	2.0	35.5	92.6		
2462.00	85.9	Fund/Peak	0	1.8	h	28.1	2.0	35.5	80.5		
2462.00	88.7	Fund/Ave.	15	1.6	v	28.1	2.0	35.5	83.3		
2462.00	76.8	Fund/Ave.	0	1.8	h	28.1	2.0	35.5	71.4		
2484.00	50.3	Ave.	15	1.8	v	28.1	2.0	35.5	44.9	54	-9.1
2484.00	47.9	Ave.	0	1.2	h	28.1	2.0	35.5	42.5	54	-11.5
4924.00	36.9	Ave.	0	1.2	v	32.5	3.1	34.6	37.9	54	-16.1
2484.00	61.5	Peak	15	1.8	v	28.1	2.0	35.5	56.1	74	-17.9
2484.00	58.4	Peak	0	1.2	h	28.1	2.0	35.5	53.0	74	-21.0
4924.00	30.3	Ave.	30	1.5	h	32.5	3.1	34.6	31.3	54	-22.7
4924.00	44.7	Peak	0	1.2	v	32.5	3.1	34.6	45.7	74	-28.3
4924.00	38.4	Peak	30	1.5	h	32.5	3.1	34.6	39.4	74	-34.6

Note:

FUND = Fundamental

AVG = average

Unintentional Emission

Indicated			Table	Antenna		Correction Factor			FCC 15 Subpart B	
Frequency	Ampl.	Direction	Height	Polar	Antenna	Cable Loss	Amp.	Corr. Ampl.	Limit	Margin
MHz	dB μ V/m	Degree	Meter	H/V	dB μ V/m	dB μ V/m	dB	dB μ V/m	dB μ V/m	dB
80.52	47.2	330	1.6	h	11.8	2.2	28.4	32.8	40	-7.2
73.20	46.5	60	1.3	v	11.8	2.2	28.8	31.7	40	-8.3
143.10	46.4	15	1.5	v	13.7	2.1	28.1	34.1	43.5	-9.4
190.30	44.1	180	1.2	v	13.7	2.1	27.9	32.0	43.5	-11.5
880.23	46.7	270	1.5	v	11.8	2.2	28.8	31.9	46	-14.1
328.45	46.1	60	1.2	v	11.8	2.2	28.8	31.3	46	-14.7
249.22	42.9	60	1.2	v	11.8	2.2	28.8	28.1	46	-17.9
228.85	42.3	0	1.5	v	11.8	2.2	28.8	27.5	46	-18.5
40.30	36.1	270	1.5	h	11.5	2.2	28.9	20.9	40	-19.1
270.04	39.2	120	1.5	h	11.8	2.2	28.8	24.4	46	-21.6

5.25 – 5.35GHz Only, Test Data with Antenna 523360**802.11a, low band (15.407)**

INDICATED			TABLE	ANTENNA		CORRECTION FACTOR			CORRECTED AMPLITUDE	FCC 15 SUBPART C	
Frequency	Ampl.	Comments		Angle	Height	Polar	Antenna	Cable		Amp.	Corr. Ampl.
MHz	dB μ V/m			Degree	Meter	H/V	dB μ V/m	DB	DB	dB μ V/m	dB μ V/m
Low Channel, 1-25GHz											
5280.00	95.8	Fund/Peak	0	1.8	v	33.9	3.2	34.4	98.5		
5280.00	80.8	Fund/Peak	15	1.5	h	33.9	3.2	34.4	83.5		
5280.00	87.2	Fund/Ave.	0	1.5	v	33.9	3.2	34.4	89.9		
5280.00	72.5	Fund/Ave.	15	1.5	h	33.9	3.2	34.4	75.2		
5351.00	50.4	Ave.	180	1.2	v	33.9	3.2	34.4	53.1	54	-0.9
5351.00	43.6	Ave.	90	1.5	h	33.9	3.2	34.4	46.3	54	-7.7
5351.00	58.4	Peak	180	1.2	v	33.9	3.2	34.4	61.1	74	-12.9
10560.00	31.8	Ave.	180	1.2	v	34.1	3.4	33.5	35.8	54	-18.2
10560.00	30.9	Ave.	310	1.5	h	34.1	3.4	33.5	34.9	54	-19.1
5351.00	51.5	Peak	90	1.5	h	33.9	3.2	34.4	54.2	74	-19.8
10560.00	42.2	Peak	180	1.2	v	34.1	3.4	33.5	46.2	74	-27.8
10560.00	41.5	Peak	310	1.5	h	34.1	3.4	33.5	45.5	74	-28.5
Middle Channel, 1-25GHz											
5300.00	96.2	Fund/Peak	120	1.8	v	33.9	3.2	34.4	98.9		
5300.00	81.1	Fund/Peak	180	2.0	h	33.9	3.2	34.4	83.8		
5300.00	87.5	Fund/Ave.	120	1.8	v	33.9	3.2	34.4	90.2		
5300.00	72.7	Fund/Ave.	180	2.0	h	33.9	3.2	34.4	75.4		
10600.00	31.9	Ave.	210	1.5	v	34.1	3.4	33.5	35.9	54	-18.1
10600.00	31.1	Ave.	230	1.5	h	34.1	3.4	33.5	35.1	54	-18.9
10600.00	42.4	Peak	210	1.5	v	34.1	3.4	33.5	46.4	74	-27.6
10600.00	41.7	Peak	230	1.5	h	34.1	3.4	33.5	45.7	74	-28.3

INDICATED			TABLE	ANTENNA		CORRECTION FACTOR			CORRECTED AMPLITUDE	FCC 15 SUBPART C	
Frequency	Ampl.	Comments	Angle	Height	Polar	Antenna	Cable	Amp.	Corr. Ampl.	Limit	Margin
MHz	dB μ V/m		Degree	Meter	H/V	dB μ V/m	DB	DB	dB μ V/m	dB μ V/m	dB
High Channel, 1-25GHz											
5320.00	96.6	Fund/Peak	180	1.2	v	33.9	3.2	34.4	99.3		
5320.00	81.4	Fund/Peak	90	1.5	h	33.9	3.2	34.4	84.1		
5320.00	87.7	Fund/Ave.	180	1.2	v	33.9	3.2	34.4	90.4		
5320.00	72.9	Fund/Ave.	90	1.5	h	33.9	3.2	34.4	75.6		
5351.00	50.5	Ave.	180	1.2	v	33.9	3.2	34.4	53.2	54	-0.8
5351.00	43.9	Ave.	90	1.5	h	33.9	3.2	34.4	46.6	54	-7.4
5351.00	58.9	Peak	180	1.2	v	33.9	3.2	34.4	61.6	74	-12.4
10640.00	32.1	Ave.	270	1.2	v	34.1	3.4	33.5	36.1	54	-17.9
10640.00	31.3	Ave.	310	1.5	h	34.1	3.4	33.5	35.3	54	-18.7
5351.00	51.7	Peak	90	1.5	h	33.9	3.2	34.4	54.4	74	-19.6
10640.00	42.5	Peak	270	1.2	v	34.1	3.4	33.5	46.5	74	-27.5
10640.00	41.9	Peak	310	1.5	h	34.1	3.4	33.5	45.9	74	-28.1

Note:

FUND = Fundamental

AVG = average

Unintentional Emission

Indicated			Table	Antenna		Correction Factor			FCC 15 Subpart B	
Frequency	Ampl.	Direction	Height	Polar	Antenna	Cable Loss	Amp.	Corr. Ampl.	Limit	Margin
MHz	dB μ V/m	Degree	Meter	H/V	dB μ V/m	dB μ V/m	dB	dB μ V/m	dB μ V/m	dB
80.52	47.1	330	1.6	h	11.8	2.2	28.4	32.7	40	-7.3
73.20	45.9	60	1.5	v	11.8	2.2	28.8	31.1	40	-8.9
143.10	46.6	15	1.5	v	13.7	2.1	28.1	34.3	43.5	-9.2
880.23	47.3	270	1.5	v	13.7	2.1	27.9	35.2	46	-10.8
190.30	44.2	180	1.5	v	13.7	2.1	27.9	32.1	43.5	-11.4
328.45	46.2	60	1.5	v	13.7	2.1	27.9	34.1	46	-11.9
249.22	42.9	60	1.2	v	11.8	2.2	28.8	28.1	46	-17.9
228.85	42.3	0	1.5	v	11.8	2.2	28.4	27.9	46	-18.1
270.04	39.5	120	1.2	h	13.7	2.1	28.1	27.2	46	-18.8
40.43	36.1	270	1.2	h	11.5	2.2	28.9	20.9	40	-19.1

5.725 – 5.825GHz Only, Test Data with Antenna 583360**802.11a, high band (15.247)**

INDICATED			TABLE	ANTENNA		CORRECTION FACTOR			CORRECTED AMPLITUDE	FCC 15 SUBPART C	
Frequency	Ampl.	Comments	Angle	Height	Polar	Anten na	Cable	Amp.	Corr. Ampl.	Limit	Margin
MHz	dB μ V/ m		Degree	Meter	H/ V	dB μ V/ m	DB	DB	dB μ V/m	dB μ V/m	dB
Low Channel, 1-25GHz											
5745.00	104.6	Fund/Peak	180	1.5	v	34.1	3.4	34.5	107.6		
5745.00	89.6	Fund/Peak	30	1.5	h	34.1	3.4	34.5	92.6		
5745.00	54.5	Fund/Ave.	180	1.5	v	34.1	3.4	34.5	57.5		
5745.00	51.2	Fund/Ave.	30	1.5	h	34.1	3.4	34.5	54.2		
5711.60	59.2	Peak	180	1.2	v	34.1	3.4	34.5	62.2	68.3	-6.1
5711.60	51.7	Peak	310	1.5	h	34.1	3.4	34.5	54.7	68.3	-13.6
11490.00	34.2	Ave.	180	1.2	v	34.1	3.4	33.5	38.2	54	-15.8
11490.00	33.1	Ave.	310	1.5	h	34.1	3.4	33.5	37.1	54	-16.9
11490.00	52.1	Peak	180	1.2	v	34.1	3.4	33.5	56.1	74	-17.9
11490.00	50.0	Peak	310	1.5	h	34.1	3.4	33.5	54.0	74	-20.0
Middle Channel, 1-25GHz											
5785.00	104.9	Fund/Peak	180	1.8	v	34.1	3.4	34.5	107.9		
5785.00	89.9	Fund/Peak	210	1.8	h	34.1	3.4	34.5	92.9		
5785.00	54.7	Fund/Ave.	180	1.8	v	34.1	3.4	34.5	57.7		
5785.00	51.5	Fund/Ave.	210	1.8	h	34.1	3.4	34.5	54.5		
11570.00	34.6	Ave.	270	1.5	v	34.1	3.4	33.5	38.6	54	-15.4
11570.00	33.5	Ave.	230	1.5	h	34.1	3.4	33.5	37.5	54	-16.5
11570.00	52.4	Peak	270	1.5	v	34.1	3.4	33.5	56.4	74	-17.6
11570.00	50.3	Peak	230	1.5	h	34.1	3.4	33.5	54.3	74	-19.7

INDICATED			TABLE	ANTENNA		CORRECTION FACTOR			CORRECTED AMPLITUDE	FCC 15 SUBPART C	
Frequency	Ampl.	Comments	Angle	Height	Polar	Antenna	Cable	Amp.	Corr. Ampl.	Limit	Margin
MHz	dB μ V/ m		Degree	Meter	H/V	dB μ V/m	DB	DB	dB μ V/m	dB μ V/m	dB
High Channel, 1-25GHz											
5805.00	104.8	Fund/Peak	0	1.5	v	34.1	3.4	34.5	107.8		
5805.00	89.7	Fund/Peak	90	1.2	h	34.1	3.4	34.5	92.7		
5805.00	54.6	Fund/Ave.	0	1.5	v	34.1	3.4	34.5	57.6		
5805.00	51.3	Fund/Ave.	90	1.2	h	34.1	3.4	34.5	54.3		
5836.40	57.9	Peak	110	1.6	v	34.1	3.4	35.2	60.2	68.3	-8.1
11610.00	34.3	Ave.	210	1.5	v	34.1	3.4	33.5	38.3	54	-15.7
5836.40	50.2	Peak	170	1.6	h	34.1	3.4	35.2	52.5	68.3	-15.8
11610.00	33.2	Ave.	60	1.5	h	34.1	3.4	33.5	37.2	54	-16.8
11610.00	52.2	Peak	210	1.5	v	34.1	3.4	33.5	56.2	74	-17.8
11610.00	50.1	Peak	60	1.5	h	34.1	3.4	33.5	54.1	74	-19.9

Note:

FUND = Fundamental

AVG = average

Unintentional Emission

Frequency	Indicated		Table	Antenna		Correction Factor			FCC 15 Subpart B	
	Ampl.	Direction	Height	Polar	Antenna	Cable Loss	Amp.	Corr. Ampl.	Limit	Margin
MHz	dB μ V/m	Degree	Meter	H/V	dB μ V/m	dB μ V/m	dB	dB μ V/m	dB μ V/m	dB
80.52	47.3	330	1.5	h	11.8	2.2	28.4	32.9	40	-7.1
73.20	46.2	60	1.2	v	11.8	2.2	28.8	31.4	40	-8.6
143.10	46.5	15	1.5	v	13.7	2.1	28.1	34.2	43.5	-9.3
880.23	47.1	270	1.5	v	13.7	2.1	27.9	35.0	46	-11.0
190.30	44.1	180	1.5	v	13.7	2.1	27.9	32.0	43.5	-11.5
328.45	46.5	60	1.4	v	13.7	2.1	28.1	34.2	46	-11.8
228.85	42.5	0	1.5	v	11.8	2.2	28.8	27.7	46	-18.3
249.22	42.7	60	1.2	v	11.5	2.2	28.9	27.5	46	-18.5
40.43	36.3	270	1.2	h	11.5	2.2	28.9	21.1	40	-18.9
270.04	39.8	120	1.2	h	11.8	2.2	28.4	25.4	46	-20.6

5GHz Test Data with Antenna FPA5350D24-N**802.11a, 5250 – 5350MHz, low band (15.407)**

INDICATED			TABLE	ANTENNA		CORRECTION FACTOR			CORRECTED AMPLITUDE	FCC 15 SUBPART C	
Frequency	Ampl.	Comments	Angle	Height	Polar	Antenna	Cable	Amp.	Corr. Ampl.	Limit	Margin
MHz	dB μ V/m		Degree	Meter	H/V	dB μ V/m	DB	DB	dB μ V/m	dB μ V/m	dB
Low Channel, 1-25GHz											
5280.00	121.4	Fund/Peak	0	1.8	v	33.9	3.2	34.4	124.1		
5280.00	102.5	Fund/Peak	0	1.5	h	33.9	3.2	34.4	105.2		
5280.00	112.7	Fund/Ave.	0	1.5	v	33.9	3.2	34.4	115.4		
5280.00	93.3	Fund/Ave.	0	1.5	h	33.9	3.2	34.4	96.0		
5250.00	60.5	Peak	0	1.2	v	33.9	3.2	34.4	63.2	68.3	-5.1
5250.00	60.2	Peak	0	1.5	h	33.9	3.2	34.4	62.9	68.3	-5.4
10560.00	34.7	Ave.	15	1.2	v	34.1	3.4	33.5	38.7	54	-15.3
10560.00	33.6	Ave.	310	1.5	h	34.1	3.4	33.5	37.6	54	-16.4
10560.00	52.4	Peak	15	1.2	v	34.1	3.4	33.5	56.4	74	-17.6
10560.00	51.5	Peak	310	1.5	h	34.1	3.4	33.5	55.5	74	-18.5
Middle Channel, 1-25GHz											
5300.00	121.2	Fund/Peak	0	1.8	v	33.9	3.2	34.4	123.9		
5300.00	102.3	Fund/Peak	0	2.0	h	33.9	3.2	34.4	105.0		
5300.00	112.2	Fund/Ave.	0	1.8	v	33.9	3.2	34.4	114.9		
5300.00	92.8	Fund/Ave.	0	2.0	h	33.9	3.2	34.4	95.5		
10600.00	34.4	Ave.	210	1.5	v	34.1	3.4	33.5	38.4	54	-15.6
10600.00	33.1	Ave.	230	1.5	h	34.1	3.4	33.5	37.1	54	-16.9
10600.00	52.1	Peak	210	1.5	v	34.1	3.4	33.5	56.1	74	-17.9
10600.00	51.2	Peak	230	1.5	h	34.1	3.4	33.5	55.2	74	-18.8

INDICATED			TABLE	ANTENNA		CORRECTION FACTOR			CORRECTED AMPLITUDE	FCC 15 SUBPART C	
Frequency	Ampl.	Comments	Angle	Height	Polar	Antenna	Cable	Amp.	Corr. Ampl.	Limit	Margin
MHz	dBµV/m		Degree	Meter	H/V	dBµV/m	DB	DB	dBµV/m	dBµV/m	dB
High Channel, 1-25GHz											
5320.00	121.3	Fund/Peak	0	1.2	v	33.9	3.2	34.4	124.0		
5320.00	102.4	Fund/Peak	0	1.5	h	33.9	3.2	34.4	105.1		
5320.00	112.5	Fund/Ave.	0	1.2	v	33.9	3.2	34.4	115.2		
5320.00	93.1	Fund/Ave.	0	1.5	h	33.9	3.2	34.4	95.8		
5351.00	50.2	Ave.	0	1.2	v	33.9	3.2	34.4	52.9	54	-1.1
5351.00	43.6	Ave.	0	1.5	h	33.9	3.2	34.4	46.3	54	-7.7
5351.00	58.7	Peak	0	1.2	v	33.9	3.2	34.4	61.4	74	-12.6
10640.00	34.6	Ave.	270	1.2	v	34.1	3.4	33.5	38.6	54	-15.4
10640.00	33.5	Ave.	310	1.5	h	34.1	3.4	33.5	37.5	54	-16.5
10640.00	52.3	Peak	270	1.2	v	34.1	3.4	33.5	56.3	74	-17.7
10640.00	51.4	Peak	310	1.5	h	34.1	3.4	33.5	55.4	74	-18.6
5351.00	51.5	Peak	0	1.5	h	33.9	3.2	34.4	54.2	74	-19.8

Note:

FUND = Fundamental

AVG = average

Unintentional Emission

Indicated			Table	Antenna		Correction Factor			FCC 15 Subpart B	
Frequency	Ampl.	Direction	Height	Polar	Antenna	Cable Loss	Amp.	Corr. Ampl.	Limit	Margin
MHz	dBµV/m	Degree	Meter	H/V	dBµV/m	dBµV/m	dB	dBµV/m	dBµV/m	dB
80.52	47.4	310	1.2	h	11.8	2.2	28.4	33.0	40	-7.0
73.20	47.1	45	1.5	v	11.8	2.2	28.8	32.3	40	-7.7
143.10	47.2	0	1.6	v	13.7	2.1	28.1	34.9	43.5	-8.6
880.23	47.3	250	1.5	v	13.7	2.1	27.9	35.2	46	-10.8
190.32	44.5	160	1.5	v	13.7	2.1	27.9	32.4	43.5	-11.1
328.45	46.7	30	1.6	v	13.7	2.1	28.1	34.4	46	-11.6
249.27	43.8	90	1.2	v	11.5	2.2	28.9	28.6	43.5	-14.9
228.85	42.9	15	1.5	v	11.8	2.2	28.8	28.1	46	-17.9
40.30	36.9	230	1.5	h	11.5	2.2	28.9	21.7	40	-18.3
270.04	40.1	110	1.2	h	11.8	2.2	28.4	25.7	46	-20.3

802.11a, 5725 – 5850MHz, high band (15.247)

INDICATED			TABLE	ANTENNA		CORRECTION FACTOR			CORRECTED AMPLITUDE	FCC 15 SUBPART C	
Frequency	Ampl.	Comments	Angle	Height	Polar	Antenna	Cable	Amp.	Corr. Ampl.	Limit	Margin
MHz	dBμV/m		Degree	Meter	H/V	dBμV/m	DB	DB	dBμV/m	dBμV/m	dB
Low Channel, 1-25GHz											
5745.00	121.6	Fund/Peak	0	1.5	v	34.1	3.4	34.5	124.6		
5745.00	102.5	Fund/Peak	0	1.5	h	34.1	3.4	34.5	105.5		
5745.00	112.9	Fund/Ave.	0	1.5	v	34.1	3.4	34.5	115.9		
5745.00	93.1	Fund/Ave.	0	1.5	h	34.1	3.4	34.5	96.1		
5711.60	49.8	Peak	0	1.2	v	34.1	3.4	34.5	52.8	54	-1.2
5711.60	42.7	Peak	0	1.5	h	34.1	3.4	34.5	45.7	54	-8.3
5711.60	59.2	Peak	0	1.2	v	34.1	3.4	34.5	62.2	74	-11.8
11490.00	35.2	Ave.	180	1.2	v	34.1	3.4	33.5	39.2	54	-14.8
11490.00	33.6	Ave.	310	1.5	h	34.1	3.4	33.5	37.6	54	-16.4
11490.00	52.7	Peak	180	1.2	v	34.1	3.4	33.5	56.7	74	-17.3
11490.00	51.6	Peak	310	1.5	h	34.1	3.4	33.5	55.6	74	-18.4
5711.60	51.8	Peak	0	1.5	h	34.1	3.4	34.5	54.8	74	-19.2
Middle Channel, 1-25GHz											
5785.00	121.9	Fund/Peak	0	1.6	v	34.1	3.4	34.5	124.9		
5785.00	102.7	Fund/Peak	0	1.8	h	34.1	3.4	34.5	105.7		
5785.00	113.1	Fund/Ave.	0	1.6	v	34.1	3.4	34.5	116.1		
5785.00	93.5	Fund/Ave.	0	1.8	h	34.1	3.4	34.5	96.5		
11570.00	35.1	Ave.	270	1.5	v	34.1	3.4	33.5	39.1	54	-14.9
11570.00	34.2	Ave.	230	1.5	h	34.1	3.4	33.5	38.2	54	-15.8
11570.00	52.8	Peak	270	1.5	v	34.1	3.4	33.5	56.8	74	-17.2
11570.00	51.9	Peak	230	1.5	h	34.1	3.4	33.5	55.9	74	-18.1

INDICATED			TABLE Angle Degree	ANTENNA		CORRECTION FACTOR			CORRECTED AMPLITUDE Corr. Ampl. dBμV/m	FCC 15 SUBPART C	
Frequency MHz	Ampl. dBμV/ m	Comments		Height Meter	Polar H/V	Antenna dBμV/m	Cable DB	Amp. DB		Limit dBμV/m	Margin dB
High Channel, 1-25GHz											
5805.00	121.5	Fund/Peak	0	1.5	v	34.1	3.4	34.5	124.5		
5805.00	102.6	Fund/Peak	0	1.2	h	34.1	3.4	34.5	105.6		
5805.00	112.7	Fund/Ave.	0	1.5	v	34.1	3.4	34.5	115.7		
5805.00	93.2	Fund/Ave.	0	1.2	h	34.1	3.4	34.5	96.2		
5850.00	46.8	Peak	0	1.6	v	34.1	3.4	35.2	49.1	54	-4.9
5850.00	41.2	Peak	0	1.5	h	34.1	3.4	35.2	43.5	54	-10.5
11610.00	34.9	Ave.	210	1.5	v	34.1	3.4	33.5	38.9	54	-15.1
5850.00	55.6	Peak	0	1.6	v	34.1	3.4	35.2	57.9	74	-16.1
11610.00	33.7	Ave.	60	1.5	h	34.1	3.4	33.5	37.7	54	-16.3
11610.00	52.6	Peak	210	1.5	v	34.1	3.4	33.5	56.6	74	-17.4
11610.00	51.8	Peak	60	1.5	h	34.1	3.4	33.5	55.8	74	-18.2
5850.00	49.7	Peak	0	1.5	h	34.1	3.4	35.2	52.0	74	-22.0

Note:

FUND = Fundamental

AVG = average

Unintentional Emission

Frequency MHz	Indicated		Table Height Meter	Antenna		Correction Factor			FCC 15 Subpart B	
	Ampl. dBμV/m	Direction Degree		Polar H/V	Antenna dBμV/m	Cable Loss dBμV/m	Amp. dB	Corr. Ampl. dBμV/m	Limit dBμV/m	Margin dB
80.52	47.2	310	1.8	h	11.8	2.2	28.4	32.8	40	-7.2
73.20	46.9	45	1.5	v	11.8	2.2	28.8	32.1	40	-7.9
143.10	47.5	0	1.6	v	13.7	2.1	28.1	35.2	43.5	-8.3
880.23	47.5	250	1.5	v	13.7	2.1	27.9	35.4	46	-10.6
190.32	44.7	160	1.5	v	13.7	2.1	27.9	32.6	43.5	-10.9
328.45	46.9	30	1.5	v	13.7	2.1	28.1	34.6	46	-11.4
249.27	43.2	90	1.2	v	11.5	2.2	28.9	28.0	43.5	-15.5
228.85	42.7	15	1.5	v	11.8	2.2	28.8	27.9	46	-18.1
40.30	36.7	230	1.5	h	11.5	2.2	28.9	21.5	40	-18.5
270.04	40.5	110	1.2	h	11.8	2.2	28.4	26.1	46	-19.9

5GHz Test Data with Antenna R0320-100**802.11a, 5250 – 5350MHz, low band (15.407)**

INDICATED			TABLE	ANTENNA		CORRECTION FACTOR			CORRECTED AMPLITUDE	FCC 15 SUBPART C	
Frequency	Ampl.	Comments	Angle	Height	Polar	Antenna	Cable	Amp.	Corr. Ampl.	Limit	Margin
MHz	dB μ V/m		Degree	Meter	H/V	dB μ V/m	DB	DB	dB μ V/m	dB μ V/m	dB
Low Channel, 1-25GHz											
5280.00	109.7	Fund/Peak	0	1.6	v	33.9	3.2	34.4	112.4		
5280.00	94.4	Fund/Peak	0	1.8	h	33.9	3.2	34.4	97.1		
5280.00	100.3	Fund/Ave.	0	1.6	v	33.9	3.2	34.4	103.0		
5280.00	85.2	Fund/Ave.	0	1.8	h	33.9	3.2	34.4	87.9		
5250.00	63.1	Peak	0	1.2	v	33.9	3.2	34.4	65.8	68.3	-2.5
5250.00	54.4	Peak	0	1.5	h	33.9	3.2	34.4	57.1	68.3	-11.2
10560.00	32.7	Ave.	15	1.2	v	34.1	3.4	33.5	36.7	54	-17.3
10560.00	31.6	Ave.	310	1.5	h	34.1	3.4	33.5	35.6	54	-18.4
10560.00	42.9	Peak	15	1.2	v	34.1	3.4	33.5	46.9	74	-27.1
10560.00	42.2	Peak	310	1.5	h	34.1	3.4	33.5	46.2	74	-27.8
Middle Channel, 1-25GHz											
5300.00	108.6	Fund/Peak	0	1.6	v	33.9	3.2	34.4	111.3		
5300.00	94.1	Fund/Peak	0	1.8	h	33.9	3.2	34.4	96.8		
5300.00	99.5	Fund/Ave.	0	1.6	v	33.9	3.2	34.4	102.2		
5300.00	95.3	Fund/Ave.	0	1.8	h	33.9	3.2	34.4	98.0		
10600.00	32.5	Ave.	210	1.5	v	34.1	3.4	33.5	36.5	54	-17.5
10600.00	31.4	Ave.	230	1.5	h	34.1	3.4	33.5	35.4	54	-18.6
10600.00	42.7	Peak	210	1.5	v	34.1	3.4	33.5	46.7	74	-27.3
10600.00	41.8	Peak	230	1.5	h	34.1	3.4	33.5	45.8	74	-28.2

INDICATED			TABLE	ANTENNA		CORRECTION FACTOR			CORRECTED AMPLITUDE	FCC 15 SUBPART C	
Frequency	Ampl.	Comments	Angle	Height	Polar	Antenna	Cable	Amp.	Corr. Ampl.	Limit	Margin
MHz	dBµV/m		Degree	Meter	H/V	dBµV/m	DB	DB	dBµV/m	dBµV/m	dB
High Channel, 1-25GHz											
5320.00	108.4	Fund/Peak	0	1.2	v	33.9	3.2	34.4	111.1		
5320.00	93.9	Fund/Peak	0	1.5	h	33.9	3.2	34.4	96.6		
5320.00	99.2	Fund/Ave.	0	1.2	v	33.9	3.2	34.4	101.9		
5320.00	95.1	Fund/Ave.	0	1.5	h	33.9	3.2	34.4	97.8		
5351.00	50.3	Ave.	0	1.2	v	33.9	3.2	34.4	53.0	54	-1.0
5351.00	64.5	Peak	0	1.2	v	33.9	3.2	34.4	67.2	74	-6.8
5351.00	40.1	Ave.	0	1.5	h	33.9	3.2	34.4	42.8	54	-11.2
10640.00	32.4	Ave.	270	1.2	v	34.1	3.4	33.5	36.4	54	-17.6
10640.00	31.2	Ave.	310	1.5	h	34.1	3.4	33.5	35.2	54	-18.8
5351.00	52.4	Peak	0	1.5	h	33.9	3.2	34.4	55.1	74	-18.9
10640.00	42.5	Peak	270	1.2	v	34.1	3.4	33.5	46.5	74	-27.5
10640.00	41.7	Peak	310	1.5	h	34.1	3.4	33.5	45.7	74	-28.3

Note:

FUND = Fundamental

AVG = average

Unintentional Emission

Indicated			Table	Antenna		Correction Factor			FCC 15 Subpart B	
Frequency	Ampl.	Direction	Height	Polar	Antenna	Cable Loss	Amp.	Corr. Ampl.	Limit	Margin
MHz	dBµV/m	Degree	Meter	H/V	dBµV/m	dBµV/m	dB	dBµV/m	dBµV/m	dB
80.52	46.8	330	1.8	h	11.8	2.2	28.4	32.4	40	-7.6
73.20	46.3	60	1.5	v	11.8	2.2	28.8	31.5	40	-8.5
143.10	47.2	15	1.6	v	13.7	2.1	28.1	34.9	43.5	-8.6
880.23	46.9	270	1.5	v	13.7	2.1	27.9	34.8	46	-11.2
190.30	44.3	180	1.5	v	13.7	2.1	27.9	32.2	43.5	-11.3
328.45	46.2	60	1.5	v	13.7	2.1	27.9	34.1	46	-11.9
249.22	43.1	60	1.5	v	11.8	2.2	28.8	28.3	46	-17.7
228.85	42.5	0	1.2	v	11.8	2.2	28.4	28.1	46	-17.9
270.04	39.4	120	1.6	h	13.7	2.1	28.1	27.1	46	-18.9
40.30	36.2	270	1.5	h	11.5	2.2	28.9	21.0	40	-19.0

802.11a, 5725 – 5825MHz, high band (15.247)

INDICATED			TABLE	ANTENNA		CORRECTION FACTOR			CORRECTED AMPLITUDE	FCC 15 SUBPART C	
Frequency	Ampl.	Comments	Angle	Height	Polar	Antenna	Cable	Amp.	Corr. Ampl.	Limit	Margin
MHz	dBμV/m		Degree	Meter	H/V	dBμV/m	DB	DB	dBμV/m	dBμV/m	dB
Low Channel, 1-25GHz											
5745.00	105.1	Fund/Peak	0	1.6	v	34.1	3.4	34.5	108.1		
5745.00	96.7	Fund/Peak	0	1.5	h	34.1	3.4	34.5	99.7		
5745.00	95.3	Fund/Ave.	0	1.6	v	34.1	3.4	34.5	98.3		
5745.00	87.1	Fund/Ave.	0	1.5	h	34.1	3.4	34.5	90.1		
5725.00	61.3	Peak	0	1.8	v	34.1	3.4	34.5	64.3	68.3	-4.0
5725.00	58.4	Peak	0	1.5	h	34.1	3.4	34.5	61.4	68.3	-6.9
11490.00	33.5	Ave.	180	1.2	v	34.1	3.4	33.5	37.5	54	-16.5
11490.00	32.3	Ave.	310	1.5	h	34.1	3.4	33.5	36.3	54	-17.7
11490.00	51.6	Peak	180	1.2	v	34.1	3.4	33.5	55.6	74	-18.4
11490.00	49.2	Peak	310	1.5	h	34.1	3.4	33.5	53.2	74	-20.8
Middle Channel, 1-25GHz											
5785.00	105.7	Fund/Peak	0	1.8	v	34.1	3.4	34.5	108.7		
5785.00	97.1	Fund/Peak	0	1.8	h	34.1	3.4	34.5	100.1		
5785.00	95.6	Fund/Ave.	0	1.8	v	34.1	3.4	34.5	98.6		
5785.00	87.4	Fund/Ave.	0	1.8	h	34.1	3.4	34.5	90.4		
11570.00	33.7	Ave.	270	1.5	v	34.1	3.4	33.5	37.7	54	-16.3
11570.00	32.5	Ave.	230	1.5	h	34.1	3.4	33.5	36.5	54	-17.5
11570.00	51.7	Peak	270	1.5	v	34.1	3.4	33.5	55.7	74	-18.3
11570.00	49.4	Peak	230	1.5	h	34.1	3.4	33.5	53.4	74	-20.6

INDICATED			TABLE	ANTENNA		CORRECTION FACTOR			CORRECTED AMPLITUDE	FCC 15 SUBPART C	
Frequency	Ampl.	Comments	Angle	Height	Polar	Antenna	Cable	Amp.	Corr. Ampl.	Limit	Margin
MHz	dB μ V/ m		Degree	Meter	H/V	dB μ V/m	DB	DB	dB μ V/m	dB μ V/m	dB
High Channel, 1-25GHz											
5805.00	105.5	Fund/Peak	0	1.5	v	34.1	3.4	34.5	108.5		
5805.00	96.9	Fund/Peak	0	1.2	h	34.1	3.4	34.5	99.9		
5805.00	95.5	Fund/Ave.	0	1.5	v	34.1	3.4	34.5	98.5		
5805.00	87.2	Fund/Ave.	0	1.2	h	34.1	3.4	34.5	90.2		
5836.40	61.5	Peak	0	1.6	v	34.1	3.4	35.2	63.8	68.3	-4.5
5836.40	54.4	Peak	0	1.6	h	34.1	3.4	35.2	56.7	68.3	-11.6
11610.00	33.6	Ave.	210	1.5	v	34.1	3.4	33.5	37.6	54	-16.4
11610.00	32.4	Ave.	60	1.5	h	34.1	3.4	33.5	36.4	54	-17.6
11610.00	51.6	Peak	210	1.5	v	34.1	3.4	33.5	55.6	74	-18.4
11610.00	49.3	Peak	60	1.5	h	34.1	3.4	33.5	53.3	74	-20.7

Note:

FUND = Fundamental

AVG = average

Unintentional Emission

Indicated			Table	Antenna		Correction Factor			FCC 15 Subpart B	
Frequency	Ampl.	Direction	Height	Polar	Antenna	Cable Loss	Amp.	Corr. Ampl.	Limit	Margin
MHz	dB μ V/m	Degree	Meter	H/V	dB μ V/m	dB μ V/m	dB	dB μ V/m	dB μ V/m	dB
80.52	46.9	330	1.6	h	11.8	2.2	28.4	32.5	40	-7.5
73.20	46.1	60	1.5	v	11.8	2.2	28.8	31.3	40	-8.7
143.10	47.1	15	1.5	v	13.7	2.1	28.1	34.8	43.5	-8.7
190.30	44.5	180	1.2	v	13.7	2.1	27.9	32.4	43.5	-11.1
880.23	46.9	270	1.5	v	13.7	2.1	27.9	34.8	46	-11.2
328.45	46.5	60	1.5	v	13.7	2.1	27.9	34.4	46	-11.6
249.22	43.2	60	1.5	v	11.8	2.2	28.8	28.4	46	-17.6
228.85	42.4	0	1.2	v	11.8	2.2	28.4	28.0	46	-18.0
40.30	36.4	270	1.5	h	11.5	2.2	28.9	21.2	40	-18.8
270.04	39.3	120	1.6	h	13.7	2.1	28.1	27.0	46	-19.0

5GHz Test Data with Antenna R0320-101**802.11a, 5250 – 5350MHz, low band (15.407)**

INDICATED			TABLE	ANTENNA		CORRECTION FACTOR			CORRECTED AMPLITUDE	FCC 15 SUBPART C	
Frequency	Ampl.	Comments	Angle	Height	Polar	Antenna	Cable	Amp.	Corr. Ampl.	Limit	Margin
MHz	dB μ V/m		Degree	Meter	H/V	dB μ V/m	DB	DB	dB μ V/m	dB μ V/m	dB
Low Channel, 1-25GHz											
5280.00	104.8	Fund/Peak	30	1.5	v	33.9	3.2	34.4	107.5		
5280.00	87.7	Fund/Peak	0	1.2	h	33.9	3.2	34.4	90.4		
5280.00	95.2	Fund/Ave.	30	1.5	v	33.9	3.2	34.4	97.9		
5280.00	78.9	Fund/Ave.	0	1.2	h	33.9	3.2	34.4	81.6		
5250.00	58.3	Peak	0	1.2	v	33.9	3.2	34.4	61.0	68.3	-7.3
5250.00	51.4	Peak	0	1.5	h	33.9	3.2	34.4	54.1	68.3	-14.2
10560.00	32.7	Ave.	15	1.2	v	34.1	3.4	33.5	36.7	54	-17.3
10560.00	31.6	Ave.	310	1.5	h	34.1	3.4	33.5	35.6	54	-18.4
10560.00	42.9	Peak	15	1.2	v	34.1	3.4	33.5	46.9	74	-27.1
10560.00	42.2	Peak	310	1.5	h	34.1	3.4	33.5	46.2	74	-27.8
Middle Channel, 1-25GHz											
5300.00	105.1	Fund/Peak	45	1.6	v	33.9	3.2	34.4	107.8		
5300.00	87.9	Fund/Peak	30	1.8	h	33.9	3.2	34.4	90.6		
5300.00	95.5	Fund/Ave.	45	1.6	v	33.9	3.2	34.4	98.2		
5300.00	79.2	Fund/Ave.	30	1.8	h	33.9	3.2	34.4	81.9		
10600.00	32.9	Ave.	210	1.5	v	34.1	3.4	33.5	36.9	54	-17.1
10600.00	31.8	Ave.	230	1.5	h	34.1	3.4	33.5	35.8	54	-18.2
10600.00	43.2	Peak	210	1.5	v	34.1	3.4	33.5	47.2	74	-26.8
10600.00	42.5	Peak	230	1.5	h	34.1	3.4	33.5	46.5	74	-27.5

INDICATED			TABLE	ANTENNA		CORRECTION FACTOR			CORRECTED AMPLITUDE	FCC 15 SUBPART C	
Frequency	Ampl.	Comments	Angle	Height	Polar	Antenna	Cable	Amp.	Corr. Ampl.	Limit	Margin
MHz	dBμV/m		Degree	Meter	H/V	dBμV/m	DB	DB	dBμV/m	dBμV/m	dB
High Channel, 1-25GHz											
5320.00	105.4	Fund/Peak	0	1.2	v	33.9	3.2	34.4	108.1		
5320.00	88.2	Fund/Peak	15	1.5	h	33.9	3.2	34.4	90.9		
5320.00	95.7	Fund/Ave.	0	1.2	v	33.9	3.2	34.4	98.4		
5320.00	79.4	Fund/Ave.	15	1.5	h	33.9	3.2	34.4	82.1		
5351.00	48.7	Ave.	0	1.2	v	33.9	3.2	34.4	51.4	54	-2.6
5351.00	41.5	Ave.	15	1.5	h	33.9	3.2	34.4	44.2	54	-9.8
5351.00	57.6	Peak	0	1.2	v	33.9	3.2	34.4	60.3	74	-13.7
10640.00	33.2	Ave.	270	1.2	v	34.1	3.4	33.5	37.2	54	-16.8
10640.00	31.9	Ave.	310	1.5	h	34.1	3.4	33.5	35.9	54	-18.1
5351.00	50.2	Peak	15	1.5	h	33.9	3.2	34.4	52.9	74	-21.1
10640.00	43.5	Peak	270	1.2	v	34.1	3.4	33.5	47.5	74	-26.5
10640.00	42.6	Peak	310	1.5	h	34.1	3.4	33.5	46.6	74	-27.4

Note:

FUND = Fundamental

AVG = average

Unintentional Emission

Indicated			Table	Antenna		Correction Factor			FCC 15 Subpart B	
Frequency	Ampl.	Direction	Height	Polar	Antenna	Cable Loss	Amp.	Corr. Ampl.	Limit	Margin
MHz	dBμV/m	Degree	Meter	H/V	dBμV/m	dBμV/m	dB	dBμV/m	dBμV/m	dB
80.52	46.9	330	1.6	h	11.8	2.2	28.4	32.5	40	-7.5
73.20	46.1	60	1.2	v	11.8	2.2	28.8	31.3	40	-8.7
143.10	46.7	15	1.5	v	13.7	2.1	28.1	34.4	43.5	-9.1
880.23	46.9	270	1.5	v	13.7	2.1	27.9	34.8	46	-11.2
190.30	44.3	180	1.5	v	13.7	2.1	27.9	32.2	43.5	-11.3
328.45	46.2	60	1.5	v	13.7	2.1	28.1	33.9	46	-12.1
249.22	43.2	60	1.2	v	11.5	2.2	28.9	28.0	46	-18.0
228.85	42.5	0	1.5	v	11.8	2.2	28.8	27.7	46	-18.3
40.30	36.2	270	1.5	h	11.5	2.2	28.9	21.0	40	-19.0
270.04	39.7	120	1.8	h	11.8	2.2	28.4	25.3	46	-20.7

802.11a, 5725 – 5825MHz, high band (15.247)

INDICATED			TABLE	ANTENNA		CORRECTION FACTOR			CORRECTED AMPLITUDE	FCC 15 SUBPART C	
Frequency	Ampl.	Comments	Angle	Height	Polar	Antenna	Cable	Amp.	Corr. Ampl.	Limit	Margin
MHz	dB μ V/m		Degree	Meter	H/V	dB μ V/m	DB	DB	dB μ V/m	dB μ V/m	dB
Low Channel, 1-25GHz											
5745.00	107.9	Fund/Peak	0	1.5	v	34.1	3.4	34.5	110.9		
5745.00	94.3	Fund/Peak	30	1.5	h	34.1	3.4	34.5	97.3		
5745.00	98.8	Fund/Ave.	0	1.5	v	34.1	3.4	34.5	101.8		
5745.00	85.7	Fund/Ave.	30	1.5	h	34.1	3.4	34.5	88.7		
5711.60	59.4	Peak	0	1.2	v	34.1	3.4	34.5	62.4	68.3	-5.9
5711.60	51.9	Peak	0	1.5	h	34.1	3.4	34.5	54.9	68.3	-13.4
11490.00	34.8	Ave.	180	1.2	v	34.1	3.4	33.5	38.8	54	-15.2
11490.00	33.5	Ave.	310	1.5	h	34.1	3.4	33.5	37.5	54	-16.5
11490.00	44.9	Peak	180	1.2	v	34.1	3.4	33.5	48.9	74	-25.1
11490.00	43.7	Peak	310	1.5	h	34.1	3.4	33.5	47.7	74	-26.3
Middle Channel, 1-25GHz											
5785.00	106.6	Fund/Peak	180	1.8	v	34.1	3.4	34.5	109.6		
5785.00	93.5	Fund/Peak	210	1.8	h	34.1	3.4	34.5	96.5		
5785.00	87.4	Fund/Ave.	180	1.8	v	34.1	3.4	34.5	90.4		
5785.00	84.7	Fund/Ave.	210	1.8	h	34.1	3.4	34.5	87.7		
11570.00	34.4	Ave.	270	1.5	v	34.1	3.4	33.5	38.4	54	-15.6
11570.00	33.2	Ave.	230	1.5	h	34.1	3.4	33.5	37.2	54	-16.8
11570.00	44.5	Peak	270	1.5	v	34.1	3.4	33.5	48.5	74	-25.5
11570.00	43.6	Peak	230	1.5	h	34.1	3.4	33.5	47.6	74	-26.4

INDICATED			TABLE	ANTENNA		CORRECTION FACTOR			CORRECTED AMPLITUDE	FCC 15 SUBPART C	
Frequency	Ampl.	Comments	Angle	Height	Polar	Antenna	Cable	Amp.	Corr. Ampl.	Limit	Margin
MHz	dB μ V/ m		Degree	Meter	H/V	dB μ V/m	DB	DB	dB μ V/m	dB μ V/m	dB
High Channel, 1-25GHz											
5805.00	107.2	Fund/Peak	0	1.5	v	34.1	3.4	34.5	110.2		
5805.00	94.1	Fund/Peak	90	1.2	h	34.1	3.4	34.5	97.1		
5805.00	98.5	Fund/Ave.	0	1.5	v	34.1	3.4	34.5	101.5		
5805.00	85.4	Fund/Ave.	90	1.2	h	34.1	3.4	34.5	88.4		
5836.40	57.5	Peak	110	1.6	v	34.1	3.4	35.2	59.8	68.3	-8.5
11610.00	34.4	Ave.	210	1.5	v	34.1	3.4	33.5	38.4	54	-15.6
5836.40	50.0	Peak	170	1.6	h	34.1	3.4	35.2	52.3	68.3	-16.0
11610.00	33.2	Ave.	60	1.5	h	34.1	3.4	33.5	37.2	54	-16.8
11610.00	44.7	Peak	210	1.5	v	34.1	3.4	33.5	48.7	74	-25.3
11610.00	43.5	Peak	60	1.5	h	34.1	3.4	33.5	47.5	74	-26.5

Note:

FUND = Fundamental
AVG = average

Unintentional Emission

Indicated			Table	Antenna		Correction Factor			FCC 15 Subpart B	
Frequency	Ampl.	Direction	Height	Polar	Antenna	Cable Loss	Amp.	Corr. Ampl.	Limit	Margin
MHz	dB μ V/m	Degree	Meter	H/V	dB μ V/m	dB μ V/m	dB	dB μ V/m	dB μ V/m	dB
80.52	46.7	330	1.6	h	11.8	2.2	28.4	32.3	40	-7.7
73.20	46.2	60	1.2	v	11.8	2.2	28.8	31.4	40	-8.6
143.10	46.9	15	1.5	v	13.7	2.1	28.1	34.6	43.5	-8.9
190.30	44.5	180	1.5	v	13.7	2.1	27.9	32.4	43.5	-11.1
880.23	46.7	270	1.5	v	13.7	2.1	27.9	34.6	46	-11.4
328.45	46.3	60	1.5	v	13.7	2.1	28.1	34.0	46	-12.0
249.22	43.1	60	1.2	v	11.5	2.2	28.9	27.9	46	-18.1
228.85	42.6	0	1.5	v	11.8	2.2	28.8	27.8	46	-18.2
40.30	36.4	270	1.5	h	11.5	2.2	28.9	21.2	40	-18.8
270.04	39.8	120	1.6	h	11.8	2.2	28.4	25.4	46	-20.6

5GHz Test Data with Antenna P3F-52**802.11a, 5250 – 5350MHz, low band (15.407)**

INDICATED			TABLE	ANTENNA		CORRECTION FACTOR			CORRECTED AMPLITUDE	FCC 15 SUBPART C	
Frequency	Ampl.	Comments		Angle	Height	Polar	Antenna	Cable		Amp.	Corr. Ampl.
MHz	dB μ V/m			Degree	Meter	H/V	dB μ V/m	DB	DB	dB μ V/m	dB μ V/m
Low Channel, 1-25GHz											
5280.00	121.4	Fund/Peak	0	1.5	v	33.9	3.2	34.4	124.1		
5280.00	102.3	Fund/Peak	0	1.2	h	33.9	3.2	34.4	107.0		
5280.00	113.1	Fund/Ave.	0	1.5	v	33.9	3.2	34.4	115.8		
5280.00	93.1	Fund/Ave.	0	1.2	h	33.9	3.2	34.4	97.8		
5250.00	61.3	Peak	0	1.2	v	33.9	3.2	34.4	64.0	68.3	-4.3
5250.00	51.4	Peak	0	1.5	h	33.9	3.2	34.4	56.1	68.3	-12.2
10560.00	34.7	Ave.	15	1.2	v	34.1	3.4	33.5	38.7	54	-15.3
10560.00	33.6	Ave.	310	1.5	h	34.1	3.4	33.5	37.6	54	-16.4
10560.00	52.4	Peak	15	1.2	v	34.1	3.4	33.5	56.4	74	-17.6
10560.00	51.5	Peak	310	1.5	h	34.1	3.4	33.5	55.5	74	-18.5
Middle Channel, 1-25GHz											
5300.00	121.6	Fund/Peak	0	1.8	v	33.9	3.2	34.4	124.3		
5300.00	102.5	Fund/Peak	0	2.0	h	33.9	3.2	34.4	107.2		
5300.00	113.4	Fund/Ave.	0	1.8	v	33.9	3.2	34.4	116.1		
5300.00	93.3	Fund/Ave.	0	2.0	h	33.9	3.2	34.4	98.1		
10600.00	34.4	Ave.	210	1.5	v	34.1	3.4	33.5	38.4	54	-15.6
10600.00	33.1	Ave.	230	1.5	h	34.1	3.4	33.5	37.1	54	-16.9
10600.00	52.1	Peak	210	1.5	v	34.1	3.4	33.5	56.1	74	-17.9
10600.00	51.2	Peak	230	1.5	h	34.1	3.4	33.5	55.2	74	-18.8

INDICATED			TABLE	ANTENNA		CORRECTION FACTOR			CORRECTED AMPLITUDE	FCC 15 SUBPART C	
Frequency	Ampl.	Comments	Angle	Height	Polar	Antenna	Cable	Amp.	Corr. Ampl.	Limit	Margin
MHz	dB μ V/ m		Degree	Meter	H/V	dB μ V/m	DB	DB	dB μ V/m	dB μ V/m	dB
High Channel, 1-25GHz											
5320.00	121.9	Fund/Peak	0	1.2	v	33.9	3.2	34.4	124.6		
5320.00	102.8	Fund/Peak	0	1.5	h	33.9	3.2	34.4	107.5		
5320.00	113.5	Fund/Ave.	0	1.2	v	33.9	3.2	34.4	116.2		
5320.00	93.4	Fund/Ave.	0	1.5	h	33.9	3.2	34.4	98.1		
5351.00	50.3	Ave.	0	1.2	v	33.9	3.2	34.4	53.0	54	-1.0
5351.00	42.7	Ave.	0	1.5	h	33.9	3.2	34.4	47.4	54	-6.3
5351.00	58.9	Peak	0	1.2	v	33.9	3.2	34.4	61.6	74	-12.4
10640.00	34.6	Ave.	270	1.2	v	34.1	3.4	33.5	38.6	54	-15.4
10640.00	33.5	Ave.	310	1.5	h	34.1	3.4	33.5	37.5	54	-16.5
10640.00	52.3	Peak	270	1.2	v	34.1	3.4	33.5	56.3	74	-17.7
10640.00	51.4	Peak	310	1.5	h	34.1	3.4	33.5	55.4	74	-18.6
5351.00	47.7	Peak	0	1.5	h	33.9	3.2	34.4	52.4	74	-21.6

Note:

FUND = Fundamental

AVG = average

Unintentional Emission

Indicated			Table	Antenna		Correction Factor			FCC 15 Subpart B	
Frequency	Ampl.	Direction	Height	Polar	Antenna	Cable Loss	Amp.	Corr. Ampl.	Limit	Margin
MHz	dB μ V/m	Degree	Meter	H/V	dB μ V/m	dB μ V/m	dB	dB μ V/m	dB μ V/m	dB
80.52	47.3	310	1.5	h	11.8	2.2	28.4	32.9	40	-7.1
73.20	46.9	45	1.5	v	11.8	2.2	28.8	32.1	40	-7.9
143.10	47.5	0	1.8	v	13.7	2.1	28.1	35.2	43.5	-8.3
880.23	47.1	250	1.5	v	13.7	2.1	27.9	35.0	46	-11.0
190.32	44.2	160	1.5	v	13.7	2.1	27.9	32.1	43.5	-11.4
328.45	46.5	30	1.8	v	13.7	2.1	28.1	34.2	46	-11.8
249.27	43.6	90	1.2	v	11.5	2.2	28.9	28.4	43.5	-15.1
228.85	42.7	15	1.5	v	11.8	2.2	28.8	27.9	46	-18.1
40.30	36.7	230	1.2	h	11.5	2.2	28.9	21.5	40	-18.5
270.04	39.9	110	1.5	h	11.8	2.2	28.4	25.5	46	-20.5

802.11a, 5725 – 5825MHz, high band (15.247)

INDICATED			TABLE	ANTENNA		CORRECTION FACTOR			CORRECTED AMPLITUDE	FCC 15 SUBPART C	
Frequency	Ampl.	Comments	Angle	Height	Polar	Antenna	Cable	Amp.	Corr. Ampl.	Limit	Margin
MHz	dB μ V/m		Degree	Meter	H/V	dB μ V/m	DB	DB	dB μ V/m	dB μ V/m	dB
Low Channel, 1-25GHz											
5745.00	123.2	Fund/Peak	0	1.5	v	34.1	3.4	34.5	126.2		
5745.00	103.4	Fund/Peak	0	1.5	h	34.1	3.4	34.5	108.4		
5745.00	113.9	Fund/Ave.	0	1.5	v	34.1	3.4	34.5	116.9		
5745.00	94.8	Fund/Ave.	0	1.5	h	34.1	3.4	34.5	99.8		
5711.60	49.8	Ave.	0	1.2	v	34.1	3.4	34.5	52.8	54	-1.2
5711.60	42.7	Ave.	0	1.5	h	34.1	3.4	34.5	45.7	54	-8.3
5711.60	59.2	Peak	0	1.2	v	34.1	3.4	34.5	62.2	74	-11.8
11490.00	35.2	Ave.	180	1.2	v	34.1	3.4	33.5	39.2	54	-14.8
11490.00	33.6	Ave.	310	1.5	h	34.1	3.4	33.5	37.6	54	-16.4
11490.00	52.7	Peak	180	1.2	v	34.1	3.4	33.5	56.7	74	-17.3
11490.00	51.6	Peak	310	1.5	h	34.1	3.4	33.5	55.6	74	-18.4
5711.60	51.8	Peak	0	1.5	h	34.1	3.4	34.5	54.8	74	-19.2
Middle Channel, 1-25GHz											
5785.00	121.9	Fund/Peak	0	1.6	v	34.1	3.4	34.5	124.9		
5785.00	102.7	Fund/Peak	0	1.8	h	34.1	3.4	34.5	105.7		
5785.00	113.1	Fund/Ave.	0	1.6	v	34.1	3.4	34.5	116.1		
5785.00	93.5	Fund/Ave.	0	1.8	h	34.1	3.4	34.5	96.5		
11570.00	35.1	Ave.	270	1.5	v	34.1	3.4	33.5	39.1	54	-14.9
11570.00	34.2	Ave.	230	1.5	h	34.1	3.4	33.5	38.2	54	-15.8
11570.00	52.8	Peak	270	1.5	v	34.1	3.4	33.5	56.8	74	-17.2
11570.00	51.9	Peak	230	1.5	h	34.1	3.4	33.5	55.9	74	-18.1

INDICATED			TABLE	ANTENNA		CORRECTION FACTOR			CORRECTED AMPLITUDE	FCC 15 SUBPART C	
Frequency	Ampl.	Comments	Angle	Height	Polar	Antenna	Cable	Amp.	Corr. Ampl.	Limit	Margin
MHz	dB μ V/m		Degree	Meter	H/V	dB μ V/m	DB	DB	dB μ V/m	dB μ V/m	dB
High Channel, 1-25GHz											
5805.00	121.5	Fund/Peak	0	1.5	v	34.1	3.4	34.5	124.5		
5805.00	102.6	Fund/Peak	0	1.2	h	34.1	3.4	34.5	105.6		
5805.00	112.7	Fund/Ave.	0	1.5	v	34.1	3.4	34.5	115.7		
5805.00	93.2	Fund/Ave.	0	1.2	h	34.1	3.4	34.5	96.2		
5850.00	46.8	Peak	0	1.6	v	34.1	3.4	35.2	49.1	54	-4.9
5850.00	41.2	Peak	0	1.5	h	34.1	3.4	35.2	43.5	54	-10.5
11610.00	34.9	Ave.	210	1.5	v	34.1	3.4	33.5	38.9	54	-15.1
5850.00	55.6	Peak	0	1.6	v	34.1	3.4	35.2	57.9	74	-16.1
11610.00	33.7	Ave.	60	1.5	h	34.1	3.4	33.5	37.7	54	-16.3
11610.00	52.6	Peak	210	1.5	v	34.1	3.4	33.5	56.6	74	-17.4
11610.00	51.8	Peak	60	1.5	h	34.1	3.4	33.5	55.8	74	-18.2
5850.00	49.7	Peak	0	1.5	h	34.1	3.4	35.2	52.0	74	-22.0

Note:

FUND = Fundamental

AVG = average

Unintentional Emission

Indicated			Table	Antenna		Correction Factor			FCC 15 Subpart B	
Frequency	Ampl.	Direction	Height	Polar	Antenna	Cable Loss	Amp.	Corr. Ampl.	Limit	Margin
MHz	dB μ V/m	Degree	Meter	H/V	dB μ V/m	dB μ V/m	dB	dB μ V/m	dB μ V/m	dB
80.52	47.3	310	1.5	h	11.8	2.2	28.4	32.9	40	-7.1
73.20	47.1	45	1.5	v	11.8	2.2	28.8	32.3	40	-7.7
143.10	47.6	0	1.8	v	13.7	2.1	28.1	35.3	43.5	-8.2
880.23	47.3	250	1.5	v	13.7	2.1	27.9	35.2	46	-10.8
190.32	44.5	160	1.5	v	13.7	2.1	27.9	32.4	43.5	-11.1
328.45	46.6	30	1.8	v	13.7	2.1	28.1	34.3	46	-11.7
249.27	43.8	90	1.2	v	11.5	2.2	28.9	28.6	43.5	-14.9
40.30	36.9	230	1.2	h	11.5	2.2	28.9	21.7	40	-18.3
228.85	42.5	15	1.5	v	11.8	2.2	28.8	27.7	46	-18.3
270.04	39.7	110	1.5	h	11.8	2.2	28.4	25.3	46	-20.7

5GHz Test Data with Antenna MA-WA58-1X**802.11a, 5250 – 5350MHz, low band (15.407)**

INDICATED			TABLE	ANTENNA		CORRECTION FACTOR			CORRECTED AMPLITUDE	FCC 15 SUBPART C	
Frequency	Ampl.	Comments	Angle	Height	Polar	Antenna	Cable	Amp.	Corr. Ampl.	Limit	Margin
MHz	dBμV/m		Degree	Meter	H/V	dBμV/m	DB	DB	dBμV/m	dBμV/m	dB
Low Channel, 1-25GHz											
5280.00	112.5	Fund/Peak	0	1.6	v	33.9	3.2	34.4	115.2		
5280.00	97.2	Fund/Peak	0	1.5	h	33.9	3.2	34.4	99.9		
5280.00	103.2	Fund/Ave.	0	1.6	v	33.9	3.2	34.4	105.9		
5280.00	88.4	Fund/Ave.	0	1.5	h	33.9	3.2	34.4	91.1		
5250.00	62.7	Peak	0	1.6	v	33.9	3.2	34.4	65.4	68.3	-2.9
5250.00	54.1	Peak	0	1.5	h	33.9	3.2	34.4	56.8	68.3	-11.5
10560.00	32.9	Ave.	45	1.2	v	34.1	3.4	33.5	36.9	54	-17.1
10560.00	31.8	Ave.	290	1.5	h	34.1	3.4	33.5	35.8	54	-18.2
10560.00	43.1	Peak	45	1.2	v	34.1	3.4	33.5	47.1	74	-26.9
10560.00	42.4	Peak	290	1.5	h	34.1	3.4	33.5	46.4	74	-27.6
Middle Channel, 1-25GHz											
5300.00	112.7	Fund/Peak	0	1.6	v	33.9	3.2	34.4	115.4		
5300.00	97.5	Fund/Peak	0	1.5	h	33.9	3.2	34.4	100.2		
5300.00	103.4	Fund/Ave.	0	1.6	v	33.9	3.2	34.4	106.1		
5300.00	88.7	Fund/Ave.	0	1.5	h	33.9	3.2	34.4	91.4		
10600.00	32.8	Ave.	180	1.5	v	34.1	3.4	33.5	36.8	54	-17.2
10600.00	31.6	Ave.	230	1.2	h	34.1	3.4	33.5	35.6	54	-18.4
10600.00	43.3	Peak	180	1.5	v	34.1	3.4	33.5	47.3	74	-26.7
10600.00	42.1	Peak	230	1.2	h	34.1	3.4	33.5	46.1	74	-27.9

INDICATED			TABLE	ANTENNA		CORRECTION FACTOR			CORRECTED AMPLITUDE	FCC 15 SUBPART C	
Frequency	Ampl.	Comments	Angle	Height	Polar	Antenna	Cable	Amp.	Corr. Ampl.	Limit	Margin
MHz	dB μ V/m		Degree	Meter	H/V	dB μ V/m	DB	DB	dB μ V/m	dB μ V/m	dB
High Channel, 1-25GHz											
5320.00	112.2	Fund/Peak	0	1.5	v	33.9	3.2	34.4	114.9		
5320.00	97.1	Fund/Peak	0	1.5	h	33.9	3.2	34.4	99.8		
5320.00	102.9	Fund/Ave.	0	1.5	v	33.9	3.2	34.4	105.6		
5320.00	88.2	Fund/Ave.	0	1.5	h	33.9	3.2	34.4	90.9		
5351.00	48.2	Ave.	0	1.2	v	33.9	3.2	34.4	50.9	54	-3.1
5351.00	63.2	Peak	0	1.2	v	33.9	3.2	34.4	65.9	74	-8.1
5351.00	39.9	Ave.	0	1.5	h	33.9	3.2	34.4	42.6	54	-11.4
10640.00	32.7	Ave.	310	1.2	v	34.1	3.4	33.5	36.7	54	-17.3
10640.00	31.5	Ave.	110	1.5	h	34.1	3.4	33.5	35.5	54	-18.5
5351.00	51.8	Peak	0	1.5	h	33.9	3.2	34.4	54.5	74	-19.5
10640.00	42.8	Peak	310	1.2	v	34.1	3.4	33.5	46.8	74	-27.2
10640.00	42.1	Peak	110	1.5	h	34.1	3.4	33.5	46.1	74	-27.9

Note:

FUND = Fundamental

AVG = average

Unintentional Emission

Indicated			Table	Antenna		Correction Factor			FCC 15 Subpart B	
Frequency	Ampl.	Direction	Height	Polar	Antenna	Cable Loss	Amp.	Corr. Ampl.	Limit	Margin
MHz	dB μ V/m	Degree	Meter	H/V	dB μ V/m	dB μ V/m	dB	dB μ V/m	dB μ V/m	dB
80.52	47.5	330	1.5	h	11.8	2.2	28.4	33.1	40	-6.9
73.20	46.8	60	1.2	v	11.8	2.2	28.8	32.0	40	-8.0
143.10	47.3	15	1.4	v	13.7	2.1	28.1	35.0	43.5	-8.5
880.23	47.6	270	1.5	v	13.7	2.1	27.9	35.5	46	-10.5
190.30	44.8	180	1.5	v	13.7	2.1	27.9	32.7	43.5	-10.8
328.45	46.8	60	1.5	v	13.7	2.1	28.1	34.5	46	-11.5
249.22	43.7	60	1.2	v	11.5	2.2	28.9	28.5	46	-17.5
228.85	43.1	0	1.5	v	11.8	2.2	28.8	28.3	46	-17.7
40.30	36.9	270	1.5	h	11.5	2.2	28.9	21.7	40	-18.3
270.04	39.9	120	1.8	h	11.8	2.2	28.4	25.5	46	-20.5

802.11a, 5725 – 5825MHz, high band (15.247)

INDICATED			TABLE	ANTENNA		CORRECTION FACTOR			CORRECTED AMPLITUDE	FCC 15 SUBPART C	
Frequency	Ampl.	Comments	Angle	Height	Polar	Antenna	Cable	Amp.	Corr. Ampl.	Limit	Margin
MHz	dBμV/m		Degree	Meter	H/V	dBμV/m	DB	DB	dBμV/m	dBμV/m	dB
Low Channel, 1-25GHz											
5745.00	112.3	Fund/Peak	0	1.6	v	34.1	3.4	34.5	115.3		
5745.00	96.9	Fund/Peak	0	1.5	h	34.1	3.4	34.5	99.9		
5745.00	102.8	Fund/Ave.	0	1.6	v	34.1	3.4	34.5	105.8		
5745.00	88.1	Fund/Ave.	0	1.5	h	34.1	3.4	34.5	91.1		
5725.00	60.9	Peak	0	1.6	v	34.1	3.4	34.5	63.9	68.3	-4.4
5725.00	57.8	Peak	0	1.5	h	34.1	3.4	34.5	60.8	68.3	-7.5
11490.00	32.7	Ave.	180	1.2	v	34.1	3.4	33.5	36.7	54	-17.3
11490.00	31.6	Ave.	120	1.5	h	34.1	3.4	33.5	35.6	54	-18.4
11490.00	42.8	Peak	180	1.2	v	34.1	3.4	33.5	46.8	74	-27.2
11490.00	42.2	Peak	120	1.5	h	34.1	3.4	33.5	46.2	74	-27.8
Middle Channel, 1-25GHz											
5785.00	112.4	Fund/Peak	0	1.5	v	34.1	3.4	34.5	115.4		
5785.00	97.1	Fund/Peak	0	1.6	h	34.1	3.4	34.5	100.1		
5785.00	102.9	Fund/Ave.	0	1.5	v	34.1	3.4	34.5	105.9		
5785.00	88.3	Fund/Ave.	0	1.6	h	34.1	3.4	34.5	91.3		
11570.00	32.8	Ave.	270	1.5	v	34.1	3.4	33.5	36.8	54	-17.2
11570.00	31.7	Ave.	230	1.5	h	34.1	3.4	33.5	35.7	54	-18.3
11570.00	42.9	Peak	270	1.5	v	34.1	3.4	33.5	46.9	74	-27.1
11570.00	42.4	Peak	230	1.5	h	34.1	3.4	33.5	46.4	74	-27.6

INDICATED			TABLE	ANTENNA		CORRECTION FACTOR			CORRECTED AMPLITUDE	FCC 15 SUBPART C	
Frequency	Ampl.	Comments	Angle	Height	Polar	Antenna	Cable	Amp.	Corr. Ampl.	Limit	Margin
MHz	dB μ V/ m		Degree	Meter	H/V	dB μ V/m	DB	DB	dB μ V/m	dB μ V/m	dB
High Channel, 1-25GHz											
5805.00	112.1	Fund/Peak	0	1.5	v	34.1	3.4	34.5	115.1		
5805.00	96.7	Fund/Peak	0	1.2	h	34.1	3.4	34.5	99.7		
5805.00	102.6	Fund/Ave.	0	1.5	v	34.1	3.4	34.5	105.6		
5805.00	87.9	Fund/Ave.	0	1.2	h	34.1	3.4	34.5	90.9		
5836.40	61.3	Peak	0	1.5	v	34.1	3.4	35.2	63.6	68.3	-4.7
5836.40	54.2	Peak	0	1.2	h	34.1	3.4	35.2	56.5	68.3	-11.8
11610.00	32.6	Ave.	180	1.5	v	34.1	3.4	33.5	36.6	54	-17.4
11610.00	31.5	Ave.	60	1.5	h	34.1	3.4	33.5	35.5	54	-18.5
11610.00	42.7	Peak	180	1.5	v	34.1	3.4	33.5	46.7	74	-27.3
11610.00	42.1	Peak	60	1.5	h	34.1	3.4	33.5	46.1	74	-27.9

Note:

FUND = Fundamental

AVG = average

Unintentional Emission

Indicated			Table	Antenna		Correction Factor			FCC 15 Subpart B	
Frequency	Ampl.	Direction	Height	Polar	Antenna	Cable Loss	Amp.	Corr. Ampl.	Limit	Margin
MHz	dB μ V/m	Degree	Meter	H/V	dB μ V/m	dB μ V/m	dB	dB μ V/m	dB μ V/m	dB
80.52	47.5	330	1.5	h	11.8	2.2	28.4	33.1	40	-6.9
73.20	46.8	60	1.2	v	11.8	2.2	28.8	32.0	40	-8.0
143.10	47.3	15	1.4	v	13.7	2.1	28.1	35.0	43.5	-8.5
880.23	47.6	270	1.5	v	13.7	2.1	27.9	35.5	46	-10.5
190.30	44.8	180	1.5	v	13.7	2.1	27.9	32.7	43.5	-10.8
328.45	46.8	60	1.5	v	13.7	2.1	28.1	34.5	46	-11.5
249.22	43.7	60	1.2	v	11.5	2.2	28.9	28.5	46	-17.5
228.85	43.1	0	1.5	v	11.8	2.2	28.8	28.3	46	-17.7
40.30	36.9	270	1.5	h	11.5	2.2	28.9	21.7	40	-18.3
270.04	39.9	120	1.8	h	11.8	2.2	28.4	25.5	46	-20.5

2.4 GHz Test Data with Antenna MA-WA24-1XP**802.11b (15.247)**

INDICATED			TABLE	ANTENNA		CORRECTION FACTOR			CORRECTED AMPLITUDE	FCC 15 SUBPART C	
Frequency	Ampl.	Comments	Angle	Height	Polar	Antenna	Cable	Amp.	Corr. Ampl.	Limit	Margin
MHz	dB μ V/m		Degree	Meter	H/V	dB μ V/m	DB	DB	dB μ V/m	dB μ V/m	dB
Low Channel, 1-25GHz											
2412.00	109.9	Fund/Peak	0	1.5	v	28.1	2.0	35.5	104.5		
2412.00	94.6	Fund/Peak	0	1.5	h	28.1	2.0	35.5	89.2		
2412.00	100.5	Fund/Ave.	0	1.5	v	28.1	2.0	35.5	95.1		
2412.00	85.4	Fund/Ave.	0	1.5	h	28.1	2.0	35.5	80.0		
4824.00	37.6	Ave.	180	1.6	v	32.5	3.1	34.6	38.6	54	-15.4
2390.00	43.2	Ave.	0	1.5	v	28.1	2.0	35.5	37.8	54	-16.2
4824.00	31.5	Ave.	230	1.5	h	32.5	3.1	34.6	32.5	54	-21.5
2390.00	37.3	Ave.	0	1.5	h	28.1	2.0	35.5	31.9	54	-22.1
2390.00	54.4	Peak	0	1.5	v	28.1	2.0	35.5	49.0	74	-25.0
4824.00	44.6	Peak	180	1.6	v	32.5	3.1	34.6	45.6	74	-28.4
2390.00	49.1	Peak	0	1.5	h	28.1	2.0	35.5	43.7	74	-30.3
4824.00	38.3	Peak	230	1.5	h	32.5	3.1	34.6	39.3	74	-34.7
Middle Channel, 1-25GHz											
2442.00	109.7	Fund/Peak	0	1.5	v	28.1	2.0	35.2	104.6		
2442.00	94.3	Fund/Peak	0	1.2	h	28.1	2.0	35.2	89.2		
2442.00	100.2	Fund/Ave.	0	1.5	v	28.1	2.0	35.2	95.1		
2442.00	85.1	Fund/Ave.	0	1.2	h	28.1	2.0	35.2	80.0		
4884.00	37.4	Ave.	210	1.5	v	32.5	3.1	34.6	38.4	54	-15.6
4884.00	31.2	Ave.	230	1.5	h	32.5	3.1	34.6	32.2	54	-21.8
4884.00	44.3	Peak	210	1.5	v	32.5	3.1	34.6	45.3	74	-28.7
4884.00	38.1	Peak	230	1.5	h	32.5	3.1	34.6	39.1	74	-34.9

INDICATED			TABLE	ANTENNA		CORRECTION FACTOR			CORRECTED AMPLITUDE	FCC 15 SUBPART C	
Frequency	Ampl.	Comments	Angle	Height	Polar	Antenna	Cable	Amp.	Corr. Ampl.	Limit	Margin
MHz	dB μ V/m		Degree	Meter	H/V	dB μ V/m	DB	DB	dB μ V/m	dB μ V/m	dB
High Channel, 1-25GHz											
2462.00	109.8	Fund/Peak	0	1.6	v	28.1	2.0	35.2	104.7		
2462.00	94.4	Fund/Peak	0	1.5	h	28.1	2.0	35.2	89.3		
2462.00	100.3	Fund/Ave.	0	1.6	v	28.1	2.0	35.2	95.2		
2462.00	85.2	Fund/Ave.	0	1.5	h	28.1	2.0	35.2	80.1		
4924.00	37.5	Ave.	270	1.2	v	32.5	3.1	34.6	38.5	54	-15.5
2485.00	41.9	Ave.	0	1.6	v	28.1	2.0	35.2	36.8	54	-17.2
2485.00	39.2	Ave.	0	1.5	h	28.1	2.0	35.2	34.1	54	-19.9
4924.00	31.4	Ave.	120	1.5	h	32.5	3.1	34.6	32.4	54	-21.6
2485.00	51.2	Peak	0	1.6	v	28.1	2.0	35.2	46.1	74	-27.9
4924.00	44.2	Peak	270	1.2	v	32.5	3.1	34.6	45.2	74	-28.8
2485.00	48.1	Peak	0	1.5	h	28.1	2.0	35.2	43.0	74	-31.0
4924.00	38.3	Peak	120	1.5	h	32.5	3.1	34.6	39.3	74	-34.7

Note:

FUND = Fundamental

AVG = average

Unintentional Emission

Indicated			Table	Antenna		Correction Factor			FCC 15 Subpart B	
Frequency	Ampl.	Direction	Height	Polar	Antenna	Cable Loss	Amp.	Corr. Ampl.	Limit	Margin
MHz	dB μ V/m	Degree	Meter	H/V	dB μ V/m	dB μ V/m	dB	dB μ V/m	dB μ V/m	dB
80.52	47.3	330	1.6	h	11.8	2.2	28.4	32.9	40	-7.1
73.20	46.2	60	1.2	v	11.8	2.2	28.8	31.4	40	-8.6
143.10	46.9	15	1.5	v	13.7	2.1	28.1	34.6	43.5	-8.9
190.30	44.5	180	1.5	v	13.7	2.1	27.9	32.4	43.5	-11.1
880.23	47.3	270	1.5	v	11.8	2.2	28.8	32.5	46	-13.5
328.45	46.6	60	1.2	v	11.8	2.2	28.8	31.8	46	-14.2
249.22	43.1	60	1.2	v	11.8	2.2	28.8	28.3	46	-17.7
228.85	42.5	0	1.5	v	11.8	2.2	28.8	27.7	46	-18.3
40.30	36.5	270	1.5	h	11.5	2.2	28.9	21.3	40	-18.7
270.04	39.8	120	1.5	h	11.8	2.2	28.8	25.0	46	-21.0

802.11g (15.247)

INDICATED			TABLE	ANTENNA		CORRECTION FACTOR			CORRECTED AMPLITUDE	FCC 15 SUBPART C	
Frequency	Ampl.	Comments	Angle	Height	Polar	Antenna	Cable	Amp.	Corr. Ampl.	Limit	Margin
MHz	dBμV/m		Degree	Meter	H/V	dBμV/m	DB	DB	dBμV/m	dBμV/m	dB
Low Channel, 1-25GHz											
2412.00	109.3	Fund/Peak	0	1.5	v	28.1	2.0	35.5	103.9		
2412.00	94.1	Fund/Peak	0	1.5	h	28.1	2.0	35.5	88.7		
2412.00	99.8	Fund/Ave.	0	1.5	v	28.1	2.0	35.5	94.4		
2412.00	84.7	Fund/Ave.	0	1.5	h	28.1	2.0	35.5	79.3		
2390.00	45.9	Ave.	0	1.5	v	28.1	2.0	35.5	40.5	54	-13.5
4824.00	37.2	Ave.	180	1.6	v	32.5	3.1	34.6	38.2	54	-15.8
2390.00	59.8	Peak	0	1.5	v	28.1	2.0	35.5	54.4	74	-19.6
4824.00	30.8	Ave.	310	1.5	h	32.5	3.1	34.6	31.8	54	-22.2
2390.00	36.6	Ave.	0	1.5	h	28.1	2.0	35.5	31.2	54	-22.8
4824.00	44.1	Peak	180	1.6	v	32.5	3.1	34.6	45.1	74	-28.9
2390.00	48.1	Peak	0	1.5	h	28.1	2.0	35.5	42.7	74	-31.3
4824.00	32.9	Peak	310	1.5	h	32.5	3.1	34.6	33.9	74	-40.1
Middle Channel, 1-25GHz											
2442.00	109.5	Fund/Peak	0	1.5	v	28.1	2.0	35.2	104.4		
2442.00	94.3	Fund/Peak	0	1.2	h	28.1	2.0	35.2	89.2		
2442.00	100.1	Fund/Ave.	0	1.5	v	28.1	2.0	35.2	95.0		
2442.00	84.9	Fund/Ave.	0	1.2	h	28.1	2.0	35.2	79.8		
4884.00	37.4	Ave.	210	1.5	v	32.5	3.1	34.6	38.4	54	-15.6
4884.00	30.9	Ave.	270	1.5	h	32.5	3.1	34.6	31.9	54	-22.1
4884.00	44.3	Peak	210	1.5	v	32.5	3.1	34.6	45.3	74	-28.7
4884.00	33.1	Peak	270	1.5	h	32.5	3.1	34.6	34.1	74	-39.9

INDICATED			TABLE	ANTENNA		CORRECTION FACTOR			CORRECTED AMPLITUDE	FCC 15 SUBPART C	
Frequency	Ampl.	Comments	Angle	Height	Polar	Antenna	Cable	Amp.	Corr. Ampl.	Limit	Margin
MHz	dBμV/m		Degree	Meter	H/V	dBμV/m	DB	DB	dBμV/m	dBμV/m	dB
High Channel, 1-25GHz											
2462.00	109.2	Fund/Peak	0	1.6	v	28.1	2.0	35.2	104.1		
2462.00	93.8	Fund/Peak	0	1.5	h	28.1	2.0	35.2	88.7		
2462.00	99.7	Fund/Ave.	0	1.6	v	28.1	2.0	35.2	94.6		
2462.00	84.5	Fund/Ave.	0	1.5	h	28.1	2.0	35.2	79.4		
2485.00	43.4	Ave.	0	1.6	v	28.1	2.0	35.2	38.3	54	-15.7
4924.00	37.1	Ave.	210	1.2	v	32.5	3.1	34.6	38.1	54	-15.9
2485.00	62.3	Peak	0	1.6	v	28.1	2.0	35.2	57.2	74	-16.8
4924.00	30.6	Ave.	230	1.5	h	32.5	3.1	34.6	31.6	54	-22.4
2485.00	36.5	Ave.	0	1.5	h	28.1	2.0	35.2	31.4	54	-22.6
4924.00	43.9	Peak	210	1.2	v	32.5	3.1	34.6	44.9	74	-29.1
2485.00	48.7	Peak	0	1.5	h	28.1	2.0	35.2	43.6	74	-30.4
4924.00	32.7	Peak	230	1.5	h	32.5	3.1	34.6	33.7	74	-40.3

Note:

FUND = Fundamental

AVG = average

Unintentional Emission

Indicated			Table	Antenna		Correction Factor			FCC 15 Subpart B	
Frequency	Ampl.	Direction	Height	Polar	Antenna	Cable Loss	Amp.	Corr. Ampl.	Limit	Margin
MHz	dBμV/m	Degree	Meter	H/V	dBμV/m	dBμV/m	dB	dBμV/m	dBμV/m	dB
80.52	47.3	330	1.8	h	11.8	2.2	28.4	32.9	40	-7.1
73.20	46.6	60	1.2	v	11.8	2.2	28.8	31.8	40	-8.2
143.10	46.8	15	1.5	v	13.7	2.1	28.1	34.5	43.5	-9.0
190.30	44.5	180	1.5	v	13.7	2.1	27.9	32.4	43.5	-11.1
880.23	47.3	270	1.5	v	11.8	2.2	28.8	32.5	46	-13.5
328.45	46.6	60	1.2	v	11.8	2.2	28.8	31.8	46	-14.2
249.22	43.3	60	1.2	v	11.8	2.2	28.8	28.5	46	-17.5
228.85	42.9	0	1.5	v	11.8	2.2	28.8	28.1	46	-17.9
40.30	36.4	270	1.5	h	11.5	2.2	28.9	21.2	40	-18.8
270.04	39.8	120	1.2	h	11.8	2.2	28.8	25.0	46	-21.0

§15.207(a) - CONDUCTED EMISSIONS

Measurement Uncertainty

All measurements involve certain levels of uncertainties. The factors contributing to uncertainties are spectrum analyzer, cable loss, and LISN.

Based on NIS 81, The Treatment of Uncertainty in EMC Measurements, the best estimate of the uncertainty of any conducted emissions measurement at BACL is ± 2.4 dB.

EUT Setup

The measurement was performed in the shield room, using the same setup per ANSI C63.4-2001 measurement procedure. The specification used was FCC 15 Subpart B limits.

The spacing between the peripherals was 10 centimeters.

External I/O cables were draped along the edge of the test table and bundle when necessary.

The notebook PC was connected with 120Vac/60Hz power source.

Spectrum Analyzer Setup

The EMI test receiver was set to investigate the spectrum from 150 kHz to 30Mhz.

Test Equipment List and Details

Manufacturer	Description	Model	Serial Number	Cal. Date
Rohde & Schwarz	Artificial LISN	ESH2-Z5	871884/039	2004-03-28
Rohde & Schwarz	EMI Test Receiver	ESCS30	100176	2004-05-06

* **Statement of Traceability: BACL Corp.** attests that all calibrations have been performed per the NVLAP requirements, traceable to the NIST.

Test Procedure

During the conducted emission test, the power cord of the host system was connected to the auxiliary outlet of the first LISN.

Maximizing procedure was performed on the six (6) highest emissions of each modes tested to ensure EUT is compliant with all installation combination.

All data was recorded in the peak detection mode. Quasi-peak readings were only performed when an emission was found to be marginal (within -4 dB μ V of specification limits). Quasi-peak readings are distinguished with a "Qp".

Summary of Test Results

According to the data in following table, the EUT complies with the FCC Conducted margin for a Class B device, with the *worst* margin reading of:

-13.3 dB μ V at 1.98 MHz in the Neutral mode

Conducted Emissions Test Data

Environmental Conditions

Temperature:	28° C
Relative Humidity:	37%
ATM Pressure:	1032 mbar

The testing was performed by Ming Jing on 2004-09-23.

LINE CONDUCTED EMISSIONS				FCC PART 15 CLASS B	
Frequency MHz	Amplitude dB μ V	Detector Qp/Ave/Peak	Phase Line/Neutral	Limit dB μ V	Margin dB
1.98	32.7	Ave	Neutral	46	-13.3
1.98	31.8	Ave	Line	46	-14.2
2.73	28.5	Ave	Neutral	50	-21.5
1.98	34.2	QP	Neutral	56	-21.8
2.73	27.2	Ave	Line	50	-22.8
1.98	32.3	QP	Line	56	-23.7
2.73	34.4	QP	Neutral	60	-25.6
2.73	33.4	QP	Line	60	-26.6
0.15	36.4	QP	Line	66	-29.6
0.15	36.2	QP	Neutral	66	-29.8
0.15	13.5	Ave	Neutral	56	-42.5
0.15	5.1	Ave	Line	56	-50.9

Plot of Conducted Emissions Test Data

Plot(s) of Conducted Emissions Test Data is presented hereinafter as reference.

Bay Area Compliance Laboratory Corp
Class B

23. Sep 04 18:53

EUT: MP11r
Manuf: Proxim
Op Cond: Normal
Operator: Ming
Comment: L

Scan Settings (3 Ranges)			Receiver Settings				
Start	Stop	Step	IF BW	Detector	M-Time	Atten	Preamp
150k	1M	5k	9k	QP+AV	1ms	15dB LN	OFF
1M	5M	10k	9k	QP+AV	1ms	15dB LN	OFF
5M	30M	100k	9k	QP+AV	1ms	15dB LN	OFF

M 2004.9.23

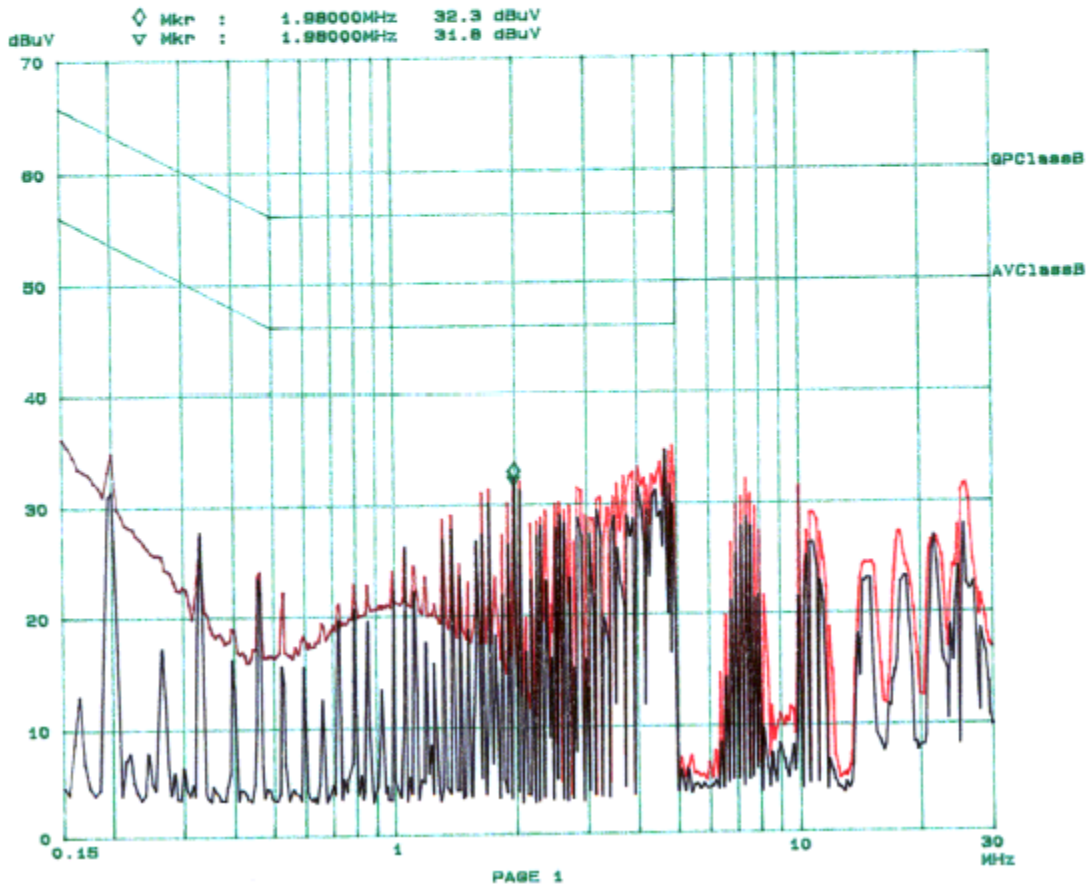

Bay Area Compliance Laboratory Corp Class B

23. Sep 04 19:19

EUT: MP11R
Manuf: Proxim
Op Cond: Normal
Operator: Ming
Comment: N

Scan Settings (3 Ranges)			Receiver Settings					
Start	Stop	Step	IF BW	Detector	M-Time	Atten	Preamp	
150k	1M	5k	9k	QP+AV	1ms	15dB	OFF	
1M	5M	10k	9k	QP+AV	1ms	15dB	OFF	
5M	30M	100k	9k	QP+AV	1ms	15dB	OFF	

Ming 2004-9-23

◇ Mkr : 1.98000MHz 34.2 dBuV
▽ Mkr : 1.98000MHz 32.7 dBuV

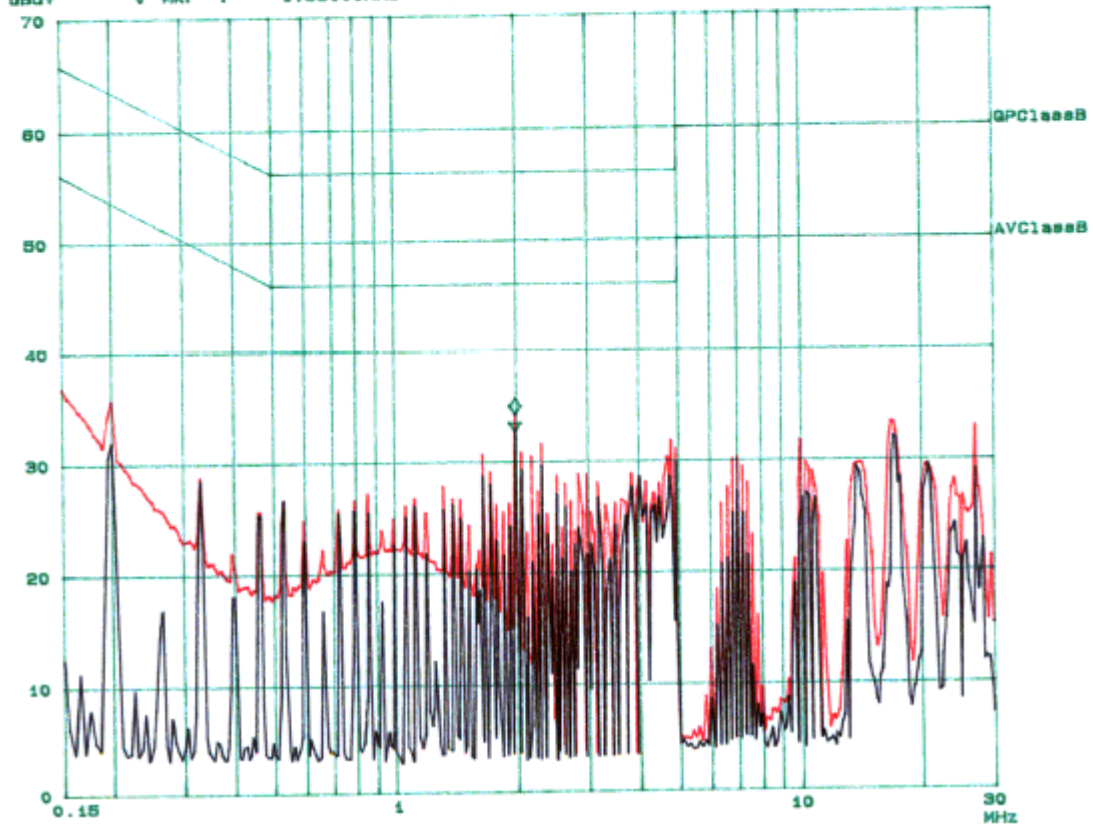

PAGE 1

§15.209(a) - SPURIOUS EMISSION

Standard Applicable

According to §15.209 (a), except as provided elsewhere in the subpart of 15.209, the emissions from an intentional radiator shall not exceed the field strength levels specified in the following table:

Frequency (MHz)	Measurement Field strength (microvolts/meter)	distance (meters)
0.009-0.490.....	2400/F(kHz)	300
0.490-1.705.....	24000/F(kHz)	30
1.705-30.0.....	30	30
30-88.....	100 **	3
88-216.....	150 **	3
216-960.....	200 **	3
Above 960.....	500	3

** Except as provided in paragraph (g), fundamental emissions from intentional radiators operating under this section shall not be located in the frequency bands 54-72 MHz, 76-88 MHz, 174-216 MHz or 470-806 MHz. However, operation within these frequency bands is permitted under other sections of this part, e.g., §§ 15.231 and 15.241

Measurement Procedure

1. Check the calibration of the measuring instrument (SA) using either an internal calibrator or a known signal from an external generator.
2. Position the EUT as shown in figure 4 without connection to measurement instrument. Turn on the EUT and connect its antenna terminal to measurement instrument via a low loss cable. Then set it to any one measured frequency within its operating range, and make sure the instrument is operated in its linear range.
3. Set the SA on Max-Hold Mode, and then keep the EUT in transmitting mode. Record all the signals from each channel until each one has been recorded.
4. Set the SA on View mode and then plot the result on SA screen.
5. Repeat above procedures until all frequencies measured were complete.

Equipment Lists

Manufacturer	Model No.	Description	Calibration Date
HP	8565EC	Spectrum Analyzer	2004-01-22

* **Statement of Traceability: BACL Corp.** attests that all calibrations have been performed per the NVLAP requirements, traceable to the NIST.

Measurement Result**Environmental Conditions**

Temperature:	28° C
Relative Humidity:	37%
ATM Pressure:	1032 mbar

The 2.4GHz testing was performed by Ming Jing on 2004-08-21.

Temperature:	24° C
Relative Humidity:	35%
ATM Pressure:	1031 mbar

The 5GHz testing was performed by Ling Zhang on 2004-08-14.

Please refer to following pages for plots of spurious emission.

Plots of Spurious Emission for 802.11b (15.247)

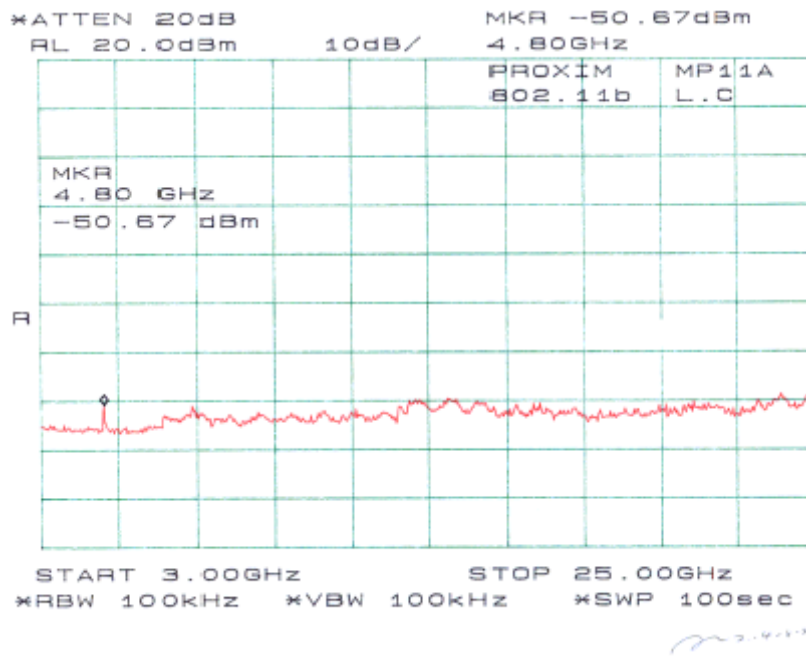
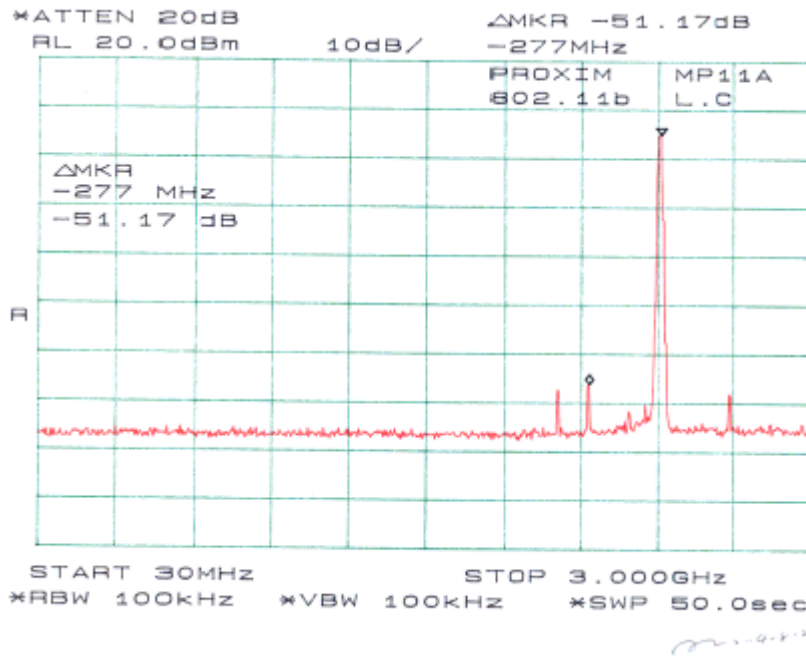

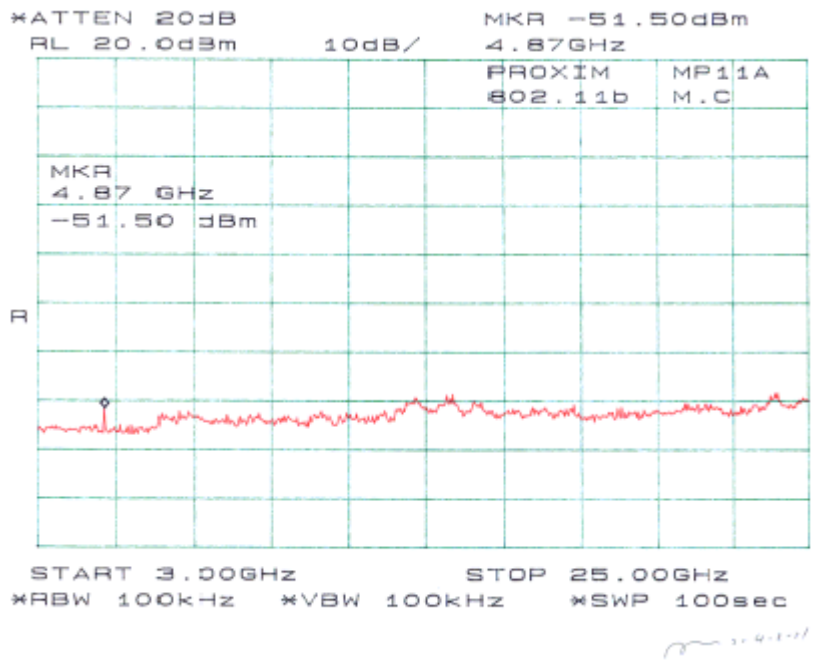
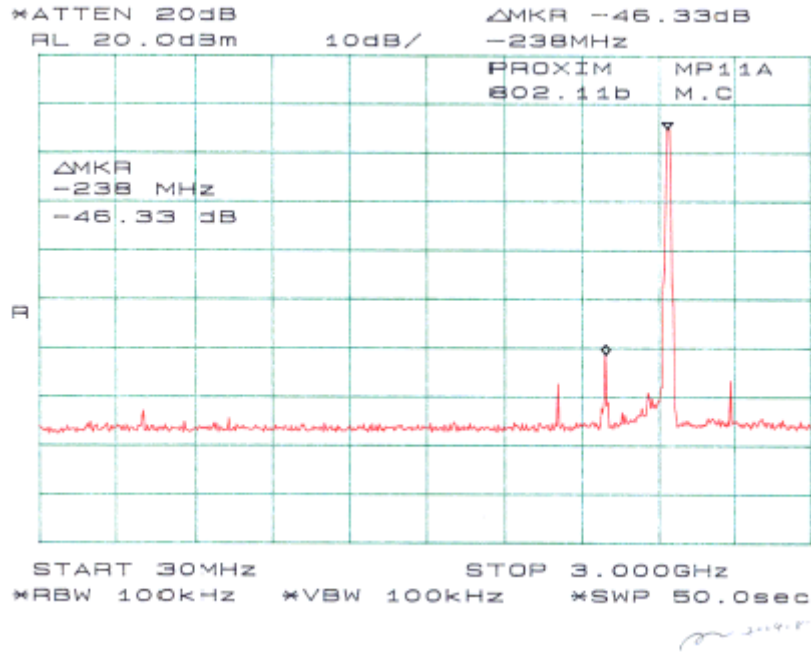

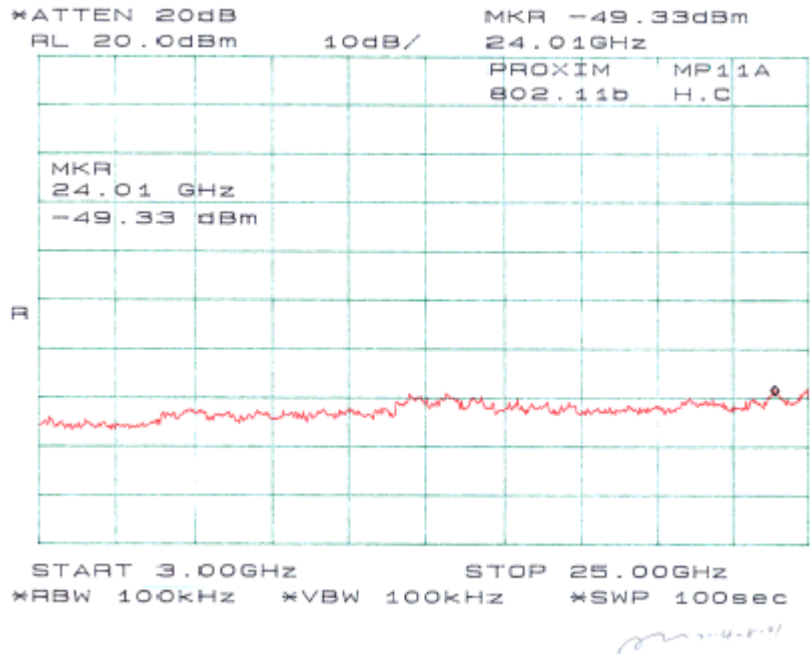
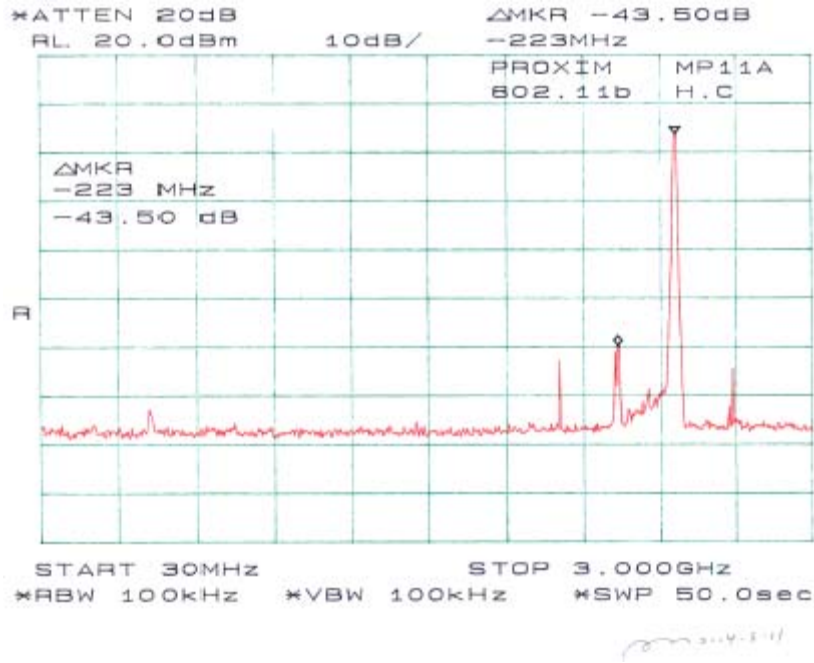

Plots of Spurious Emission for 802.11g (15.247)

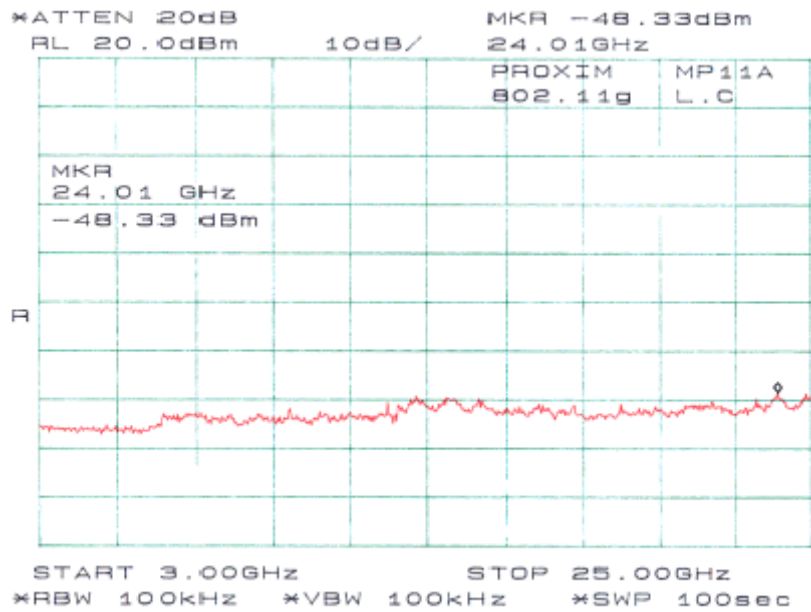
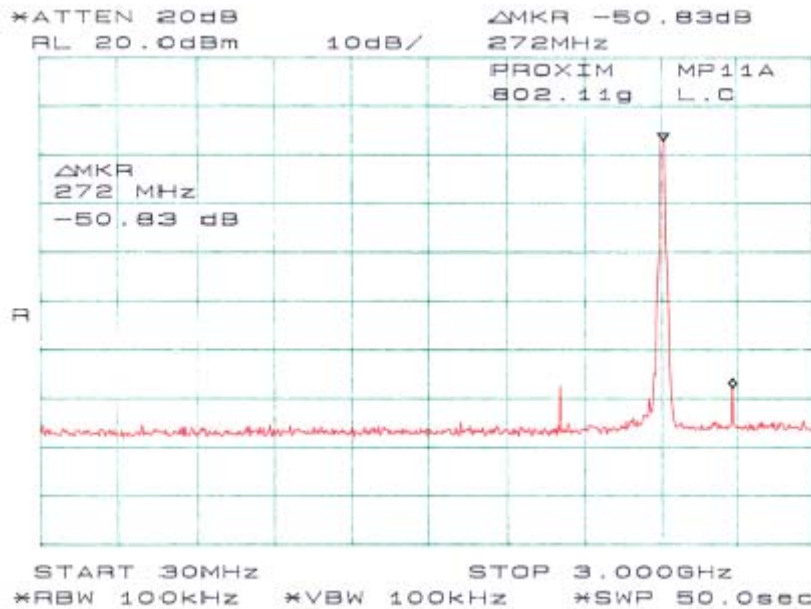

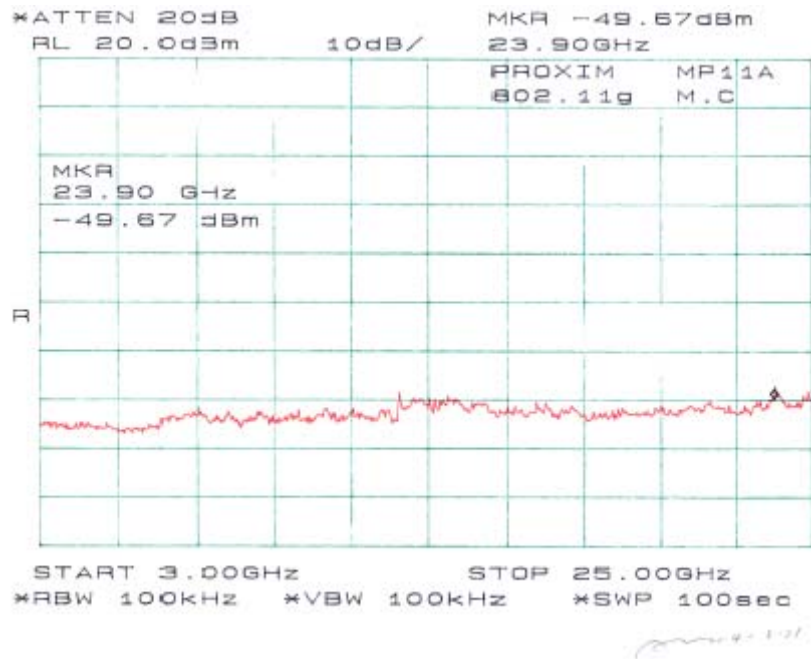
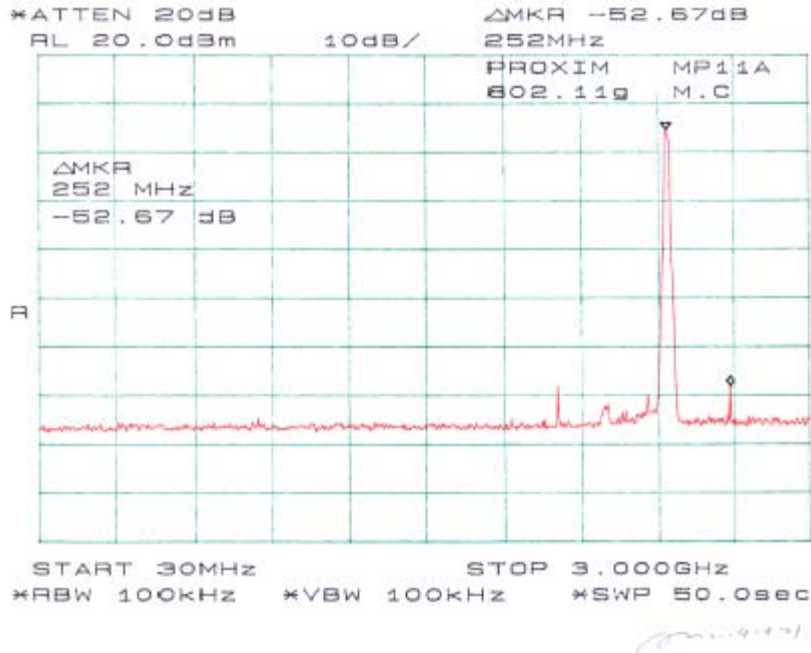

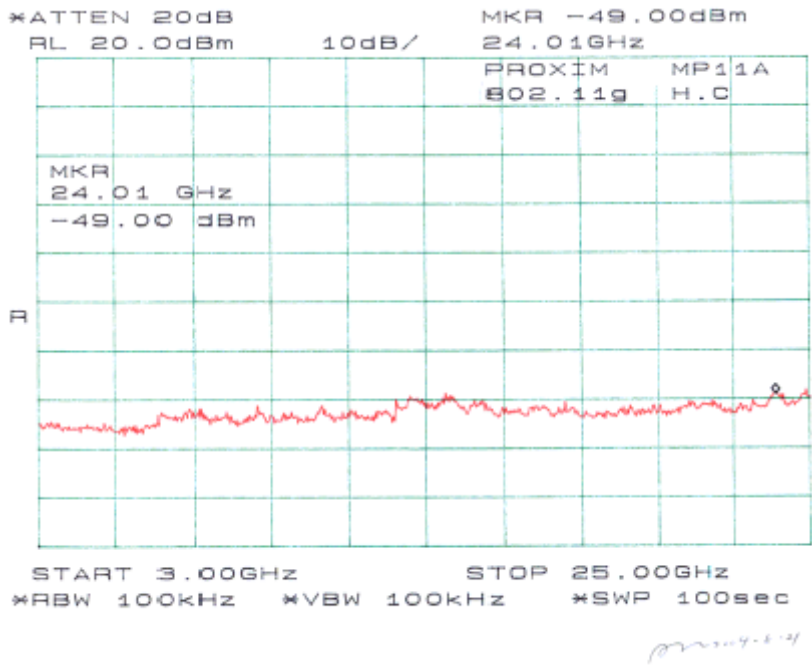
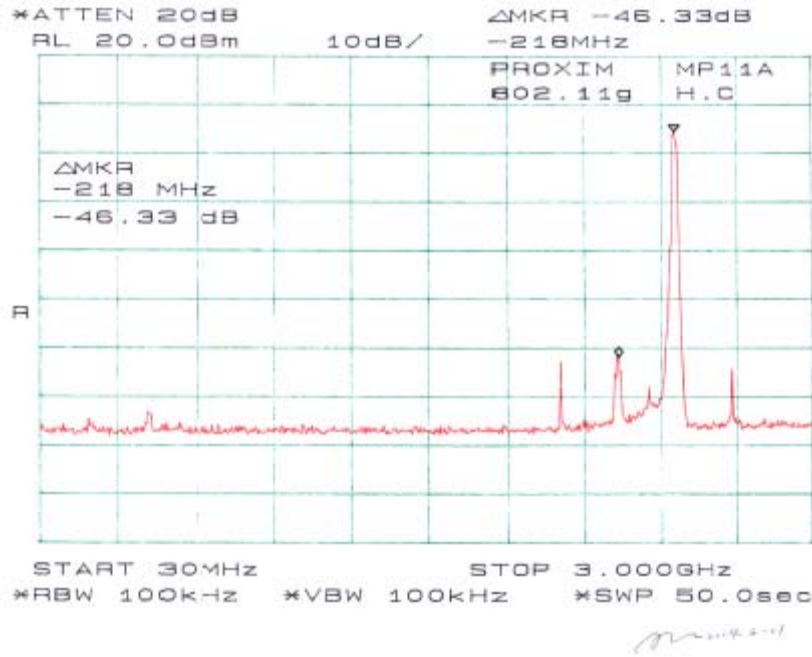

Plots of Spurious Emission for 802.11a (15.247), high band

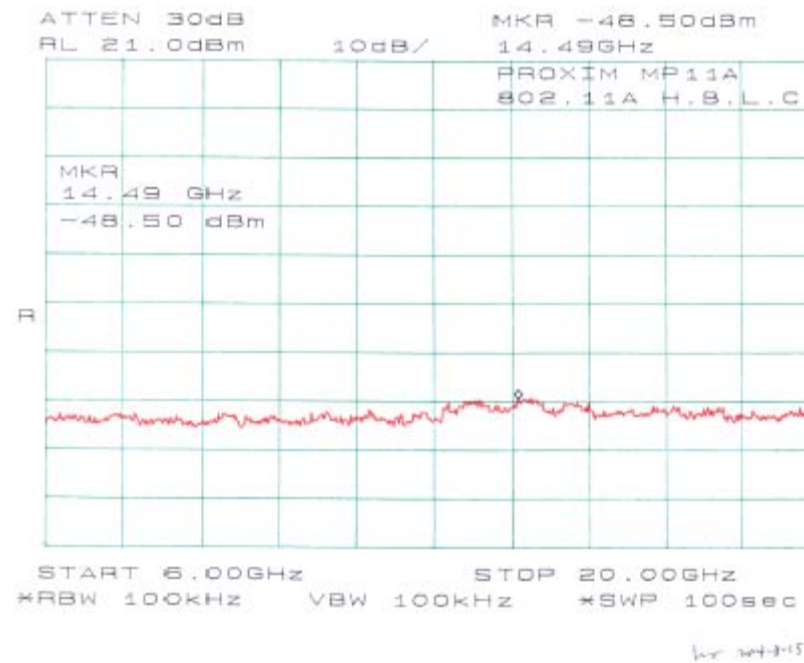
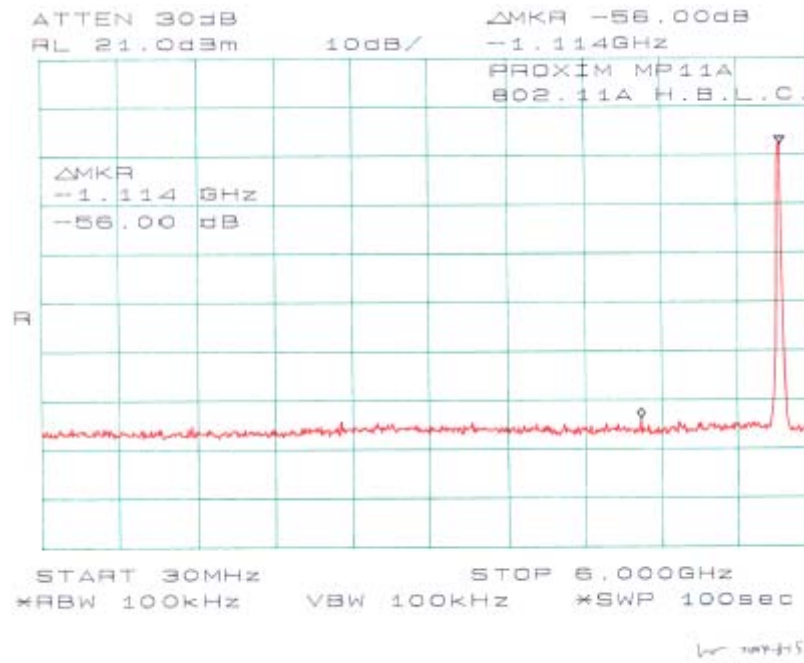

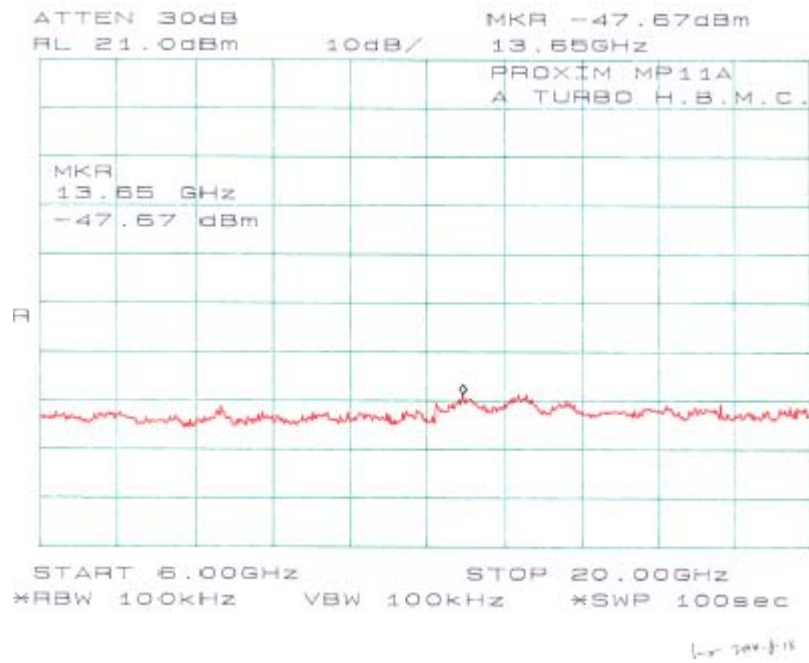
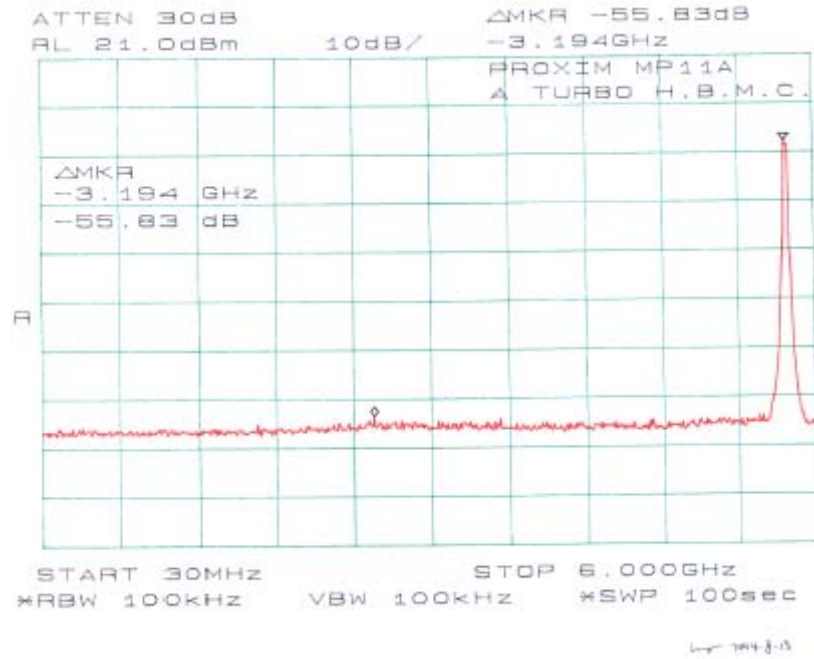

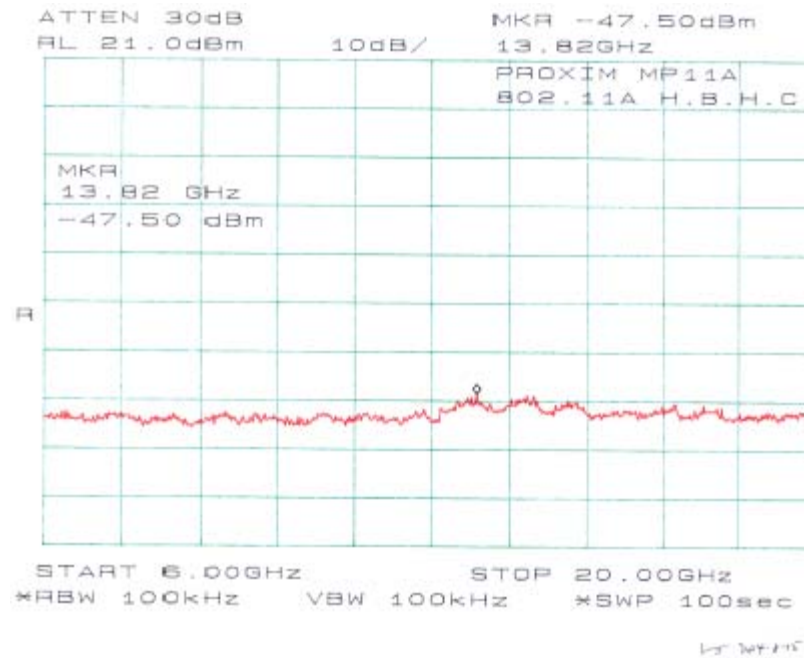
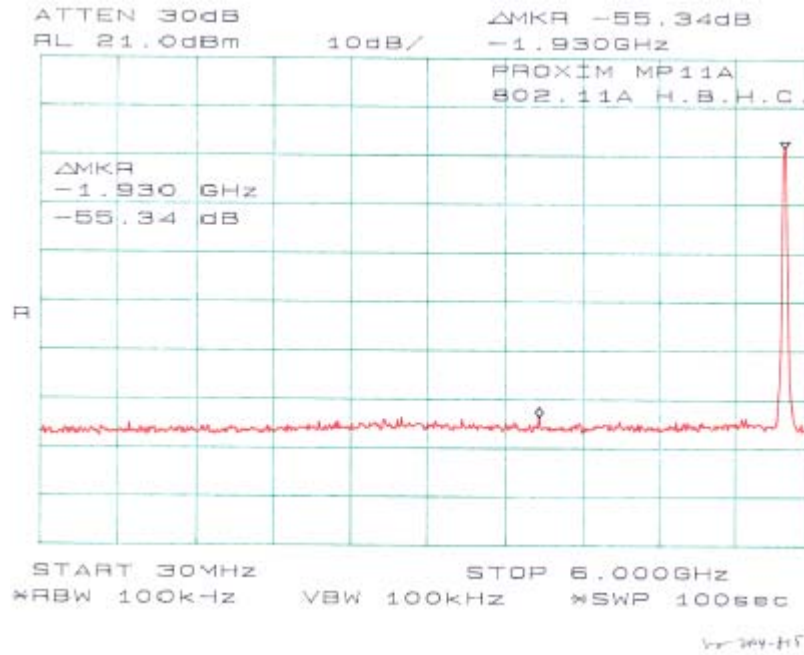

Plots of Spurious Emission for 802.11a (15.407), low band

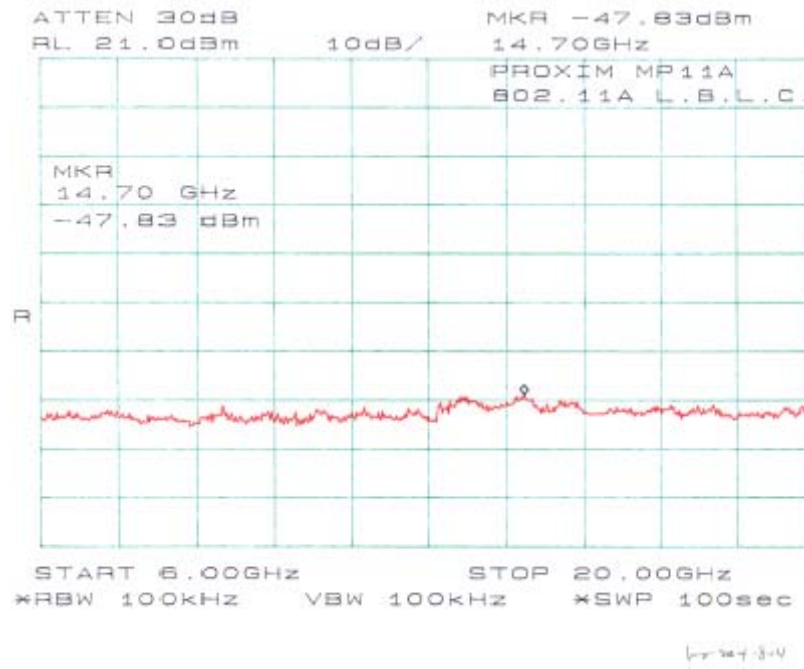
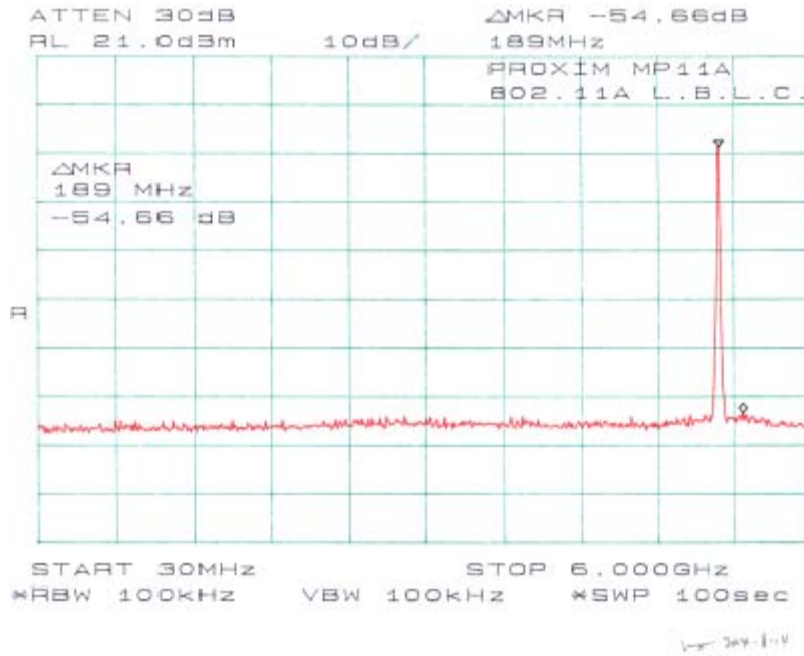

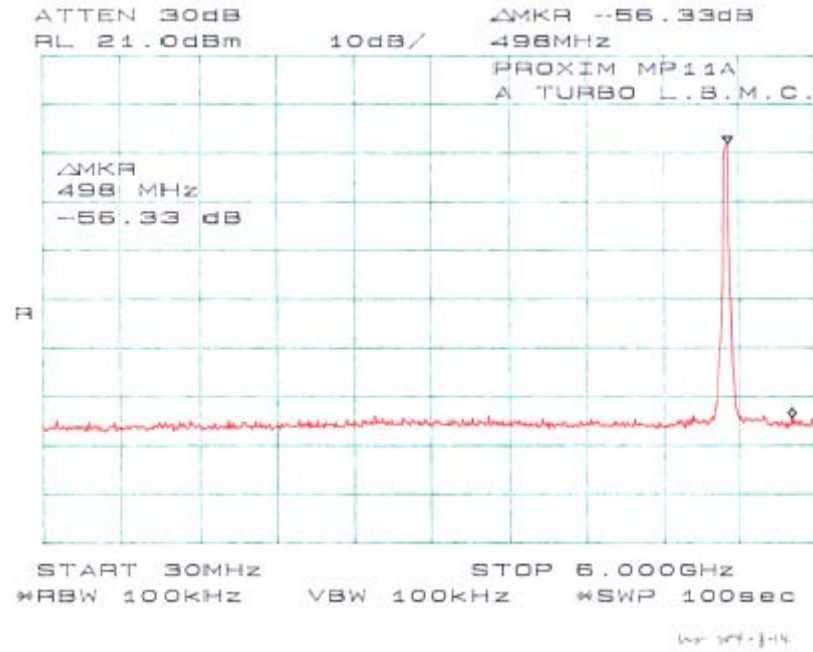

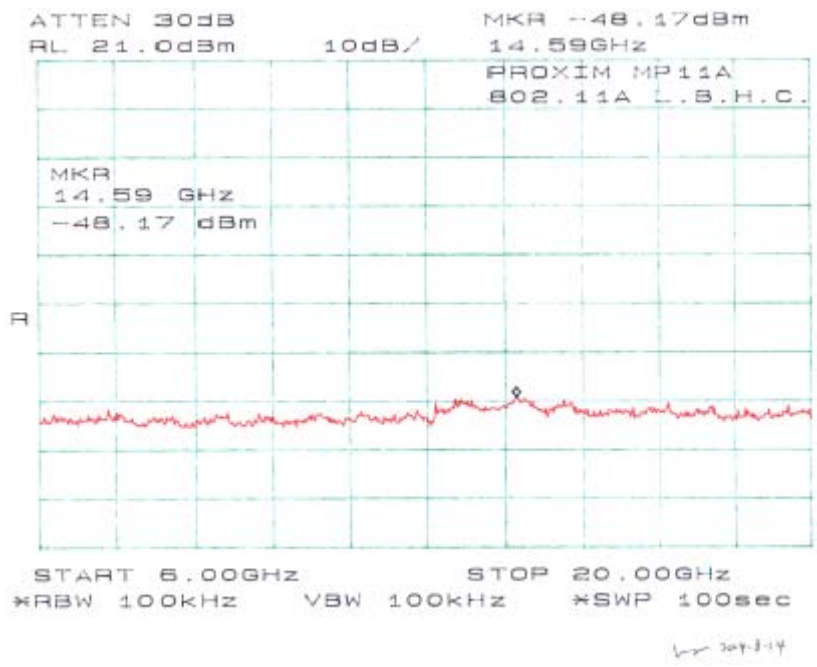
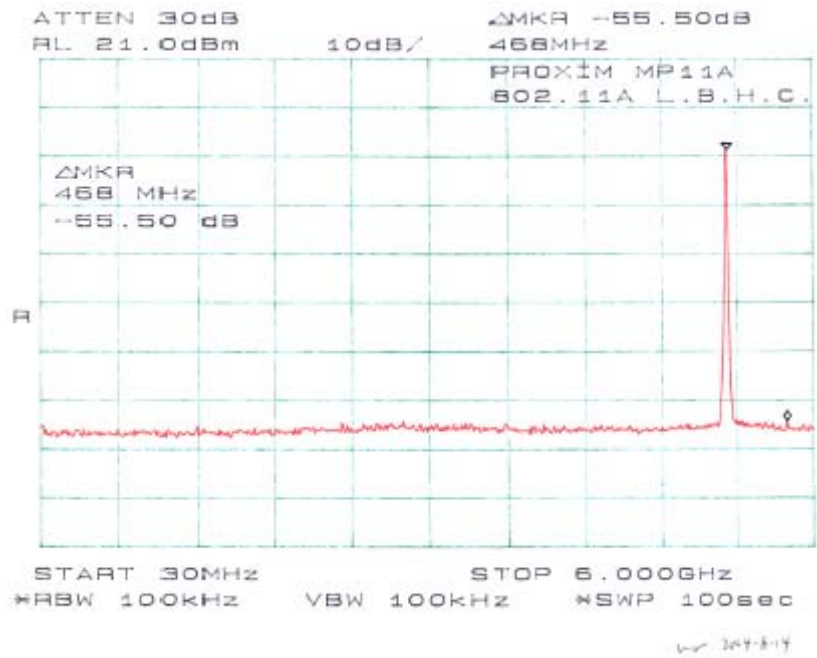

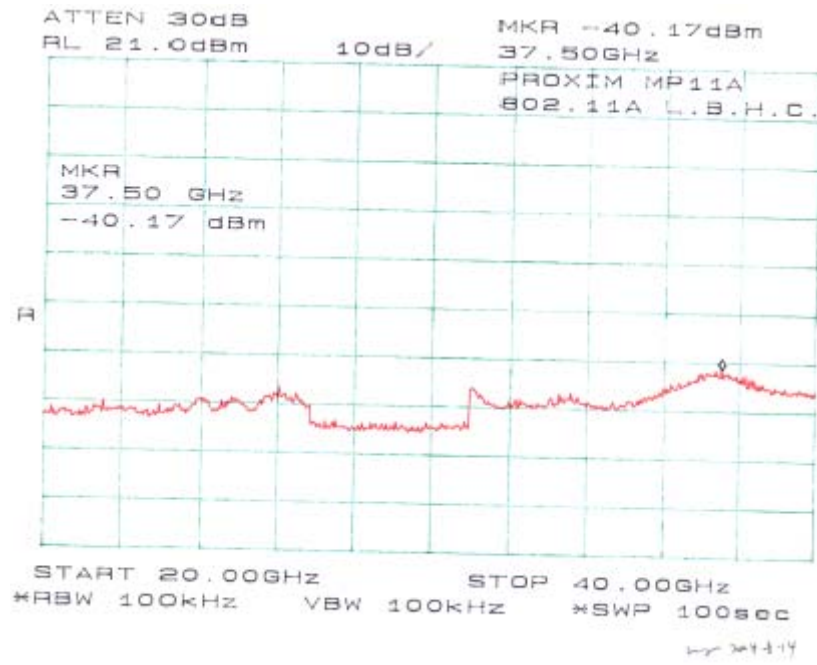

§15.247(a)(2) & §15.407 – 6 DB BANDWIDTH and 26 DB BANDWIDTH

Standard Applicable

According to §15.247(a)(2), for direct sequence systems, the minimum 6dB bandwidth shall be at least 500 kHz. According to §15.407, 26dB Bandwidth should be shown.

Measurement Procedure

1. Check the calibration of the measuring instrument using either an internal calibrator or a known signal from an external generator.
2. Position the EUT without connection to measurement instrument. Turn on the EUT and connect it to measurement instrument. Then set it to any one convenient frequency within its operating range. Set a reference level on the measuring instrument equal to the highest peak value.
3. Measure the frequency difference of two frequencies that were attenuated 6 dB from the reference level. Record the frequency difference as the emission bandwidth. (6 dB bandwidth for DTS)
4. Same as (3) except 26 dB. (26dB bandwidth for UNII)
5. Repeat above procedures until all frequencies measured were complete.

Equipment Lists

Manufacturer	Model No.	Description	Calibration Date
HP	8565EC	Spectrum Analyzer	2004-01-22

* **Statement of Traceability: BACL Corp.** attests that all calibrations have been performed per the NVLAP requirements, traceable to the NIST.

Measurement Result

Environmental Conditions

Temperature:	28° C
Relative Humidity:	37%
ATM Pressure:	1032 mbar

The 2.4GHz testing was performed by Ming Jing on 2004-08-21.

Temperature:	24° C
Relative Humidity:	35%
ATM Pressure:	1031 mbar

The 5GHz testing was performed by Ling Zhang on 2004-08-14.

Please refer to following pages for plots of spurious emission.

Test Result for 802.11b (15.247)

Channel	Frequency (MHz)	Measured (MHz)	Standard (kHz)	Result
Low	2412	12.00 MHz	≥ 500	Compliant
Mid	2442	12.08 MHz	≥ 500	Compliant
High	2462	12.25 MHz	≥ 500	Compliant

Test Result for 802.11g (15.247)

Channel	Frequency (MHz)	Measured (MHz)	Standard (kHz)	Result
Low	2412	16.67	≥ 500	Compliant
Mid	2442	16.83	≥ 500	Compliant
High	2462	16.75	≥ 500	Compliant

Test Result for 802.11a (15.247)**HIGH BAND**

Channel	Frequency (MHz)	Measured (MHz)	Standard (kHz)	Result
Low	5745	16.67	≥ 500	Compliant
Mid	5785	33.00	≥ 500	Compliant
High	5825	16.67	≥ 500	Compliant

Test Result for 802.11a (15.407)**LOW BAND:**

Channel	Frequency (MHz)	Measured (MHz)
Low	5250	24.17
Mid	5300	41.83
High	5320	24.33

Plots of 6dB Bandwidth for 802.11b (15.247)

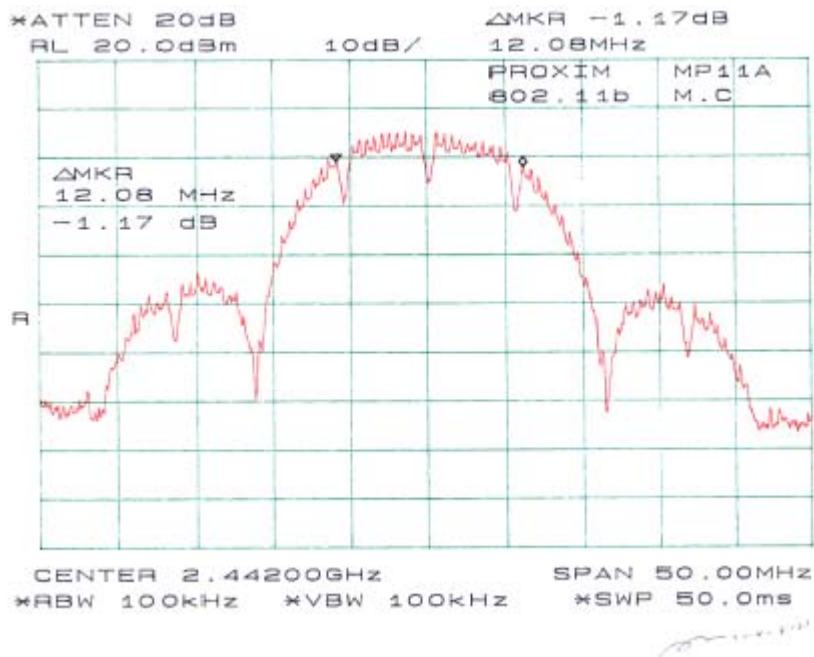
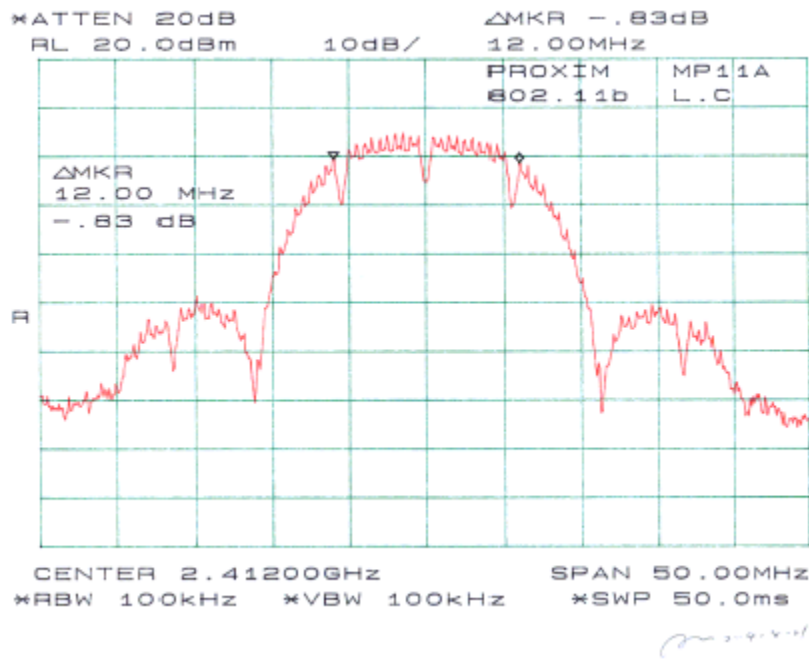

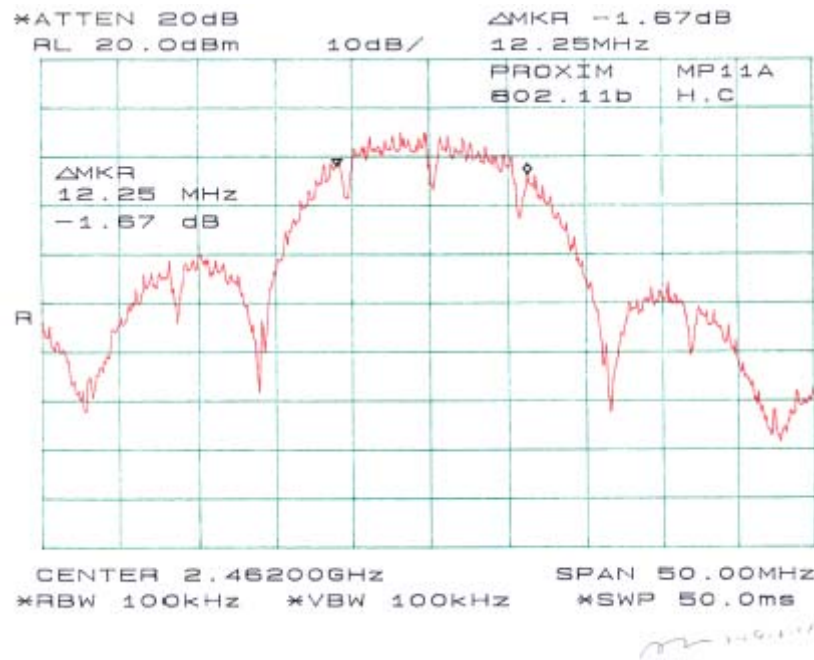

Plots of 6dB Bandwidth for 802.11g (15.247)

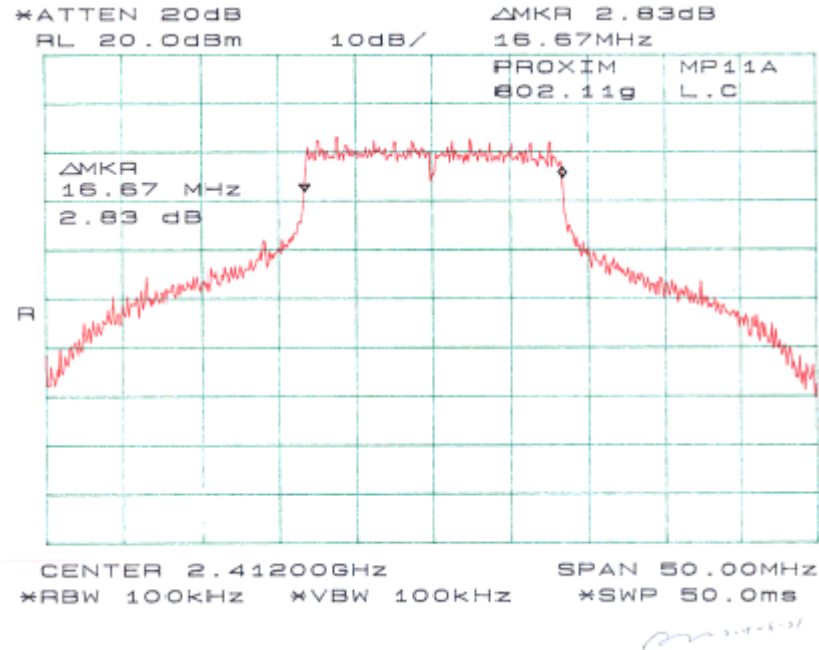

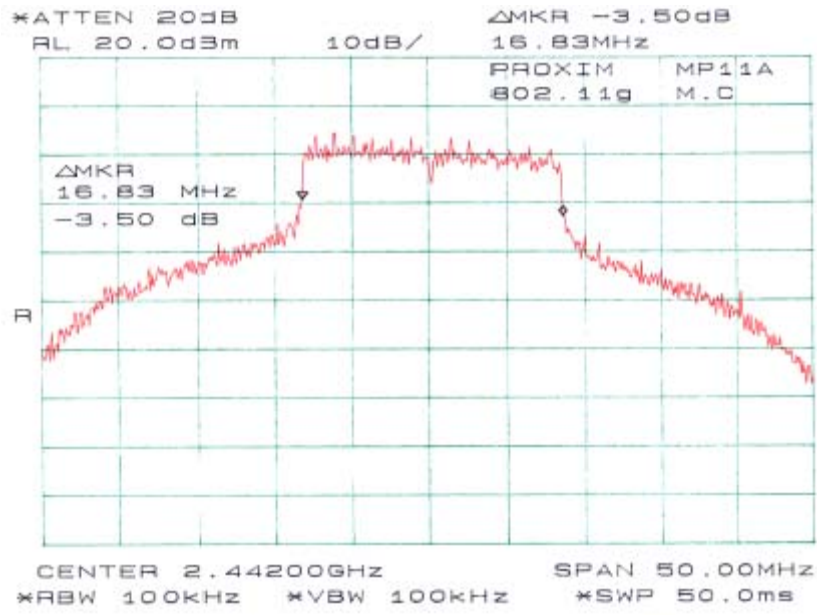

Handwritten signature

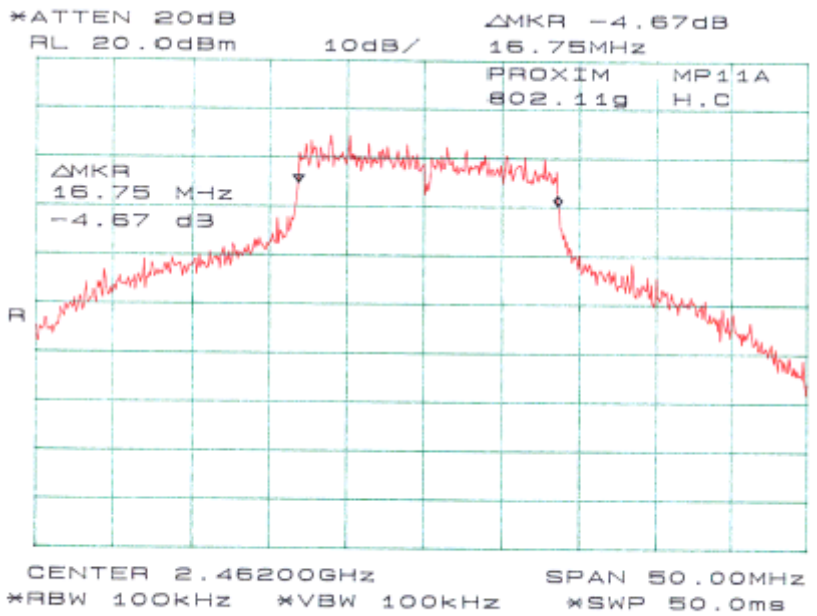

Handwritten signature

Plots of 6dB Bandwidth for 802.11a (15.247), High Band

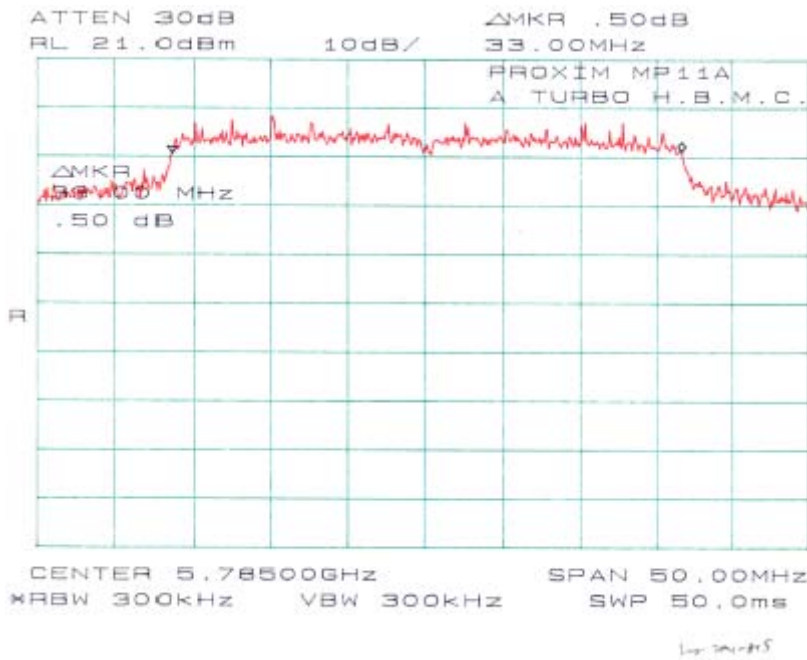
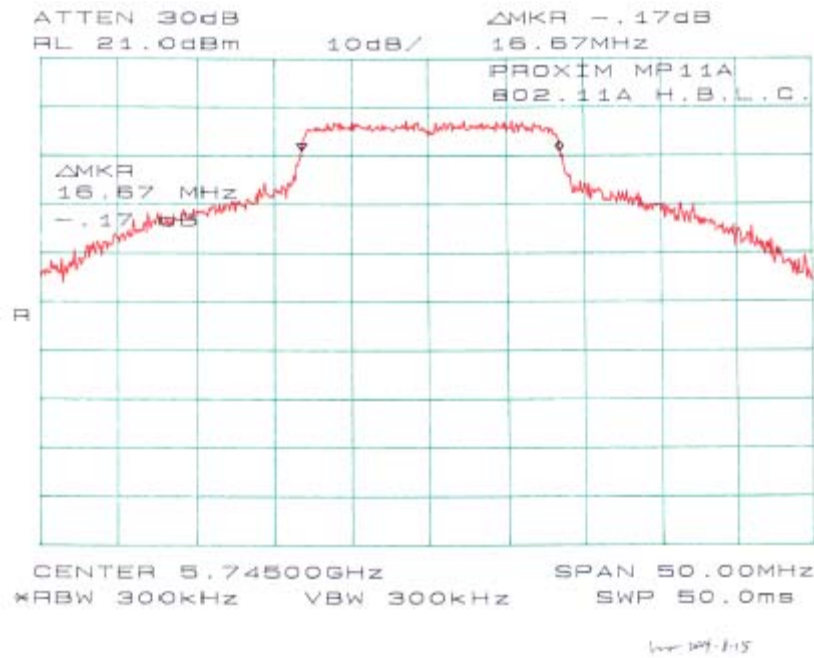



Plots of 26dB Bandwidth for 802.11a (15.407), Low Band

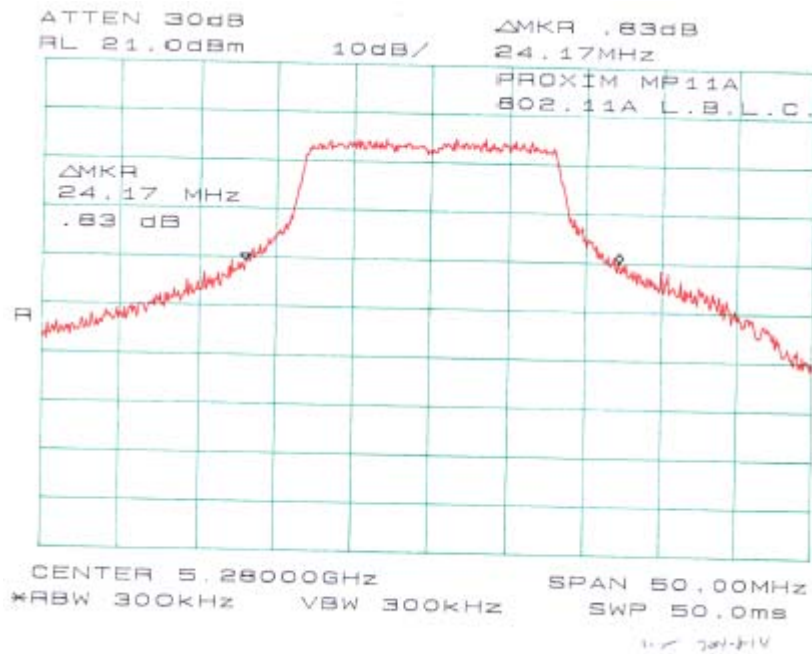

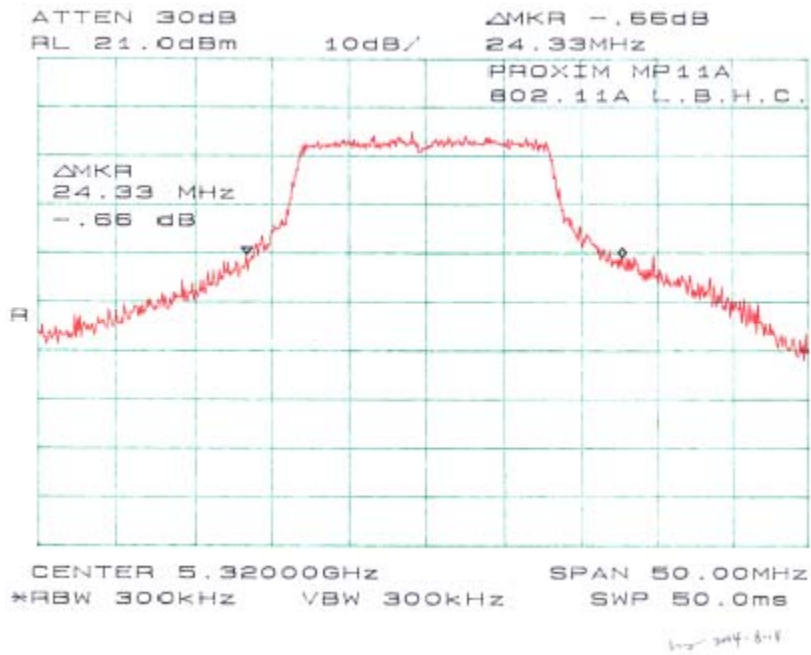
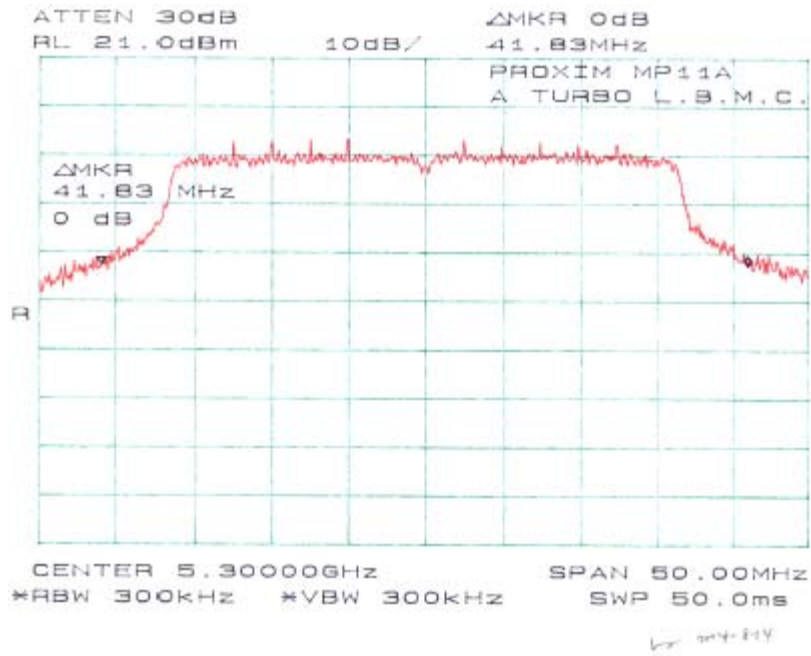

§15.247(b)(3), §15.407(a)(2) - RF OUTPUT POWER MEASUREMENT

Standard Applicable

According to §15.247(b) (3), for systems using digital modulation in 2400-2483.5 MHz: 1 Watt

According to §15.407(a)(1), for the band 5.15-5.25 GHz, the peak transmit power over the frequency band of operation shall not exceed the lesser of 50 mW or $4 \text{ dBm} + 10\log B$, where B is the 26-dB emission bandwidth in MHz.

According to §15.407(a)(2), for the band 5.25-5.35 GHz, the peak transmit power over the frequency band of operation shall not exceed the lesser of 250 mW or $11 \text{ dBm} + 10\log B$, where B is the 26-dB emission bandwidth in MHz.

According to §15.407(a)(3), for the band 5.725-5.825 GHz, the peak transmit power over the frequency band of operation shall not exceed the lesser of 1 W or $17 \text{ dBm} + 10\log B$, where B is the 26-dB emission bandwidth in MHz.

Measurement Procedure

Test was performed according to the order of FCC04-165 (ET Docket No. 03-201) released on July 12, 2004:

The Commission established measurement procedures for digital U-NII devices which allow for averaging output power in order to disregard these insignificant spikes.



Equipment Lists

Manufacturer	Model No.	Description	Calibration Date
Agilent	E4419B	Power Meter	2004-04-29

* **Statement of Traceability: BACL Corp.** attests that all calibrations have been performed per the NVLAP requirements, traceable to the NIST.

Measurement Result**Environmental Conditions**

Temperature:	28° C
Relative Humidity:	37%
ATM Pressure:	1032 mbar

The 2.4GHz testing was performed by Ming Jing on 2004-08-21.

Temperature:	24° C
Relative Humidity:	35%
ATM Pressure:	1031 mbar

The 5GHz testing was performed by Ling Zhang on 2004-08-14.

802.11b (FCC.15.247)

Channel	Frequency MHz	RF Power dBm	RF Power mW	Limit
Low	2412	19.95	98.4	1W (30dBm)
Mid	2442	20.14	102.8	1W (30dBm)
High	2462	20.09	101.6	1W (30dBm)

802.11g (FCC.15.247)

Channel	Frequency MHz	RF Power dBm	RF Power mW	Limit
Low	2412	17.97	62.5	1W (30dBm)
Mid	2442	18.12	65.3	1W (30dBm)
High	2462	18.05	63.5	1W (30dBm)

802.11a Low Band 5250 - 5350 MHz (FCC.15.407)

Channel	Frequency MHz	RF Power dBm	RF Power mW	Limit
Low	5280	16.00	39.81	250mW (24dBm)
Mid	5300	16.02	39.99	250mW (24dBm)
High	5320	15.98	39.63	250mW (24dBm)

802.11a High Band 5725 - 5850 MHz (FCC.15.247)

Channel	Frequency MHz	RF Power dBm	RF Power mW	Limit
Low	5745	18.55	71.61	1W (30dBm)
Mid	5785	18.52	71.12	1W (30dBm)
High	5825	18.49	70.63	1W (30dBm)

§15.247(c) - 100 KHZ BANDWIDTH OF BAND EDGES

Standard Applicable

According to §15.247(c), in *any* 100 kHz bandwidth outside the frequency bands in which the spread spectrum intentional radiator is operating, the radio frequency power that is produced by the intentional radiator shall be at least 20 dB below that in the 100 kHz bandwidth within the band that contains the highest level of the desired power, based on either an RF conducted or a radiated measurement. In addition, radiated emissions which fall in the restricted bands, as defined in §15.205(a), must also comply with the radiated emission limits specified in §15.209(a) see §15.205(c).

Measurement Procedure

1. Check the calibration of the measuring instrument using either an internal calibrator or a known signal from an external generator.
2. Position the EUT without connection to measurement instrument. Turn on the EUT and connect its antenna terminal to measurement instrument via a low loss cable. Then set it to any one measured frequency within its operating range, and make sure the instrument is operated in its linear range.
3. Set both RBW and VBW of spectrum analyzer to 100 kHz with a convenient frequency span including 100kHz bandwidth from band edge.
4. Measure the highest amplitude appearing on spectral display and set it as a reference level. Plot the graph with marking the highest point and edge frequency.
5. Repeat above procedures until all measured frequencies were complete.

Equipment Lists

Manufacturer	Model No.	Description	Calibration Date
Agilent	8564E	Spectrum Analyzer	2004-08-26

* **Statement of Traceability: BA CL Corp.** attests that all calibrations have been performed per the NVLAP requirements, traceable to the NIST.

Measure Results**Environmental Conditions**

Temperature:	28° C
Relative Humidity:	37%
ATM Pressure:	1032 mbar

The 2.4GHz testing was performed by Ming Jing on 2004-08-21.

Temperature:	24° C
Relative Humidity:	35%
ATM Pressure:	1031 mbar

The 5GHz testing was performed by Ling Zhang on 2004-08-14.

Plots of Band Edge for 802.11b (15.247)

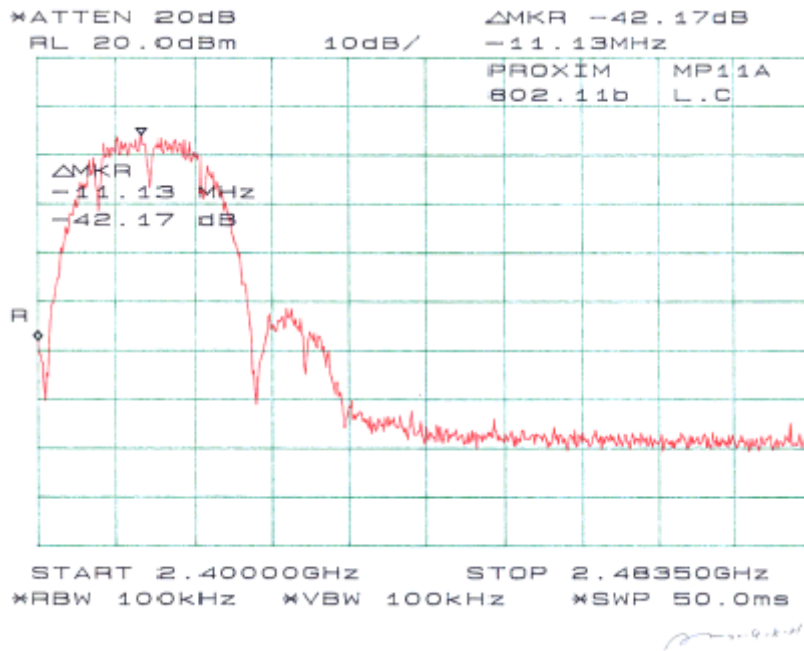
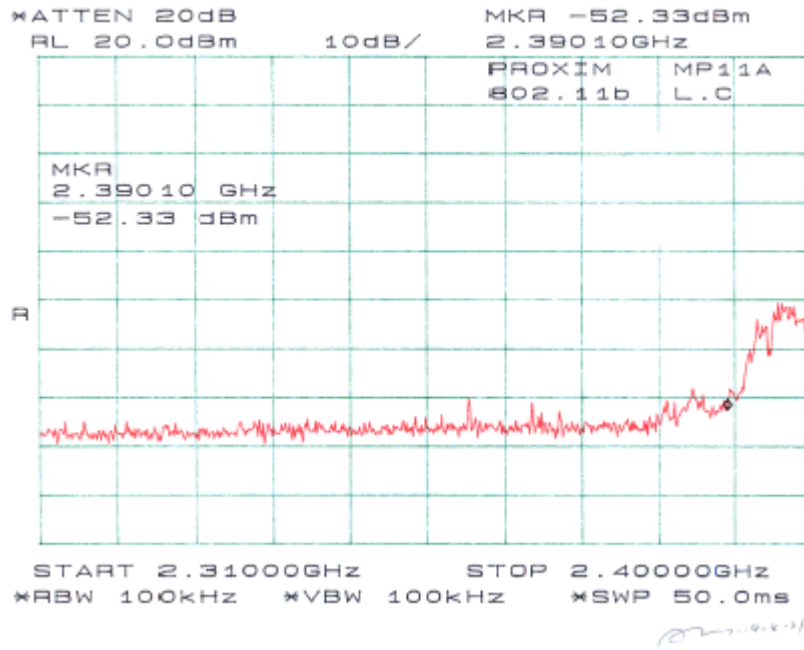

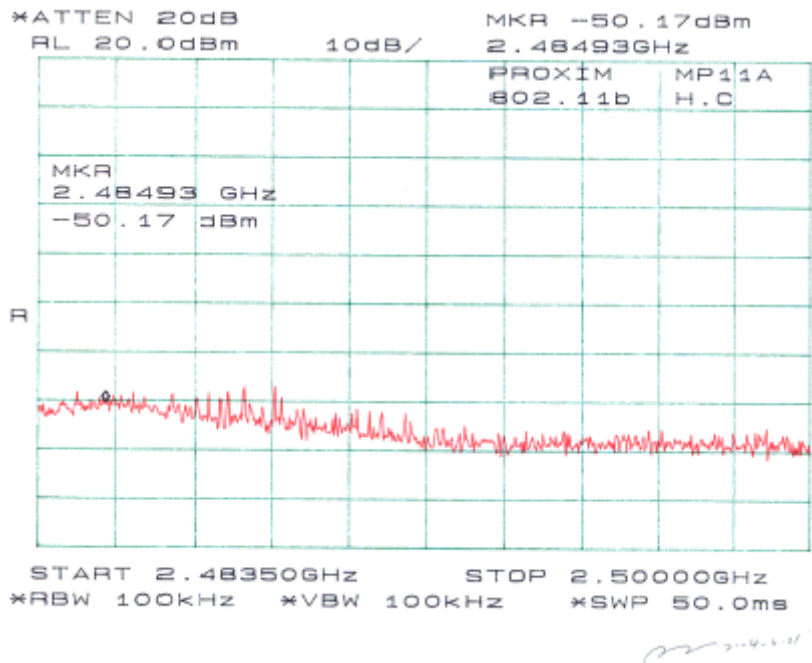
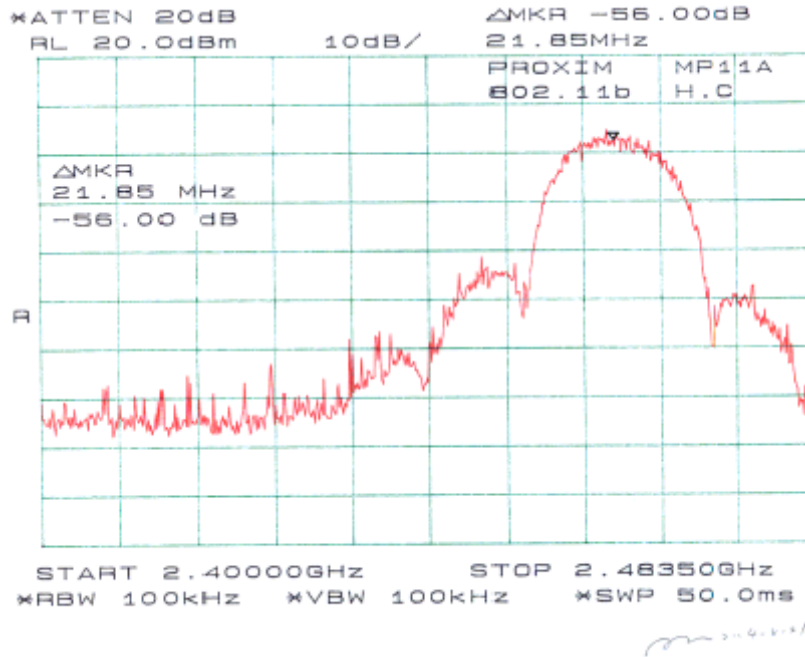

Plots of Band Edge for 802.11g (15.247)

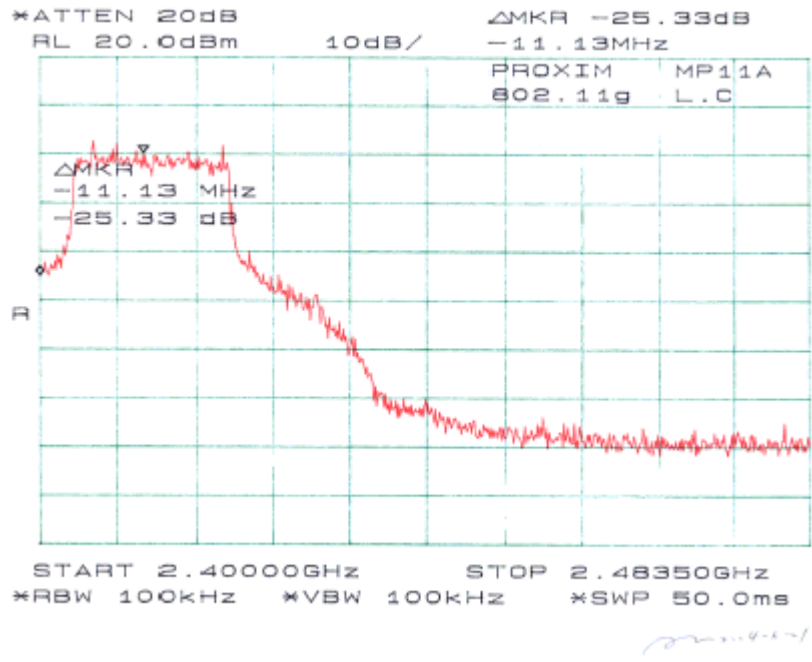
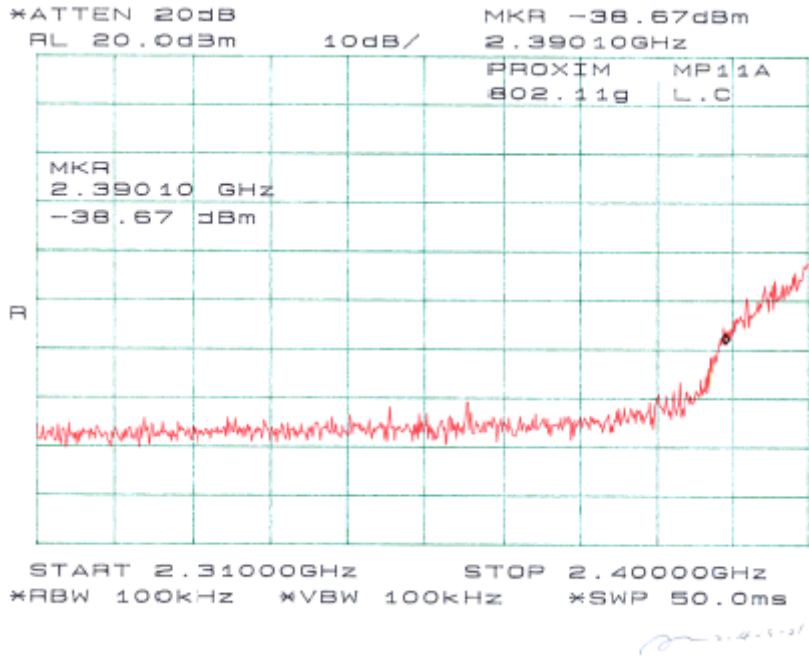

Plots of Band Edge for 802.11a (15.247), High Band

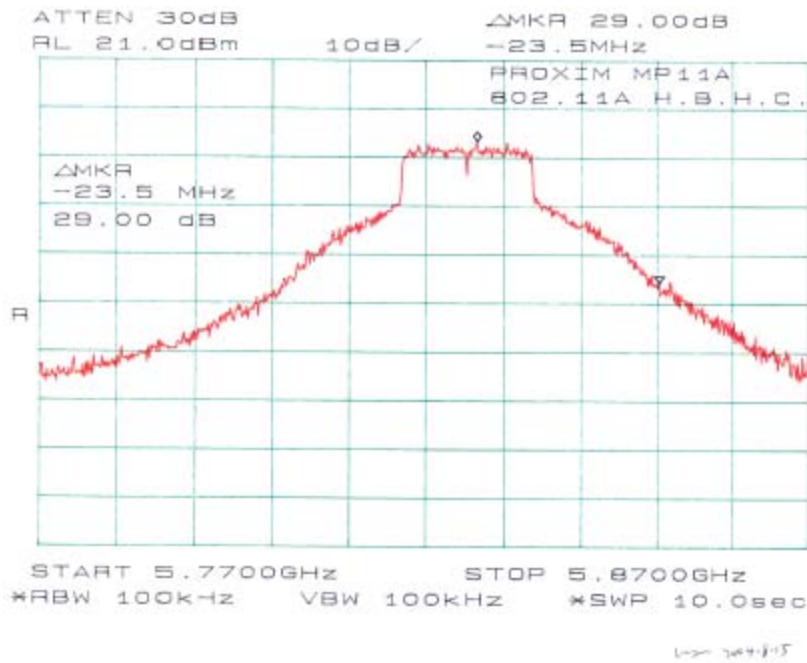
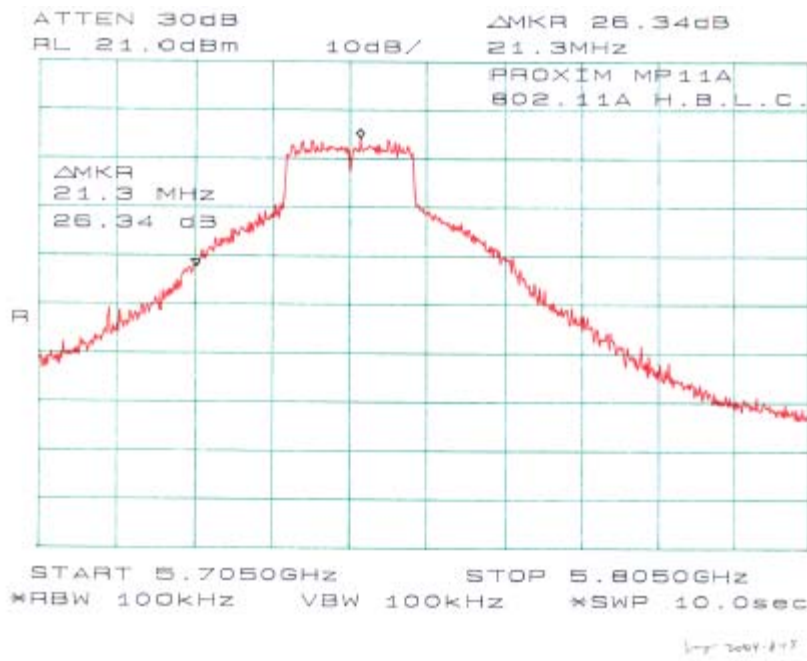

§15.247(d) & §15.407(a)(2) - POWER SPECTRAL DENSITY

Standard Applicable

According to §15.247 (d), for direct sequence systems, the peak power spectral density conducted from the intentional radiator to the antenna shall not be greater than 8 dBm in any 3 kHz band during any time interval of continuous transmission.

According to §15.407(a) (1), for the band 5.15-5.25 GHz, the peak power spectral density shall not exceed 4 dBm in any 1-MHz band. If transmitting antennas of directional gain greater than 6 dBi are used, both the peak transmit power and the peak power spectral density shall be reduced by the amount in dB that the directional gain of the antenna exceeds 6 dBi.

According to §15.407(a) (2), for the band 5.25-5.35 GHz, the peak power spectral density shall not exceed 11 dBm in any 1-MHz band. If transmitting antennas of directional gain greater than 6 dBi are used, both the peak transmit power and the peak power spectral density shall be reduced by the amount in dB that the directional gain of the antenna exceed 6 dBi.

According to §15.407(a) (3), for the band 5.725-5.825 GHz, the peak power spectral density shall not exceed 17 dBm in any 1-MHz band. If transmitting antennas of directional gain greater than 6 dBi are used, both the peak transmit power and the peak power spectral density shall be reduced by the amount in dB that the directional gain of the antenna exceeds 6 dBi.

Measurement Procedure

1. Check the calibration of the measuring instrument using either an internal calibrator or a known signal from an external generator.
2. Position the EUT was set without connection to measurement instrument. Turn on the EUT and connect its antenna terminal to measurement instrument via a low loss cable. Then set it to any one measured frequency within its operating range, and make sure the instrument is operated in its linear range.
3. Adjust the center frequency of SA on any frequency be measured and set SA to 6MHz span mode. And then, set RBW and VBW of spectrum analyzer to proper value. (DTS)
4. Adjust the center frequency of SA on any frequency be measured and set SA to 50MHz span mode. And then, set RBW and VBW of spectrum analyzer to proper value. (UNII)
5. Repeat above procedures until all frequencies measured were complete.

Equipment Lists

Manufacturer	Model No.	Description	Calibration Date
Agilent	8564E	Spectrum Analyzer	2004-08-26

* **Statement of Traceability: BA CL Corp.** attests that all calibrations have been performed per the NVLAP requirements, traceable to the NIST.

Measurement Results**Environmental Conditions**

Temperature:	28° C
Relative Humidity:	37%
ATM Pressure:	1032 mbar

The 2.4GHz testing was performed by Ming Jing on 2004-08-21.

Temperature:	24° C
Relative Humidity:	35%
ATM Pressure:	1031 mbar

The 5GHz testing was performed by Ling Zhang on 2004-08-14.

Test Result for 802.11b (15.247)

Channel	Frequency (MHz)	Peak Power Spectral Density (dBm)	Standard (dBm)	Result
Low	2412	-7.33	≤ 8	Compliant
Mid	2442	-7.67	≤ 8	Compliant
High	2462	-9.17	≤ 8	Compliant

Test Result for 802.11g (15.247)

Channel	Frequency (MHz)	Peak Power Spectral Density (dBm)	Standard (dBm)	Result
Low	2412	-8.83	≤ 8	Compliant
Mid	2442	-8.67	≤ 8	Compliant
High	2462	-9.17	≤ 8	Compliant

Test Result for 802.11a (15.247), High Band

Channel	Frequency (MHz)	Peak Power Spectral Density (dBm)	Standard (dBm)	Result
Low	5745	-3.67	≤ 8	Compliant
Mid	5785	-3.33	≤ 8	Compliant
High	5825	-4.83	≤ 8	Compliant

Test Result for 802.11a (15.407), Low Band

Channel	Frequency (MHz)	Peak Power Spectral Density (dBm)	Standard (dBm)	Result
Low	5280	10.83	≤ 11	Compliant
Mid	5300	8.33	≤ 11	Compliant
High	5320	10.50	≤ 11	Compliant

Plots of Power Spectral Density for 802.11b (15.247)

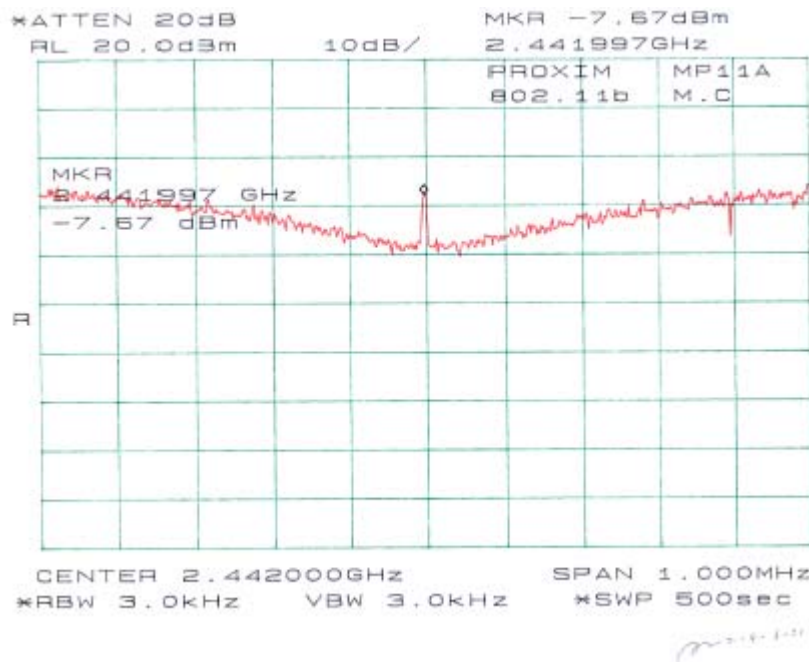
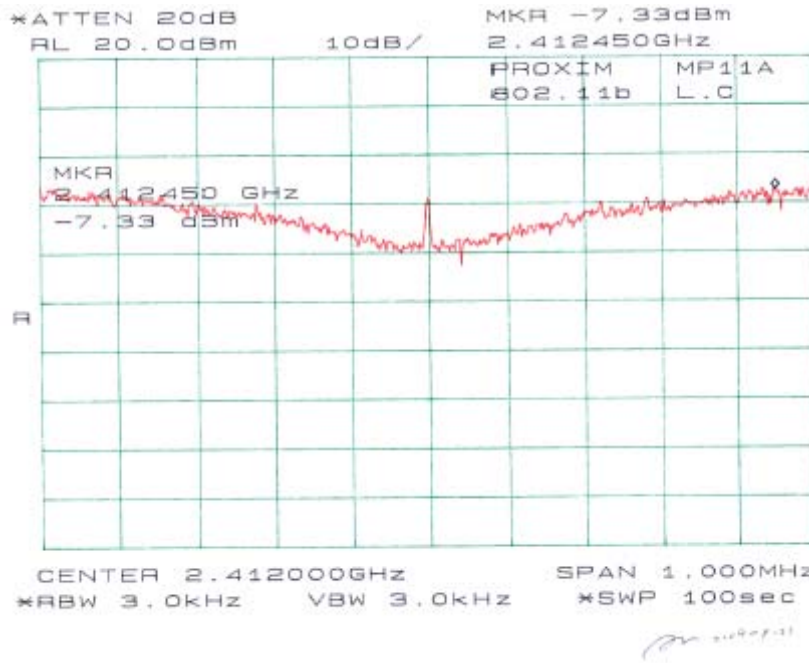

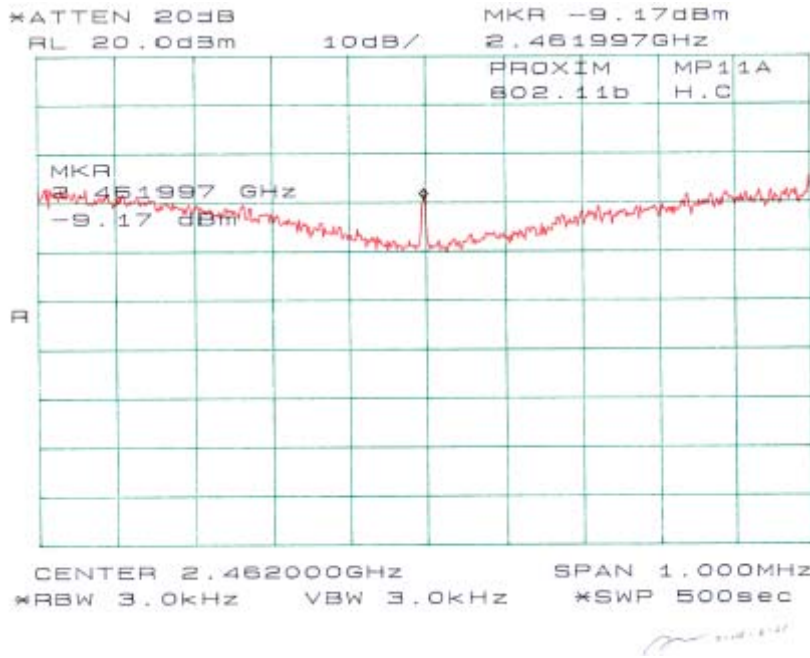

Plots of Power Spectral Density for 802.11g (15.247)

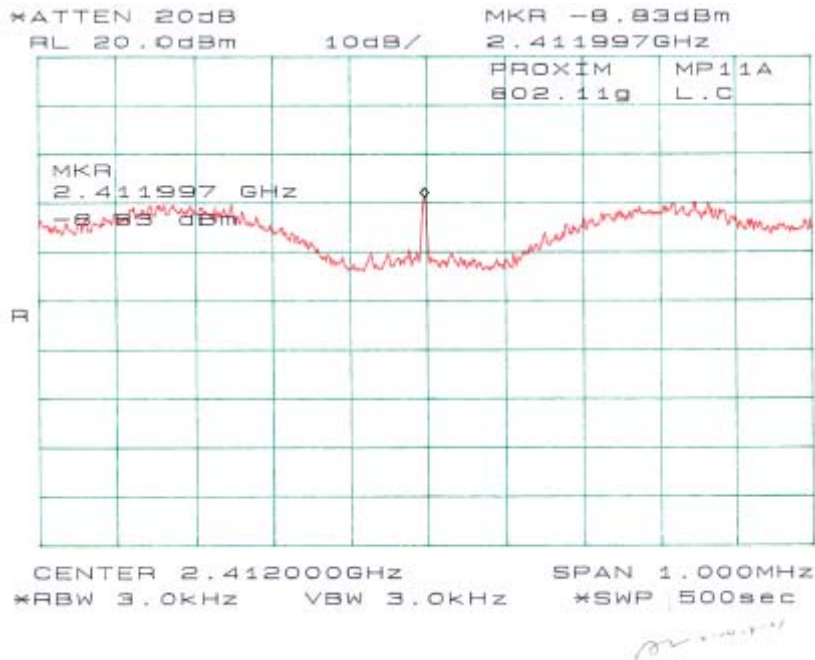

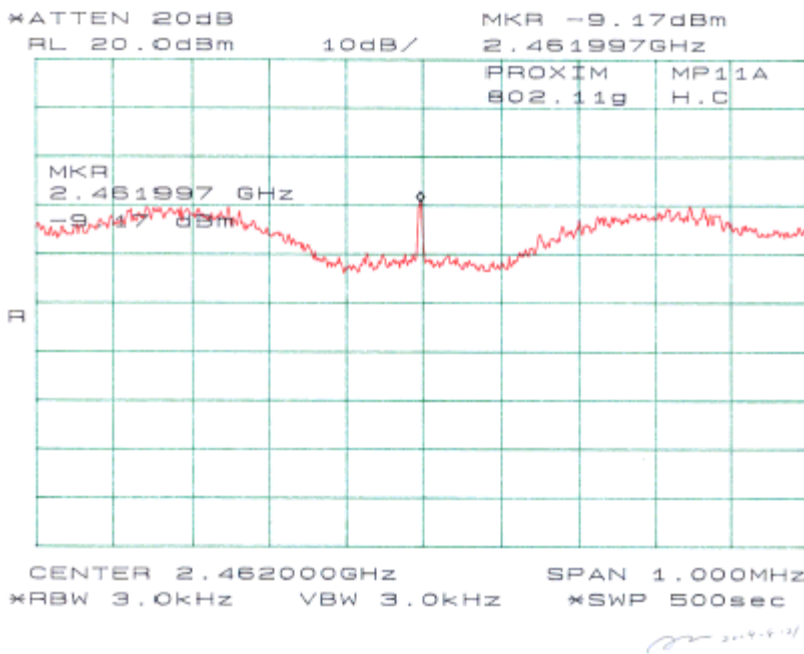
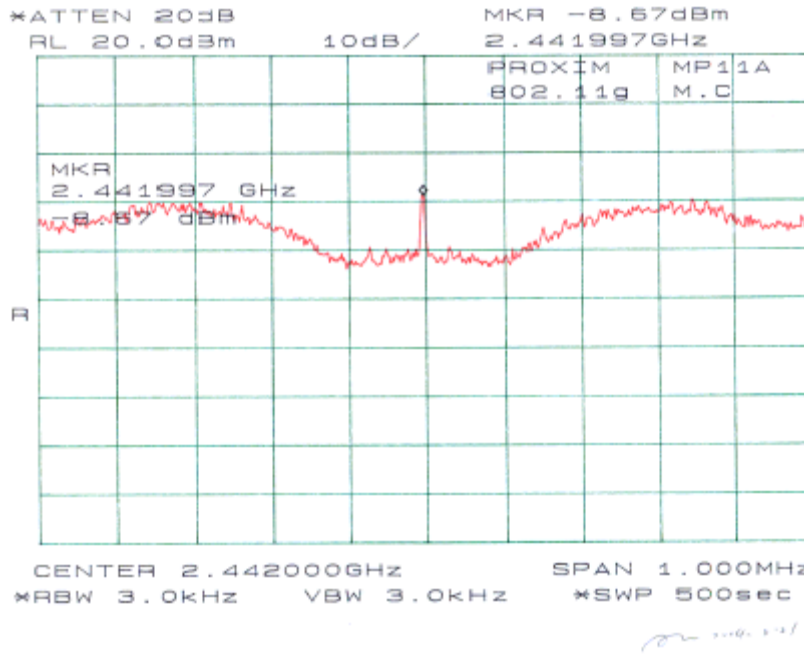

Plots of Spectral Density for 802.11a (15.247), High Band

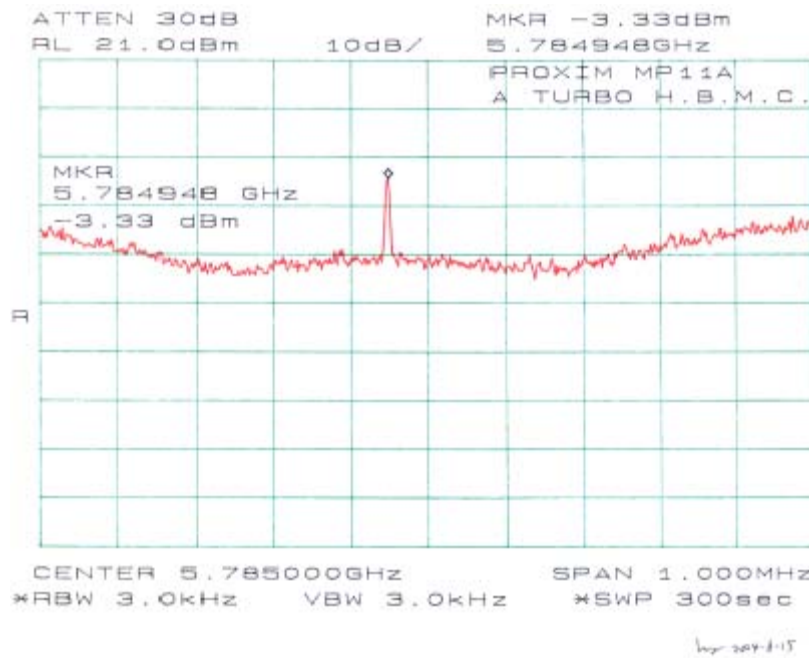
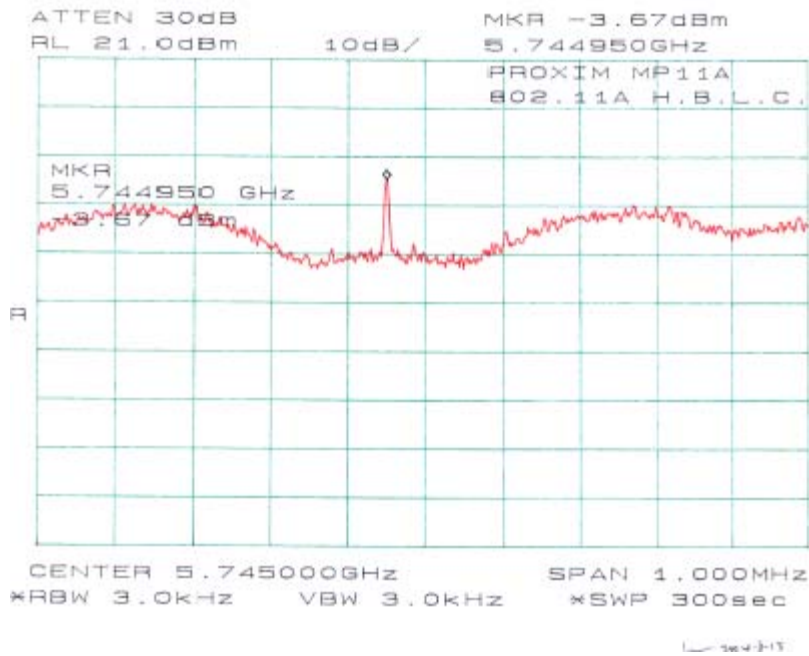

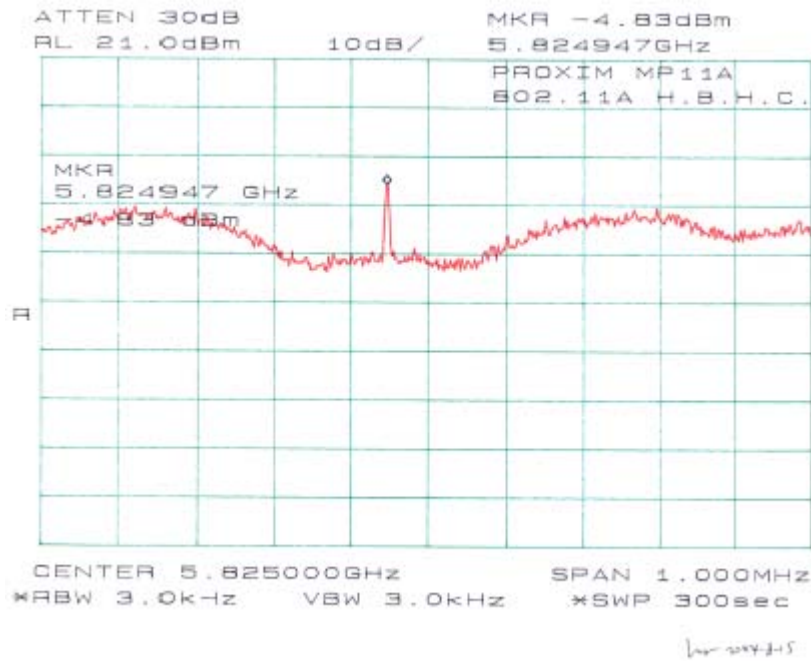

Plots of Spectral Density for 802.11a (15.407), Low Band

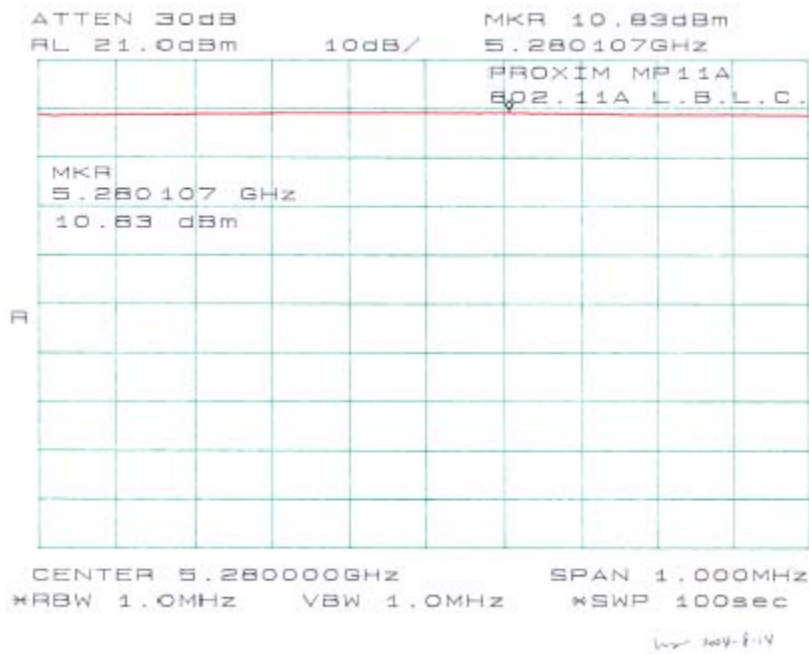

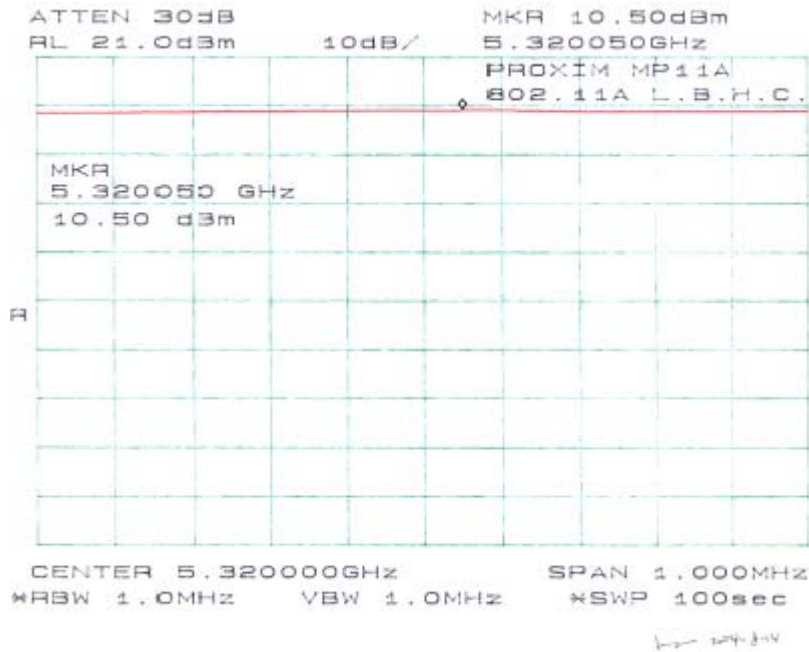
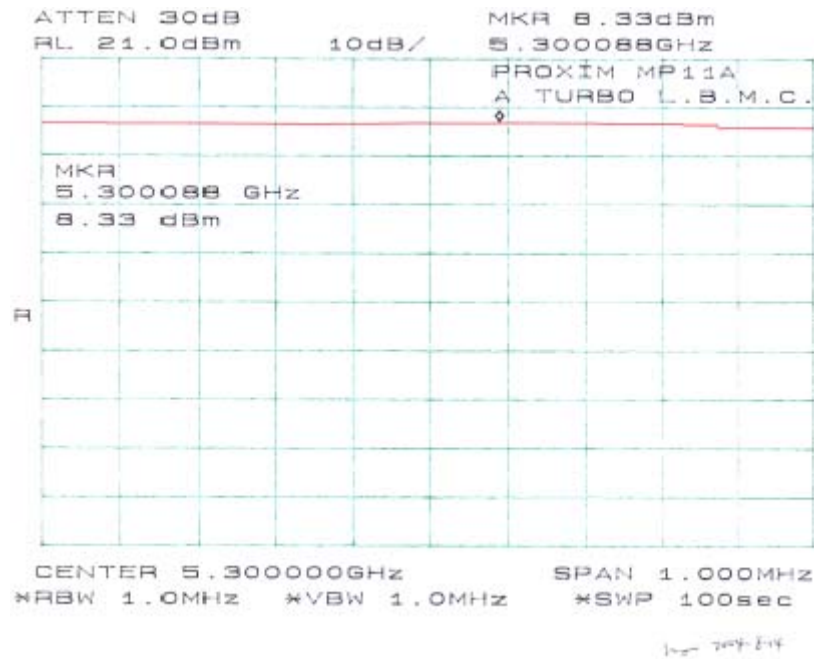

§15.407(a)(6) - Peak Excursion To Average Ratio

Standard Applicable

According to §15.407(a)(6), the ratio of the peak excursion of the modulation envelope (measured using a peak hold function) to the peak transmit power (measured as specified above) shall not exceed 13dB across any 1MHz bandwidth or the emission bandwidth whichever is less.

Test Procedure

For this test, the EUT's antenna was removed and replaced with a SMA jack to UMP2.0 plug test cable, so output power levels were calculated from conducted emission levels.

The analyzer center frequency was set to the EUT carrier frequency. For the peak value trace A, the analyzer resolution and video bandwidth were set to 1MHz. Do a MAX HOLD, then VIEW. For the average value trace B, the analyzer resolution bandwidth was set to 1MHz, the video bandwidth was set to 30kHz. MAX HOLD then VIEW trace B also.

The delta from the peak value trace and the Average should not exceed 13dBm across any 1MHz bandwidth.

Equipment Lists

Manufacturer	Model No.	Description	Calibration Date
Agilent	8564E	Spectrum Analyzer	2004-08-26

* **Statement of Traceability: BACL Corp.** attests that all calibrations have been performed per the NVLAP requirements, traceable to the NIST.

Test Result for

Environmental Conditions

Temperature:	24° C
Relative Humidity:	35%
ATM Pressure:	1031 mbar

The 5GHz testing was performed by Ling Zhang on 2004-08-14.

Channel	Frequency (MHz)	Reading (dB)	Limit (dBm)	Result
Low	5280	10.33	13	Compliant
Mid	5300	10.33	13	Compliant
High	5320	10.50	13	Compliant

Please see the hereinafter plots for more detail.

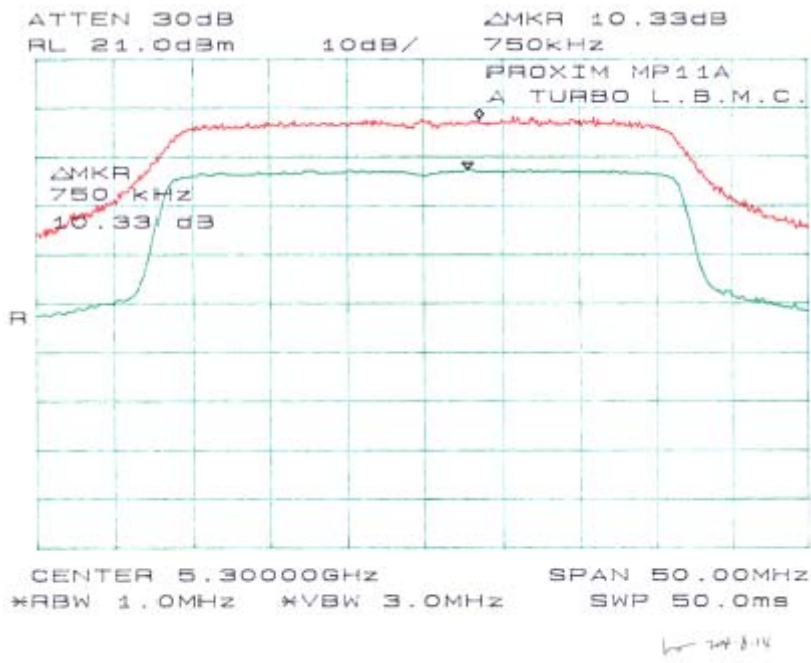
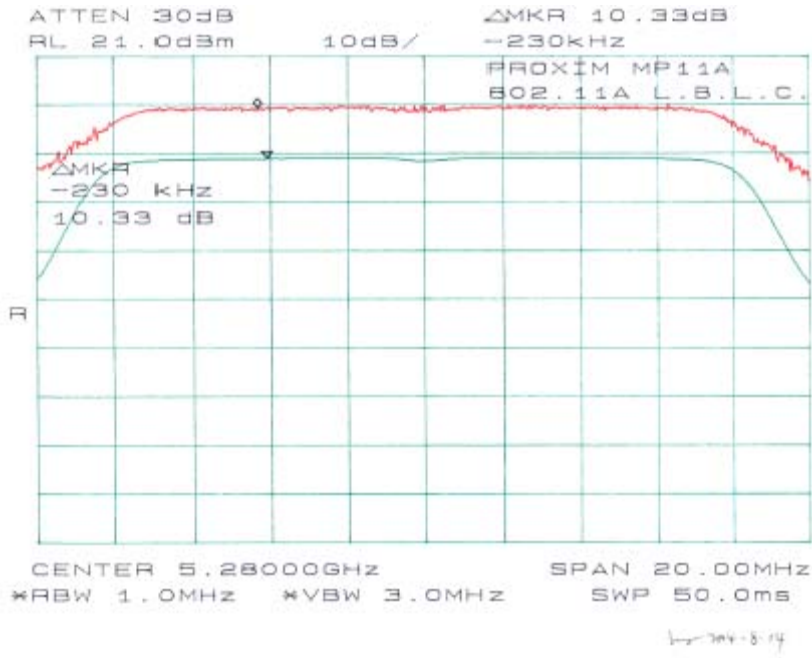

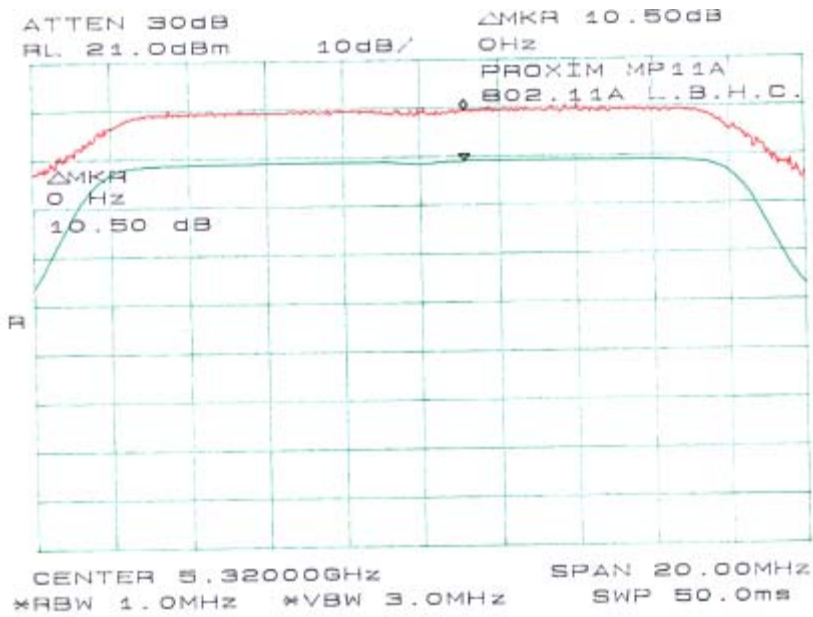

by 2043/4

§15.407(b) - Out Of Band Emission

Standard Applicable

§15.407 (b), undesirable emission limits: except as shown in paragraph (b)(6) of this section, the peak emission outside of the frequency bands of operation shall be attenuated in accordance with the following limits:

§15.407 (b)(1), for transmitters operating in the 5.15-5.25 GHz band: all emissions outside of the 5.15-5.35 GHz band shall not exceed an EIRP of -27 dBm/MHz.

§15.407 (b)(2), for transmitters operating in the 5.25 – 5.35 GHz band: all emissions outside of the 5.15 – 5.25 GHz band shall not exceed an EIRP of -27 dBm/MHz. Devices operating in the 5.25 – 5.35 GHz band that generate emissions in the 5.15 – 5.25 GHz band must meet all applicable technical requirements for operation in the 5.15 – 5.25 GHz band (including indoor use) or alternatively meet an out-of-band emission EIRP limit of -27 dBm/MHz in the 5.15 – 5.25 GHz band.

§15.407 (b)(3), for transmitters operating in the 5.725 – 5.825 GHz band: all emissions within the frequency range from the band edge to 10 MHz above or below the band edge shall not exceed an EURP of -17dBm/MHz; for frequencies 10 MHz or greater above or below the band edge, emission shall not exceed an EIRP of -27 dBm/MHz.

Test Procedure

For this test, the EUT's antenna was removed and replaced with a low loss cable, so output power levels were calculated from conducted emission levels.

The analyzer center frequency was set to the EUT carrier frequency. The analyzer resolution and video bandwidth were set to 1MHz. The entire band from 30kHz to 40GHz was investigated.

Every suspected signal was also investigated through radiated emission. Refer to section 15.205 restricted bands of operation.

Equipment Lists

Manufacturer	Model No.	Description	Calibration Date
Agilent	8564E	Spectrum Analyzer	2004-08-26

* **Statement of Traceability: BACL Corp.** attests that all calibrations have been performed per the NVLAP requirements, traceable to the NIST.

Test Result

Environmental Conditions

Temperature:	24° C
Relative Humidity:	35%
ATM Pressure:	1031 mbar

The 5GHz testing was performed by Ling Zhang on 2004-08-14.

Please refer to the following plots.

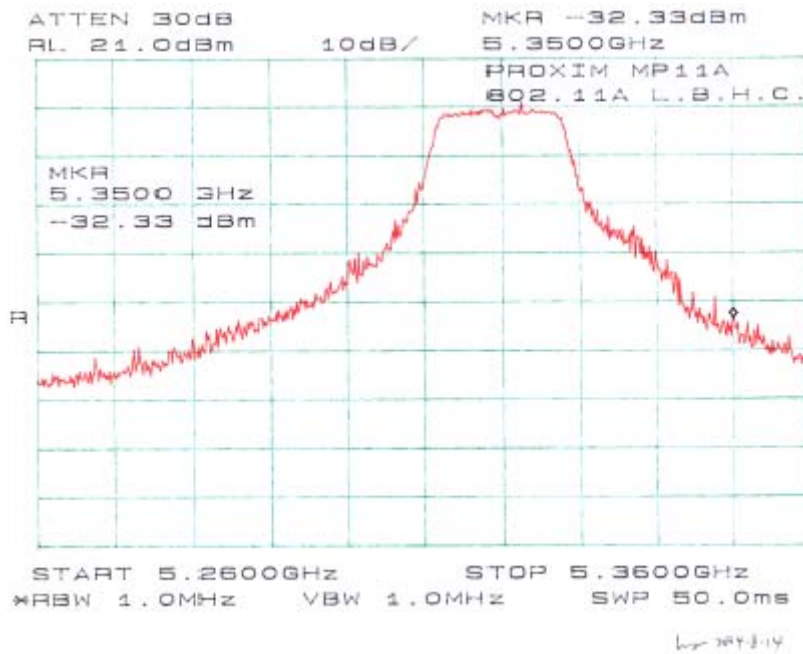
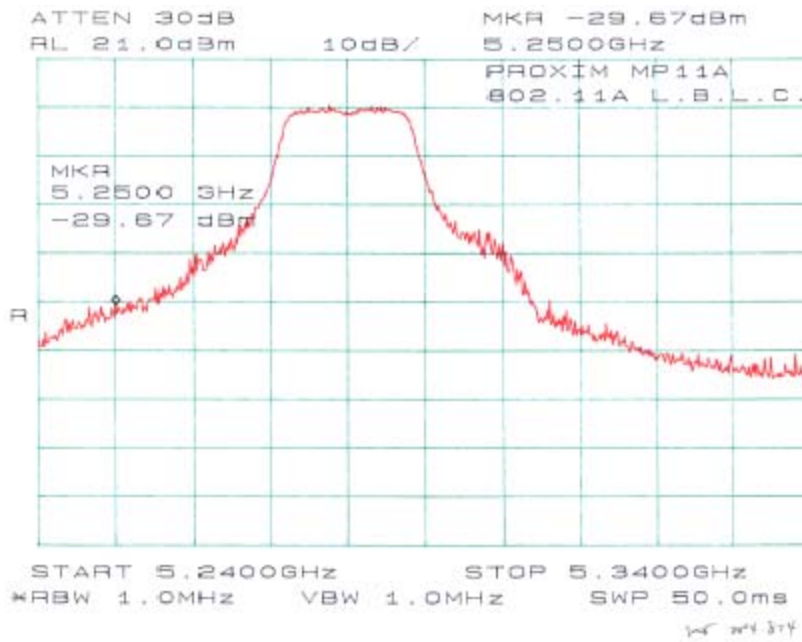

15.407(c) - Discontinue Transmitting With Absence Of Data Or Operational Failure

According to § 15.407 (c), the device shall automatically discontinue transmission in case of either absence of information to transmit or operational failure. These provisions are not intended to preclude the transmission of control or signaling information or the user of repetitive codes used by certain digital technologies to complete frame or burst intervals. Applicants shall include in their application a description of how this requirement is met.

Please refer to respective technical description.

§15.407(g) - Frequency Stability

Standard Applicable

According to §15.407 (g), manufacturers of U-NII devices are responsible for ensuring frequency stability such that an emission is maintained within the band of operation under all conditions of normal operation .

Test Equipment List and Details

Manufacturer	Description	Model	Serial Number	Cal. Date
HP	Analyzer, Spectrum	8565EC	3946A00131	6/30/2004
HP	Amplifier, Pre, microwave	8449B	3147A00400	3/14/2004
A. H. Systems	Antenna, Horn, DRG	SAS-200/571	2455-261	8/1/2004
Tenney	Oven, Temperature	VersaTenn	12222-193	4/23/2004
A. H. Systems	Antenna, Horn, DRG	SAS-200/571	2455-261	8/1/2004

* **Statement of Traceability: BA CL Corp.** attests that all calibrations have been performed per the NVLAP requirements, traceable to the NIST.

Measurement Result

Environmental Conditions

Temperature:	28° C
Relative Humidity:	37%
ATM Pressure:	1032 mbar

The testing was performed by Ming Jing on 2004-08-21.

Reference Frequency : 5300.0000 MHz, Limit : +/- 0.02%				
Temperature C	Power supplied Vdc		Frequency Measure with Time Elapsed	
			MCF (MHz)	Error %
50	110	5300.0091	0.00017	
40	110	5300.0018	0.00003	
30	110	5300.0018	0.00003	
20	110	5300	0	
10	110	5300	0	
0	110	5299.9997	-0.00001	
-10	110	5299.9997	-0.00001	
-20	110	5299.9991	-0.00002	
-30	110	5299.9991	-0.00002	

Reference Frequency : 5300.0000 MHz, Limit : +/- 0.02%		
Power supplied Vac	Frequency Measure with Time Elapsed	
	Frequency (MHz)	Error %
126.5	5299.9997	-0.00001
110	5300	0
93.5	5300.0009	0.00002