



FCC TEST REPORT

REPORT NO.: RF920501R04

MODEL NO.: G11FNF

PLATFORM: Alpha-1, **BRAND:** Proxim

RECEIVED: May 01, 2003

TESTED: May 08 to 15, 2003

APPLICANT: Proxim Corporation

ADDRESS: 935 Stewart Drive, Sunnyvale, CA 94085, USA

ISSUED BY: Advance Data Technology Corporation

LAB LOCATION: No. 81-1, Lu Liao Keng, 9 Ling, Wu Lung Tsuen,
Chiung Lin Hsiang, Hsin Chu Hsien,
Taiwan, R.O.C.

This test report consists of 102 pages in total. It may be duplicated completely for legal use with the approval of the applicant. It should not be reproduced except in full, without the written approval of our laboratory. The client should not use it to claim product endorsement by CNLA, NVLAP or any government agencies. The test results in the report only apply to the tested sample.



Lab Code: 200376-0



Table of Contents

1	CERTIFICATION.....	4
2	SUMMARY OF TEST RESULTS	5
3	GENERAL INFORMATION	6
3.1	GENERAL DESCRIPTION OF EUT.....	6
3.2	DESCRIPTION OF TEST MODES.....	8
3.3	GENERAL DESCRIPTION OF APPLIED STANDARDS	8
3.4	DESCRIPTION OF SUPPORT UNITS	9
4	TEST TYPES AND RESULTS	11
4.1	CONDUCTED EMISSION MEASUREMENT	11
4.1.1	LIMITS OF CONDUCTED EMISSION MEASUREMENT.....	11
4.1.2	TEST INSTRUMENTS	11
4.1.3	TEST SETUP	12
4.1.4	EUT OPERATING CONDITIONS	13
4.1.5	TEST RESULTS	14
4.2	RADIATED EMISSION MEASUREMENT	20
4.2.1	LIMITS OF RADIATED EMISSION MEASUREMENT	20
4.2.2	TEST INSTRUMENTS	21
4.2.3	TEST PROCEDURES	22
4.2.4	TEST SETUP	23
4.2.5	EUT OPERATING CONDITIONS	23
4.2.6	TEST RESULTS (A).....	24
4.2.7	TEST RESULTS (A) - DSSS.....	25
4.2.8	TEST RESULTS (A) -OFDM.....	28
4.2.9	TEST RESULTS (B).....	31
4.2.10	TEST RESULTS (B) - DSSS.....	32
4.2.11	TEST RESULTS (B) -OFDM.....	35
4.2.12	TEST RESULTS (C).....	38
4.2.13	TEST RESULTS (C) - DSSS	39
4.2.14	TEST RESULTS (C) -OFDM.....	42
4.3	6dB BANDWIDTH MEASUREMENT	45
4.3.1	LIMITS OF 6dB BANDWIDTH MEASUREMENT	45
4.3.2	TEST INSTRUMENTS	45
4.3.3	TEST PROCEDURE	46
4.3.4	TEST SETUP	46
4.3.5	EUT OPERATING CONDITIONS	46



4.3.6 TEST RESULTS-DSSS47

4.3.7 TEST RESULTS-OFDM55

4.4 MAXIMUM PEAK OUTPUT POWER63

4.4.1 LIMITS OF MAXIMUM PEAK OUTPUT POWER MEASUREMENT63

4.4.2 TEST INSTRUMENTS63

4.4.3 TEST PROCEDURES64

4.4.4 TEST SETUP64

4.4.5 EUT OPERATING CONDITIONS64

4.4.6 TEST RESULTS(A)-DSSS65

4.4.7 TEST RESULTS(A)-OFDM.....65

4.4.8 TEST RESULTS(B)-DSSS66

4.4.9 TEST RESULTS(B)-OFDM.....66

4.4.10 TEST RESULTS(C)-DSSS.....67

4.4.11 TEST RESULTS(C)-OFDM.....67

4.5 POWER SPECTRAL DENSITY MEASUREMENT68

4.5.1 LIMITS OF POWER SPECTRAL DENSITY MEASUREMENT68

4.5.2 TEST INSTRUMENTS68

4.5.3 TEST PROCEDURE69

4.5.4 TEST SETUP69

4.5.5 EUT OPERATING CONDITIONS69

4.5.6 TEST RESULTS-DSSS70

4.5.7 TEST RESULTS-OFDM78

4.6 BAND EDGES MEASUREMENT86

4.6.1 LIMITS OF BAND EDGES MEASUREMENT.....86

4.6.2 TEST INSTRUMENTS86

4.6.3 TEST PROCEDURE86

4.6.4 EUT OPERATING CONDITION.....86

4.6.5 TEST RESULTS - DSSS87

4.6.6 TEST RESULTS-OFDM93

4.7 ANTENNA REQUIREMENT99

4.7.1 STANDARD APPLICABLE.....99

4.7.2 ANTENNA CONNECTED CONSTRUCTION99

5 PHOTOGRAPHS OF THE TEST CONFIGURATION.....100

6 INFORMATION ON THE TESTING LABORATORIE S.....102



1 CERTIFICATION

PRODUCT : 802.11b/g MiniPCI Module
BRAND NAME : Proxim
PLATFORM: Alpha-1, **BRAND:** Proxim
MODEL NO. : G11FNF
APPLICANT : Proxim Corporation
STANDARDS : 47 CFR Part 15, Subpart C (Section 15.247),
ANSI C63.4-1992

We, **Advance Data Technology Corporation**, hereby certify that one sample of the designation has been tested in our facility from May 08 to 15, 2003. The test record, data evaluation and Equipment Under Test (EUT) configurations represented herein are true and accurate accounts of the measurements of the sample's EMC characteristics under the conditions herein specified.

CHECKED BY: Amanda Chu, **DATE:** May 17, 2003
(Amanda Chu)

APPROVED BY: Eric Lin, **DATE:** May 17, 2003
(Eric Lin, Manager)



2 SUMMARY OF TEST RESULTS

The EUT has been tested according to the following specifications:

APPLIED STANDARD: 47 CFR Part 15, Subpart C			
Standard Section	Test Type and Limit	Result	REMARK
15.207	AC Power Conducted Emission Limit: 48dBuV	PASS	Meet the requirement of limit Minimum passing margin is -13.27 dBuV at 2.802 MHz
15.247(a)(2)	Spectrum Bandwidth of a Direct Sequence Spread Spectrum System Limit: min. 500kHz	PASS	Meet the requirement of limit
15.247(b)	Maximum Peak Output Power Limit: max. 30dBm	PASS	Meet the requirement of limit
15.247(c)	Transmitter Radiated Emissions Limit: Table 15.209	PASS	Meet the requirement of limit Minimum passing margin is -2.1 dBuV at 2484.00MHz
15.247(d)	Power Spectral Density Limit: max. 8dBm	PASS	Meet the requirement of limit
15.247(c)	Band Edge Measurement Limit: 20 dB less than the peak value of fundamental frequency	PASS	Meet the requirement of limit



3 GENERAL INFORMATION

3.1 GENERAL DESCRIPTION OF EUT

PRODUCT	802.11b/g MiniPCI Module
MODEL NO.	G11FNF
PLATFORM:	Alpha-1, BRAND: Proxim
POWER SUPPLY	3.3VDC from host equipment
MODULATION TYPE	CCK, OFDM, DBPSK, DQPSK
RADIO TECHNOLOGY	DSSS, OFDM
TRANSFER RATE	1/2/5.5/6/9/11/12/18/24/36/48/54Mbps
FREQUENCY RANGE	2412MHz ~ 2462MHz
NUMBER OF CHANNEL	11
OUTPUT POWER	15.93dBm
ANTENNA TYPE	omni directional antenna (dipole) & Omni directional (mono-pole) Antenna & Dual band Omni directional (dipole) Antenna
DATA CABLE	NA
I/O PORTS	NA
ASSOCIATED DEVICES	NA

NOTE:

1. Platforms was operated with an AC/DC power adapter:

BRAND:	DVE
MODEL:	DSA-0151F-12A
INPUT	100-240Vac, 50/60Hz, 0.4A
OUTPUT:	+12V DC, 1.5A



2. There are three types of antennas provided to this EUT, please refer to the following table:

No.	Model No.	Gain (dBi)	Antenna Type / Connector
1	IAN24-OD-03-S	3	omni directional antenna (dipole) / with MMCX connector
	IAN24-OD-03	3	omni directional antenna (dipole) / without connector
	Model : IAN24-OD-03-S & IAN24-OD-03, two models are identical except for their model and Connector. Model: IAN24-OD-03-S was chosen for final test.		
2	AOU24-OD-55-B	5	Omni directional (mono-pole) Antenna / MMCX connector
3	AIN24-WB-OD	3	Omni directional (dipole) Antenna / MMCX connector

3. The EUT operates in the 2.4GHz frequency spectrum with throughput of up to 54Mbps.

4. The EUT complies with IEEE 802.11g draft standards, and backwards compatible with IEEE 802.11b products.

5. For a more detailed features description, please refer to the manufacturer's specifications or User's Manual.



3.2 DESCRIPTION OF TEST MODES

Eleven channels are provided in this EUT.

Channel	Frequency	Channel	Frequency
1	2412 MHz	7	2442 MHz
2	2417 MHz	8	2447 MHz
3	2422 MHz	9	2452 MHz
4	2427 MHz	10	2457 MHz
5	2432 MHz	11	2462 MHz
6	2437 MHz		

NOTE:

1. Below 1 GHz, for Antenna 1&3, the channel 1, 6, and 11 were pre-tested in chamber. The channel 11, worst case one, was chosen for final test.
2. Below 1 GHz, for Antenna 2, the channel 2, 6, and 10 were pre-tested in chamber. The channel 11, worst case one, was chosen for final test.
3. Above 1 GHz, for Antenna 1&3, the channel 1, 6, and 11 were tested individually.
4. Above 1 GHz, for Antenna 2, the channel 2, 6, and 10 were tested individually.
5. Test result (A) is for antenna 1, test result (B) is for antenna 2 and test result (C) is for antenna 3, which were mentioned on section 3.1.
6. Transfer rate, 11Mbps with CCK technique and 54Mbps with OFDM technique, the worst case, were chosen for final test.
7. These antennas shall be tested in combination with 20 FT extension cable (LMR400) + surge_arrester (010997)+EUT. After pre-tested, the EUT + antenna is the worst case.

3.3 GENERAL DESCRIPTION OF APPLIED STANDARDS

The EUT is a 802.11b/g MiniPCI Module. According to the specifications of the manufacturer, it must comply with the requirements of the following standards:

FCC CFR 47 Part 15, Subpart C. (15.247)
ANSI C63.4 : 1992

All tests have been performed and recorded as per the above standards.

NOTE: The EUT is also considered as a kind of computer peripheral, because the connection to computer is necessary for typical use. It has been verified to comply with the requirements of FCC Part 15, Subpart B, Class B (DoC). The test report has been issued separately.



3.4 DESCRIPTION OF SUPPORT UNITS

The EUT has been tested as an independent unit together with other necessary accessories or support units. The following support units or accessories were used to form a representative test configuration during the tests.

No.	Product	Brand	Model No.	Serial No.	FCC ID
1	Wireless LAN basestation	Proxim	Alpha-1	NA	FCC DoC
2	NOTEBOOK COMPUTER	DELL	PP01L	TW-09C748-1280 0-17Q-C504	FCC DoC

No.	Signal cable description
1	NA
2	NA

Note: 1. All power cords of the above support units are unshielded (1.8m).

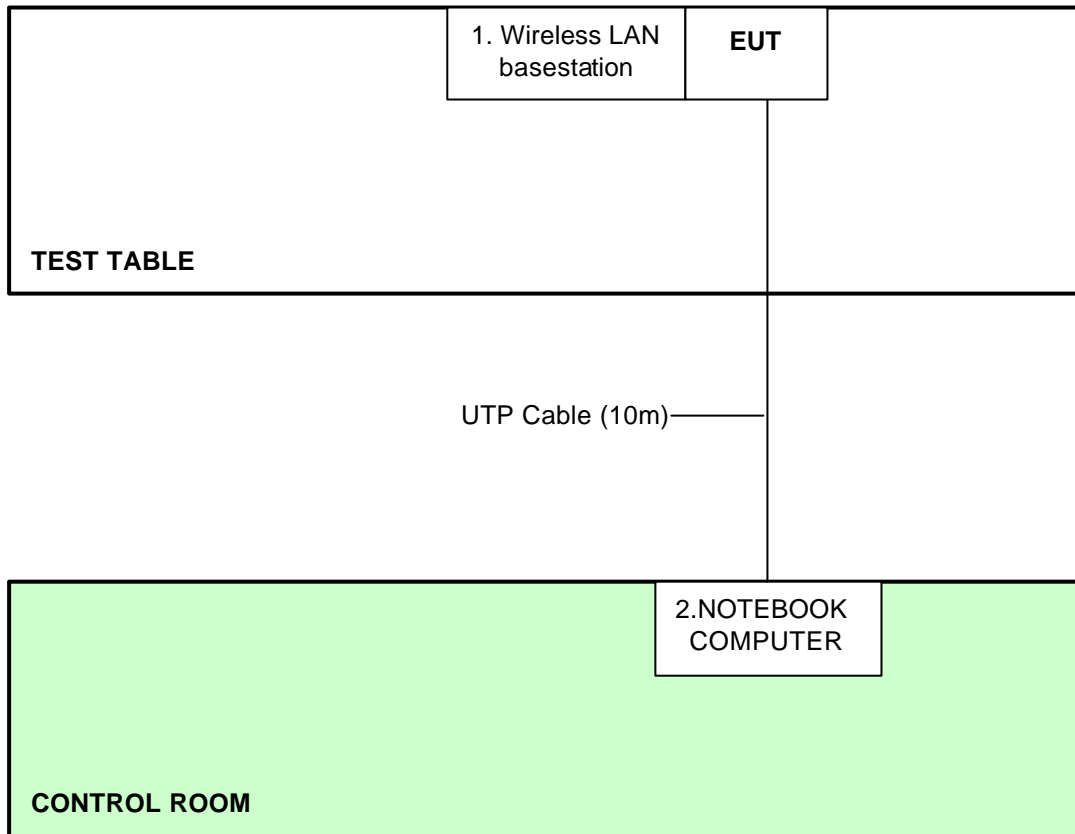

NOTE: 1. Support unit 2 was kept in the control room during the test.
2. Please refer to the photos of test configuration in Item 5 also.



4 TEST TYPES AND RESULTS

4.1 CONDUCTED EMISSION MEASUREMENT

4.1.1 LIMITS OF CONDUCTED EMISSION MEASUREMENT

FREQUENCY OF EMISSION (MHz)	CONDUCTED LIMIT (dB μ V)	
	Quasi-peak	Average
0.15-0.5	66 to 56	56 to 46
0.5-5	56	46
5-30	60	50

NOTE

1. The lower limit shall apply at the transition frequencies.
2. All emanations from a class B digital device or system, including any network of conductors and apparatus connected thereto, shall not exceed the level of field strengths specified above.

4.1.2 TEST INSTRUMENTS

DESCRIPTION & MANUFACTURER	MODEL NO.	SERIAL NO.	CALIBRATION DATE
ROHDE & SCHWARZ Test Receiver	ESCS 30	847124/029	Nov. 17, 2003
ROHDE & SCHWARZ LISN (for EUT)	ESHS-Z5	848773/004	Nov. 13, 2003
KYORITSU LISN (for peripheral)	KNW-407	8/1395/12	Jul. 23, 2003
RF Cable (JETBAO)	RG233/U	Cable_CA_01	Jul. 03, 2003
Terminator(for KYORITSU)	50	#1	Apr. 11, 2004
Software	Cond-V2e	NA	NA

- NOTE: 1. The calibration interval of the above test instruments is 12 months and the calibrations are traceable to NML/ROC and NIST/USA.
 2. The test was performed in ADT Shielded Room No. A.
 3. The VCCI Con A Registration No. is C-817.

3. TEST PROCEDURES

- a. The EUT was placed 0.4 meters from the conducting wall of the shielded room with EUT being connected to the power mains through a line impedance stabilization network (LISN). Other support units were connected to the power mains through another LISN. The two LISNs provide 50 ohm/ 50uH of coupling impedance for the measuring instrument.
- b. Both lines of the power mains connected to the EUT were checked for maximum conducted interference.
- c. The frequency range from 150 kHz to 30 MHz was searched. Emission levels over 10dB under the prescribed limits could not be reported

4.1.3 TEST SETUP

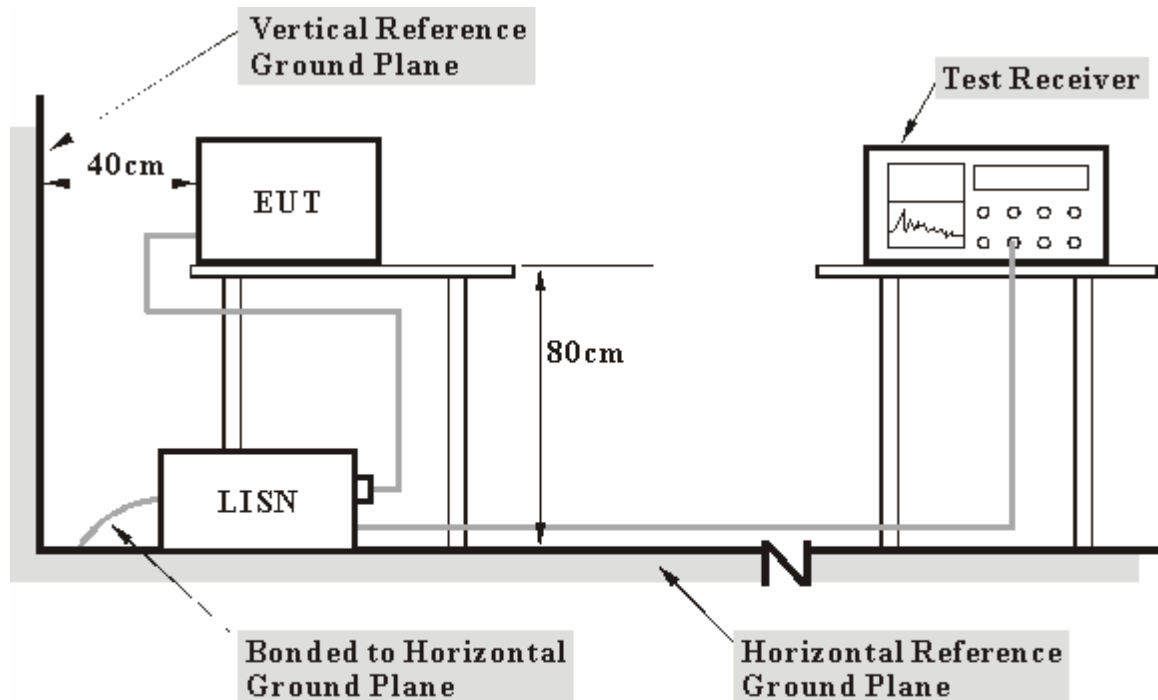

- Note:**
1. Support units were connected to second LISN.
 2. Both of LISNs (AMN) 80 cm from EUT and at the least 80 cm from other units and other metal planes support units.

For the actual test configuration, please refer to the related item – Photographs of the Test Configuration.



4.1.4 EUT OPERATING CONDITIONS

- a. Plug the EUT into the Wireless LAN basestation placed on a testing table.
- b. The computer system ran a test program to enable EUT under transmission/receiving condition continuously at specific channel frequency.



4.1.5 TEST RESULTS

EUT	802.11b/g MiniPCI Module	MODEL	G11FNF
MODE	Channel 1	6dB BANDWIDTH	9 kHz
INPUT POWER (SYSTEM)	120Vac, 60 Hz	PHASE	Line (L)
ENVIRONMENTAL CONDITIONS	26 deg. C, 59%RH, 979 hPa	TESTED BY	Tony Chen

No	Freq. [MHz]	Corr. Factor (dB)	Reading Value [dB (uV)]		Emission Level [dB (uV)]		Limit [dB (uV)]		Margin (dB)	
			Q.P.	AV.	Q.P.	AV.	Q.P.	AV.	Q.P.	AV.
1	0.216	0.10	34.81	-	34.91	-	62.96	52.96	-28.05	-
2	0.322	0.10	35.06	-	35.16	-	59.66	49.66	-24.50	-
3	1.330	0.10	41.06	-	41.16	-	56.00	46.00	-14.84	-
4	2.759	0.14	42.44	-	42.58	-	56.00	46.00	-13.42	-
5	4.652	0.29	34.09	-	34.38	-	56.00	46.00	-21.62	-
6	25.262	1.20	39.52	-	40.72	-	60.00	50.00	-19.28	-

- NOTES: (1) "*": Undetectable
 (2) Q.P. and AV. are abbreviations of quasi-peak and average.
 (3) "-": The Quasi-peak reading value also meets an average limit, thus measurement with the average detector is unnecessary.
 (4) The emission levels of other frequencies were very low against the limit.
 (5) Correction Factor = Insertion loss + Cable loss
 (6) Margin value = Emission level - Limit value

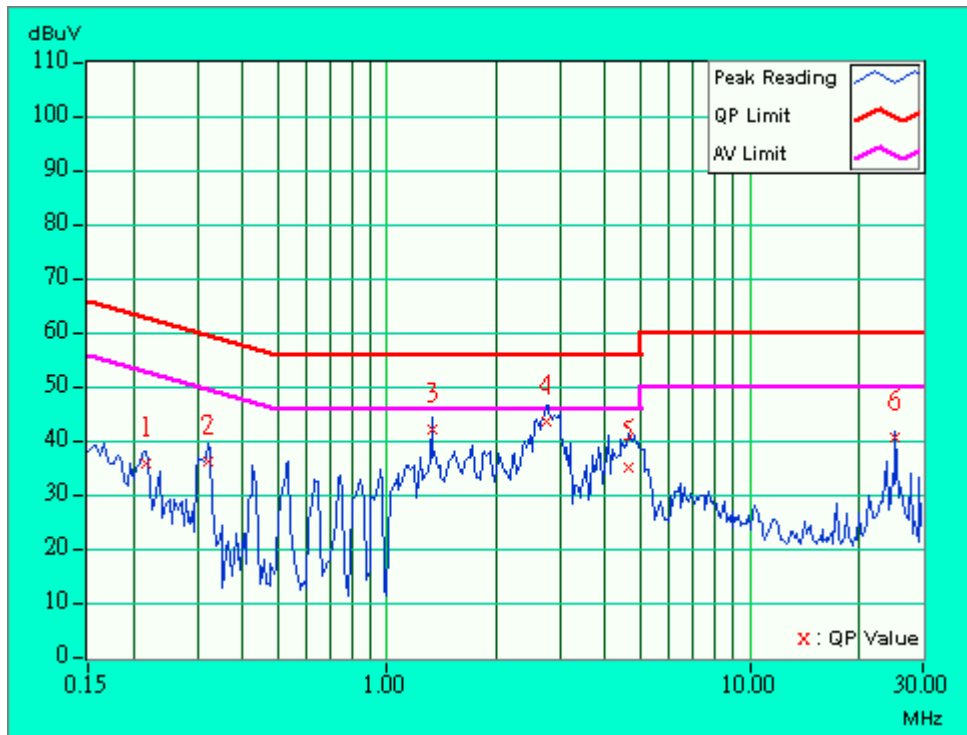



EUT	802.11b/g MiniPCI Module	MODEL	G11FNF
MODE	Channel 1	6dB BANDWIDTH	9 kHz
INPUT POWER (SYSTEM)	120Vac, 60 Hz	PHASE	Neutral (N)
ENVIRONMENTAL CONDITIONS	26 deg. C, 59%RH, 979 hPa	TESTED BY	Tony Chen

No	Freq. [MHz]	Corr. Factor (dB)	Reading Value [dB (uV)]		Emission Level [dB (uV)]		Limit [dB (uV)]		Margin (dB)	
			Q.P.	AV.	Q.P.	AV.	Q.P.	AV.	Q.P.	AV.
1	0.213	0.10	33.35	-	33.45	-	63.11	53.11	-29.66	-
2	0.326	0.10	32.59	-	32.69	-	59.56	49.56	-26.87	-
3	1.330	0.10	40.99	-	41.09	-	56.00	46.00	-14.91	-
4	2.775	0.14	42.60	-	42.74	-	56.00	46.00	-13.26	-
5	4.693	0.28	33.84	-	34.12	-	56.00	46.00	-21.88	-
6	25.254	0.90	42.18	-	43.08	-	60.00	50.00	-16.92	-

- NOTES: (1) "-": Undetectable
 (2) Q.P. and AV. are abbreviations of quasi-peak and average.
 (3) "-": The Quasi-peak reading value also meets an average limit, thus measurement with the average detector is unnecessary.
 (4) The emission levels of other frequencies were very low against the limit.
 (5) Correction Factor = Insertion loss + Cable loss
 (6) Margin value = Emission level - Limit value

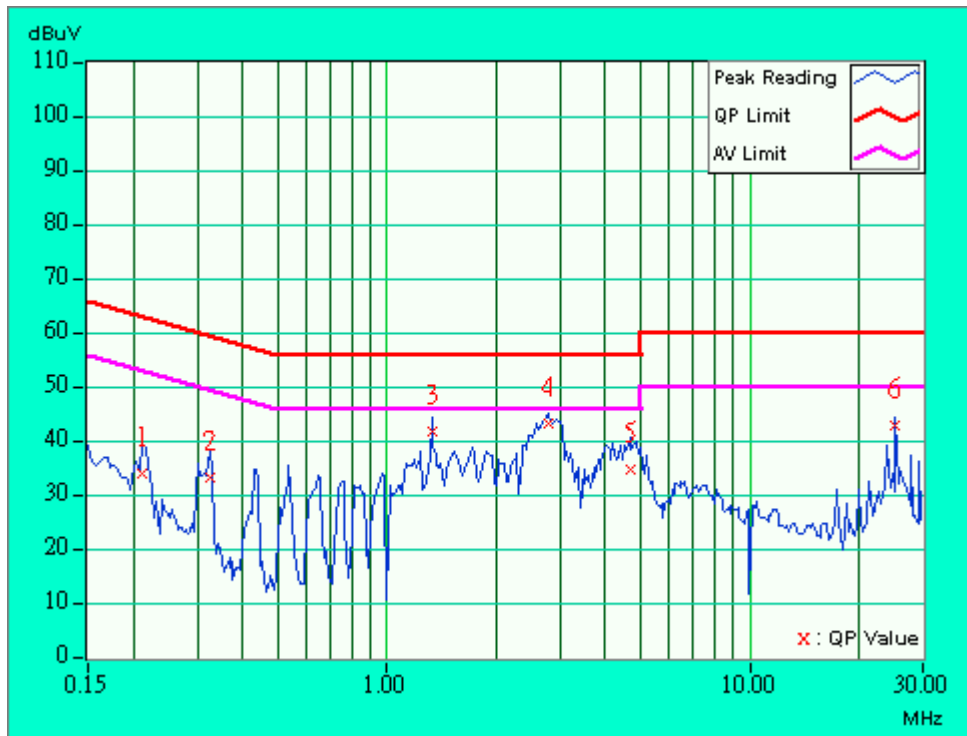



EUT	802.11b/g MiniPCI Module	MODEL	G11FNF
MODE	Channel 6	6dB BANDWIDTH	9 kHz
INPUT POWER (SYSTEM)	120Vac, 60 Hz	PHASE	Line (L)
ENVIRONMENTAL CONDITIONS	26 deg. C, 59%RH, 979 hPa	TESTED BY	Tony Chen

No	Freq. [MHz]	Corr. Factor (dB)	Reading Value [dB (uV)]		Emission Level [dB (uV)]		Limit [dB (uV)]		Margin (dB)	
			Q.P.	AV.	Q.P.	AV.	Q.P.	AV.	Q.P.	AV.
1	0.216	0.10	34.85	-	34.95	-	62.96	52.96	-28.01	-
2	0.321	0.10	34.35	-	34.45	-	59.69	49.69	-25.24	-
3	0.529	0.10	31.72	-	31.82	-	56.00	46.00	-24.18	-
4	1.330	0.10	41.02	-	41.12	-	56.00	46.00	-14.88	-
5	2.798	0.14	42.33	-	42.47	-	56.00	46.00	-13.53	-
6	4.695	0.29	35.15	-	35.44	-	56.00	46.00	-20.56	-
7	25.264	1.20	39.56	-	40.76	-	60.00	50.00	-19.24	-

- NOTES: (1) "": Undetectable
 (2) Q.P. and AV. are abbreviations of quasi-peak and average.
 (3) "-": The Quasi-peak reading value also meets an average limit, thus measurement with the average detector is unnecessary.
 (4) The emission levels of other frequencies were very low against the limit.
 (5) Correction Factor = Insertion loss + Cable loss
 (6) Margin value = Emission level - Limit value

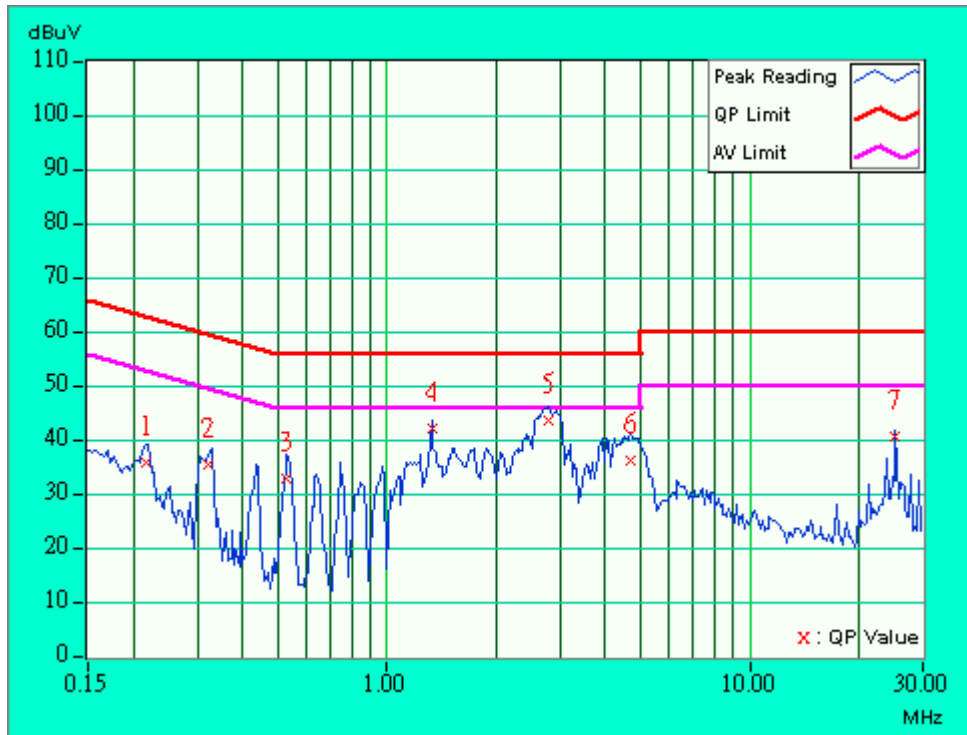



EUT	802.11b/g MiniPCI Module	MODEL	G11FNF
MODE	Channel 6	6dB BANDWIDTH	9 kHz
INPUT POWER (SYSTEM)	120Vac, 60 Hz	PHASE	Neutral (N)
ENVIRONMENTAL CONDITIONS	26 deg. C, 59%RH, 979 hPa	TESTED BY	Tony Chen

No	Freq. [MHz]	Corr. Factor (dB)	Reading Value [dB (uV)]		Emission Level [dB (uV)]		Limit [dB (uV)]		Margin (dB)	
			Q.P.	AV.	Q.P.	AV.	Q.P.	AV.	Q.P.	AV.
1	0.213	0.10	33.24	-	33.34	-	63.11	53.11	-29.77	-
2	0.533	0.10	30.96	-	31.06	-	56.00	46.00	-24.94	-
3	1.330	0.10	41.14	-	41.24	-	56.00	46.00	-14.76	-
4	2.770	0.14	42.04	-	42.18	-	56.00	46.00	-13.82	-
5	4.637	0.27	36.78	-	37.05	-	56.00	46.00	-18.95	-
6	25.266	0.90	42.00	-	42.90	-	60.00	50.00	-17.10	-

- NOTES: (1) "-": Undetectable
 (2) Q.P. and AV. are abbreviations of quasi-peak and average.
 (3) "-": The Quasi-peak reading value also meets an average limit, thus measurement with the average detector is unnecessary.
 (4) The emission levels of other frequencies were very low against the limit.
 (5) Correction Factor = Insertion loss + Cable loss
 (6) Margin value = Emission level - Limit value

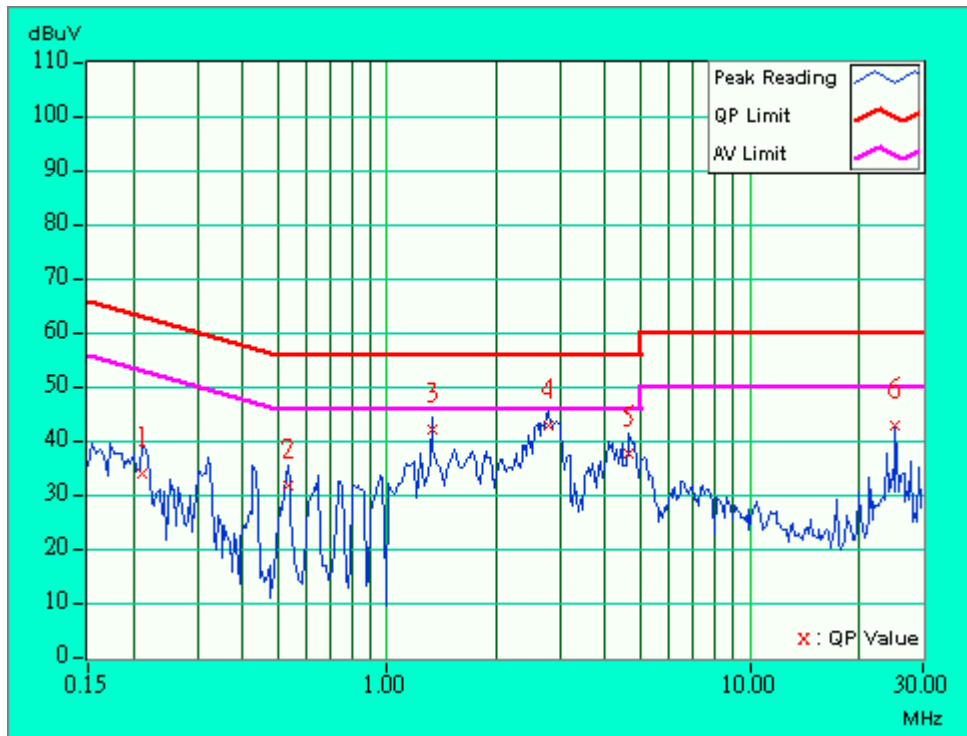



EUT	802.11b/g MiniPCI Module	MODEL	G11FNF
MODE	Channel 11	6dB BANDWIDTH	9 kHz
INPUT POWER (SYSTEM)	120Vac, 60 Hz	PHASE	Line (L)
ENVIRONMENTAL CONDITIONS	26 deg. C, 59%RH, 979 hPa	TESTED BY	Tony Chen

No	Freq. [MHz]	Corr. Factor (dB)	Reading Value [dB (uV)]		Emission Level [dB (uV)]		Limit [dB (uV)]		Margin (dB)	
			Q.P.	AV.	Q.P.	AV.	Q.P.	AV.	Q.P.	AV.
1	0.216	0.10	34.99	-	35.09	-	62.96	52.96	-27.87	-
2	0.326	0.10	35.10	-	35.20	-	59.56	49.56	-24.36	-
3	1.330	0.10	41.26	-	41.36	-	56.00	46.00	-14.64	-
4	2.798	0.14	42.39	-	42.53	-	56.00	46.00	-13.47	-
5	4.777	0.30	36.01	-	36.31	-	56.00	46.00	-19.69	-
6	25.275	1.20	39.03	-	40.23	-	60.00	50.00	-19.77	-

- NOTES: (1) "-": Undetectable
 (2) Q.P. and AV. are abbreviations of quasi-peak and average.
 (3) "-": The Quasi-peak reading value also meets an average limit, thus measurement with the average detector is unnecessary.
 (4) The emission levels of other frequencies were very low against the limit.
 (5) Correction Factor = Insertion loss + Cable loss
 (6) Margin value = Emission level - Limit value

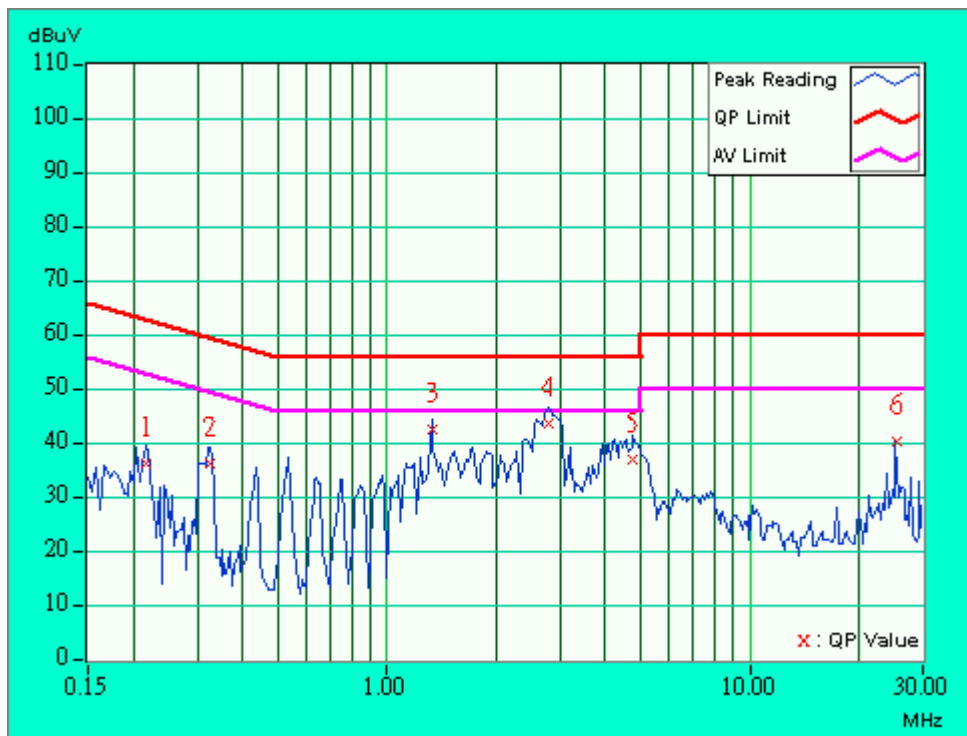



EUT	802.11b/g MiniPCI Module	MODEL	G11FNF
MODE	Channel 11	6dB BANDWIDTH	9 kHz
INPUT POWER (SYSTEM)	120Vac, 60 Hz	PHASE	Neutral (N)
ENVIRONMENTAL CONDITIONS	26 deg. C, 59%RH, 979 hPa	TESTED BY	Tony Chen

No	Freq. [MHz]	Corr. Factor (dB)	Reading Value [dB (uV)]		Emission Level [dB (uV)]		Limit [dB (uV)]		Margin (dB)	
			Q.P.	AV.	Q.P.	AV.	Q.P.	AV.	Q.P.	AV.
1	0.213	0.10	32.82	-	32.92	-	63.11	53.11	-30.19	-
2	0.529	0.10	29.73	-	29.83	-	56.00	46.00	-26.17	-
3	1.330	0.10	41.14	-	41.24	-	56.00	46.00	-14.76	-
4	2.802	0.14	42.59	-	42.73	-	56.00	46.00	-13.27	-
5	4.465	0.25	35.34	-	35.59	-	56.00	46.00	-20.41	-
6	25.272	0.90	42.10	-	43.00	-	60.00	50.00	-17.00	-

- NOTES: (1) "-": Undetectable
 (2) Q.P. and AV. are abbreviations of quasi-peak and average.
 (3) "-": The Quasi-peak reading value also meets an average limit, thus measurement with the average detector is unnecessary.
 (4) The emission levels of other frequencies were very low against the limit.
 (5) Correction Factor = Insertion loss + Cable loss
 (6) Margin value = Emission level - Limit value

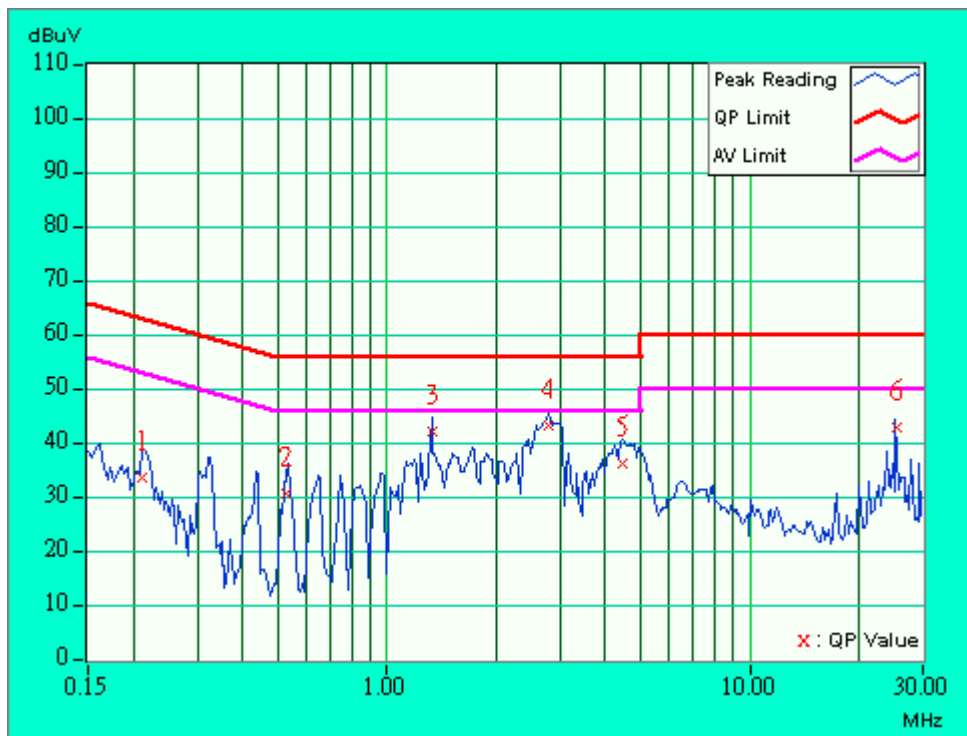



4.2 RADIATED EMISSION MEASUREMENT

4.2.1 LIMITS OF RADIATED EMISSION MEASUREMENT

Field strength limits are at the distance of 3 meters, emissions radiated outside of the specified bands, shall be according to the general radiated limits in 15.209 as following:

Frequencies (MHz)	Field Strength of Fundamental	
	uV/m	dBuV/m
30-88	100	40.0
88-216	150	43.5
216-960	200	46.0
Above 960	500	54.0

NOTE

1. The lower limit shall apply at the transition frequencies.
2. Emission level (dBuV/m) = 20 log Emission level (uV/m).
3. As shown in 15.35(b), for frequencies above 1000MHz, the field strength limits are based on average detector, however, the peak field strength of any emission shall not exceed the maximum permitted average limits, specified above by more than 20dB under any condition of modulation.



4.2.2 TEST INSTRUMENTS

DESCRIPTION & MANUFACTURER	MODEL NO.	SERIAL NO.	CALIBRATED UNTIL
HP Spectrum Analyzer	8594ER	3829U04676	Jul. 14, 2003
ADVANTEST Spectrum Analyzer	R3271A	85060311	May 21, 2003
CHASE RF Pre_Amplifier	CPA9232	1057	Apr. 24, 2004
HP Pre_Amplifier	8449B	3008A01281	June 27, 2004
ROHDE & SCHWARZ Test Receiver	ESVS 10	849231 /019	Nov. 03, 2003
CHASE Broadband Antenna	CBL6111c	2730	Jul 17, 2003
Schwarzbeck Horn_Antenna	BBHA9120-D1	D123	Jul. 31, 2003
SCHWARZBECK Tunable Dipole Antenna	UHAP	897	Mar. 07, 2005
SCHWARZBECK Tunable Dipole Antenna	VHAP	880	Mar. 07, 2005
RF Switches (ARNITSU)	CS-201	1565157	Jul. 29, 2003
RF CABLE (Chaintek) 1GHz-20GHz	Ak 9515-D	001	Aug, 20.2003
RF Cable(RICHTEC)	9913-30M	STCCAB-30M-1GH z-021	Nov. 5, 2003
Software	AS60P8	NA	NA
CHANCE MOST Antenna Tower	AT-100	0203	NA
CHANCE MOST Turn Table	TT-100	0203	NA

Note: 1. The calibration interval of the above test instruments is 12 months (36 months for Tunable Dipole Antenna) and the calibrations are traceable to NML/ROC and NIST/USA.

2. * = These equipment are used for the final measurement.
3. The horn antenna and HP preamplifier (model: 8449B) are used only for the measurement of emission frequency above 1GHz if tested.
4. The test was performed in ADT Open Site No. C.
5. The FCC Site Registration No. is 656396.
6. The VCCI Site Registration No. is R-1626.



4.2.3 TEST PROCEDURES

- a. The EUT was placed on the top of a rotating table 0.8 meters above the ground at a 10 meter open area test site. The table was rotated 360 degrees to determine the position of the highest radiation.
- b. The EUT was set 3 meters away from the interference-receiving antenna, which was mounted on the top of a variable-height antenna tower.
- c. The antenna is a broadband antenna, and its height is varied from one meter to four meters above the ground to determine the maximum value of the field strength. Both horizontal and vertical polarizations of the antenna are set to make the measurement.
- d. For each suspected emission, the EUT was arranged to its worst case and then the antenna was tuned to heights from 1 meter to 4 meters and the rotatable table was turned from 0 degrees to 360 degrees to find the maximum reading.
- e. The test-receiver system was set to Peak Detect Function and Specified Bandwidth with Maximum Hold Mode.
- f. If the emission level of the EUT in peak mode was 10 dB lower than the limit specified, then testing could be stopped and the peak values of the EUT would be reported. Otherwise the emissions that did not have 10 dB margin would be re-tested one by one using peak, quasi-peak or average method as specified and then reported in a data sheet.

NOTE:

1. The resolution bandwidth and video bandwidth of test receiver/spectrum analyzer is 120kHz for Peak detection (PK) and Quasi-peak detection (QP) at frequency below 1GHz.
2. The resolution bandwidth and video bandwidth of test receiver/spectrum analyzer is 1 MHz for Peak detection at frequency above 1GHz.
3. The resolution bandwidth of test receiver/spectrum analyzer is 1 MHz and the video bandwidth is 300 Hz for Average detection (AV) at frequency above 1GHz.

4.2.4 TEST SETUP

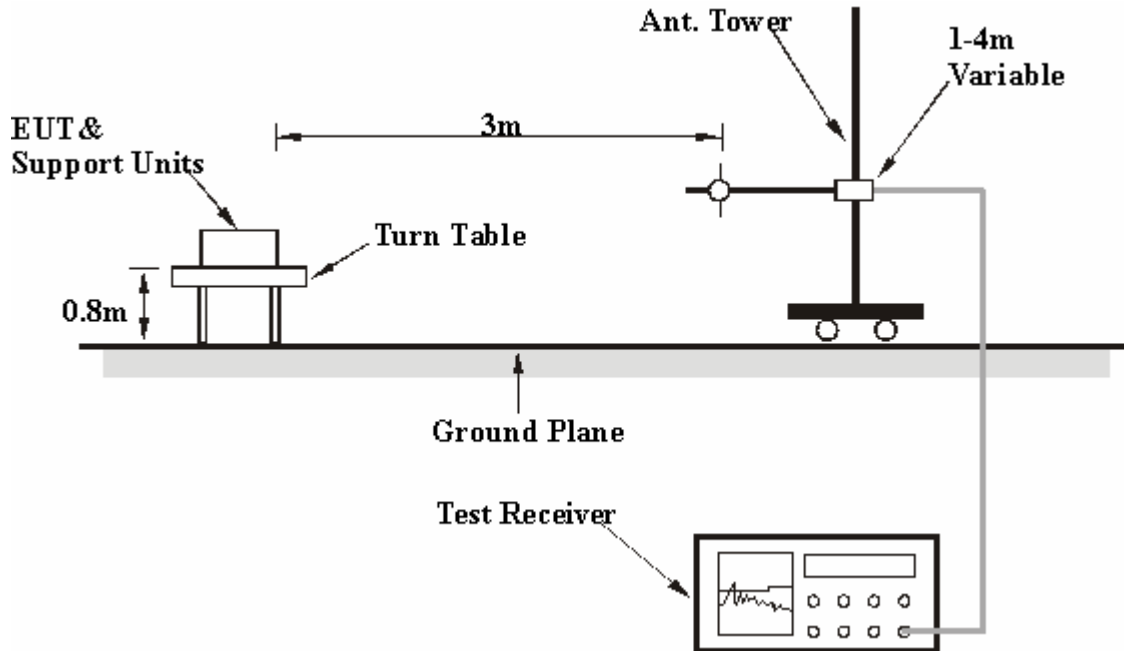

For the actual test configuration, please refer to the related item – Photographs of the Test Configuration.

4.2.5 EUT OPERATING CONDITIONS

Same as 4.1.5.



4.2.6 TEST RESULTS (A)

EUT	802.11b/g MiniPCI Module	MODEL	G11FNF
MODE	Channel 11	FREQUENCY RANGE	30-1000 MHz
INPUT POWER (SYSTEM)	120Vac, 60 Hz	DETECTOR FUNCTION	Quasi-Peak
ENVIRONMENTAL CONDITIONS	26 deg. C, 58 % RH, 979 hPa	TESTED BY	Eric Lee

ANTENNA POLARITY & TEST DISTANCE: HORIZONTAL AT 3 M

No.	Freq. (MHz)	Emission Level (dBuV/m)	Limit (dBuV/m)	Margin (dB)	Antenna Height (m)	Table Angle (Degree)	Raw Value (dBuV)	Correction Factor (dB/m)
1	125.02	35.5 QP	43.50	-8.00	1.57 H	299	23.40	12.10
2	132.20	30.9 QP	43.50	-12.60	1.25 H	41	19.00	11.90
3	175.03	36.4 QP	43.50	-7.10	1.34 H	297	27.10	9.30
4	200.02	31.1 QP	43.50	-12.40	1.54 H	1	22.10	9.00
5	250.00	43.4 QP	46.00	-2.60	1.47 H	184	30.20	13.20
6	264.00	34.0 QP	46.00	-12.00	1.42 H	35	19.90	14.10
7	288.00	42.2 QP	46.00	-3.80	1.57 H	249	28.40	13.80
8	352.00	35.5 QP	46.00	-10.50	1.13 H	198	19.90	15.60
9	480.00	42.0 QP	46.00	-4.00	1.29 H	239	23.10	18.90
10	650.03	35.9 QP	46.00	-10.10	1.01 H	32	13.80	22.10

ANTENNA POLARITY & TEST DISTANCE: VERTICAL AT 3 M

No.	Freq. (MHz)	Emission Level (dBuV/m)	Limit (dBuV/m)	Margin (dB)	Antenna Height (m)	Table Angle (Degree)	Raw Value (dBuV)	Correction Factor (dB/m)
1	125.01	37.5 QP	43.50	-6.00	1.00 V	23	25.40	12.10
2	132.09	30.8 QP	43.50	-12.70	1.07 V	258	18.90	11.90
3	175.01	39.2 QP	43.50	-4.30	1.04 V	309	29.90	9.30
4	200.02	38.3 QP	43.50	-5.20	1.00 V	254	29.30	9.00
5	250.00	43.2 QP	46.00	-2.80	1.00 V	57	30.00	13.20
6	288.00	37.9 QP	46.00	-8.10	1.00 V	81	24.10	13.80
7	352.00	33.9 QP	46.00	-12.10	1.12 V	258	18.30	15.60
8	480.01	42.1 QP	46.00	-3.90	1.12 V	232	23.20	18.90
9	512.01	36.3 QP	46.00	-9.70	1.20 V	298	16.90	19.40
10	650.00	35.9 QP	46.00	-10.10	1.11 V	200	13.80	22.10

- REMARKS:**
1. Emission level(dBuV/m)=Raw Value(dBuV) + Correction Factor(dB)
 2. Correction Factor(dB/m) = Antenna Factor (dB/m) + Cable Factor (dB)
 3. The other emission levels were very low against the limit.
 4. Margin value = Emission level – Limit value.
 5. The limit value is defined as per 15.247



4.2.7 TEST RESULTS (A) - DSSS

EUT	802.11b/g MiniPCI Module	MODEL	G11FNF
MODE	Channel 1	FREQUENCY RANGE	Above 1000 MHz
INPUT POWER (SYSTEM)	120Vac, 60 Hz	DETECTOR FUNCTION	Peak(PK) Average(AV)
ENVIRONMENTAL CONDITIONS	22 deg. C, 57%RH, 979 hPa	TESTED BY	Eric Lee

ANTENNA POLARITY & TEST DISTANCE: HORIZONTAL AT 3 M

No.	Freq. (MHz)	Emission Level (dBuV/m)	Limit (dBuV/m)	Margin (dB)	Antenna Height (m)	Table Angle (Degree)	Raw Value (dBuV)	Correction Factor (dB/m)
1	2390.00	55.6 PK	74.00	-18.40	1.05 H	169	26.40	29.20
1	2390.00	43.4 AV	54.00	-10.60	1.05 H	169	14.20	29.20
2	*2412.00	100.1 PK			1.10 H	301	70.20	29.90
2	*2412.00	92.8 AV			1.10 H	301	62.90	29.90
3	2496.00	55.7 PK	74.00	-18.30	1.25 H	1	25.90	29.80
3	2496.00	44.4 AV	54.00	-9.60	1.25 H	1	14.60	29.80
4	4824.00	37.0 PK	74.00	-37.00	1.00 H	45	1.50	35.60

ANTENNA POLARITY & TEST DISTANCE: VERTICAL AT 3 M

No.	Freq. (MHz)	Emission Level (dBuV/m)	Limit (dBuV/m)	Margin (dB)	Antenna Height (m)	Table Angle (Degree)	Raw Value (dBuV)	Correction Factor (dB/m)
1	2390.00	57.7 PK	74.00	-16.30	1.02 V	63	28.40	29.20
1	2390.00	47.7 AV	54.00	-6.30	1.02 V	63	18.50	29.20
2	*2412.00	109.8 PK			1.13 V	1	79.90	29.90
2	*2412.00	100.5 AV			1.13 V	1	70.60	29.90
3	2484.00	57.8 PK	74.00	-16.20	1.23 V	154	27.60	30.10
3	2484.00	46.4 AV	54.00	-7.60	1.23 V	154	16.20	30.10
4	4824.00	37.7 PK	74.00	-36.30	1.58 V	63	2.10	35.60

- REMARKS:**
1. Emission level(dBuV/m)=Raw Value(dBuV) + Correction Factor(dB)
 2. Correction Factor(dB/m) = Antenna Factor (dB/m) + Cable Factor (dB)
 3. The other emission levels were very low against the limit.
 4. Margin value = Emission level – Limit value.
 5. The limit value is defined as per 15.247
 6. " * " : Fundamental frequency



EUT	802.11b/g MiniPCI Module	MODEL	G11FNF
MODE	Channel 6	FREQUENCY RANGE	Above 1000 MHz
INPUT POWER (SYSTEM)	120Vac, 60 Hz	DETECTOR FUNCTION	Peak(PK) Average (AV)
ENVIRONMENTAL CONDITIONS	22 deg. C, 57%RH, 979 hPa	TESTED BY	Eric Lee

ANTENNA POLARITY & TEST DISTANCE: HORIZONTAL AT 3 M

No.	Freq. (MHz)	Emission Level (dBuV/m)	Limit (dBuV/m)	Margin (dB)	Antenna Height (m)	Table Angle (Degree)	Raw Value (dBuV)	Correction Factor (dB/m)
1	2390.00	54.5 PK	74.00	-19.50	1.00 H	247	25.30	29.20
1	2390.00	43.5 AV	54.00	-10.50	1.00 H	247	14.20	29.20
2	*2437.00	100.1 PK			1.10 H	300	70.20	30.00
2	*2437.00	94.2 AV			1.10 H	300	64.20	30.00
3	2484.00	55.8 PK	74.00	-18.20	1.35 H	281	25.60	30.10
3	2484.00	45.0 AV	54.00	-9.00	1.35 H	281	14.90	30.10
4	4874.00	35.6 PK	74.00	-38.40	1.43 H	327	-0.10	35.70

ANTENNA POLARITY & TEST DISTANCE: VERTICAL AT 3 M

No.	Freq. (MHz)	Emission Level (dBuV/m)	Limit (dBuV/m)	Margin (dB)	Antenna Height (m)	Table Angle (Degree)	Raw Value (dBuV)	Correction Factor (dB/m)
1	2390.00	56.6 PK	74.00	-17.40	1.06 V	254	27.30	29.20
1	2390.00	45.5 AV	54.00	-8.50	1.06 V	254	16.20	29.20
2	*2437.00	108.1 PK			1.11 V	2	78.10	30.00
2	*2437.00	100.2 AV			1.11 V	2	70.20	30.00
3	2484.00	57.1 PK	74.00	-16.90	1.00 V	326	26.90	30.10
3	2484.00	46.7 AV	54.00	-7.30	1.00 V	326	16.60	30.10
4	4874.00	37.8 PK	74.00	-36.20	1.07 V	47	2.00	35.70

- REMARKS:**
1. Emission level(dBuV/m)=Raw Value(dBuV) + Correction Factor(dB)
 2. Correction Factor(dB/m) = Antenna Factor (dB/m) + Cable Factor (dB)
 3. The other emission levels were very low against the limit.
 4. Margin value = Emission level – Limit value.
 5. The limit value is defined as per 15.247
 6. “ * “ : Fundamental frequency



EUT	802.11b/g MiniPCI Module	MODEL	G11FNF
MODE	Channel 11	FREQUENCY RANGE	Above 1000 MHz
INPUT POWER (SYSTEM)	120Vac, 60 Hz	DETECTOR FUNCTION	Peak(PK) Average (AV)
ENVIRONMENTAL CONDITIONS	22 deg. C, 57%RH, 979 hPa	TESTED BY	Eric Lee

ANTENNA POLARITY & TEST DISTANCE: HORIZONTAL AT 3 M

No.	Freq. (MHz)	Emission Level (dBuV/m)	Limit (dBuV/m)	Margin (dB)	Antenna Height (m)	Table Angle (Degree)	Raw Value (dBuV)	Correction Factor (dB/m)
1	2390.00	56.1 PK	74.00	-17.90	1.29 H	269	26.80	29.20
1	2390.00	43.8 AV	54.00	-10.20	1.29 H	269	14.60	29.20
2	*2462.00	100.5 PK			1.09 H	292	70.40	30.10
2	*2462.00	93.3 AV			1.09 H	292	63.20	30.10
3	2484.00	56.9 PK	74.00	-17.10	1.12 H	136	26.70	30.10
3	2484.00	47.5 AV	54.00	-6.50	1.12 H	136	17.40	30.10
4	4924.00	37.6 PK	74.00	-36.40	1.63 H	321	1.70	35.90

ANTENNA POLARITY & TEST DISTANCE: VERTICAL AT 3 M

No.	Freq. (MHz)	Emission Level (dBuV/m)	Limit (dBuV/m)	Margin (dB)	Antenna Height (m)	Table Angle (Degree)	Raw Value (dBuV)	Correction Factor (dB/m)
1	2390.00	58.9 PK	74.00	-15.10	1.03 V	12	29.70	29.20
1	2390.00	45.6 AV	54.00	-8.40	1.03 V	12	16.30	29.20
2	*2462.00	108.3 PK			1.09 V	1	78.20	30.10
2	*2462.00	100.7 AV			1.09 V	1	70.60	30.10
3	2484.00	61.0 PK	74.00	-13.00	1.22 V	151	30.90	30.10
3	2484.00	51.9 AV	54.00	-2.10	1.22 V	151	21.80	30.10
4	4924.00	38.4 PK	74.00	-35.60	1.22 V	151	2.60	35.90

- REMARKS:**
1. Emission level(dBuV/m)=Raw Value(dBuV) + Correction Factor(dB)
 2. Correction Factor(dB/m) = Antenna Factor (dB/m) + Cable Factor (dB)
 3. The other emission levels were very low against the limit.
 4. Margin value = Emission level – Limit value.
 5. The limit value is defined as per 15.247
 6. “ * “ : Fundamental frequency



4.2.8 TEST RESULTS (A) -OFDM

EUT	802.11b/g MiniPCI Module	MODEL	G11FNF
MODE	Channel 1	FREQUENCY RANGE	Above 1000 MHz
INPUT POWER (SYSTEM)	120Vac, 60 Hz	DETECTOR FUNCTION	Peak(PK) Average(AV)
ENVIRONMENTAL CONDITIONS	22 deg. C, 57%RH, 979 hPa	TESTED BY	Eric Lee

ANTENNA POLARITY & TEST DISTANCE: HORIZONTAL AT 3 M

No.	Freq. (MHz)	Emission Level (dBuV/m)	Limit (dBuV/m)	Margin (dB)	Antenna Height (m)	Table Angle (Degree)	Raw Value (dBuV)	Correction Factor (dB/m)
1	2390.00	58.4 PK	74.00	-15.60	1.45 H	73	29.10	29.20
1	2390.00	47.8 AV	54.00	-6.20	1.45 H	73	18.60	29.20
2	*2412.00	99.4 PK			1.21 H	66	69.50	29.90
2	*2412.00	91.7 AV			1.21 H	66	61.80	29.90
3	2496.00	56.3 PK	74.00	-17.70	1.52 H	296	26.50	29.80
3	2496.00	44.0 AV	54.00	-10.00	1.52 H	296	14.20	29.80
4	4824.00	35.3 PK	74.00	-38.70	1.00 H	210	-0.20	35.60

ANTENNA POLARITY & TEST DISTANCE: VERTICAL AT 3 M

No.	Freq. (MHz)	Emission Level (dBuV/m)	Limit (dBuV/m)	Margin (dB)	Antenna Height (m)	Table Angle (Degree)	Raw Value (dBuV)	Correction Factor (dB/m)
1	2390.00	62.1 PK	74.00	-11.90	1.50 V	262	32.80	29.20
1	2390.00	50.7 AV	54.00	-3.30	1.50 V	262	21.50	29.20
2	*2412.00	103.1 PK			1.27 V	157	73.20	29.90
2	*2412.00	95.5 AV			1.27 V	157	65.60	29.90
3	2496.00	57.1 PK	74.00	-16.90	1.24 V	326	27.30	29.80
3	2496.00	44.9 AV	54.00	-9.10	1.24 V	326	15.10	29.80
4	4824.00	37.7 PK	74.00	-36.30	1.14 V	200	2.10	35.60

- REMARKS:**
1. Emission level(dBuV/m)=Raw Value(dBuV) + Correction Factor(dB)
 2. Correction Factor(dB/m) = Antenna Factor (dB/m) + Cable Factor (dB)
 3. The other emission levels were very low against the limit.
 4. Margin value = Emission level – Limit value.
 5. The limit value is defined as per 15.247
 6. “ * “ : Fundamental frequency



EUT	802.11b/g MiniPCI Module	MODEL	G11FNF
MODE	Channel 6	FREQUENCY RANGE	Above 1000 MHz
INPUT POWER (SYSTEM)	120Vac, 60 Hz	DETECTOR FUNCTION	Peak(PK) Average (AV)
ENVIRONMENTAL CONDITIONS	22 deg. C, 57%RH, 979 hPa	TESTED BY	Eric Lee

ANTENNA POLARITY & TEST DISTANCE: HORIZONTAL AT 3 M

No.	Freq. (MHz)	Emission Level (dBuV/m)	Limit (dBuV/m)	Margin (dB)	Antenna Height (m)	Table Angle (Degree)	Raw Value (dBuV)	Correction Factor (dB/m)
1	2390.00	55.5 PK	74.00	-18.50	1.06 H	295	26.30	29.20
1	2390.00	43.7 AV	54.00	-10.30	1.06 H	295	14.50	29.20
2	*2437.00	98.7 PK			1.22 H	50	68.70	30.00
2	*2437.00	90.1 AV			1.22 H	50	60.10	30.00
3	2496.00	56.5 PK	74.00	-17.50	1.03 H	299	26.70	29.80
3	2496.00	45.0 AV	54.00	-9.00	1.03 H	299	15.20	29.80
4	4874.00	36.2 PK	74.00	-37.80	1.00 H	343	0.50	35.70

ANTENNA POLARITY & TEST DISTANCE: VERTICAL AT 3 M

No.	Freq. (MHz)	Emission Level (dBuV/m)	Limit (dBuV/m)	Margin (dB)	Antenna Height (m)	Table Angle (Degree)	Raw Value (dBuV)	Correction Factor (dB/m)
1	2390.00	55.6 PK	74.00	-18.40	1.59 V	36	26.30	29.20
1	2390.00	46.5 AV	54.00	-7.50	1.59 V	36	17.30	29.20
2	*2437.00	104.1 PK			1.02 V	3	74.10	30.00
2	*2437.00	94.4 AV			1.02 V	3	64.40	30.00
3	2496.00	57.8 PK	74.00	-16.20	1.23 V	5	27.90	29.80
3	2496.00	47.1 AV	54.00	-6.90	1.23 V	5	17.20	29.80
4	4874.00	37.1 PK	74.00	-36.90	1.54 V	42	1.40	35.70

- REMARKS:**
1. Emission level(dBuV/m)=Raw Value(dBuV) + Correction Factor(dB)
 2. Correction Factor(dB/m) = Antenna Factor (dB/m) + Cable Factor (dB)
 3. The other emission levels were very low against the limit.
 4. Margin value = Emission level – Limit value.
 5. The limit value is defined as per 15.247
 6. “ * “ : Fundamental frequency



EUT	802.11b/g MiniPCI Module	MODEL	G11FNF
MODE	Channel 11	FREQUENCY RANGE	Above 1000 MHz
INPUT POWER (SYSTEM)	120Vac, 60 Hz	DETECTOR FUNCTION	Peak(PK) Average (AV)
ENVIRONMENTAL CONDITIONS	22 deg. C, 57%RH, 979 hPa	TESTED BY	Eric Lee

ANTENNA POLARITY & TEST DISTANCE: HORIZONTAL AT 3 M

No.	Freq. (MHz)	Emission Level (dBuV/m)	Limit (dBuV/m)	Margin (dB)	Antenna Height (m)	Table Angle (Degree)	Raw Value (dBuV)	Correction Factor (dB/m)
1	2390.00	55.5 PK	74.00	-18.50	1.06 H	32	26.30	29.20
1	2390.00	43.4 AV	54.00	-10.60	1.06 H	32	14.20	29.20
2	*2462.00	100.1 PK			1.09 H	65	70.00	30.10
2	*2462.00	92.5 AV			1.09 H	65	62.40	30.10
3	2496.00	56.2 PK	74.00	-17.80	1.31 H	16	26.40	29.80
3	2496.00	48.2 AV	54.00	-5.80	1.31 H	16	18.30	29.80
4	4924.00	36.8 PK	74.00	-37.20	1.11 H	242	0.90	35.90

ANTENNA POLARITY & TEST DISTANCE: VERTICAL AT 3 M

No.	Freq. (MHz)	Emission Level (dBuV/m)	Limit (dBuV/m)	Margin (dB)	Antenna Height (m)	Table Angle (Degree)	Raw Value (dBuV)	Correction Factor (dB/m)
1	2390.00	57.5 PK	74.00	-16.50	1.35 V	230	28.20	29.20
1	2390.00	45.5 AV	54.00	-8.50	1.35 V	230	16.20	29.20
2	*2462.00	103.9 PK			1.06 V	1	73.80	30.10
2	*2462.00	95.5 AV			1.06 V	1	65.40	30.10
3	2496.00	62.0 PK	74.00	-12.00	1.54 V	20	32.10	29.80
3	2496.00	51.7 AV	54.00	-2.30	1.54 V	20	21.90	29.80
4	4924.00	37.5 PK	74.00	-36.50	1.06 V	271	1.60	35.90

- REMARKS:**
1. Emission level(dBuV/m)=Raw Value(dBuV) + Correction Factor(dB)
 2. Correction Factor(dB/m) = Antenna Factor (dB/m) + Cable Factor (dB)
 3. The other emission levels were very low against the limit.
 4. Margin value = Emission level – Limit value.
 5. The limit value is defined as per 15.247
 6. “ * “ : Fundamental frequency



4.2.9 TEST RESULTS (B)

EUT	802.11b/g MiniPCI Module	MODEL	G11FNF
MODE	Channel 10	FREQUENCY RANGE	30-1000 MHz
INPUT POWER (SYSTEM)	120Vac, 60 Hz	DETECTOR FUNCTION	Quasi-Peak
ENVIRONMENTAL CONDITIONS	20 deg. C, 84 % RH, 979 hPa	TESTED BY	Eric Lee

ANTENNA POLARITY & TEST DISTANCE: HORIZONTAL AT 3 M

No.	Freq. (MHz)	Emission Level (dBuV/m)	Limit (dBuV/m)	Margin (dB)	Antenna Height (m)	Table Angle (Degree)	Raw Value (dBuV)	Correction Factor (dB/m)
1	192.00	29.0 QP	43.50	-14.50	1.74 H	37	19.80	9.20
2	256.00	35.4 QP	46.00	-10.60	1.58 H	43	21.50	13.90
3	288.00	41.2 QP	46.00	-4.80	1.16 H	23	27.30	13.90
4	480.00	39.8 QP	46.00	-6.20	1.72 H	92	20.90	18.90
5	500.01	32.0 QP	46.00	-14.00	1.00 H	214	12.70	19.30
6	576.00	30.7 QP	46.00	-15.30	1.46 H	243	9.40	21.30
7	672.00	42.9 QP	46.00	-3.10	1.69 H	311	20.80	22.10
8	768.00	39.6 QP	46.00	-6.40	1.44 H	57	15.80	23.90
9	864.00	34.7 QP	46.00	-11.30	1.00 H	208	9.60	25.10
10	960.00	30.6 QP	46.00	-15.40	1.19 H	185	4.20	26.40

ANTENNA POLARITY & TEST DISTANCE: VERTICAL AT 3 M

No.	Freq. (MHz)	Emission Level (dBuV/m)	Limit (dBuV/m)	Margin (dB)	Antenna Height (m)	Table Angle (Degree)	Raw Value (dBuV)	Correction Factor (dB/m)
1	43.77	36.2 QP	40.00	-3.80	1.00 V	50	24.40	11.90
2	128.00	30.4 QP	43.50	-13.10	1.00 V	181	18.50	11.90
3	192.00	30.9 QP	43.50	-12.60	1.04 V	177	21.70	9.20
4	224.00	31.1 QP	46.00	-14.90	1.02 V	128	21.30	9.90
5	250.02	28.7 QP	46.00	-17.30	1.10 V	245	15.70	13.00
6	256.00	32.6 QP	46.00	-13.40	1.62 V	128	18.70	13.90
7	288.00	40.0 QP	46.00	-6.00	1.05 V	330	26.00	13.90
8	384.00	41.6 QP	46.00	-4.40	1.61 V	89	25.10	16.50
9	672.00	44.6 QP	46.00	-1.40	1.27 V	214	22.50	22.10
10	768.00	35.8 QP	46.00	-10.20	1.16 V	172	12.00	23.90
11	864.00	32.9 QP	46.00	-13.10	1.08 V	107	7.80	25.10

- REMARKS:**
1. Emission level(dBuV/m)=Raw Value(dBuV) + Correction Factor(dB)
 2. Correction Factor(dB/m) = Antenna Factor (dB/m) + Cable Factor (dB)
 3. The other emission levels were very low against the limit.
 4. Margin value = Emission level – Limit value.
 5. The limit value is defined as per 15.247



4.2.10 TEST RESULTS (B) - DSSS

EUT	802.11b/g MiniPCI Module	MODEL	G11FNF
MODE	Channel 2	FREQUENCY RANGE	Above 1000 MHz
INPUT POWER (SYSTEM)	120Vac, 60 Hz	DETECTOR FUNCTION	Peak(PK) Average(AV)
ENVIRONMENTAL CONDITIONS	22 deg. C, 57%RH, 979 hPa	TESTED BY	Eric Lee

ANTENNA POLARITY & TEST DISTANCE: HORIZONTAL AT 3 M

No.	Freq. (MHz)	Emission Level (dBuV/m)	Limit (dBuV/m)	Margin (dB)	Antenna Height (m)	Table Angle (Degree)	Raw Value (dBuV)	Correction Factor (dB/m)
1	2368.00	55.9 PK	74.00	-18.10	1.22 H	162	25.60	30.30
1	2368.00	46.5 AV	54.00	-7.50	1.22 H	162	16.20	30.30
2	*2417.00	96.3 PK			1.60 H	82	65.70	30.60
2	*2417.00	89.8 AV			1.60 H	82	59.20	30.60
3	2492.00	56.3 PK	74.00	-17.70	1.37 H	17	25.40	30.80
3	2492.00	47.2 AV	54.00	-6.80	1.37 H	17	16.30	30.80
4	4834.00	39.5 PK	74.00	-34.50	1.04 H	68	3.20	36.30

ANTENNA POLARITY & TEST DISTANCE: VERTICAL AT 3 M

No.	Freq. (MHz)	Emission Level (dBuV/m)	Limit (dBuV/m)	Margin (dB)	Antenna Height (m)	Table Angle (Degree)	Raw Value (dBuV)	Correction Factor (dB/m)
1	2388.00	57.3 PK	74.00	-16.70	1.31 V	84	26.90	30.40
1	2388.00	47.2 AV	54.00	-6.80	1.31 V	84	16.80	30.40
2	*2417.00	104.2 PK			1.01 V	96	73.60	30.60
2	*2417.00	97.8 AV			1.01 V	96	67.20	30.60
3	2496.00	56.6 PK	74.00	-17.40	1.24 V	144	25.90	30.80
3	2496.00	47.5 AV	54.00	-6.50	1.24 V	144	16.80	30.80
4	4834.00	37.9 PK	74.00	-36.10	1.40 V	34	1.60	36.30

- REMARKS:**
1. Emission level(dBuV/m)=Raw Value(dBuV) + Correction Factor(dB)
 2. Correction Factor(dB/m) = Antenna Factor (dB/m) + Cable Factor (dB)
 3. The other emission levels were very low against the limit.
 4. Margin value = Emission level – Limit value.
 5. The limit value is defined as per 15.247
 6. “ * “ : Fundamental frequency



EUT	802.11b/g MiniPCI Module	MODEL	G11FNF
MODE	Channel 6	FREQUENCY RANGE	Above 1000 MHz
INPUT POWER (SYSTEM)	120Vac, 60 Hz	DETECTOR FUNCTION	Peak(PK) Average (AV)
ENVIRONMENTAL CONDITIONS	22 deg. C, 57%RH, 979 hPa	TESTED BY	Eric Lee

ANTENNA POLARITY & TEST DISTANCE: HORIZONTAL AT 3 M

No.	Freq. (MHz)	Emission Level (dBuV/m)	Limit (dBuV/m)	Margin (dB)	Antenna Height (m)	Table Angle (Degree)	Raw Value (dBuV)	Correction Factor (dB/m)
1	2376.00	55.8 PK	74.00	-18.20	1.56 H	202	25.50	30.40
1	2376.00	46.5 AV	54.00	-7.50	1.56 H	202	16.10	30.40
2	*2437.00	95.5 PK			1.59 H	32	64.80	30.70
2	*2437.00	88.8 AV			1.59 H	32	58.10	30.70
3	2496.00	56.8 PK	74.00	-17.20	1.00 H	152	26.00	30.80
3	2496.00	47.1 AV	54.00	-6.90	1.00 H	152	16.30	30.80
4	4874.00	38.9 PK	74.00	-35.10	1.27 H	144	2.40	36.50

ANTENNA POLARITY & TEST DISTANCE: VERTICAL AT 3 M

No.	Freq. (MHz)	Emission Level (dBuV/m)	Limit (dBuV/m)	Margin (dB)	Antenna Height (m)	Table Angle (Degree)	Raw Value (dBuV)	Correction Factor (dB/m)
1	2389.00	56.0 PK	74.00	-18.00	1.21 V	127	25.60	30.40
1	2389.00	47.0 AV	54.00	-7.00	1.21 V	127	16.60	30.40
2	*2437.00	104.5 PK			1.02 V	69	73.80	30.70
2	*2437.00	97.3 AV			1.02 V	69	66.60	30.70
3	2496.00	57.3 PK	74.00	-16.70	1.23 V	109	26.50	30.80
3	2496.00	47.9 AV	54.00	-6.10	1.23 V	109	17.10	30.80
4	4874.00	37.9 PK	74.00	-36.10	1.87 V	94	1.50	36.50

- REMARKS:**
1. Emission level(dBuV/m)=Raw Value(dBuV) + Correction Factor(dB)
 2. Correction Factor(dB/m) = Antenna Factor (dB/m) + Cable Factor (dB)
 3. The other emission levels were very low against the limit.
 4. Margin value = Emission level – Limit value.
 5. The limit value is defined as per 15.247
 6. “ * “ : Fundamental frequency



EUT	802.11b/g MiniPCI Module	MODEL	G11FNF
MODE	Channel 10	FREQUENCY RANGE	Above 1000 MHz
INPUT POWER (SYSTEM)	120Vac, 60 Hz	DETECTOR FUNCTION	Peak(PK) Average (AV)
ENVIRONMENTAL CONDITIONS	22 deg. C, 57%RH, 979 hPa	TESTED BY	Eric Lee

ANTENNA POLARITY & TEST DISTANCE: HORIZONTAL AT 3 M

No.	Freq. (MHz)	Emission Level (dBuV/m)	Limit (dBuV/m)	Margin (dB)	Antenna Height (m)	Table Angle (Degree)	Raw Value (dBuV)	Correction Factor (dB/m)
1	2368.00	56.4 PK	74.00	-17.60	1.05 H	132	26.10	30.30
1	2368.00	46.4 AV	54.00	-7.60	1.05 H	132	16.10	30.30
2	*2457.00	94.5 PK			1.05 H	181	63.70	30.80
2	*2457.00	88.5 AV			1.05 H	181	57.70	30.80
3	2496.00	57.5 PK	74.00	-16.50	1.33 H	198	26.80	30.80
3	2496.00	47.1 AV	54.00	-6.90	1.33 H	198	16.30	30.80
4	4914.00	40.9 PK	74.00	-33.10	1.15 H	241	4.30	36.60

ANTENNA POLARITY & TEST DISTANCE: VERTICAL AT 3 M

No.	Freq. (MHz)	Emission Level (dBuV/m)	Limit (dBuV/m)	Margin (dB)	Antenna Height (m)	Table Angle (Degree)	Raw Value (dBuV)	Correction Factor (dB/m)
1	2389.00	57.2 PK	74.00	-16.80	1.21 V	56	26.80	30.40
1	2389.00	46.9 AV	54.00	-7.10	1.21 V	56	16.50	30.40
2	*2457.00	104.7 PK			1.04 V	182	73.90	30.80
2	*2457.00	98.1 AV			1.04 V	182	67.20	30.80
3	2489.00	57.0 PK	74.00	-17.00	1.44 V	152	26.20	30.90
3	2489.00	48.3 AV	54.00	-5.70	1.44 V	152	17.50	30.90
4	4914.00	40.2 PK	74.00	-33.80	1.06 V	216	3.60	36.60

- REMARKS:**
1. Emission level(dBuV/m)=Raw Value(dBuV) + Correction Factor(dB)
 2. Correction Factor(dB/m) = Antenna Factor (dB/m) + Cable Factor (dB)
 3. The other emission levels were very low against the limit.
 4. Margin value = Emission level – Limit value.
 5. The limit value is defined as per 15.247
 6. “ * “ : Fundamental frequency



4.2.11 TEST RESULTS (B) -OFDM

EUT	802.11b/g MiniPCI Module	MODEL	G11FNF
MODE	Channel 2	FREQUENCY RANGE	Above 1000 MHz
INPUT POWER (SYSTEM)	120Vac, 60 Hz	DETECTOR FUNCTION	Peak(PK) Average(AV)
ENVIRONMENTAL CONDITIONS	22 deg. C, 57%RH, 979 hPa	TESTED BY	Eric Lee

ANTENNA POLARITY & TEST DISTANCE: HORIZONTAL AT 3 M

No.	Freq. (MHz)	Emission Level (dBuV/m)	Limit (dBuV/m)	Margin (dB)	Antenna Height (m)	Table Angle (Degree)	Raw Value (dBuV)	Correction Factor (dB/m)
1	2387.00	55.7 PK	74.00	-18.30	2.10 H	197	25.30	30.40
1	2387.00	46.2 AV	54.00	-7.80	2.10 H	197	15.80	30.40
2	*2417.00	94.1 PK			1.35 H	51	63.50	30.60
2	*2417.00	86.8 AV			1.35 H	51	56.20	30.60
3	2496.00	57.0 PK	74.00	-17.00	1.19 H	303	26.30	30.80
3	2496.00	47.1 AV	54.00	-6.90	1.19 H	303	16.40	30.80
4	4834.00	38.8 PK	74.00	-35.20	1.04 H	96	2.50	36.30

ANTENNA POLARITY & TEST DISTANCE: VERTICAL AT 3 M

No.	Freq. (MHz)	Emission Level (dBuV/m)	Limit (dBuV/m)	Margin (dB)	Antenna Height (m)	Table Angle (Degree)	Raw Value (dBuV)	Correction Factor (dB/m)
1	2390.00	57.0 PK	74.00	-17.00	1.01 V	262	26.60	30.40
1	2390.00	47.2 AV	54.00	-6.80	1.01 V	262	16.80	30.40
2	*2417.00	101.6 PK			1.00 V	96	71.00	30.60
2	*2417.00	94.3 AV			1.00 V	96	63.70	30.60
3	2496.00	57.2 PK	74.00	-16.80	1.39 V	354	26.40	30.80
3	2496.00	47.7 AV	54.00	-6.30	1.39 V	354	17.00	30.80
4	4834.00	39.6 PK	74.00	-34.40	1.45 V	117	3.30	36.30

- REMARKS:**
1. Emission level(dBuV/m)=Raw Value(dBuV) + Correction Factor(dB)
 2. Correction Factor(dB/m) = Antenna Factor (dB/m) + Cable Factor (dB)
 3. The other emission levels were very low against the limit.
 4. Margin value = Emission level – Limit value.
 5. The limit value is defined as per 15.247
 6. “ * “ : Fundamental frequency



EUT	802.11b/g MiniPCI Module	MODEL	G11FNF
MODE	Channel 6	FREQUENCY RANGE	Above 1000 MHz
INPUT POWER (SYSTEM)	120Vac, 60 Hz	DETECTOR FUNCTION	Peak(PK) Average (AV)
ENVIRONMENTAL CONDITIONS	22 deg. C, 57%RH, 979 hPa	TESTED BY	Eric Lee

ANTENNA POLARITY & TEST DISTANCE: HORIZONTAL AT 3 M

No.	Freq. (MHz)	Emission Level (dBuV/m)	Limit (dBuV/m)	Margin (dB)	Antenna Height (m)	Table Angle (Degree)	Raw Value (dBuV)	Correction Factor (dB/m)
1	2374.00	55.6 PK	74.00	-18.40	1.95 H	291	25.20	30.40
1	2374.00	46.4 AV	54.00	-7.60	1.95 H	291	16.10	30.40
2	*2437.00	93.5 PK			2.00 H	338	62.80	30.70
2	*2437.00	85.3 AV			2.00 H	338	54.60	30.70
3	2496.00	57.0 PK	74.00	-17.00	1.84 H	231	26.30	30.80
3	2496.00	47.0 AV	54.00	-7.00	1.84 H	231	16.20	30.80
4	4874.00	39.3 PK	74.00	-34.70	1.10 H	201	2.90	36.50

ANTENNA POLARITY & TEST DISTANCE: VERTICAL AT 3 M

No.	Freq. (MHz)	Emission Level (dBuV/m)	Limit (dBuV/m)	Margin (dB)	Antenna Height (m)	Table Angle (Degree)	Raw Value (dBuV)	Correction Factor (dB/m)
1	2386.00	56.4 PK	74.00	-17.60	1.73 V	284	26.00	30.40
1	2386.00	46.4 AV	54.00	-7.60	1.73 V	284	16.00	30.40
2	*2437.00	100.7 PK			1.00 V	69	70.00	30.70
2	*2437.00	93.5 AV			1.00 V	69	62.80	30.70
3	2496.00	56.2 PK	74.00	-17.80	1.91 V	323	25.40	30.80
3	2496.00	47.6 AV	54.00	-6.40	1.91 V	323	16.80	30.80
4	4874.00	38.6 PK	74.00	-35.40	1.75 V	222	2.10	36.50

- REMARKS:**
1. Emission level(dBuV/m)=Raw Value(dBuV) + Correction Factor(dB)
 2. Correction Factor(dB/m) = Antenna Factor (dB/m) + Cable Factor (dB)
 3. The other emission levels were very low against the limit.
 4. Margin value = Emission level – Limit value.
 5. The limit value is defined as per 15.247
 6. “ * “ : Fundamental frequency



EUT	802.11b/g MiniPCI Module	MODEL	G11FNF
MODE	Channel 10	FREQUENCY RANGE	Above 1000 MHz
INPUT POWER (SYSTEM)	120Vac, 60 Hz	DETECTOR FUNCTION	Peak(PK) Average (AV)
ENVIRONMENTAL CONDITIONS	22 deg. C, 57%RH, 979 hPa	TESTED BY	Eric Lee

ANTENNA POLARITY & TEST DISTANCE: HORIZONTAL AT 3 M

No.	Freq. (MHz)	Emission Level (dBuV/m)	Limit (dBuV/m)	Margin (dB)	Antenna Height (m)	Table Angle (Degree)	Raw Value (dBuV)	Correction Factor (dB/m)
1	2372.00	55.8 PK	74.00	-18.20	1.38 H	222	25.40	30.40
1	2372.00	46.5 AV	54.00	-7.50	1.38 H	222	16.10	30.40
2	*2455.00	92.9 PK			1.13 H	333	62.10	30.80
2	*2455.00	85.8 AV			1.13 H	333	55.00	30.80
3	2491.00	56.9 PK	74.00	-17.10	1.18 H	334	26.10	30.80
3	2491.00	47.2 AV	54.00	-6.80	1.18 H	334	16.30	30.80
4	4914.00	39.6 PK	74.00	-34.40	1.26 H	102	2.90	36.60

ANTENNA POLARITY & TEST DISTANCE: VERTICAL AT 3 M

No.	Freq. (MHz)	Emission Level (dBuV/m)	Limit (dBuV/m)	Margin (dB)	Antenna Height (m)	Table Angle (Degree)	Raw Value (dBuV)	Correction Factor (dB/m)
1	2389.00	55.1 PK	74.00	-18.90	1.33 V	268	24.70	30.40
1	2389.00	46.8 AV	54.00	-7.20	1.33 V	268	16.30	30.40
2	*2455.00	101.5 PK			1.17 V	31	70.70	30.80
2	*2455.00	94.4 AV			1.17 V	31	63.60	30.80
3	2484.00	57.8 PK	74.00	-16.20	1.03 V	263	26.80	31.00
3	2484.00	48.4 AV	54.00	-5.60	1.03 V	263	17.40	31.00
4	4914.00	39.4 PK	74.00	-34.60	1.24 V	136	2.80	36.60

- REMARKS:**
1. Emission level(dBuV/m)=Raw Value(dBuV) + Correction Factor(dB)
 2. Correction Factor(dB/m) = Antenna Factor (dB/m) + Cable Factor (dB)
 3. The other emission levels were very low against the limit.
 4. Margin value = Emission level – Limit value.
 5. The limit value is defined as per 15.247
 6. “ * “ : Fundamental frequency



4.2.12 TEST RESULTS (C)

EUT	802.11b/g MiniPCI Module	MODEL	G11FNF
MODE	Channel 11	FREQUENCY RANGE	30-1000 MHz
INPUT POWER (SYSTEM)	120Vac, 60 Hz	DETECTOR FUNCTION	Quasi-Peak
ENVIRONMENTAL CONDITIONS	20 deg. C, 84 % RH, 979 hPa	TESTED BY	Eric Lee

ANTENNA POLARITY & TEST DISTANCE: HORIZONTAL AT 3 M

No.	Freq. (MHz)	Emission Level (dBuV/m)	Limit (dBuV/m)	Margin (dB)	Antenna Height (m)	Table Angle (Degree)	Raw Value (dBuV)	Correction Factor (dB/m)
1	125.00	20.9 QP	43.50	-22.60	1.57 H	89	8.70	12.10
2	224.02	21.6 QP	46.00	-24.40	1.26 H	310	11.70	9.90
3	256.01	38.1 QP	46.00	-7.90	1.08 H	60	24.10	14.00
4	288.01	37.1 QP	46.00	-8.90	1.11 H	105	23.30	13.80
5	352.02	28.4 QP	46.00	-17.60	1.27 H	37	12.80	15.60
6	384.01	31.1 QP	46.00	-14.90	1.11 H	16	14.60	16.50
7	416.01	32.5 QP	46.00	-13.50	1.55 H	80	14.90	17.60
8	480.01	36.4 QP	46.00	-9.60	1.32 H	36	17.50	18.90
9	511.98	32.1 QP	46.00	-13.90	1.58 H	7	12.70	19.40
10	767.96	38.2 QP	46.00	-7.80	1.00 H	14	14.50	23.70

ANTENNA POLARITY & TEST DISTANCE: VERTICAL AT 3 M

No.	Freq. (MHz)	Emission Level (dBuV/m)	Limit (dBuV/m)	Margin (dB)	Antenna Height (m)	Table Angle (Degree)	Raw Value (dBuV)	Correction Factor (dB/m)
1	125.02	25.7 QP	43.50	-17.80	1.60 V	163	13.60	12.10
2	223.99	26.9 QP	46.00	-19.10	1.00 V	162	17.00	9.90
3	256.02	35.6 QP	46.00	-10.40	1.69 V	113	21.60	14.00
4	288.00	37.1 QP	46.00	-8.90	1.00 V	320	23.30	13.80
5	384.00	38.5 QP	46.00	-7.50	1.18 V	12	22.00	16.50
6	416.01	40.0 QP	46.00	-6.00	1.56 V	123	22.30	17.60
7	448.01	32.8 QP	46.00	-13.20	1.01 V	112	14.60	18.10
8	480.00	42.1 QP	46.00	-3.90	1.00 V	34	23.20	18.90
9	544.02	37.2 QP	46.00	-8.80	1.19 V	279	16.20	21.00
10	768.00	41.7 QP	46.00	-4.30	1.22 V	137	18.00	23.70

- REMARKS:**
1. Emission level(dBuV/m)=Raw Value(dBuV) + Correction Factor(dB)
 2. Correction Factor(dB/m) = Antenna Factor (dB/m) + Cable Factor (dB)
 3. The other emission levels were very low against the limit.
 4. Margin value = Emission level – Limit value.
 5. The limit value is defined as per 15.247

4.2.13 TEST RESULTS (C) - DSSS

EUT	802.11b/g MiniPCI Module	MODEL	G11FNF
MODE	Channel 1	FREQUENCY RANGE	Above 1000 MHz
INPUT POWER (SYSTEM)	120Vac, 60 Hz	DETECTOR FUNCTION	Peak(PK) Average(AV)
ENVIRONMENTAL CONDITIONS	22 deg. C, 57%RH, 979 hPa	TESTED BY	Eric Lee

ANTENNA POLARITY & TEST DISTANCE: HORIZONTAL AT 3 M

No.	Freq. (MHz)	Emission Level (dBuV/m)	Limit (dBuV/m)	Margin (dB)	Antenna Height (m)	Table Angle (Degree)	Raw Value (dBuV)	Correction Factor (dB/m)
1	2390.00	53.8 PK	74.00	-20.20	1.13 H	357	24.60	29.20
1	2390.00	45.0 AV	54.00	-9.00	1.13 H	357	15.80	29.20
2	*2412.00	97.8 PK			1.11 H	139	67.90	29.90
2	*2412.00	90.4 AV			1.11 H	139	60.50	29.90
3	2484.00	54.9 PK	74.00	-19.10	1.39 H	243	24.80	30.10
3	2484.00	44.4 AV	54.00	-9.60	1.39 H	243	14.30	30.10
4	4824.00	37.7 PK	74.00	-36.30	1.01 H	345	2.10	35.60

ANTENNA POLARITY & TEST DISTANCE: VERTICAL AT 3 M

No.	Freq. (MHz)	Emission Level (dBuV/m)	Limit (dBuV/m)	Margin (dB)	Antenna Height (m)	Table Angle (Degree)	Raw Value (dBuV)	Correction Factor (dB/m)
1	2390.00	58.9 PK	74.00	-15.10	1.29 V	200	29.70	29.20
1	2390.00	49.2 AV	54.00	-4.80	1.29 V	200	19.90	29.20
2	*2412.00	107.7 PK			1.07 V	132	77.80	29.90
2	*2412.00	100.2 AV			1.07 V	132	70.30	29.90
3	2484.00	56.3 PK	74.00	-17.70	1.32 V	303	26.20	30.10
3	2484.00	47.0 AV	54.00	-7.00	1.32 V	303	16.90	30.10
4	4824.00	38.5 PK	74.00	-35.50	1.58 V	69	2.90	35.60

- REMARKS:**
1. Emission level(dBuV/m)=Raw Value(dBuV) + Correction Factor(dB)
 2. Correction Factor(dB/m) = Antenna Factor (dB/m) + Cable Factor (dB)
 3. The other emission levels were very low against the limit.
 4. Margin value = Emission level – Limit value.
 5. The limit value is defined as per 15.247
 6. " * " : Fundamental frequency



EUT	802.11b/g MiniPCI Module	MODEL	G11FNF
MODE	Channel 6	FREQUENCY RANGE	Above 1000 MHz
INPUT POWER (SYSTEM)	120Vac, 60 Hz	DETECTOR FUNCTION	Peak(PK) Average (AV)
ENVIRONMENTAL CONDITIONS	22 deg. C, 57%RH, 979 hPa	TESTED BY	Eric Lee

ANTENNA POLARITY & TEST DISTANCE: HORIZONTAL AT 3 M

No.	Freq. (MHz)	Emission Level (dBuV/m)	Limit (dBuV/m)	Margin (dB)	Antenna Height (m)	Table Angle (Degree)	Raw Value (dBuV)	Correction Factor (dB/m)
1	2390.00	53.6 PK	74.00	-20.40	1.24 H	25	24.40	29.20
1	2390.00	43.9 AV	54.00	-10.10	1.24 H	25	14.60	29.20
2	*2437.00	97.2 PK			1.12 H	140	67.20	30.00
2	*2437.00	89.7 AV			1.12 H	140	59.70	30.00
3	2484.00	55.1 PK	74.00	-18.90	1.58 H	3	25.00	30.10
3	2484.00	45.1 AV	54.00	-8.90	1.58 H	3	15.00	30.10
4	4874.00	37.8 PK	74.00	-36.20	1.02 H	69	2.10	35.70

ANTENNA POLARITY & TEST DISTANCE: VERTICAL AT 3 M

No.	Freq. (MHz)	Emission Level (dBuV/m)	Limit (dBuV/m)	Margin (dB)	Antenna Height (m)	Table Angle (Degree)	Raw Value (dBuV)	Correction Factor (dB/m)
1	2390.00	55.0 PK	74.00	-19.00	1.31 V	321	25.80	29.20
1	2390.00	45.1 AV	54.00	-8.90	1.31 V	321	15.80	29.20
2	*2437.00	108.6 PK			1.30 V	28	78.60	30.00
2	*2437.00	101.5 AV			1.30 V	28	71.50	30.00
3	2484.00	56.2 PK	74.00	-17.80	1.64 V	148	26.10	30.10
3	2484.00	46.1 AV	54.00	-7.90	1.64 V	148	15.90	30.10
4	4874.00	38.6 PK	74.00	-35.40	1.47 V	254	2.90	35.70

- REMARKS:**
1. Emission level(dBuV/m)=Raw Value(dBuV) + Correction Factor(dB)
 2. Correction Factor(dB/m) = Antenna Factor (dB/m) + Cable Factor (dB)
 3. The other emission levels were very low against the limit.
 4. Margin value = Emission level – Limit value.
 5. The limit value is defined as per 15.247
 6. “ * “ : Fundamental frequency



EUT	802.11b/g MiniPCI Module	MODEL	G11FNF
MODE	Channel 11	FREQUENCY RANGE	Above 1000 MHz
INPUT POWER (SYSTEM)	120Vac, 60 Hz	DETECTOR FUNCTION	Peak(PK) Average (AV)
ENVIRONMENTAL CONDITIONS	22 deg. C, 57%RH, 979 hPa	TESTED BY	Eric Lee

ANTENNA POLARITY & TEST DISTANCE: HORIZONTAL AT 3 M

No.	Freq. (MHz)	Emission Level (dBuV/m)	Limit (dBuV/m)	Margin (dB)	Antenna Height (m)	Table Angle (Degree)	Raw Value (dBuV)	Correction Factor (dB/m)
1	2390.00	56.0 PK	74.00	-18.00	1.44 H	309	26.70	29.20
1	2390.00	43.5 AV	54.00	-10.50	1.44 H	309	14.20	29.20
2	*2462.00	93.9 PK			1.12 H	134	63.80	30.10
2	*2462.00	88.2 AV			1.12 H	134	58.10	30.10
3	2484.00	55.7 PK	74.00	-18.30	1.15 H	2	25.60	30.10
3	2484.00	46.5 AV	54.00	-7.50	1.15 H	2	16.40	30.10
4	4924.00	37.8 PK	74.00	-36.20	1.53 H	147	1.90	35.90

ANTENNA POLARITY & TEST DISTANCE: VERTICAL AT 3 M

No.	Freq. (MHz)	Emission Level (dBuV/m)	Limit (dBuV/m)	Margin (dB)	Antenna Height (m)	Table Angle (Degree)	Raw Value (dBuV)	Correction Factor (dB/m)
1	2390.00	56.2 PK	74.00	-17.80	1.24 V	348	26.90	29.20
1	2390.00	46.0 AV	54.00	-8.00	1.24 V	348	16.70	29.20
2	*2462.00	107.7 PK			1.29 V	208	77.60	30.10
2	*2462.00	100.6 AV			1.29 V	208	70.50	30.10
3	2484.00	60.9 PK	74.00	-13.10	1.05 V	234	30.80	30.10
3	2484.00	51.7 AV	54.00	-2.30	1.05 V	234	21.60	30.10
4	4924.00	38.2 PK	74.00	-35.80	1.34 V	21	2.30	35.90

- REMARKS:**
1. Emission level(dBuV/m)=Raw Value(dBuV) + Correction Factor(dB)
 2. Correction Factor(dB/m) = Antenna Factor (dB/m) + Cable Factor (dB)
 3. The other emission levels were very low against the limit.
 4. Margin value = Emission level – Limit value.
 5. The limit value is defined as per 15.247
 6. “ * “ : Fundamental frequency



4.2.14 TEST RESULTS (C) -OFDM

EUT	802.11b/g MiniPCI Module	MODEL	G11FNF
MODE	Channel 1	FREQUENCY RANGE	Above 1000 MHz
INPUT POWER (SYSTEM)	120Vac, 60 Hz	DETECTOR FUNCTION	Peak(PK) Average(AV)
ENVIRONMENTAL CONDITIONS	22 deg. C, 57%RH, 979 hPa	TESTED BY	Eric Lee

ANTENNA POLARITY & TEST DISTANCE: HORIZONTAL AT 3 M

No.	Freq. (MHz)	Emission Level (dBuV/m)	Limit (dBuV/m)	Margin (dB)	Antenna Height (m)	Table Angle (Degree)	Raw Value (dBuV)	Correction Factor (dB/m)
1	2390.00	57.6 PK	74.00	-16.40	1.11 H	247	28.40	29.20
1	2390.00	45.3 AV	54.00	-8.70	1.11 H	247	16.10	29.20
2	*2412.00	93.9 PK			1.11 H	157	64.00	29.90
2	*2412.00	83.2 AV			1.11 H	157	53.40	29.90
3	2484.00	56.5 PK	74.00	-17.50	1.21 H	265	26.30	30.10
3	2484.00	45.2 AV	54.00	-8.80	1.21 H	265	15.10	30.10
4	4824.00	36.9 PK	74.00	-37.10	1.09 H	295	1.30	35.60

ANTENNA POLARITY & TEST DISTANCE: VERTICAL AT 3 M

No.	Freq. (MHz)	Emission Level (dBuV/m)	Limit (dBuV/m)	Margin (dB)	Antenna Height (m)	Table Angle (Degree)	Raw Value (dBuV)	Correction Factor (dB/m)
1	2390.00	63.2 PK	74.00	-10.80	1.09 V	130	34.00	29.20
1	2390.00	49.9 AV	54.00	-4.10	1.09 V	130	20.60	29.20
2	*2412.00	102.3 PK			1.11 V	265	72.40	29.90
2	*2412.00	93.2 AV			1.11 V	265	63.30	29.90
3	2484.00	59.1 PK	74.00	-14.90	1.23 V	68	28.90	30.10
3	2484.00	47.0 AV	54.00	-7.00	1.23 V	68	16.80	30.10
4	4824.00	37.4 PK	74.00	-36.60	1.08 V	351	1.80	35.60

- REMARKS:**
1. Emission level(dBuV/m)=Raw Value(dBuV) + Correction Factor(dB)
 2. Correction Factor(dB/m) = Antenna Factor (dB/m) + Cable Factor (dB)
 3. The other emission levels were very low against the limit.
 4. Margin value = Emission level – Limit value.
 5. The limit value is defined as per 15.247
 6. “ * “ : Fundamental frequency



EUT	802.11b/g MiniPCI Module	MODEL	G11FNF
MODE	Channel 6	FREQUENCY RANGE	Above 1000 MHz
INPUT POWER (SYSTEM)	120Vac, 60 Hz	DETECTOR FUNCTION	Peak(PK) Average (AV)
ENVIRONMENTAL CONDITIONS	22 deg. C, 57%RH, 979 hPa	TESTED BY	Eric Lee

ANTENNA POLARITY & TEST DISTANCE: HORIZONTAL AT 3 M

No.	Freq. (MHz)	Emission Level (dBuV/m)	Limit (dBuV/m)	Margin (dB)	Antenna Height (m)	Table Angle (Degree)	Raw Value (dBuV)	Correction Factor (dB/m)
1	2390.00	54.5 PK	74.00	-19.50	1.58 H	343	25.20	29.20
1	2390.00	44.5 AV	54.00	-9.50	1.58 H	343	15.20	29.20
2	*2437.00	94.4 PK			1.12 H	250	64.40	30.00
2	*2437.00	84.9 AV			1.12 H	250	54.90	30.00
3	2484.00	56.0 PK	74.00	-18.00	1.06 H	62	25.90	30.10
3	2484.00	44.4 AV	54.00	-9.60	1.06 H	62	14.30	30.10
4	4874.00	36.9 PK	74.00	-37.10	1.66 H	353	1.20	35.70

ANTENNA POLARITY & TEST DISTANCE: VERTICAL AT 3 M

No.	Freq. (MHz)	Emission Level (dBuV/m)	Limit (dBuV/m)	Margin (dB)	Antenna Height (m)	Table Angle (Degree)	Raw Value (dBuV)	Correction Factor (dB/m)
1	2390.00	56.6 PK	74.00	-17.40	1.54 V	293	27.40	29.20
1	2390.00	45.8 AV	54.00	-8.20	1.54 V	293	16.60	29.20
2	*2437.00	103.6 PK			1.05 V	110	73.60	30.00
2	*2437.00	94.3 AV			1.05 V	110	64.30	30.00
3	2484.00	57.1 PK	74.00	-16.90	1.00 V	1	26.90	30.10
3	2484.00	46.7 AV	54.00	-7.30	1.00 V	1	16.60	30.10
4	4874.00	38.6 PK	74.00	-35.40	1.20 V	12	2.90	35.70

- REMARKS:**
1. Emission level(dBuV/m)=Raw Value(dBuV) + Correction Factor(dB)
 2. Correction Factor(dB/m) = Antenna Factor (dB/m) + Cable Factor (dB)
 3. The other emission levels were very low against the limit.
 4. Margin value = Emission level – Limit value.
 5. The limit value is defined as per 15.247
 6. “ * “ : Fundamental frequency



EUT	802.11b/g MiniPCI Module	MODEL	G11FNF
MODE	Channel 11	FREQUENCY RANGE	Above 1000 MHz
INPUT POWER (SYSTEM)	120Vac, 60 Hz	DETECTOR FUNCTION	Peak(PK) Average (AV)
ENVIRONMENTAL CONDITIONS	22 deg. C, 57%RH, 979 hPa	TESTED BY	Eric Lee

ANTENNA POLARITY & TEST DISTANCE: HORIZONTAL AT 3 M

No.	Freq. (MHz)	Emission Level (dBuV/m)	Limit (dBuV/m)	Margin (dB)	Antenna Height (m)	Table Angle (Degree)	Raw Value (dBuV)	Correction Factor (dB/m)
1	2390.00	51.1 PK	74.00	-22.90	1.04 H	6	21.90	29.20
1	2390.00	44.1 AV	54.00	-9.90	1.04 H	6	14.90	29.20
2	*2462.00	93.1 PK			1.08 H	22	63.10	30.10
2	*2462.00	84.8 AV			1.08 H	22	54.70	30.10
3	2484.00	54.9 PK	74.00	-19.10	1.11 H	239	24.70	30.10
3	2484.00	46.1 AV	54.00	-7.90	1.11 H	239	16.00	30.10
4	4924.00	37.1 PK	74.00	-36.90	1.36 H	254	1.20	35.90

ANTENNA POLARITY & TEST DISTANCE: VERTICAL AT 3 M

No.	Freq. (MHz)	Emission Level (dBuV/m)	Limit (dBuV/m)	Margin (dB)	Antenna Height (m)	Table Angle (Degree)	Raw Value (dBuV)	Correction Factor (dB/m)
1	2390.00	58.9 PK	74.00	-15.10	1.63 V	347	29.60	29.20
1	2390.00	46.3 AV	54.00	-7.70	1.63 V	347	17.00	29.20
2	*2462.00	103.7 PK			1.03 V	111	73.60	30.10
2	*2462.00	95.7 AV			1.03 V	111	65.70	30.10
3	2484.00	64.8 PK	74.00	-9.20	1.35 V	121	34.70	30.10
3	2484.00	51.6 AV	54.00	-2.40	1.35 V	121	21.50	30.10
4	4924.00	38.3 PK	74.00	-35.70	1.14 V	73	2.40	35.90

- REMARKS:**
1. Emission level(dBuV/m)=Raw Value(dBuV) + Correction Factor(dB)
 2. Correction Factor(dB/m) = Antenna Factor (dB/m) + Cable Factor (dB)
 3. The other emission levels were very low against the limit.
 4. Margin value = Emission level – Limit value.
 5. The limit value is defined as per 15.247
 6. “ * “ : Fundamental frequency



4.3 6dB BANDWIDTH MEASUREMENT

4.3.1 LIMITS OF 6dB BANDWIDTH MEASUREMENT

The minimum of 6dB Bandwidth Measurement is 0.5 MHz.

4.3.2 TEST INSTRUMENTS

Description & Manufacturer	Model No.	Serial No.	Calibrated Until
R&S SPECTRUM ANALYZER	FSP	1093.4495.30	Dec. 19, 2003

NOTE:

- 1.The measurement uncertainty is less than +/- 2.6dB, which is calculated as per the NAMAS document NIS81.
- 2.The calibration interval of the above test instruments is 12 months and the calibrations are traceable to NML/ROC and NIST/USA.

4.3.3 TEST PROCEDURE

The transmitter output was connected to the spectrum analyzer through an attenuator. The bandwidth of the fundamental frequency was measured by spectrum analyzer with 100 kHz RBW and 100 kHz VBW. The 6 dB bandwidth is defined as the total spectrum the power of which is higher than peak power minus 6 dB.

4.3.4 TEST SETUP



For the actual test configuration, please refer to the related Item – Photographs of the Test Configuration.

4.3.5 EUT OPERATING CONDITIONS

The software provided by client to enable the EUT under transmission condition continuously at lowest, middle and highest channel frequencies individually.



4.3.6 TEST RESULTS-DSSS

EUT	802.11b/g MiniPCI Module	MODEL	G11FNF
INPUT POWER (SYSTEM)	120Vac, 60 Hz	ENVIRONMENTAL CONDITIONS	26 deg. C, 59 %RH, 979 hPa
TEST MODE	Antenna 1 & 3	TESTED BY	Hunk Chung

CHANNEL	CHANNEL FREQUENCY (MHz)	6 dB BANDWIDTH (MHz)	MINIMUM LIMIT (MHz)	PASS/FAIL
1	2412	12.04	0.5	PASS
6	2437	12.04	0.5	PASS
11	2462	11.84	0.5	PASS



CH1

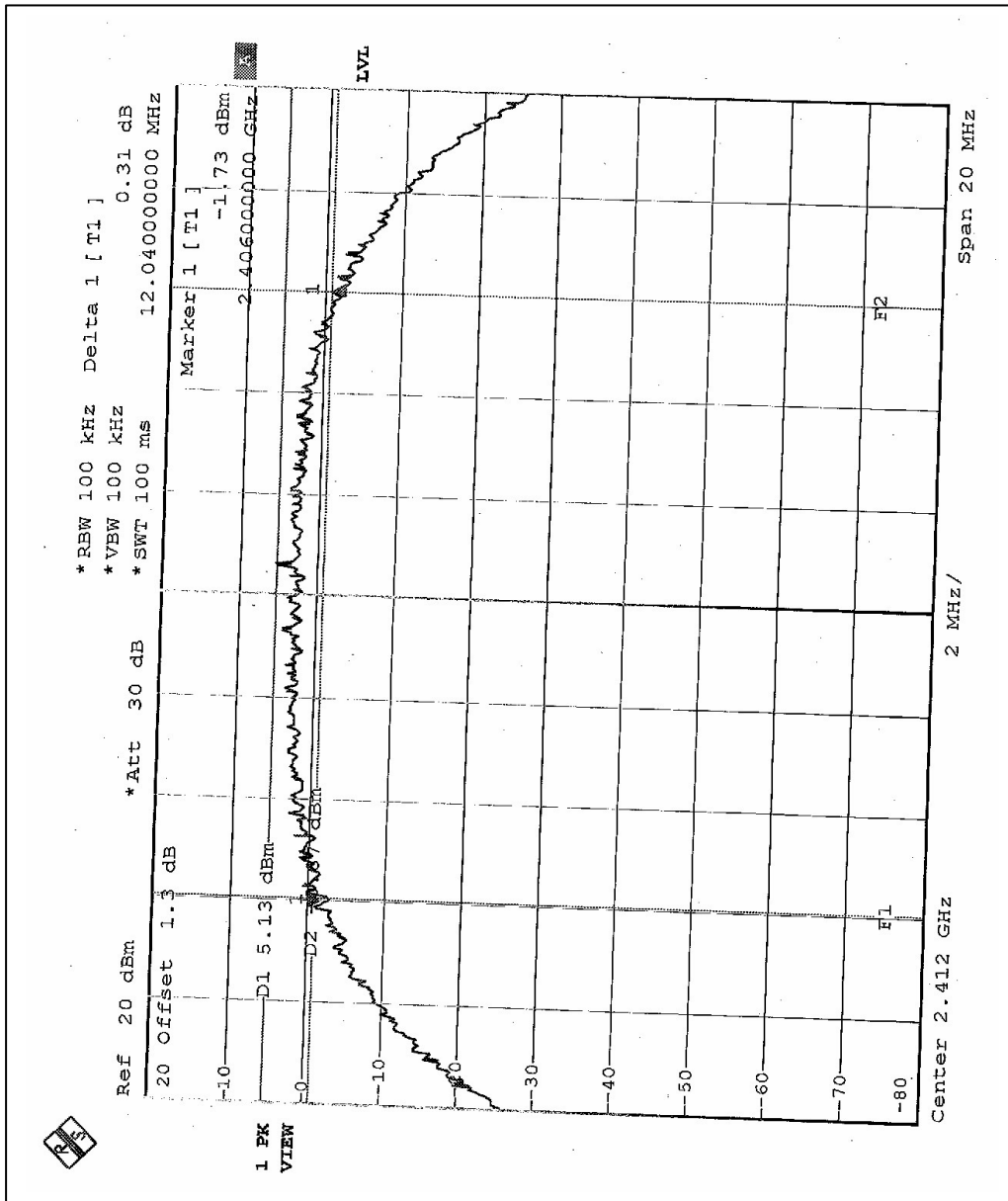



CH6

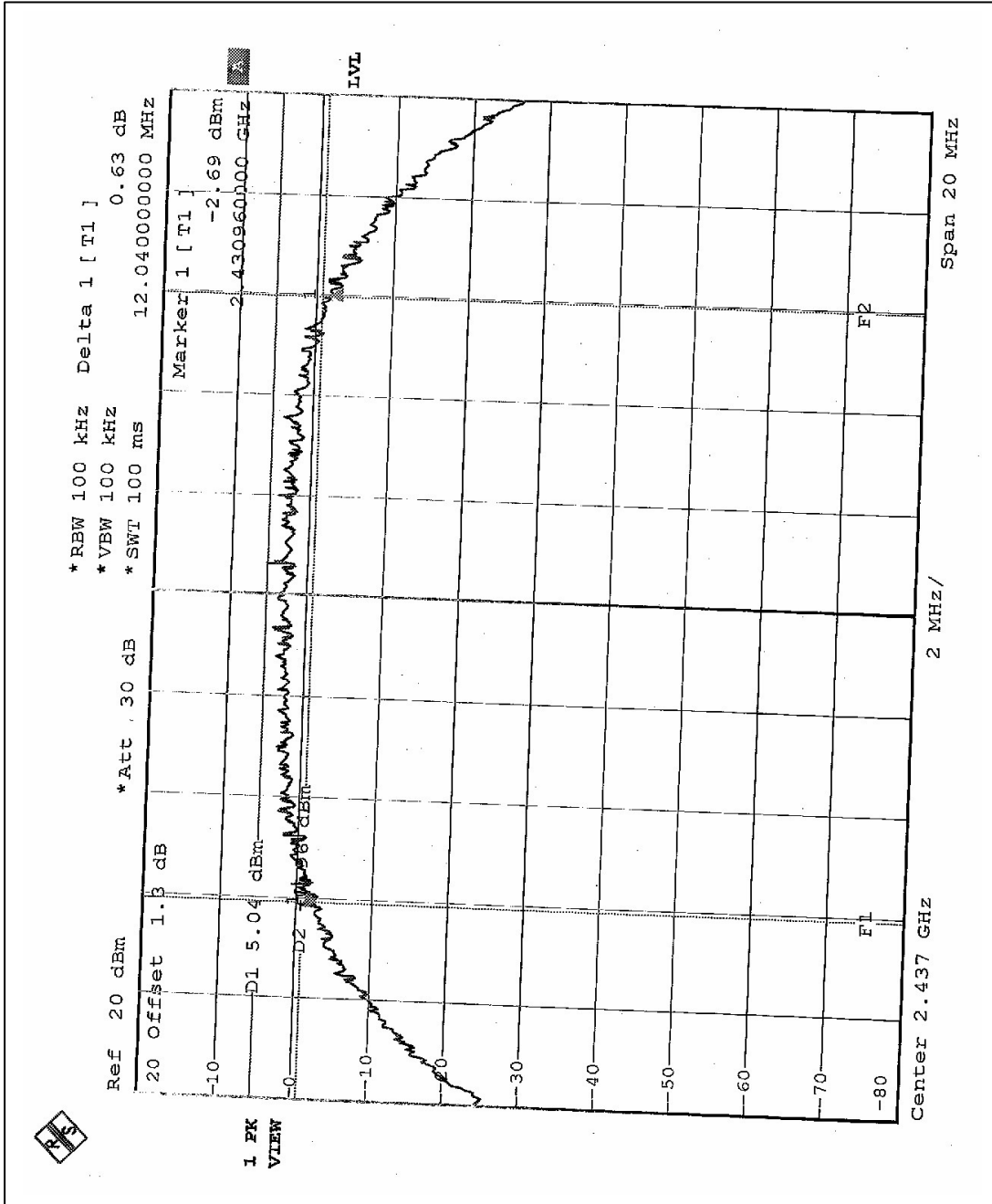



CH11

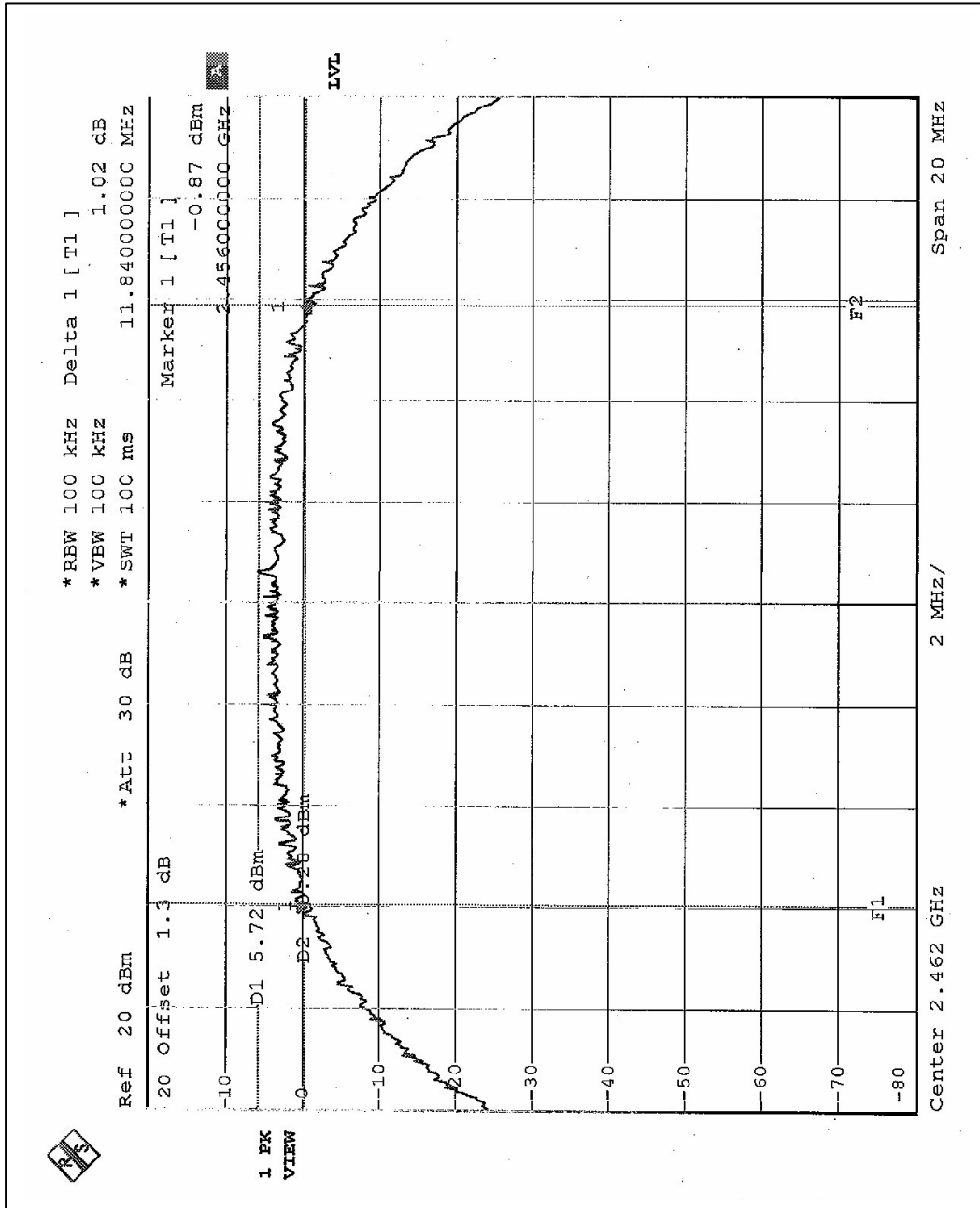



EUT	802.11b/g MiniPCI Module	MODEL	G11FNF
INPUT POWER (SYSTEM)	120Vac, 60 Hz	ENVIRONMENTAL CONDITIONS	26 deg. C, 59 %RH, 979 hPa
TEST MODE	Antenna 2	TESTED BY	Hunk Chung

CHANNEL	CHANNEL FREQUENCY (MHz)	6 dB BANDWIDTH (MHz)	MINIMUM LIMIT (MHz)	PASS/FAIL
2	2417	12.36	0.5	PASS
6	2437	12.04	0.5	PASS
10	2457	11.76	0.5	PASS



CH2

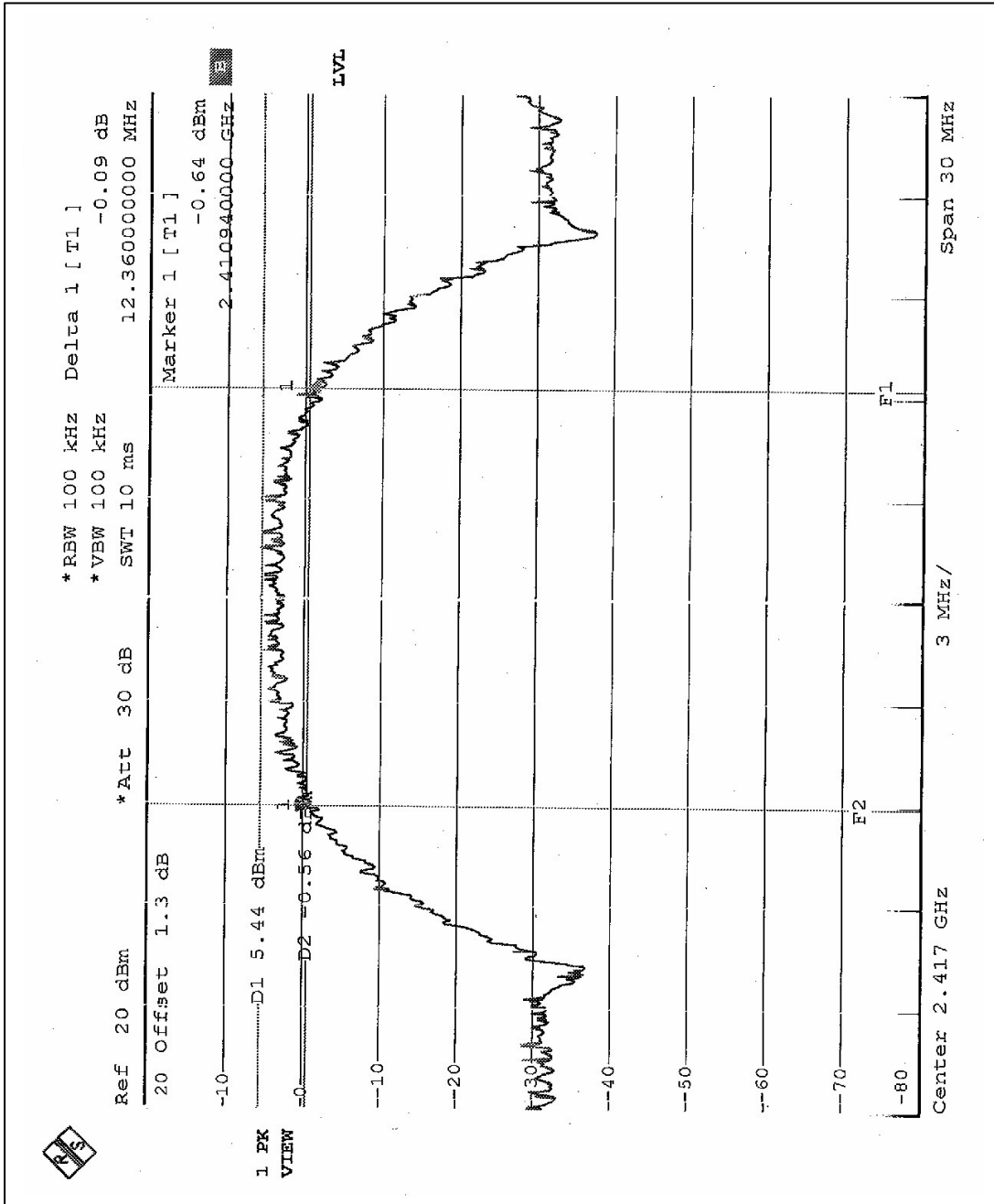



CH6

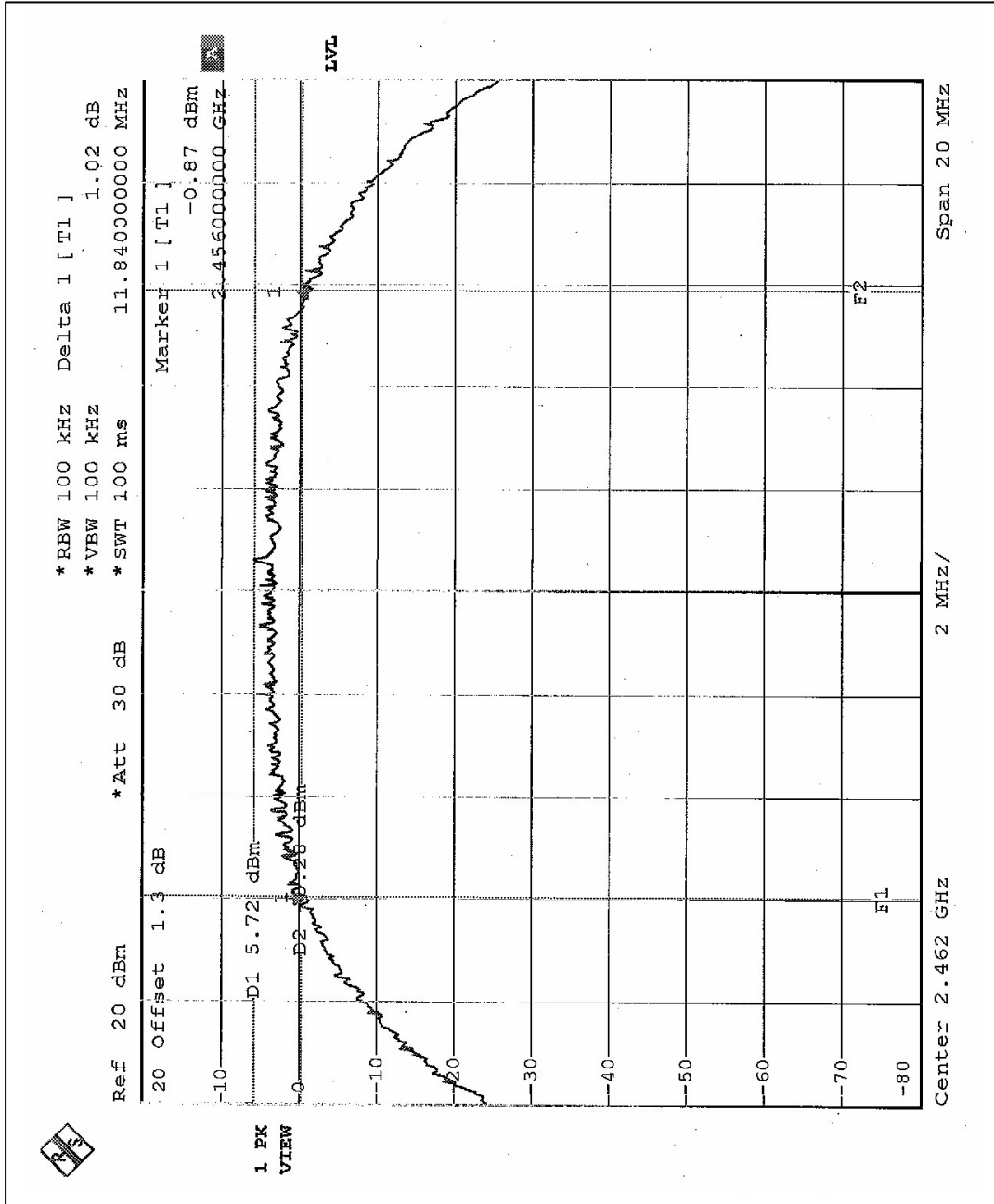



CH10

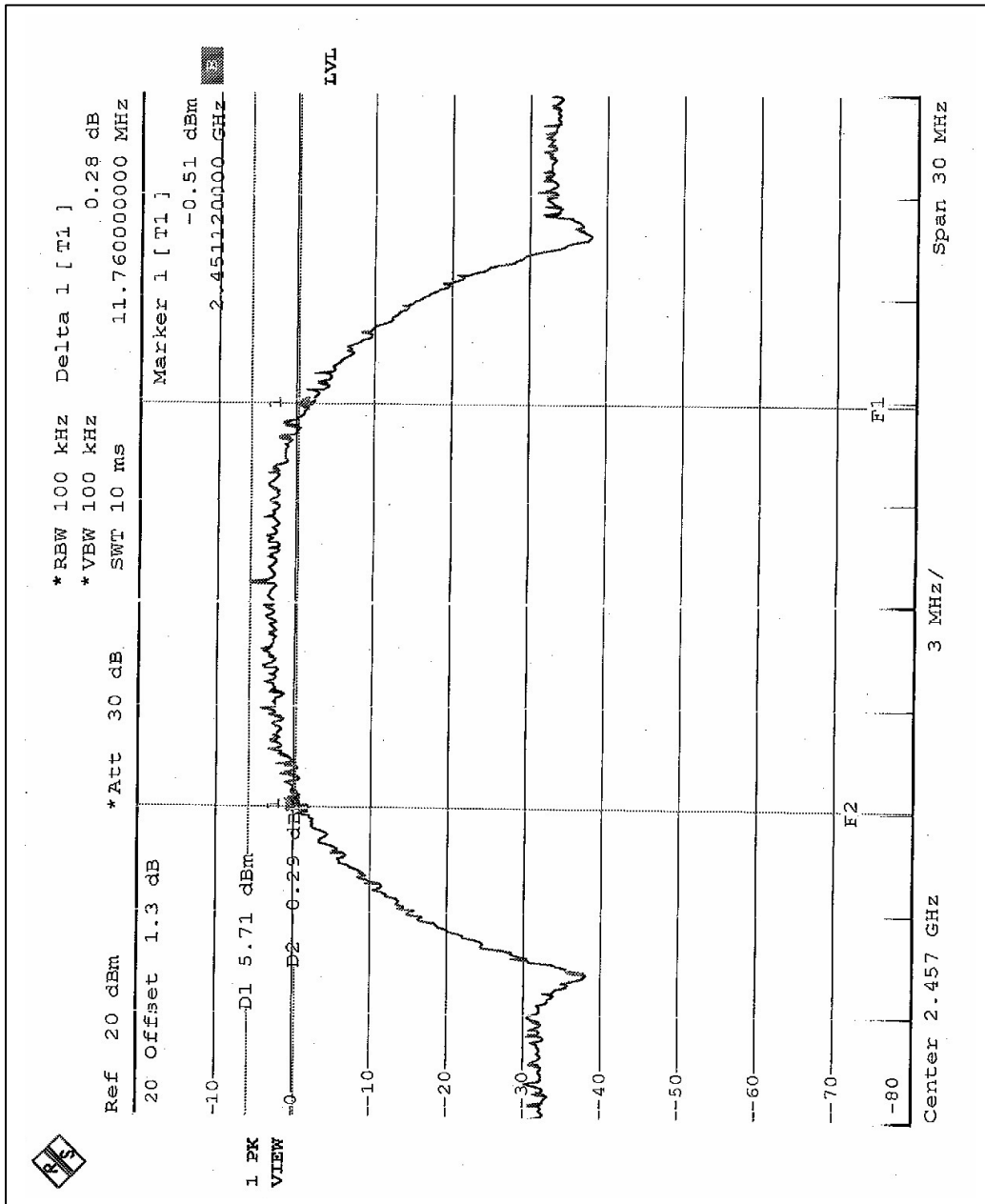



4.3.7 TEST RESULTS-OFDM

EUT	802.11b/g MiniPCI Module	MODEL	G11FNF
INPUT POWER (SYSTEM)	120Vac, 60 Hz	ENVIRONMENTAL CONDITIONS	26 deg. C, 59 %RH, 979 hPa
TEST MODE	Antenna 1&3	TESTED BY	Hunk Chung

CHANNEL	CHANNEL FREQUENCY (MHz)	6 dB BANDWIDTH (MHz)	MINIMUM LIMIT (MHz)	PASS/FAIL
1	2412	16.62	0.5	PASS
6	2437	16.56	0.5	PASS
11	2462	16.62	0.5	PASS



CH1

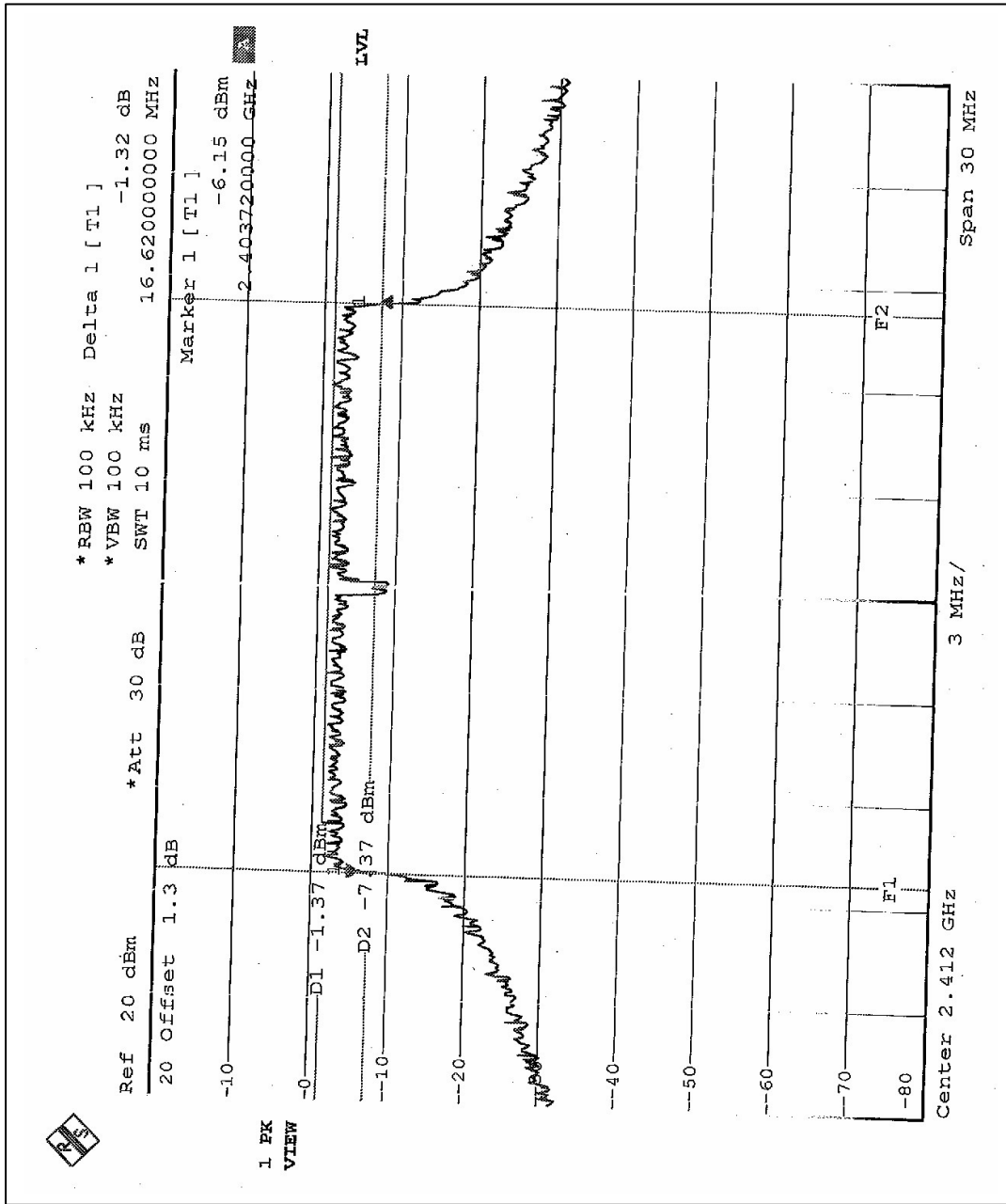



CH6

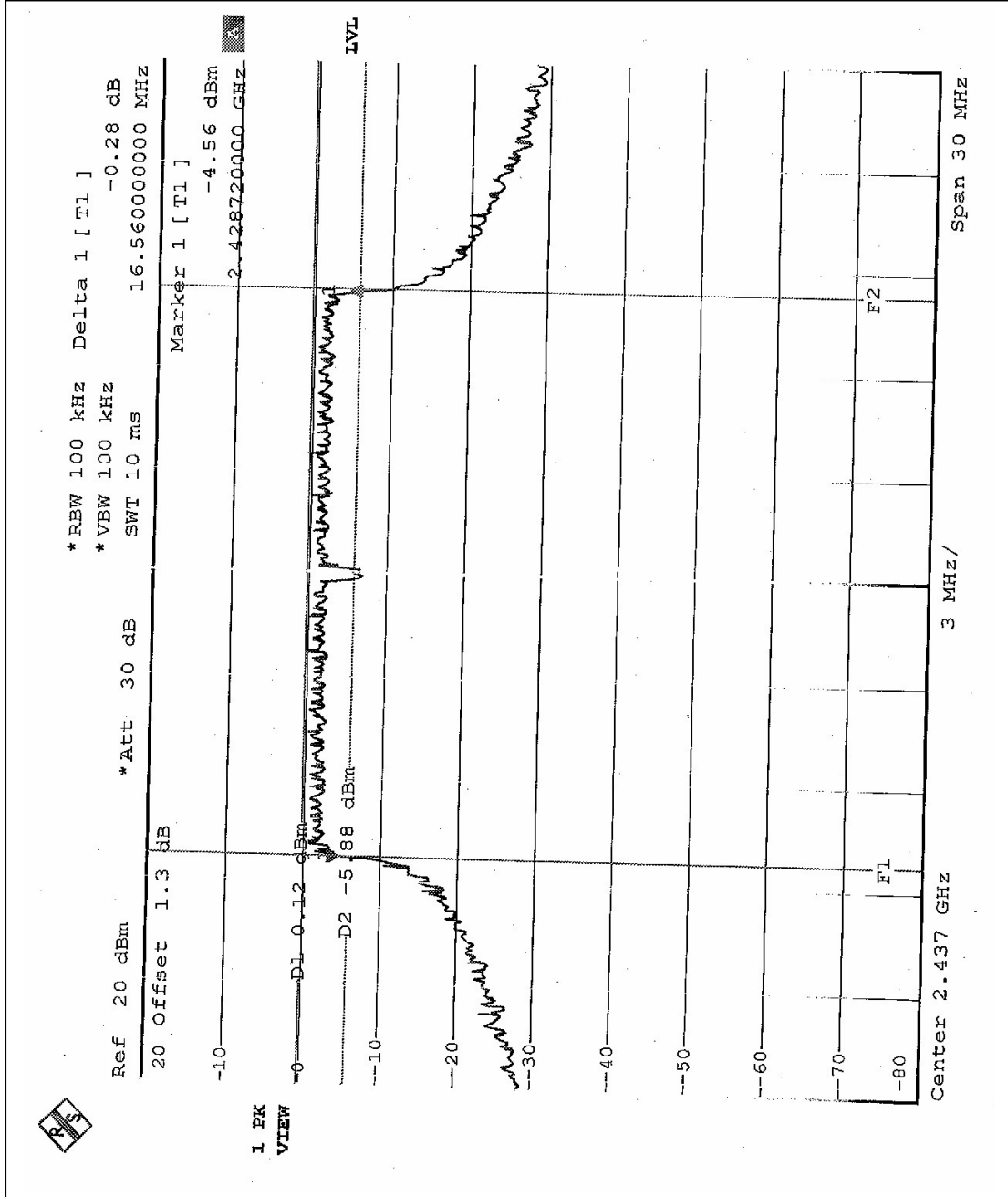



CH11

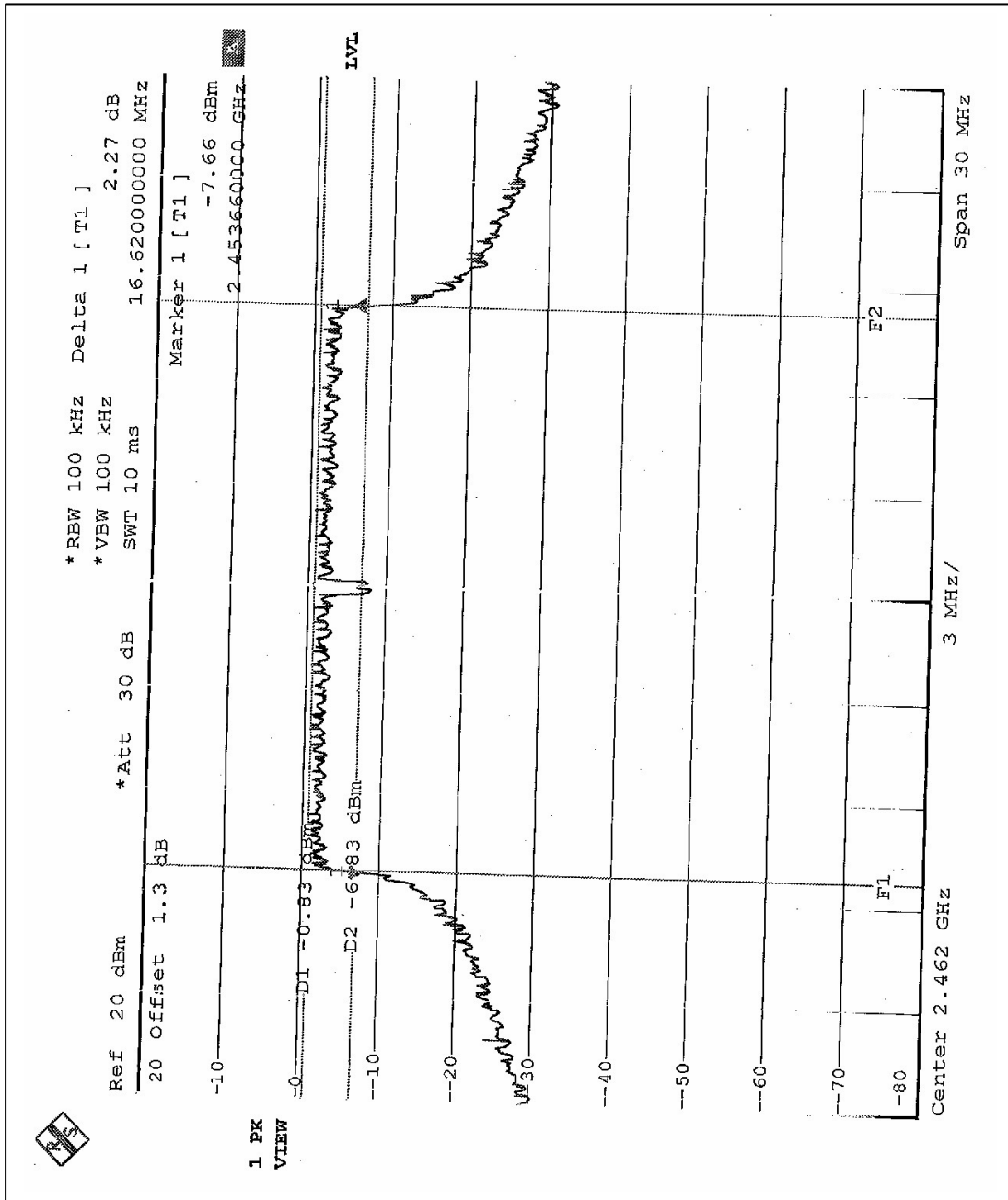



EUT	802.11b/g MiniPCI Module	MODEL	G11FNF
INPUT POWER (SYSTEM)	120Vac, 60 Hz	ENVIRONMENTAL CONDITIONS	26 deg. C, 59 %RH, 979 hPa
TEST MODE	Antenna 1&3	TESTED BY	Hunk Chung

CHANNEL	CHANNEL FREQUENCY (MHz)	6 dB BANDWIDTH (MHz)	MINIMUM LIMIT (MHz)	PASS/FAIL
2	2417	16.50	0.5	PASS
6	2437	16.56	0.5	PASS
10	2457	16.56	0.5	PASS



CH2

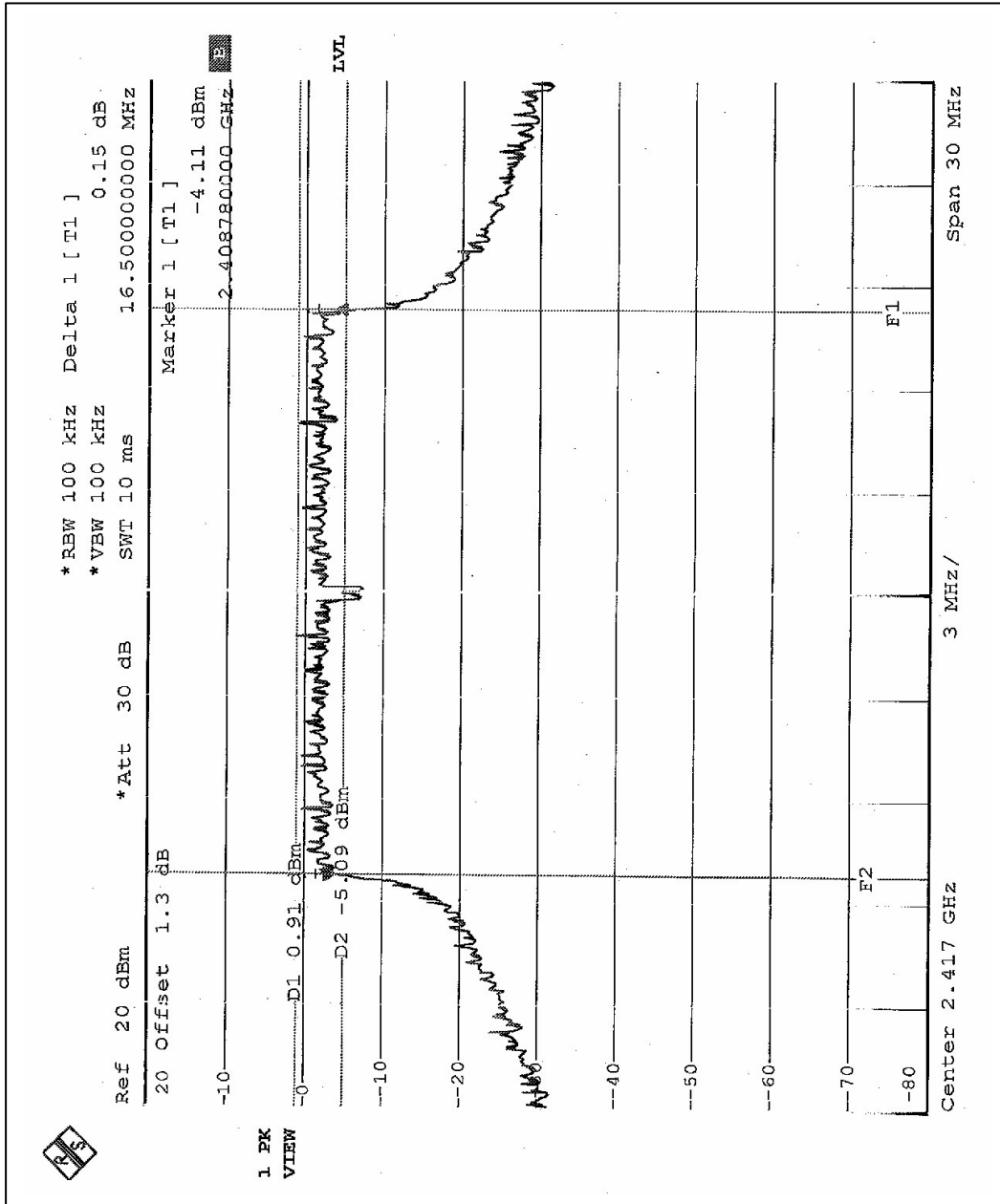



CH6

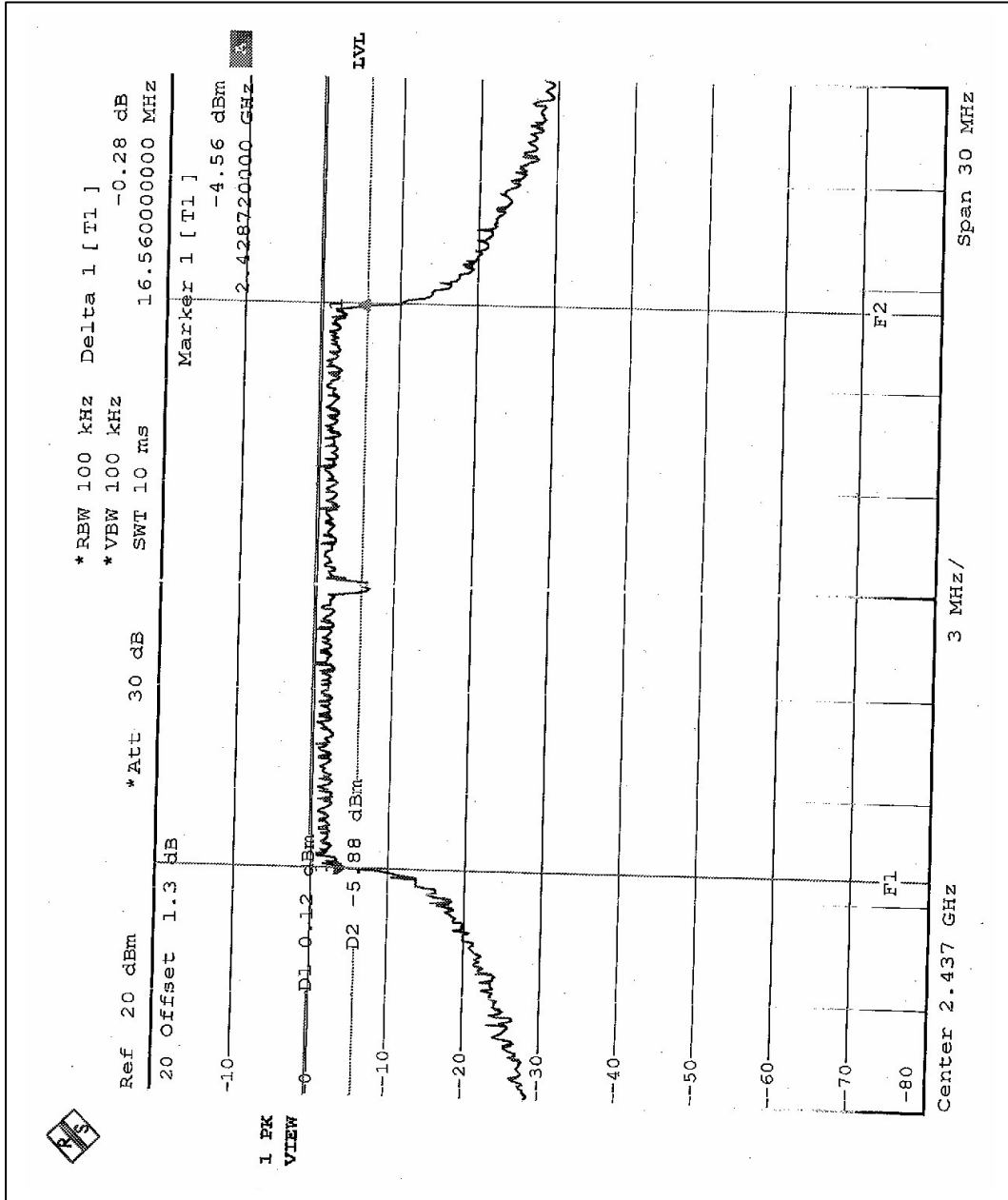



CH10

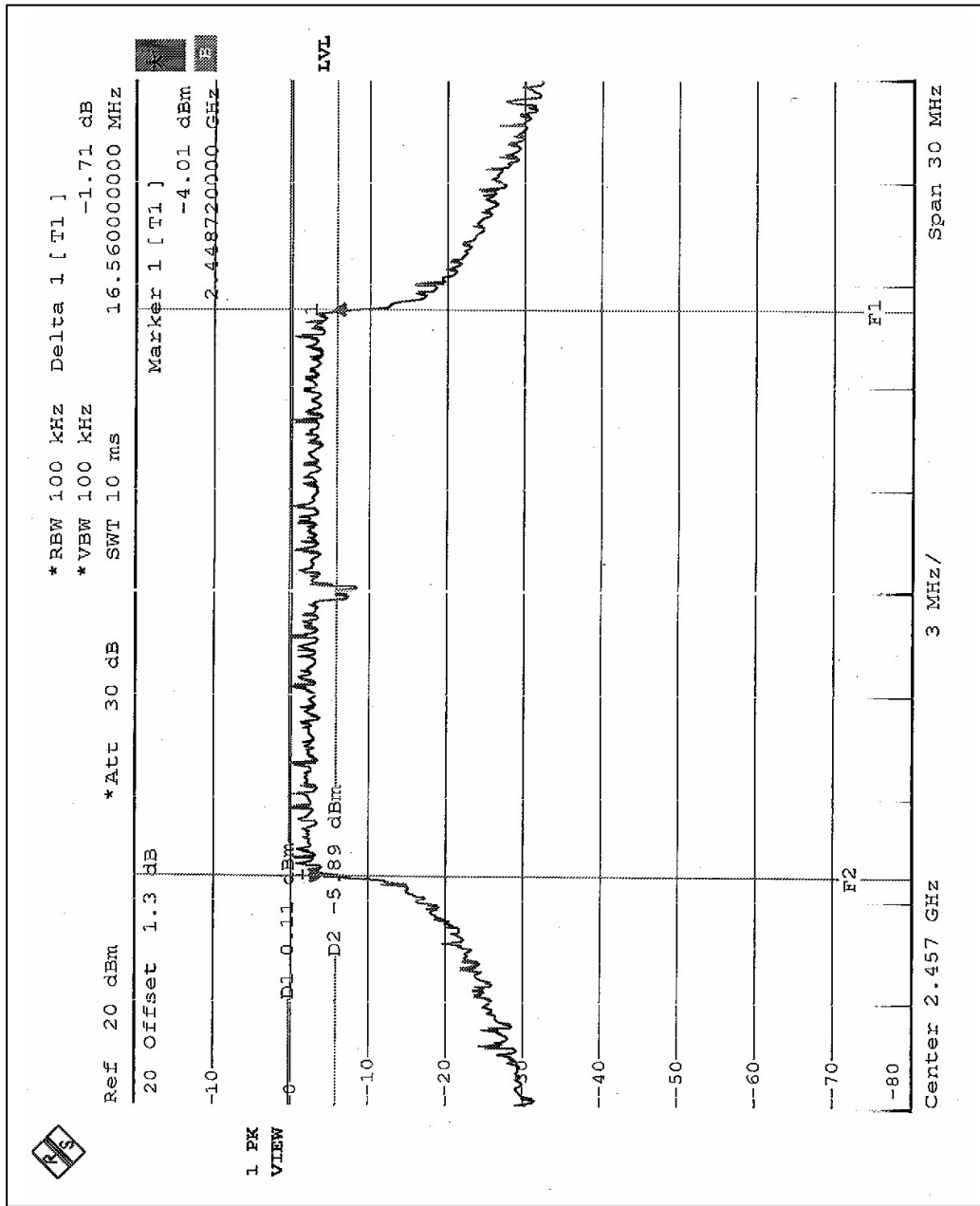



4.4 MAXIMUM PEAK OUTPUT POWER

4.4.1 LIMITS OF MAXIMUM PEAK OUTPUT POWER MEASUREMENT

The Maximum Peak Output Power Measurement is 30dBm.

4.4.2 TEST INSTRUMENTS

Description & Manufacturer	Model No.	Serial No.	Calibrated Until
POWER METER	E4416A	GB41291118	July 30, 2003
PEAK POWER SENSOR	E9327A	US40440722	July 30, 2003

NOTE:

1. The measurement uncertainty is less than +/- 2.6dB, which is calculated as per the NAMAS document NIS81.
2. The calibration interval of the above test instruments is 12 months and the calibrations are traceable to NML/ROC and NIST/USA.

4.4.3 TEST PROCEDURES

The transmitter output was connected to the peak power meter.

4.4.4 TEST SETUP

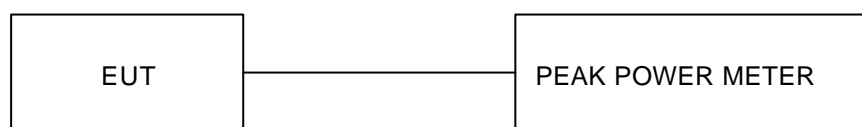

4.4.5 EUT OPERATING CONDITIONS

Same as Item 4.3.5



4.4.6 TEST RESULTS(A)-DSSS

EUT	802.11b/g MiniPCI Module	MODEL	G11FNF
INPUT POWER (SYSTEM)	120Vac, 60 Hz	ENVIRONMENTAL CONDITIONS	26 deg. C, 59 %RH, 979 hPa
TEST MODE	Antenna 1	TESTED BY	Hank Chung

CHANNEL	CHANNEL FREQUENCY (MHz)	PEAK POWER OUTPUT (dBm)	PEAK POWER LIMIT (dBm)	PASS/FAIL
1	2412	15.35	30	PASS
6	2437	15.23	30	PASS
11	2462	15.14	30	PASS

4.4.7 TEST RESULTS(A)-OFDM

EUT	802.11b/g MiniPCI Module	MODEL	G11FNF
INPUT POWER (SYSTEM)	120Vac, 60 Hz	ENVIRONMENTAL CONDITIONS	26 deg. C, 59 %RH, 979 hPa
TEST MODE	Antenna 1	TESTED BY	Hank Chung

CHANNEL	CHANNEL FREQUENCY (MHz)	PEAK POWER OUTPUT (dBm)	PEAK POWER LIMIT (dBm)	PASS/FAIL
1	2412	15.71	30	PASS
6	2437	15.40	30	PASS
11	2462	15.15	30	PASS



4.4.8 TEST RESULTS(B)-DSSS

EUT	802.11b/g MiniPCI Module	MODEL	G11FNF
INPUT POWER (SYSTEM)	120Vac, 60 Hz	ENVIRONMENTAL CONDITIONS	26 deg. C, 59 %RH, 979 hPa
TEST MODE	Antenna 2	TESTED BY	Hank Chung

CHANNEL	CHANNEL FREQUENCY (MHz)	PEAK POWER OUTPUT (dBm)	PEAK POWER LIMIT (dBm)	PASS/FAIL
2	2417	15.92	30	PASS
6	2437	15.23	30	PASS
10	2457	15.48	30	PASS

4.4.9 TEST RESULTS(B)-OFDM

EUT	802.11b/g MiniPCI Module	MODEL	G11FNF
INPUT POWER (SYSTEM)	120Vac, 60 Hz	ENVIRONMENTAL CONDITIONS	26 deg. C, 59 %RH, 979 hPa
TEST MODE	Antenna 2	TESTED BY	Hank Chung

CHANNEL	CHANNEL FREQUENCY (MHz)	PEAK POWER OUTPUT (dBm)	PEAK POWER LIMIT (dBm)	PASS/FAIL
2	2417	15.89	30	PASS
6	2437	15.40	30	PASS
10	2457	15.93	30	PASS



4.4.10 TEST RESULTS(C)-DSSS

EUT	802.11b/g MiniPCI Module	MODEL	G11FNF
INPUT POWER (SYSTEM)	120Vac, 60 Hz	ENVIRONMENTAL CONDITIONS	26 deg. C, 59 %RH, 979 hPa
TEST MODE	Antenna 3	TESTED BY	Hank Chung

CHANNEL	CHANNEL FREQUENCY (MHz)	PEAK POWER OUTPUT (dBm)	PEAK POWER LIMIT (dBm)	PASS/FAIL
1	2412	15.35	30	PASS
6	2437	15.23	30	PASS
11	2462	15.14	30	PASS

4.4.11 TEST RESULTS(C)-OFDM

EUT	802.11b/g MiniPCI Module	MODEL	G11FNF
INPUT POWER (SYSTEM)	120Vac, 60 Hz	ENVIRONMENTAL CONDITIONS	26 deg. C, 59 %RH, 979 hPa
TEST MODE	Antenna 3	TESTED BY	Hank Chung

CHANNEL	CHANNEL FREQUENCY (MHz)	PEAK POWER OUTPUT (dBm)	PEAK POWER LIMIT (dBm)	PASS/FAIL
1	2412	15.71	30	PASS
6	2437	15.40	30	PASS
11	2462	15.15	30	PASS



4.5 POWER SPECTRAL DENSITY MEASUREMENT

4.5.1 LIMITS OF POWER SPECTRAL DENSITY MEASUREMENT

The Maximum of Power Spectral Density Measurement is 8dBm.

4.5.2 TEST INSTRUMENTS

Description & Manufacturer	Model No.	Serial No.	Calibrated Until
R&S SPECTRUM ANALYZER	FSP	1093.4495.30	Dec. 19, 2003

NOTE:

- 1.The measurement uncertainty is less than +/- 2.6dB, which is calculated as per the NAMAS document NIS81.
- 2.The calibration interval of the above test instruments is 12 months and the calibrations are traceable to NML/ROC and NIST/USA.

4.5.3 TEST PROCEDURE

The transmitter output was connected to the spectrum analyzer through an attenuator, the bandwidth of the fundamental frequency was measured with the spectrum analyzer using 3 kHz RBW and 30 kHz VBW, set sweep time= $\text{span}/3\text{kHz}$. The power spectral density was measured and recorded. The sweep time is allowed to be longer than $\text{span}/3\text{kHz}$ for a full response of the mixer in the spectrum analyzer.

4.5.4 TEST SETUP

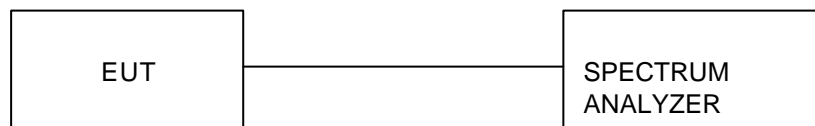

4.5.5 EUT OPERATING CONDITIONS

Same as 4.3.5



4.5.6 TEST RESULTS-DSSS

EUT	802.11b/g MiniPCI Module	MODEL	G11FNF
INPUT POWER (SYSTEM)	120Vac, 60 Hz	ENVIRONMENTAL CONDITIONS	26 deg. C, 59 %RH, 979 hPa
TEST MODE	Antenna 1&3	TESTED BY	Hank Chung

CHANNEL NUMBER	CHANNEL FREQUENCY (MHz)	RF POWER LEVEL IN 3 KHz BW (dBm)	MAXIMUM LIMIT (dBm)	PASS/FAIL
1	2412	-10.33	8	PASS
6	2437	-9.75	8	PASS
11	2462	-9.45	8	PASS