



FCC TEST REPORT

REPORT NO.: RF920722R01
MODEL NO.: C38WCW
PLATFORM: Alpha-1, **BRAND:** Proxim
RECEIVED: Jul. 22, 2003
TESTED: Jul. 31 to Aug. 23, 2003

APPLICANT: Proxim Corporation

ADDRESS: 935 Stewart Drive, Sunnyvale, CA 94085, USA

ISSUED BY: Advance Data Technology Corporation

LAB LOCATION: No. 81-1, Lu Liao Keng, 9 Ling, Wu Lung Tsuen,
Chiung Lin Hsiang, Hsin Chu Hsien,
Taiwan, R.O.C.

This test report consists of 279 pages in total. It may be duplicated completely for legal use with the approval of the applicant. It should not be reproduced except in full, without the written approval of our laboratory. The client should not use it to claim product endorsement by NVLAP or any government agencies. The test results in the report only apply to the tested sample.



Lab Code: 200376-0



Table of Contents

1.	CERTIFICATION.....	7
2.	SUMMARY OF TEST RESULTS.....	8
3.	GENERAL INFORMATION.....	11
3.1	GENERAL DESCRIPTION OF EUT.....	11
3.2	DESCRIPTION OF TEST MODES.....	15
3.3	GENERAL DESCRIPTION OF APPLIED STANDARDS.....	16
3.4	DESCRIPTION OF SUPPORT UNITS.....	17
4.	TEST TYPES AND RESULTS (FOR PART 802.11B).....	18
4.1	CONDUCTED EMISSION MEASUREMENT.....	18
4.1.1	LIMITS OF CONDUCTED EMISSION MEASUREMENT.....	18
4.1.2	TEST INSTRUMENTS.....	18
4.1.3	TEST PROCEDURES.....	19
4.1.4	DEVIATION FROM TEST STANDARD.....	19
4.1.5	TEST SETUP.....	20
4.1.6	EUT OPERATING CONDITIONS.....	20
4.1.7	TEST RESULTS.....	21
4.2	RADIATED EMISSION MEASUREMENT.....	23
4.2.1	LIMITS OF RADIATED EMISSION MEASUREMENT.....	23
4.2.2	TEST INSTRUMENTS.....	24
4.2.3	TEST PROCEDURES.....	25
4.2.4	DEVIATION FROM TEST STANDARD.....	25
4.2.5	TEST SETUP.....	26
4.2.6	EUT OPERATING CONDITIONS.....	26
4.2.7	TEST RESULTS (I)- ANTENNA 1.....	27
4.2.8	TEST RESULTS (II)- ANTENNA 2.....	34
4.2.9	TEST RESULTS (III)- ANTENNA 3.....	41
4.2.10	TEST RESULTS (IV)- ANTENNA 4.....	48
4.2.11	TEST RESULTS (V)- ANTENNA 5.....	55
4.2.12	TEST RESULTS (VI)- ANTENNA 7.....	62
4.2.13	TEST RESULTS (VII)- ANTENNA 8.....	69
4.3	6DB BANDWIDTH MEASUREMENT.....	76
4.3.1	LIMITS OF 6DB BANDWIDTH MEASUREMENT.....	76
4.3.2	TEST INSTRUMENTS.....	76
4.3.3	TEST PROCEDURE.....	77
4.3.4	DEVIATION FROM TEST STANDARD.....	77
4.3.5	TEST SETUP.....	77
4.3.6	EUT OPERATING CONDITIONS.....	77
4.3.7	TEST RESULTS (A).....	78
4.3.8	TEST RESULTS (A).....	82
4.4	MAXIMUM PEAK OUTPUT POWER.....	86
4.4.1	LIMITS OF MAXIMUM PEAK OUTPUT POWER MEASUREMENT.....	86



4.4.2	INSTRUMENTS	86
4.4.3	TEST PROCEDURES	87
4.4.4	TEST SETUP	87
4.4.5	EUT OPERATING CONDITIONS	87
4.4.6	TEST RESULTS (B)-ANTENNA 1 & ANTENNA 4 & ANTENNA 7-DSSS	88
4.4.7	TEST RESULTS (B)-ANTENNA 1 & ANTENNA 4 & ANTENNA 7-OFDM	88
4.4.8	TEST RESULTS (B)-ANTENNA 2-DSSS	89
4.4.9	TEST RESULTS (B)-ANTENNA 2-OFDM	89
4.4.10	TEST RESULTS (B)-ANTENNA 3-DSSS	90
4.4.11	TEST RESULTS (B)-ANTENNA 3-OFDM	90
4.4.12	TEST RESULTS (B)-ANTENNA 5-DSSS	91
4.4.13	TEST RESULTS (B)-ANTENNA 5-OFDM	91
4.4.14	TEST RESULTS (B)-ANTENNA 8-DSSS	92
4.4.15	TEST RESULTS (B)-ANTENNA 8-OFDM	92
4.5	POWER SPECTRAL DENSITY MEASUREMENT	93
4.5.1	LIMITS OF POWER SPECTRAL DENSITY MEASUREMENT	93
4.5.2	TEST INSTRUMENTS	93
4.5.3	TEST PROCEDURE	94
4.5.4	DEVIATION FROM TEST STANDARD	94
4.5.5	TEST SETUP	94
4.5.6	EUT OPERATING CONDITION	94
4.5.7	TEST RESULTS (C)	95
4.5.8	TEST RESULTS(C)	99
4.6	BAND EDGES MEASUREMENT	103
4.6.1	LIMITS OF BAND EDGES MEASUREMENT	103
4.6.2	TEST INSTRUMENTS	103
4.6.3	TEST PROCEDURE	103
4.6.4	DEVIATION FROM TEST STANDARD	103
4.6.5	EUT OPERATING CONDITION	104
4.6.6	TEST RESULTS (D)-ANTENNA 1 & ANTENNA 4 & ANTENNA 7-DSSS	104
4.6.7	TEST RESULTS (D)-ANTENNA 1 & ANTENNA 4 & ANTENNA 7-OFDM	107
4.6.8	TEST RESULTS (D)-ANTENNA 2-DSSS	110
4.6.9	TEST RESULTS (D)-ANTENNA 2-OFDM	113
4.6.10	TEST RESULTS (D)-ANTENNA 3-DSSS	116
4.6.11	TEST RESULTS (D)-ANTENNA 3-OFDM	119
4.6.12	TEST RESULTS (D)-ANTENNA 5-DSSS	122
4.6.13	TEST RESULTS (D)-ANTENNA 5-OFDM	125
4.6.14	TEST RESULTS (D)-ANTENNA 8-DSSS	128
4.6.15	TEST RESULTS (D)-ANTENNA 8-OFDM	131
4.7	ANTENNA REQUIREMENT	134
4.7.1	STANDARD APPLICABLE	134
4.7.2	ANTENNA CONNECTED CONSTRUCTION	134
5.	TEST TYPES AND RESULTS (FOR PART 802.11A)	135
5.1	CONDUCTED EMISSION MEASUREMENT	135



5.1.1	LIMITS OF CONDUCTED EMISSION MEASUREMENT.....	135
5.1.2	TEST INSTRUMENTS.....	135
5.1.3	TEST PROCEDURES.....	136
5.1.4	DEVIATION FROM TEST STANDARD.....	136
5.1.5	TEST SETUP.....	137
5.1.6	EUT OPERATING CONDITIONS.....	137
5.1.7	TEST RESULTS.....	138
5.2	RADIATED EMISSION MEASUREMENT.....	140
5.2.1	LIMITS OF RADIATED EMISSION MEASUREMENT.....	140
5.2.2	LIMITS OF UNWANTED EMISSION OUT OF THE RESTRICTED BANDS.....	141
5.2.3	TEST INSTRUMENTS.....	142
5.2.4	TEST PROCEDURES.....	143
5.2.5	DEVIATION FROM TEST STANDARD.....	143
5.2.6	TEST SETUP.....	144
5.2.7	EUT OPERATING CONDITIONS.....	144
5.2.8	TEST RESULTS(I) -ANTENNA 1.....	145
5.2.9	TEST RESULTS(II) -ANTENNA 7.....	158
5.2.10	TEST RESULTS(III) -ANTENNA 8.....	167
5.3	PEAK TRANSMIT POWER MEASUREMENT.....	176
5.3.1	LIMITS OF PEAK TRANSMIT POWER MEASUREMENT.....	176
5.3.2	TEST INSTRUMENTS.....	176
5.3.3	TEST PROCEDURE.....	177
5.3.4	DEVIATION FROM TEST STANDARD.....	177
5.3.5	TEST SETUP.....	177
5.3.6	EUT OPERATING CONDITIONS.....	177
5.3.7	TEST RESULTS (E)-ANTENNA 1 & ANTENNA 7.....	178
5.3.8	TEST RESULTS (E)-ANTENNA 8.....	194
5.4	PEAK POWER EXCURSION MEASUREMENT.....	202
5.4.1	LIMITS OF PEAK POWER EXCURSION MEASUREMENT.....	202
5.4.2	TEST INSTRUMENTS.....	202
5.4.3	TEST PROCEDURE.....	203
5.4.4	DEVIATION FROM TEST STANDARD.....	203
5.4.5	TEST SETUP.....	203
5.4.6	EUT OPERATING CONDITIONS.....	203
5.4.7	TEST RESULTS (F)-ANTENNA 1 & ANTENNA 7.....	204
5.4.8	TEST RESULTS (F)-ANTENNA 8.....	213
5.5	PEAK POWER SPECTRAL DENSITY MEASUREMENT.....	218
5.5.1	LIMITS OF PEAK POWER SPECTRAL DENSITY MEASUREMENT.....	218
5.5.2	TEST INSTRUMENTS.....	218
5.5.3	TEST PROCEDURES.....	219
5.5.4	DEVIATION FROM TEST STANDARD.....	219
5.5.5	TEST SETUP.....	219
5.5.6	EUT OPERATING CONDITIONS.....	219
5.5.7	TEST RESULTS (G)-ANTENNA 1 & ANTENNA 7.....	220



5.5.8	TEST RESULTS (G)-ANTENNA 8.....	229
5.6	FREQUENCY STABILITY.....	234
5.6.1	LIMITS OF FREQUENCY STABILITY MEASUREMENT.....	234
5.6.2	TEST INSTRUMENTS.....	234
5.6.3	TEST PROCEDURE	234
5.6.4	DEVIATION FROM TEST STANDARD	234
5.6.5	TEST SETUP.....	235
5.6.6	EUT OPERATING CONDITION.....	235
5.6.7	TEST RESULTS (H).....	236
5.7	BAND EDGES MEASUREMENT	237
5.7.1	TEST INSTRUMENTS.....	237
5.7.2	TEST PROCEDURE	237
5.7.3	EUT OPERATING CONDITION.....	237
5.7.4	TEST RESULTS (I).....	238
5.8	6DB BANDWIDTH MEASUREMENT.....	246
5.8.1	LIMITS OF 6DB BANDWIDTH MEASUREMENT.....	246
5.8.2	TEST INSTRUMENTS.....	246
5.8.3	TEST PROCEDURE	247
5.8.4	DEVIATION FROM TEST STANDARD	247
5.8.5	TEST SETUP.....	247
5.8.6	EUT OPERATING CONDITIONS	247
5.8.7	TEST RESULTS(J).....	248
5.9	MAXIMUM PEAK OUTPUT POWER.....	255
5.9.1	LIMITS OF MAXIMUM PEAK OUTPUT POWER MEASUREMENT.....	255
5.9.2	INSTRUMENTS	255
5.9.3	TEST PROCEDURES	256
5.9.4	TEST SETUP.....	256
5.9.5	EUT OPERATING CONDITIONS	256
5.9.6	TEST RESULTS(K)-ANTENNA 1 & ANTENNA 7.....	257
5.9.7	TEST RESULTS(K)-ANTENNA 8.....	258
5.9.8	LIMITS OF POWER SPECTRAL DENSITY MEASUREMENT.....	259
5.9.9	TEST INSTRUMENTS.....	259
5.9.10	TEST PROCEDURE	260
5.9.11	DEVIATION FROM TEST STANDARD	260
5.9.12	TEST SETUP.....	260
5.9.13	EUT OPERATING CONDITION.....	260
5.9.14	TEST RESULTS (L).....	261
5.10	BAND EDGES MEASUREMENT	268
5.10.1	LIMITS OF BAND EDGES MEASUREMENT.....	268
5.10.2	TEST INSTRUMENTS.....	268
5.10.3	TEST PROCEDURE	268
5.10.4	DEVIATION FROM TEST STANDARD	268
5.10.5	EUT OPERATING CONDITION.....	269
5.10.6	TEST RESULTS (M).....	269



5.11	ANTENNA REQUIREMENT.....	278
5.11.1	STANDARD APPLICABLE	278
5.11.2	ANTENNA CONNE CTED CONSTRUCTION.....	278
6.	INFORMATION ON THE TESTING LABORATORIES.....	279



1. CERTIFICATION

PRODUCT : 802.11a/b/g miniPCI module
BRAND NAME : Proxim
MODEL NO. : C38WCW
PLATFORM: Alpha-1 **BRAND:** Proxim
APPLICANT : Proxim Corporation
STANDARDS : 47 CFR Part 15, Subpart C (Section 15.247),
Subpart E (Section 15.407), ANSI C63.4-1992

We, **Advance Data Technology Corporation**, hereby certify that one sample of the designation has been tested in our facility from Jul. 31 to Aug. 23, 2003. The test record data evaluation and Equipment under Test (EUT) configurations represented herein are true and accurate accounts of the measurements of the sample's EMC characteristics under the conditions herein specified.

PREPARED BY: *Amanda Chu* , **DATE:** *Aug. 23, 2003*
(Amanda Chu)

APPROVED BY: *Eric Lin* , **DATE:** *Aug. 23, 2003*
(Eric Lin, Manager)

2. SUMMARY OF TEST RESULTS

The EUT has been tested according to the following specifications:

APPLIED STANDARD: 47 CFR Part 15, Subpart C			
Standard Section	Test Type and Limit	Result	REMARK
15.207	AC Power Conducted Emission	PASS	Meet the requirement of limit Minimum passing margin is -11.83dBuV at 2.755MHz
15.247(a)(2)	Spectrum Bandwidth of a Direct Sequence Spread Spectrum System Limit: min. 500kHz	PASS	Meet the requirement of limit
15.247(b)	Maximum Peak Output Power Limit: max. 30dBm	PASS	Meet the requirement of limit
15.247(c)	Radiated Emissions Limit: Table 15.209	PASS	Meet the requirement of limit Minimum passing margin is -1.3dBuV at 2390.00 MHz
15.247(d)	Power Spectral Density Limit: max. 8dBm	PASS	Meet the requirement of limit
15.247(c)	Band Edge Measurement Limit: 20dB less than the peak value of fundamental frequency	PASS	Meet the requirement of limit



for freq. 5.15~5.35GHz :

APPLIED STANDARD: 47 CFR Part 15, Subpart E			
Standard Section	Test Type	Result	REMARK
15.407(b)(5)	AC Power Conducted Emission	PASS	Meet the requirement of limit Minimum passing margin is -10.62dBuV at 2.482MHz
15.407(b/1/2/3) (b)(5)	Electric Field Strength Spurious Emissions, 30 MHz – 40000 MHz	PASS	Meet the requirement of limit Minimum passing margin is -1.0dBuV at 5250.00MHz
15.407(a/1/2/3)	Peak Transmit Power	PASS	Meet the requirement of limit
15.407(a)(6)	Peak Power Excursion	PASS	Meet the requirement of limit
15.407(a/1/2/3)	Peak Power Spectral Density	PASS	Meet the requirement of limit
15.407(g)	Frequency Stability	PASS	Meet the requirement of limit



for freq. 5.725~5.850GHz :

APPLIED STANDARD: 47 CFR Part 15, Subpart C			
Standard Section	Test Type and Limit	Result	REMARK
15.207	AC Power Conducted Emission	PASS	Meet the requirement of limit Minimum passing margin is -10.62dBuV at 2.482MHz
15.247(a)(2)	Spectrum Bandwidth of a Direct Sequence Spread Spectrum System Limit: min. 500kHz	PASS	Meet the requirement of limit
15.247(b)	Maximum Peak Output Power Limit: max. 30dBm	PASS	Meet the requirement of limit
15.247(c)	Radiated Emissions Limit: Table 15.209	PASS	Meet the requirement of limit Minimum passing margin is -2.7dBuV at 11490.00MHz
15.247(d)	Power Spectral Density Limit: max. 8dBm	PASS	Meet the requirement of limit
15.247(c)	Band Edge Measurement Limit: 20dB less than the peak value of fundamental frequency	PASS	Meet the requirement of limit



3. GENERAL INFORMATION

3.1 GENERAL DESCRIPTION OF EUT

PRODUCT	802.11a/b/g miniPCI module
MODEL NO.	C38WCW
PLATFORM	Alpha-1
POWER SUPPLY	3.3VDC from host equipment
MODULATION	DSSS, OFDM
TRANSFER RATE	802.11b and draft 802.11g: 1/2/5.5/6/9/11/12/18/24/36/48/54Mbps 802.11a:6 to 54Mbps (Turbo mode: up to 108Mbps *see note 1)
FREQUENCY RANGE	802.11b and draft 802.11g: 2400MHz ~ 2483.5MHz 802.11a: 5.15GHz ~ 5.35GHz, 5.725GHz ~ 5.850GHz
NUMBER OF CHANNEL	802.11b and draft 802.11g: 11 802.11a: 13 for Normal mode / 5 for Turbo mode
CHANNEL SPACING	802.11b and draft 802.11g: 5MHz 802.11a: 20MHz for Normal mode / 40MHz for Turbo mode
OUTPUT POWER	802.11b: 20.39dBm / draft 802.11g: 19.41dBm 802.11a: 19.64dBm (*see note 4)
DATA CABLE	NA
ANTENNA TYPE	Omni-Directional Antenna, Patch -Directional Antenna, Directional Antenna, Directional Wide Angle Antenna, Window Antenna
I/O PORTS	NA
ASSOCIATED DEVICES	NA

NOTE:

1. This EUT is capable of providing data rates of up to 108Mbps in Turbo Mode depending upon reception quality.



2. There are eleven types of antennas provided to this EUT, please refer to the following table:

No.	Model No.	Gain (dBi)	Antenna Connector
1	IAN-WB-OD-S	3dBi/2.4GHz; 5dBi/5GHz	With Connector
6	IAN-WB-OD	3dBi/2.4GHz; 5dBi/5GHz	Without Connector
* Two antennas (Antenna No. 1 & Antenna 6) are identical except for their Antenna Connector.			
7	AIN-WB-OD	3dBi/2.4GHz; 6dBi/5GHz	
8	AIN-WB-OD-B	2.5dBi / 2.4GHz; 5.5dBi / 5GHz	

* Antenna No. 7 & Antenna 8 shall be tested in combination with Antenna 1.

No.	Model No.	Gain (dBi)	Antenna Type	Total loss of PAC24-09 + surge arrester + extension cable	Total gain that the combination contributes to the output power of the mini pci
				Total insertion loss (dBi)	Effective antenna gain (dBi)
2	AOU24-OD-10	10	Omni-Directional	1.7	8.3
3	AOU24-DI-14	14	patch -Directional	1.7	12.3
4	AOU24-OD-55-B	1.5	Omni-Directional	1.7	-0.2
5	AOU24-YA-1414	13.5	Directional	1.7	11.8
9	AOU24-OD-77	7	Omni-Directional	1.7	5.3
10	AOU24-WA-12-B	12	Directional Wide Angle	1.7	10.3
11	AOU24-WI-12-B	12	Window	1.7	10.3

* These antennas shall be tested in combination with Antenna 1+ PAC24-09 + surge_arrester (010997) + 20 FT extention cable (LMR400).

3. Frequency Range of each Antennas are as followings:

Antenna No.	Frequency Range
No. 1	2400MHz ~ 2483.5MHz, 5.15GHz ~ 5.35GHz, 5.725GHz ~ 5.850GHz
No. 7, 8	2400MHz ~ 2483.5MHz, 5.25GHz ~ 5.35GHz, 5.725GHz ~ 5.850GHz
No. 2-6	2400MHz ~ 2483.5MHz



4. Peak output power (Unit : dBm) :

No.	Model No.	Operating Frequency (MHz)			
		2412~2462	5150~5250	5250~5350	5725~5850
1	IAN-WB-OD-S	20.39	16.75	19.20	19.64
2	AOU24-OD-10	16.90	NA	NA	NA
3	AOU24-DI-14	11.93	NA	NA	NA
4	AOU24-OD-55-B	20.39	NA	NA	NA
5	AOU24-YA-1414	12.60	NA	NA	NA
7	AIN-WB-OD	20.39	NA	19.2	19.64
8	AIN-WB-OD-B	15.67	NA	15.30	15.38

5. Platforms was operated with an AC/DC power adapter:

BRAND:	DVE
MODEL:	DSA-0151F-12A
INPUT	100-240Vac, 50/60Hz, 0.4A
OUTPUT:	+12V DC, 1.5A

6. Dual-band, the EUT communicates with Wireless-A (802.11a), Wireless-B, (802.11b), and Wireless-G (draft 802.11g) wireless networks.
7. For more detailed features description, please refer to the manufacturer's specifications or User's Manual.

8. The EUT was tested under the following test results, and its data were recorded in this report::

Test result	Measurement Description
<i>For 802.11b DSSS & 802.11g OFDM</i>	
A	6dB bandwidth of maximum conducted output power
B	Peak output power
C	Power Spectral Density of maximum conducted output power
D	Band Edge Measurement
<i>For freq. 5.15~5.35GHz :</i>	
E	Peak Transmit Power
F	Peak Power Excursion
G	Peak Power Spectral Density
H	Frequency Stability
I	Band Edge Measurement
<i>For freq. 5.725~5.850GHz :</i>	
J	6dB bandwidth of maximum conducted output power
K	Peak output power
L	Power Spectral Density of maximum conducted output power
M	Band Edge Measurement



3.2 DESCRIPTION OF TEST MODES

For 802.11b: Eleven channels are provided to this EUT.

Channel	Frequency	Channel	Frequency
1	2412 MHz	7	2442 MHz
2	2417 MHz	8	2447 MHz
3	2422 MHz	9	2452 MHz
4	2427 MHz	10	2457 MHz
5	2432 MHz	11	2462 MHz
6	2437 MHz		

NOTE:

1. Below 1 GHz, the channel 1, 6, and 11 were pre-tested in chamber. The channel 11, worst case one, was chosen for final test.
2. Above 1 GHz, the channel 1, 6, and 11 were tested individually.
3. Transfer rate, 11Mbps with CCK technique and 6Mbps with OFDM technique, the worst case, were chosen for final test.
4. CCK technique and OFDM technique are presented in Section 4.

For 802.11a: Thirteen channels are provided to this EUT for Normal mode.

Channel	Frequency	Channel	Frequency
1	5180 MHz	8	5320 MHz
2	5200 MHz	9	5745MHz
3	5220 MHz	10	5765MHz
4	5240 MHz	11	5785MHz
5	5260 MHz	12	5805MHz
6	5280 MHz	13	5825MHz
7	5300 MHz		

Five channels are provided to this EUT for Turbo Mode.

Channel	Frequency	Channel	Frequency
1	5210 MHz	4	5760MHz
2	5250 MHz	5	5800MHz
3	5290 MHz		

NOTE:

1. The EUT was tested in both normal mode (channel bandwidth of approximately 30MHz) and turbo mode (channel bandwidth of approximately 60MHz).
2. "Normal Mode" allows data rates of up to 54Mbps. The device was, therefore, tested in Normal mode at the data rate that produced the highest output power for normal mode (6Mbps).
3. "Turbo Mode" allows data rates of up to 108Mbps. At data rates higher than 12Mbps the PA gain is reduced to improve signal fidelity. The device was, therefore, tested in turbo mode at the data rate that produced the highest output power for turbo mode (12Mbps).
4. Channel 1, 4, 5, 8, 9, 11 and 13 are the closest frequencies to the band edge, were chosen for final test of Normal Mode.
5. Channel 1 ~ 5 were chosen for final test of turbo mode.



3.3 GENERAL DESCRIPTION OF APPLIED STANDARDS

The EUT is an 802.11a/b/g miniPCI module According to the specifications of the manufacturer, it must comply with the requirements of the following standards:

**47 CFR Part 15, Subpart C. (15.247),
Subpart E (15.407). ANSI C63.4 : 1992**

All tests have been performed and recorded as per the above standards.

NOTE: The EUT is also considered as a kind of computer peripheral, because the connection to computer is necessary for typical use. It has been verified to comply with the requirements of 47CFR Part 15, Subpart B, Class B (DoC). The test report has been issued separately.



3.4 DESCRIPTION OF SUPPORT UNITS

The EUT has been tested as an independent unit together with other necessary accessories or support units. The following support units or accessories were used to form a representative test configuration during the tests.

No.	Product	Brand	Model No.	Serial No.	FCC ID
1	NOTEBOOK COMPUTER	DELL	PP01L	TW-09C748-12800-17Q-C504	FCC DoC

No.	Signal cable description
1	NA

Note: 1. All power cords of the above support units are unshielded (1.8m).

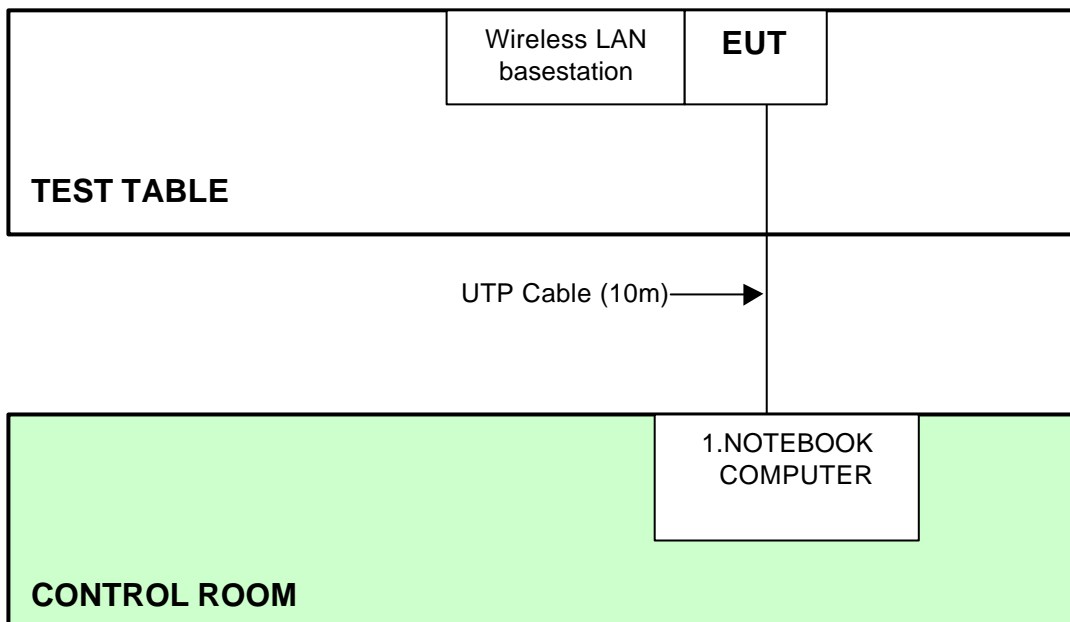

NOTE: 1. Support unit 1 was kept in the control room during the test.
 2. Please refer to the photos of test configuration in Item 5 also.



4. TEST TYPES AND RESULTS (FOR PART 802.11b)

4.1 CONDUCTED EMISSION MEASUREMENT

4.1.1 LIMITS OF CONDUCTED EMISSION MEASUREMENT

FREQUENCY (MHz)	Class A (dBuV)		Class B (dBuV)	
	Quasi-peak	Average	Quasi-peak	Average
0.15 - 0.5	79	66	66 - 56	56 - 46
0.50 - 5.0	73	60	56	46
5.0 - 30.0	73	60	60	50

- NOTES:**
- (1) The lower limit shall apply at the transition frequencies.
 - (2) The limit decreases in line with the logarithm of the frequency in the range of 0.15 to 0.50 MHz.
 - (3) All emanations from a class A/B digital device or system, including any network of conductors and apparatus connected thereto, shall not exceed the level of field strengths specified above.

4.1.2 TEST INSTRUMENTS

DESCRIPTION & MANUFACTURER	MODEL NO.	SERIAL NO.	CALIBRATED UNTIL
ROHDE & SCHWARZ Test Receiver	ESCS 30	847124/029	Nov. 17, 2003
ROHDE & SCHWARZ LISN (for EUT)	ESHS-Z5	848773/004	Nov. 13, 2003
KYORITSU LISN (for peripheral)	KNW-407	8/1395/12	Jul. 23, 2004
RF Cable (JETBAO)	RG233/U	Cable_CA_01	Jul. 03, 2004
Terminator(for KYORITSU)	50	3	Apr. 11, 2004
Software	Cond-V2e	NA	NA

- NOTE:**
1. The calibration interval of the above test instruments is 12 months and the calibrations are traceable to NML/ROC and NIST/USA.
 2. The test was performed in ADT Shielded Room No. A.
 3. The VCCI Con A Registration No. is C-817.



4.1.3 TEST PROCEDURES

- a. The EUT was placed 0.4 meters from the conducting wall of the shielded room with EUT being connected to the power mains through a line impedance stabilization network (LISN). Other support units were connected to the power mains through another LISN. The two LISNs provide 50 ohm/ 50uH of coupling impedance for the measuring instrument.
- b. Both lines of the power mains connected to the EUT were checked for maximum conducted interference.
- c. The frequency range from 150 kHz to 30 MHz was searched. Emission levels over 10dB under the prescribed limits could not be reported

4.1.4 DEVIATION FROM TEST STANDARD

No deviation

4.1.5 TEST SETUP

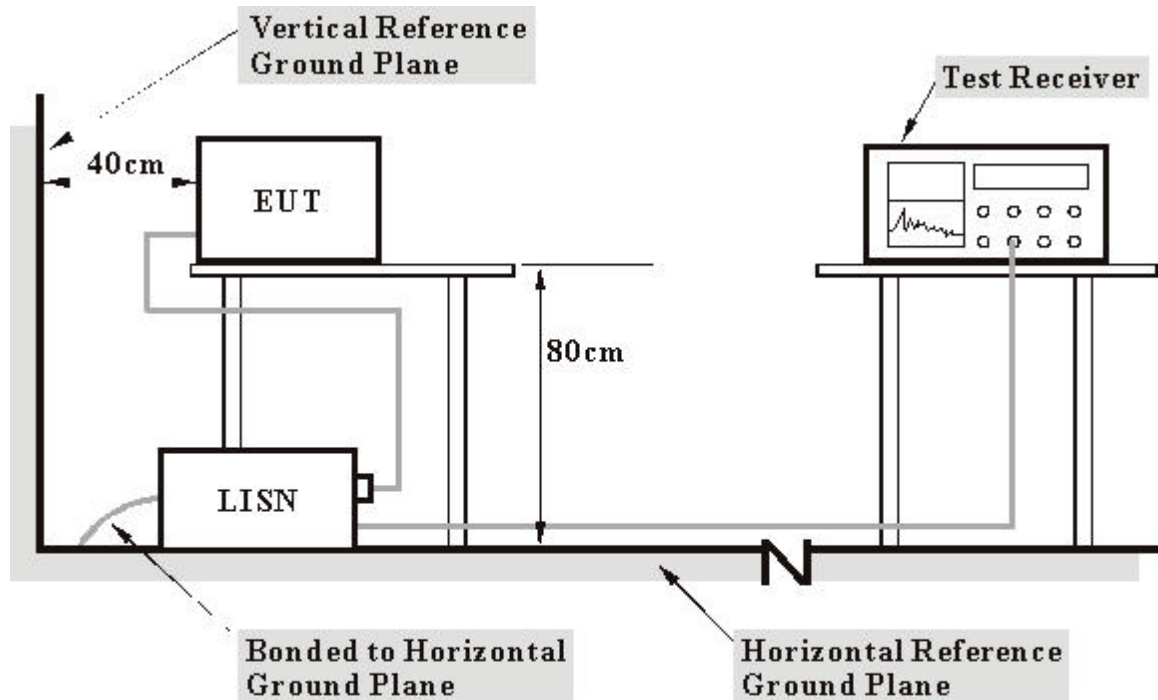

- Note:**
1. Support units were connected to second LISN.
 2. Both of LISNs (AMN) 80 cm from EUT and at the least 80 cm from other units and other metal planes support units.

For the actual test configuration, please refer to the related item – Photographs of the Test Configuration.

4.1.6 EUT OPERATING CONDITIONS

- a. Placed the EUT on the testing table.
- b. Prepared another computer system to act as a communication partner and placed it outside of testing area.
- c. The communication partner run a test program to enable EUT under transmission/receiving condition continuously at specific channel frequency via an RJ 45 cable and wireless.
- d. The communication partner sent data to EUT by command "PING".



4.1.7 TEST RESULTS

EUT	802.11a/b/g miniPCI module	MODEL	C38WCW
MODE	Channel 11	6dB BANDWIDTH	9 kHz
INPUT POWER (SYSTEM)	120Vac, 60Hz	PHASE	Line (L)
ENVIRONMENTAL CONDITIONS	27deg. C, 60%RH, 965 hPa	TESTED BY	Tony Chen

No	Freq. [MHz]	Corr. Factor (dB)	Reading Value [dB (uV)]		Emission Level [dB (uV)]		Limit [dB (uV)]		Margin (dB)	
			Q.P.	AV.	Q.P.	AV.	Q.P.	AV.	Q.P.	AV.
			1	0.341	0.20	35.56	-	35.76	-	59.17
2	0.564	0.23	33.85	-	34.08	-	56.00	46.00	-21.92	-
3	0.783	0.26	32.82	-	33.08	-	56.00	46.00	-22.92	-
4	1.236	0.30	38.46	-	38.76	-	56.00	46.00	-17.24	-
5	2.529	0.33	41.70	-	42.03	-	56.00	46.00	-13.97	-
6	2.755	0.34	43.83	-	44.17	-	56.00	46.00	-11.83	-

- NOTES: (1) "***": Undetectable
 (2) Q.P. and AV. are abbreviations of quasi-peak and average.
 (3) "-": The Quasi-peak reading value also meets an average limit, thus measurement with the average detector is unnecessary.
 (4) The emission levels of other frequencies were very low against the limit.
 (5) Correction Factor = Insertion loss + Cable loss
 (6) Margin value = Emission level - Limit value

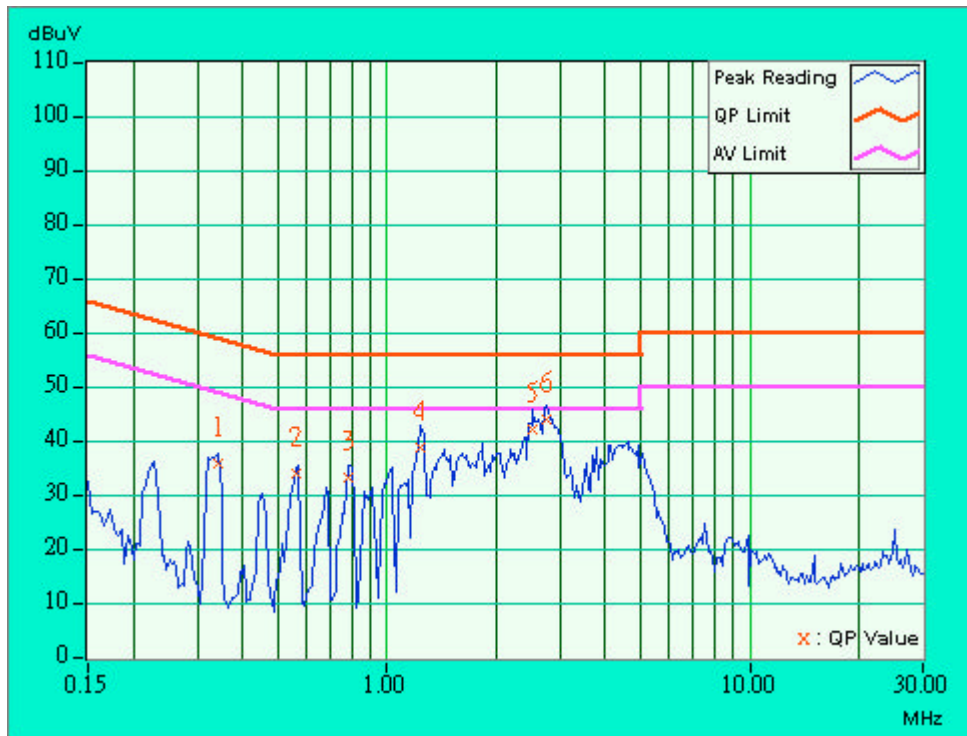



EUT	802.11a/b/g miniPCI module	MODEL	C38WCW
MODE	Channel 11	6dB BANDWIDTH	9 kHz
INPUT POWER (SYSTEM)	120Vac, 60Hz	PHASE	Neutral (N)
ENVIRONMENTAL CONDITIONS	27deg. C, 60%RH, 965 hPa	TESTED BY	Tony Chen

No	Freq. [MHz]	Corr. Factor (dB)	Reading Value [dB (uV)]		Emission Level [dB (uV)]		Limit [dB (uV)]		Margin (dB)	
			Q.P.	AV.	Q.P.	AV.	Q.P.	AV.	Q.P.	AV.
			1	0.224	0.20	32.86	-	33.06	-	62.66
2	0.861	0.28	33.06	-	33.34	-	56.00	46.00	-22.66	-
3	1.232	0.30	40.06	-	40.36	-	56.00	46.00	-15.64	-
4	2.470	0.32	41.38	-	41.70	-	56.00	46.00	-14.30	-
5	2.705	0.34	42.02	-	42.36	-	56.00	46.00	-13.64	-
6	4.277	0.41	34.77	-	35.18	-	56.00	46.00	-20.82	-

- NOTES: (1) "": Undetectable
 (2) Q.P. and AV. are abbreviations of quasi-peak and average.
 (3) "-": The Quasi-peak reading value also meets an average limit, thus measurement with the average detector is unnecessary.
 (4) The emission levels of other frequencies were very low against the limit.
 (5) Correction Factor = Insertion loss + Cable loss
 (6) Margin value = Emission level - Limit value

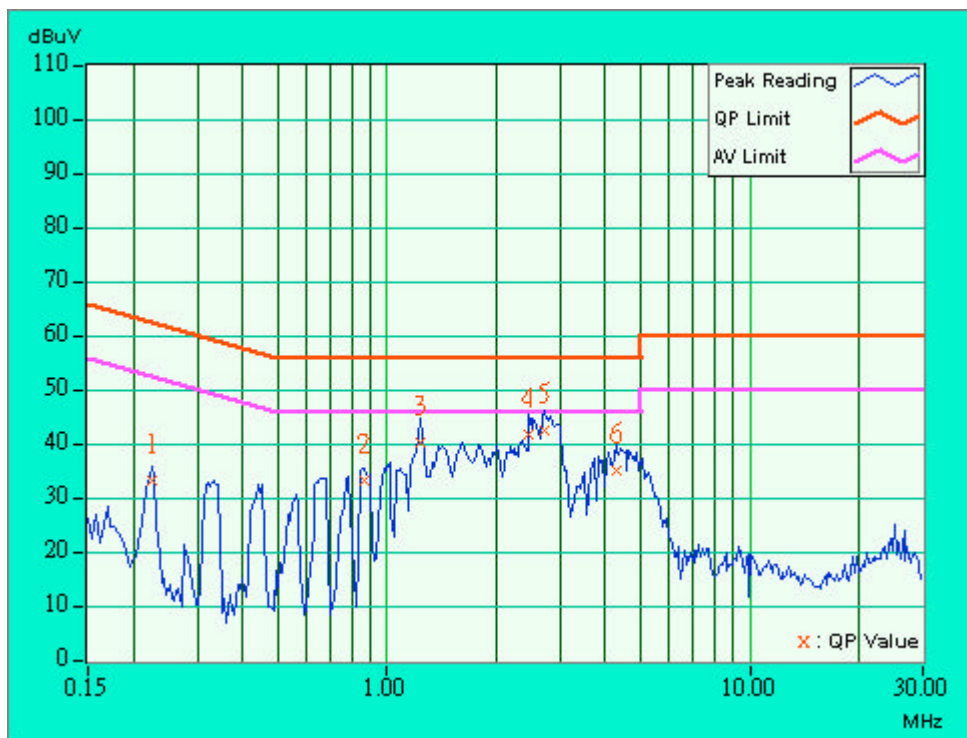



4.2 RADIATED EMISSION MEASUREMENT

4.2.1 LIMITS OF RADIATED EMISSION MEASUREMENT

Emissions radiated outside of the specified bands, shall be according to the general radiated limits in 15.209 as following:

Frequencies (MHz)	Field strength (microvolts/meter)	Measurement distance (meters)
0.009-0.490	2400/F(kHz)	300
0.490-1.705	24000/F(kHz)	30
1.705-30.0	30	30
30-88	100	3
88-216	150	3
216-960	200	3
Above 960	500	3

NOTE

1. The lower limit shall apply at the transition frequencies.
2. Emission level (dBuV/m) = 20 log Emission level (uV/m).
3. As shown in 15.35(b), for frequencies above 1000MHz, the field strength limits are based on average detector, however, the peak field strength of any emission shall not exceed the maximum permitted average limits, specified above by more than 20dB under any condition of modulation.



4.2.2 TEST INSTRUMENTS

DESCRIPTION & MANUFACTURER	MODEL NO.	SERIAL NO.	CALIBRATED UNTIL
HP Spectrum Analyzer	8594ER	3829U04676	Jul. 14, 2004
ADVANTEST Spectrum Analyzer	R3271A	85060311	May 21, 2004
CHASE RF Pre_Amplifier	CPA9232	1057	Apr. 24, 2004
HP Pre_Amplifier	8449B	3008A01281	June 27, 2004
ROHDE & SCHWARZ Test Receiver	ESVS 10	849231 /019	Nov. 03, 2003
CHASE Broadband Antenna	CBL6111c	2730	Jul 17, 2004
Schwarzbeck Horn_Antenna	BBHA9120-D1	D123	Aug. 26, 2003
SCHWARZBECK Tunable Dipole Antenna	UHAP	897	Mar. 07, 2005
SCHWARZBECK Tunable Dipole Antenna	VHAP	880	Mar. 07, 2005
RF Switches (ARNITSU)	CS-201	1565157	Dec. 01, 2003
RF CABLE (Chaintek) 1GHz-20GHz	Ak 9515-D	001	Aug, 20.2003
RF Cable(RICHTEC)	9913-30M	STCCAB-30M- 1GHz-021	Nov. 5, 2003
Software	AS60P8	NA	NA
CHANCE MOST Antenna Tower	AT-100	0203	NA
CHANCE MOST Turn Table	TT-100	0203	NA

Note: 1. The calibration interval of the above test instruments is 12 months (36 months for Tunable Dipole Antenna) and the calibrations are traceable to NML/ROC and NIST/USA.

2. * = These equipment are used for the final measurement.
3. The horn antenna and HP preamplifier (model: 8449B) are used only for the measurement of emission frequency above 1GHz if tested.
4. The test was performed in ADT Open Site No. C.
5. The FCC Site Registration No. is 656396.
6. The VCCI Site Registration No. is R-1626.
7. The CANADA Site Registration No. is IC 3789-C.



4.2.3 TEST PROCEDURES

- a. The EUT was placed on the top of a rotating table 0.8 meters above the ground at a 10 meter open area test site. The table was rotated 360 degrees to determine the position of the highest radiation.
- b. The EUT was set 3 meters away from the interference-receiving antenna, which was mounted on the top of a variable-height antenna tower.
- c. The antenna is a broadband antenna, and its height is varied from one meter to four meters above the ground to determine the maximum value of the field strength. Both horizontal and vertical polarizations of the antenna are set to make the measurement.
- d. For each suspected emission, the EUT was arranged to its worst case and then the antenna was tuned to heights from 1 meter to 4 meters and the rotatable table was turned from 0 degrees to 360 degrees to find the maximum reading.
- e. The test-receiver system was set to Peak Detect Function and Specified Bandwidth with Maximum Hold Mode.
- f. If the emission level of the EUT in peak mode was 10 dB lower than the limit specified, then testing could be stopped and the peak values of the EUT would be reported. Otherwise the emissions that did not have 10 dB margin would be re-tested one by one using the quasi-peak method or average method as specified and then reported in Data sheet peak mode and QP mode.

NOTE:

1. The resolution bandwidth and video bandwidth of test receiver/spectrum analyzer is 120kHz for Quasi-peak detection at frequency below 1GHz.
2. The resolution bandwidth and video bandwidth of test receiver/spectrum analyzer is 1 MHz for Peak detection (PK) at frequency above 1GHz.
3. The resolution bandwidth of test receiver/spectrum analyzer is 1 MHz and the video bandwidth is 300 Hz for Average detection (AV) at frequency above 1GHz.

4.2.4 DEVIATION FROM TEST STANDARD

No deviation

4.2.5 TEST SETUP

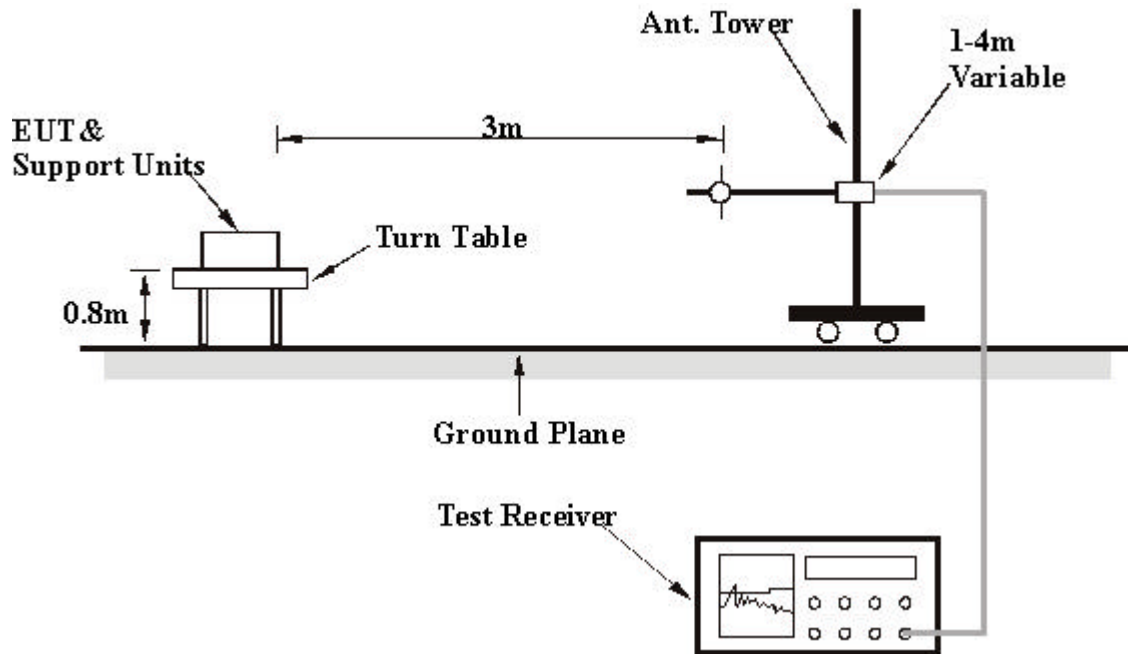

For the actual test configuration, please refer to the related item – Photographs of the Test Configuration.

4.2.6 EUT OPERATING CONDITIONS

Same as 4.1.6



4.2.7 TEST RESULTS (I)- ANTENNA 1

EUT	802.11a/b/g miniPCI module	MODEL	C38WCW
MODE	Channel 11	FREQUENCY RANGE	Below 1000 MHz
INPUT POWER (SYSTEM)	120Vac, 60Hz	DETECTOR FUNCTION	Quasi-Peak
ENVIRONMENTAL CONDITIONS	30deg. C, 59%RH, 965 hPa	TESTED BY	Eric Lee

ANTENNA POLARITY & TEST DISTANCE: HORIZONTAL AT 3 M

No.	Freq. (MHz)	Emission Level (dBuV/m)	Limit (dBuV/m)	Margin (dB)	Antenna Height (m)	Table Angle (Degree)	Raw Value (dBuV)	Correction Factor (dB/m)
1	125.04	24.1 QP	43.50	-19.40	1.27 H	8	12.00	12.00
2	250.16	22.3 QP	46.00	-23.70	1.11 H	18	9.30	13.00
3	307.74	27.7 QP	46.00	-18.30	1.17 H	162	13.30	14.30
4	308.45	27.9 QP	46.00	-18.10	1.51 H	0	13.50	14.40
5	351.94	28.6 QP	46.00	-17.40	1.05 H	88	13.10	15.50
6	375.02	26.4 QP	46.00	-19.60	1.55 H	103	10.20	16.20
7	480.03	29.9 QP	46.00	-16.10	1.88 H	254	11.10	18.90
8	500.16	31.5 QP	46.00	-14.50	1.04 H	81	12.20	19.30
9	572.13	30.7 QP	46.00	-15.30	1.88 H	9	9.40	21.30
10	704.00	31.2 QP	46.00	-14.80	1.03 H	106	8.60	22.60

ANTENNA POLARITY & TEST DISTANCE: VERTICAL AT 3 M

No.	Freq. (MHz)	Emission Level (dBuV/m)	Limit (dBuV/m)	Margin (dB)	Antenna Height (m)	Table Angle (Degree)	Raw Value (dBuV)	Correction Factor (dB/m)
1	45.25	34.4 QP	40.00	-5.60	1.63 V	25	23.30	11.10
2	125.02	27.7 QP	43.50	-15.80	1.44 V	52	15.70	12.00
3	208.93	22.5 QP	43.50	-21.00	1.08 V	70	13.70	8.90
4	208.99	24.1 QP	43.50	-19.40	1.32 V	10	15.20	8.90
5	352.12	27.9 QP	46.00	-18.10	1.45 V	214	12.40	15.50
6	416.03	32.9 QP	46.00	-13.10	1.59 V	353	15.30	17.70
7	440.11	28.0 QP	46.00	-18.00	1.52 V	111	10.00	18.00
8	480.13	32.5 QP	46.00	-13.50	1.08 V	218	13.60	18.90
9	500.02	34.6 QP	46.00	-11.40	1.40 V	209	15.30	19.30
10	625.09	35.0 QP	46.00	-11.00	1.68 V	24	13.20	21.70

- REMARKS:**
1. Emission level(dBuV/m)=Raw Value(dBuV) + Correction Factor(dB)
 2. Correction Factor(dB/m) = Antenna Factor (dB/m) + Cable Factor (dB)
 3. The other emission levels were very low against the limit.
 4. Margin value = Emission level – Limit value.
 5. The limit value is defined as per 15.247



TEST RESULTS (I)- Antenna 1, DSSS

EUT	802.11a/b/g miniPCI module	MODEL	C38WCW
MODE	Channel 1	FREQUENCY RANGE	Above 1000 MHz
INPUT POWER (SYSTEM)	120Vac, 60Hz	DETECTOR FUNCTION	Peak(PK) Average (AV)
ENVIRONMENTAL CONDITIONS	28deg. C, 69%RH, 965 hPa	TESTED BY	Eric Lee

ANTENNA POLARITY & TEST DISTANCE: HORIZONTAL AT 3 M

No.	Freq. (MHz)	Emission Level (dBuV/m)	Limit (dBuV/m)	Margin (dB)	Antenna Height (m)	Table Angle (Degree)	Raw Value (dBuV)	Correction Factor (dB/m)
1	2390.00	56.0 PK	74.00	-18.00	1.32 H	45	26.20	29.80
1	2390.00	44.1 AV	54.00	-9.90	1.32 H	45	14.30	29.80
2	*2412.00	104.9 PK			1.25 H	36	75.00	29.90
2	*2412.00	98.1 AV			1.25 H	36	68.20	29.90
3	2688.00	50.3 PK	74.00	-23.70	1.59 H	357	19.60	30.70
4	4824.00	54.1 PK	74.00	-19.90	1.75 H	168	17.80	36.20
4	4824.00	46.3 AV	54.00	-7.70	1.75 H	168	10.10	30.70
5	7236.00	50.8 PK	74.00	-23.20	1.54 H	252	9.20	41.70
6	9648.00	50.8 PK	74.00	-23.20	1.08 H	55	5.90	44.90

ANTENNA POLARITY & TEST DISTANCE: VERTICAL AT 3 M

No.	Freq. (MHz)	Emission Level (dBuV/m)	Limit (dBuV/m)	Margin (dB)	Antenna Height (m)	Table Angle (Degree)	Raw Value (dBuV)	Correction Factor (dB/m)
1	2390.00	60.1 PK	74.00	-13.90	1.05 V	55	30.30	29.80
1	2390.00	51.0 AV	54.00	-3.00	1.05 V	55	21.20	29.80
2	*2412.00	113.1 PK			1.25 V	24	83.20	29.90
2	*2412.00	107.7 AV			1.25 V	24	77.80	29.90
3	2688.00	55.2 PK	74.00	-18.80	1.05 V	78	24.50	30.70
3	2688.00	49.3 AV	54.00	-4.70	1.05 V	78	18.60	30.70
4	4824.00	56.6 PK	74.00	-17.40	1.32 V	10	20.40	36.20
4	4824.00	49.3 AV	54.00	-4.70	1.32 V	10	13.10	36.20
5	7236.00	50.9 PK	74.00	-23.10	1.02 V	356	9.30	41.70
6	9648.00	49.3 PK	74.00	-24.70	1.47 V	54	4.40	44.90

- NOTE:**
1. Emission level = Raw Value - Correction Factor
 2. Correction Factor = External Preamp. Gain - Ant. Factor - Cable loss
(External Preamp. Gain = 0, when the test receiver is used for the test.)
 3. The other emission levels were very low against the limit.
 4. Margin value = Emission level - Limit value
 5. The limit value is defined as per 15.247
 6. " * " : Fundamental frequency



EUT	802.11a/b/g miniPCI module	MODEL	C38WCW
MODE	Channel 6	FREQUENCY RANGE	Above 1000 MHz
INPUT POWER (SYSTEM)	120Vac, 60Hz	DETECTOR FUNCTION	Peak(PK) Average (AV)
ENVIRONMENTAL CONDITIONS	28deg. C, 69%RH, 965 hPa	TESTED BY	Eric Lee

ANTENNA POLARITY & TEST DISTANCE: HORIZONTAL AT 3 M								
No.	Freq. (MHz)	Emission Level (dBuV/m)	Limit (dBuV/m)	Margin (dB)	Antenna Height (m)	Table Angle (Degree)	Raw Value (dBuV)	Correction Factor (dB/m)
1	2390.00	55.2 PK	74.00	-18.80	1.56 H	325	25.40	29.80
1	2390.00	44.0 AV	54.00	-10.00	1.56 H	325	14.20	29.80
2	*2437.00	106.2 PK			1.54 H	24	76.20	30.00
2	*2437.00	96.2 AV			1.54 H	24	66.20	30.00
3	2483.50	54.7 PK	74.00	-19.30	1.37 H	54	24.60	30.10
3	2483.50	40.4 AV	54.00	-13.60	1.37 H	54	10.20	30.10
4	2688.00	50.9 PK	74.00	-23.10	1.59 H	63	20.20	30.70
5	4874.00	53.5 PK	74.00	-20.50	1.43 H	209	17.10	36.50
5	4874.00	46.9 AV	54.00	-7.10	1.43 H	209	10.40	30.70
6	7311.00	48.4 PK	74.00	-25.60	1.05 H	24	6.70	41.80
7	9748.00	49.9 PK	74.00	-24.10	1.65 H	39	5.30	44.60

ANTENNA POLARITY & TEST DISTANCE: VERTICAL AT 3 M								
No.	Freq. (MHz)	Emission Level (dBuV/m)	Limit (dBuV/m)	Margin (dB)	Antenna Height (m)	Table Angle (Degree)	Raw Value (dBuV)	Correction Factor (dB/m)
1	2390.00	58.2 PK	74.00	-15.80	1.59 V	65	28.40	29.80
1	2390.00	46.1 AV	54.00	-7.90	1.59 V	65	16.30	29.80
2	*2437.00	114.1 PK			1.08 V	54	84.10	30.00
2	*2437.00	106.9 AV			1.08 V	54	76.90	30.00
3	2483.50	56.7 PK	74.00	-17.30	1.14 V	9	26.60	30.10
3	2483.50	46.4 AV	54.00	-7.60	1.14 V	9	16.20	30.10
4	2688.00	55.3 PK	74.00	-18.70	1.56 V	35	24.60	30.70
4	2688.00	50.2 AV	54.00	-3.80	1.56 V	35	19.50	30.70
5	4874.00	58.0 PK	74.00	-16.00	1.26 V	353	21.60	36.50
5	4874.00	50.3 AV	54.00	-3.70	1.26 V	353	13.90	36.50
6	7311.00	48.4 PK	74.00	-25.60	1.55 V	268	6.70	41.80
7	9748.00	49.8 PK	74.00	-24.20	1.54 V	24	5.10	44.60

- NOTE:**
1. Emission level = Raw Value - Correction Factor
 2. Correction Factor = External Preamp. Gain - Ant. Factor - Cable loss
(External Preamp. Gain = 0, when the test receiver is used for the test.)
 3. The other emission levels were very low against the limit.
 4. Margin value = Emission level - Limit value
 5. The limit value is defined as per 15.247
 6. " * " : Fundamental frequency



EUT	802.11a/b/g miniPCI module	MODEL	C38WCW
MODE	Channel 11	FREQUENCY RANGE	Above 1000 MHz
INPUT POWER (SYSTEM)	120Vac, 60Hz	DETECTOR FUNCTION	Peak(PK) Average (AV)
ENVIRONMENTAL CONDITIONS	28deg. C, 69%RH, 965 hPa	TESTED BY	Eric Lee

ANTENNA POLARITY & TEST DISTANCE: HORIZONTAL AT 3M								
No.	Freq. (MHz)	Emission Level (dBuV/m)	Limit (dBuV/m)	Margin (dB)	Antenna Height (m)	Table Angle (Degree)	Raw Value (dBuV)	Correction Factor (dB/m)
1	*2462.00	103.2 PK			1.54 H	24	73.10	30.10
1	*2462.00	100.0 AV			1.54 H	24	69.90	30.10
2	2483.50	54.2 PK	74.00	-19.80	1.68 H	57	24.10	30.10
2	2483.50	43.4 AV	54.00	-10.60	1.68 H	57	13.30	30.10
3	2688.00	50.4 PK	74.00	-23.60	1.20 H	55	19.70	30.70
4	4924.00	55.8 PK	74.00	-18.20	1.02 H	325	19.10	36.70
4	4924.00	46.2 AV	54.00	-7.80	1.02 H	325	9.50	30.70
5	7386.00	47.6 PK	74.00	-26.40	1.47 H	357	5.80	41.80
6	9848.00	49.8 PK	74.00	-24.20	1.51 H	242	5.40	44.40

ANTENNA POLARITY & TEST DISTANCE: VERTICAL AT 3M								
No.	Freq. (MHz)	Emission Level (dBuV/m)	Limit (dBuV/m)	Margin (dB)	Antenna Height (m)	Table Angle (Degree)	Raw Value (dBuV)	Correction Factor (dB/m)
1	*2462.00	113.0 PK			1.65 V	352	82.90	30.10
1	*2462.00	106.7 AV			1.65 V	352	76.60	30.10
2	2483.50	59.7 PK	74.00	-14.30	1.52 V	4	29.60	30.10
2	2483.50	48.1 AV	54.00	-5.90	1.52 V	4	18.00	30.10
3	2688.00	55.1 PK	74.00	-18.90	1.22 V	235	24.40	30.70
3	2688.00	51.8 AV	54.00	-2.20	1.22 V	235	21.10	30.70
4	4924.00	58.2 PK	74.00	-15.80	1.04 V	59	21.50	36.70
4	4924.00	50.9 AV	54.00	-3.10	1.04 V	59	14.20	36.70
5	7386.00	51.3 PK	74.00	-22.70	1.07 V	49	9.50	41.80
5	7386.00	42.5 AV	54.00	-11.50	1.07 V	49	0.60	41.80
6	9848.00	49.4 PK	74.00	-24.60	1.07 V	66	5.00	44.40

- NOTE:**
1. Emission level= Raw Value - Correction Factor
 2. Correction Factor = External Preamp. Gain - Ant. Factor - Cable loss
(External Preamp. Gain = 0, when the test receiver is used for the test.)
 3. The other emission levels were very low against the limit.
 4. Margin value = Emission level - Limit value
 5. The limit value is defined as per 15.247
 6. " * " : Fundamental frequency



TEST RESULTS (I)- Antenna 1, OFDM

EUT	802.11a/b/g miniPCI module	MODEL	C38WCW
MODE	Channel 1	FREQUENCY RANGE	Above 1000 MHz
INPUT POWER (SYSTEM)	120Vac, 60Hz	DETECTOR FUNCTION	Peak(PK) Average (AV)
ENVIRONMENTAL CONDITIONS	28deg. C, 69%RH, 965 hPa	TESTED BY	Eric Lee

ANTENNA POLARITY & TEST DISTANCE: HORIZONTAL AT 3 M								
No.	Freq. (MHz)	Emission Level (dBuV/m)	Limit (dBuV/m)	Margin (dB)	Antenna Height (m)	Table Angle (Degree)	Raw Value (dBuV)	Correction Factor (dB/m)
1	2360.00	45.9 PK	74.00	-28.10	1.35 H	47	16.20	29.70
2	2390.00	55.7 PK	74.00	-18.30	1.52 H	247	25.90	29.80
2	2390.00	46.2 AV	54.00	-7.80	1.52 H	247	16.40	29.70
3	*2412.00	97.8 PK			1.23 H	80	67.90	29.90
3	*2412.00	90.9 AV			1.23 H	80	61.00	29.80
4	2688.00	49.3 PK	74.00	-24.70	1.57 H	58	18.60	30.70
5	4824.00	53.3 PK	74.00	-20.70	1.68 H	352	17.10	36.20
5	4824.00	44.6 AV	54.00	-9.40	1.68 H	352	8.30	29.90
6	7236.00	47.3 PK	74.00	-26.70	1.05 H	9	5.70	41.70
7	9648.00	50.9 PK	74.00	-23.10	1.39 H	247	6.00	44.90

ANTENNA POLARITY & TEST DISTANCE: VERTICAL AT 3 M								
No.	Freq. (MHz)	Emission Level (dBuV/m)	Limit (dBuV/m)	Margin (dB)	Antenna Height (m)	Table Angle (Degree)	Raw Value (dBuV)	Correction Factor (dB/m)
1	2360.00	52.7 PK	74.00	-21.30	1.44 V	277	23.00	29.70
1	2360.00	40.7 AV	54.00	-13.30	1.44 V	277	11.00	29.70
2	2390.00	60.3 PK	74.00	-13.70	1.41 V	205	30.50	29.80
2	2390.00	52.5 AV	54.00	-1.50	1.41 V	205	22.70	29.80
3	*2412.00	105.6 PK			1.27 V	325	75.70	29.90
3	*2412.00	98.8 AV			1.27 V	325	69.00	29.90
4	2688.00	54.2 PK	74.00	-19.80	1.08 V	54	23.50	30.70
4	2688.00	50.6 AV	54.00	-3.40	1.08 V	54	19.90	30.70
5	4824.00	58.3 PK	74.00	-15.70	1.23 V	21	22.10	36.20
5	4824.00	50.5 AV	54.00	-3.50	1.23 V	21	14.20	36.20
6	7236.00	50.9 PK	74.00	-23.10	1.25 V	36	9.30	41.70
7	9648.00	51.3 PK	74.00	-22.70	1.63 V	333	6.40	44.90
7	9648.00	40.5 AV	54.00	-13.50	1.63 V	333	-4.40	41.70

NOTE:

1. Emission level = Raw Value - Correction Factor
2. Correction Factor = External Preamp. Gain - Ant. Factor - Cable loss (External Preamp. Gain = 0, when the test receiver is used for the test.)
3. The other emission levels were very low against the limit.
4. Margin value = Emission level - Limit value
5. The limit value is defined as per 15.247
6. " * " : Fundamental frequency



EUT	802.11a/b/g miniPCI module	MODEL	C38WCW
MODE	Channel 6	FREQUENCY RANGE	Above 1000 MHz
INPUT POWER (SYSTEM)	120Vac, 60Hz	DETECTOR FUNCTION	Peak(PK) Average (AV)
ENVIRONMENTAL CONDITIONS	28deg. C, 69%RH, 965 hPa	TESTED BY	Eric Lee

ANTENNA POLARITY & TEST DISTANCE: HORIZONTAL AT 3 M								
No.	Freq. (MHz)	Emission Level (dBuV/m)	Limit (dBuV/m)	Margin (dB)	Antenna Height (m)	Table Angle (Degree)	Raw Value (dBuV)	Correction Factor (dB/m)
1	2390.00	54.0 PK	74.00	-20.00	1.46 H	356	24.20	29.80
1	2390.00	43.8 AV	54.00	-10.20	1.46 H	356	14.00	29.80
2	*2437.00	99.2 PK			1.39 H	165	69.30	30.00
2	*2437.00	90.3 AV			1.39 H	165	60.30	30.00
3	2483.50	52.2 PK	74.00	-21.80	1.55 H	246	22.10	30.10
3	2483.50	43.4 AV	54.00	-10.60	1.55 H	246	13.30	30.10
4	2688.00	48.9 PK	74.00	-25.10	1.08 H	54	18.20	30.70
5	4874.00	53.5 PK	74.00	-20.50	1.22 H	208	17.10	36.50
5	4874.00	45.6 AV	54.00	-8.40	1.22 H	208	9.10	30.70
6	7311.00	48.4 PK	74.00	-25.60	1.45 H	241	6.70	41.80
7	9748.00	49.9 PK	74.00	-24.10	1.53 H	326	5.30	44.60

ANTENNA POLARITY & TEST DISTANCE: VERTICAL AT 3 M								
No.	Freq. (MHz)	Emission Level (dBuV/m)	Limit (dBuV/m)	Margin (dB)	Antenna Height (m)	Table Angle (Degree)	Raw Value (dBuV)	Correction Factor (dB/m)
1	2390.00	56.4 PK	74.00	-17.60	1.54 V	24	26.60	29.80
1	2390.00	46.1 AV	54.00	-7.90	1.54 V	24	16.30	29.80
2	*2437.00	106.2 PK			1.26 V	326	76.20	30.00
2	*2437.00	99.2 AV			1.26 V	326	69.20	30.00
3	2483.50	56.5 PK	74.00	-17.50	1.54 V	2	26.40	30.10
3	2483.50	45.3 AV	54.00	-8.70	1.54 V	2	15.20	30.10
4	2688.00	55.2 PK	74.00	-18.80	1.05 V	35	24.50	30.70
4	2688.00	50.6 AV	54.00	-3.40	1.05 V	35	19.90	30.70
5	4874.00	60.0 PK	74.00	-14.00	1.30 V	23	23.60	36.50
5	4874.00	50.6 AV	54.00	-3.40	1.30 V	23	14.10	36.50
6	7311.00	51.0 PK	74.00	-23.00	1.45 V	245	9.30	41.80
6	7311.00	41.1 AV	54.00	-12.90	1.45 V	245	-0.70	41.80
7	9748.00	50.4 PK	74.00	-23.60	1.59 V	359	5.80	44.60

- NOTE:**
1. Emission level = Raw Value - Correction Factor
 2. Correction Factor = External Preamp. Gain - Ant. Factor - Cable loss
(External Preamp. Gain = 0, when the test receiver is used for the test.)
 3. The other emission levels were very low against the limit.
 4. Margin value = Emission level - Limit value
 5. The limit value is defined as per 15.247
 6. " * " : Fundamental frequency



EUT	802.11a/b/g miniPCI module	MODEL	C38WCW
MODE	Channel 11	FREQUENCY RANGE	Above 1000 MHz
INPUT POWER (SYSTEM)	120Vac, 60Hz	DETECTOR FUNCTION	Peak(PK) Average (AV)
ENVIRONMENTAL CONDITIONS	28deg. C, 69%RH, 965 hPa	TESTED BY	Eric Lee

ANTENNA POLARITY & TEST DISTANCE: HORIZONTAL AT 3M								
No.	Freq. (MHz)	Emission Level (dBuV/m)	Limit (dBuV/m)	Margin (dB)	Antenna Height (m)	Table Angle (Degree)	Raw Value (dBuV)	Correction Factor (dB/m)
1	*2462.00	97.3 PK			1.25 H	352	67.20	30.10
1	*2462.00	90.2 AV			1.25 H	352	60.10	30.10
2	2483.50	56.5 PK	74.00	-17.50	1.58 H	66	26.40	30.10
2	2483.50	46.3 AV	54.00	-7.70	1.58 H	66	16.20	30.10
3	2688.00	49.2 PK	74.00	-24.80	1.54 H	35	18.50	30.70
4	4924.00	50.8 PK	74.00	-23.20	1.14 H	88	14.10	36.70
5	7386.00	48.1 PK	74.00	-25.90	1.29 H	68	6.30	41.80
6	9848.00	49.3 PK	74.00	-24.70	1.59 H	207	4.90	44.40

ANTENNA POLARITY & TEST DISTANCE: VERTICAL AT 3M								
No.	Freq. (MHz)	Emission Level (dBuV/m)	Limit (dBuV/m)	Margin (dB)	Antenna Height (m)	Table Angle (Degree)	Raw Value (dBuV)	Correction Factor (dB/m)
1	*2462.00	106.4 PK			1.01 V	68	76.30	30.10
1	*2462.00	98.7 AV			1.01 V	68	68.60	30.10
2	2483.50	61.5 PK	74.00	-12.50	1.09 V	9	31.40	30.10
2	2483.50	52.6 AV	54.00	-1.40	1.09 V	9	22.50	30.10
3	2688.00	55.2 PK	74.00	-18.80	1.22 V	235	24.50	30.70
3	2688.00	51.4 AV	54.00	-2.60	1.22 V	235	20.70	30.70
4	4924.00	60.2 PK	74.00	-13.80	4.00 V	48	23.50	36.70
4	4924.00	51.0 AV	54.00	-3.00	4.00 V	48	14.30	36.70
5	7386.00	51.2 PK	74.00	-22.80	1.05 V	55	9.30	41.80
5	7386.00	38.3 AV	54.00	-15.70	1.05 V	55	-3.50	41.80
6	9848.00	50.2 PK	74.00	-23.80	1.54 V	269	5.90	44.40

- NOTE:**
1. Emission level= Raw Value - Correction Factor
 2. Correction Factor = External Preamp. Gain - Ant. Factor - Cable loss
(External Preamp. Gain = 0, when the test receiver is used for the test.)
 3. The other emission levels were very low against the limit.
 4. Margin value = Emission level - Limit value
 5. The limit value is defined as per 15.247
 6. " * " : Fundamental frequency



4.2.8 TEST RESULTS (II)- ANTENNA 2

EUT	802.11a/b/g miniPCI module	MODEL	C38WCW
MODE	Channel 11	FREQUENCY RANGE	Below 1000 MHz
INPUT POWER (SYSTEM)	120Vac, 60Hz	DETECTOR FUNCTION	Quasi-Peak
ENVIRONMENTAL CONDITIONS	30deg. C, 59%RH, 965 hPa	TESTED BY	Eric Lee

ANTENNA POLARITY & TEST DISTANCE: HORIZONTAL AT 3 M

No.	Freq. (MHz)	Emission Level (dBuV/m)	Limit (dBuV/m)	Margin (dB)	Antenna Height (m)	Table Angle (Degree)	Raw Value (dBuV)	Correction Factor (dB/m)
1	125.00	26.1 QP	43.50	-17.40	1.19 H	24	14.10	12.10
2	250.30	23.3 QP	46.00	-22.70	1.12 H	251	10.30	13.00
3	264.21	24.9 QP	46.00	-21.10	1.69 H	69	10.90	14.00
4	307.76	28.0 QP	46.00	-18.00	1.19 H	162	13.70	14.30
5	352.36	31.2 QP	46.00	-14.80	1.26 H	359	15.70	15.50
6	375.03	27.9 QP	46.00	-18.10	1.01 H	248	11.70	16.20
7	480.00	29.9 QP	46.00	-16.10	1.52 H	6	11.00	18.90
8	500.16	31.6 QP	46.00	-14.40	1.09 H	81	12.30	19.30
9	574.03	31.0 QP	46.00	-15.00	1.01 H	64	9.70	21.30
10	703.99	33.0 QP	46.00	-13.00	1.03 H	269	10.40	22.60

ANTENNA POLARITY & TEST DISTANCE: VERTICAL AT 3 M

No.	Freq. (MHz)	Emission Level (dBuV/m)	Limit (dBuV/m)	Margin (dB)	Antenna Height (m)	Table Angle (Degree)	Raw Value (dBuV)	Correction Factor (dB/m)
1	50.02	34.6 QP	40.00	-5.40	1.36 V	186	26.10	8.50
2	125.01	25.5 QP	43.50	-18.00	1.69 V	242	13.50	12.00
3	209.68	25.5 QP	43.50	-18.00	1.21 V	235	16.60	8.90
4	250.07	26.7 QP	46.00	-19.30	1.16 V	334	13.70	13.00
5	352.12	27.4 QP	46.00	-18.60	1.62 V	256	11.90	15.50
6	416.03	32.4 QP	46.00	-13.60	1.95 V	29	14.70	17.70
7	440.01	33.9 QP	46.00	-12.10	1.49 V	193	15.90	18.00
8	479.92	32.1 QP	46.00	-13.90	1.50 V	222	13.20	18.90
9	500.04	33.5 QP	46.00	-12.50	1.28 V	7	14.20	19.30
10	624.31	35.1 QP	46.00	-10.90	1.37 V	95	13.40	21.70

- REMARKS:**
1. Emission level(dBuV/m)=Raw Value(dBuV) + Correction Factor(dB)
 2. Correction Factor(dB/m) = Antenna Factor (dB/m) + Cable Factor (dB)
 3. The other emission levels were very low against the limit.
 4. Margin value = Emission level – Limit value.
 5. The limit value is defined as per 15.247



TEST RESULTS (II)- Antenna 2, DSSS

EUT	802.11a/b/g miniPCI module	MODEL	C38WCW
MODE	Channel 1	FREQUENCY RANGE	Above 1000 MHz
INPUT POWER (SYSTEM)	120Vac, 60Hz	DETECTOR FUNCTION	Peak(PK) Average (AV)
ENVIRONMENTAL CONDITIONS	26deg. C, 65%RH, 965 hPa	TESTED BY	Eric Lee

ANTENNA POLARITY & TEST DISTANCE: HORIZONTAL AT 3 M

No.	Freq. (MHz)	Emission Level (dBuV/m)	Limit (dBuV/m)	Margin (dB)	Antenna Height (m)	Table Angle (Degree)	Raw Value (dBuV)	Correction Factor (dB/m)
1	2390.00	59.0 PK	74.00	-15.00	1.45 H	215	28.60	30.40
1	2390.00	46.9 AV	54.00	-7.10	1.45 H	215	16.50	30.40
2	*2412.00	107.7 PK			1.54 H	74	77.20	30.50
2	*2412.00	100.1 AV			1.54 H	74	69.60	30.50
3	2688.00	42.6 PK	74.00	-31.40	1.36 H	69	11.40	31.30
4	4824.00	44.4 PK	74.00	-29.60	1.25 H	85	8.20	36.20
5	7236.00	45.4 PK	74.00	-28.60	1.59 H	357	3.80	41.70
6	9648.00	50.5 PK	74.00	-23.50	1.27 H	345	5.60	44.90

ANTENNA POLARITY & TEST DISTANCE: VERTICAL AT 3 M

No.	Freq. (MHz)	Emission Level (dBuV/m)	Limit (dBuV/m)	Margin (dB)	Antenna Height (m)	Table Angle (Degree)	Raw Value (dBuV)	Correction Factor (dB/m)
1	2390.00	63.0 PK	74.00	-11.00	1.54 V	21	32.60	30.40
1	2390.00	52.0 AV	54.00	-2.00	1.54 V	21	21.60	30.40
2	*2412.00	115.8 PK			1.25 V	96	85.30	30.50
2	*2412.00	108.6 AV			1.25 V	96	78.10	30.50
3	2688.00	51.2 PK	74.00	-22.80	1.23 V	130	20.00	31.30
3	2688.00	46.6 AV	54.00	-7.40	1.23 V	130	15.40	31.30
4	4824.00	49.4 PK	74.00	-24.60	1.54 V	247	13.20	36.20
5	7236.00	48.4 PK	74.00	-25.60	1.55 V	209	6.80	41.70
6	9648.00	52.3 PK	74.00	-21.70	1.39 V	6	7.40	44.90
6	9648.00	43.3 AV	54.00	-10.70	1.39 V	6	-1.60	36.20

- NOTE:**
1. Emission level = Raw Value - Correction Factor
 2. Correction Factor = External Preamp. Gain - Ant. Factor - Cable loss
(External Preamp. Gain = 0, when the test receiver is used for the test.)
 3. The other emission levels were very low against the limit.
 4. Margin value = Emission level - Limit value
 5. The limit value is defined as per 15.247
 6. " * " : Fundamental frequency



EUT	802.11a/b/g miniPCI module	MODEL	C38WCW
MODE	Channel 6	FREQUENCY RANGE	Above 1000 MHz
INPUT POWER (SYSTEM)	120Vac, 60Hz	DETECTOR FUNCTION	Peak(PK) Average (AV)
ENVIRONMENTAL CONDITIONS	26deg. C, 65%RH, 965 hPa	TESTED BY	Eric Lee

ANTENNA POLARITY & TEST DISTANCE: HORIZONTAL AT 3 M

No.	Freq. (MHz)	Emission Level (dBuV/m)	Limit (dBuV/m)	Margin (dB)	Antenna Height (m)	Table Angle (Degree)	Raw Value (dBuV)	Correction Factor (dB/m)
1	2390.00	55.0 PK	74.00	-19.00	1.06 H	326	24.60	30.40
1	2390.00	43.0 AV	54.00	-11.00	1.06 H	326	12.50	30.40
2	*2437.00	108.6 PK			1.59 H	62	77.90	30.70
2	*2437.00	101.3 AV			1.59 H	62	70.60	30.70
3	2483.50	54.6 PK	74.00	-19.40	1.23 H	51	23.60	31.00
3	2483.50	42.0 AV	54.00	-12.00	1.23 H	51	11.00	31.00
4	2688.00	41.9 PK	74.00	-32.10	1.04 H	56	10.70	31.30
5	4874.00	46.7 PK	74.00	-27.30	1.54 H	222	10.20	36.50
6	7311.00	47.4 PK	74.00	-26.60	1.08 H	78	5.60	41.80
7	9748.00	48.4 PK	74.00	-25.60	1.08 H	4	3.80	44.60

ANTENNA POLARITY & TEST DISTANCE: VERTICAL AT 3 M

No.	Freq. (MHz)	Emission Level (dBuV/m)	Limit (dBuV/m)	Margin (dB)	Antenna Height (m)	Table Angle (Degree)	Raw Value (dBuV)	Correction Factor (dB/m)
1	2390.00	60.0 PK	74.00	-14.00	1.25 V	84	29.60	30.40
1	2390.00	47.4 AV	54.00	-6.60	1.25 V	84	17.00	30.40
2	*2437.00	116.9 PK			1.26 V	100	86.30	30.70
2	*2437.00	108.9 AV			1.26 V	100	78.20	30.70
3	2483.50	57.5 PK	74.00	-16.50	1.52 V	360	26.60	31.00
3	2483.50	46.2 AV	54.00	-7.80	1.52 V	360	15.30	31.00
4	2688.00	49.9 PK	74.00	-24.10	1.26 V	54	18.70	31.30
5	4874.00	48.5 PK	74.00	-25.50	1.08 V	4	12.00	36.50
6	7311.00	51.0 PK	74.00	-23.00	1.52 V	147	9.20	41.80
6	7311.00	40.9 AV	54.00	-13.10	1.52 V	147	-0.90	31.30
7	9748.00	51.6 PK	74.00	-22.40	1.32 V	265	7.00	44.60
7	9748.00	42.7 AV	54.00	-11.30	1.32 V	265	-2.00	36.50

- NOTE:**
1. Emission level = Raw Value - Correction Factor
 2. Correction Factor = External Preamp. Gain - Ant. Factor - Cable loss
(External Preamp. Gain = 0, when the test receiver is used for the test.)
 3. The other emission levels were very low against the limit.
 4. Margin value = Emission level - Limit value
 5. The limit value is defined as per 15.247
 6. " * " : Fundamental frequency



EUT	802.11a/b/g miniPCI module	MODEL	C38WCW
MODE	Channel 11	FREQUENCY RANGE	Above 1000 MHz
INPUT POWER (SYSTEM)	120Vac, 60Hz	DETECTOR FUNCTION	Peak(PK) Average (AV)
ENVIRONMENTAL CONDITIONS	26deg. C, 65%RH, 965 hPa	TESTED BY	Eric Lee

ANTENNA POLARITY & TEST DISTANCE: HORIZONTAL AT 3M

No.	Freq. (MHz)	Emission Level (dBuV/m)	Limit (dBuV/m)	Margin (dB)	Antenna Height (m)	Table Angle (Degree)	Raw Value (dBuV)	Correction Factor (dB/m)
1	*2462.00	108.8 PK			1.84 H	269	78.00	30.80
1	*2462.00	101.0 AV			1.84 H	269	70.20	30.80
2	2483.50	59.5 PK	74.00	-14.50	1.38 H	360	28.50	31.00
2	2483.50	47.2 AV	54.00	-6.80	1.38 H	360	16.30	31.00
3	2688.00	42.3 PK	74.00	-31.70	1.25 H	344	11.00	31.30
4	4924.00	46.6 PK	74.00	-27.40	1.38 H	254	10.00	36.70
5	7386.00	47.4 PK	74.00	-26.60	1.25 H	245	5.60	41.80
6	9848.00	48.5 PK	74.00	-25.50	1.54 H	44	4.10	44.40

ANTENNA POLARITY & TEST DISTANCE: VERTICAL AT 3M

No.	Freq. (MHz)	Emission Level (dBuV/m)	Limit (dBuV/m)	Margin (dB)	Antenna Height (m)	Table Angle (Degree)	Raw Value (dBuV)	Correction Factor (dB/m)
1	*2462.00	117.3 PK			1.23 V	261	86.40	30.80
1	*2462.00	109.8 AV			1.23 V	261	79.00	30.80
2	2483.50	63.0 PK	74.00	-11.00	1.56 V	36	32.10	31.00
2	2483.50	52.2 AV	54.00	-1.80	1.56 V	36	21.20	31.00
3	2688.00	50.2 PK	74.00	-23.80	1.48 V	298	19.00	31.30
4	4924.00	50.0 PK	74.00	-24.00	1.41 V	54	13.30	36.70
5	7386.00	49.2 PK	74.00	-24.80	1.36 V	229	7.40	41.80
6	9848.00	51.1 PK	74.00	-22.90	1.55 V	132	6.70	44.40
6	9848.00	42.8 AV	54.00	-11.20	1.55 V	132	-1.60	31.30

- NOTE:**
1. Emission level= Raw Value - Correction Factor
 2. Correction Factor = External Preamp. Gain - Ant. Factor - Cable loss
(External Preamp. Gain = 0, when the test receiver is used for the test.)
 3. The other emission levels were very low against the limit.
 4. Margin value = Emission level - Limit value
 5. The limit value is defined as per 15.247
 6. " * " : Fundamental frequency



TEST RESULTS (II)- Antenna 2, OFDM

EUT	802.11a/b/g miniPCI module	MODEL	C38WCW
MODE	Channel 1	FREQUENCY RANGE	Above 1000 MHz
INPUT POWER (SYSTEM)	120Vac, 60Hz	DETECTOR FUNCTION	Peak(PK) Average (AV)
ENVIRONMENTAL CONDITIONS	26deg. C, 65%RH, 965 hPa	TESTED BY	Eric Lee

ANTENNA POLARITY & TEST DISTANCE: HORIZONTAL AT 3 M

No.	Freq. (MHz)	Emission Level (dBuV/m)	Limit (dBuV/m)	Margin (dB)	Antenna Height (m)	Table Angle (Degree)	Raw Value (dBuV)	Correction Factor (dB/m)
1	2390.00	58.3 PK	74.00	-15.70	1.25 H	356	27.80	30.40
1	2390.00	47.3 AV	54.00	-6.70	1.25 H	356	16.80	30.40
2	*2412.00	96.9 PK			1.25 H	254	66.30	30.50
2	*2412.00	90.2 AV			1.25 H	254	59.70	30.50
3	2688.00	42.6 PK	74.00	-31.40	1.52 H	213	11.40	31.30
4	4824.00	45.5 PK	74.00	-28.50	1.04 H	96	9.20	36.20
5	7236.00	47.9 PK	74.00	-26.10	1.38 H	295	6.20	41.70
6	9648.00	49.8 PK	74.00	-24.20	1.03 H	55	4.90	44.90

ANTENNA POLARITY & TEST DISTANCE: VERTICAL AT 3 M

No.	Freq. (MHz)	Emission Level (dBuV/m)	Limit (dBuV/m)	Margin (dB)	Antenna Height (m)	Table Angle (Degree)	Raw Value (dBuV)	Correction Factor (dB/m)
1	2390.00	62.1 PK	74.00	-11.90	1.45 V	265	31.70	30.40
1	2390.00	52.4 AV	54.00	-1.60	1.45 V	265	22.00	30.40
2	*2412.00	108.6 PK			1.01 V	127	78.10	30.50
2	*2412.00	101.0 AV			1.01 V	127	70.40	30.50
3	2688.00	46.6 PK	74.00	-27.40	1.01 V	97	15.30	31.30
4	4824.00	49.5 PK	74.00	-24.50	1.54 V	225	13.20	36.20
5	7236.00	51.2 PK	74.00	-22.80	1.64 V	266	9.50	41.70
5	7236.00	41.8 AV	54.00	-12.20	1.64 V	266	0.20	31.30
6	9648.00	50.9 PK	74.00	-23.10	1.36 V	266	6.00	44.90

- NOTE:**
1. Emission level = Raw Value - Correction Factor
 2. Correction Factor = External Preamp. Gain - Ant. Factor - Cable loss
(External Preamp. Gain = 0, when the test receiver is used for the test.)
 3. The other emission levels were very low against the limit.
 4. Margin value = Emission level - Limit value
 5. The limit value is defined as per 15.247
 6. " * " : Fundamental frequency



EUT	802.11a/b/g miniPCI module	MODEL	C38WCW
MODE	Channel 6	FREQUENCY RANGE	Above 1000 MHz
INPUT POWER (SYSTEM)	120Vac, 60Hz	DETECTOR FUNCTION	Peak(PK) Average (AV)
ENVIRONMENTAL CONDITIONS	26deg. C, 65%RH, 965 hPa	TESTED BY	Eric Lee

ANTENNA POLARITY & TEST DISTANCE: HORIZONTAL AT 3 M								
No.	Freq. (MHz)	Emission Level (dBuV/m)	Limit (dBuV/m)	Margin (dB)	Antenna Height (m)	Table Angle (Degree)	Raw Value (dBuV)	Correction Factor (dB/m)
1	2390.00	56.0 PK	74.00	-18.00	1.09 H	326	25.60	30.40
1	2390.00	43.0 AV	54.00	-11.00	1.09 H	326	12.50	30.40
2	*2437.00	96.7 PK			1.25 H	241	66.00	30.70
2	*2437.00	89.9 AV			1.25 H	241	59.20	30.70
3	2483.50	54.5 PK	74.00	-19.50	1.10 H	52	23.50	31.00
3	2483.50	42.3 AV	54.00	-11.70	1.10 H	52	11.30	31.00
4	2688.00	44.0 PK	74.00	-30.00	1.11 H	264	12.70	31.30
5	4874.00	48.2 PK	74.00	-25.80	1.18 H	76	11.70	36.50
6	7311.00	48.0 PK	74.00	-26.00	1.65 H	222	6.30	41.80
7	9748.00	49.9 PK	74.00	-24.10	1.03 H	229	5.30	44.60

ANTENNA POLARITY & TEST DISTANCE: VERTICAL AT 3 M								
No.	Freq. (MHz)	Emission Level (dBuV/m)	Limit (dBuV/m)	Margin (dB)	Antenna Height (m)	Table Angle (Degree)	Raw Value (dBuV)	Correction Factor (dB/m)
1	2390.00	58.8 PK	74.00	-15.20	1.25 V	24	28.40	30.40
1	2390.00	46.7 AV	54.00	-7.30	1.25 V	24	16.20	30.40
2	*2437.00	109.7 PK			1.01 V	230	79.00	30.70
2	*2437.00	101.6 AV			1.01 V	230	70.90	30.70
3	2483.50	57.7 PK	74.00	-16.30	1.30 V	6	26.70	31.00
3	2483.50	46.6 AV	54.00	-7.40	1.30 V	6	15.70	31.00
4	2688.00	45.7 PK	74.00	-28.30	1.25 V	226	14.50	31.30
5	4874.00	51.6 PK	74.00	-22.40	1.25 V	321	15.10	36.50
5	4874.00	43.7 AV	54.00	-10.30	1.25 V	321	7.30	31.30
6	7311.00	48.5 PK	74.00	-25.50	1.09 V	246	6.80	41.80
7	9748.00	51.6 PK	74.00	-22.40	1.55 V	265	7.00	44.60
7	9748.00	42.6 AV	54.00	-11.40	1.55 V	265	-2.00	36.50

- NOTE:**
1. Emission level = Raw Value - Correction Factor
 2. Correction Factor = External Preamp. Gain - Ant. Factor - Cable loss
(External Preamp. Gain = 0, when the test receiver is used for the test.)
 3. The other emission levels were very low against the limit.
 4. Margin value = Emission level - Limit value
 5. The limit value is defined as per 15.247
 6. " * " : Fundamental frequency



EUT	802.11a/b/g miniPCI module	MODEL	C38WCW
MODE	Channel 11	FREQUENCY RANGE	Above 1000 MHz
INPUT POWER (SYSTEM)	120Vac, 60Hz	DETECTOR FUNCTION	Peak(PK) Average (AV)
ENVIRONMENTAL CONDITIONS	26deg. C, 65%RH, 965 hPa	TESTED BY	Eric Lee

ANTENNA POLARITY & TEST DISTANCE: HORIZONTAL AT 3M								
No.	Freq. (MHz)	Emission Level (dBuV/m)	Limit (dBuV/m)	Margin (dB)	Antenna Height (m)	Table Angle (Degree)	Raw Value (dBuV)	Correction Factor (dB/m)
1	*2462.00	98.5 PK			1.56 H	254	67.60	30.80
1	*2462.00	89.5 AV			1.56 H	254	58.70	30.80
2	2483.50	59.6 PK	74.00	-14.40	1.54 H	254	28.60	31.00
2	2483.50	47.2 AV	54.00	-6.80	1.54 H	254	16.20	31.00
3	2688.00	42.2 PK	74.00	-31.80	1.06 H	326	11.00	31.30
4	4924.00	47.3 PK	74.00	-26.70	1.08 H	245	10.60	36.70
5	7386.00	46.2 PK	74.00	-27.80	1.20 H	54	4.40	41.80
6	9848.00	48.5 PK	74.00	-25.50	1.54 H	21	4.10	44.40

ANTENNA POLARITY & TEST DISTANCE: VERTICAL AT 3M								
No.	Freq. (MHz)	Emission Level (dBuV/m)	Limit (dBuV/m)	Margin (dB)	Antenna Height (m)	Table Angle (Degree)	Raw Value (dBuV)	Correction Factor (dB/m)
1	*2462.00	108.3 PK			1.01 V	184	77.50	30.80
1	*2462.00	100.4 AV			1.01 V	184	69.60	30.80
2	2483.50	62.3 PK	74.00	-11.70	1.25 V	24	31.40	31.00
2	2483.50	51.8 AV	54.00	-2.20	1.25 V	24	20.80	31.00
3	2688.00	46.6 PK	74.00	-27.40	1.02 V	130	15.40	31.30
4	4924.00	54.9 PK	74.00	-19.10	1.05 V	185	18.20	36.70
4	4924.00	44.9 AV	54.00	-9.10	1.05 V	185	8.20	31.30
5	7386.00	48.4 PK	74.00	-25.60	1.06 V	179	6.60	41.80
6	9848.00	52.2 PK	74.00	-21.80	1.10 V	182	7.80	44.40
6	9848.00	42.7 AV	54.00	-11.30	1.10 V	182	-1.70	36.70

- NOTE:**
1. Emission level= Raw Value - Correction Factor
 2. Correction Factor = External Preamp. Gain - Ant. Factor - Cable loss
(External Preamp. Gain = 0, when the test receiver is used for the test.)
 3. The other emission levels were very low against the limit.
 4. Margin value = Emission level - Limit value
 5. The limit value is defined as per 15.247
 6. " * " : Fundamental frequency



4.2.9 TEST RESULTS (III)- ANTENNA 3

EUT	802.11a/b/g miniPCI module	MODEL	C38WCW
MODE	Channel 11	FREQUENCY RANGE	Below 1000 MHz
INPUT POWER (SYSTEM)	120Vac, 60Hz	DETECTOR FUNCTION	Quasi-Peak
ENVIRONMENTAL CONDITIONS	30deg. C, 59%RH, 965 hPa	TESTED BY	Eric Lee

ANTENNA POLARITY & TEST DISTANCE: HORIZONTAL AT 3 M

No.	Freq. (MHz)	Emission Level (dBuV/m)	Limit (dBuV/m)	Margin (dB)	Antenna Height (m)	Table Angle (Degree)	Raw Value (dBuV)	Correction Factor (dB/m)
1	125.03	27.5 QP	43.50	-16.00	1.39 H	169	15.50	12.00
2	250.02	25.6 QP	46.00	-20.40	1.57 H	259	12.60	13.00
3	264.00	26.1 QP	46.00	-19.90	1.07 H	93	12.00	14.10
4	308.02	28.5 QP	46.00	-17.50	1.33 H	210	14.20	14.30
5	352.06	31.7 QP	46.00	-14.30	1.73 H	9	16.20	15.50
6	376.33	26.3 QP	46.00	-19.70	1.57 H	348	10.00	16.30
7	480.00	28.9 QP	46.00	-17.10	1.31 H	91	10.00	18.90
8	500.12	30.8 QP	46.00	-15.20	1.08 H	79	11.50	19.30
9	574.68	32.2 QP	46.00	-13.80	1.29 H	316	10.90	21.30
10	704.00	31.8 QP	46.00	-14.20	1.06 H	325	9.20	22.60

ANTENNA POLARITY & TEST DISTANCE: VERTICAL AT 3 M

No.	Freq. (MHz)	Emission Level (dBuV/m)	Limit (dBuV/m)	Margin (dB)	Antenna Height (m)	Table Angle (Degree)	Raw Value (dBuV)	Correction Factor (dB/m)
1	48.03	31.7 QP	40.00	-8.30	1.35 V	246	22.20	9.50
2	125.01	25.9 QP	43.50	-17.60	1.15 V	296	13.90	12.00
3	209.98	22.1 QP	43.50	-21.40	1.54 V	219	13.20	8.90
4	250.00	28.3 QP	46.00	-17.70	1.08 V	78	15.30	13.00
5	352.01	27.4 QP	46.00	-18.60	1.08 V	79	11.90	15.50
6	416.32	34.9 QP	46.00	-11.10	1.20 V	219	17.20	17.70
7	440.00	33.2 QP	46.00	-12.80	1.03 V	221	15.20	18.00
8	480.13	35.3 QP	46.00	-10.70	1.30 V	60	16.40	18.90
9	500.01	32.7 QP	46.00	-13.30	1.86 V	97	13.40	19.30
10	625.11	32.7 QP	46.00	-13.30	1.54 V	231	11.00	21.70

- REMARKS:**
1. Emission level(dBuV/m)=Raw Value(dBuV) + Correction Factor(dB)
 2. Correction Factor(dB/m) = Antenna Factor (dB/m) + Cable Factor (dB)
 3. The other emission levels were very low against the limit.
 4. Margin value = Emission level – Limit value.
 5. The limit value is defined as per 15.247



TEST RESULTS (III)- Antenna 3, DSSS

EUT	802.11a/b/g miniPCI module	MODEL	C38WCW
MODE	Channel 1	FREQUENCY RANGE	Above 1000 MHz
INPUT POWER (SYSTEM)	120Vac, 60Hz	DETECTOR FUNCTION	Peak(PK) Average (AV)
ENVIRONMENTAL CONDITIONS	26deg. C, 65%RH, 965 hPa	TESTED BY	Eric Lee

ANTENNA POLARITY & TEST DISTANCE: HORIZONTAL AT 3 M

No.	Freq. (MHz)	Emission Level (dBuV/m)	Limit (dBuV/m)	Margin (dB)	Antenna Height (m)	Table Angle (Degree)	Raw Value (dBuV)	Correction Factor (dB/m)
1	2390.00	55.6 PK	74.00	-18.40	1.08 H	54	25.20	30.40
1	2390.00	47.0 AV	54.00	-7.00	1.08 H	54	16.60	30.40
2	*2412.00	99.7 PK			1.25 H	41	69.20	30.50
2	*2412.00	92.7 AV			1.25 H	41	62.20	30.50
3	2688.00	47.0 PK	74.00	-27.00	1.65 H	249	15.70	31.30
4	4824.00	47.6 PK	74.00	-26.40	1.05 H	9	11.40	36.20
5	7236.00	48.5 PK	74.00	-25.50	1.14 H	254	6.80	41.70
6	9648.00	52.2 PK	74.00	-21.80	1.00 H	2	7.30	44.90
6	9648.00	41.1 AV	54.00	-12.90	1.00 H	2	-3.80	31.30

ANTENNA POLARITY & TEST DISTANCE: VERTICAL AT 3 M

No.	Freq. (MHz)	Emission Level (dBuV/m)	Limit (dBuV/m)	Margin (dB)	Antenna Height (m)	Table Angle (Degree)	Raw Value (dBuV)	Correction Factor (dB/m)
1	2390.00	64.0 PK	74.00	-10.00	1.20 V	214	33.60	30.40
1	2390.00	52.3 AV	54.00	-1.70	1.20 V	214	21.90	30.40
2	*2412.00	110.9 PK			1.01 V	179	80.30	30.50
2	*2412.00	103.2 AV			1.01 V	179	72.70	30.50
3	2688.00	55.9 PK	74.00	-18.10	1.54 V	55	24.60	31.30
3	2688.00	50.6 AV	54.00	-3.40	1.54 V	55	19.40	31.30
4	4824.00	57.5 PK	74.00	-16.50	1.54 V	201	21.20	36.20
4	4824.00	46.9 AV	54.00	-7.10	1.54 V	201	10.60	36.20
5	7236.00	51.8 PK	74.00	-22.20	1.20 V	145	10.10	41.70
5	7236.00	43.8 AV	54.00	-10.20	1.20 V	145	2.20	41.70
6	9648.00	53.2 PK	74.00	-20.80	1.41 V	68	8.30	44.90
6	9648.00	44.6 AV	54.00	-9.40	1.41 V	68	-0.30	44.90

- NOTE:**
1. Emission level = Raw Value - Correction Factor
 2. Correction Factor = External Preamp. Gain - Ant. Factor - Cable loss
(External Preamp. Gain = 0, when the test receiver is used for the test.)
 3. The other emission levels were very low against the limit.
 4. Margin value = Emission level - Limit value
 5. The limit value is defined as per 15.247
 6. " * " : Fundamental frequency



EUT	802.11a/b/g miniPCI module	MODEL	C38WCW
MODE	Channel 6	FREQUENCY RANGE	Above 1000 MHz
INPUT POWER (SYSTEM)	120Vac, 60Hz	DETECTOR FUNCTION	Peak(PK) Average (AV)
ENVIRONMENTAL CONDITIONS	26deg. C, 65%RH, 965 hPa	TESTED BY	Eric Lee

ANTENNA POLARITY & TEST DISTANCE: HORIZONTAL AT 3 M								
No.	Freq. (MHz)	Emission Level (dBuV/m)	Limit (dBuV/m)	Margin (dB)	Antenna Height (m)	Table Angle (Degree)	Raw Value (dBuV)	Correction Factor (dB/m)
1	2390.00	57.4 PK	74.00	-16.60	1.05 H	114	27.00	30.40
1	2390.00	44.7 AV	54.00	-9.30	1.05 H	114	14.30	30.40
2	*2437.00	99.2 PK			1.52 H	193	68.50	30.70
2	*2437.00	93.7 AV			1.52 H	193	63.00	30.70
3	2483.50	56.2 PK	74.00	-17.80	1.54 H	211	25.20	31.00
3	2483.50	43.5 AV	54.00	-10.50	1.54 H	211	12.60	31.00
4	2688.00	47.0 PK	74.00	-27.00	1.57 H	360	15.70	31.30
5	4874.00	47.8 PK	74.00	-26.20	1.20 H	241	11.30	36.50
6	7311.00	48.5 PK	74.00	-25.50	1.02 H	55	6.80	41.80
7	9748.00	49.6 PK	74.00	-24.40	1.62 H	209	5.00	44.60

ANTENNA POLARITY & TEST DISTANCE: VERTICAL AT 3 M								
No.	Freq. (MHz)	Emission Level (dBuV/m)	Limit (dBuV/m)	Margin (dB)	Antenna Height (m)	Table Angle (Degree)	Raw Value (dBuV)	Correction Factor (dB/m)
1	2390.00	58.7 PK	74.00	-15.30	1.00 V	54	28.20	30.40
1	2390.00	47.0 AV	54.00	-7.00	1.00 V	54	16.60	30.40
2	*2437.00	111.1 PK			1.09 V	187	80.40	30.70
2	*2437.00	103.3 AV			1.09 V	187	72.70	30.70
3	2483.50	60.6 PK	74.00	-13.40	1.03 V	355	29.60	31.00
3	2483.50	48.6 AV	54.00	-5.40	1.03 V	355	17.60	31.00
4	2688.00	56.8 PK	74.00	-17.20	1.39 V	61	25.60	31.30
4	2688.00	50.2 AV	54.00	-3.80	1.39 V	61	18.90	31.30
5	4874.00	58.1 PK	74.00	-15.90	1.02 V	346	21.60	36.50
5	4874.00	46.7 AV	54.00	-7.30	1.02 V	346	10.20	36.50
6	7311.00	51.5 PK	74.00	-22.50	1.08 V	214	9.80	41.80
6	7311.00	44.9 AV	54.00	-9.10	1.08 V	214	3.10	41.80
7	9748.00	52.9 PK	74.00	-21.10	1.08 V	213	8.30	44.60
7	9748.00	43.4 AV	54.00	-10.60	1.08 V	213	-1.20	44.60

- NOTE:**
1. Emission level = Raw Value - Correction Factor
 2. Correction Factor = External Preamp. Gain - Ant. Factor - Cable loss
(External Preamp. Gain = 0, when the test receiver is used for the test.)
 3. The other emission levels were very low against the limit.
 4. Margin value = Emission level - Limit value
 5. The limit value is defined as per 15.247
 6. " * " : Fundamental frequency



EUT	802.11a/b/g miniPCI module	MODEL	C38WCW
MODE	Channel 11	FREQUENCY RANGE	Above 1000 MHz
INPUT POWER (SYSTEM)	120Vac, 60Hz	DETECTOR FUNCTION	Peak(PK) Average (AV)
ENVIRONMENTAL CONDITIONS	26deg. C, 65%RH, 965 hPa	TESTED BY	Eric Lee

ANTENNA POLARITY & TEST DISTANCE: HORIZONTAL AT 3M

No.	Freq. (MHz)	Emission Level (dBuV/m)	Limit (dBuV/m)	Margin (dB)	Antenna Height (m)	Table Angle (Degree)	Raw Value (dBuV)	Correction Factor (dB/m)
1	*2462.00	107.5 PK			1.54 H	214	76.70	30.80
1	*2462.00	99.4 AV			1.54 H	214	68.50	30.80
2	2483.50	57.3 PK	74.00	-16.70	1.09 H	8	26.40	31.00
2	2483.50	46.2 AV	54.00	-7.80	1.09 H	8	15.30	31.00
3	2688.00	46.6 PK	74.00	-27.40	1.07 H	4	15.40	31.30
4	4924.00	47.3 PK	74.00	-26.70	1.32 H	360	10.70	36.70
5	7386.00	50.9 PK	74.00	-23.10	1.45 H	213	9.00	41.80
6	9848.00	49.7 PK	74.00	-24.30	1.54 H	24	5.40	44.40

ANTENNA POLARITY & TEST DISTANCE: VERTICAL AT 3M

No.	Freq. (MHz)	Emission Level (dBuV/m)	Limit (dBuV/m)	Margin (dB)	Antenna Height (m)	Table Angle (Degree)	Raw Value (dBuV)	Correction Factor (dB/m)
1	*2462.00	111.4 PK			1.10 V	181	80.60	30.80
1	*2462.00	104.0 AV			1.10 V	181	73.10	30.80
2	2483.50	63.5 PK	74.00	-10.50	1.54 V	214	32.50	31.00
2	2483.50	52.2 AV	54.00	-1.80	1.54 V	214	21.20	31.00
3	2688.00	48.9 PK	74.00	-25.10	1.54 V	24	17.60	31.30
4	4924.00	59.1 PK	74.00	-14.90	1.59 V	326	22.40	36.70
4	4924.00	47.6 AV	54.00	-6.40	1.59 V	326	10.90	31.30
5	7386.00	51.7 PK	74.00	-22.30	1.08 V	65	9.90	41.80
5	7386.00	43.8 AV	54.00	-10.20	1.08 V	65	2.00	36.70
6	9848.00	53.0 PK	74.00	-21.00	1.41 V	68	8.60	44.40
6	9848.00	44.4 AV	54.00	-9.60	1.41 V	68	0.00	41.80

- NOTE:**
1. Emission level= Raw Value - Correction Factor
 2. Correction Factor = External Preamp. Gain - Ant. Factor - Cable loss
(External Preamp. Gain = 0, when the test receiver is used for the test.)
 3. The other emission levels were very low against the limit.
 4. Margin value = Emission level - Limit value
 5. The limit value is defined as per 15.247
 6. " * " : Fundamental frequency



TEST RESULTS (III)- Antenna 3, OFDM

EUT	802.11a/b/g miniPCI module	MODEL	C38WCW
MODE	Channel 1	FREQUENCY RANGE	Above 1000 MHz
INPUT POWER (SYSTEM)	120Vac, 60Hz	DETECTOR FUNCTION	Peak(PK) Average (AV)
ENVIRONMENTAL CONDITIONS	26deg. C, 65%RH, 965 hPa	TESTED BY	Eric Lee

ANTENNA POLARITY & TEST DISTANCE: HORIZONTAL AT 3 M

No.	Freq. (MHz)	Emission Level (dBuV/m)	Limit (dBuV/m)	Margin (dB)	Antenna Height (m)	Table Angle (Degree)	Raw Value (dBuV)	Correction Factor (dB/m)
1	2390.00	59.7 PK	74.00	-14.30	1.32 H	269	29.30	30.40
1	2390.00	48.0 AV	54.00	-6.00	1.32 H	269	17.60	30.40
2	*2412.00	97.7 PK			1.35 H	222	67.10	30.50
2	*2412.00	90.7 AV			1.35 H	222	60.20	30.50
3	2688.00	46.3 PK	74.00	-27.70	1.45 H	22	15.00	31.30
4	4824.00	49.9 PK	74.00	-24.10	1.68 H	54	13.70	36.20
5	7236.00	50.2 PK	74.00	-23.80	1.36 H	6	8.50	41.70
6	9648.00	52.1 PK	74.00	-21.90	1.57 H	45	7.20	44.90
6	9648.00	42.4 AV	54.00	-11.60	1.57 H	45	-2.50	31.30

ANTENNA POLARITY & TEST DISTANCE: VERTICAL AT 3 M

No.	Freq. (MHz)	Emission Level (dBuV/m)	Limit (dBuV/m)	Margin (dB)	Antenna Height (m)	Table Angle (Degree)	Raw Value (dBuV)	Correction Factor (dB/m)
1	2390.00	63.0 PK	74.00	-11.00	1.01 V	222	32.60	30.40
1	2390.00	52.0 AV	54.00	-2.00	1.01 V	222	21.60	30.40
2	*2412.00	107.1 PK			1.09 V	102	76.60	30.50
2	*2412.00	98.9 AV			1.09 V	102	68.30	30.50
3	2688.00	55.8 PK	74.00	-18.20	1.02 V	254	24.60	31.30
3	2688.00	50.9 AV	54.00	-3.10	1.02 V	254	19.60	31.30
4	4824.00	54.5 PK	74.00	-19.50	1.07 V	253	18.20	36.20
4	4824.00	45.8 AV	54.00	-8.20	1.07 V	253	9.50	36.20
5	7236.00	51.2 PK	74.00	-22.80	1.07 V	248	9.50	41.70
5	7236.00	42.4 AV	54.00	-11.60	1.07 V	248	0.80	41.70
6	9648.00	53.1 PK	74.00	-20.90	1.35 V	244	8.20	44.90
6	9648.00	44.5 AV	54.00	-9.50	1.35 V	244	-0.40	44.90

- NOTE:**
1. Emission level = Raw Value - Correction Factor
 2. Correction Factor = External Preamp. Gain - Ant. Factor - Cable loss
(External Preamp. Gain = 0, when the test receiver is used for the test.)
 3. The other emission levels were very low against the limit.
 4. Margin value = Emission level - Limit value
 5. The limit value is defined as per 15.247
 6. " * " : Fundamental frequency



EUT	802.11a/b/g miniPCI module	MODEL	C38WCW
MODE	Channel 6	FREQUENCY RANGE	Above 1000 MHz
INPUT POWER (SYSTEM)	120Vac, 60Hz	DETECTOR FUNCTION	Peak(PK) Average (AV)
ENVIRONMENTAL CONDITIONS	26deg. C, 65%RH, 965 hPa	TESTED BY	Eric Lee

ANTENNA POLARITY & TEST DISTANCE: HORIZONTAL AT 3 M								
No.	Freq. (MHz)	Emission Level (dBuV/m)	Limit (dBuV/m)	Margin (dB)	Antenna Height (m)	Table Angle (Degree)	Raw Value (dBuV)	Correction Factor (dB/m)
1	2390.00	55.6 PK	74.00	-18.40	1.39 H	62	25.20	30.40
1	2390.00	43.4 AV	54.00	-10.60	1.39 H	62	13.00	30.40
2	*2437.00	99.1 PK			1.45 H	21	68.40	30.70
2	*2437.00	90.9 AV			1.45 H	21	60.20	30.70
3	2483.50	54.5 PK	74.00	-19.50	1.58 H	65	23.50	31.00
3	2483.50	43.3 AV	54.00	-10.70	1.58 H	65	12.30	31.00
4	2688.00	46.7 PK	74.00	-27.30	1.11 H	54	15.50	31.30
5	4874.00	47.8 PK	74.00	-26.20	1.63 H	332	11.30	36.50
6	7311.00	47.2 PK	74.00	-26.80	1.33 H	69	5.50	41.80
7	9848.00	48.5 PK	74.00	-25.50	1.52 H	41	4.10	44.40

ANTENNA POLARITY & TEST DISTANCE: VERTICAL AT 3 M								
No.	Freq. (MHz)	Emission Level (dBuV/m)	Limit (dBuV/m)	Margin (dB)	Antenna Height (m)	Table Angle (Degree)	Raw Value (dBuV)	Correction Factor (dB/m)
1	2390.00	59.7 PK	74.00	-14.30	1.06 V	241	29.20	30.40
1	2390.00	47.9 AV	54.00	-6.10	1.06 V	241	17.40	30.40
2	*2437.00	107.8 PK			1.06 V	190	77.20	30.70
2	*2437.00	99.2 AV			1.06 V	190	68.50	30.70
3	2483.50	58.4 PK	74.00	-15.60	1.09 V	264	27.50	31.00
3	2483.50	47.2 AV	54.00	-6.80	1.09 V	264	16.20	31.00
4	2688.00	46.8 PK	74.00	-27.20	1.12 V	214	15.50	31.30
5	4874.00	56.8 PK	74.00	-17.20	1.36 V	251	20.30	36.50
5	4874.00	46.4 AV	54.00	-7.60	1.36 V	251	10.00	31.30
6	7311.00	50.2 PK	74.00	-23.80	1.63 V	214	8.40	41.80
7	9748.00	53.2 PK	74.00	-20.80	1.56 V	22	8.60	44.60
7	9748.00	44.0 AV	54.00	-10.00	1.56 V	22	-0.70	36.50

- NOTE:**
1. Emission level = Raw Value - Correction Factor
 2. Correction Factor = External Preamp. Gain - Ant. Factor - Cable loss
(External Preamp. Gain = 0, when the test receiver is used for the test.)
 3. The other emission levels were very low against the limit.
 4. Margin value = Emission level - Limit value
 5. The limit value is defined as per 15.247
 6. " * " : Fundamental frequency



EUT	802.11a/b/g miniPCI module	MODEL	C38WCW
MODE	Channel 11	FREQUENCY RANGE	Above 1000 MHz
INPUT POWER (SYSTEM)	120Vac, 60Hz	DETECTOR FUNCTION	Peak(PK) Average (AV)
ENVIRONMENTAL CONDITIONS	26deg. C, 65%RH, 965 hPa	TESTED BY	Eric Lee

ANTENNA POLARITY & TEST DISTANCE: HORIZONTAL AT 3M

No.	Freq. (MHz)	Emission Level (dBuV/m)	Limit (dBuV/m)	Margin (dB)	Antenna Height (m)	Table Angle (Degree)	Raw Value (dBuV)	Correction Factor (dB/m)
1	*2462.00	102.0 PK			1.58 H	8	71.20	30.80
1	*2462.00	90.8 AV			1.58 H	8	60.00	30.80
2	2483.50	59.0 PK	74.00	-15.00	1.07 H	347	28.00	31.00
2	2483.50	47.2 AV	54.00	-6.80	1.07 H	347	16.20	31.00
3	2688.00	46.6 PK	74.00	-27.40	1.21 H	66	15.40	31.30
4	4924.00	48.0 PK	74.00	-26.00	1.30 H	322	11.30	36.70
5	7386.00	48.5 PK	74.00	-25.50	1.54 H	222	6.60	41.80
6	9848.00	48.8 PK	74.00	-25.20	1.68 H	52	4.50	44.40

ANTENNA POLARITY & TEST DISTANCE: VERTICAL AT 3M

No.	Freq. (MHz)	Emission Level (dBuV/m)	Limit (dBuV/m)	Margin (dB)	Antenna Height (m)	Table Angle (Degree)	Raw Value (dBuV)	Correction Factor (dB/m)
1	*2462.00	107.8 PK			1.01 V	180	77.00	30.80
1	*2462.00	99.7 AV			1.01 V	180	68.90	30.80
2	2483.50	63.5 PK	74.00	-10.50	1.20 V	32	32.50	31.00
2	2483.50	52.2 AV	54.00	-1.80	1.20 V	32	21.20	31.00
3	2688.00	56.9 PK	74.00	-17.10	1.57 V	54	25.60	31.30
3	2688.00	51.3 AV	54.00	-2.70	1.57 V	54	20.00	31.30
4	4924.00	58.0 PK	74.00	-16.00	1.36 V	254	21.40	36.70
4	4924.00	47.3 AV	54.00	-6.70	1.36 V	254	10.60	36.70
5	7386.00	51.6 PK	74.00	-22.40	1.40 V	21	9.70	41.80
5	7386.00	44.4 AV	54.00	-9.60	1.40 V	21	2.60	41.80
6	9848.00	52.8 PK	74.00	-21.20	1.00 V	321	8.50	44.40
6	9848.00	44.2 AV	54.00	-9.80	1.00 V	321	-0.20	44.40

- NOTE:**
1. Emission level= Raw Value - Correction Factor
 2. Correction Factor = External Preamp. Gain - Ant. Factor - Cable loss
(External Preamp. Gain = 0, when the test receiver is used for the test.)
 3. The other emission levels were very low against the limit.
 4. Margin value = Emission level - Limit value
 5. The limit value is defined as per 15.247
 6. " * " : Fundamental frequency



4.2.10 TEST RESULTS (IV)- ANTENNA 4

EUT	802.11a/b/g miniPCI module	MODEL	C38WCW
MODE	Channel 11	FREQUENCY RANGE	Below 1000 MHz
INPUT POWER (SYSTEM)	120Vac, 60Hz	DETECTOR FUNCTION	Quasi-Peak
ENVIRONMENTAL CONDITIONS	30deg. C, 59%RH, 965 hPa	TESTED BY	Eric Lee

ANTENNA POLARITY & TEST DISTANCE: HORIZONTAL AT 3 M

No.	Freq. (MHz)	Emission Level (dBuV/m)	Limit (dBuV/m)	Margin (dB)	Antenna Height (m)	Table Angle (Degree)	Raw Value (dBuV)	Correction Factor (dB/m)
1	125.20	25.7 QP	43.50	-17.80	1.45 H	100	13.70	12.00
2	250.06	25.6 QP	46.00	-20.40	1.58 H	54	12.60	13.00
3	308.01	22.5 QP	46.00	-23.50	1.02 H	65	8.20	14.30
4	352.31	25.8 QP	46.00	-20.20	1.39 H	7	10.30	15.50
5	374.59	28.2 QP	46.00	-17.80	1.00 H	4	12.00	16.20
6	440.02	27.1 QP	46.00	-18.90	1.09 H	169	9.10	18.00
7	480.03	29.9 QP	46.00	-16.10	1.88 H	254	11.10	18.90
8	500.16	31.5 QP	46.00	-14.50	1.04 H	81	12.20	19.30
9	572.13	30.7 QP	46.00	-15.30	1.88 H	9	9.40	21.30
10	624.56	29.9 QP	46.00	-16.10	1.68 H	152	8.20	21.70
11	704.00	31.2 QP	46.00	-14.80	1.03 H	106	8.60	22.60

ANTENNA POLARITY & TEST DISTANCE: VERTICAL AT 3 M

No.	Freq. (MHz)	Emission Level (dBuV/m)	Limit (dBuV/m)	Margin (dB)	Antenna Height (m)	Table Angle (Degree)	Raw Value (dBuV)	Correction Factor (dB/m)
1	50.00	31.6 QP	40.00	-8.40	1.60 V	360	23.10	8.50
2	125.12	25.6 QP	43.50	-17.90	1.09 V	241	13.60	12.00
3	208.99	23.3 QP	43.50	-20.20	1.45 V	344	14.50	8.90
4	249.66	29.2 QP	46.00	-16.80	1.59 V	49	16.20	13.00
5	308.02	21.4 QP	46.00	-24.60	1.00 V	66	7.10	14.30
6	352.04	27.2 QP	46.00	-18.80	1.62 V	254	11.70	15.50
7	396.03	24.2 QP	46.00	-21.80	1.36 V	49	7.20	17.00
8	415.99	31.2 QP	46.00	-14.80	1.59 V	240	13.60	17.70
9	440.21	28.0 QP	46.00	-18.00	2.00 V	321	10.00	18.00
10	480.01	31.1 QP	46.00	-14.90	1.46 V	231	12.20	18.90
11	501.01	30.9 QP	46.00	-15.10	1.02 V	54	11.60	19.30
12	625.00	34.9 QP	46.00	-11.10	1.09 V	66	13.20	21.70

- REMARKS:**
1. Emission level(dBuV/m)=Raw Value(dBuV) + Correction Factor(dB)
 2. Correction Factor(dB/m) = Antenna Factor (dB/m) + Cable Factor (dB)
 3. The other emission levels were very low against the limit.
 4. Margin value = Emission level – Limit value.
 5. The limit value is defined as per 15.247



TEST RESULTS (IV)- Antenna 4, DSSS

EUT	802.11a/b/g miniPCI module	MODEL	C38WCW
MODE	Channel 1	FREQUENCY RANGE	Above 1000 MHz
INPUT POWER (SYSTEM)	120Vac, 60Hz	DETECTOR FUNCTION	Peak(PK) Average (AV)
ENVIRONMENTAL CONDITIONS	26deg. C, 57%RH, 965 hPa	TESTED BY	Eric Lee

ANTENNA POLARITY & TEST DISTANCE: HORIZONTAL AT 3 M								
No.	Freq. (MHz)	Emission Level (dBuV/m)	Limit (dBuV/m)	Margin (dB)	Antenna Height (m)	Table Angle (Degree)	Raw Value (dBuV)	Correction Factor (dB/m)
1	2390.00	49.3 PK	74.00	-24.70	1.66 H	333	18.90	30.40
2	*2412.00	98.8 PK			1.25 H	2	68.30	30.50
2	*2412.00	89.5 AV			1.25 H	2	59.00	30.40
3	2688.00	45.0 PK	74.00	-29.00	1.59 H	247	13.70	31.30
4	4824.00	50.3 PK	74.00	-23.70	1.36 H	69	14.00	36.20
5	7236.00	44.2 PK	74.00	-29.80	1.01 H	24	2.50	41.70
6	9648.00	49.0 PK	74.00	-25.00	1.00 H	90	4.10	44.90

ANTENNA POLARITY & TEST DISTANCE: VERTICAL AT 3 M								
No.	Freq. (MHz)	Emission Level (dBuV/m)	Limit (dBuV/m)	Margin (dB)	Antenna Height (m)	Table Angle (Degree)	Raw Value (dBuV)	Correction Factor (dB/m)
1	2390.00	54.3 PK	74.00	-19.70	1.28 V	99	23.90	30.40
1	2390.00	43.7 AV	54.00	-10.30	1.28 V	99	13.30	30.40
2	*2412.00	105.5 PK			1.01 V	192	74.90	30.50
2	*2412.00	98.9 AV			1.01 V	192	68.30	30.50
3	2688.00	49.9 PK	74.00	-24.10	1.28 V	99	18.60	31.30
4	4824.00	60.3 PK	74.00	-13.70	1.01 V	274	24.00	36.20
4	4824.00	50.5 AV	54.00	-3.50	1.01 V	274	14.20	31.30
5	7236.00	47.8 PK	74.00	-26.20	1.46 V	293	6.10	41.70
6	9648.00	52.8 PK	74.00	-21.20	1.41 V	21	7.90	44.90
6	9648.00	42.3 AV	54.00	-11.70	1.41 V	21	-2.60	36.20

- NOTE:**
1. Emission level = Raw Value - Correction Factor
 2. Correction Factor = External Preamp. Gain - Ant. Factor - Cable loss
(External Preamp. Gain = 0, when the test receiver is used for the test.)
 3. The other emission levels were very low against the limit.
 4. Margin value = Emission level - Limit value
 5. The limit value is defined as per 15.247
 6. " * " : Fundamental frequency



EUT	802.11a/b/g miniPCI module	MODEL	C38WCW
MODE	Channel 6	FREQUENCY RANGE	Above 1000 MHz
INPUT POWER (SYSTEM)	120Vac, 60Hz	DETECTOR FUNCTION	Peak(PK) Average (AV)
ENVIRONMENTAL CONDITIONS	26deg. C, 57%RH, 965 hPa	TESTED BY	Eric Lee

ANTENNA POLARITY & TEST DISTANCE: HORIZONTAL AT 3 M

No.	Freq. (MHz)	Emission Level (dBuV/m)	Limit (dBuV/m)	Margin (dB)	Antenna Height (m)	Table Angle (Degree)	Raw Value (dBuV)	Correction Factor (dB/m)
1	2390.00	46.6 PK	74.00	-27.40	1.07 H	88	16.20	30.40
2	*2437.00	98.9 PK			1.25 H	326	68.20	30.70
2	*2437.00	90.9 AV			1.25 H	326	60.20	30.40
3	2483.50	46.9 PK	74.00	-27.10	1.54 H	246	16.00	31.00
4	2688.00	42.6 PK	74.00	-31.40	1.45 H	69	11.40	31.30
5	4874.00	55.4 PK	74.00	-18.60	1.08 H	59	18.90	36.50
5	4874.00	45.7 AV	54.00	-8.30	1.08 H	59	9.30	30.70
6	7311.00	44.4 PK	74.00	-29.60	1.28 H	87	2.60	41.80
7	9748.00	48.6 PK	74.00	-25.40	1.58 H	97	3.90	44.60

ANTENNA POLARITY & TEST DISTANCE: VERTICAL AT 3 M

No.	Freq. (MHz)	Emission Level (dBuV/m)	Limit (dBuV/m)	Margin (dB)	Antenna Height (m)	Table Angle (Degree)	Raw Value (dBuV)	Correction Factor (dB/m)
1	2390.00	51.9 PK	74.00	-22.10	1.36 V	66	21.40	30.40
1	2390.00	39.5 AV	54.00	-14.50	1.36 V	66	9.10	30.40
2	*2437.00	107.6 PK			1.06 V	168	76.90	30.70
2	*2437.00	100.5 AV			1.06 V	168	69.80	30.70
3	2483.50	51.6 PK	74.00	-22.40	1.54 V	21	20.70	31.00
3	2483.50	41.2 AV	54.00	-12.80	1.54 V	21	10.30	31.00
4	2688.00	50.2 PK	74.00	-23.80	1.16 V	323	18.90	31.30
5	4874.00	64.7 PK	74.00	-9.30	1.25 V	241	28.20	36.50
5	4874.00	51.5 AV	54.00	-2.50	1.25 V	241	15.00	31.30
6	7311.00	49.5 PK	74.00	-24.50	1.24 V	289	7.70	41.80
7	9748.00	53.1 PK	74.00	-20.90	1.52 V	247	8.40	44.60
7	9748.00	44.1 AV	54.00	-9.90	1.52 V	247	-0.60	36.50

- NOTE:**
1. Emission level = Raw Value - Correction Factor
 2. Correction Factor = External Preamp. Gain - Ant. Factor - Cable loss
(External Preamp. Gain = 0, when the test receiver is used for the test.)
 3. The other emission levels were very low against the limit.
 4. Margin value = Emission level - Limit value
 5. The limit value is defined as per 15.247
 6. " * " : Fundamental frequency



EUT	802.11a/b/g miniPCI module	MODEL	C38WCW
MODE	Channel 11	FREQUENCY RANGE	Above 1000 MHz
INPUT POWER (SYSTEM)	120Vac, 60Hz	DETECTOR FUNCTION	Peak(PK) Average (AV)
ENVIRONMENTAL CONDITIONS	26deg. C, 57%RH, 965 hPa	TESTED BY	Eric Lee

ANTENNA POLARITY & TEST DISTANCE: HORIZONTAL AT 3M

No.	Freq. (MHz)	Emission Level (dBuV/m)	Limit (dBuV/m)	Margin (dB)	Antenna Height (m)	Table Angle (Degree)	Raw Value (dBuV)	Correction Factor (dB/m)
1	*2462.00	89.2 PK			1.25 H	22	58.40	30.80
1	*2462.00	90.0 AV			1.25 H	22	59.20	30.80
2	2462.00	99.1 PK	74.00	25.10	1.69 H	66	68.20	30.80
2	2462.00	90.7 AV	54.00	36.70	1.69 H	66	59.90	30.80
3	2483.50	47.2 PK	74.00	-26.80	1.54 H	247	16.20	31.00
4	2687.00	41.6 PK	74.00	-32.40	1.00 H	20	10.40	31.30
5	4924.00	48.3 PK	74.00	-25.70	1.29 H	36	11.60	36.70
6	7386.00	45.4 PK	74.00	-28.60	1.20 H	7	3.50	41.80
7	9848.00	48.2 PK	74.00	-25.80	1.69 H	93	3.80	44.40

ANTENNA POLARITY & TEST DISTANCE: VERTICAL AT 3M

No.	Freq. (MHz)	Emission Level (dBuV/m)	Limit (dBuV/m)	Margin (dB)	Antenna Height (m)	Table Angle (Degree)	Raw Value (dBuV)	Correction Factor (dB/m)
1	*2462.00	107.0 PK			1.01 V	186	76.20	30.80
1	*2462.00	99.8 AV			1.01 V	186	69.00	30.80
2	2483.50	51.3 PK	74.00	-22.70	1.02 V	8	20.40	31.00
2	2483.50	41.2 AV	54.00	-12.80	1.02 V	8	10.30	31.00
3	2688.00	48.9 PK	74.00	-25.10	1.12 V	230	17.70	31.30
4	4924.00	60.1 PK	74.00	-13.90	1.39 V	248	23.40	36.70
4	4924.00	49.9 AV	54.00	-4.10	1.39 V	248	13.20	31.30
5	7386.00	48.4 PK	74.00	-25.60	1.02 V	44	6.60	41.80
6	9848.00	51.0 PK	74.00	-23.00	1.02 V	241	6.70	44.40
6	9848.00	42.4 AV	54.00	-11.60	1.02 V	241	-2.00	36.70

- NOTE:**
1. Emission level= Raw Value - Correction Factor
 2. Correction Factor = External Preamp. Gain - Ant. Factor - Cable loss
(External Preamp. Gain = 0, when the test receiver is used for the test.)
 3. The other emission levels were very low against the limit.
 4. Margin value = Emission level - Limit value
 5. The limit value is defined as per 15.247
 6. " * " : Fundamental frequency



TEST RESULTS (IV)- Antenna 4, OFDM

EUT	802.11a/b/g miniPCI module	MODEL	C38WCW
MODE	Channel 1	FREQUENCY RANGE	Above 1000 MHz
INPUT POWER (SYSTEM)	120Vac, 60Hz	DETECTOR FUNCTION	Peak(PK) Average (AV)
ENVIRONMENTAL CONDITIONS	26deg. C, 57%RH, 965 hPa	TESTED BY	Eric Lee

ANTENNA POLARITY & TEST DISTANCE: HORIZONTAL AT 3 M

No.	Freq. (MHz)	Emission Level (dBuV/m)	Limit (dBuV/m)	Margin (dB)	Antenna Height (m)	Table Angle (Degree)	Raw Value (dBuV)	Correction Factor (dB/m)
1	2390.00	52.0 PK	74.00	-22.00	1.47 H	54	21.60	30.40
1	2390.00	40.6 AV	54.00	-13.40	1.47 H	54	10.20	30.40
2	*2412.00	91.6 PK			1.20 H	142	61.10	30.50
2	*2412.00	84.8 AV			1.20 H	142	54.30	30.50
3	2688.00	44.7 PK	74.00	-29.30	1.24 H	21	13.40	31.30
4	4824.00	48.4 PK	74.00	-25.60	1.01 H	250	12.20	36.20
5	7236.00	44.3 PK	74.00	-29.70	1.02 H	360	2.70	41.70
6	9648.00	48.3 PK	74.00	-25.70	1.35 H	68	3.40	44.90

ANTENNA POLARITY & TEST DISTANCE: VERTICAL AT 3 M

No.	Freq. (MHz)	Emission Level (dBuV/m)	Limit (dBuV/m)	Margin (dB)	Antenna Height (m)	Table Angle (Degree)	Raw Value (dBuV)	Correction Factor (dB/m)
1	2390.00	56.2 PK	74.00	-17.80	1.00 V	175	25.80	30.40
1	2390.00	47.0 AV	54.00	-7.00	1.00 V	175	16.60	30.40
2	*2412.00	100.8 PK			1.00 V	166	70.20	30.50
2	*2412.00	92.4 AV			1.00 V	166	61.90	30.50
3	2687.00	48.4 PK	74.00	-25.60	1.00 V	175	17.10	31.30
4	4824.00	57.4 PK	74.00	-16.60	1.01 V	272	21.20	36.20
4	4824.00	45.3 AV	54.00	-8.70	1.01 V	272	9.10	31.30
5	7236.00	46.9 PK	74.00	-27.10	1.01 V	267	5.20	41.70
6	9648.00	48.3 PK	74.00	-25.70	1.01 V	264	3.40	44.90

- NOTE:**
1. Emission level = Raw Value - Correction Factor
 2. Correction Factor = External Preamp. Gain - Ant. Factor - Cable loss
(External Preamp. Gain = 0, when the test receiver is used for the test.)
 3. The other emission levels were very low against the limit.
 4. Margin value = Emission level - Limit value
 5. The limit value is defined as per 15.247
 6. " * " : Fundamental frequency



EUT	802.11a/b/g miniPCI module	MODEL	C38WCW
MODE	Channel 6	FREQUENCY RANGE	Above 1000 MHz
INPUT POWER (SYSTEM)	120Vac, 60Hz	DETECTOR FUNCTION	Peak(PK) Average (AV)
ENVIRONMENTAL CONDITIONS	26deg. C, 57%RH, 965 hPa	TESTED BY	Eric Lee

ANTENNA POLARITY & TEST DISTANCE: HORIZONTAL AT 3 M

No.	Freq. (MHz)	Emission Level (dBuV/m)	Limit (dBuV/m)	Margin (dB)	Antenna Height (m)	Table Angle (Degree)	Raw Value (dBuV)	Correction Factor (dB/m)
1	2390.00	51.5 PK	74.00	-22.50	1.02 H	1	21.10	30.40
1	2390.00	39.5 AV	54.00	-14.50	1.02 H	1	9.10	30.40
2	*2437.00	91.7 PK			1.13 H	165	61.00	30.70
2	*2437.00	84.0 AV			1.13 H	165	53.30	30.70
3	2483.50	50.6 PK	74.00	-23.40	1.35 H	99	19.60	31.00
4	2688.00	42.8 PK	74.00	-31.20	1.06 H	204	11.60	31.30
5	4874.00	49.2 PK	74.00	-24.80	1.01 H	256	12.70	36.50
6	7311.00	45.2 PK	74.00	-28.80	1.00 H	245	3.50	41.80
7	9748.00	48.8 PK	74.00	-25.20	1.35 H	26	4.10	44.60

ANTENNA POLARITY & TEST DISTANCE: VERTICAL AT 3 M

No.	Freq. (MHz)	Emission Level (dBuV/m)	Limit (dBuV/m)	Margin (dB)	Antenna Height (m)	Table Angle (Degree)	Raw Value (dBuV)	Correction Factor (dB/m)
1	2390.00	54.5 PK	74.00	-19.50	1.32 V	20	24.10	30.40
1	2390.00	45.6 AV	54.00	-8.40	1.32 V	20	15.20	30.40
2	*2437.00	102.3 PK			1.22 V	66	71.60	30.70
2	*2437.00	93.6 AV			1.22 V	66	62.90	30.70
3	2483.50	56.8 PK	74.00	-17.20	1.35 V	9	25.90	31.00
3	2483.50	45.0 AV	54.00	-9.00	1.35 V	9	14.10	31.00
4	2687.00	49.0 PK	74.00	-25.00	1.18 V	324	17.70	31.30
5	4874.00	56.5 PK	74.00	-17.50	1.03 V	247	20.00	36.50
5	4874.00	45.4 AV	54.00	-8.60	1.03 V	247	8.90	31.30
6	7311.00	47.4 PK	74.00	-26.60	1.01 V	214	5.70	41.80
7	9748.00	51.7 PK	74.00	-22.30	1.52 V	202	7.00	44.60
7	9748.00	41.7 AV	54.00	-12.30	1.52 V	202	-3.00	36.50

- NOTE:**
1. Emission level = Raw Value - Correction Factor
 2. Correction Factor = External Preamp. Gain - Ant. Factor - Cable loss
(External Preamp. Gain = 0, when the test receiver is used for the test.)
 3. The other emission levels were very low against the limit.
 4. Margin value = Emission level - Limit value
 5. The limit value is defined as per 15.247
 6. " * " : Fundamental frequency



EUT	802.11a/b/g miniPCI module	MODEL	C38WCW
MODE	Channel 11	FREQUENCY RANGE	Above 1000 MHz
INPUT POWER (SYSTEM)	120Vac, 60Hz	DETECTOR FUNCTION	Peak(PK) Average (AV)
ENVIRONMENTAL CONDITIONS	26deg. C, 57%RH, 965 hPa	TESTED BY	Eric Lee

ANTENNA POLARITY & TEST DISTANCE: HORIZONTAL AT 3M

No.	Freq. (MHz)	Emission Level (dBuV/m)	Limit (dBuV/m)	Margin (dB)	Antenna Height (m)	Table Angle (Degree)	Raw Value (dBuV)	Correction Factor (dB/m)
1	*2462.00	91.9 PK			1.06 H	172	61.10	30.80
1	*2462.00	84.1 AV			1.06 H	172	53.20	30.80
2	2483.50	52.6 PK	74.00	-21.40	1.11 H	8	21.70	31.00
2	2483.50	41.2 AV	54.00	-12.80	1.11 H	8	10.30	31.00
3	2688.00	43.8 PK	74.00	-30.20	1.08 H	210	12.60	31.30
4	4924.00	49.2 PK	74.00	-24.80	1.09 H	201	12.50	36.70
5	7386.00	44.6 PK	74.00	-29.40	1.01 H	222	2.70	41.80
6	9848.00	48.0 PK	74.00	-26.00	1.01 H	24	3.70	44.40

ANTENNA POLARITY & TEST DISTANCE: VERTICAL AT 3M

No.	Freq. (MHz)	Emission Level (dBuV/m)	Limit (dBuV/m)	Margin (dB)	Antenna Height (m)	Table Angle (Degree)	Raw Value (dBuV)	Correction Factor (dB/m)
1	*2462.00	101.4 PK			1.01 V	164	70.60	30.80
1	*2462.00	93.5 AV			1.01 V	164	62.70	30.80
2	2483.50	56.2 PK	74.00	-17.80	1.11 V	99	25.30	31.00
2	2483.50	47.2 AV	54.00	-6.80	1.11 V	99	16.30	31.00
3	2687.00	48.2 PK	74.00	-25.80	1.01 V	215	16.90	31.30
4	4924.00	54.9 PK	74.00	-19.10	1.02 V	222	18.20	36.70
4	4924.00	42.9 AV	54.00	-11.10	1.02 V	222	6.20	31.30
5	7386.00	45.3 PK	74.00	-28.70	1.02 V	21	3.40	41.80
6	9848.00	50.0 PK	74.00	-24.00	1.02 V	248	5.70	44.40

- NOTE:**
1. Emission level= Raw Value - Correction Factor
 2. Correction Factor = External Preamp. Gain - Ant. Factor - Cable loss
(External Preamp. Gain = 0, when the test receiver is used for the test.)
 3. The other emission levels were very low against the limit.
 4. Margin value = Emission level - Limit value
 5. The limit value is defined as per 15.247
 6. " * " : Fundamental frequency



4.2.11 TEST RESULTS (V)- ANTENNA 5

EUT	802.11a/b/g miniPCI module	MODEL	C38WCW
MODE	Channel 11	FREQUENCY RANGE	Below 1000 MHz
INPUT POWER (SYSTEM)	120Vac, 60Hz	DETECTOR FUNCTION	Quasi-Peak
ENVIRONMENTAL CONDITIONS	30deg. C, 59%RH, 965 hPa	TESTED BY	Eric Lee

ANTENNA POLARITY & TEST DISTANCE: HORIZONTAL AT 3 M

No.	Freq. (MHz)	Emission Level (dBuV/m)	Limit (dBuV/m)	Margin (dB)	Antenna Height (m)	Table Angle (Degree)	Raw Value (dBuV)	Correction Factor (dB/m)
1	125.12	27.9 QP	43.50	-15.60	1.36 H	63	15.90	12.00
2	250.98	25.0 QP	46.00	-21.00	1.76 H	98	11.90	13.10
3	264.06	25.8 QP	46.00	-20.20	1.67 H	213	11.70	14.10
4	308.00	27.6 QP	46.00	-18.40	1.18 H	162	13.30	14.30
5	352.00	27.4 QP	46.00	-18.60	1.37 H	41	11.90	15.50
6	376.83	25.4 QP	46.00	-20.60	1.52 H	19	9.10	16.30
7	480.10	28.8 QP	46.00	-17.20	1.43 H	309	9.90	18.90
8	500.05	31.6 QP	46.00	-14.40	1.04 H	54	12.30	19.30
9	574.03	31.4 QP	46.00	-14.60	1.07 H	49	10.10	21.30
10	704.00	31.5 QP	46.00	-14.50	1.05 H	119	8.90	22.60

ANTENNA POLARITY & TEST DISTANCE: VERTICAL AT 3 M

No.	Freq. (MHz)	Emission Level (dBuV/m)	Limit (dBuV/m)	Margin (dB)	Antenna Height (m)	Table Angle (Degree)	Raw Value (dBuV)	Correction Factor (dB/m)
1	48.12	33.7 QP	40.00	-6.30	1.54 V	214	24.20	9.50
2	125.20	24.9 QP	43.50	-18.60	1.70 V	59	12.90	12.00
3	210.32	24.7 QP	43.50	-18.80	1.19 V	20	15.80	8.90
4	250.00	27.6 QP	46.00	-18.40	1.38 V	78	14.60	13.00
5	352.04	28.1 QP	46.00	-17.90	1.22 V	54	12.60	15.50
6	416.01	33.7 QP	46.00	-12.30	1.02 V	54	16.00	17.70
7	439.92	32.2 QP	46.00	-13.80	1.31 V	99	14.20	18.00
8	480.21	34.6 QP	46.00	-11.40	1.82 V	310	15.70	18.90
9	500.00	31.8 QP	46.00	-14.20	1.59 V	64	12.50	19.30
10	625.10	32.1 QP	46.00	-13.90	1.52 V	23	10.40	21.70

- REMARKS:**
1. Emission level(dBuV/m)=Raw Value(dBuV) + Correction Factor(dB)
 2. Correction Factor(dB/m) = Antenna Factor (dB/m) + Cable Factor (dB)
 3. The other emission levels were very low against the limit.
 4. Margin value = Emission level – Limit value.
 5. The limit value is defined as per 15.247



TEST RESULTS (V)- Antenna 5, DSSS

EUT	802.11a/b/g miniPCI module	MODEL	C38WCW
MODE	Channel 1	FREQUENCY RANGE	Above 1000 MHz
INPUT POWER (SYSTEM)	120Vac, 60Hz	DETECTOR FUNCTION	Peak(PK) Average (AV)
ENVIRONMENTAL CONDITIONS	28deg. C, 69%RH, 965 hPa	TESTED BY	Eric Lee

ANTENNA POLARITY & TEST DISTANCE: HORIZONTAL AT 3 M

No.	Freq. (MHz)	Emission Level (dBuV/m)	Limit (dBuV/m)	Margin (dB)	Antenna Height (m)	Table Angle (Degree)	Raw Value (dBuV)	Correction Factor (dB/m)
1	2390.00	57.8 PK	74.00	-16.20	1.36 H	52	27.40	30.40
1	2390.00	47.1 AV	54.00	-6.90	1.36 H	52	16.70	30.40
2	*2412.00	104.8 PK			1.74 H	251	74.20	30.50
2	*2412.00	99.8 AV			1.74 H	251	69.30	30.50
3	2688.00	43.9 PK	74.00	-30.10	1.62 H	32	12.70	31.30
4	4824.00	49.0 PK	74.00	-25.00	1.54 H	214	12.80	36.20
5	7236.00	48.6 PK	74.00	-25.40	1.53 H	26	6.90	41.70
6	9648.00	50.5 PK	74.00	-23.50	1.06 H	66	5.60	44.90

ANTENNA POLARITY & TEST DISTANCE: VERTICAL AT 3 M

No.	Freq. (MHz)	Emission Level (dBuV/m)	Limit (dBuV/m)	Margin (dB)	Antenna Height (m)	Table Angle (Degree)	Raw Value (dBuV)	Correction Factor (dB/m)
1	2390.00	61.7 PK	74.00	-12.30	1.54 V	21	31.30	30.40
1	2390.00	52.0 AV	54.00	-2.00	1.54 V	21	21.60	30.40
2	*2412.00	111.5 PK			1.03 V	183	81.00	30.50
2	*2412.00	104.5 AV			1.03 V	183	73.90	30.50
3	2688.00	50.8 PK	74.00	-23.20	1.07 V	34	19.50	31.30
4	4824.00	50.8 PK	74.00	-23.20	1.54 V	247	14.50	36.20
5	7236.00	51.4 PK	74.00	-22.60	1.24 V	51	9.70	41.70
5	7236.00	41.4 AV	54.00	-12.60	1.24 V	51	-0.20	31.30
6	9648.00	52.2 PK	74.00	-21.80	1.29 V	326	7.30	44.90
6	9648.00	43.5 AV	54.00	-10.50	1.29 V	326	-1.40	36.20

- NOTE:**
1. Emission level = Raw Value - Correction Factor
 2. Correction Factor = External Preamp. Gain - Ant. Factor - Cable loss
(External Preamp. Gain = 0, when the test receiver is used for the test.)
 3. The other emission levels were very low against the limit.
 4. Margin value = Emission level - Limit value
 5. The limit value is defined as per 15.247
 6. " * " : Fundamental frequency



EUT	802.11a/b/g miniPCI module	MODEL	C38WCW
MODE	Channel 6	FREQUENCY RANGE	Above 1000 MHz
INPUT POWER (SYSTEM)	120Vac, 60Hz	DETECTOR FUNCTION	Peak(PK) Average (AV)
ENVIRONMENTAL CONDITIONS	28deg. C, 69%RH, 965 hPa	TESTED BY	Eric Lee

ANTENNA POLARITY & TEST DISTANCE: HORIZONTAL AT 3 M								
No.	Freq. (MHz)	Emission Level (dBuV/m)	Limit (dBuV/m)	Margin (dB)	Antenna Height (m)	Table Angle (Degree)	Raw Value (dBuV)	Correction Factor (dB/m)
1	2390.00	52.0 PK	74.00	-22.00	1.57 H	54	21.60	30.40
1	2390.00	42.5 AV	54.00	-11.50	1.57 H	54	12.10	30.40
2	*2437.00	107.7 PK			1.76 H	215	77.00	30.70
2	*2437.00	99.9 AV			1.76 H	215	69.20	30.70
3	2483.50	54.6 PK	74.00	-19.40	1.03 H	94	23.60	31.00
3	2483.50	42.5 AV	54.00	-11.50	1.03 H	94	11.50	31.00
4	2688.00	43.6 PK	74.00	-30.40	1.22 H	87	12.40	31.30
5	4874.00	47.8 PK	74.00	-26.20	1.68 H	54	11.30	36.50
6	7311.00	48.5 PK	74.00	-25.50	1.03 H	6	6.70	41.80
7	9748.00	49.1 PK	74.00	-24.90	1.53 H	325	4.40	44.60

ANTENNA POLARITY & TEST DISTANCE: VERTICAL AT 3 M								
No.	Freq. (MHz)	Emission Level (dBuV/m)	Limit (dBuV/m)	Margin (dB)	Antenna Height (m)	Table Angle (Degree)	Raw Value (dBuV)	Correction Factor (dB/m)
1	2390.00	58.1 PK	74.00	-15.90	4.00 V	69	27.70	30.40
1	2390.00	47.2 AV	54.00	-6.80	4.00 V	69	16.80	30.40
2	*2437.00	111.4 PK			1.01 V	191	80.70	30.70
2	*2437.00	103.6 AV			1.01 V	191	73.00	30.70
3	2483.50	59.0 PK	74.00	-15.00	1.11 V	5	28.00	31.00
3	2483.50	47.8 AV	54.00	-6.20	1.11 V	5	16.80	31.00
4	2688.00	50.6 PK	74.00	-23.40	1.52 V	320	19.40	31.30
5	4874.00	52.5 PK	74.00	-21.50	1.55 V	320	16.00	36.50
5	4874.00	45.1 AV	54.00	-8.90	1.55 V	320	8.60	31.30
6	7311.00	50.3 PK	74.00	-23.70	1.65 V	249	8.60	41.80
7	9748.00	52.8 PK	74.00	-21.20	1.68 V	326	8.10	44.60
7	9748.00	41.7 AV	54.00	-12.30	1.68 V	326	-3.00	36.50

- NOTE:**
1. Emission level = Raw Value - Correction Factor
 2. Correction Factor = External Preamp. Gain - Ant. Factor - Cable loss
(External Preamp. Gain = 0, when the test receiver is used for the test.)
 3. The other emission levels were very low against the limit.
 4. Margin value = Emission level - Limit value
 5. The limit value is defined as per 15.247
 6. " * " : Fundamental frequency



EUT	802.11a/b/g miniPCI module	MODEL	C38WCW
MODE	Channel 11	FREQUENCY RANGE	Above 1000 MHz
INPUT POWER (SYSTEM)	120Vac, 60Hz	DETECTOR FUNCTION	Peak(PK) Average (AV)
ENVIRONMENTAL CONDITIONS	28deg. C, 69%RH, 965 hPa	TESTED BY	Eric Lee

ANTENNA POLARITY & TEST DISTANCE: HORIZONTAL AT 3M

No.	Freq. (MHz)	Emission Level (dBuV/m)	Limit (dBuV/m)	Margin (dB)	Antenna Height (m)	Table Angle (Degree)	Raw Value (dBuV)	Correction Factor (dB/m)
1	*2462.00	107.7 PK			1.07 H	85	76.90	30.80
1	*2462.00	100.0 AV			1.07 H	85	69.20	30.80
2	2483.50	57.4 PK	74.00	-16.60	1.25 H	65	26.40	31.00
2	2483.50	46.6 AV	54.00	-7.40	1.25 H	65	15.70	31.00
3	2688.00	44.0 PK	74.00	-30.00	1.06 H	78	12.70	31.30
4	4924.00	46.7 PK	74.00	-27.30	1.12 H	5	10.00	36.70
5	7386.00	49.2 PK	74.00	-24.80	1.53 H	360	7.30	41.80
6	9848.00	47.3 PK	74.00	-26.70	1.42 H	10	3.00	44.40

ANTENNA POLARITY & TEST DISTANCE: VERTICAL AT 3M

No.	Freq. (MHz)	Emission Level (dBuV/m)	Limit (dBuV/m)	Margin (dB)	Antenna Height (m)	Table Angle (Degree)	Raw Value (dBuV)	Correction Factor (dB/m)
1	*2462.00	111.4 PK			1.09 V	185	80.60	30.80
1	*2462.00	103.9 AV			1.09 V	185	73.10	30.80
2	2483.50	62.4 PK	74.00	-11.60	1.52 V	320	31.40	31.00
2	2483.50	51.9 AV	54.00	-2.10	1.52 V	320	20.90	31.00
3	2688.00	51.8 PK	74.00	-22.20	1.54 V	245	20.60	31.30
3	2688.00	48.3 AV	54.00	-5.70	1.54 V	245	17.10	31.30
4	4924.00	52.3 PK	74.00	-21.70	1.36 V	52	15.60	36.70
4	4924.00	44.1 AV	54.00	-9.90	1.36 V	52	7.50	36.70
5	7386.00	50.4 PK	74.00	-23.60	1.64 V	5	8.50	41.80
6	9848.00	50.8 PK	74.00	-23.20	1.00 V	360	6.50	44.40

- NOTE:**
1. Emission level= Raw Value - Correction Factor
 2. Correction Factor = External Preamp. Gain - Ant. Factor - Cable loss
(External Preamp. Gain = 0, when the test receiver is used for the test.)
 3. The other emission levels were very low against the limit.
 4. Margin value = Emission level - Limit value
 5. The limit value is defined as per 15.247
 6. " * " : Fundamental frequency



TEST RESULTS (V)- Antenna 5, OFDM

EUT	802.11a/b/g miniPCI module	MODEL	C38WCW
MODE	Channel 1	FREQUENCY RANGE	Above 1000 MHz
INPUT POWER (SYSTEM)	120Vac, 60Hz	DETECTOR FUNCTION	Peak(PK) Average (AV)
ENVIRONMENTAL CONDITIONS	28deg. C, 69%RH, 965 hPa	TESTED BY	Eric Lee

ANTENNA POLARITY & TEST DISTANCE: HORIZONTAL AT 3 M

No.	Freq. (MHz)	Emission Level (dBuV/m)	Limit (dBuV/m)	Margin (dB)	Antenna Height (m)	Table Angle (Degree)	Raw Value (dBuV)	Correction Factor (dB/m)
1	2390.00	57.2 PK	74.00	-16.80	1.08 H	69	26.80	30.40
1	2390.00	46.1 AV	54.00	-7.90	1.08 H	69	15.70	30.40
2	*2412.00	97.7 PK			1.87 H	247	67.20	30.50
2	*2412.00	89.8 AV			1.87 H	247	59.30	30.50
3	2688.00	43.8 PK	74.00	-30.20	1.36 H	69	12.60	31.30
4	4824.00	47.2 PK	74.00	-26.80	1.32 H	5	11.00	36.20
5	7236.00	48.5 PK	74.00	-25.50	1.57 H	241	6.80	41.70
6	9648.00	50.0 PK	74.00	-24.00	1.00 H	210	5.10	44.90

ANTENNA POLARITY & TEST DISTANCE: VERTICAL AT 3 M

No.	Freq. (MHz)	Emission Level (dBuV/m)	Limit (dBuV/m)	Margin (dB)	Antenna Height (m)	Table Angle (Degree)	Raw Value (dBuV)	Correction Factor (dB/m)
1	2390.00	63.0 PK	74.00	-11.00	1.54 V	241	32.60	30.40
1	2390.00	52.7 AV	54.00	-1.30	1.54 V	241	22.30	30.40
2	*2412.00	106.7 PK			1.08 V	185	76.10	30.50
2	*2412.00	98.5 AV			1.08 V	185	68.00	30.50
3	2688.00	49.8 PK	74.00	-24.20	1.20 V	202	18.50	31.30
4	4824.00	51.3 PK	74.00	-22.70	1.25 V	24	15.00	36.20
4	4824.00	42.5 AV	54.00	-11.50	1.25 V	24	6.30	31.30
5	7236.00	48.4 PK	74.00	-25.60	1.59 V	326	6.80	41.70
6	9648.00	50.5 PK	74.00	-23.50	1.57 V	85	5.60	44.90

- NOTE:**
1. Emission level = Raw Value - Correction Factor
 2. Correction Factor = External Preamp. Gain - Ant. Factor - Cable loss
(External Preamp. Gain = 0, when the test receiver is used for the test.)
 3. The other emission levels were very low against the limit.
 4. Margin value = Emission level - Limit value
 5. The limit value is defined as per 15.247
 6. " * " : Fundamental frequency



EUT	802.11a/b/g miniPCI module	MODEL	C38WCW
MODE	Channel 6	FREQUENCY RANGE	Above 1000 MHz
INPUT POWER (SYSTEM)	120Vac, 60Hz	DETECTOR FUNCTION	Peak(PK) Average (AV)
ENVIRONMENTAL CONDITIONS	28deg. C, 69%RH, 965 hPa	TESTED BY	Eric Lee

ANTENNA POLARITY & TEST DISTANCE: HORIZONTAL AT 3 M								
No.	Freq. (MHz)	Emission Level (dBuV/m)	Limit (dBuV/m)	Margin (dB)	Antenna Height (m)	Table Angle (Degree)	Raw Value (dBuV)	Correction Factor (dB/m)
1	2390.00	55.6 PK	74.00	-18.40	1.58 H	223	25.10	30.40
1	2390.00	43.7 AV	54.00	-10.30	1.58 H	223	13.30	30.40
2	*2437.00	97.9 PK			1.79 H	242	67.20	30.70
2	*2437.00	88.9 AV			1.79 H	242	58.30	30.70
3	2483.50	57.3 PK	74.00	-16.70	1.25 H	24	26.30	31.00
3	2483.50	43.2 AV	54.00	-10.80	1.25 H	24	12.20	31.00
4	2688.00	43.8 PK	74.00	-30.20	1.08 H	78	12.60	31.30
5	4874.00	47.1 PK	74.00	-26.90	1.63 H	326	10.60	36.50
6	7311.00	47.5 PK	74.00	-26.50	1.96 H	326	5.70	41.80
7	9748.00	49.0 PK	74.00	-25.00	1.32 H	65	4.40	44.60

ANTENNA POLARITY & TEST DISTANCE: VERTICAL AT 3 M								
No.	Freq. (MHz)	Emission Level (dBuV/m)	Limit (dBuV/m)	Margin (dB)	Antenna Height (m)	Table Angle (Degree)	Raw Value (dBuV)	Correction Factor (dB/m)
1	2390.00	56.9 PK	74.00	-17.10	1.27 V	289	26.50	30.40
1	2390.00	45.3 AV	54.00	-8.70	1.27 V	289	14.90	30.40
2	*2437.00	106.8 PK			1.25 V	45	76.10	30.70
2	*2437.00	98.9 AV			1.25 V	45	68.20	30.70
3	2483.50	57.8 PK	74.00	-16.20	1.05 V	215	26.80	31.00
3	2483.50	47.3 AV	54.00	-6.70	1.05 V	215	16.40	31.00
4	2688.00	50.6 PK	74.00	-23.40	1.07 V	87	19.30	31.30
5	4874.00	49.5 PK	74.00	-24.50	1.08 V	74	13.00	36.50
6	7311.00	50.4 PK	74.00	-23.60	1.36 V	96	8.70	41.80
7	9748.00	51.6 PK	74.00	-22.40	1.32 V	123	7.00	44.60
7	9748.00	42.6 AV	54.00	-11.40	1.32 V	123	-2.00	31.30

- NOTE:**
1. Emission level = Raw Value - Correction Factor
 2. Correction Factor = External Preamp. Gain - Ant. Factor - Cable loss
(External Preamp. Gain = 0, when the test receiver is used for the test.)
 3. The other emission levels were very low against the limit.
 4. Margin value = Emission level - Limit value
 5. The limit value is defined as per 15.247
 6. " * " : Fundamental frequency



EUT	802.11a/b/g miniPCI module	MODEL	C38WCW
MODE	Channel 11	FREQUENCY RANGE	Above 1000 MHz
INPUT POWER (SYSTEM)	120Vac, 60Hz	DETECTOR FUNCTION	Peak(PK) Average (AV)
ENVIRONMENTAL CONDITIONS	28deg. C, 69%RH, 965 hPa	TESTED BY	Eric Lee

ANTENNA POLARITY & TEST DISTANCE: HORIZONTAL AT 3M

No.	Freq. (MHz)	Emission Level (dBuV/m)	Limit (dBuV/m)	Margin (dB)	Antenna Height (m)	Table Angle (Degree)	Raw Value (dBuV)	Correction Factor (dB/m)
1	*2462.00	97.9 PK			1.82 H	135	67.00	30.80
1	*2462.00	90.1 AV			1.82 H	135	59.20	30.80
2	2483.50	59.5 PK	74.00	-14.50	1.08 H	54	28.50	31.00
2	2483.50	47.2 AV	54.00	-6.80	1.08 H	54	16.20	31.00
3	2688.00	43.0 PK	74.00	-31.00	1.35 H	62	11.70	31.30
4	4924.00	48.3 PK	74.00	-25.70	1.42 H	222	11.60	36.70
5	7386.00	49.1 PK	74.00	-24.90	1.45 H	213	7.20	41.80
6	9848.00	48.4 PK	74.00	-25.60	1.06 H	2	4.00	44.40

ANTENNA POLARITY & TEST DISTANCE: VERTICAL AT 3M

No.	Freq. (MHz)	Emission Level (dBuV/m)	Limit (dBuV/m)	Margin (dB)	Antenna Height (m)	Table Angle (Degree)	Raw Value (dBuV)	Correction Factor (dB/m)
1	*2462.00	107.7 PK			1.08 V	103	76.90	30.80
1	*2462.00	99.1 AV			1.08 V	103	68.30	30.80
2	2483.50	63.0 PK	74.00	-11.00	1.00 V	25	32.00	31.00
2	2483.50	52.3 AV	54.00	-1.70	1.00 V	25	21.30	31.00
3	2688.00	50.7 PK	74.00	-23.30	1.24 V	54	19.50	31.30
4	4924.00	49.9 PK	74.00	-24.10	1.07 V	87	13.20	36.70
5	7386.00	50.9 PK	74.00	-23.10	1.35 V	42	9.00	41.80
6	9848.00	51.6 PK	74.00	-22.40	1.59 V	79	7.20	44.40
6	9848.00	42.1 AV	54.00	-11.90	1.59 V	79	-2.30	31.30

- NOTE:**
1. Emission level= Raw Value - Correction Factor
 2. Correction Factor = External Preamp. Gain - Ant. Factor - Cable loss
(External Preamp. Gain = 0, when the test receiver is used for the test.)
 3. The other emission levels were very low against the limit.
 4. Margin value = Emission level - Limit value
 5. The limit value is defined as per 15.247
 6. " * " : Fundamental frequency



4.2.12 TEST RESULTS (VI)- ANTENNA 7

EUT	802.11a/b/g miniPCI module	MODEL	C38WCW
MODE	Channel 11	FREQUENCY RANGE	Below 1000 MHz
INPUT POWER (SYSTEM)	120Vac, 60Hz	DETECTOR FUNCTION	Quasi-Peak
ENVIRONMENTAL CONDITIONS	30deg. C, 59%RH, 965 hPa	TESTED BY	Eric Lee

ANTENNA POLARITY & TEST DISTANCE: HORIZONTAL AT 3 M

No.	Freq. (MHz)	Emission Level (dBuV/m)	Limit (dBuV/m)	Margin (dB)	Antenna Height (m)	Table Angle (Degree)	Raw Value (dBuV)	Correction Factor (dB/m)
1	125.04	24.1 QP	43.50	-19.40	1.27 H	8	12.00	12.00
2	250.31	23.0 QP	46.00	-23.00	1.11 H	251	10.00	13.00
3	264.20	24.0 QP	46.00	-22.00	1.69 H	66	10.00	14.00
4	307.74	27.7 QP	46.00	-18.30	1.17 H	162	13.30	14.30
5	352.36	30.8 QP	46.00	-15.20	1.68 H	9	15.30	15.50
6	375.02	26.4 QP	46.00	-19.60	1.55 H	103	10.20	16.20
7	480.11	28.2 QP	46.00	-17.80	1.01 H	219	9.30	18.90
8	500.16	31.5 QP	46.00	-14.50	1.04 H	81	12.20	19.30
9	573.14	30.0 QP	46.00	-16.00	1.67 H	44	8.70	21.30
10	704.00	32.3 QP	46.00	-13.70	1.54 H	21	9.80	22.60

ANTENNA POLARITY & TEST DISTANCE: VERTICAL AT 3 M

No.	Freq. (MHz)	Emission Level (dBuV/m)	Limit (dBuV/m)	Margin (dB)	Antenna Height (m)	Table Angle (Degree)	Raw Value (dBuV)	Correction Factor (dB/m)
1	48.05	34.0 QP	40.00	-6.00	1.58 V	96	24.50	9.50
2	125.08	24.1 QP	43.50	-19.40	3.25 V	41	12.00	12.00
3	208.99	23.3 QP	43.50	-20.20	1.45 V	344	14.50	8.90
4	250.03	26.1 QP	46.00	-19.90	1.16 V	334	13.00	13.00
5	352.04	27.2 QP	46.00	-18.80	1.62 V	254	11.70	15.50
6	415.99	31.2 QP	46.00	-14.80	1.59 V	240	13.60	17.70
7	439.99	27.6 QP	46.00	-18.40	1.19 V	54	9.70	18.00
8	480.01	31.1 QP	46.00	-14.90	1.46 V	231	12.20	18.90
9	500.04	33.2 QP	46.00	-12.80	1.32 V	172	13.90	19.30
10	625.04	33.0 QP	46.00	-13.00	1.55 V	294	11.30	21.70

- REMARKS:**
1. Emission level(dBuV/m)=Raw Value(dBuV) + Correction Factor(dB)
 2. Correction Factor(dB/m) = Antenna Factor (dB/m) + Cable Factor (dB)
 3. The other emission levels were very low against the limit.
 4. Margin value = Emission level – Limit value.
 5. The limit value is defined as per 15.247



TEST RESULTS (VI)- Antenna 7, DSSS

EUT	802.11a/b/g miniPCI module	MODEL	C38WCW
MODE	Channel 1	FREQUENCY RANGE	Above 1000 MHz
INPUT POWER (SYSTEM)	120Vac, 60Hz	DETECTOR FUNCTION	Peak(PK) Average (AV)
ENVIRONMENTAL CONDITIONS	28deg. C, 69%RH, 965 hPa	TESTED BY	Eric Lee

ANTENNA POLARITY & TEST DISTANCE: HORIZONTAL AT 3 M

No.	Freq. (MHz)	Emission Level (dBuV/m)	Limit (dBuV/m)	Margin (dB)	Antenna Height (m)	Table Angle (Degree)	Raw Value (dBuV)	Correction Factor (dB/m)
1	2390.00	56.0 PK	74.00	-18.00	1.44 H	20	26.20	29.80
1	2390.00	45.0 AV	54.00	-9.00	1.44 H	20	15.20	29.80
2	*2412.00	105.1 PK			1.33 H	65	75.20	29.90
2	*2412.00	98.5 AV			1.33 H	65	68.70	29.90
3	2680.00	51.7 PK	74.00	-22.30	1.09 H	32	21.00	30.70
3	2680.00	43.4 AV	54.00	-10.60	1.09 H	32	12.70	30.70
4	4824.00	54.4 PK	74.00	-19.60	1.00 H	5	18.20	36.20
4	4824.00	46.2 AV	54.00	-7.80	1.00 H	5	10.00	36.20
5	7236.00	49.3 PK	74.00	-24.70	1.07 H	24	7.60	41.70
6	9648.00	47.5 PK	74.00	-26.50	1.63 H	25	2.60	44.90

ANTENNA POLARITY & TEST DISTANCE: VERTICAL AT 3 M

No.	Freq. (MHz)	Emission Level (dBuV/m)	Limit (dBuV/m)	Margin (dB)	Antenna Height (m)	Table Angle (Degree)	Raw Value (dBuV)	Correction Factor (dB/m)
1	2390.00	60.4 PK	74.00	-13.60	1.54 V	24	30.60	29.80
1	2390.00	50.1 AV	54.00	-3.90	1.54 V	24	20.30	29.80
2	*2412.00	113.4 PK			1.00 V	6	83.50	29.90
2	*2412.00	106.6 AV			1.00 V	6	76.70	29.90
3	2680.00	57.0 PK	74.00	-17.00	1.58 V	65	26.30	30.70
3	2680.00	50.4 AV	54.00	-3.60	1.58 V	65	19.70	30.70
4	4824.00	61.7 PK	74.00	-12.30	1.23 V	87	25.50	36.20
4	4824.00	50.4 AV	54.00	-3.60	1.23 V	87	14.20	36.20
5	7236.00	54.0 PK	74.00	-20.00	1.01 V	58	12.30	41.70
5	7236.00	45.0 AV	54.00	-9.00	1.01 V	58	3.40	41.70
6	9648.00	51.1 PK	74.00	-22.90	1.01 V	71	6.20	44.90
6	9648.00	39.9 AV	54.00	-14.10	1.01 V	71	-5.00	44.90

- NOTE:**
1. Emission level = Raw Value - Correction Factor
 2. Correction Factor = External Preamp. Gain - Ant. Factor - Cable loss
(External Preamp. Gain = 0, when the test receiver is used for the test.)
 3. The other emission levels were very low against the limit.
 4. Margin value = Emission level - Limit value
 5. The limit value is defined as per 15.247
 6. " * " : Fundamental frequency



EUT	802.11a/b/g miniPCI module	MODEL	C38WCW
MODE	Channel 6	FREQUENCY RANGE	Above 1000 MHz
INPUT POWER (SYSTEM)	120Vac, 60Hz	DETECTOR FUNCTION	Peak(PK) Average (AV)
ENVIRONMENTAL CONDITIONS	28deg. C, 69%RH, 965 hPa	TESTED BY	Eric Lee

ANTENNA POLARITY & TEST DISTANCE: HORIZONTAL AT 3 M								
No.	Freq. (MHz)	Emission Level (dBuV/m)	Limit (dBuV/m)	Margin (dB)	Antenna Height (m)	Table Angle (Degree)	Raw Value (dBuV)	Correction Factor (dB/m)
1	2390.00	49.0 PK	74.00	-25.00	1.40 H	15	19.20	29.80
2	*2437.00	106.2 PK			1.01 H	54	76.20	30.00
2	*2437.00	98.9 AV			1.01 H	54	68.90	29.80
3	2483.50	50.1 PK	74.00	-23.90	1.06 H	32	20.00	30.10
4	2680.00	52.7 PK	74.00	-21.30	1.20 H	58	22.00	30.70
4	2680.00	43.9 AV	54.00	-10.10	1.20 H	58	13.20	30.00
5	4874.00	55.1 PK	74.00	-18.90	1.07 H	57	18.60	36.50
5	4874.00	47.5 AV	54.00	-6.50	1.07 H	57	11.00	30.10
6	7311.00	50.1 PK	74.00	-23.90	1.65 H	10	8.30	41.80
7	9748.00	49.3 PK	74.00	-24.70	1.25 H	20	4.60	44.60

ANTENNA POLARITY & TEST DISTANCE: VERTICAL AT 3 M								
No.	Freq. (MHz)	Emission Level (dBuV/m)	Limit (dBuV/m)	Margin (dB)	Antenna Height (m)	Table Angle (Degree)	Raw Value (dBuV)	Correction Factor (dB/m)
1	2390.00	56.4 PK	74.00	-17.60	1.00 V	21	26.60	29.80
1	2390.00	45.0 AV	54.00	-9.00	1.00 V	21	15.20	29.80
2	*2437.00	114.0 PK			1.01 V	6	84.00	30.00
2	*2437.00	106.2 AV			1.01 V	6	76.20	30.00
3	2483.50	53.7 PK	74.00	-20.30	1.00 V	6	23.50	30.10
3	2483.50	43.3 AV	54.00	-10.70	1.00 V	6	13.20	30.10
4	2680.00	57.1 PK	74.00	-16.90	1.07 V	55	26.40	30.70
4	2680.00	50.6 AV	54.00	-3.40	1.07 V	55	19.90	30.70
5	4874.00	62.5 PK	74.00	-11.50	1.01 V	88	26.00	36.50
5	4874.00	51.5 AV	54.00	-2.50	1.01 V	88	15.00	36.50
6	7311.00	55.5 PK	74.00	-18.50	1.04 V	21	13.70	41.80
6	7311.00	45.7 AV	54.00	-8.30	1.04 V	21	3.90	41.80
7	9748.00	51.5 PK	74.00	-22.50	1.08 V	2	6.90	44.60
7	9748.00	40.4 AV	54.00	-13.60	1.08 V	2	-4.20	44.60

- NOTE:**
1. Emission level = Raw Value - Correction Factor
 2. Correction Factor = External Preamp. Gain - Ant. Factor - Cable loss
(External Preamp. Gain = 0, when the test receiver is used for the test.)
 3. The other emission levels were very low against the limit.
 4. Margin value = Emission level - Limit value
 5. The limit value is defined as per 15.247
 6. " * " : Fundamental frequency



EUT	802.11a/b/g miniPCI module	MODEL	C38WCW
MODE	Channel 11	FREQUENCY RANGE	Above 1000 MHz
INPUT POWER (SYSTEM)	120Vac, 60Hz	DETECTOR FUNCTION	Peak(PK) Average (AV)
ENVIRONMENTAL CONDITIONS	28deg. C, 69%RH, 965 hPa	TESTED BY	Eric Lee

ANTENNA POLARITY & TEST DISTANCE: HORIZONTAL AT 3M								
No.	Freq. (MHz)	Emission Level (dBuV/m)	Limit (dBuV/m)	Margin (dB)	Antenna Height (m)	Table Angle (Degree)	Raw Value (dBuV)	Correction Factor (dB/m)
1	*2462.00	106.4 PK			1.69 H	35	76.30	30.10
1	*2462.00	99.0 AV			1.69 H	35	68.90	30.10
2	2483.50	56.5 PK	74.00	-17.50	1.58 H	68	26.40	30.10
2	2483.50	44.3 AV	54.00	-9.70	1.58 H	68	14.20	30.10
3	2680.00	51.3 PK	74.00	-22.70	1.00 H	2	20.60	30.70
3	2680.00	41.9 AV	54.00	-12.10	1.00 H	2	11.20	30.70
4	4924.00	56.3 PK	74.00	-17.70	1.01 H	7	19.60	36.70
4	4924.00	47.7 AV	54.00	-6.30	1.01 H	7	11.00	36.70
5	7386.00	50.4 PK	74.00	-23.60	1.11 H	89	8.60	41.80
6	9848.00	47.4 PK	74.00	-26.60	1.11 H	216	3.00	44.40

ANTENNA POLARITY & TEST DISTANCE: VERTICAL AT 3M								
No.	Freq. (MHz)	Emission Level (dBuV/m)	Limit (dBuV/m)	Margin (dB)	Antenna Height (m)	Table Angle (Degree)	Raw Value (dBuV)	Correction Factor (dB/m)
1	*2462.00	114.0 PK			1.54 V	24	84.00	30.10
1	*2462.00	106.0 AV			1.54 V	24	75.90	30.10
2	2483.50	60.4 PK	74.00	-13.60	1.54 V	24	30.20	30.10
2	2483.50	50.5 AV	54.00	-3.50	1.54 V	24	20.40	30.10
3	2680.00	58.0 PK	74.00	-16.00	1.55 V	8	27.40	30.70
3	2680.00	50.3 AV	54.00	-3.70	1.55 V	8	19.60	30.70
4	4924.00	63.1 PK	74.00	-10.90	1.08 V	54	26.40	36.70
4	4924.00	51.9 AV	54.00	-2.10	1.08 V	54	15.20	36.70
5	7386.00	53.7 PK	74.00	-20.30	1.54 V	213	11.90	41.80
5	7386.00	45.7 AV	54.00	-8.30	1.54 V	213	3.90	41.80
6	9848.00	52.2 PK	74.00	-21.80	1.05 V	24	7.80	44.40
6	9848.00	40.7 AV	54.00	-13.30	1.05 V	24	-3.70	44.40

- NOTE:**
1. Emission level= Raw Value - Correction Factor
 2. Correction Factor = External Preamp. Gain - Ant. Factor - Cable loss
(External Preamp. Gain = 0, when the test receiver is used for the test.)
 3. The other emission levels were very low against the limit.
 4. Margin value = Emission level - Limit value
 5. The limit value is defined as per 15.247
 6. " * " : Fundamental frequency



TEST RESULTS (VI)- Antenna 7, OFDM

EUT	802.11a/b/g miniPCI module	MODEL	C38WCW
MODE	Channel 1	FREQUENCY RANGE	Above 1000 MHz
INPUT POWER (SYSTEM)	120Vac, 60Hz	DETECTOR FUNCTION	Peak(PK) Average (AV)
ENVIRONMENTAL CONDITIONS	28deg. C, 69%RH, 965 hPa	TESTED BY	Eric Lee

ANTENNA POLARITY & TEST DISTANCE: HORIZONTAL AT 3 M								
No.	Freq. (MHz)	Emission Level (dBuV/m)	Limit (dBuV/m)	Margin (dB)	Antenna Height (m)	Table Angle (Degree)	Raw Value (dBuV)	Correction Factor (dB/m)
1	2390.00	54.2 PK	74.00	-19.80	1.35 H	68	24.40	29.80
1	2390.00	45.0 AV	54.00	-9.00	1.35 H	68	15.20	29.80
2	*2412.00	96.5 PK			1.54 H	27	66.60	29.90
2	*2412.00	89.1 AV			1.54 H	27	59.20	29.90
3	2680.00	47.4 PK	74.00	-26.60	1.22 H	58	16.70	30.70
4	4824.00	52.4 PK	74.00	-21.60	1.68 H	242	16.20	36.20
4	4824.00	45.5 AV	54.00	-8.50	1.68 H	242	9.30	30.70
5	7236.00	46.3 PK	74.00	-27.70	1.02 H	353	4.70	41.70
6	9648.00	48.4 PK	74.00	-25.60	1.57 H	47	3.50	44.90

ANTENNA POLARITY & TEST DISTANCE: VERTICAL AT 3 M								
No.	Freq. (MHz)	Emission Level (dBuV/m)	Limit (dBuV/m)	Margin (dB)	Antenna Height (m)	Table Angle (Degree)	Raw Value (dBuV)	Correction Factor (dB/m)
1	2390.00	60.8 PK	74.00	-13.20	1.12 V	54	31.00	29.80
1	2390.00	52.1 AV	54.00	-1.90	1.12 V	54	22.30	29.80
2	*2412.00	105.8 PK			1.25 V	72	75.90	29.90
2	*2412.00	97.8 AV			1.25 V	72	67.90	29.90
3	2680.00	54.1 PK	74.00	-19.90	1.21 V	354	23.40	30.70
3	2680.00	48.9 AV	54.00	-5.10	1.21 V	354	18.20	30.70
4	4824.00	55.3 PK	74.00	-18.70	1.01 V	25	19.10	36.20
4	4824.00	47.3 AV	54.00	-6.70	1.01 V	25	11.10	36.20
5	7236.00	51.6 PK	74.00	-22.40	1.08 V	59	9.90	41.70
5	7236.00	39.8 AV	54.00	-14.20	1.08 V	59	-1.80	41.70
6	9648.00	50.6 PK	74.00	-23.40	1.10 V	35	5.70	44.90

- NOTE:**
1. Emission level = Raw Value - Correction Factor
 2. Correction Factor = External Preamp. Gain - Ant. Factor - Cable loss
(External Preamp. Gain = 0, when the test receiver is used for the test.)
 3. The other emission levels were very low against the limit.
 4. Margin value = Emission level - Limit value
 5. The limit value is defined as per 15.247
 6. " * " : Fundamental frequency



EUT	802.11a/b/g miniPCI module	MODEL	C38WCW
MODE	Channel 6	FREQUENCY RANGE	Above 1000 MHz
INPUT POWER (SYSTEM)	120Vac, 60Hz	DETECTOR FUNCTION	Peak(PK) Average (AV)
ENVIRONMENTAL CONDITIONS	28deg. C, 69%RH, 965 hPa	TESTED BY	Eric Lee

ANTENNA POLARITY & TEST DISTANCE: HORIZONTAL AT 3 M

No.	Freq. (MHz)	Emission Level (dBuV/m)	Limit (dBuV/m)	Margin (dB)	Antenna Height (m)	Table Angle (Degree)	Raw Value (dBuV)	Correction Factor (dB/m)
1	2390.00	50.0 PK	74.00	-24.00	1.58 H	323	20.10	29.80
2	*2437.00	97.0 PK			1.45 H	50	67.00	30.00
2	*2437.00	90.1 AV			1.45 H	50	60.10	29.80
3	2483.50	39.6 PK	74.00	-34.40	1.07 H	44	9.40	30.10
4	2680.00	48.3 PK	74.00	-25.70	1.02 H	263	17.60	30.70
5	4874.00	54.7 PK	74.00	-19.30	1.55 H	287	18.20	36.50
5	4874.00	46.8 AV	54.00	-7.20	1.55 H	287	10.30	30.00
6	7311.00	47.5 PK	74.00	-26.50	1.14 H	257	5.80	41.80
7	9748.00	48.8 PK	74.00	-25.20	1.39 H	64	4.10	44.60

ANTENNA POLARITY & TEST DISTANCE: VERTICAL AT 3 M

No.	Freq. (MHz)	Emission Level (dBuV/m)	Limit (dBuV/m)	Margin (dB)	Antenna Height (m)	Table Angle (Degree)	Raw Value (dBuV)	Correction Factor (dB/m)
1	2390.00	56.4 PK	74.00	-17.60	1.06 V	358	26.60	29.80
1	2390.00	45.0 AV	54.00	-9.00	1.06 V	358	15.20	29.80
2	*2437.00	106.2 PK			1.00 V	80	76.20	30.00
2	*2437.00	98.0 AV			1.00 V	80	68.00	30.00
3	2483.50	54.2 PK	74.00	-19.80	1.01 V	49	24.10	30.10
3	2483.50	43.4 AV	54.00	-10.60	1.01 V	49	13.30	30.10
4	2680.00	55.7 PK	74.00	-18.30	1.05 V	25	25.00	30.70
4	2680.00	48.3 AV	54.00	-5.70	1.05 V	25	17.60	30.70
5	4874.00	56.8 PK	74.00	-17.20	1.63 V	252	20.30	36.50
5	4874.00	46.8 AV	54.00	-7.20	1.63 V	252	10.30	36.50
6	7311.00	51.3 PK	74.00	-22.70	1.68 V	321	9.50	41.80
6	7311.00	40.2 AV	54.00	-13.80	1.68 V	321	-1.60	41.80
7	9748.00	50.7 PK	74.00	-23.30	1.05 V	246	6.10	44.60

- NOTE:**
1. Emission level = Raw Value - Correction Factor
 2. Correction Factor = External Preamp. Gain - Ant. Factor - Cable loss
(External Preamp. Gain = 0, when the test receiver is used for the test.)
 3. The other emission levels were very low against the limit.
 4. Margin value = Emission level - Limit value
 5. The limit value is defined as per 15.247
 6. " * " : Fundamental frequency



EUT	802.11a/b/g miniPCI module	MODEL	C38WCW
MODE	Channel 11	FREQUENCY RANGE	Above 1000 MHz
INPUT POWER (SYSTEM)	120Vac, 60Hz	DETECTOR FUNCTION	Peak(PK) Average (AV)
ENVIRONMENTAL CONDITIONS	28deg. C, 69%RH, 965 hPa	TESTED BY	Eric Lee

ANTENNA POLARITY & TEST DISTANCE: HORIZONTAL AT 3M								
No.	Freq. (MHz)	Emission Level (dBuV/m)	Limit (dBuV/m)	Margin (dB)	Antenna Height (m)	Table Angle (Degree)	Raw Value (dBuV)	Correction Factor (dB/m)
1	*2462.00	98.3 PK			1.21 H	54	68.20	30.10
1	*2462.00	91.3 AV			1.21 H	54	61.20	30.10
2	2483.50	57.0 PK	74.00	-17.00	1.50 H	233	26.90	30.10
2	2483.50	45.3 AV	54.00	-8.70	1.50 H	233	15.20	30.10
3	2680.00	49.3 PK	74.00	-24.70	1.35 H	249	18.60	30.70
4	4924.00	56.0 PK	74.00	-18.00	1.50 H	37	19.30	36.70
4	4924.00	46.9 AV	54.00	-7.10	1.50 H	37	10.20	30.70
5	7386.00	46.3 PK	74.00	-27.70	1.54 H	249	4.50	41.80
6	9848.00	48.2 PK	74.00	-25.80	1.11 H	5	3.90	44.40

ANTENNA POLARITY & TEST DISTANCE: VERTICAL AT 3M								
No.	Freq. (MHz)	Emission Level (dBuV/m)	Limit (dBuV/m)	Margin (dB)	Antenna Height (m)	Table Angle (Degree)	Raw Value (dBuV)	Correction Factor (dB/m)
1	*2462.00	105.3 PK			1.35 V	26	75.20	30.10
1	*2462.00	99.1 AV			1.35 V	26	69.00	30.10
2	2483.50	61.1 PK	74.00	-12.90	1.08 V	352	31.00	30.10
2	2483.50	52.4 AV	54.00	-1.60	1.08 V	352	22.30	30.10
3	2680.00	56.3 PK	74.00	-17.70	1.03 V	132	25.60	30.70
3	2680.00	49.7 AV	54.00	-4.30	1.03 V	132	19.00	30.70
4	4924.00	55.0 PK	74.00	-19.00	1.52 V	54	18.40	36.70
4	4924.00	47.9 AV	54.00	-6.10	1.52 V	54	11.20	36.70
5	7386.00	49.6 PK	74.00	-24.40	1.07 V	360	7.70	41.80
6	9848.00	50.0 PK	74.00	-24.00	1.76 V	63	5.60	44.40

- NOTE:**
1. Emission level= Raw Value - Correction Factor
 2. Correction Factor = External Preamp. Gain - Ant. Factor - Cable loss
(External Preamp. Gain = 0, when the test receiver is used for the test.)
 3. The other emission levels were very low against the limit.
 4. Margin value = Emission level - Limit value
 5. The limit value is defined as per 15.247
 6. " * " : Fundamental frequency



4.2.13 TEST RESULTS (VII)- ANTENNA 8

EUT	802.11a/b/g miniPCI module	MODEL	C38WCW
MODE	Channel 11	FREQUENCY RANGE	Below 1000 MHz
INPUT POWER (SYSTEM)	120Vac, 60Hz	DETECTOR FUNCTION	Quasi-Peak
ENVIRONMENTAL CONDITIONS	23deg. C, 57%RH, 965 hPa	TESTED BY	Eric Lee

ANTENNA POLARITY & TEST DISTANCE: HORIZONTAL AT 3 M

No.	Freq. (MHz)	Emission Level (dBuV/m)	Limit (dBuV/m)	Margin (dB)	Antenna Height (m)	Table Angle (Degree)	Raw Value (dBuV)	Correction Factor (dB/m)
1	125.20	25.9 QP	43.50	-17.60	2.00 H	236	13.90	12.00
2	250.00	24.2 QP	46.00	-21.80	1.42 H	209	11.20	13.00
3	264.37	25.7 QP	46.00	-20.30	1.62 H	326	11.70	14.00
4	307.96	28.2 QP	46.00	-17.80	1.11 H	52	13.90	14.30
5	352.15	32.4 QP	46.00	-13.60	1.79 H	1	16.90	15.50
6	375.00	25.2 QP	46.00	-20.80	1.16 H	98	9.00	16.20
7	480.13	29.4 QP	46.00	-16.60	1.54 H	29	10.50	18.90
8	500.11	33.6 QP	46.00	-12.40	1.50 H	82	14.30	19.30
9	574.00	30.2 QP	46.00	-15.80	1.36 H	26	8.90	21.30
10	704.01	33.2 QP	46.00	-12.80	1.54 H	213	10.60	22.60

ANTENNA POLARITY & TEST DISTANCE: VERTICAL AT 3 M

No.	Freq. (MHz)	Emission Level (dBuV/m)	Limit (dBuV/m)	Margin (dB)	Antenna Height (m)	Table Angle (Degree)	Raw Value (dBuV)	Correction Factor (dB/m)
1	46.75	33.3 QP	40.00	-6.70	1.52 V	359	23.00	10.30
2	125.11	24.3 QP	43.50	-19.20	1.52 V	24	12.30	12.00
3	208.99	25.8 QP	43.50	-17.70	1.74 V	21	16.90	8.90
4	250.23	28.7 QP	46.00	-17.30	1.30 V	69	15.60	13.00
5	352.12	27.6 QP	46.00	-18.40	1.07 V	89	12.10	15.50
6	416.01	31.9 QP	46.00	-14.10	1.55 V	54	14.20	17.70
7	440.00	29.9 QP	46.00	-16.10	1.79 V	213	11.90	18.00
8	481.00	32.1 QP	46.00	-13.90	1.58 V	9	13.20	18.90
9	500.14	34.2 QP	46.00	-11.80	1.30 V	212	14.90	19.30
10	625.23	34.0 QP	46.00	-12.00	1.47 V	85	12.30	21.70

- REMARKS:**
1. Emission level(dBuV/m)=Raw Value(dBuV) + Correction Factor(dB)
 2. Correction Factor(dB/m) = Antenna Factor (dB/m) + Cable Factor (dB)
 3. The other emission levels were very low against the limit.
 4. Margin value = Emission level – Limit value.
 5. The limit value is defined as per 15.247



TEST RESULTS (VII)- Antenna 8, DSSS

EUT	802.11a/b/g miniPCI module	MODEL	C38WCW
MODE	Channel 1	FREQUENCY RANGE	Above 1000 MHz
INPUT POWER (SYSTEM)	120Vac, 60Hz	DETECTOR FUNCTION	Peak(PK) Average (AV)
ENVIRONMENTAL CONDITIONS	23deg. C, 57%RH, 965 hPa	TESTED BY	Eric Lee

ANTENNA POLARITY & TEST DISTANCE: HORIZONTAL AT 3 M								
No.	Freq. (MHz)	Emission Level (dBuV/m)	Limit (dBuV/m)	Margin (dB)	Antenna Height (m)	Table Angle (Degree)	Raw Value (dBuV)	Correction Factor (dB/m)
1	2360.00	46.7 PK	74.00	-27.30	1.79 H	119	16.30	30.30
2	2390.00	51.4 PK	74.00	-22.60	1.58 H	360	21.00	30.40
2	2390.00	40.7 AV	54.00	-13.30	1.58 H	360	10.30	30.30
3	*2412.00	102.2 PK			1.65 H	24	71.70	30.50
3	*2412.00	96.9 AV			1.65 H	24	66.30	30.40
4	2688.00	45.8 PK	74.00	-28.20	1.05 H	64	14.60	31.30
5	4824.00	43.9 PK	74.00	-30.10	1.32 H	43	7.60	36.20
6	7236.00	43.5 PK	74.00	-30.50	1.73 H	193	1.80	41.70
7	9648.00	48.2 PK	74.00	-25.80	1.63 H	9	3.30	44.90

ANTENNA POLARITY & TEST DISTANCE: VERTICAL AT 3 M								
No.	Freq. (MHz)	Emission Level (dBuV/m)	Limit (dBuV/m)	Margin (dB)	Antenna Height (m)	Table Angle (Degree)	Raw Value (dBuV)	Correction Factor (dB/m)
1	2360.00	58.5 PK	74.00	-15.50	1.30 V	2	28.20	30.30
1	2360.00	46.6 AV	54.00	-7.40	1.30 V	2	16.20	30.30
2	2390.00	59.7 PK	74.00	-14.30	1.25 V	321	29.30	30.40
2	2390.00	47.7 AV	54.00	-6.30	1.25 V	321	17.20	30.40
3	*2412.00	110.5 PK			1.14 V	14	80.00	30.50
3	*2412.00	103.1 AV			1.14 V	14	72.60	30.50
4	2688.00	57.9 PK	74.00	-16.10	1.16 V	230	26.70	31.30
4	2688.00	51.0 AV	54.00	-3.00	1.16 V	230	19.80	31.30
5	4824.00	50.6 PK	74.00	-23.40	1.68 V	54	14.30	36.20
6	7236.00	50.5 PK	74.00	-23.50	1.52 V	241	8.80	41.70
7	9648.00	54.1 PK	74.00	-19.90	1.03 V	9	9.20	44.90
7	9648.00	44.3 AV	54.00	-9.70	1.03 V	9	-0.60	36.20

- NOTE:**
1. Emission level = Raw Value - Correction Factor
 2. Correction Factor = External Preamp. Gain - Ant. Factor - Cable loss
(External Preamp. Gain = 0, when the test receiver is used for the test.)
 3. The other emission levels were very low against the limit.
 4. Margin value = Emission level - Limit value
 5. The limit value is defined as per 15.247
 6. " * " : Fundamental frequency



EUT	802.11a/b/g miniPCI module	MODEL	C38WCW
MODE	Channel 6	FREQUENCY RANGE	Above 1000 MHz
INPUT POWER (SYSTEM)	120Vac, 60Hz	DETECTOR FUNCTION	Peak(PK) Average (AV)
ENVIRONMENTAL CONDITIONS	23deg. C, 57%RH, 965 hPa	TESTED BY	Eric Lee

ANTENNA POLARITY & TEST DISTANCE: HORIZONTAL AT 3 M

No.	Freq. (MHz)	Emission Level (dBuV/m)	Limit (dBuV/m)	Margin (dB)	Antenna Height (m)	Table Angle (Degree)	Raw Value (dBuV)	Correction Factor (dB/m)
1	2390.00	51.2 PK	74.00	-22.80	1.78 H	226	20.80	30.40
1	2390.00	38.6 AV	54.00	-15.40	1.78 H	226	8.20	30.40
2	*2437.00	101.7 PK			1.55 H	8	71.00	30.70
2	*2437.00	95.0 AV			1.55 H	8	64.30	30.70
3	2483.50	50.3 PK	74.00	-23.70	1.30 H	69	19.40	31.00
4	2688.00	44.9 PK	74.00	-29.10	1.02 H	21	13.70	31.30
5	4874.00	44.4 PK	74.00	-29.60	1.87 H	48	7.90	36.50
6	7311.00	42.2 PK	74.00	-31.80	1.02 H	14	0.50	41.80
7	9748.00	48.8 PK	74.00	-25.20	1.68 H	32	4.10	44.60

ANTENNA POLARITY & TEST DISTANCE: VERTICAL AT 3 M

No.	Freq. (MHz)	Emission Level (dBuV/m)	Limit (dBuV/m)	Margin (dB)	Antenna Height (m)	Table Angle (Degree)	Raw Value (dBuV)	Correction Factor (dB/m)
1	2390.00	55.8 PK	74.00	-18.20	1.36 V	62	25.40	30.40
1	2390.00	44.6 AV	54.00	-9.40	1.36 V	62	14.20	30.40
2	*2437.00	111.0 PK			1.15 V	20	80.30	30.70
2	*2437.00	103.0 AV			1.15 V	20	72.30	30.70
3	2483.50	55.3 PK	74.00	-18.70	1.39 V	3	24.40	31.00
3	2483.50	43.8 AV	54.00	-10.20	1.39 V	3	12.90	31.00
4	2688.00	56.3 PK	74.00	-17.70	1.61 V	326	25.00	31.30
4	2688.00	50.0 AV	54.00	-4.00	1.61 V	326	18.70	31.30
5	4874.00	49.0 PK	74.00	-25.00	1.53 V	219	12.50	36.50
6	7311.00	50.5 PK	74.00	-23.50	1.33 V	6	8.70	41.80
7	9748.00	53.7 PK	74.00	-20.30	1.25 V	321	9.10	44.60
7	9748.00	43.4 AV	54.00	-10.60	1.25 V	321	-1.20	36.50

- NOTE:**
1. Emission level = Raw Value - Correction Factor
 2. Correction Factor = External Preamp. Gain - Ant. Factor - Cable loss
(External Preamp. Gain = 0, when the test receiver is used for the test.)
 3. The other emission levels were very low against the limit.
 4. Margin value = Emission level - Limit value
 5. The limit value is defined as per 15.247
 6. " * " : Fundamental frequency



EUT	802.11a/b/g miniPCI module	MODEL	C38WCW
MODE	Channel 11	FREQUENCY RANGE	Above 1000 MHz
INPUT POWER (SYSTEM)	120Vac, 60Hz	DETECTOR FUNCTION	Peak(PK) Average (AV)
ENVIRONMENTAL CONDITIONS	23deg. C, 57%RH, 965 hPa	TESTED BY	Eric Lee

ANTENNA POLARITY & TEST DISTANCE: HORIZONTAL AT 3M								
No.	Freq. (MHz)	Emission Level (dBuV/m)	Limit (dBuV/m)	Margin (dB)	Antenna Height (m)	Table Angle (Degree)	Raw Value (dBuV)	Correction Factor (dB/m)
1	*2462.00	101.0 PK			1.57 H	214	70.20	30.80
1	*2462.00	95.8 AV			1.57 H	214	65.00	30.80
2	2483.50	53.2 PK	74.00	-20.80	1.03 H	22	22.20	31.00
2	2483.50	41.2 AV	54.00	-12.80	1.03 H	22	10.20	31.00
3	2688.00	44.0 PK	74.00	-30.00	1.68 H	9	12.80	31.30
4	4924.00	42.7 PK	74.00	-31.30	1.63 H	69	6.00	36.70
5	7386.00	41.8 PK	74.00	-32.20	1.25 H	14	0.00	41.80
6	9848.00	45.8 PK	74.00	-28.20	1.69 H	69	1.50	44.40

ANTENNA POLARITY & TEST DISTANCE: VERTICAL AT 3M								
No.	Freq. (MHz)	Emission Level (dBuV/m)	Limit (dBuV/m)	Margin (dB)	Antenna Height (m)	Table Angle (Degree)	Raw Value (dBuV)	Correction Factor (dB/m)
1	*2462.00	109.9 PK			1.13 V	73	79.10	30.80
1	*2462.00	103.8 AV			1.13 V	73	73.00	30.80
2	2483.50	59.2 PK	74.00	-14.80	1.25 V	241	28.20	31.00
2	2483.50	47.2 AV	54.00	-6.80	1.25 V	241	16.20	31.00
3	2688.00	59.4 PK	74.00	-14.60	1.15 V	232	28.20	31.30
3	2688.00	52.1 AV	54.00	-1.90	1.15 V	232	20.80	31.30
4	4924.00	50.7 PK	74.00	-23.30	1.08 V	78	14.00	36.70
5	7386.00	47.3 PK	74.00	-26.70	1.65 V	3	5.40	41.80
6	9848.00	51.2 PK	74.00	-22.80	1.32 V	55	6.80	44.40
6	9848.00	42.0 AV	54.00	-12.00	1.32 V	55	-2.30	36.70

- NOTE:**
1. Emission level= Raw Value - Correction Factor
 2. Correction Factor = External Preamp. Gain - Ant. Factor - Cable loss
(External Preamp. Gain = 0, when the test receiver is used for the test.)
 3. The other emission levels were very low against the limit.
 4. Margin value = Emission level - Limit value
 5. The limit value is defined as per 15.247
 6. “ * “ : Fundamental frequency



TEST RESULTS (VII)- Antenna 8, OFDM

EUT	802.11a/b/g miniPCI module	MODEL	C38WCW
MODE	Channel 1	FREQUENCY RANGE	Above 1000 MHz
INPUT POWER (SYSTEM)	120Vac, 60Hz	DETECTOR FUNCTION	Peak(PK) Average (AV)
ENVIRONMENTAL CONDITIONS	23deg. C, 57%RH, 965 hPa	TESTED BY	Eric Lee

ANTENNA POLARITY & TEST DISTANCE: HORIZONTAL AT 3 M

No.	Freq. (MHz)	Emission Level (dBuV/m)	Limit (dBuV/m)	Margin (dB)	Antenna Height (m)	Table Angle (Degree)	Raw Value (dBuV)	Correction Factor (dB/m)
1	2360.00	50.7 PK	74.00	-23.30	1.25 H	84	20.40	30.30
2	2390.00	55.8 PK	74.00	-18.20	1.65 H	241	25.40	30.40
2	2390.00	44.6 AV	54.00	-9.40	1.65 H	241	14.20	30.30
3	*2412.00	98.8 PK			1.24 H	51	68.20	30.50
3	*2412.00	89.9 AV			1.24 H	51	59.40	30.40
4	2688.00	46.0 PK	74.00	-28.00	1.57 H	201	14.70	31.30
5	4824.00	44.5 PK	74.00	-29.50	1.35 H	261	8.20	36.20
6	7236.00	44.8 PK	74.00	-29.20	1.32 H	22	3.10	41.70
7	9648.00	47.3 PK	74.00	-26.70	1.63 H	320	2.40	44.90

ANTENNA POLARITY & TEST DISTANCE: VERTICAL AT 3 M

No.	Freq. (MHz)	Emission Level (dBuV/m)	Limit (dBuV/m)	Margin (dB)	Antenna Height (m)	Table Angle (Degree)	Raw Value (dBuV)	Correction Factor (dB/m)
1	2360.00	56.7 PK	74.00	-17.30	1.47 V	54	26.40	30.30
1	2360.00	44.6 AV	54.00	-9.40	1.47 V	54	14.20	30.30
2	2390.00	60.7 PK	74.00	-13.30	1.52 V	222	30.30	30.40
2	2390.00	49.7 AV	54.00	-4.30	1.52 V	222	19.20	30.40
3	*2412.00	107.0 PK			1.44 V	312	76.50	30.50
3	*2412.00	98.0 AV			1.44 V	312	67.40	30.50
4	2688.00	51.6 PK	74.00	-22.40	1.13 V	336	20.40	31.30
4	2688.00	49.0 AV	54.00	-5.00	1.13 V	336	17.70	31.30
5	4824.00	49.5 PK	74.00	-24.50	1.54 V	222	13.30	36.20
6	7236.00	50.5 PK	74.00	-23.50	1.08 V	69	8.80	41.70
7	9648.00	53.2 PK	74.00	-20.80	1.45 V	213	8.30	44.90
7	9648.00	44.2 AV	54.00	-9.80	1.45 V	213	-0.70	36.20

- NOTE:**
1. Emission level = Raw Value - Correction Factor
 2. Correction Factor = External Preamp. Gain - Ant. Factor - Cable loss
(External Preamp. Gain = 0, when the test receiver is used for the test.)
 3. The other emission levels were very low against the limit.
 4. Margin value = Emission level - Limit value
 5. The limit value is defined as per 15.247
 6. " * " : Fundamental frequency



EUT	802.11a/b/g miniPCI module	MODEL	C38WCW
MODE	Channel 6	FREQUENCY RANGE	Above 1000 MHz
INPUT POWER (SYSTEM)	120Vac, 60Hz	DETECTOR FUNCTION	Peak(PK) Average (AV)
ENVIRONMENTAL CONDITIONS	23deg. C, 57%RH, 965 hPa	TESTED BY	Eric Lee

ANTENNA POLARITY & TEST DISTANCE: HORIZONTAL AT 3 M

No.	Freq. (MHz)	Emission Level (dBuV/m)	Limit (dBuV/m)	Margin (dB)	Antenna Height (m)	Table Angle (Degree)	Raw Value (dBuV)	Correction Factor (dB/m)
1	2390.00	51.8 PK	74.00	-22.20	1.30 H	92	21.40	30.40
1	2390.00	40.7 AV	54.00	-13.30	1.30 H	92	10.30	30.40
2	*2437.00	99.9 PK			1.65 H	8	69.20	30.70
2	*2437.00	90.7 AV			1.65 H	8	60.00	30.70
3	2483.50	49.4 PK	74.00	-24.60	1.57 H	333	18.50	31.00
4	2688.00	44.9 PK	74.00	-29.10	1.08 H	278	13.70	31.30
5	4874.00	43.7 PK	74.00	-30.30	1.09 H	250	7.20	36.50
6	7311.00	42.6 PK	74.00	-31.40	1.05 H	320	0.80	41.80
7	9748.00	46.8 PK	74.00	-27.20	1.53 H	331	2.10	44.60

ANTENNA POLARITY & TEST DISTANCE: VERTICAL AT 3 M

No.	Freq. (MHz)	Emission Level (dBuV/m)	Limit (dBuV/m)	Margin (dB)	Antenna Height (m)	Table Angle (Degree)	Raw Value (dBuV)	Correction Factor (dB/m)
1	2390.00	55.7 PK	74.00	-18.30	1.02 V	321	25.20	30.40
1	2390.00	45.7 AV	54.00	-8.30	1.02 V	321	15.20	30.40
2	*2437.00	105.9 PK			1.40 V	320	75.20	30.70
2	*2437.00	98.7 AV			1.40 V	320	68.00	30.70
3	2483.50	58.6 PK	74.00	-15.40	1.03 V	6	27.70	31.00
3	2483.50	47.9 AV	54.00	-6.10	1.03 V	6	17.00	31.00
4	2688.00	50.0 PK	74.00	-24.00	1.36 V	65	18.70	31.30
5	4874.00	52.1 PK	74.00	-21.90	1.09 V	321	15.60	36.50
5	4874.00	41.7 AV	54.00	-12.30	1.09 V	321	5.20	31.30
6	7311.00	49.2 PK	74.00	-24.80	1.69 V	98	7.40	41.80
7	9748.00	52.7 PK	74.00	-21.30	1.37 V	192	8.10	44.60
7	9748.00	44.6 AV	54.00	-9.40	1.37 V	192	0.00	36.50

- NOTE:**
1. Emission level = Raw Value - Correction Factor
 2. Correction Factor = External Preamp. Gain - Ant. Factor - Cable loss
(External Preamp. Gain = 0, when the test receiver is used for the test.)
 3. The other emission levels were very low against the limit.
 4. Margin value = Emission level - Limit value
 5. The limit value is defined as per 15.247
 6. " * " : Fundamental frequency



EUT	802.11a/b/g miniPCI module	MODEL	C38WCW
MODE	Channel 11	FREQUENCY RANGE	Above 1000 MHz
INPUT POWER (SYSTEM)	120Vac, 60Hz	DETECTOR FUNCTION	Peak(PK) Average (AV)
ENVIRONMENTAL CONDITIONS	23deg. C, 57%RH, 965 hPa	TESTED BY	Eric Lee

ANTENNA POLARITY & TEST DISTANCE: HORIZONTAL AT 3M								
No.	Freq. (MHz)	Emission Level (dBuV/m)	Limit (dBuV/m)	Margin (dB)	Antenna Height (m)	Table Angle (Degree)	Raw Value (dBuV)	Correction Factor (dB/m)
1	*2462.00	99.1 PK			1.50 H	39	68.20	30.80
1	*2462.00	90.4 AV			1.50 H	39	59.60	30.80
2	2483.50	55.6 PK	74.00	-18.40	1.57 H	88	24.70	31.00
2	2483.50	44.2 AV	54.00	-9.80	1.57 H	88	13.30	31.00
3	2688.00	43.9 PK	74.00	-30.10	1.54 H	214	12.60	31.30
4	4924.00	43.9 PK	74.00	-30.10	1.36 H	33	7.20	36.70
5	7386.00	43.6 PK	74.00	-30.40	1.68 H	3	1.80	41.80
6	9848.00	47.1 PK	74.00	-26.90	1.54 H	213	2.70	44.40

ANTENNA POLARITY & TEST DISTANCE: VERTICAL AT 3M								
No.	Freq. (MHz)	Emission Level (dBuV/m)	Limit (dBuV/m)	Margin (dB)	Antenna Height (m)	Table Angle (Degree)	Raw Value (dBuV)	Correction Factor (dB/m)
1	*2462.00	108.1 PK			1.29 V	236	77.30	30.80
1	*2462.00	98.0 AV			1.29 V	236	67.20	30.80
2	2483.50	61.5 PK	74.00	-12.50	1.38 V	54	30.50	31.00
2	2483.50	50.2 AV	54.00	-3.80	1.38 V	54	19.20	31.00
3	2688.00	55.5 PK	74.00	-18.50	1.17 V	333	24.30	31.30
3	2688.00	51.1 AV	54.00	-2.90	1.17 V	333	19.80	31.30
4	4924.00	49.9 PK	74.00	-24.10	1.06 V	108	13.20	36.70
5	7386.00	49.9 PK	74.00	-24.10	1.03 V	221	8.10	41.80
6	9848.00	51.2 PK	74.00	-22.80	1.52 V	229	6.80	44.40
6	9848.00	44.1 AV	54.00	-9.90	1.52 V	229	-0.30	36.70

- NOTE:**
1. Emission level= Raw Value - Correction Factor
 2. Correction Factor = External Preamp. Gain - Ant. Factor - Cable loss
(External Preamp. Gain = 0, when the test receiver is used for the test.)
 3. The other emission levels were very low against the limit.
 4. Margin value = Emission level - Limit value
 5. The limit value is defined as per 15.247
 6. " * " : Fundamental frequency



4.3 6dB BANDWIDTH MEASUREMENT

4.3.1 LIMITS OF 6dB BANDWIDTH MEASUREMENT

The minimum of 6dB Bandwidth Measurement is 0.5 MHz.

4.3.2 TEST INSTRUMENTS

Description & Manufacturer	Model No.	Serial No.	Calibrated Until
R&S SPECTRUM ANALYZER	FSP	1093.4495.30	Dec. 19, 2003

NOTE:

- 1.The measurement uncertainty is less than +/- 2.6dB, which is calculated as per the NAMAS document NIS81.
- 2.The calibration interval of the above test instruments is 12 months and the calibrations are traceable to NML/ROC and NIST/USA.

4.3.3 TEST PROCEDURE

The transmitter output was connected to the spectrum analyzer through an attenuator. The bandwidth of the fundamental frequency was measured by spectrum analyzer with 100kHz RBW and 100kHz VBW. The 6dB bandwidth is defined as the total spectrum the power of which is higher than peak power minus 6 dB.

4.3.4 DEVIATION FROM TEST STANDARD

No deviation

4.3.5 TEST SETUP

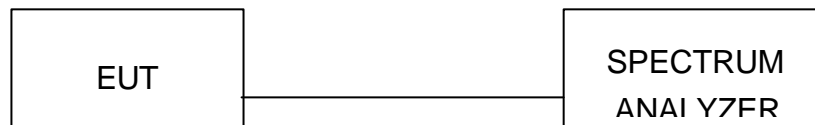

4.3.6 EUT OPERATING CONDITIONS

The software provided by client to enable the EUT under transmission condition continuously at lowest, middle and highest channel frequencies individually.



4.3.7 TEST RESULTS (A)

6dB bandwidth of maximum conducted output power -DSSS

EUT	802.11a/b/g miniPCI module	MODEL	C38WCW
INPUT POWER (SYSTEM)	120Vac, 60Hz	ENVIRONMENTAL CONDITIONS	26deg. C, 58%RH, 965 hPa
TESTED BY	Eric Lee		

CHANNEL	CHANNEL FREQUENCY (MHz)	6dB BANDWIDTH (MHz)	MINIMUM LIMIT (MHz)	PASS/FAIL
1	2412	11.96	0.5	PASS
6	2437	11.24	0.5	PASS
11	2462	11.92	0.5	PASS



CH1

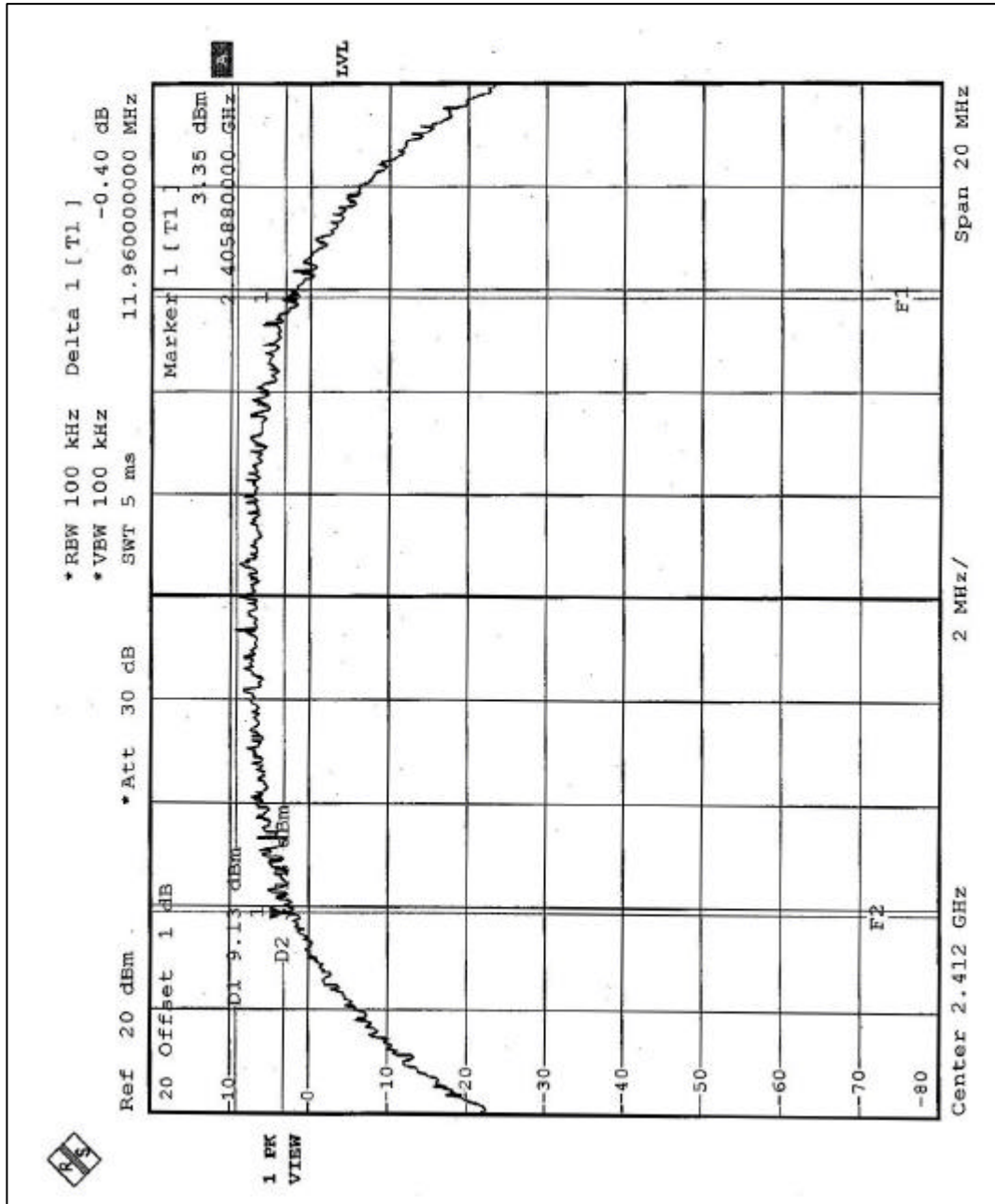



CH6

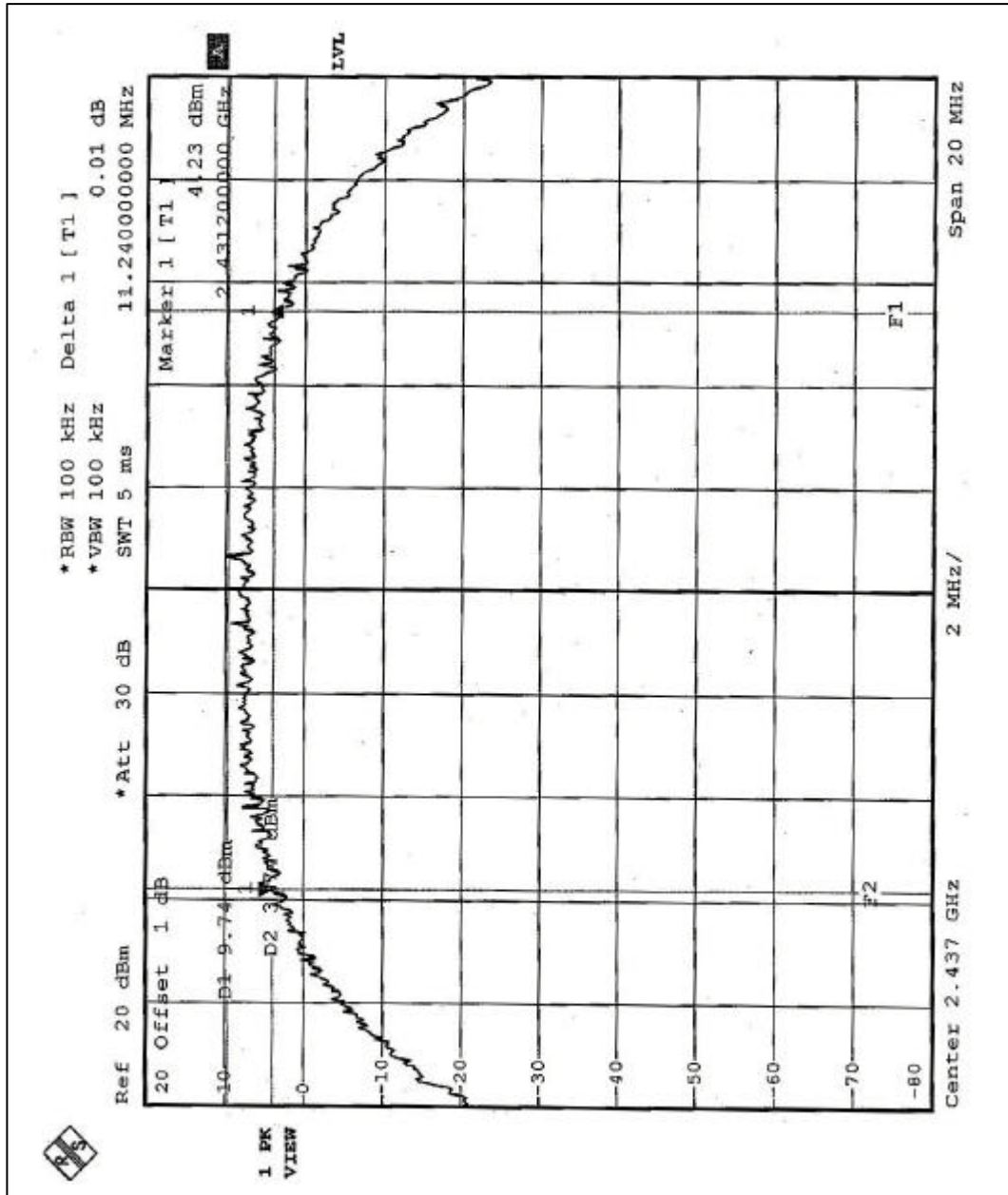



CH11

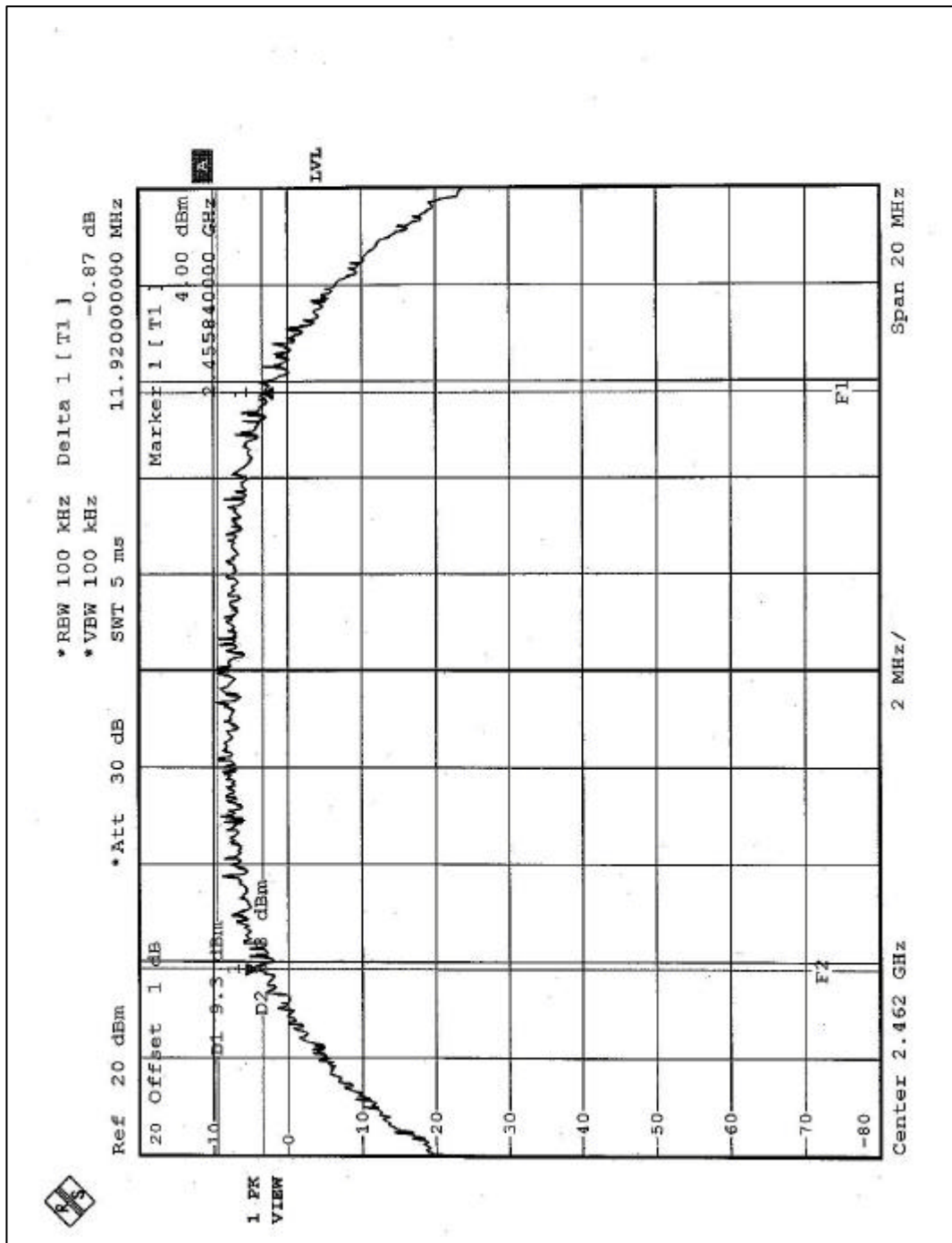



4.3.8 TEST RESULTS (A)

6dB bandwidth of maximum conducted output power - OFDM

EUT	802.11a/b/g miniPCI module	MODEL	C38WCW
INPUT POWER (SYSTEM)	120Vac, 60Hz	ENVIRONMENTAL CONDITIONS	25deg. C, 58%RH, 965 hPa
TESTED BY	Eric Lee		

CHANNEL	CHANNEL FREQUENCY (MHz)	6dB BANDWIDTH (MHz)	MINIMUM LIMIT (MHz)	PASS/FAIL
1	2412	16.6	0.5	PASS
6	2437	16.5	0.5	PASS
11	2462	16.55	0.5	PASS



CH1

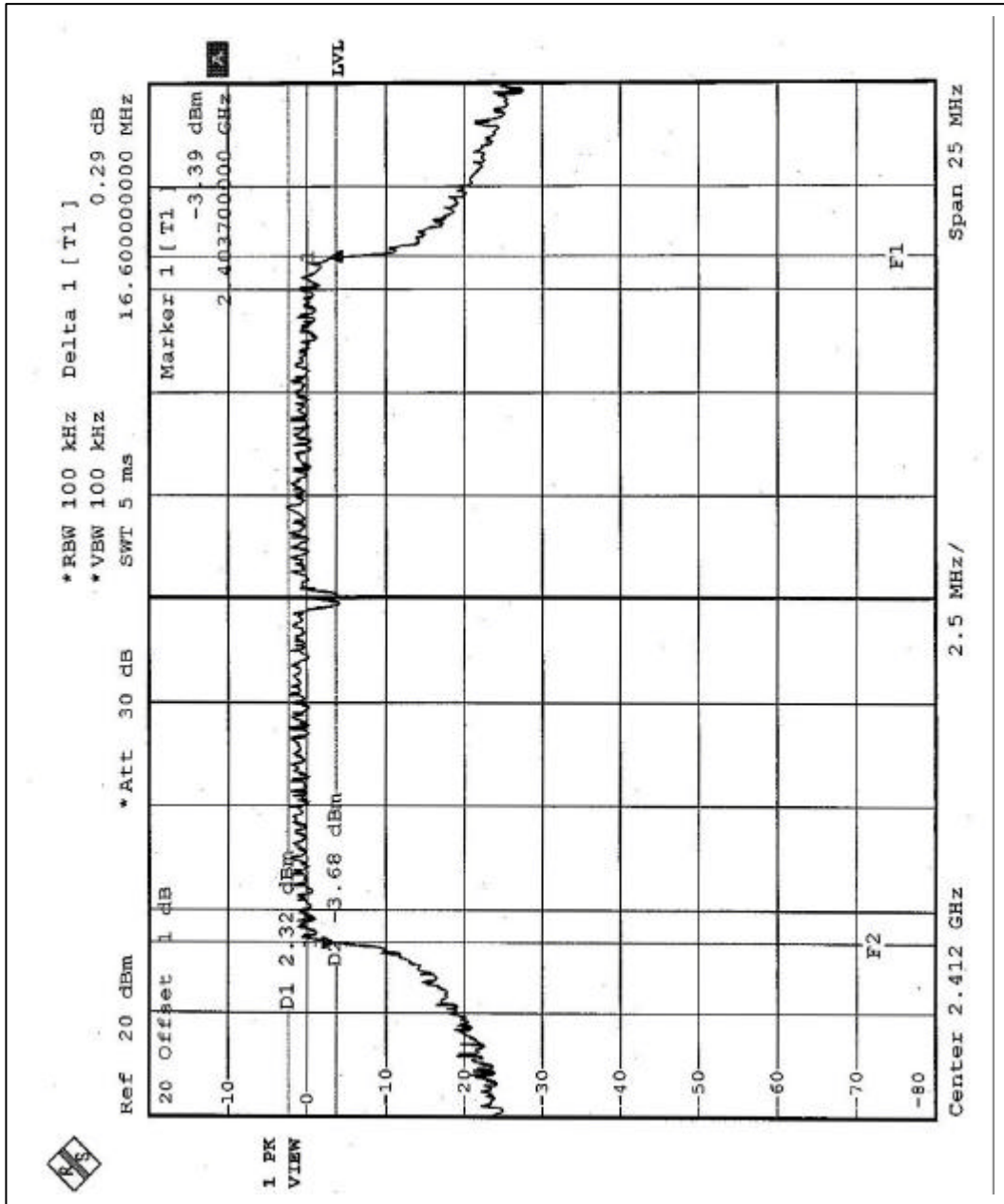



CH6

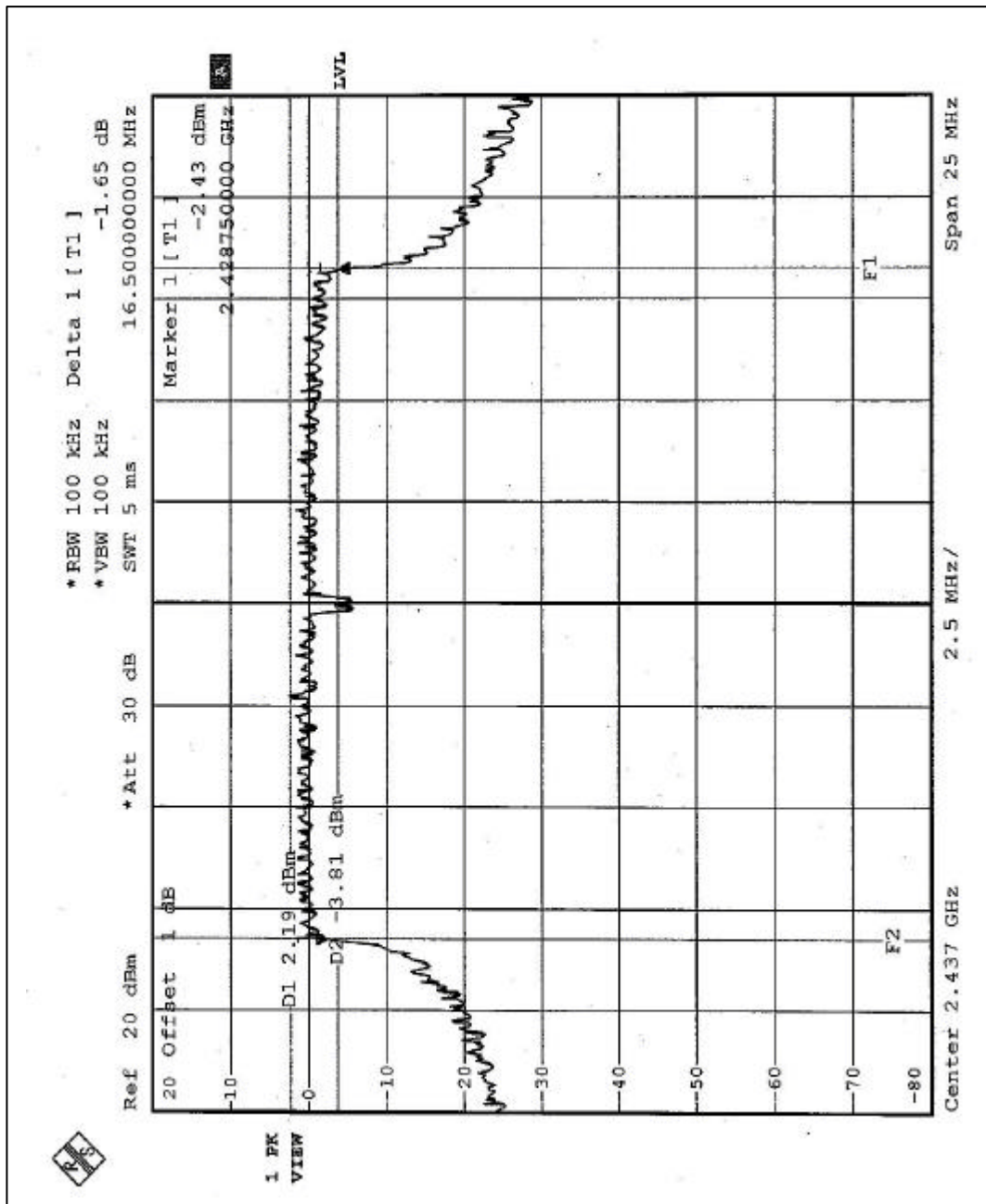



CH11

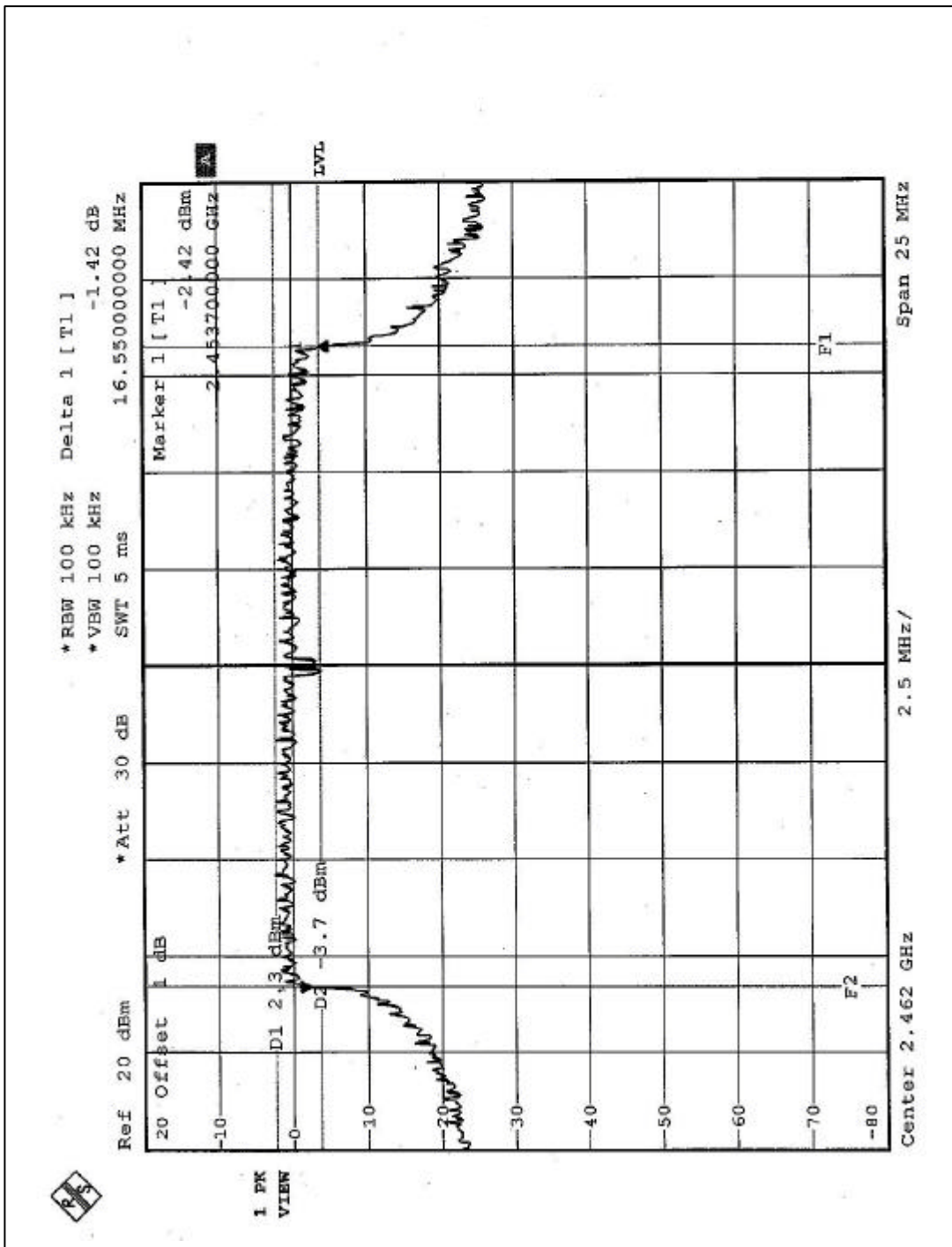



4.4 MAXIMUM PEAK OUTPUT POWER

4.4.1 LIMITS OF MAXIMUM PEAK OUTPUT POWER MEASUREMENT

The Maximum Peak Output Power Measurement is 30dBm.

4.4.2 INSTRUMENTS

Description & Manufacturer	Model No.	Serial No.	Calibrated Until
R&S SPECTRUM ANALYZER	FSP30	100019	Dec. 19, 2003
R&S SIGNAL GENERATOR	SMP04	100011	May 28, 2004
TEKTRONIX OSCILLOSCOPE	TDS 220	B048470	Mar. 05, 2004
NARDA DETECTOR	4503A	FSCM99899	NA

NOTE:

The calibration interval of the above test instruments is 12 months and the calibrations are traceable to NML/ROC and NIST/USA.

4.4.3 TEST PROCEDURES

1. A detector was used on the output port of the EUT. An oscilloscope was used to read the response of the detector.
2. Replaced the EUT by the signal generator. The center frequency of the S.G was adjusted to the center frequency of the measured channel.
3. Adjusted the power to have the same reading on oscilloscope. Record the power level.

4.4.4 TEST SETUP

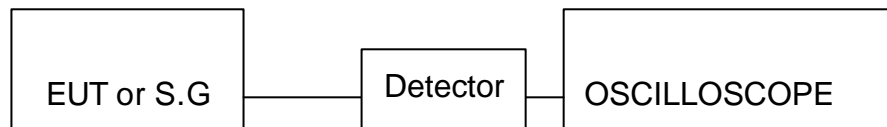

4.4.5 EUT OPERATING CONDITIONS

Same as Item 4.3.6



4.4.6 TEST RESULTS (B)-Antenna 1 & Antenna 4 & Antenna 7-DSSS

EUT	802.11a/b/g miniPCI module	MODEL	C38WCW
INPUT POWER (SYSTEM)	120Vac, 60Hz	ENVIRONMENTAL CONDITIONS	21deg. C, 58%RH, 965 hPa
TESTED BY	Eric Lee		

CHANNEL	CHANNEL FREQUENCY (MHz)	PEAK POWER OUTPUT (dBm)	PEAK POWER LIMIT (dBm)	PASS/FAIL
1	2412	20.00	30	PASS
6	2437	20.22	30	PASS
11	2462	20.39	30	PASS

4.4.7 TEST RESULTS (B)-Antenna 1 & Antenna 4 & Antenna 7-OFDM

EUT	802.11a/b/g miniPCI module	MODEL	C38WCW
INPUT POWER (SYSTEM)	120Vac, 60Hz	ENVIRONMENTAL CONDITIONS	21deg. C, 58%RH, 965 hPa
TESTED BY	Tony Chen		

CHANNEL	CHANNEL FREQUENCY (MHz)	PEAK POWER OUTPUT (dBm)	PEAK POWER LIMIT (dBm)	PASS/FAIL
1	2412	19.41	30	PASS
6	2437	19.24	30	PASS
11	2462	19.11	30	PASS

Note: The output power of Antenna 1 & Antenna 4 & Antenna 7 will be programmed to the same output power by software.



4.4.8 TEST RESULTS (B)-Antenna 2-DSSS

EUT	802.11a/b/g miniPCI module	MODEL	C38WCW
INPUT POWER (SYSTEM)	120Vac, 60Hz	ENVIRONMENTAL CONDITIONS	21deg. C, 58%RH, 965 hPa
TESTED BY	Eric Lee		

CHANNEL	CHANNEL FREQUENCY (MHz)	PEAK POWER OUTPUT (dBm)	PEAK POWER LIMIT (dBm)	PASS/FAIL
1	2412	16.58	30	PASS
6	2437	16.24	30	PASS
11	2462	16.90	30	PASS

4.4.9 TEST RESULTS (B)-Antenna 2-OFDM

EUT	802.11a/b/g miniPCI module	MODEL	C38WCW
INPUT POWER (SYSTEM)	120Vac, 60Hz	ENVIRONMENTAL CONDITIONS	21deg. C, 58%RH, 965 hPa
TESTED BY	Tony Chen		

CHANNEL	CHANNEL FREQUENCY (MHz)	PEAK POWER OUTPUT (dBm)	PEAK POWER LIMIT (dBm)	PASS/FAIL
1	2412	15.24	30	PASS
6	2437	15.71	30	PASS
11	2462	15.30	30	PASS



4.4.10 TEST RESULTS (B)-Antenna 3-DSSS

EUT	802.11a/b/g miniPCI module	MODEL	C38WCW
INPUT POWER (SYSTEM)	120Vac, 60Hz	ENVIRONMENTAL CONDITIONS	21deg. C, 58%RH, 965 hPa
TESTED BY	Eric Lee		

CHANNEL	CHANNEL FREQUENCY (MHz)	PEAK POWER OUTPUT (dBm)	PEAK POWER LIMIT (dBm)	PASS/FAIL
1	2412	11.89	30	PASS
6	2437	11.76	30	PASS
11	2462	11.93	30	PASS

4.4.11 TEST RESULTS (B)-Antenna 3-OFDM

EUT	802.11a/b/g miniPCI module	MODEL	C38WCW
INPUT POWER (SYSTEM)	120Vac, 60Hz	ENVIRONMENTAL CONDITIONS	21deg. C, 58%RH, 965 hPa
TESTED BY	Tony Chen		

CHANNEL	CHANNEL FREQUENCY (MHz)	PEAK POWER OUTPUT (dBm)	PEAK POWER LIMIT (dBm)	PASS/FAIL
1	2412	9.70	30	PASS
6	2437	9.81	30	PASS
11	2462	9.59	30	PASS



4.4.12 TEST RESULTS (B)-Antenna 5-DSSS

EUT	802.11a/b/g miniPCI module	MODEL	C38WCW
INPUT POWER (SYSTEM)	120Vac, 60Hz	ENVIRONMENTAL CONDITIONS	21deg. C, 58%RH, 965 hPa
TESTED BY	Eric Lee		

CHANNEL	CHANNEL FREQUENCY (MHz)	PEAK POWER OUTPUT (dBm)	PEAK POWER LIMIT (dBm)	PASS/FAIL
1	2412	12.03	30	PASS
6	2437	12.24	30	PASS
11	2462	12.60	30	PASS

4.4.13 TEST RESULTS (B)-Antenna 5-OFDM

EUT	802.11a/b/g miniPCI module	MODEL	C38WCW
INPUT POWER (SYSTEM)	120Vac, 60Hz	ENVIRONMENTAL CONDITIONS	21deg. C, 58%RH, 965 hPa
TESTED BY	Tony Chen		

CHANNEL	CHANNEL FREQUENCY (MHz)	PEAK POWER OUTPUT (dBm)	PEAK POWER LIMIT (dBm)	PASS/FAIL
1	2412	10.55	30	PASS
6	2437	10.46	30	PASS
11	2462	10.70	30	PASS



4.4.14 TEST RESULTS (B)-Antenna 8-DSSS

EUT	802.11a/b/g miniPCI module	MODEL	C38WCW
INPUT POWER (SYSTEM)	120Vac, 60Hz	ENVIRONMENTAL CONDITIONS	21deg. C, 58%RH, 965 hPa
TESTED BY	Eric Lee		

CHANNEL	CHANNEL FREQUENCY (MHz)	PEAK POWER OUTPUT (dBm)	PEAK POWER LIMIT (dBm)	PASS/FAIL
1	2412	15.09	30	PASS
6	2437	15.36	30	PASS
11	2462	15.87	30	PASS

4.4.15 TEST RESULTS (B)-Antenna 8-OFDM

EUT	802.11a/b/g miniPCI module	MODEL	C38WCW
INPUT POWER (SYSTEM)	120Vac, 60Hz	ENVIRONMENTAL CONDITIONS	21deg. C, 58%RH, 965 hPa
TESTED BY	Tony Chen		

CHANNEL	CHANNEL FREQUENCY (MHz)	PEAK POWER OUTPUT (dBm)	PEAK POWER LIMIT (dBm)	PASS/FAIL
1	2412	15.12	30	PASS
6	2437	15.29	30	PASS
11	2462	15.83	30	PASS



4.5 POWER SPECTRAL DENSITY MEASUREMENT

4.5.1 LIMITS OF POWER SPECTRAL DENSITY MEASUREMENT

The Maximum of Power Spectral Density Measurement is 8dBm.

4.5.2 TEST INSTRUMENTS

Description & Manufacturer	Model No.	Serial No.	Calibrated Until
R&S SPECTRUM ANALYZER	FSP	1093.4495.30	Dec. 19, 2003

NOTE:

- 1.The measurement uncertainty is less than +/- 2.6dB, which is calculated as per the NAMAS document NIS81.
- 2.The calibration interval of the above test instruments is 12 months and the calibrations are traceable to NML/ROC and NIST/USA.

4.5.3 TEST PROCEDURE

The transmitter output was connected to the spectrum analyzer through an attenuator, the bandwidth of the fundamental frequency was measured with the spectrum analyzer using 3 kHz RBW and 30 kHz VBW, set sweep time = span/3 kHz. The power spectral density was measured and recorded.

The sweep time is allowed to be longer than span/3 kHz for a full response of the mixer in the spectrum analyzer.

4.5.4 DEVIATION FROM TEST STANDARD

No deviation

4.5.5 TEST SETUP

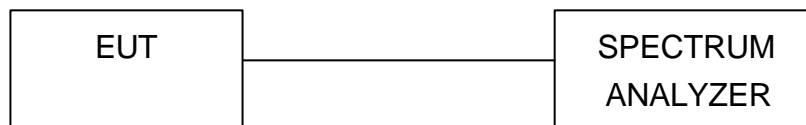

4.5.6 EUT OPERATING CONDITION

Same as Item 4.3.6



4.5.7 TEST RESULTS (C)

Power Spectral Density of maximum conducted output power -DSSS

EUT	802.11a/b/g miniPCI module	MODEL	C38WCW
INPUT POWER (SYSTEM)	120Vac, 60Hz	ENVIRONMENTAL CONDITIONS	21deg. C, 58RH, 965 hPa
TESTED BY	Eric Lee		

CHANNEL NUMBER	CHANNEL FREQUENCY (MHz)	RF POWER LEVEL IN 3 kHz BW (dBm)	MAXIMUM LIMIT (dBm)	PASS/FAIL
1	2412	-1.36	8	PASS
6	2437	-1.32	8	PASS
11	2462	-1.09	8	PASS



CH1

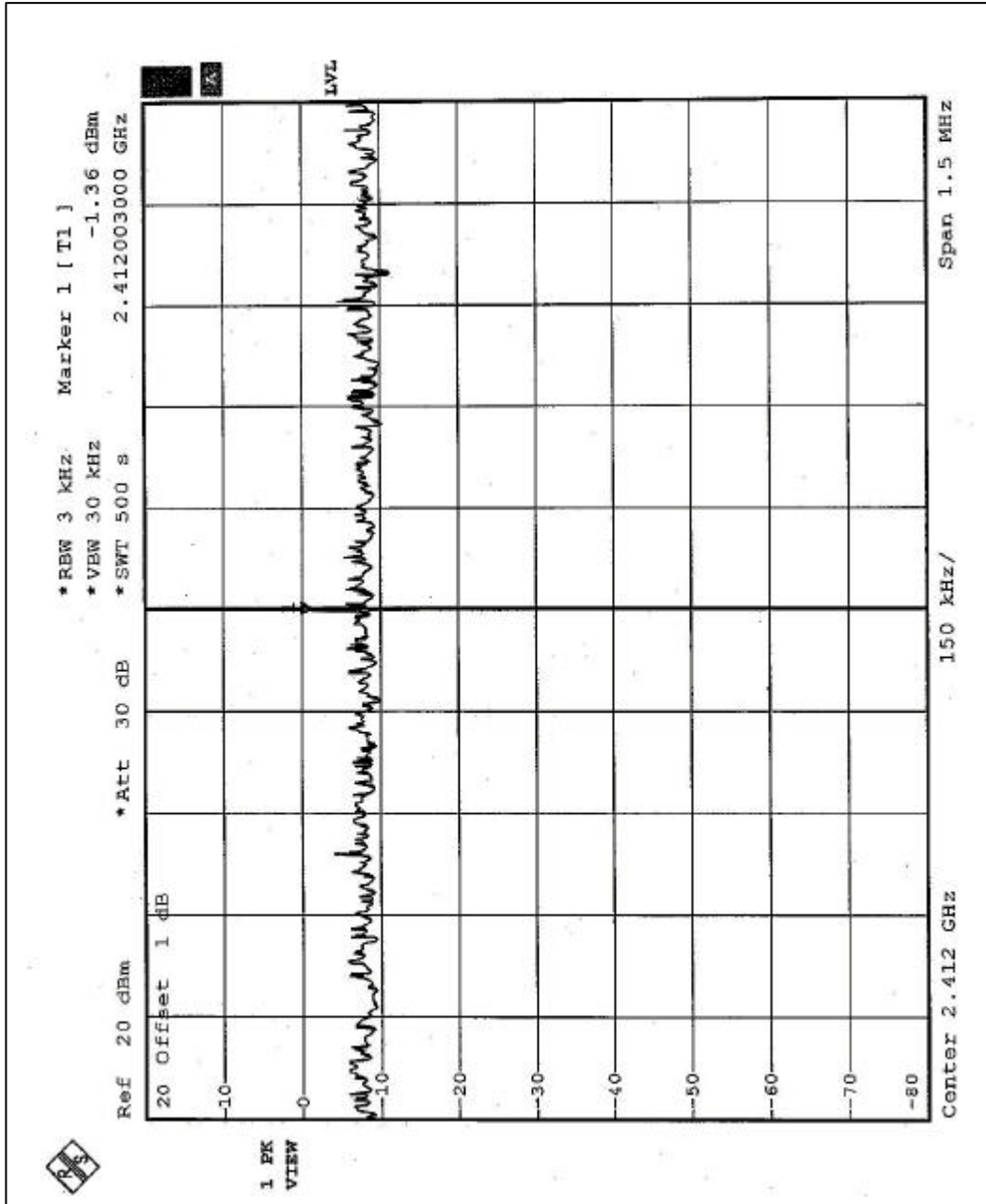



CH6

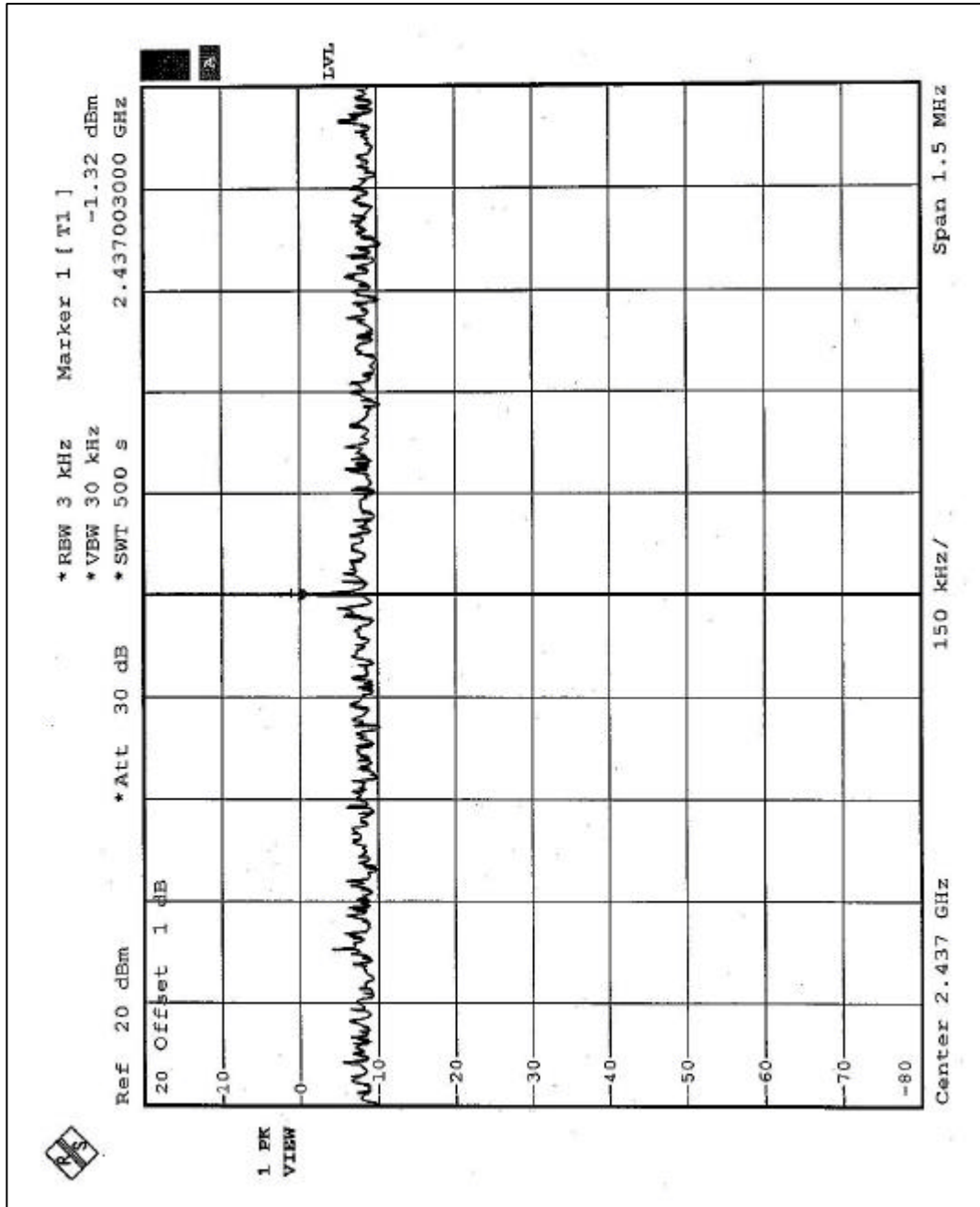



CH11

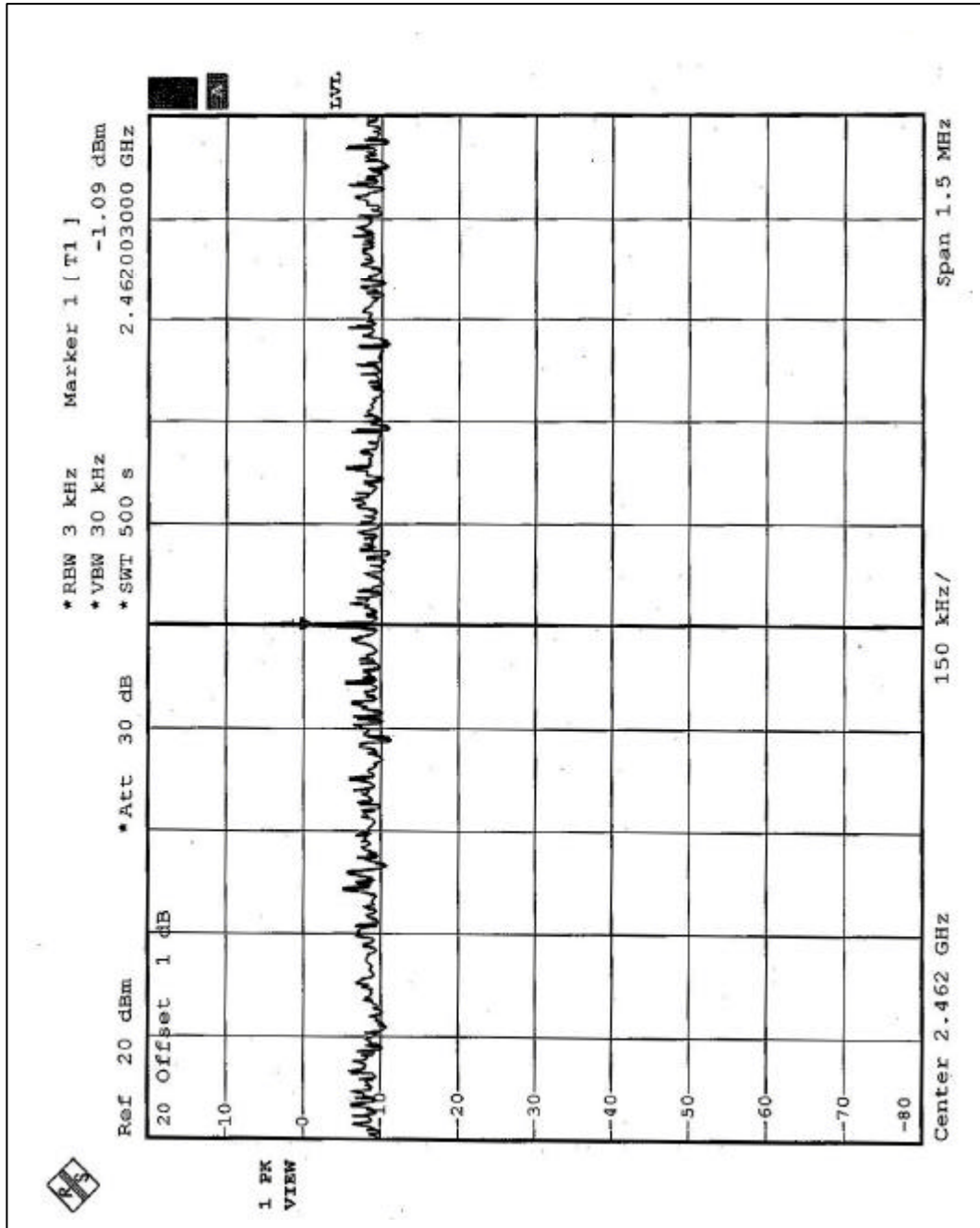



4.5.8 TEST RESULTS(C)

Power Spectral Density of maximum conducted output power-OFDM

EUT	802.11a/b/g miniPCI module	MODEL	C38WCW
INPUT POWER (SYSTEM)	120Vac, 60Hz	ENVIRONMENTAL CONDITIONS	21deg. C, 58RH, 965 hPa
TESTED BY	Eric Lee		

CHANNEL NUMBER	CHANNEL FREQUENCY (MHz)	RF POWER LEVEL IN 3 kHz BW (dBm)	MAXIMUM LIMIT (dBm)	PASS/FAIL
1	2412	-6.10	8	PASS
6	2437	-6.85	8	PASS
11	2462	-7.21	8	PASS



CH1

