



FCC TEST REPORT

REPORT NO.: RF920529R03

MODEL NO.: 8482-WD

RECEIVED: Mar. 29, 2003

TESTED: Mar. 20 to Jun. 06, 2003

APPLICANT: Proxim Corporation

ADDRESS: 935 Stewart Drive, Sunnyvale, CA 94085, USA

ISSUED BY: Advance Data Technology Corporation

LAB LOCATION: No. 81-1, Lu Liao Keng, 9 Ling, Wu Lung Tsuen,
Chiung Lin Hsiang, Hsin Chu Hsien,
Taiwan, R.O.C.

This test report consists of 171 pages in total. It may be duplicated completely for legal use with the approval of the applicant. It should not be reproduced except in full, without the written approval of our laboratory. The client should not use it to claim product endorsement by NVLAP or any government agencies. The test results in the report only apply to the tested sample.



Lab Code: 200376-0



Table of Contents

1.	CERTIFICATION.....	6
2.	SUMMARY OF TEST RESULTS.....	7
3.	GENERAL INFORMATION	10
3.1	GENERAL DESCRIPTION OF EUT.....	10
3.2	DESCRIPTION OF TEST MODES.....	11
3.3	GENERAL DESCRIPTION OF APPLIED STANDARDS.....	12
3.4	DESCRIPTION OF SUPPORT UNITS.....	13
4.	TEST TYPES AND RESULTS (For Part 802.11b).....	14
4.1	CONDUCTED EMISSION MEASUREMENT	14
4.1.1	LIMITS OF CONDUCTED EMISSION MEASUREMENT.....	14
4.1.2	TEST INSTRUMENTS	14
4.1.3	TEST PROCEDURES.....	15
4.1.4	DEVIATION FROM TEST STANDARD	15
4.1.5	TEST SETUP	16
4.1.6	EUT OPERATING CONDITIONS	16
4.1.7	TEST RESULTS	17
4.2	Radiated Emission Measurement.....	23
4.2.1	LIMITS OF RADIATED EMISSION MEASUREMENT.....	23
4.2.2	TEST INSTRUMENTS	24
4.2.3	TEST PROCEDURES.....	25
4.2.4	DEVIATION FROM TEST STANDARD	25
4.2.5	TEST SETUP	26
4.2.6	EUT OPERATING CONDITIONS	26
4.2.7	TEST RESULTS	27
4.3	6dB BANDWIDTH MEASUREMENT.....	34
4.3.1	LIMITS OF 6dB BANDWIDTH MEASUREMENT.....	34
4.3.2	TEST INSTRUMENTS	34
4.3.3	TEST PROCEDURE	35
4.3.4	DEVIATION FROM TEST STANDARD	35
4.3.5	TEST SETUP	35
4.3.6	EUT OPERATING CONDITIONS	35
4.3.7	TEST RESULTS (A).....	36
4.3.8	TEST RESULTS (B).....	40
4.4	MAXIMUM PEAK OUTPUT POWER.....	44
4.4.1	LIMITS OF MAXIMUM PEAK OUTPUT POWER MEASUREMENT.....	44
4.4.2	INSTRUMENTS	44
4.4.3	TEST PROCEDURES.....	45
4.4.4	DEVIATION FROM TEST STANDARD	45
4.4.5	TEST SETUP	45
4.4.6	EUT OPERATING CONDITIONS	45
4.4.7	TEST RESULTS (A).....	46



4.4.8	TEST RESULTS (B).....	46
4.5	POWER SPECTRAL DENSITY MEASUREMENT.....	47
4.5.1	LIMITS OF POWER SPECTRAL DENSITY MEASUREMENT	47
4.5.2	TEST INSTRUMENTS	47
4.5.3	TEST PROCEDURE	48
4.5.4	DEVIATION FROM TEST STANDARD	48
4.5.5	TEST SETUP	48
4.5.6	EUT OPERATING CONDITION	48
4.5.7	TEST RESULTS(A).....	49
4.5.8	TEST RESULTS(B).....	53
4.6	BAND EDGES MEASUREMENT.....	57
4.6.1	LIMITS OF BAND EDGES MEASUREMENT.....	57
4.6.2	TEST INSTRUMENTS	57
4.6.3	TEST PROCEDURE	57
4.6.4	DEVIATION FROM TEST STANDARD	57
4.6.5	EUT OPERATING CONDITION	58
4.6.6	TEST RESULTS (A).....	58
4.6.7	TEST RESULTS (B).....	60
4.7	ANTENNA REQUIREMENT.....	64
4.7.1	STANDARD APPLICABLE	64
4.7.2	ANTENNA CONNECTED CONSTRUCTION	64
5.	TEST TYPES AND RESULTS (For part 802.11a)	65
5.1	CONDUCTED EMISSION MEASUREMENT	65
5.1.1	LIMITS OF CONDUCTED EMISSION MEASUREMENT	65
5.1.2	TEST INSTRUMENTS	65
5.1.3	TEST PROCEDURES.....	66
5.1.4	DEVIATION FROM TEST STANDARD	66
5.1.5	TEST SETUP	67
5.1.6	EUT OPERATING CONDITIONS	67
5.1.7	TEST RESULTS	68
5.2	Radiated Emission Measurement.....	70
5.2.1	LIMITS OF RADIATED EMISSION MEASUREMENT.....	70
5.2.2	LIMITS OF UNWANTED EMISSION OUT OF THE RESTRICTED BANDS.....	71
5.2.3	TEST INSTRUMENTS	72
5.2.4	TEST PROCEDURES.....	73
5.2.5	DEVIATION FROM TEST STANDARD	73
5.2.6	TEST SETUP	74
5.2.7	EUT OPERATING CONDITIONS	74
5.2.8	TEST RESULTS	75
5.2.9	TEST RESULTS	76
5.3	Peak transmit power MEASUREMENT.....	88
5.3.1	LIMITS OF PEAK TRANSMIT POWER MEASUREMENT	88
5.3.2	TEST INSTRUMENTS	88
5.3.3	TEST PROCEDURE	89



5.3.4	DEVIATION FROM TEST STANDARD	89
5.3.5	TEST SETUP	89
5.3.6	EUT OPERATING CONDITIONS	89
5.3.7	TEST RESULTS	90
5.4	Peak power EXCURSION MEASUREMENT.....	106
5.4.1	LIMITS OF PEAK POWER EXCURSION MEASUREMENT.....	106
5.4.2	TEST INSTRUMENTS	106
5.4.3	TEST PROCEDURE	107
5.4.4	DEVIATION FROM TEST STANDARD	107
5.4.5	TEST SETUP	107
5.4.6	EUT OPERATING CONDITIONS	107
5.4.7	TEST RESULTS	108
5.5	PEAK power spectral density measurement.....	117
5.5.1	LIMITS OF PEAK POWER SPECTRAL DENSITY MEASUREMENT.....	117
5.5.2	TEST INSTRUMENTS	117
5.5.3	TEST PROCEDURES.....	118
5.5.4	DEVIATION FROM TEST STANDARD	118
5.5.5	TEST SETUP	118
5.5.6	EUT OPERATING CONDITIONS	118
5.5.7	TEST RESULTS	119
5.6	FREQUENCY STABILITY	128
5.6.1	LIMITS OF FREQUENCY STABILITY MEASUREMENT.....	128
5.6.2	TEST INSTRUMENTS	128
5.6.3	TEST PROCEDURE	128
5.6.4	DEVIATION FROM TEST STANDARD	128
5.6.5	TEST SETUP	129
5.6.6	EUT OPERATING CONDITION	129
5.6.7	TEST RESULTS	130
5.7	BAND EDGES MEASUREMENT	131
5.7.1	TEST INSTRUMENTS	131
5.7.2	TEST PROCEDURE	131
5.7.3	EUT OPERATING CONDITION	131
5.7.4	TEST RESULTS	132
5.8	6dB BANDWIDTH MEASUREMENT.....	137
5.8.1	LIMITS OF 6dB BANDWIDTH MEASUREMENT.....	137
5.8.2	TEST INSTRUMENTS	137
5.8.3	TEST PROCEDURE	138
5.8.4	DEVIATION FROM TEST STANDARD	138
5.8.5	TEST SETUP	138
5.8.6	EUT OPERATING CONDITIONS	138
5.8.7	TEST RESULTS	139
5.9	MAXIMUM PEAK OUTPUT POWER.....	146
5.9.1	LIMITS OF MAXIMUM PEAK OUTPUT POWER MEASUREMENT.....	146
5.9.2	INSTRUMENTS	146



5.9.3	TEST PROCEDURES	147
5.9.4	DEVIATION FROM TEST STANDARD	147
5.9.5	TEST SETUP	147
5.9.6	EUT OPERATING CONDITIONS	147
5.9.7	TEST RESULTS	148
5.9.8	LIMITS OF POWER SPECTRAL DENSITY MEASUREMENT	149
5.9.9	TEST INSTRUMENTS	149
5.9.10	TEST PROCEDURE	150
5.9.11	DEVIATION FROM TEST STANDARD	150
5.9.12	TEST SETUP	150
5.9.13	EUT OPERATING CONDITION	150
5.9.14	TEST RESULTS	151
5.10	BAND EDGES MEASUREMENT	158
5.10.1	LIMITS OF BAND EDGES MEASUREMENT	158
5.10.2	TEST INSTRUMENTS	158
5.10.3	TEST PROCEDURE	158
5.10.4	DEVIATION FROM TEST STANDARD	158
5.10.5	EUT OPERATING CONDITION	159
5.10.6	TEST RESULTS	159
5.11	ANTENNA REQUIREMENT.....	168
5.11.1	STANDARD APPLICABLE	168
5.11.2	ANTENNA CONNECTED CONSTRUCTION	168
6.	PHOTOGRAPHS OF THE TEST CONFIGURATION.....	169
7.	INFORMATION ON THE TESTING LABORATORIES	171



1. CERTIFICATION

PRODUCT : 802.11a/b/g PCI adapter card
BRAND NAME : Proxim
MODEL NO. : 8482-WD
APPLICANT : Proxim Corporation
STANDARDS : 47 CFR Part 15, Subpart C (Section 15.247),
Subpart E (Section 15.407), ANSI C63.4-1992

We, **Advance Data Technology Corporation**, hereby certify that one sample of the designation has been tested in our facility from Mar. 20 to Jun. 06, 2003. The test record data evaluation and Equipment under Test (EUT) configurations represented herein are true and accurate accounts of the measurements of the sample's EMC characteristics under the conditions herein specified.

PREPARED BY: *Amanda Chu* , **DATE:** *Jun. 06, 2003*
(Amanda Chu)

APPROVED BY: *Eric Lin* , **DATE:** *Jun. 06, 2003*
(Eric Lin, Manager)



2. SUMMARY OF TEST RESULTS

The EUT has been tested according to the following specifications:

APPLIED STANDARD: 47 CFR Part 15, Subpart C			
Standard Section	Test Type and Limit	Result	REMARK
15.207	AC Power Conducted Emission	PASS	Meet the requirement of limit Minimum passing margin is -1.47dBuV at 0.150MHz
15.247(a)(2)	Spectrum Bandwidth of a Direct Sequence Spread Spectrum System Limit: min. 500kHz	PASS	Meet the requirement of limit
15.247(b)	Maximum Peak Output Power Limit: max. 30dBm	PASS	Meet the requirement of limit
15.247(c)	Radiated Emissions Limit: Table 15.209	PASS	Meet the requirement of limit Minimum passing margin is -1.1 dBuV at 2390.00 MHz
15.247(d)	Power Spectral Density Limit: max. 8dBm	PASS	Meet the requirement of limit
15.247(c)	Band Edge Measurement Limit: 20dB less than the peak value of fundamental frequency	PASS	Meet the requirement of limit



for freq. 5.15~5.35GHz :

APPLIED STANDARD: 47 CFR Part 15, Subpart E			
Standard Section	Test Type	Result	REMARK
15.407(b)(5)	AC Power Conducted Emission	PASS	Meet the requirement of limit Minimum passing margin is -1.53dBuV at 0.150MHz
15.407(b/1/2/3) (b)(5)	Electric Field Strength Spurious Emissions, 30 MHz – 40000 MHz	PASS	Meet the requirement of limit Minimum passing margin is -5.8dBuV at 5350.00MHz
15.407(a/1/2/3)	Peak Transmit Power	PASS	Meet the requirement of limit
15.407(a)(6)	Peak Power Excursion	PASS	Meet the requirement of limit
15.407(a/1/2/3)	Peak Power Spectral Density	PASS	Meet the requirement of limit
15.407(g)	Frequency Stability	PASS	Meet the requirement of limit



for freq. 5.725~5.850GHz :

APPLIED STANDARD: 47 CFR Part 15, Subpart C			
Standard Section	Test Type and Limit	Result	REMARK
15.207	AC Power Conducted Emission	PASS	Meet the requirement of limit Minimum passing margin is -1.53dBuV at 0.150MHz
15.247(a)(2)	Spectrum Bandwidth of a Direct Sequence Spread Spectrum System Limit: min. 500kHz	PASS	Meet the requirement of limit
15.247(b)	Maximum Peak Output Power Limit: max. 30dBm	PASS	Meet the requirement of limit
15.247(c)	Radiated Emissions Limit: Table 15.209	PASS	Meet the requirement of limit Minimum passing margin is -5.3dBuV at 11490.00MHz
15.247(d)	Power Spectral Density Limit: max. 8dBm	PASS	Meet the requirement of limit
15.247(c)	Band Edge Measurement Limit: 20dB less than the peak value of fundamental frequency	PASS	Meet the requirement of limit



3. GENERAL INFORMATION

3.1 GENERAL DESCRIPTION OF EUT

PRODUCT	802.11a/b/g PCI adapter card
MODEL NO.	8482-WD
POWER SUPPLY	12VDC from host equipment
MODULATION	DSSS, OFDM
TRANSFER RATE	802.11b and draft 802.11g: 1/2/5.5/6/9/11/12/18/24/36/48/54Mbps 802.11a:6 to 54Mbps (Turbo mode: up to 108Mbps *see note 1)
FREQUENCY RANGE	802.11b and draft 802.11g: 2400MHz ~ 2483.5MHz 802.11a: 5.15GHz ~ 5.35GHz, 5.725GHz ~ 5.850GHz
NUMBER OF CHANNEL	802.11b and draft 802.11g: 11 802.11a: 13 for Normal mode / 5 for Turbo mode
CHANNEL SPACING	802.11b and draft 802.11g: 5MHz 802.11a: 20MHz for Normal mode / 40MHz for Turbo mode
OUTPUT POWER	802.11b: 15.21dBm / draft 802.11g: 15.24dBm 802.11a: 17.02dBm
DATA CABLE	NA
ANTENNA TYPE	Dipole antenna
I/O PORTS	NA
ASSOCIATED DEVICES	NA

NOTE:

1. This EUT is capable of providing data rates of up to 108Mbps in Turbo Mode depending upon reception quality.
2. Dual-band, the EUT communicates with Wireless-A (802.11a), Wireless-B, (802.11b), and Wireless-G (draft 802.11g) wireless networks.
3. For more detailed features description, please refer to the manufacturer's specifications or User's Manual.



3.2 DESCRIPTION OF TEST MODES

For 802.11b: Eleven channels are provided to this EUT.

Channel	Frequency	Channel	Frequency
1	2412 MHz	7	2442 MHz
2	2417 MHz	8	2447 MHz
3	2422 MHz	9	2452 MHz
4	2427 MHz	10	2457 MHz
5	2432 MHz	11	2462 MHz
6	2437 MHz		

NOTE:

1. Below 1 GHz, the channel 1, 6, and 11 were pre-tested in chamber. The channel 11, worst case one, was chosen for final test.
2. Above 1 GHz, the channel 1, 6, and 11 were tested individually.
3. Transfer rate, 11Mbps with CCK technique and 54Mbps with OFDM technique, the worst case, were chosen for final test.
4. Test result A is for CCK technique and test result B is for OFDM technique which presented in Section 4.

For 802.11a: Thirteen channels are provided to this EUT for Normal mode.

Channel	Frequency	Channel	Frequency
1	5180 MHz	8	5320 MHz
2	5200 MHz	9	5745MHz
3	5220 MHz	10	5765MHz
4	5240 MHz	11	5785MHz
5	5260 MHz	12	5805MHz
6	5280 MHz	13	5825MHz
7	5300 MHz		

Five channels are provided to this EUT for Turbo Mode.

Channel	Frequency	Channel	Frequency
1	5210 MHz	4	5760MHz
2	5250 MHz	5	5800MHz
3	5290 MHz		

NOTE:

- 1..The EUT was tested in both normal mode (channel bandwidth of approximately 30MHz) and turbo mode (channel bandwidth of approximately 60MHz).
2. "Normal Mode" allows data rates of up to 54Mbps. The device was, therefore, tested in Normal mode at the data rate that produced the highest output power for normal mode (6Mbps).
3. "Turbo Mode" allows data rates of up to 108Mbps. At data rates higher than 12Mbps the PA gain is reduced to improve signal fidelity. The device was, therefore, tested in turbo mode at the data rate that produced the highest output power for turbo mode (12Mbps).
4. Channel 1, 4, 5, 8, 9, 11 and 13 are the closest frequencies to the band edge, were chosen for final test of Normal Mode.
5. Channel 1 ~ 5 were chosen for final test of turbo mode.



3.3 GENERAL DESCRIPTION OF APPLIED STANDARDS

The EUT is an 802.11a/b/g PCI adapter card According to the specifications of the manufacturer, it must comply with the requirements of the following standards:

**47 CFR Part 15, Subpart C. (15.247),
Subpart E (15.407). ANSI C63.4 : 1992**

All tests have been performed and recorded as per the above standards.

NOTE: The EUT is also considered as a kind of computer peripheral, because the connection to computer is necessary for typical use. It has been verified to comply with the requirements of 47CFR Part 15, Subpart B, Class B (DoC). The test report has been issued separately.



3.4 DESCRIPTION OF SUPPORT UNITS

The EUT has been tested as an independent unit together with other necessary accessories or support units. The following support units or accessories were used to form a representative test configuration during the tests.

No.	Product	Brand	Model No.	Serial No.	FCC ID
1	PERSONAL COMPUTER	COMPAQ	EXM/P800/20C/9/64V TAI	7103FR4Z0065	FCC DoC
2	MONITOR	ADI	CM100	026058T10200531	FCC DoC
3	PRINTER	EPSON	LQ-300+	DCGY017082	FCC DoC
4	MODEM	ACEEX	1414	0206026780	IFAXDM1414
5	KEYBOARD	FORWARD	FDA-104GA	FDKB 8110056	F4ZFDA -104G
6	MOUSE	DEXIN	A2P800A	80102116	NA

No.	Signal cable description
1	NA
2	1.8 m braid shielded wire, terminated with VGA connector via metallic frame, w/o core.
3	1.8m braid shielded wire, terminated with DB25 and Centronics connector via metallic frame, w/o core.
4	1.3 m braid shielded wire, terminated with DB25 and DB9 connector via metallic frame, w/o core.
5	1.4 m foil shielded wire, terminal by frame, PS2 Connector, w/o Core.
6	NA

Note: 1. The power cords of the above support units were unshielded (1.8m).

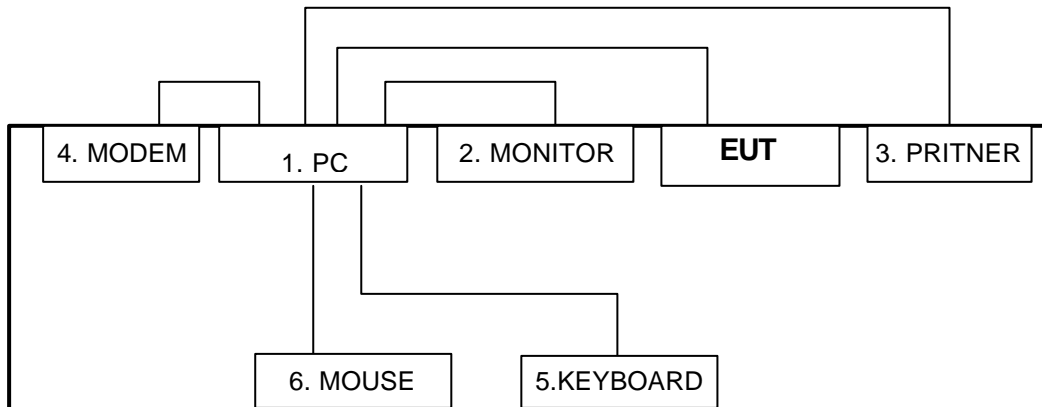

NOTE: 1. Please refer to the photos of test configuration in Item 6 also.



4. TEST TYPES AND RESULTS (FOR PART 802.11b)

4.1 CONDUCTED EMISSION MEASUREMENT

4.1.1 LIMITS OF CONDUCTED EMISSION MEASUREMENT

FREQUENCY (MHz)	Class A (dBuV)		Class B (dBuV)	
	Quasi-peak	Average	Quasi-peak	Average
0.15 - 0.5	79	66	66 - 56	56 - 46
0.50 - 5.0	73	60	56	46
5.0 - 30.0	73	60	60	50

- NOTES:**
- (1) The lower limit shall apply at the transition frequencies.
 - (2) The limit decreases in line with the logarithm of the frequency in the range of 0.15 to 0.50 MHz.
 - (3) All emanations from a class A/B digital device or system, including any network of conductors and apparatus connected thereto, shall not exceed the level of field strengths specified above.

4.1.2 TEST INSTRUMENTS

DESCRIPTION & MANUFACTURER	MODEL NO.	SERIAL NO.	CALIBRATED UNTIL
ROHDE & SCHWARZ Test Receiver	ESCS 30	847124/029	Nov. 17, 2003
ROHDE & SCHWARZ LISN (for EUT)	ESHS-Z5	848773/004	Nov. 13, 2003
KYORITSU LISN (for peripheral)	KNW-407	8/1395/12	Jul. 23, 2003
RF Cable (JETBAO)	RG233/U	Cable_CA_01	Jul. 03, 2003
Terminator(for KYORITSU)	50	3	Apr. 11, 2004
Software	Cond-V2e	NA	NA

- NOTE:**
1. The calibration interval of the above test instruments is 12 months and the calibrations are traceable to NML/ROC and NIST/USA.
 2. The test was performed in ADT Shielded Room No. A.
 3. The VCCI Con A Registration No. is C-817.



4.1.3 TEST PROCEDURES

- a. The EUT was placed 0.4 meters from the conducting wall of the shielded room with EUT being connected to the power mains through a line impedance stabilization network (LISN). Other support units were connected to the power mains through another LISN. The two LISNs provide 50 ohm/ 50uH of coupling impedance for the measuring instrument.
- b. Both lines of the power mains connected to the EUT were checked for maximum conducted interference.
- c. The frequency range from 150 kHz to 30 MHz was searched. Emission levels over 10dB under the prescribed limits could not be reported

4.1.4 DEVIATION FROM TEST STANDARD

No deviation

4.1.5 TEST SETUP

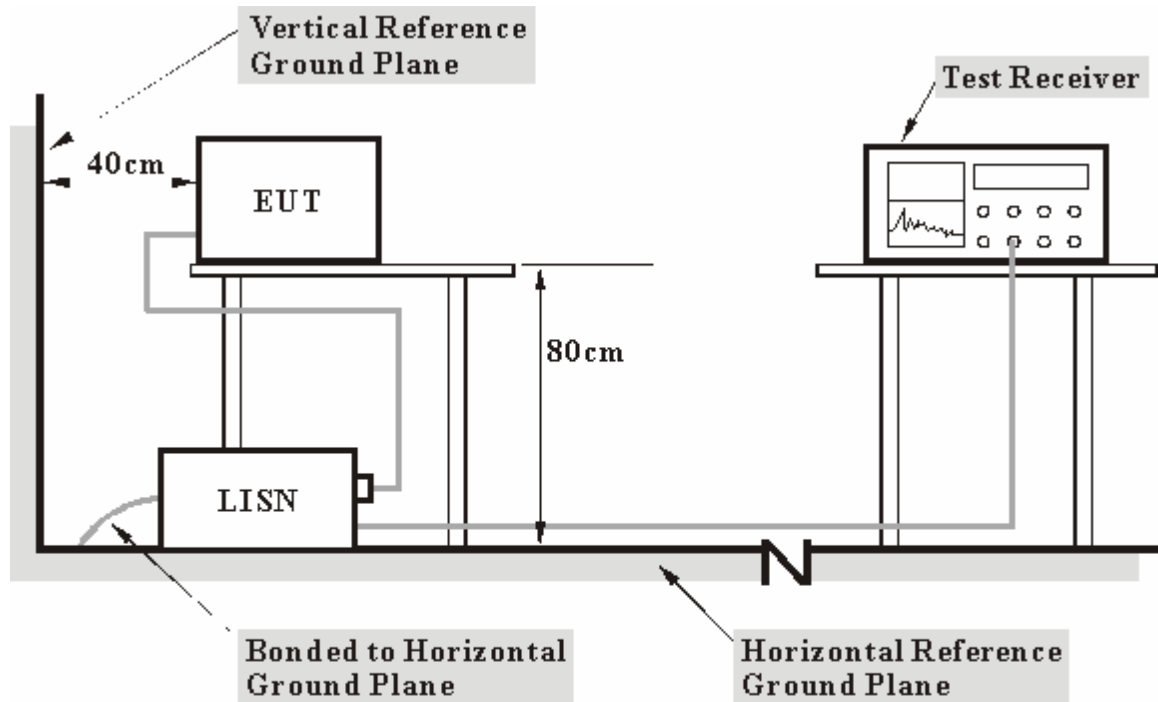

- Note:**
1. Support units were connected to second LISN.
 2. Both of LISNs (AMN) 80 cm from EUT and at the least 80 cm from other units and other metal planes support units.

For the actual test configuration, please refer to the related item – Photographs of the Test Configuration.

4.1.6 EUT OPERATING CONDITIONS

- a. Placed the EUT on the testing table.
- b. Prepared another computer system to act as a communication partner and placed it outside of testing area.
- c. The communication partner run a test program to enable EUT under transmission/receiving condition continuously at specific channel frequency via an RJ 45 cable and wireless.
- d. The communication partner sent data to EUT by command "PING".



4.1.7 TEST RESULTS

EUT	802.11a/b/g PCI adapter card	MODEL	8482-WD
MODE	Channel 1	6dB BANDWIDTH	9 kHz
INPUT POWER (SYSTEM)	120Vac, 60Hz	PHASE	Line (L)
ENVIRONMENTAL CONDITIONS	26deg. C, 57%RH, 965 hPa	TESTED BY	Tony Chen

No	Freq. [MHz]	Corr. Factor [dB]	Reading Value [dB (uV)]		Emission Level [dB (uV)]		Limit [dB (uV)]		Margin (dB)	
			Q.P.	AV.	Q.P.	AV.	Q.P.	AV.	Q.P.	AV.
			1	0.150	0.10	55.44	-	55.54	-	66.00
2	0.197	0.10	45.53	-	45.63	-	63.74	53.74	-18.11	-
3	0.298	0.10	39.50	-	39.60	-	60.29	50.29	-20.69	-
4	0.345	0.10	41.63	-	41.73	-	59.07	49.07	-17.34	-
5	0.392	0.10	38.44	-	38.54	-	58.02	48.02	-19.48	-
6	0.591	0.10	33.39	-	33.49	-	56.00	46.00	-22.51	-

- NOTES: (1) "***": Undetectable
 (2) Q.P. and AV. are abbreviations of quasi-peak and average.
 (3) "-": The Quasi-peak reading value also meets an average limit, thus measurement with the average detector is unnecessary.
 (4) The emission levels of other frequencies were very low against the limit.
 (5) Correction Factor = Insertion loss + Cable loss
 (6) Margin value = Emission level - Limit value

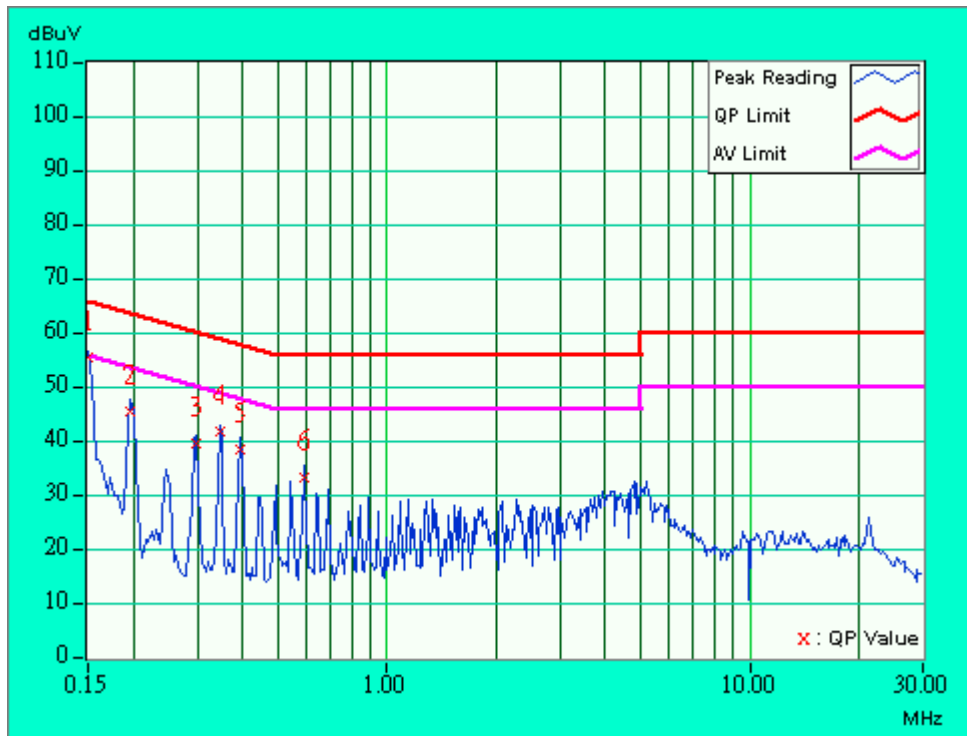



EUT	802.11a/b/g PCI adapter card	MODEL	8482-WD
MODE	Channel 1	6dB BANDWIDTH	9 kHz
INPUT POWER (SYSTEM)	120Vac, 60Hz	PHASE	Neutral (N)
ENVIRONMENTAL CONDITIONS	26deg. C, 57%RH, 965 hPa	TESTED BY	Tony Chen

No	Freq. [MHz]	Corr. Factor (dB)	Reading Value [dB (uV)]		Emission Level [dB (uV)]		Limit [dB (uV)]		Margin (dB)	
			Q.P.	AV.	Q.P.	AV.	Q.P.	AV.	Q.P.	AV.
			1	0.150	0.10	55.96	54.43	56.06	54.53	66.00
2	0.197	0.10	46.55	-	46.65	-	63.74	53.74	-17.09	-
3	0.298	0.10	40.61	-	40.71	-	60.29	50.29	-19.58	-
4	0.345	0.10	42.87	-	42.97	-	59.07	49.07	-16.10	-
5	0.396	0.10	41.94	-	42.04	-	57.93	47.93	-15.89	-
6	0.595	0.10	35.20	-	35.30	-	56.00	46.00	-20.70	-

- NOTES: (1) "": Undetectable
 (2) Q.P. and AV. are abbreviations of quasi-peak and average.
 (3) "-": The Quasi-peak reading value also meets an average limit, thus measurement with the average detector is unnecessary.
 (4) The emission levels of other frequencies were very low against the limit.
 (5) Correction Factor = Insertion loss + Cable loss
 (6) Margin value = Emission level - Limit value

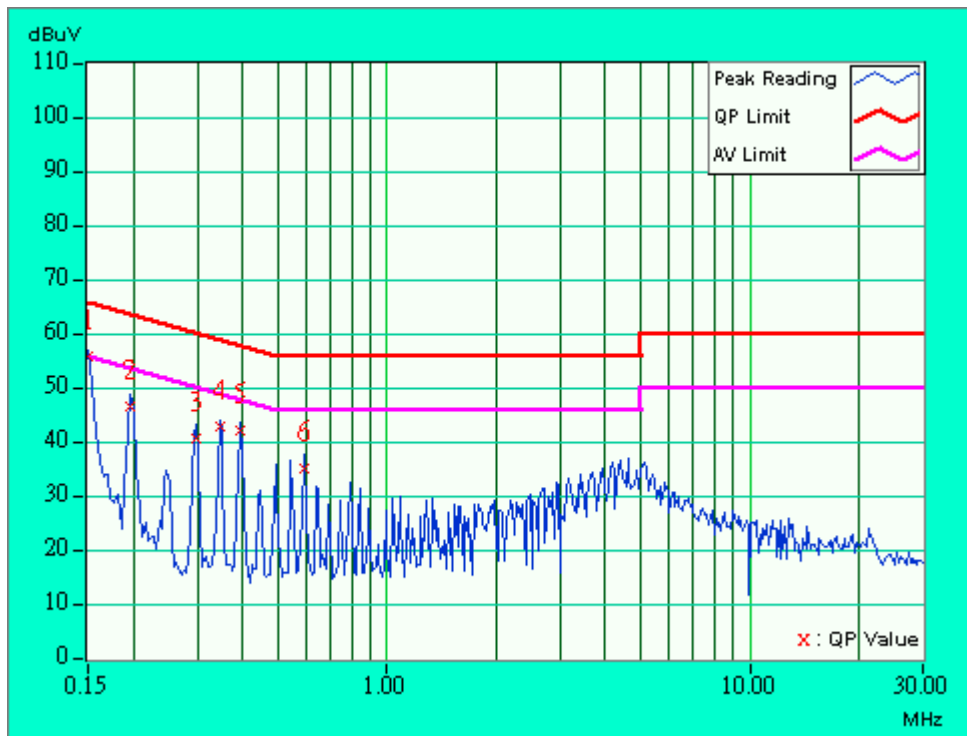



EUT	802.11a/b/g PCI adapter card	MODEL	8482-WD
MODE	Channel 6	6dB BANDWIDTH	9 kHz
INPUT POWER (SYSTEM)	120Vac, 60Hz	PHASE	Line (L)
ENVIRONMENTAL CONDITIONS	26deg. C, 57%RH, 965 hPa	TESTED BY	Tony Chen

No	Freq. [MHz]	Corr. Factor (dB)	Reading Value		Emission Level		Limit		Margin	
			[dB (uV)]		[dB (uV)]		[dB (uV)]		(dB)	
			Q.P.	AV.	Q.P.	AV.	Q.P.	AV.	Q.P.	AV.
1	0.150	0.10	55.31	-	55.41	-	66.00	56.00	-10.59	-
2	0.197	0.10	45.50	-	45.60	-	63.74	53.74	-18.14	-
3	0.295	0.10	39.10	-	39.20	-	60.40	50.40	-21.20	-
4	0.345	0.10	41.68	-	41.78	-	59.07	49.07	-17.29	-
5	0.396	0.10	39.57	-	39.67	-	57.93	47.93	-18.26	-
6	0.591	0.10	33.35	-	33.45	-	56.00	46.00	-22.55	-

- NOTES: (1) "": Undetectable
 (2) Q.P. and AV. are abbreviations of quasi-peak and average.
 (3) "-": The Quasi-peak reading value also meets an average limit, thus measurement with the average detector is unnecessary.
 (4) The emission levels of other frequencies were very low against the limit.
 (5) Correction Factor = Insertion loss + Cable loss
 (6) Margin value = Emission level - Limit value

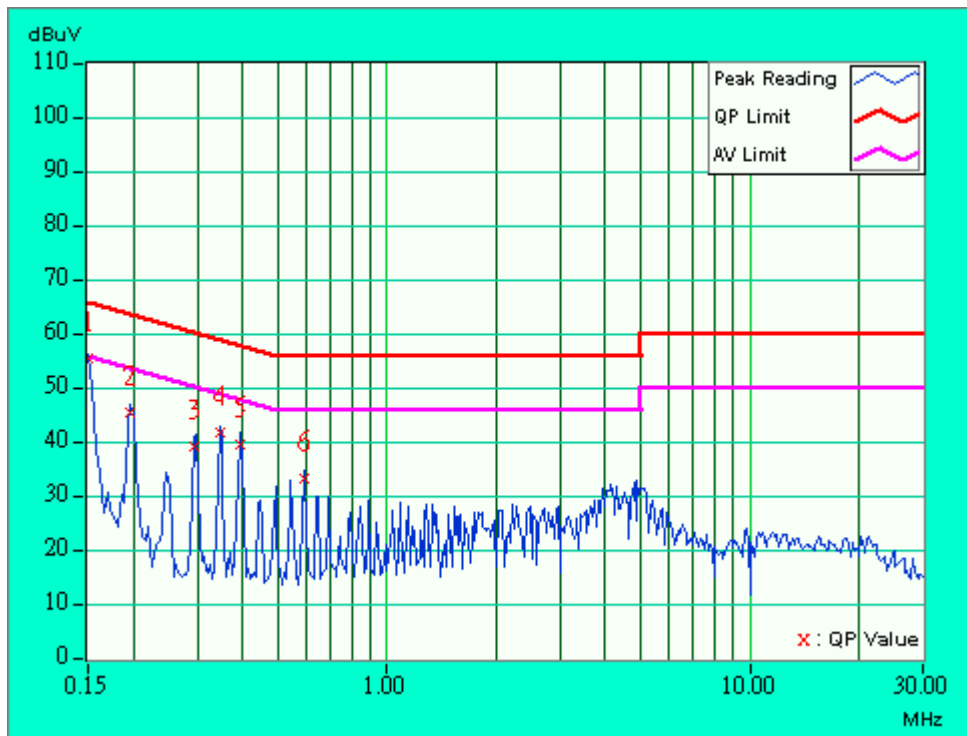



EUT	802.11a/b/g PCI adapter card	MODEL	8482-WD
MODE	Channel 6	6dB BANDWIDTH	9 kHz
INPUT POWER (SYSTEM)	120Vac, 60Hz	PHASE	Neutral (N)
ENVIRONMENTAL CONDITIONS	26deg. C, 57%RH, 965 hPa	TESTED BY	Tony Chen

No	Freq. [MHz]	Corr. Factor (dB)	Reading Value		Emission Level		Limit		Margin	
			[dB (uV)]		[dB (uV)]		[dB (uV)]		(dB)	
			Q.P.	AV.	Q.P.	AV.	Q.P.	AV.	Q.P.	AV.
1	0.150	0.10	55.46	-	55.56	-	66.00	56.00	-10.44	-
2	0.197	0.10	45.43	-	45.53	-	63.74	53.74	-18.21	-
3	0.295	0.10	38.69	-	38.79	-	60.40	50.40	-21.61	-
4	0.345	0.10	41.63	-	41.73	-	59.07	49.07	-17.34	-
5	0.396	0.10	39.65	-	39.75	-	57.93	47.93	-18.18	-
6	0.591	0.10	33.17	-	33.27	-	56.00	46.00	-22.73	-

- NOTES: (1) "***": Undetectable
 (2) Q.P. and AV. are abbreviations of quasi-peak and average.
 (3) "-": The Quasi-peak reading value also meets an average limit, thus measurement with the average detector is unnecessary.
 (4) The emission levels of other frequencies were very low against the limit.
 (5) Correction Factor = Insertion loss + Cable loss
 (6) Margin value = Emission level - Limit value

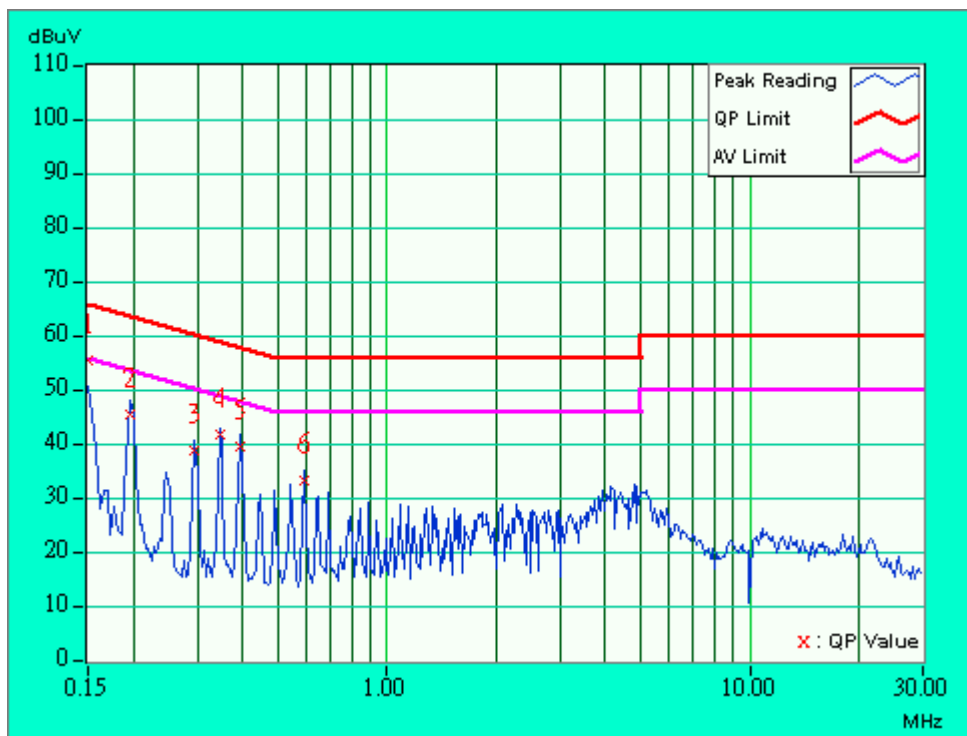



EUT	802.11a/b/g PCI adapter card	MODEL	8482-WD
MODE	Channel 11	6dB BANDWIDTH	9 kHz
INPUT POWER (SYSTEM)	120Vac, 60Hz	PHASE	Line (L)
ENVIRONMENTAL CONDITIONS	26deg. C, 57%RH, 965 hPa	TESTED BY	Tony Chen

No	Freq. [MHz]	Corr. Factor (dB)	Reading Value		Emission Level		Limit		Margin	
			[dB (uV)]		[dB (uV)]		[dB (uV)]		(dB)	
			Q.P.	AV.	Q.P.	AV.	Q.P.	AV.	Q.P.	AV.
1	0.150	0.10	55.46	-	55.56	-	66.00	56.00	-10.44	-
2	0.197	0.10	45.43	-	45.53	-	63.74	53.74	-18.21	-
3	0.295	0.10	38.69	-	38.79	-	60.40	50.40	-21.61	-
4	0.345	0.10	41.63	-	41.73	-	59.07	49.07	-17.34	-
5	0.396	0.10	39.65	-	39.75	-	57.93	47.93	-18.18	-
6	0.591	0.10	33.17	-	33.27	-	56.00	46.00	-22.73	-

- NOTES: (1) "": Undetectable
 (2) Q.P. and AV. are abbreviations of quasi-peak and average.
 (3) "-": The Quasi-peak reading value also meets an average limit, thus measurement with the average detector is unnecessary.
 (4) The emission levels of other frequencies were very low against the limit.
 (5) Correction Factor = Insertion loss + Cable loss
 (6) Margin value = Emission level - Limit value

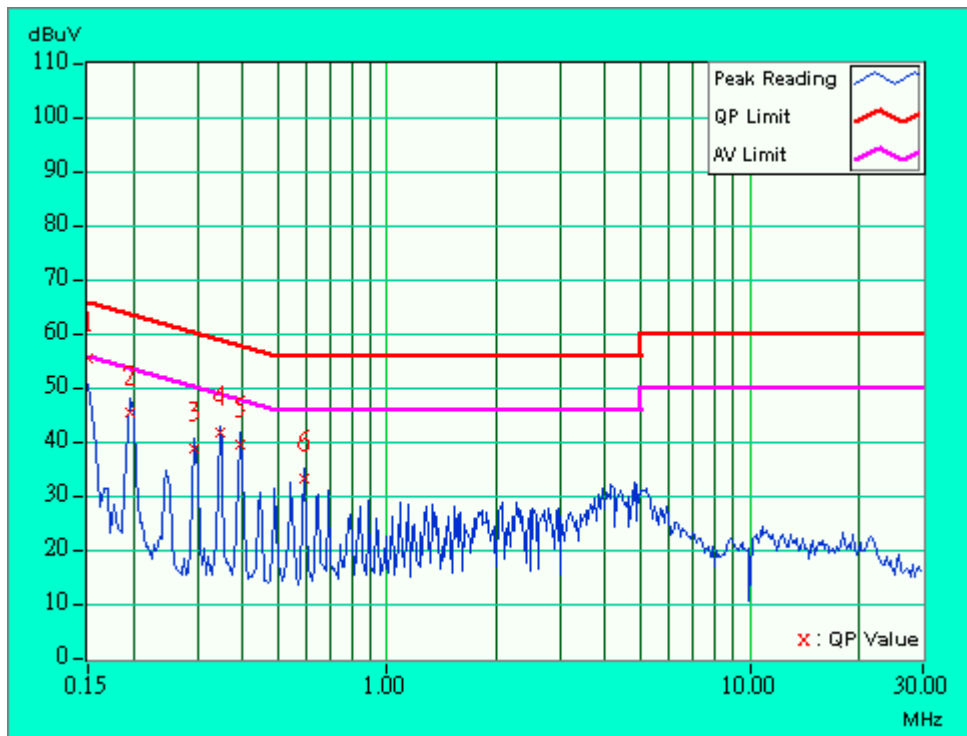



EUT	802.11a/b/g PCI adapter card	MODEL	8482-WD
MODE	Channel 11	6dB BANDWIDTH	9 kHz
INPUT POWER (SYSTEM)	120Vac, 60Hz	PHASE	Neutral (N)
ENVIRONMENTAL CONDITIONS	26deg. C, 57%RH, 965 hPa	TESTED BY	Tony Chen

No	Freq. [MHz]	Corr. Factor (dB)	Reading Value [dB (uV)]		Emission Level [dB (uV)]		Limit [dB (uV)]		Margin (dB)	
			Q.P.	AV.	Q.P.	AV.	Q.P.	AV.	Q.P.	AV.
			1	0.150	0.10	55.84	-	55.94	-	66.00
2	0.197	0.10	46.31	-	46.41	-	63.74	53.74	-17.33	-
3	0.297	0.10	41.51	-	41.61	-	60.32	50.32	-18.71	-
4	0.345	0.10	42.87	-	42.97	-	59.07	49.07	-16.10	-
5	0.396	0.10	41.52	-	41.62	-	57.93	47.93	-16.31	-
6	4.113	0.21	35.41	-	35.62	-	56.00	46.00	-20.38	-

- NOTES: (1) "": Undetectable
 (2) Q.P. and AV. are abbreviations of quasi-peak and average.
 (3) "-": The Quasi-peak reading value also meets an average limit, thus measurement with the average detector is unnecessary.
 (4) The emission levels of other frequencies were very low against the limit.
 (5) Correction Factor = Insertion loss + Cable loss
 (6) Margin value = Emission level - Limit value

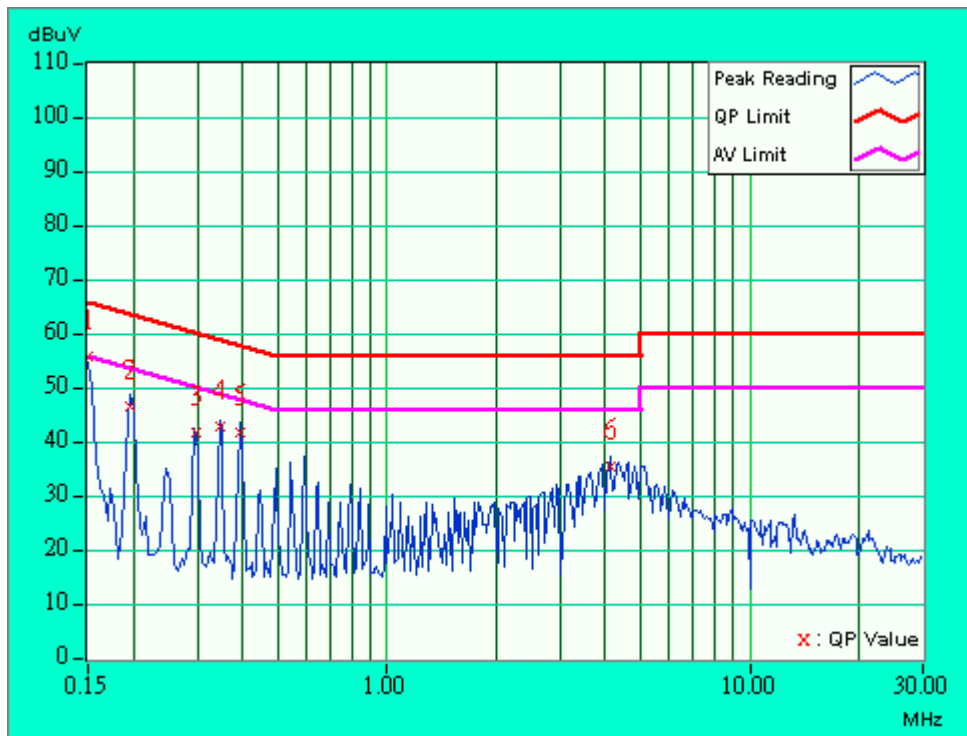



4.2 RADIATED EMISSION MEASUREMENT

4.2.1 LIMITS OF RADIATED EMISSION MEASUREMENT

Emissions radiated outside of the specified bands, shall be according to the general radiated limits in 15.209 as following:

Frequencies (MHz)	Field strength (microvolts/meter)	Measurement distance (meters)
0.009-0.490	2400/F(kHz)	300
0.490-1.705	24000/F(kHz)	30
1.705-30.0	30	30
30-88	100	3
88-216	150	3
216-960	200	3
Above 960	500	3

NOTE

1. The lower limit shall apply at the transition frequencies.
2. Emission level (dBuV/m) = 20 log Emission level (uV/m).
3. As shown in 15.35(b), for frequencies above 1000MHz, the field strength limits are based on average detector, however, the peak field strength of any emission shall not exceed the maximum permitted average limits, specified above by more than 20dB under any condition of modulation.



4.2.2 TEST INSTRUMENTS

DESCRIPTION & MANUFACTURER	MODEL NO.	SERIAL NO.	CALIBRATED UNTIL
HP Spectrum Analyzer	8594ER	3829U04676	Jul. 14, 2003
ADVANTEST Spectrum Analyzer	R3271A	85060311	May 21, 2004
CHASE RF Pre_Amplifier	CPA9232	1057	Apr. 24, 2004
HP Pre_Amplifier	8449B	3008A01281	June 27, 2004
ROHDE & SCHWARZ Test Receiver	ESVS 10	849231 /019	Nov. 03, 2003
CHASE Broadband Antenna	CBL6111c	2730	Jul 17, 2003
Schwarzbeck Horn_Antenna	BBHA9120-D1	D123	Jul. 31, 2003
SCHWARZBECK Tunable Dipole Antenna	UHAP	897	Mar. 07, 2005
SCHWARZBECK Tunable Dipole Antenna	VHAP	880	Mar. 07, 2005
RF Switches (ARNITSU)	CS-201	1565157	Jul. 29, 2003
RF CABLE (Chaintek) 1GHz-20GHz	Ak 9515-D	001	Aug. 20.2003
RF Cable(RICHTEC)	9913-30M	STCCAB-30M-1GH z-021	Nov. 5, 2003
Software	AS60P8	NA	NA
CHANCE MOST Antenna Tower	AT-100	0203	NA
CHANCE MOST Turn Table	TT-100	0203	NA

Note: 1. The calibration interval of the above test instruments is 12 months (36 months for Tunable Dipole Antenna) and the calibrations are traceable to NML/ROC and NIST/USA.

2. * = These equipment are used for the final measurement.
3. The horn antenna and HP preamplifier (model: 8449B) are used only for the measurement of emission frequency above 1GHz if tested.
4. The test was performed in ADT Open Site No. C.
5. The FCC Site Registration No. is 656396.
6. The VCCI Site Registration No. is R-1626.



4.2.3 TEST PROCEDURES

- a. The EUT was placed on the top of a rotating table 0.8 meters above the ground at a 10 meter open area test site. The table was rotated 360 degrees to determine the position of the highest radiation.
- b. The EUT was set 3 meters away from the interference-receiving antenna, which was mounted on the top of a variable-height antenna tower.
- c. The antenna is a broadband antenna, and its height is varied from one meter to four meters above the ground to determine the maximum value of the field strength. Both horizontal and vertical polarizations of the antenna are set to make the measurement.
- d. For each suspected emission, the EUT was arranged to its worst case and then the antenna was tuned to heights from 1 meter to 4 meters and the rotatable table was turned from 0 degrees to 360 degrees to find the maximum reading.
- e. The test-receiver system was set to Peak Detect Function and Specified Bandwidth with Maximum Hold Mode.
- f. If the emission level of the EUT in peak mode was 10 dB lower than the limit specified, then testing could be stopped and the peak values of the EUT would be reported. Otherwise the emissions that did not have 10 dB margin would be re-tested one by one using the quasi-peak method or average method as specified and then reported in Data sheet peak mode and QP mode.

NOTE:

1. The resolution bandwidth and video bandwidth of test receiver/spectrum analyzer is 120kHz for Quasi-peak detection at frequency below 1GHz.
2. The resolution bandwidth and video bandwidth of test receiver/spectrum analyzer is 1 MHz for Peak detection (PK) at frequency above 1GHz.
3. The resolution bandwidth of test receiver/spectrum analyzer is 1 MHz and the video bandwidth is 300 Hz for Average detection (AV) at frequency above 1GHz.

4.2.4 DEVIATION FROM TEST STANDARD

No deviation

4.2.5 TEST SETUP

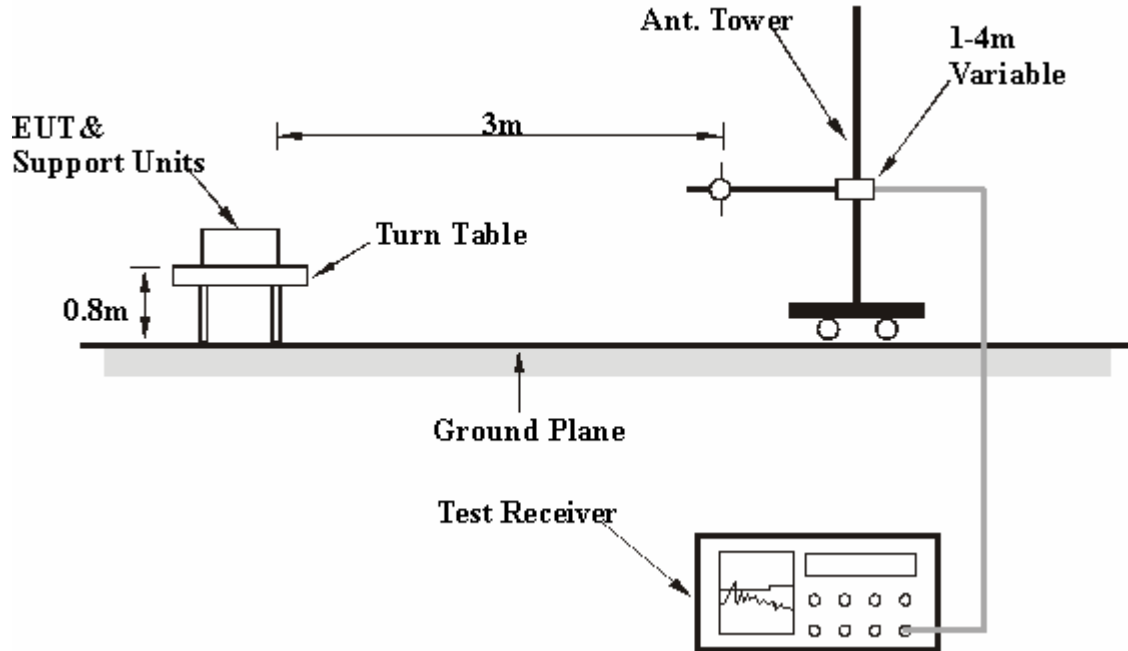

For the actual test configuration, please refer to the related item – Photographs of the Test Configuration.

4.2.6 EUT OPERATING CONDITIONS

Same as 4.1.6



4.2.7 TEST RESULTS

EUT	802.11a/b/g PCI adapter card	MODEL	8482-WD
MODE	Channel 11	FREQUENCY RANGE	Below 1000 MHz
INPUT POWER (SYSTEM)	120Vac, 60Hz	DETECTOR FUNCTION	Quasi-Peak
ENVIRONMENTAL CONDITIONS	19deg. C, 60%RH, 965 hPa	TESTED BY	Eric Lee

ANTENNA POLARITY & TEST DISTANCE: HORIZONTAL AT 3 M

No.	Freq. (MHz)	Emission Level (dBuV/m)	Limit (dBuV/m)	Margin (dB)	Antenna Height (m)	Table Angle (Degree)	Raw Value (dBuV)	Correction Factor (dB/m)
1	123.12	21.6 QP	43.50	-21.90	1.43 H	79	9.60	11.90
2	125.01	24.6 QP	43.50	-18.90	1.22 H	288	12.40	12.10
3	250.02	27.2 QP	46.00	-18.80	1.17 H	57	14.00	13.20
4	263.82	21.6 QP	46.00	-24.40	1.49 H	97	7.60	14.10
5	330.50	23.7 QP	46.00	-22.30	1.54 H	75	8.80	14.90
6	375.03	26.1 QP	46.00	-19.90	1.38 H	102	9.80	16.20
7	468.01	25.3 QP	46.00	-20.70	1.37 H	225	6.70	18.60
8	480.01	25.6 QP	46.00	-20.40	1.50 H	146	6.70	18.90
9	499.99	22.3 QP	46.00	-23.70	1.00 H	38	3.00	19.30
10	598.34	24.2 QP	46.00	-21.80	1.15 H	292	3.20	20.90

ANTENNA POLARITY & TEST DISTANCE: VERTICAL AT 3 M

No.	Freq. (MHz)	Emission Level (dBuV/m)	Limit (dBuV/m)	Margin (dB)	Antenna Height (m)	Table Angle (Degree)	Raw Value (dBuV)	Correction Factor (dB/m)
1	47.80	25.6 QP	40.00	-14.40	1.03 V	236	15.90	9.70
2	196.62	22.6 QP	43.50	-20.90	1.00 V	248	13.40	9.20
3	264.01	23.1 QP	46.00	-22.90	1.11 V	0	9.10	14.10
4	312.01	21.4 QP	46.00	-24.60	1.02 V	25	7.00	14.40
5	323.92	24.4 QP	46.00	-21.60	1.13 V	245	9.70	14.70
6	352.06	24.2 QP	46.00	-21.80	1.30 V	151	8.60	15.60
7	374.50	26.5 QP	46.00	-19.50	1.54 V	19	10.30	16.20
8	468.07	29.5 QP	46.00	-16.50	1.41 V	335	10.90	18.60
9	480.54	25.3 QP	46.00	-20.70	1.15 V	358	6.40	18.90
10	639.24	31.0 QP	46.00	-15.00	1.06 V	2	9.10	21.90

- REMARKS:**
1. Emission level(dBuV/m)=Raw Value(dBuV) + Correction Factor(dB)
 2. Correction Factor(dB/m) = Antenna Factor (dB/m) + Cable Factor (dB)
 3. The other emission levels were very low against the limit.
 4. Margin value = Emission level – Limit value.
 5. The limit value is defined as per 15.247



TEST RESULTS(A)- DSSS

EUT	802.11a/b/g PCI adapter card	MODEL	8482-WD
MODE	Channel 1	FREQUENCY RANGE	Above 1000 MHz
INPUT POWER (SYSTEM)	120Vac, 60Hz	DETECTOR FUNCTION	Peak(PK) Average (AV)
ENVIRONMENTAL CONDITIONS	20deg. C, 58%RH, 965 hPa	TESTED BY	Eric Lee

ANTENNA POLARITY & TEST DISTANCE: HORIZONTAL AT 3 M

No.	Freq. (MHz)	Emission Level (dBuV/m)	Limit (dBuV/m)	Margin (dB)	Antenna Height (m)	Table Angle (Degree)	Raw Value (dBuV)	Correction Factor (dB/m)
1	2336.00	53.6 PK	74.00	-20.40	1.33 H	320	24.00	29.60
1	2336.00	44.9 AV	54.00	-9.10	1.33 H	320	15.30	29.60
2	2368.00	57.7 PK	74.00	-16.30	1.22 H	348	28.00	29.70
2	2368.00	47.7 AV	54.00	-6.30	1.22 H	348	18.00	29.70
3	2390.00	55.4 PK	68.30	-12.90	1.22 H	61	25.60	29.80
3	2390.00	45.2 AV	54.00	-8.80	1.22 H	61	15.40	29.80
4	*2412.00	96.4 PK			1.27 H	328	66.50	29.90
4	*2412.00	90.1 AV			1.27 H	328	60.20	29.90
5	4824.00	42.2 PK	74.00	-31.80	1.15 H	141	6.00	36.20

ANTENNA POLARITY & TEST DISTANCE: VERTICAL AT 3 M

No.	Freq. (MHz)	Emission Level (dBuV/m)	Limit (dBuV/m)	Margin (dB)	Antenna Height (m)	Table Angle (Degree)	Raw Value (dBuV)	Correction Factor (dB/m)
1	2336.00	57.9 PK	74.00	-16.10	1.27 V	350	28.20	29.60
1	2336.00	47.4 AV	54.00	-6.60	1.27 V	350	17.80	29.60
2	2368.00	59.3 PK	74.00	-14.70	1.33 V	240	29.60	29.70
2	2368.00	50.3 AV	54.00	-3.70	1.33 V	240	20.60	29.70
3	2390.00	58.2 PK	68.30	-10.10	1.29 V	237	28.40	29.80
3	2390.00	47.8 AV	54.00	-6.20	1.29 V	237	18.00	29.80
4	*2412.00	103.8 PK			1.25 V	241	73.90	29.90
4	*2412.00	97.2 AV			1.25 V	241	67.30	29.90
5	2484.00	55.3 PK	74.00	-18.70	1.02 V	247	25.10	30.10
5	2484.00	45.4 AV	54.00	-8.60	1.02 V	247	15.20	30.10
6	4824.00	42.4 PK	74.00	-31.60	1.24 V	4	6.20	36.20

- NOTE:**
1. Emission level = Raw Value - Correction Factor
 2. Correction Factor = External Preamp. Gain - Ant. Factor - Cable loss
(External Preamp. Gain = 0, when the test receiver is used for the test.)
 3. The other emission levels were very low against the limit.
 4. Margin value = Emission level - Limit value
 5. The limit value is defined as per 15.247
 6. " * " : Fundamental frequency



EUT	802.11a/b/g PCI adapter card	MODEL	8482-WD
MODE	Channel 6	FREQUENCY RANGE	Above 1000 MHz
INPUT POWER (SYSTEM)	120Vac, 60Hz	DETECTOR FUNCTION	Peak(PK) Average (AV)
ENVIRONMENTAL CONDITIONS	20deg. C, 58%RH, 965 hPa	TESTED BY	Eric Lee

ANTENNA POLARITY & TEST DISTANCE: HORIZONTAL AT 3 M

No.	Freq. (MHz)	Emission Level (dBuV/m)	Limit (dBuV/m)	Margin (dB)	Antenna Height (m)	Table Angle (Degree)	Raw Value (dBuV)	Correction Factor (dB/m)
1	2390.00	52.1 PK	68.30	-16.20	1.02 H	236	22.30	29.80
1	2390.00	42.0 AV	54.00	-12.00	1.02 H	236	12.20	29.80
2	*2437.00	97.2 PK			1.24 H	315	67.30	30.00
2	*2437.00	90.2 AV			1.24 H	315	60.20	30.00
3	2484.00	52.8 PK	74.00	-21.20	1.41 H	332	22.60	30.10
3	2484.00	41.4 AV	54.00	-12.60	1.41 H	332	11.20	30.10
4	4874.00	41.9 PK	74.00	-32.10	1.20 H	14	5.50	36.50

ANTENNA POLARITY & TEST DISTANCE: VERTICAL AT 3 M

No.	Freq. (MHz)	Emission Level (dBuV/m)	Limit (dBuV/m)	Margin (dB)	Antenna Height (m)	Table Angle (Degree)	Raw Value (dBuV)	Correction Factor (dB/m)
1	2390.00	55.1 PK	68.30	-13.20	1.02 V	201	25.30	29.80
1	2390.00	44.0 AV	54.00	-10.00	1.02 V	201	14.20	29.80
2	*2437.00	103.0 PK			1.54 V	247	73.10	30.00
2	*2437.00	97.0 AV			1.54 V	247	67.00	30.00
3	2484.00	54.2 PK	74.00	-19.80	1.65 V	262	24.00	30.10
3	2484.00	44.4 AV	54.00	-9.60	1.65 V	262	14.30	30.10
4	4874.00	43.6 PK	74.00	-30.40	1.56 V	320	7.10	36.50

- NOTE:**
1. Emission level = Raw Value - Correction Factor
 2. Correction Factor = External Preamp. Gain - Ant. Factor - Cable loss
(External Preamp. Gain = 0, when the test receiver is used for the test.)
 3. The other emission levels were very low against the limit.
 4. Margin value = Emission level - Limit value
 5. The limit value is defined as per 15.247
 6. " * " : Fundamental frequency



EUT	802.11a/b/g PCI adapter card	MODEL	8482-WD
MODE	Channel 11	FREQUENCY RANGE	Above 1000 MHz
INPUT POWER (SYSTEM)	120Vac, 60Hz	DETECTOR FUNCTION	Peak(PK) Average (AV)
ENVIRONMENTAL CONDITIONS	20deg. C, 58%RH, 965 hPa	TESTED BY	Eric Lee

ANTENNA POLARITY & TEST DISTANCE: HORIZONTAL AT 3M

No.	Freq. (MHz)	Emission Level (dBuV/m)	Limit (dBuV/m)	Margin (dB)	Antenna Height (m)	Table Angle (Degree)	Raw Value (dBuV)	Correction Factor (dB/m)
1	2390.00	52.2 PK	68.30	-16.10	1.25 H	247	22.40	29.80
1	2390.00	42.1 AV	54.00	-11.90	1.25 H	247	12.30	29.80
2	*2462.00	97.3 PK			1.28 H	340	67.30	30.10
2	*2462.00	90.4 AV			1.28 H	340	60.40	30.10
3	2484.00	55.4 PK	74.00	-18.60	1.47 H	241	25.30	30.10
3	2484.00	45.4 AV	54.00	-8.60	1.47 H	241	15.20	30.10
4	2496.00	55.8 PK	74.00	-18.20	1.47 H	201	25.60	30.20
4	2496.00	44.7 AV	54.00	-9.30	1.47 H	201	14.60	30.20
5	4924.00	42.6 PK	74.00	-31.40	1.42 H	227	5.90	36.70

ANTENNA POLARITY & TEST DISTANCE: VERTICAL AT 3M

No.	Freq. (MHz)	Emission Level (dBuV/m)	Limit (dBuV/m)	Margin (dB)	Antenna Height (m)	Table Angle (Degree)	Raw Value (dBuV)	Correction Factor (dB/m)
1	2390.00	54.2 PK	68.30	-14.10	1.35 V	247	24.40	29.80
1	2390.00	45.0 AV	54.00	-9.00	1.35 V	247	15.20	29.80
2	*2462.00	104.5 PK			1.20 V	349	74.40	30.10
2	*2462.00	97.8 AV			1.20 V	349	67.70	30.10
3	2484.00	60.6 PK	74.00	-13.40	1.02 V	331	30.50	30.10
3	2484.00	51.9 AV	54.00	-2.10	1.02 V	331	21.80	30.10
4	2496.00	57.8 PK	74.00	-16.20	1.00 V	166	27.60	30.20
4	2496.00	49.6 AV	54.00	-4.40	1.00 V	166	19.40	30.20
5	4924.00	44.3 PK	74.00	-29.70	1.25 V	356	7.60	36.70

- NOTE:**
1. Emission level= Raw Value - Correction Factor
 2. Correction Factor = External Preamp. Gain - Ant. Factor - Cable loss
(External Preamp. Gain = 0, when the test receiver is used for the test.)
 3. The other emission levels were very low against the limit.
 4. Margin value = Emission level - Limit value
 5. The limit value is defined as per 15.247
 6. " * " : Fundamental frequency



TEST RESULTS (B)- OFDM

EUT	802.11a/b/g PCI adapter card	MODEL	8482-WD
MODE	Channel 1	FREQUENCY RANGE	Above 1000 MHz
INPUT POWER (SYSTEM)	120Vac, 60Hz	DETECTOR FUNCTION	Peak(PK) Average (AV)
ENVIRONMENTAL CONDITIONS	20deg. C, 58%RH, 965 hPa	TESTED BY	Eric Lee

ANTENNA POLARITY & TEST DISTANCE: HORIZONTAL AT 3 M

No.	Freq. (MHz)	Emission Level (dBuV/m)	Limit (dBuV/m)	Margin (dB)	Antenna Height (m)	Table Angle (Degree)	Raw Value (dBuV)	Correction Factor (dB/m)
1	2368.00	58.3 PK	74.00	-15.70	1.40 H	309	28.60	29.70
1	2368.00	44.6 AV	54.00	-9.40	1.40 H	309	14.90	29.70
2	2390.00	58.5 PK	68.30	-9.80	1.43 H	349	28.70	29.80
2	2390.00	45.4 AV	54.00	-8.60	1.43 H	349	15.60	29.80
3	*2412.00	94.8 PK			1.42 H	358	64.90	29.90
3	*2412.00	88.1 AV			1.42 H	358	58.20	29.90
4	2484.00	52.4 PK	74.00	-21.60	1.24 H	300	22.30	30.10
4	2484.00	42.5 AV	54.00	-11.50	1.24 H	300	12.30	30.10
5	4824.00	41.1 PK	74.00	-32.90	1.33 H	59	4.80	36.20

ANTENNA POLARITY & TEST DISTANCE: VERTICAL AT 3 M

No.	Freq. (MHz)	Emission Level (dBuV/m)	Limit (dBuV/m)	Margin (dB)	Antenna Height (m)	Table Angle (Degree)	Raw Value (dBuV)	Correction Factor (dB/m)
1	2368.00	58.4 PK	74.00	-15.60	1.37 V	30	28.70	29.70
1	2368.00	49.8 AV	54.00	-4.20	1.37 V	30	20.10	29.70
2	2390.00	65.7 PK	68.30	-2.60	1.53 V	347	35.90	29.80
2	2390.00	52.9 AV	54.00	-1.10	1.53 V	347	23.10	29.80
3	*2412.00	102.3 PK			1.29 V	30	72.40	29.90
3	*2412.00	93.0 AV			1.29 V	30	63.10	29.90
4	2484.00	55.8 PK	74.00	-18.20	1.47 V	222	25.70	30.10
4	2484.00	44.4 AV	54.00	-9.60	1.47 V	222	14.20	30.10
5	4824.00	42.7 PK	74.00	-31.30	1.00 V	247	6.40	36.20

- NOTE:**
1. Emission level = Raw Value - Correction Factor
 2. Correction Factor = External Preamp. Gain - Ant. Factor - Cable loss
(External Preamp. Gain = 0, when the test receiver is used for the test.)
 3. The other emission levels were very low against the limit.
 4. Margin value = Emission level - Limit value
 5. The limit value is defined as per 15.247
 6. " * " : Fundamental frequency



EUT	802.11a/b/g PCI adapter card	MODEL	8482-WD
MODE	Channel 6	FREQUENCY RANGE	Above 1000 MHz
INPUT POWER (SYSTEM)	120Vac, 60Hz	DETECTOR FUNCTION	Peak(PK) Average (AV)
ENVIRONMENTAL CONDITIONS	20deg. C, 58%RH, 965 hPa	TESTED BY	Eric Lee

ANTENNA POLARITY & TEST DISTANCE: HORIZONTAL AT 3 M

No.	Freq. (MHz)	Emission Level (dBuV/m)	Limit (dBuV/m)	Margin (dB)	Antenna Height (m)	Table Angle (Degree)	Raw Value (dBuV)	Correction Factor (dB/m)
1	2390.00	52.1 PK	68.30	-16.20	1.54 H	27	22.30	29.80
1	2390.00	42.1 AV	54.00	-11.90	1.54 H	27	12.30	29.80
2	*2437.00	95.9 PK			1.23 H	358	66.00	30.00
2	*2437.00	87.2 AV			1.23 H	358	57.20	30.00
3	2484.00	17.1 PK	74.00	-56.90	1.02 H	333	-13.10	30.10
4	4874.00	41.6 PK	74.00	-32.40	1.32 H	247	5.10	36.50

ANTENNA POLARITY & TEST DISTANCE: VERTICAL AT 3 M

No.	Freq. (MHz)	Emission Level (dBuV/m)	Limit (dBuV/m)	Margin (dB)	Antenna Height (m)	Table Angle (Degree)	Raw Value (dBuV)	Correction Factor (dB/m)
1	2390.00	53.8 PK	68.30	-14.50	1.03 V	269	24.00	29.80
1	2390.00	44.0 AV	54.00	-10.00	1.03 V	269	14.20	29.80
2	*2437.00	103.1 PK			1.27 V	351	73.10	30.00
2	*2437.00	93.6 AV			1.27 V	351	63.60	30.00
3	2484.00	54.0 PK	74.00	-20.00	1.63 V	327	23.90	30.10
3	2484.00	44.3 AV	54.00	-9.70	1.63 V	327	14.20	30.10
4	4874.00	43.9 PK	74.00	-30.10	1.54 V	71	7.40	36.50

- NOTE:**
1. Emission level = Raw Value - Correction Factor
 2. Correction Factor = External Preamp. Gain - Ant. Factor - Cable loss
(External Preamp. Gain = 0, when the test receiver is used for the test.)
 3. The other emission levels were very low against the limit.
 4. Margin value = Emission level - Limit value
 5. The limit value is defined as per 15.247
 6. " * " : Fundamental frequency



EUT	802.11a/b/g PCI adapter card	MODEL	8482-WD
MODE	Channel 11	FREQUENCY RANGE	Above 1000 MHz
INPUT POWER (SYSTEM)	120Vac, 60Hz	DETECTOR FUNCTION	Peak(PK) Average (AV)
ENVIRONMENTAL CONDITIONS	20deg. C, 58%RH, 965 hPa	TESTED BY	Eric Lee

ANTENNA POLARITY & TEST DISTANCE: HORIZONTAL AT 3M

No.	Freq. (MHz)	Emission Level (dBuV/m)	Limit (dBuV/m)	Margin (dB)	Antenna Height (m)	Table Angle (Degree)	Raw Value (dBuV)	Correction Factor (dB/m)
1	2390.00	51.1 PK	68.30	-17.20	1.10 H	2	21.30	29.80
1	2390.00	43.0 AV	54.00	-11.00	1.10 H	2	13.20	29.80
2	*2462.00	83.2 PK			1.42 H	261	53.10	30.10
2	*2462.00	86.0 AV			1.42 H	261	55.90	30.10
3	2484.00	58.8 PK	74.00	-15.20	1.43 H	82	28.60	30.10
3	2484.00	44.9 AV	54.00	-9.10	1.43 H	82	14.70	30.10
4	2496.00	55.4 PK	74.00	-18.60	1.50 H	212	25.20	30.20
4	2496.00	46.8 AV	54.00	-7.20	1.50 H	212	16.60	30.20
5	4924.00	43.3 PK	74.00	-30.70	1.27 H	111	6.60	36.70

ANTENNA POLARITY & TEST DISTANCE: VERTICAL AT 3M

No.	Freq. (MHz)	Emission Level (dBuV/m)	Limit (dBuV/m)	Margin (dB)	Antenna Height (m)	Table Angle (Degree)	Raw Value (dBuV)	Correction Factor (dB/m)
1	2390.00	54.1 PK	68.30	-14.20	1.02 V	247	24.30	29.80
1	2390.00	45.0 AV	54.00	-9.00	1.02 V	247	15.20	29.80
2	*2462.00	101.4 PK			1.25 V	350	71.30	30.10
2	*2462.00	93.0 AV			1.25 V	350	62.90	30.10
3	2484.00	66.7 PK	74.00	-7.30	1.36 V	10	36.50	30.10
3	2484.00	50.9 AV	54.00	-3.10	1.36 V	10	20.80	30.10
4	2496.00	61.3 PK	74.00	-12.70	1.30 V	342	31.10	30.20
4	2496.00	52.4 AV	54.00	-1.60	1.30 V	342	22.20	30.20
5	4924.00	43.3 PK	74.00	-30.70	1.54 V	74	6.60	36.70

- NOTE:**
1. Emission level= Raw Value - Correction Factor
 2. Correction Factor = External Preamp. Gain - Ant. Factor - Cable loss
(External Preamp. Gain = 0, when the test receiver is used for the test.)
 3. The other emission levels were very low against the limit.
 4. Margin value = Emission level - Limit value
 5. The limit value is defined as per 15.247
 6. " * " : Fundamental frequency



4.3 6dB BANDWIDTH MEASUREMENT

4.3.1 LIMITS OF 6dB BANDWIDTH MEASUREMENT

The minimum of 6dB Bandwidth Measurement is 0.5 MHz.

4.3.2 TEST INSTRUMENTS

Description & Manufacturer	Model No.	Serial No.	Calibrated Until
R&S SPECTRUM ANALYZER	FSP	1093.4495.30	Dec. 19, 2003

NOTE:

- 1.The measurement uncertainty is less than +/- 2.6dB, which is calculated as per the NAMAS document NIS81.
- 2.The calibration interval of the above test instruments is 12 months and the calibrations are traceable to NML/ROC and NIST/USA.

4.3.3 TEST PROCEDURE

The transmitter output was connected to the spectrum analyzer through an attenuator. The bandwidth of the fundamental frequency was measured by spectrum analyzer with 100kHz RBW and 100kHz VBW. The 6dB bandwidth is defined as the total spectrum the power of which is higher than peak power minus 6 dB.

4.3.4 DEVIATION FROM TEST STANDARD

No deviation

4.3.5 TEST SETUP

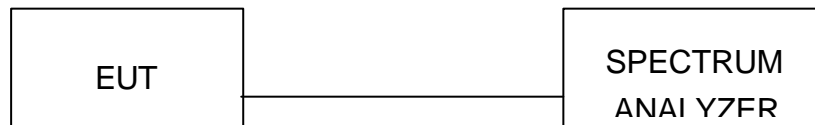

4.3.6 EUT OPERATING CONDITIONS

The software provided by client to enable the EUT under transmission condition continuously at lowest, middle and highest channel frequencies individually.



4.3.7 TEST RESULTS (A)

EUT	802.11a/b/g PCI adapter card	MODEL	8482-WD
INPUT POWER (SYSTEM)	120Vac, 60Hz	ENVIRONMENTAL CONDITIONS	27deg. C, 56%RH, 965 hPa
TESTED BY	Tony Chen		

CHANNEL	CHANNEL FREQUENCY (MHz)	6dB BANDWIDTH (MHz)	MINIMUM LIMIT (MHz)	PASS/FAIL
1	2412	12.3	0.5	PASS
6	2437	12.24	0.5	PASS
11	2462	12.18	0.5	PASS



CH1

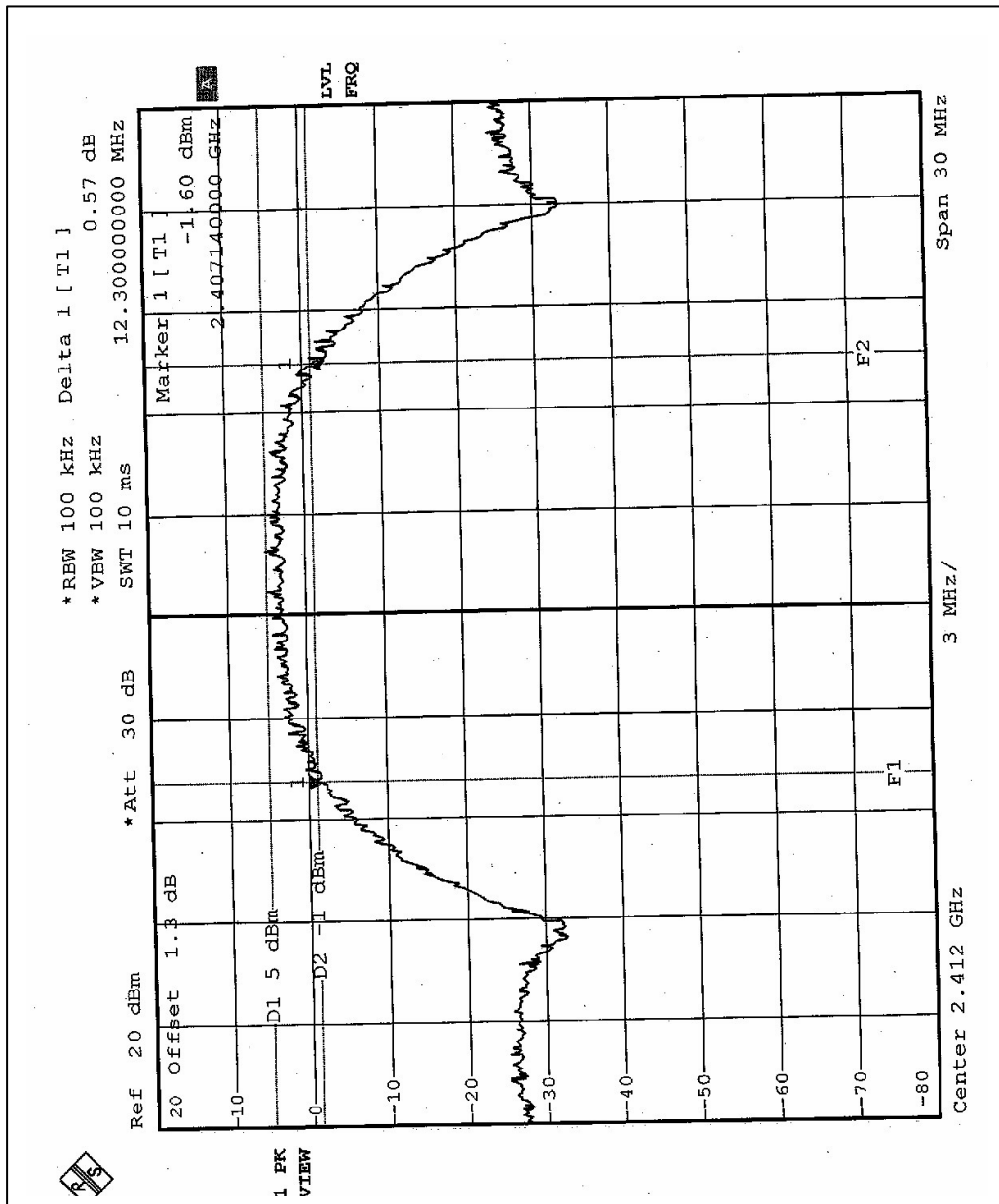



CH6

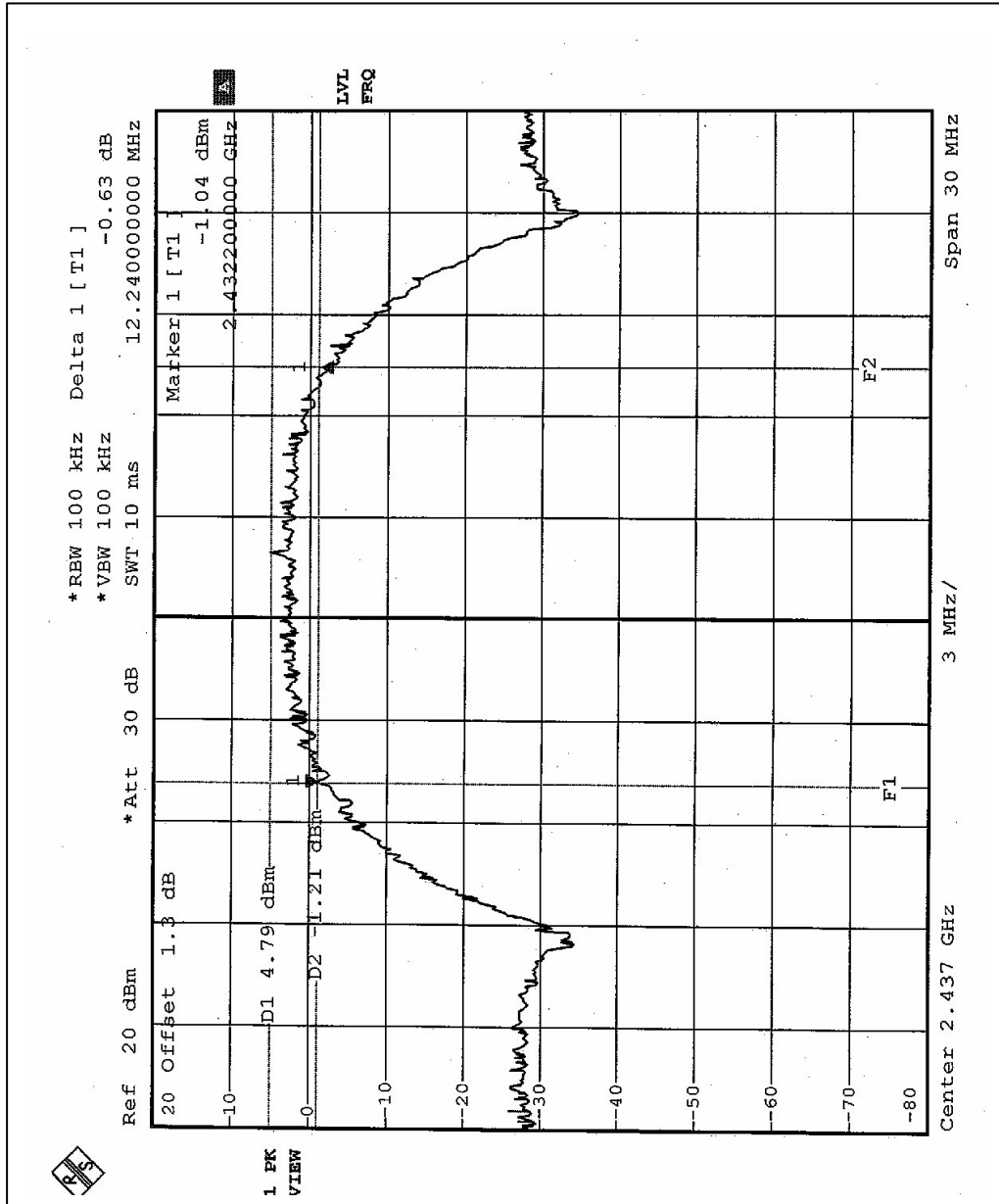



CH11

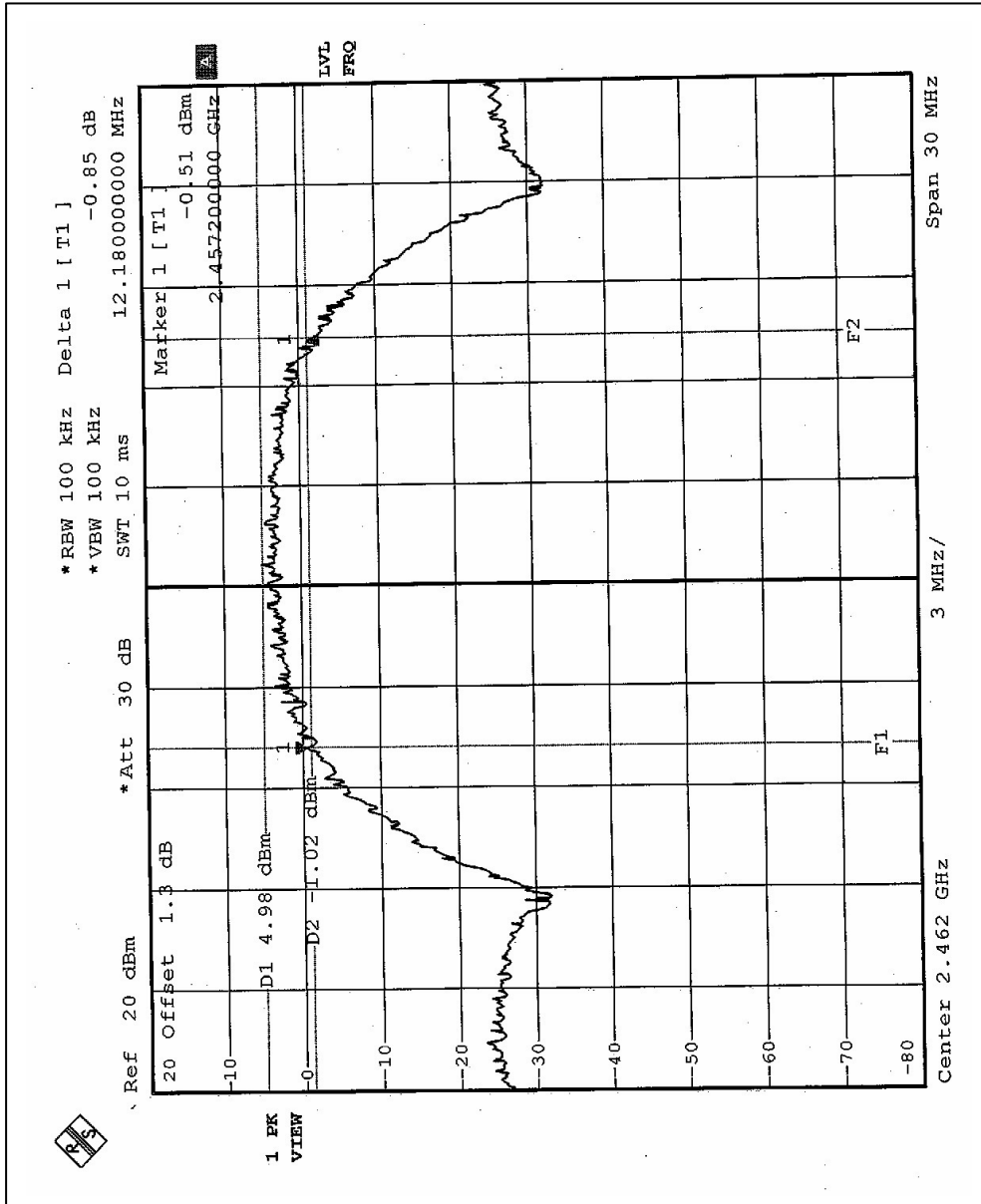



4.3.8 TEST RESULTS (B)

EUT	802.11a/b/g PCI adapter card	MODEL	8482-WD
INPUT POWER (SYSTEM)	120Vac, 60Hz	ENVIRONMENTAL CONDITIONS	27deg. C, 56%RH, 965 hPa
TESTED BY	Tony Chen		

CHANNEL	CHANNEL FREQUENCY (MHz)	6dB BANDWIDTH (MHz)	MINIMUM LIMIT (MHz)	PASS/FAIL
1	2412	16.62	0.5	PASS
6	2437	16.56	0.5	PASS
11	2462	16.62	0.5	PASS



CH1

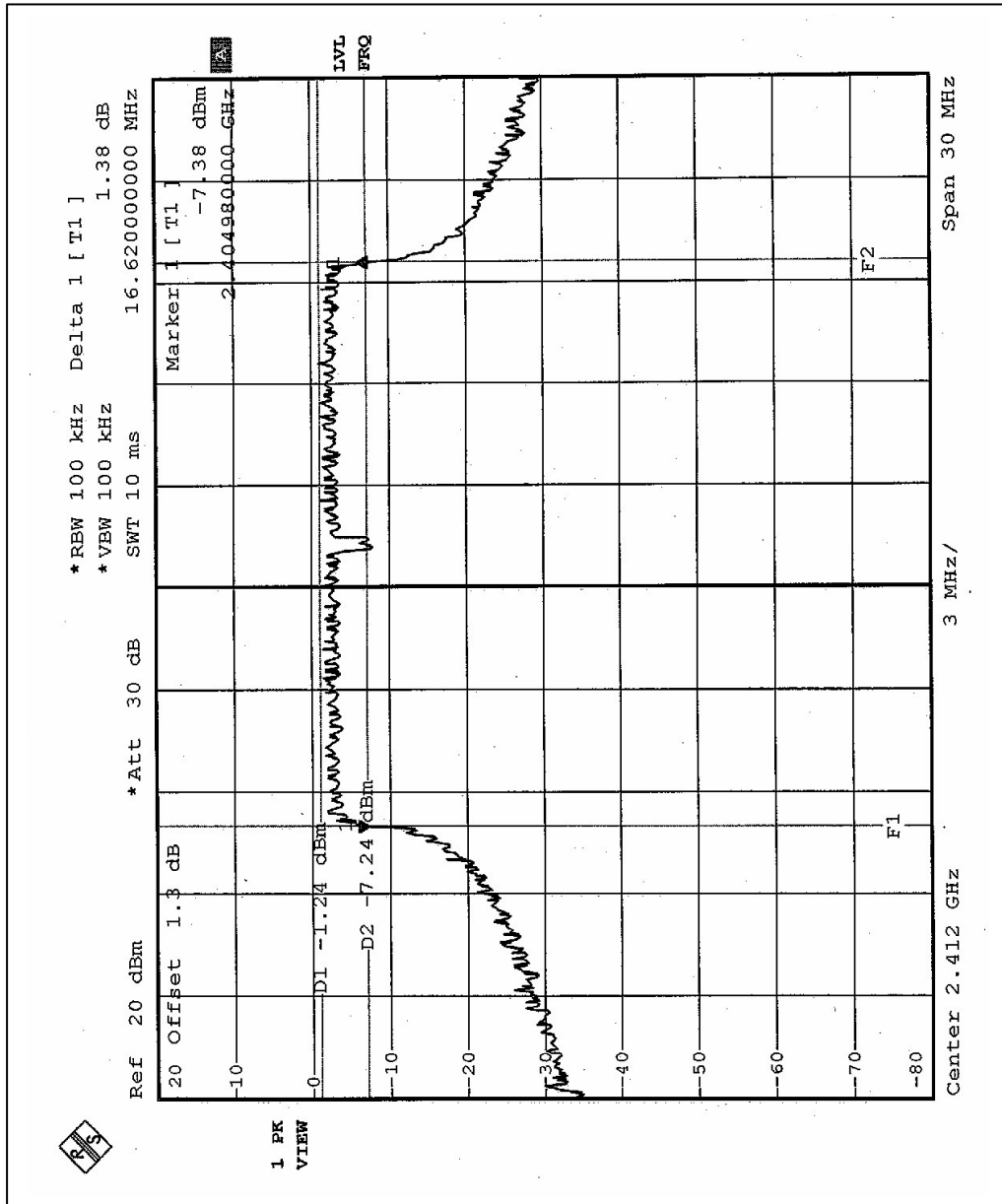



CH6

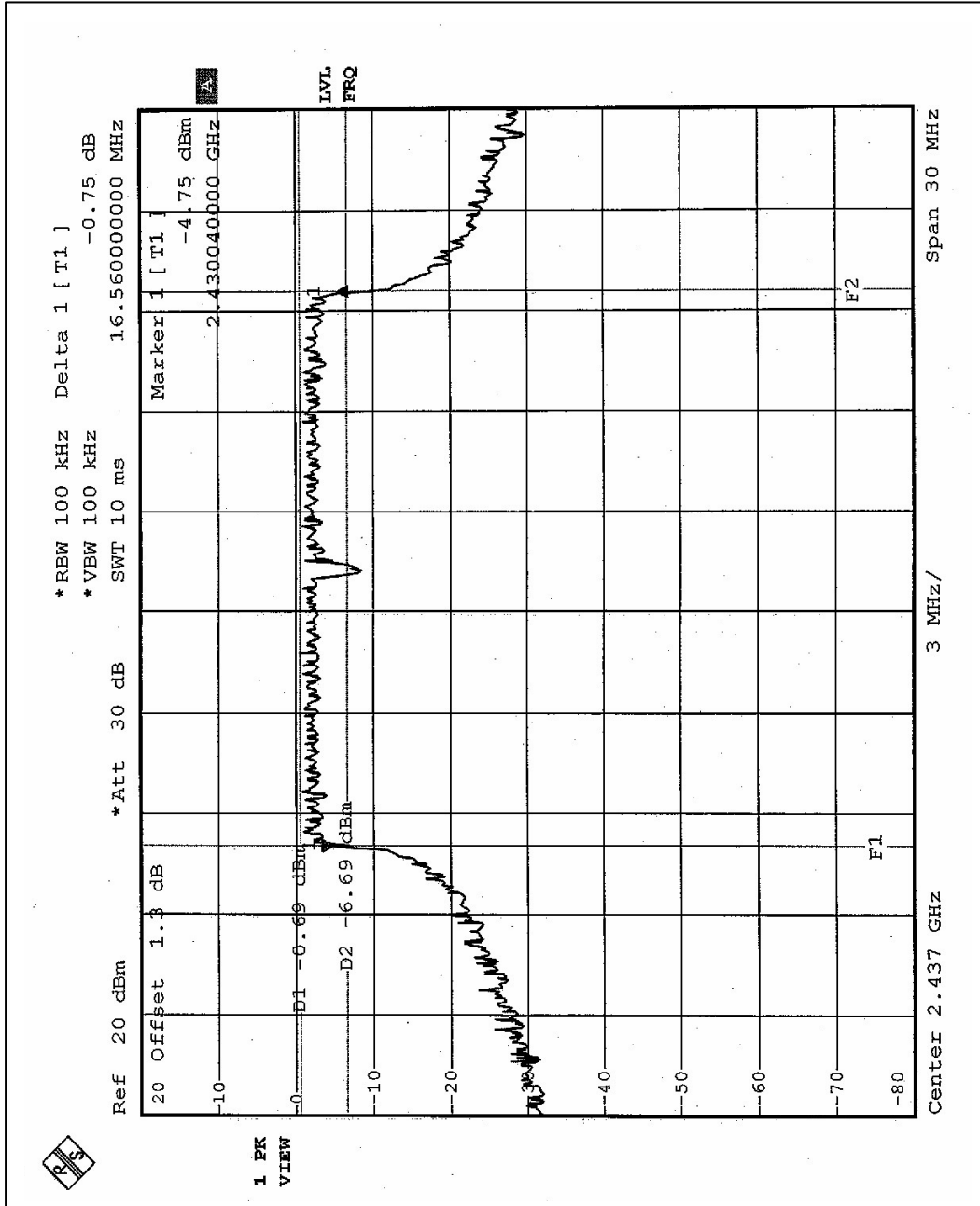



CH11

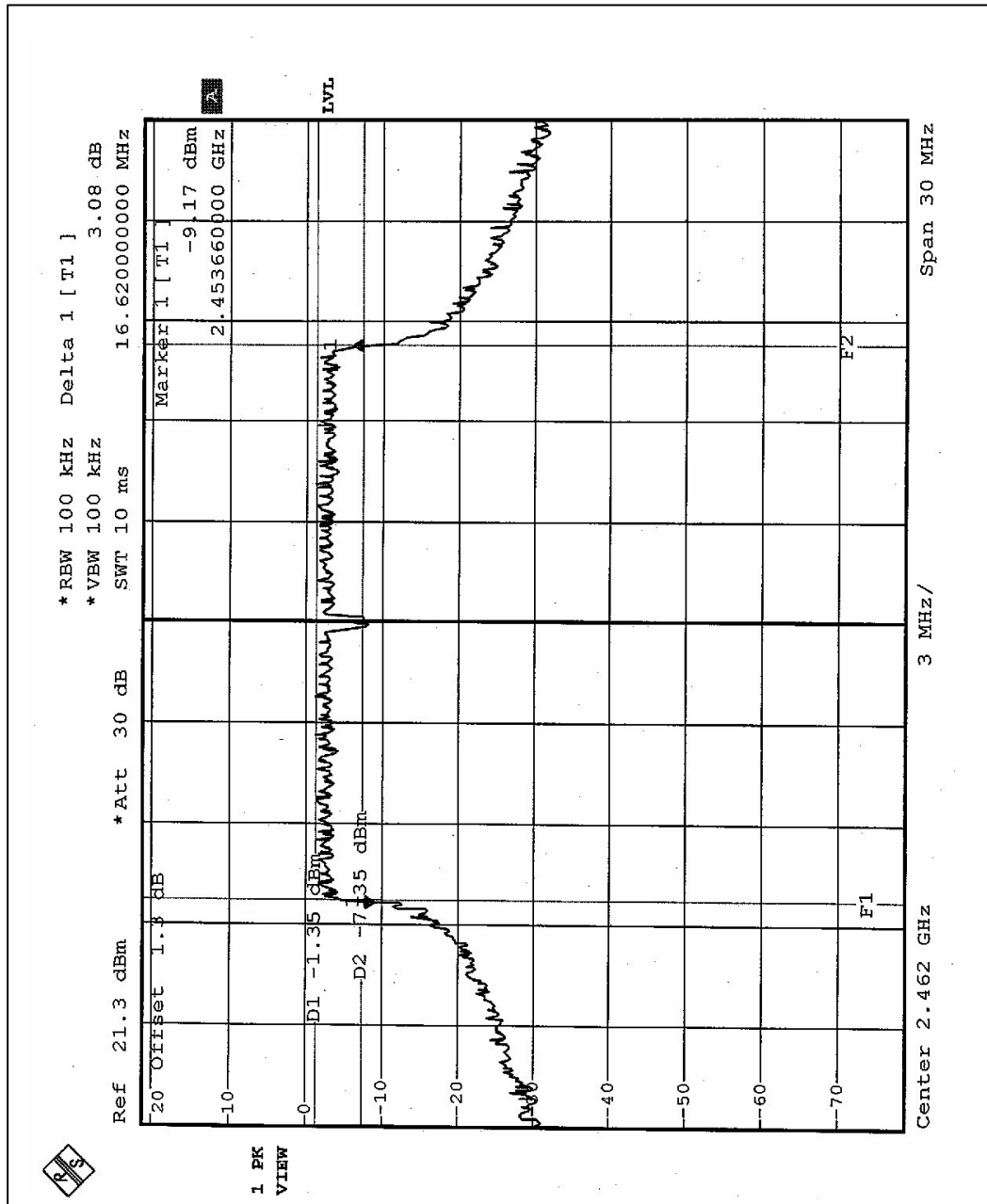



4.4 MAXIMUM PEAK OUTPUT POWER

4.4.1 LIMITS OF MAXIMUM PEAK OUTPUT POWER MEASUREMENT

The Maximum Peak Output Power Measurement is 30dBm.

4.4.2 INSTRUMENTS

Description & Manufacturer	Model No.	Serial No.	Calibrated Until
POWER METER	E4416A	GB41291118	July 30, 2003
PEAK POWER SENSOR	E9327A	US40440722	July 30, 2003

NOTE:

1. The measurement uncertainty is less than +/- 2.6dB, which is calculated as per the NAMAS document NIS81.
2. The calibration interval of the above test instruments is 12 months and the calibrations are traceable to NML/ROC and NIST/USA.

4.4.3 TEST PROCEDURES

The transmitter output was connected to the peak power meter.

4.4.4 DEVIATION FROM TEST STANDARD

No deviation

4.4.5 TEST SETUP

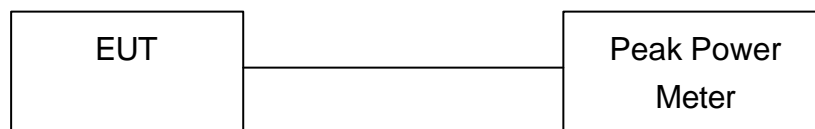

4.4.6 EUT OPERATING CONDITIONS

Same as Item 4.3.6



4.4.7 TEST RESULTS (A)

EUT	802.11a/b/g PCI adapter card	MODEL	8482-WD
INPUT POWER (SYSTEM)	120Vac, 60Hz	ENVIRONMENTAL CONDITIONS	27deg. C, 56%RH, 965 hPa
TESTED BY	Tony Chen		

CHANNEL	CHANNEL FREQUENCY (MHz)	PEAK POWER OUTPUT (dBm)	PEAK POWER LIMIT (dBm)	PASS/FAIL
1	2412	15.21	30	PASS
6	2437	15.09	30	PASS
11	2462	15.18	30	PASS

4.4.8 TEST RESULTS (B)

EUT	802.11a/b/g PCI adapter card	MODEL	8482-WD
INPUT POWER (SYSTEM)	120Vac, 60Hz	ENVIRONMENTAL CONDITIONS	27deg. C, 56%RH, 965 hPa
TESTED BY	Tony Chen		

CHANNEL	CHANNEL FREQUENCY (MHz)	PEAK POWER OUTPUT (dBm)	PEAK POWER LIMIT (dBm)	PASS/FAIL
1	2412	15.15	30	PASS
6	2437	15.24	30	PASS
11	2462	14.01	30	PASS



4.5 POWER SPECTRAL DENSITY MEASUREMENT

4.5.1 LIMITS OF POWER SPECTRAL DENSITY MEASUREMENT

The Maximum of Power Spectral Density Measurement is 8dBm.

4.5.2 TEST INSTRUMENTS

Description & Manufacturer	Model No.	Serial No.	Calibrated Until
R&S SPECTRUM ANALYZER	FSP	1093.4495.30	Dec. 19, 2003

NOTE:

- 1.The measurement uncertainty is less than +/- 2.6dB, which is calculated as per the NAMAS document NIS81.
- 2.The calibration interval of the above test instruments is 12 months and the calibrations are traceable to NML/ROC and NIST/USA.

4.5.3 TEST PROCEDURE

The transmitter output was connected to the spectrum analyzer through an attenuator, the bandwidth of the fundamental frequency was measured with the spectrum analyzer using 3 kHz RBW and 30 kHz VBW, set sweep time = span/3 kHz. The power spectral density was measured and recorded.

The sweep time is allowed to be longer than span/3 kHz for a full response of the mixer in the spectrum analyzer.

4.5.4 DEVIATION FROM TEST STANDARD

No deviation

4.5.5 TEST SETUP

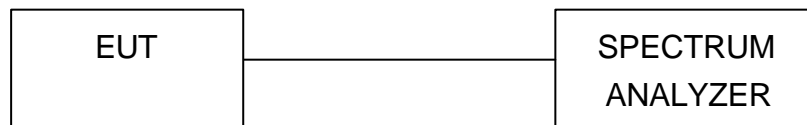

4.5.6 EUT OPERATING CONDITION

Same as Item 4.3.6



4.5.7 TEST RESULTS(A)

EUT	802.11a/b/g PCI adapter card	MODEL	8482-WD
INPUT POWER (SYSTEM)	120Vac, 60Hz	ENVIRONMENTAL CONDITIONS	18deg. C, 69RH, 965 hPa
TESTED BY	Tony Chen		

CHANNEL NUMBER	CHANNEL FREQUENCY (MHz)	RF POWER LEVEL IN 3 kHz BW (dBm)	MAXIMUM LIMIT (dBm)	PASS/FAIL
1	2412	-9.62	8	PASS
6	2437	-9.36	8	PASS
11	2462	-9.02	8	PASS



CH1

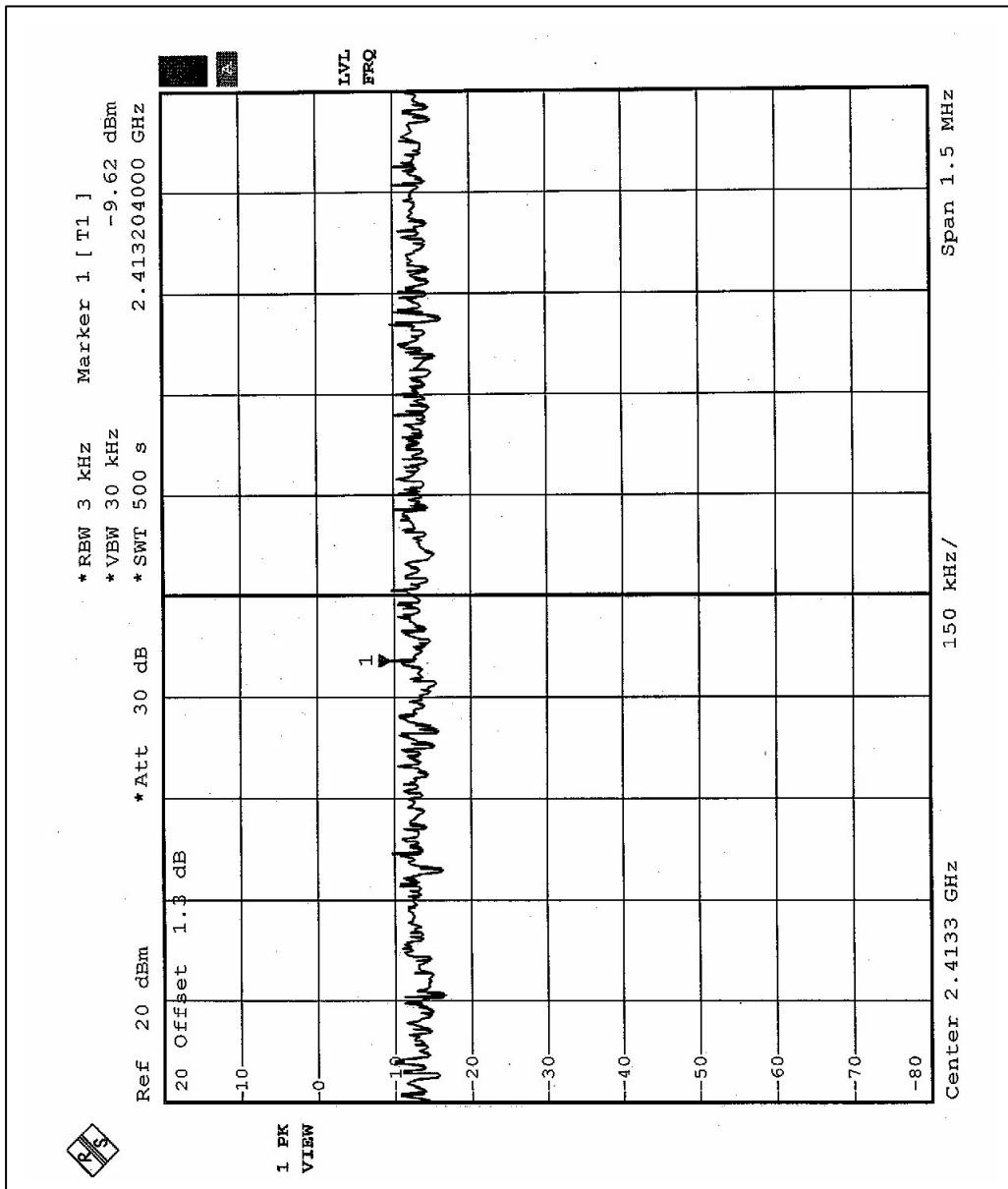



CH6

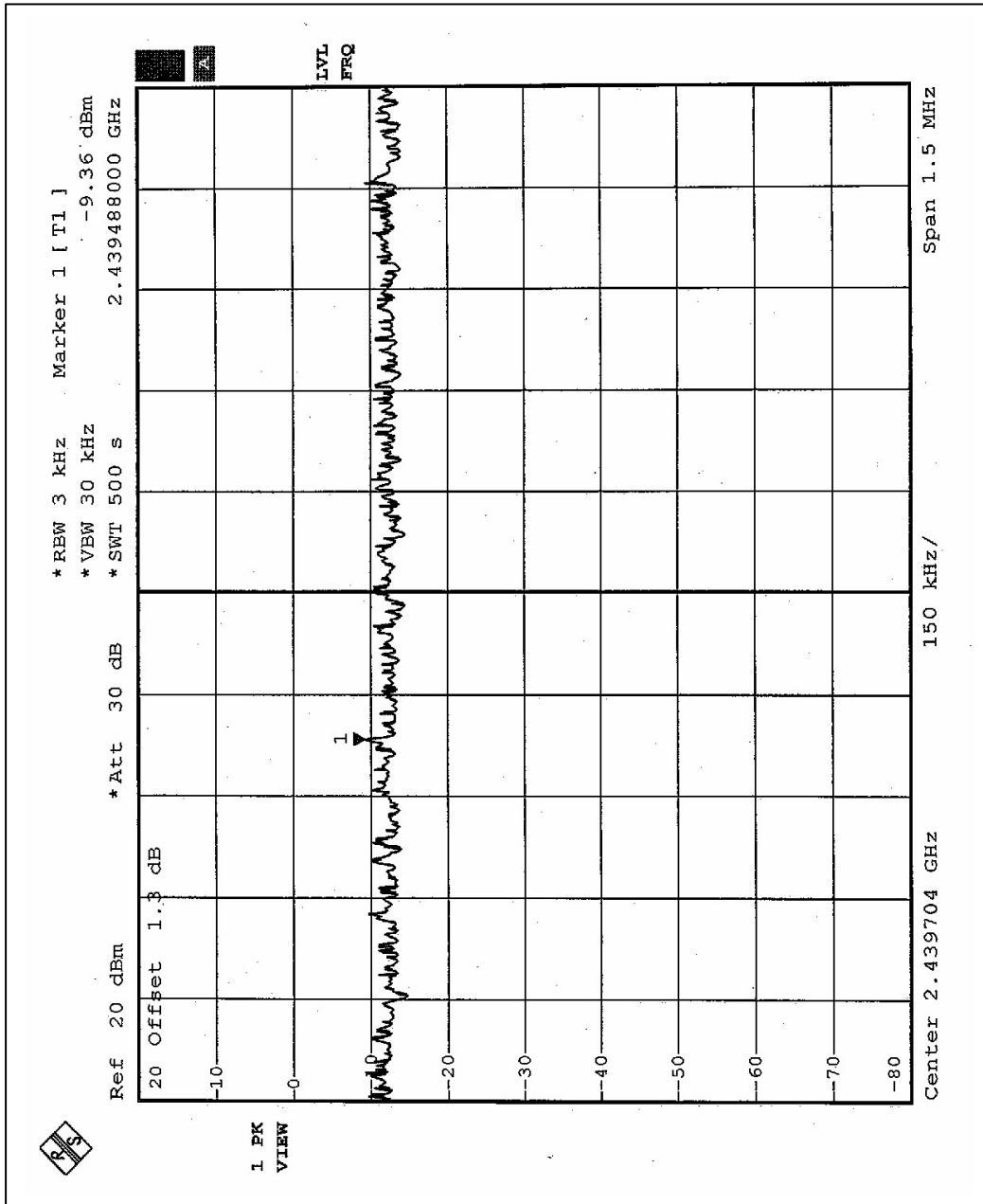



CH11

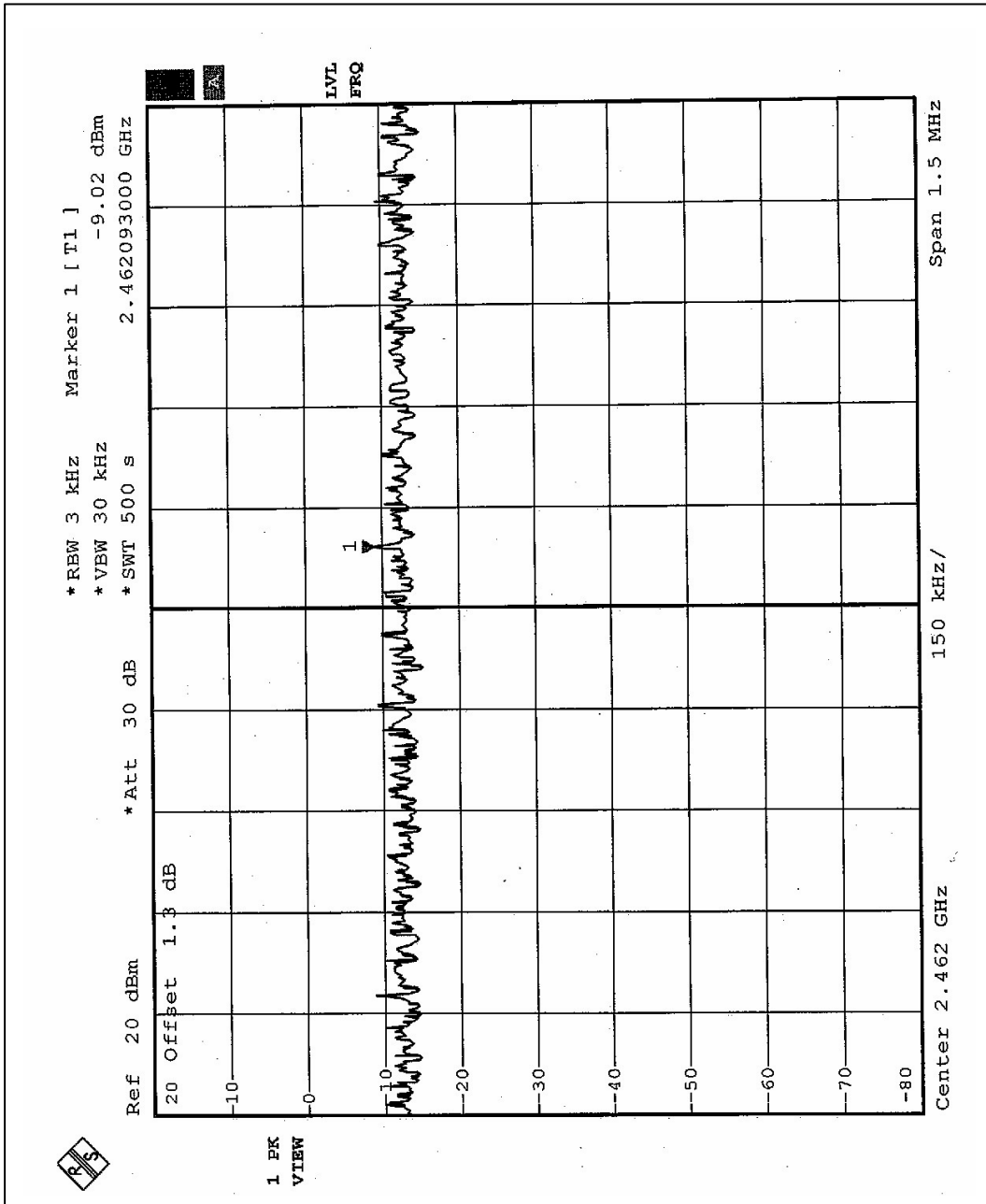



4.5.8 TEST RESULTS(B)

EUT	802.11a/b/g PCI adapter card	MODEL	8482-WD
INPUT POWER (SYSTEM)	120Vac, 60Hz	ENVIRONMENTAL CONDITIONS	18deg. C, 69RH, 965 hPa
TESTED BY	Tony Chen		

CHANNEL NUMBER	CHANNEL FREQUENCY (MHz)	RF POWER LEVEL IN 3 kHz BW (dBm)	MAXIMUM LIMIT (dBm)	PASS/FAIL
1	2412	-12.6	8	PASS
6	2437	-12.18	8	PASS
11	2462	-12.78	8	PASS



CH1

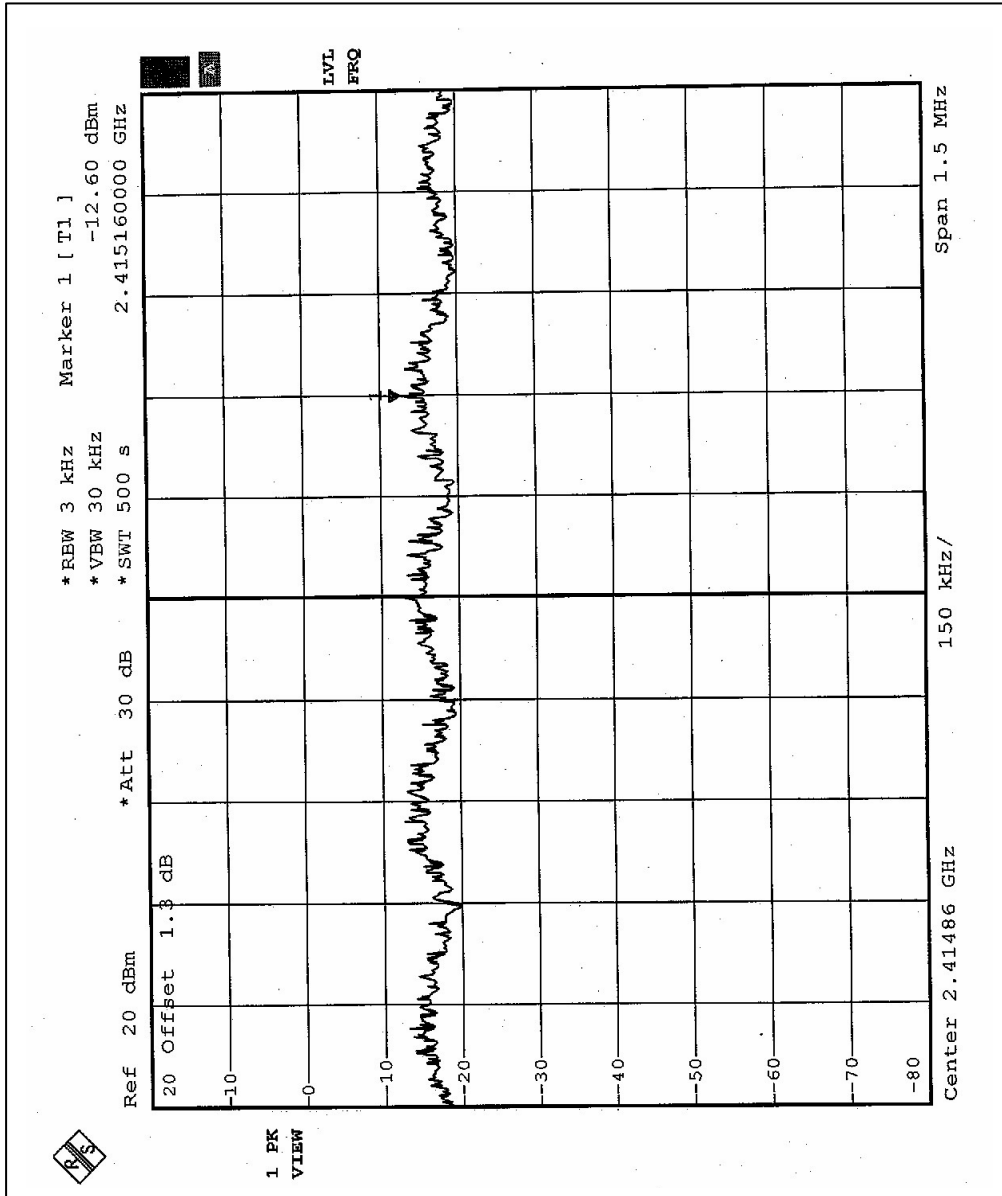



CH6

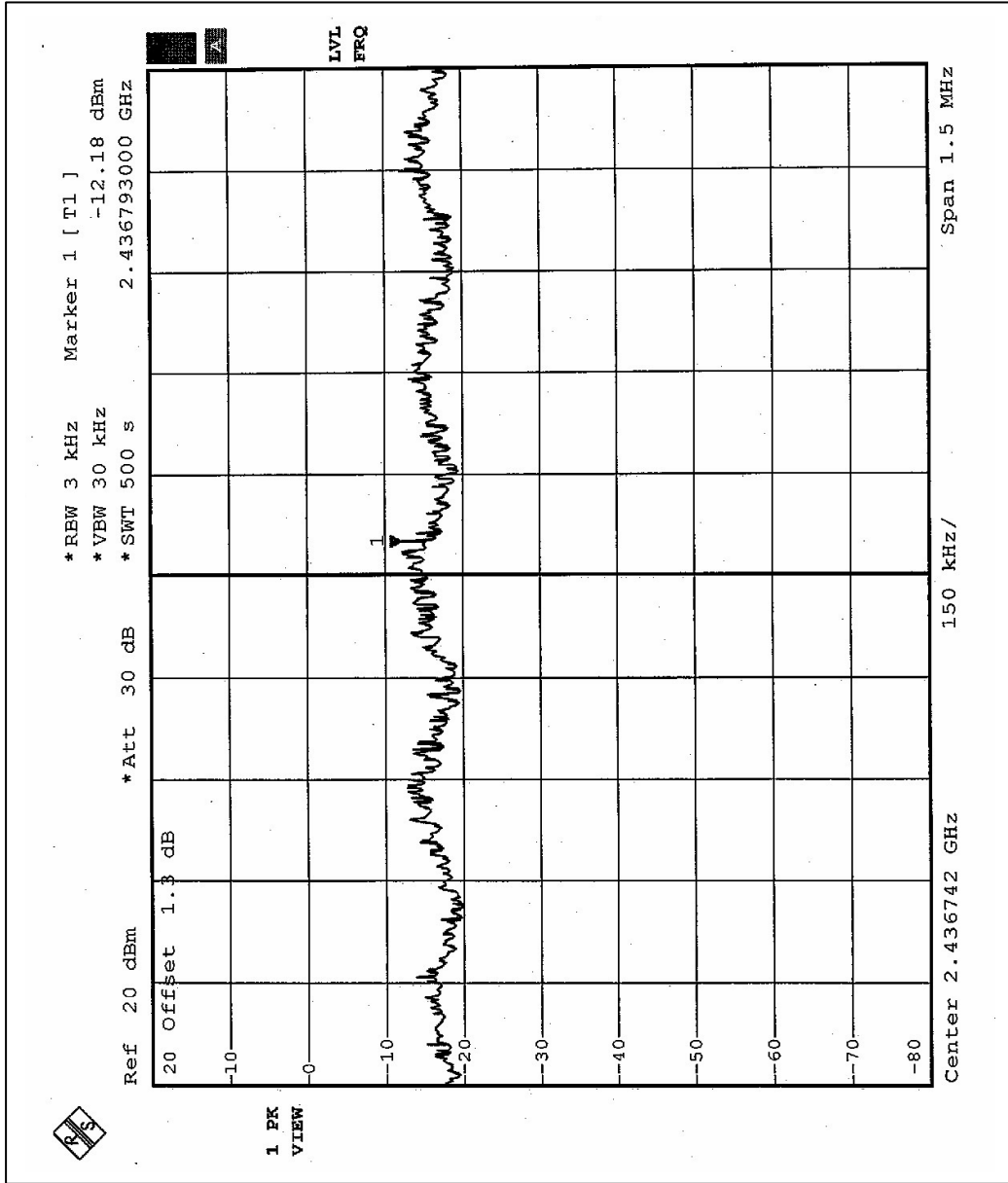



CH11

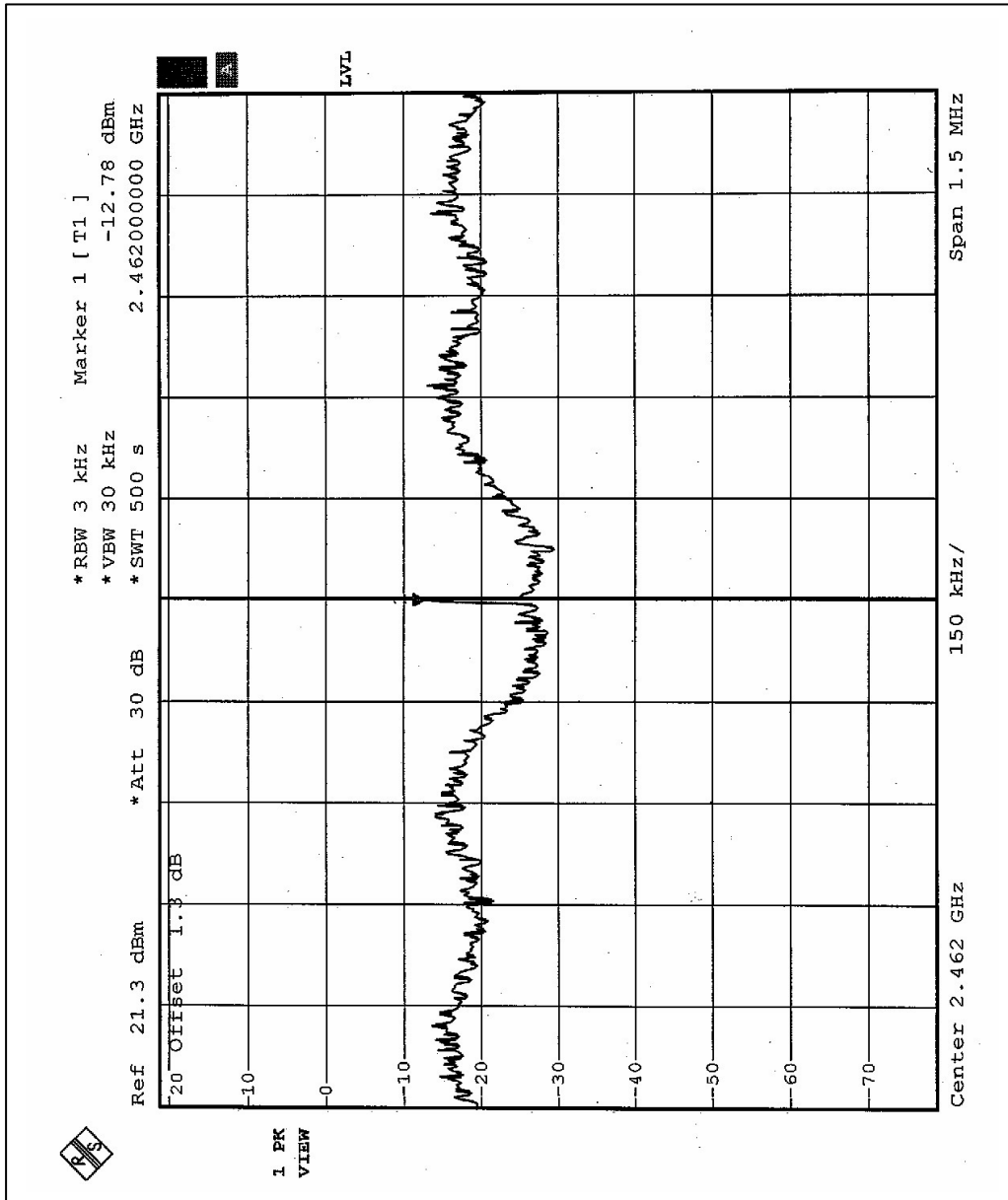



4.6 BAND EDGES MEASUREMENT

4.6.1 LIMITS OF BAND EDGES MEASUREMENT

Below -20dB of the highest emission level of operating band (in 100KHz Resolution Bandwidth).

4.6.2 TEST INSTRUMENTS

Description & Manufacturer	Model No.	Serial No.	Calibrated Until
R&S SPECTRUM ANALYZER	FSP	1093.4495.30	Dec. 19, 2003

NOTE:

- 1.The measurement uncertainty is less than +/- 2.6dB, which is calculated as per the NAMAS document NIS81.
- 2.The calibration interval of the above test instruments is 12 months and the calibrations are traceable to NML/ROC and NIST/USA.

4.6.3 TEST PROCEDURE

The transmitter output was connected to the spectrum analyzer via a low lose cable. Set both RBW and VBW of spectrum analyzer to 100 kHz with suitable frequency span including 100 kHz bandwidth from band edge. The band edges was measured and recorded.

4.6.4 DEVIATION FROM TEST STANDARD

No deviation



4.6.5 EUT OPERATING CONDITION

Same as Item 4.3.6

4.6.6 TEST RESULTS (A)

The spectrum plots are attached on the following 2 pages. D1 line indicates the highest level, and D2 line indicates the 20dB offset below D2. It shows compliance with the requirement in part 15.247(C).

NOTE (1): The band edge emission plot on the following second page shows 47.84dB delta between carrier maximum power and local maximum emission in restrict band (2.390GHz). The emission of carrier strength list in the test result of channel 11 at the item 4.2.7 is 97.2dBuV/m, so the maximum field strength in restrict band is $97.2-47.84=49.36$ dBuV/m which is under 54 dBuV/m limit.

NOTE (2): The band edge emission plot on the following first page shows 48.26dB delta between carrier maximum power and local maximum emission in restrict band (2.496GHz). The emission of carrier strength list in the test result of channel 1 at the item 4.2.7 is 97.8dBuV/m, so the maximum field strength in restrict band is $97.8-48.26=49.54$ dBuV/m which is under 54 dBuV/m limit.

