



**FCC Certification Test Report**  
**For the**  
**Proxim Corporation**  
**AP4000MR-LR**  
**(2.4GHz Radio, 802.11g Mode)**  
**HZB-4000LR**

WLL JOB# 9153  
June 20, 2006

Prepared for:

**Proxim Corporation**  
**2115 O'Nel Drive**  
**San Jose, CA 95131**

Prepared By:

**Washington Laboratories, Ltd.**  
**7560 Lindbergh Drive**  
**Gaithersburg, Maryland 20879**

**FCC Certification Test Report**  
**for the**  
**Proxim Corporation**  
**AP4000MR-LR**  
**(2.4GHz Radio, 802.11g Mode)**  
**FCC ID: HZB-4000LR**

**June 20, 2006**

WLL JOB# 9153

Prepared by: Brian J. Dettling  
Documentation Specialist

Reviewed by: Michael F. Violette, P.E.  
President

## Abstract

This report has been prepared on behalf of Proxim Corporation to support the attached Application for Equipment Authorization. The test report and application are submitted for a Digital Transmission System Transmitter under Part 15.247 of the FCC Rules and Regulations.

This Certification Test Report documents the test configuration and test results for a Proxim Corporation AP4000MR-LR 2.4GHz card operating in the 802.11b mode. A separate test report covers the 802.11g mode.

Testing was performed on an Open Area Test Site (OATS) of Washington Laboratories, Ltd, 7560 Lindbergh Drive, Gaithersburg, MD 20879. Site description and site attenuation data have been placed on file with the FCC's Sampling and Measurements Branch at the FCC laboratory in Columbia, MD. Washington Laboratories, Ltd. has been accepted by the FCC and approved by NIST NVLAP (NVLAP Lab Code: 200066-0) as an independent FCC test laboratory.

The Proxim Corporation AP4000MR-LR complies with the limits for a Digital Transmission System Transmitter device under FCC Part 15.247.

Table of Contents

Abstract..... ii

1 Introduction..... 1

    1.1 Compliance Statement ..... 1

    1.2 Test Scope..... 1

    1.3 Contract Information..... 1

    1.4 Test Dates ..... 1

    1.5 Test and Support Personnel ..... 1

2 Equipment Under Test ..... 1

    2.1 EUT Identification & Description ..... 1

    2.2 Test Configuration ..... 2

    2.3 Testing Algorithm..... 3

    2.4 Test Location ..... 3

    2.5 Measurements ..... 3

        2.5.1 References..... 3

    2.6 Measurement Uncertainty ..... 4

3 Test Equipment ..... 5

4 Test Results..... 6

    4.1 RF Power Output: (FCC Part §2.1046) ..... 6

    4.2 Occupied Bandwidth: (FCC Part §2.1049)..... 7

    4.3 RF Peak Power Spectral Density (§15.247(e))..... 11

    4.4 Conducted Spurious Emissions at Antenna Terminals (FCC Part §2.1051) ..... 15

    4.5 Radiated Spurious Emissions: (FCC Part §2.1053)..... 32

**4.5.1 Test Procedure** ..... 32

    4.6 AC Powerline Conducted Emissions: (FCC Part §15.207) ..... 41

    4.7 Co-Location Measurements ..... 42

List of Tables

Table 1. Device Summary..... 1

Table 2: Test Equipment List..... 5

Table 3. RF Power Output ..... 6

Table 4. Occupied Bandwidth Results..... 11

Table 5: Radiated Emission Test Data: Antenna A2.45LP17 ..... 33

Table 6: Radiated Emission Test Data: Antenna A2412-0..... 35

Table 7: Radiated Emission Test Data: Antenna A2.45FP18..... 38

Table 8. Conducted Emissions Test Data; §15.207 ..... 41

Table 9. Co-Location Radio Measurement..... 42

List of Figures

Figure 1. Power Measurement Setup..... 7

Figure 4-2. Occupied Bandwidth, Low Channel ..... 8

Figure 4-3. Occupied Bandwidth, Mid Channel..... 9

Figure 4-4. Occupied Bandwidth, High Channel ..... 10

Figure 4-5: Power Spectral Density, Low Channel ..... 12  
Figure 4-6: Power Spectral Density, Mid Channel ..... 13  
Figure 4-7: Power Spectral Density, High Channel ..... 14  
Figure 4-8. Conducted Spurious Emissions, Low Power: Low Channel Band Edge..... 16  
Figure 4-9. Conducted Spurious Emissions, Low Power: Low Channel 30 - 2483MHz ..... 17  
Figure 4-10. Conducted Spurious Emissions, Low Power: Low Channel 2.4– 25GHz ..... 18  
Figure 4-11. Conducted Spurious Emissions, Low Power: Mid Channel 30 – 2483MHz ..... 19  
Figure 4-12. Conducted Spurious Emissions, Low Power: Mid Channel 2.4 - 25GHz ..... 20  
Figure 4-13. Conducted Spurious Emissions, Low Power: High Channel Band Edge ..... 21  
Figure 4-14. Conducted Spurious Emissions, Low Power: High Channel 30 – 2483MHz ..... 22  
Figure 4-15. Conducted Spurious Emissions, Low Power: High Channel 2.4 - 25GHz ..... 23  
Figure 4-16. Conducted Spurious Emissions, High Power: Low Channel Band Edge ..... 24  
Figure 4-17. Conducted Spurious Emissions, High Power: Low Channel 30 - 2483MHz ..... 25  
Figure 4-18. Conducted Spurious Emissions, High Power: Low Channel 2.4 – 25GHz ..... 26  
Figure 4-19. Conducted Spurious Emissions, High Power: Mid Channel 30 – 2483MHz ..... 27  
Figure 4-20. Conducted Spurious Emissions, High Power: Mid Channel 2.4 - 25GHz ..... 28  
Figure 4-21. Conducted Spurious Emissions, High Power: High Channel Band Edge ..... 29  
Figure 4-22. Conducted Spurious Emissions, High Power: High Channel 30 – 2483MHz ..... 30  
Figure 4-23. Conducted Spurious Emissions, High Power: High Channel 2.4 - 25GHz ..... 31

## 1 Introduction

### 1.1 Compliance Statement

The Proxim Corporation AP4000MR-LR complies with the limits for a Digital Transmission System Transmitter device under FCC Part 15.247.

### 1.2 Test Scope

Tests for radiated and conducted (at antenna terminal) emissions were performed. All measurements were performed in accordance with the 2003 version of ANSI C63.4. The measurement equipment conforms to ANSI C63.2 Specifications for Electromagnetic Noise and Field Strength Instrumentation.

### 1.3 Contract Information

Customer: Proxim Corporation  
2115 O'Nel Drive  
San Jose, CA 95131

Purchase Order Number: P06040012

Quotation Number: 62929

### 1.4 Test Dates

Testing performed on the following date(s): April 13 to April 24, 2006

### 1.5 Test and Support Personnel

Washington Laboratories, LTD James Ritter, Greg Snyder, Steve Dovell, Thuan Ta  
Client Representative Michael F. Young

## 2 Equipment Under Test

### 2.1 EUT Identification & Description

The Proxim Corporation AP4000MR-LR is one configuration of dual band access point product line.

- 2.4GHz + 5.8GHz dual access point

The **2.4 GHz 802.11g** portion of the radio is reported here.

The other sections are reported separately. Both have separate amplifier boards that are mounted in the metal case with the access point device.

The product is offered with an external connector. External antennas must be professionally installed.

**Table 1. Device Summary**

ITEM	DESCRIPTION
------	-------------

Manufacturer:	Proxim Corporation
FCC ID:	HZB-4000LR
Model:	AP4000MR-LR
FCC Rule Parts:	§15.247
Frequency Range:	2412 – 2462MHz
Maximum Output Power:	250mW (24dBm)
Modulation:	OFDM
Occupied Bandwidth:	16.7MHz
Keying:	Automatic
Type of Information:	Data
Number of Channels:	11
Power Output Level	Stepped
Antenna Connector	N-type
Antenna Type	Three types intended: Linear Omni Array Sector Panel
Interface Cables:	Ethernet Network Connector
Power Source & Voltage:	48Vdc

## 2.2 Test Configuration

The AP4000MR-LR was provided 48 VDC power mixed with data over a CAT5 RJ-45 (data & power port) from the PW130 Power supply. This power supply accepted AC 100-250 VAC wall power and data from the support laptop (via CAT5 RJ-45) and outputted the above power and data. A support laptop used an ART program and local server to provide power and tuning command to the unit. The EUT was set to 15 and 24 dBm output (9 and 18 dBm on ART program) at hi, mid, & low channels). The following diagram shows the test setup. Port 1 is the RF port under test.

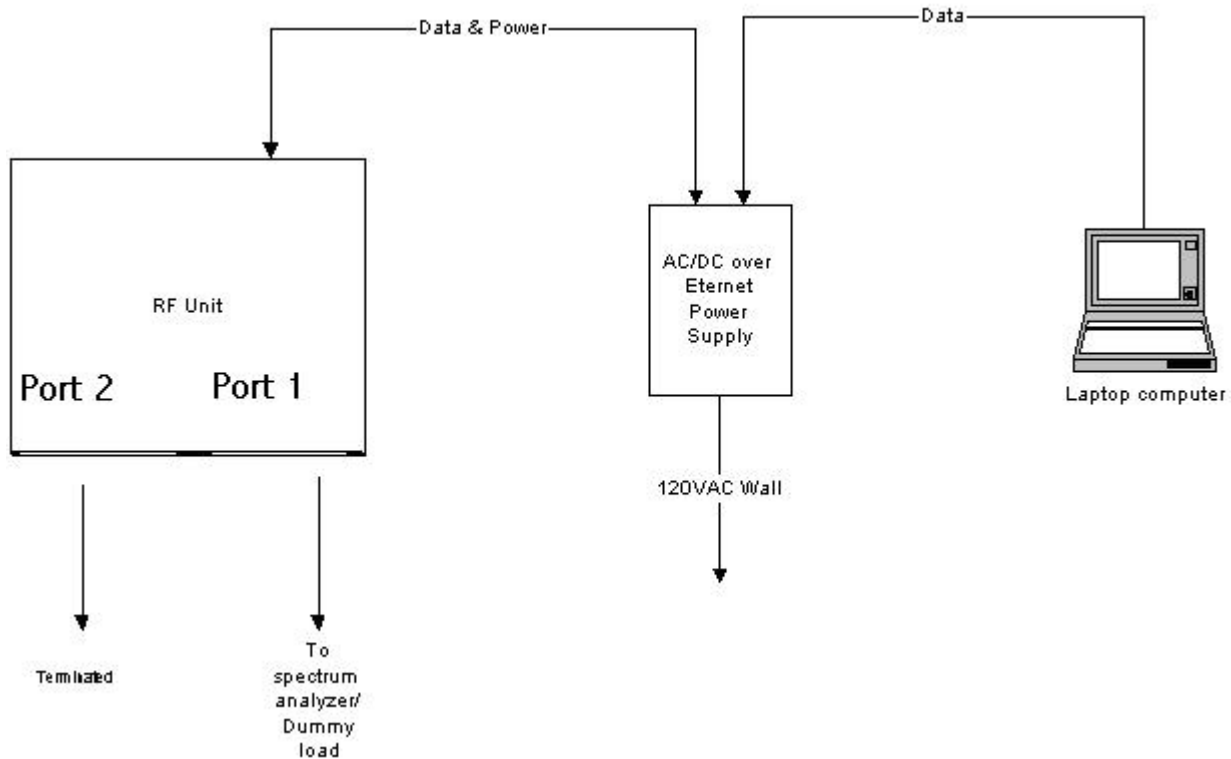

### 2.3 Testing Algorithm

The EUT was provided with 48 VDC power mixed with data over a CAT5 RJ-45 (data & power port) from the PW130 Power supply. This power supply accepted AC 100-250 VAC wall power and data from the support laptop (via cat5 RJ-45) and outputted the above power and data. A support laptop used an ART program and local server to provide power and tuning command to the unit. The EUT was set to 15 and 24 dBm output (9 and 18 dBm on ART program) at high, mid, & low channels).

### 2.4 Test Location

All measurements herein were performed at Washington Laboratories, Ltd. test center in Gaithersburg, MD. Site description and site attenuation data have been placed on file with the FCC's Sampling and Measurements Branch at the FCC laboratory in Columbia, MD. The Industry Canada OATS numbers are 3035A-1 and 3035A-2 for Washington Laboratories, Ltd. Site 1 and Site 2, respectively. Washington Laboratories, Ltd. has been accepted by the FCC and approved by NIST NVLAP (NVLAP Lab Code: 200066-0) as an independent FCC test laboratory.

### 2.5 Measurements

#### 2.5.1 References

ANSI C63.2 Specifications for Electromagnetic Noise and Field Strength Instrumentation

ANSI C63.4 American National Standard for Methods of Measurement of Radio-Noise Emissions from Low-Voltage Electrical and Electronic Equipment in the Range of 9 kHz to 40 GHz



## 2.6 Measurement Uncertainty

All results reported herein relate only to the equipment tested. For the purposes of the measurements performed by Washington Laboratories, the measurement uncertainty is  $\pm 2.3$  dB. This has been calculated for a *worst-case situation* (radiated emissions measurements performed on an open area test site).

The following measurement uncertainty calculation is provided:

$$\text{Total Uncertainty} = (A^2 + B^2 + C^2)^{1/2}/(n-1)$$

where:

A = Antenna calibration uncertainty, in dB = 2 dB

B = Spectrum Analyzer uncertainty, in dB = 1 dB

C = Site uncertainty, in dB = 4 dB

n = number of factors in uncertainty calculation = 3

Thus, Total Uncertainty =  $0.5 (2^2 + 1^2 + 4^2)^{1/2} = \pm 2.3$  dB.

### 3 Test Equipment

Table 2 shows a list of the test equipment used for measurements along with the calibration information.

**Table 2: Test Equipment List**

Site 2 List:

WLL Asset #	Manufacturer Model/Type	Function	Cal. Due
0073	HP 8568B	SPECTRUM ANALYZER	6/30/2006
0069	HP 85650A	QUASI-PEAK ADAPTER	6/30/2006
0073	HP 8568B	SPECTRUM ANALYZER	6/30/2006
0007	ARA LPB-2520	BICONILOG ANTENNA	12/20/2006
0074	HEWLETT-PACKARD 8593A	SPECTRUM ANALYZER	10/04/2006
0522	HEWLETT-PACKARD 8449B	MICROWAVE PREAMP	4/11/2006
0425	ARA DRG118/A	MICROWAVE HORN ANTENNA	1/17/2007
0557	Schaffner, CBL6141A	BICONILOG ANTENNA	12/1/2006
0071	HP 85685A	RF PRESELECTOR	6/30/2006
0069	HP 85650A	QUASI-PEAK ADAPTER	6/30/2006

## 4 Test Results

### 4.1 RF Power Output: (FCC Part §2.1046)

The output from the transmitter was connected to a diode detector and oscilloscope. The peak deflection was measured on the oscilloscope and recorded. A signal generator was then substituted in place of EUT and set to the same frequency as the transmitter. The CW output of the signal generator was increased until the same deflection was noted on the oscilloscope. A power meter was then connected to the output of the signal generator to determine the output power of the signal generator. This level is then recorded as the output power of the EUT at the specified frequency.

**Table 3. RF Power Output**

Channel and/or Frequency	Measured Level (dBm)	Measured Level (Watts)	Rated (dBm)	Limit (dBm)	Limit w 18dbi ant (dBm)
2412 MHz (highest power)	23.3	0.212	24	30	26
2442 MHz (highest power)	24.0	0.250	24	30	26
2462 MHz (highest power)	23.8	0.240	24	30	26
2412 MHz (Lowest power)	13.4	0.022	24	30	26
2442 MHz (Lowest power)	15.5	0.035	24	30	26
2462 MHz (lowest power)	15.6	0.036	24	30	26

### RF Output Power Measurement Diode Detector Method Test Setup Diagram

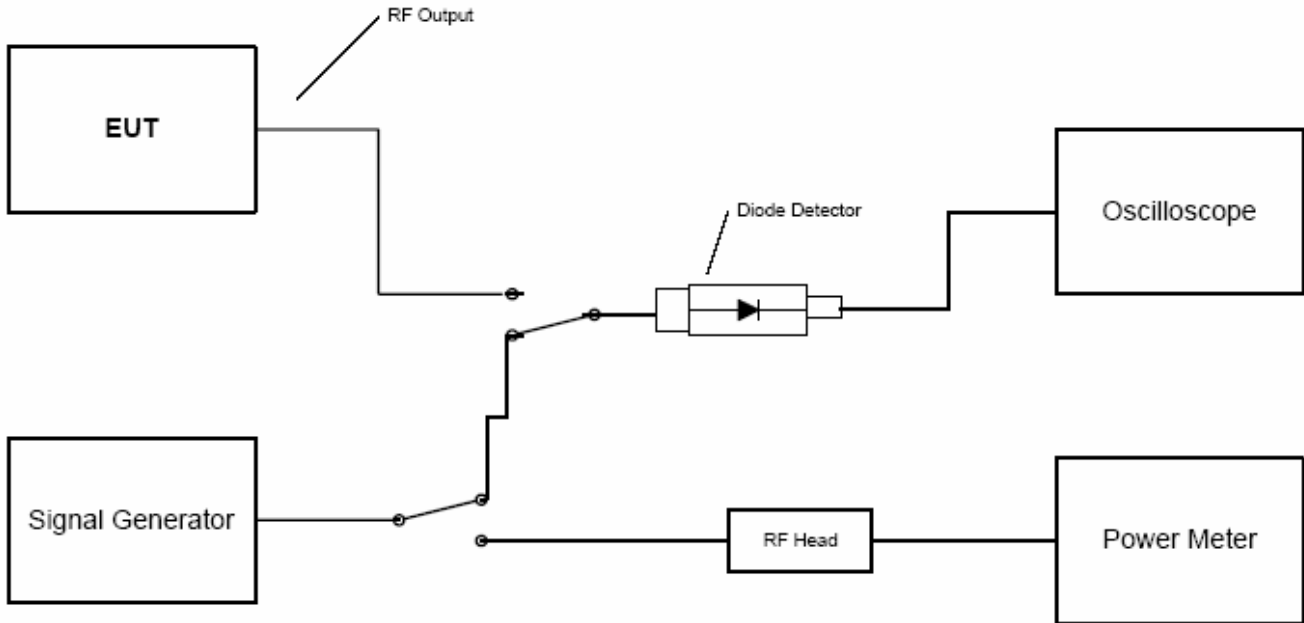

**Figure 1. Power Measurement Setup**

#### 4.2 Occupied Bandwidth: (FCC Part §2.1049)

Occupied bandwidth was performed by coupling the output of the EUT to the input of a spectrum analyzer.

For DTS systems, FCC Part 15.247 requires that the 20 dB bandwidth exceed 0.5MHz.

At full modulation, the occupied bandwidth was measured as shown:

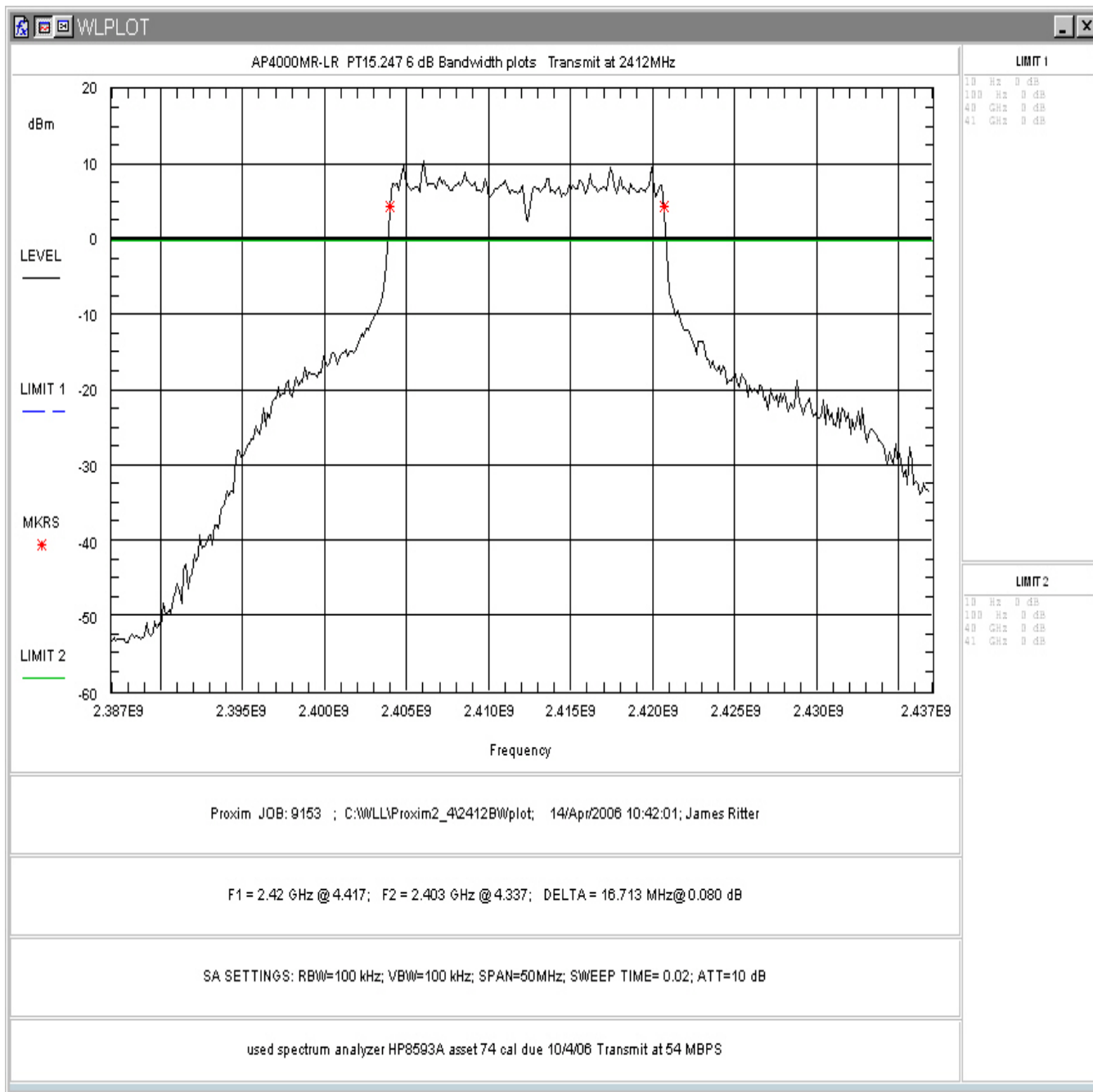

Figure 4-2. Occupied Bandwidth, Low Channel

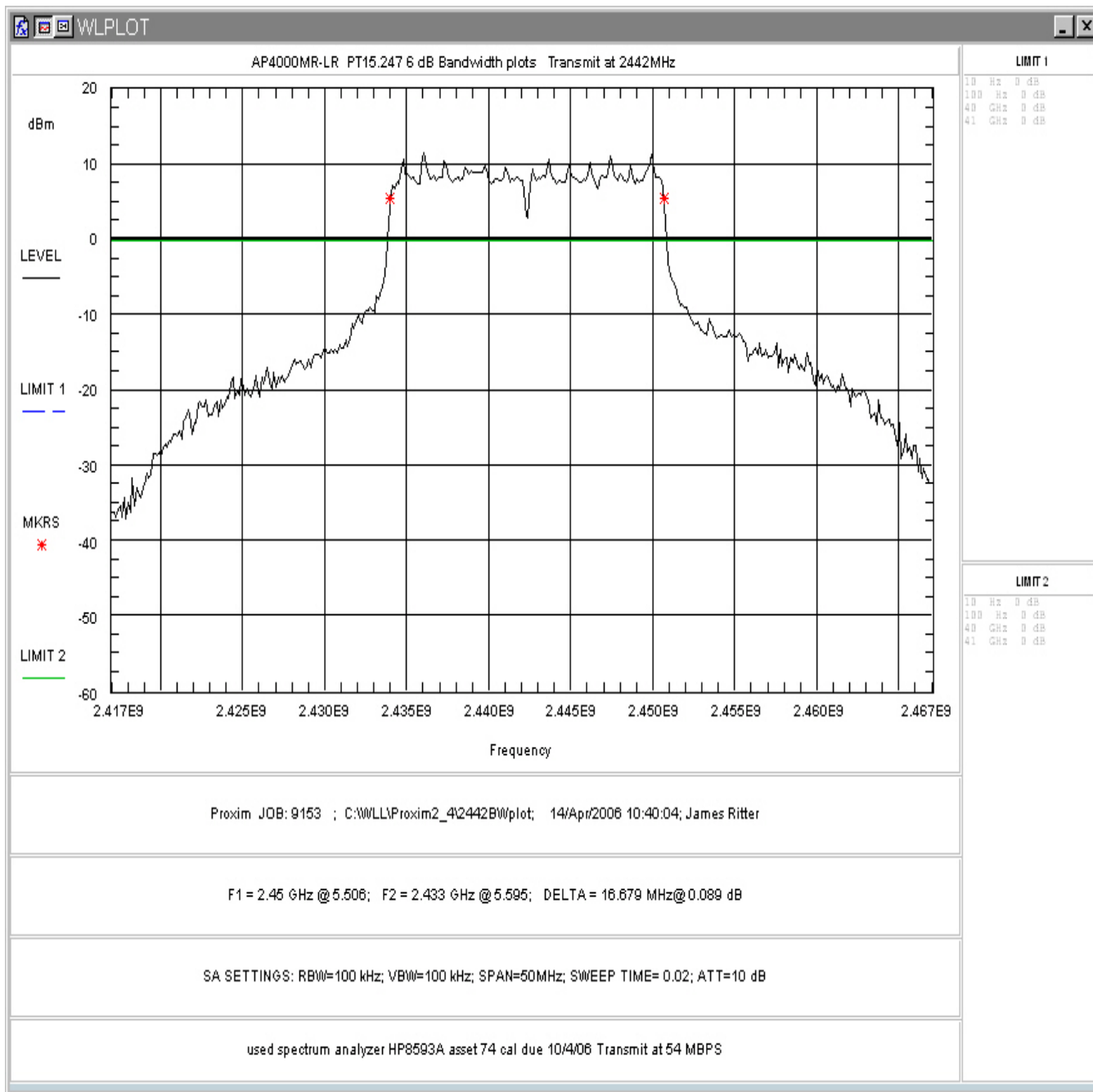
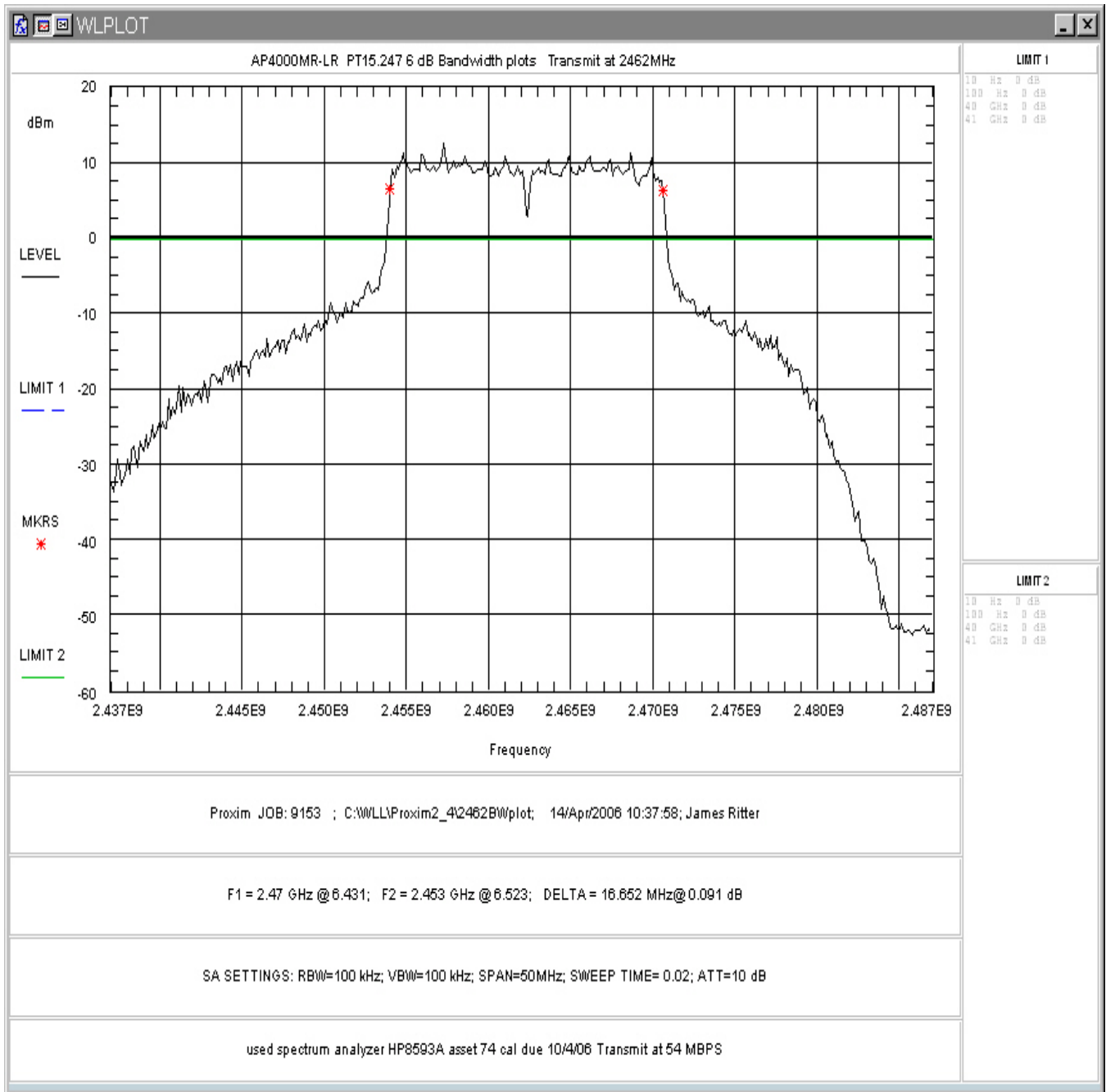

Figure 4-3. Occupied Bandwidth, Mid Channel



**Figure 4-4. Occupied Bandwidth, High Channel**

Table 4 provides a summary of the Occupied Bandwidth Results.

**Table 4. Occupied Bandwidth Results**

Frequency	Bandwidth	Limit	Pass/Fail
Low Channel 2412MHz	16.713MHz	>0.5 MHz	Pass
Mid Channel 2442MHz	16.679MHz	>0.5 MHz	Pass
High Channel 2462MHz	16.652MHz	>0.5 MHz	Pass

**4.3 RF Peak Power Spectral Density (§15.247(e))**

For digitally modulated systems, the peak power spectral density conducted from the intentional radiator to the antenna shall not be greater than 8 dBm in any 3 kHz band during any time interval of continuous transmission.

The output from the transmitter was connected to an attenuator and then to the input of the RF Spectrum Analyzer. The analyzer offset was adjusted to compensate for the attenuator and other losses in the system.

The highest peak within the transmission was located and measured for the high, middle and low channels of operation. Plots of the PSD were taken as shown in Figure 6 through Figure 9 below. Table 5 provides a summary of the data.

Note that the following plots were set to scan the displayed range in five 100 second segments for a total sweep time of the 1.5MHz span of 500 seconds. The SA Settings display only shows the sweep time setting for the last segment.



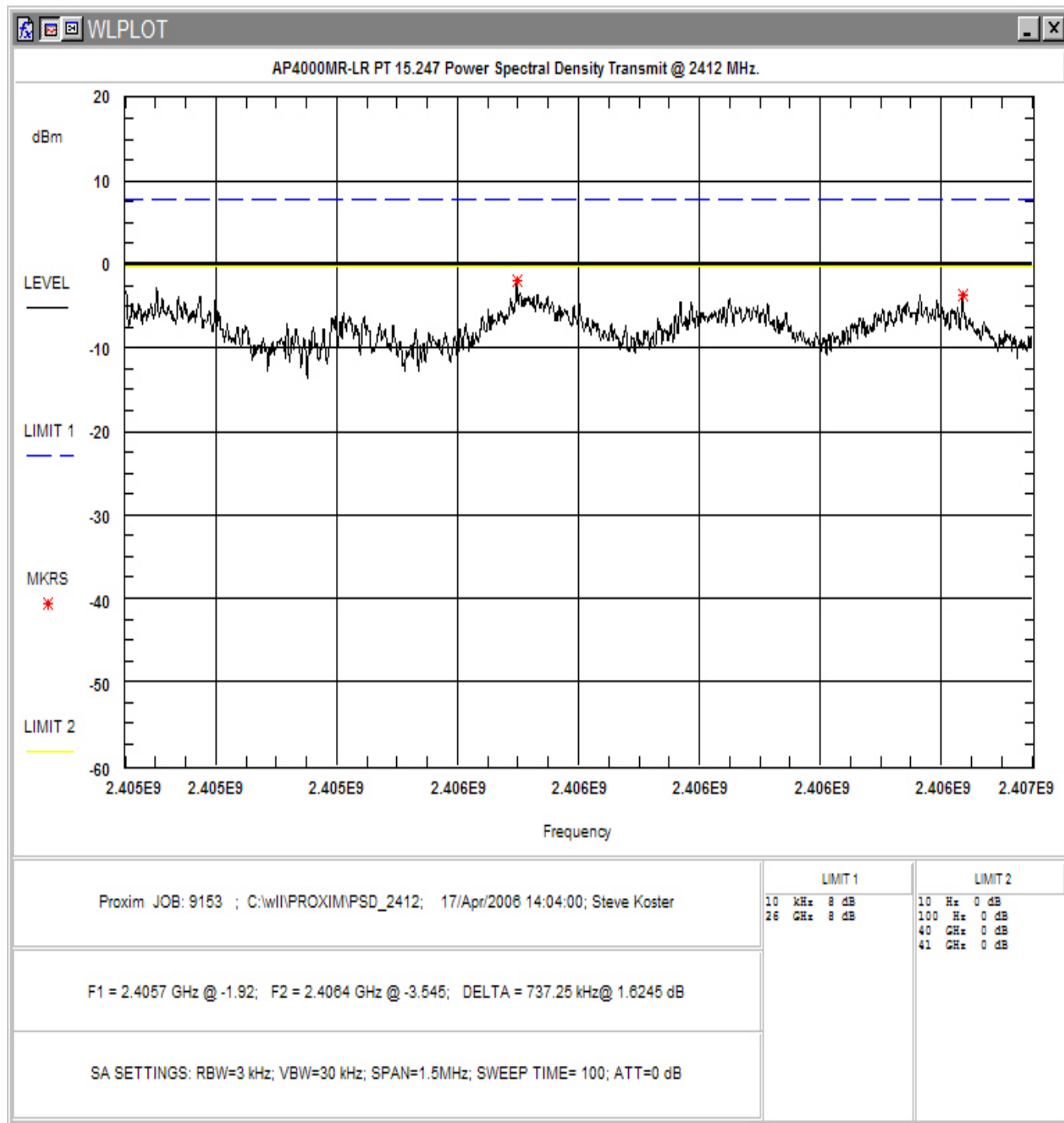

Figure 4-5: Power Spectral Density, Low Channel

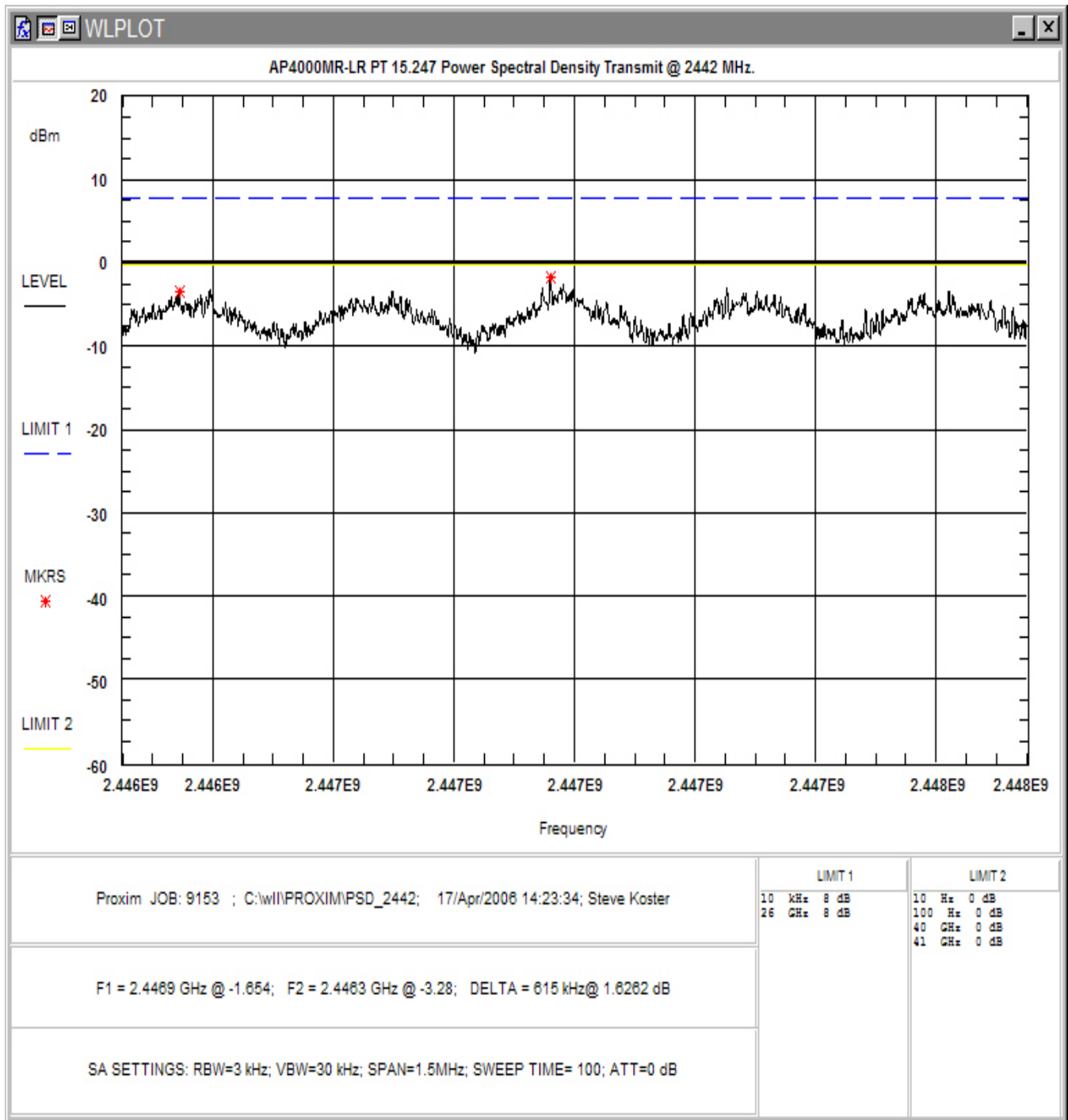

Figure 4-6: Power Spectral Density, Mid Channel

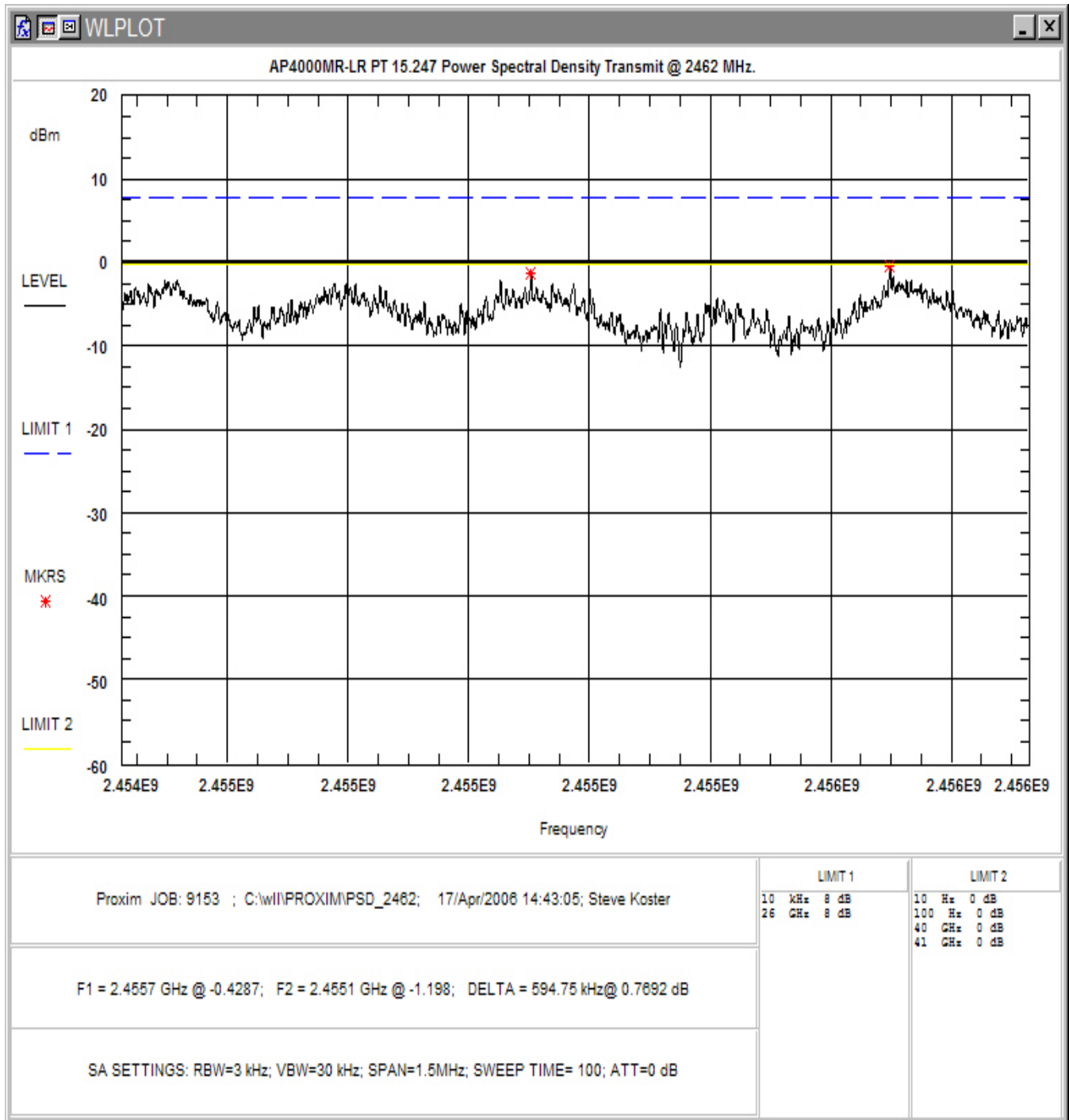

Figure 4-7: Power Spectral Density, High Channel

#### **4.4 Conducted Spurious Emissions at Antenna Terminals (FCC Part §2.1051)**

The EUT must comply with requirements for spurious emissions at antenna terminals. Per §15.247(c) all spurious emissions in any 100 kHz bandwidth outside the frequency band in which the spread spectrum device is operating shall be attenuated 20 dB below the highest power level in a 100 kHz bandwidth within the band containing the highest level of the desired power.

The EUT antenna was removed and the cable was connected directly into a spectrum analyzer through a 10 dB attenuator. An offset was programmed into the spectrum analyzer to compensate for the loss of the external attenuator. The spectrum analyzer resolution bandwidth was set to 100 kHz and the video bandwidth was set to 100 kHz. The amplitude of the EUT carrier frequency was measured to determine the emissions limit (20 dB below the carrier frequency amplitude). The emissions outside of the allocated frequency band were then scanned from 30 MHz up to the tenth harmonic of the carrier.

Conducted Spurious data was taken at Low Power and at High Power. The following are plots of the conducted spurious emissions data.

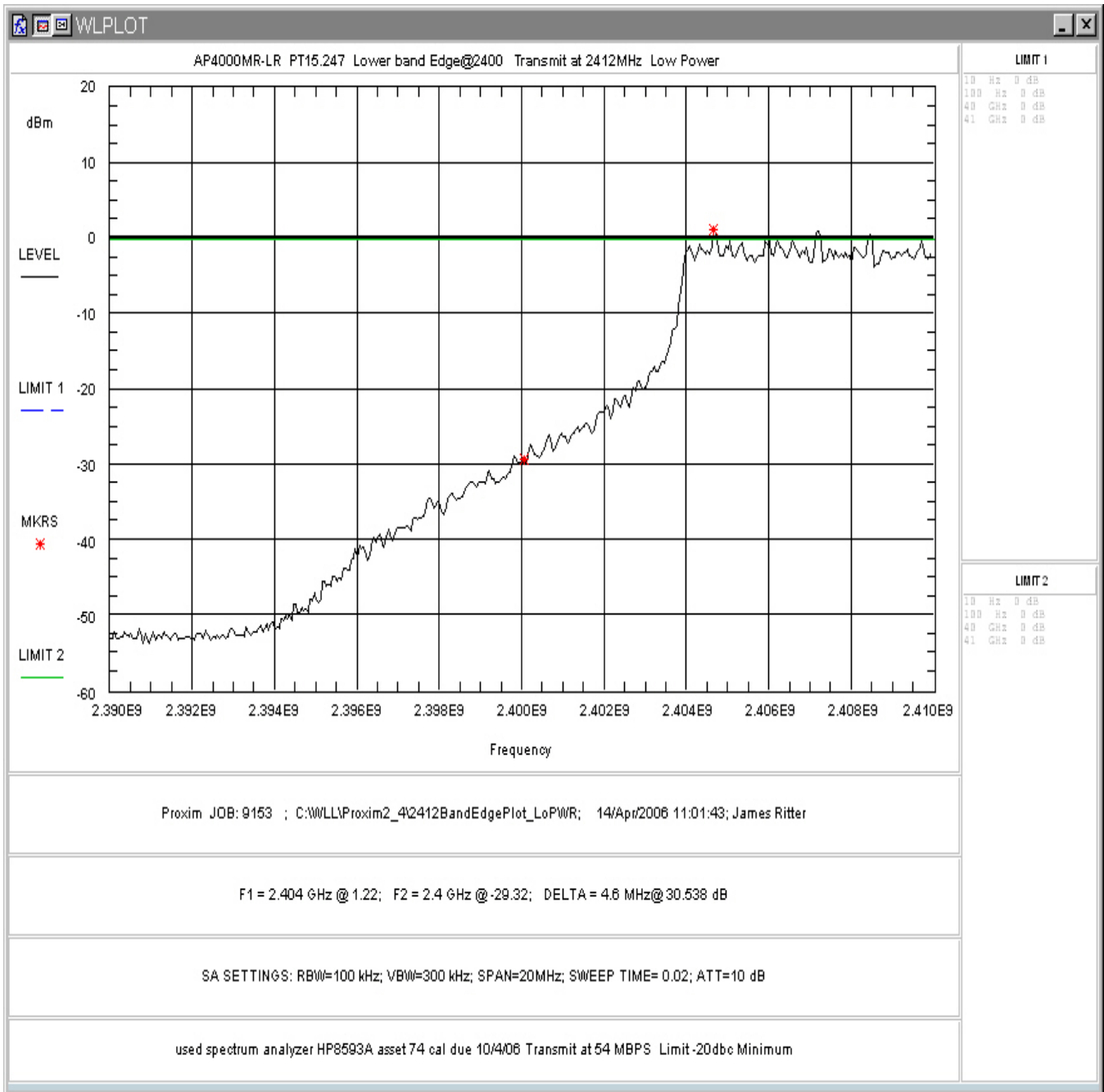

Figure 4-8. Conducted Spurious Emissions, Low Power: Low Channel Band Edge

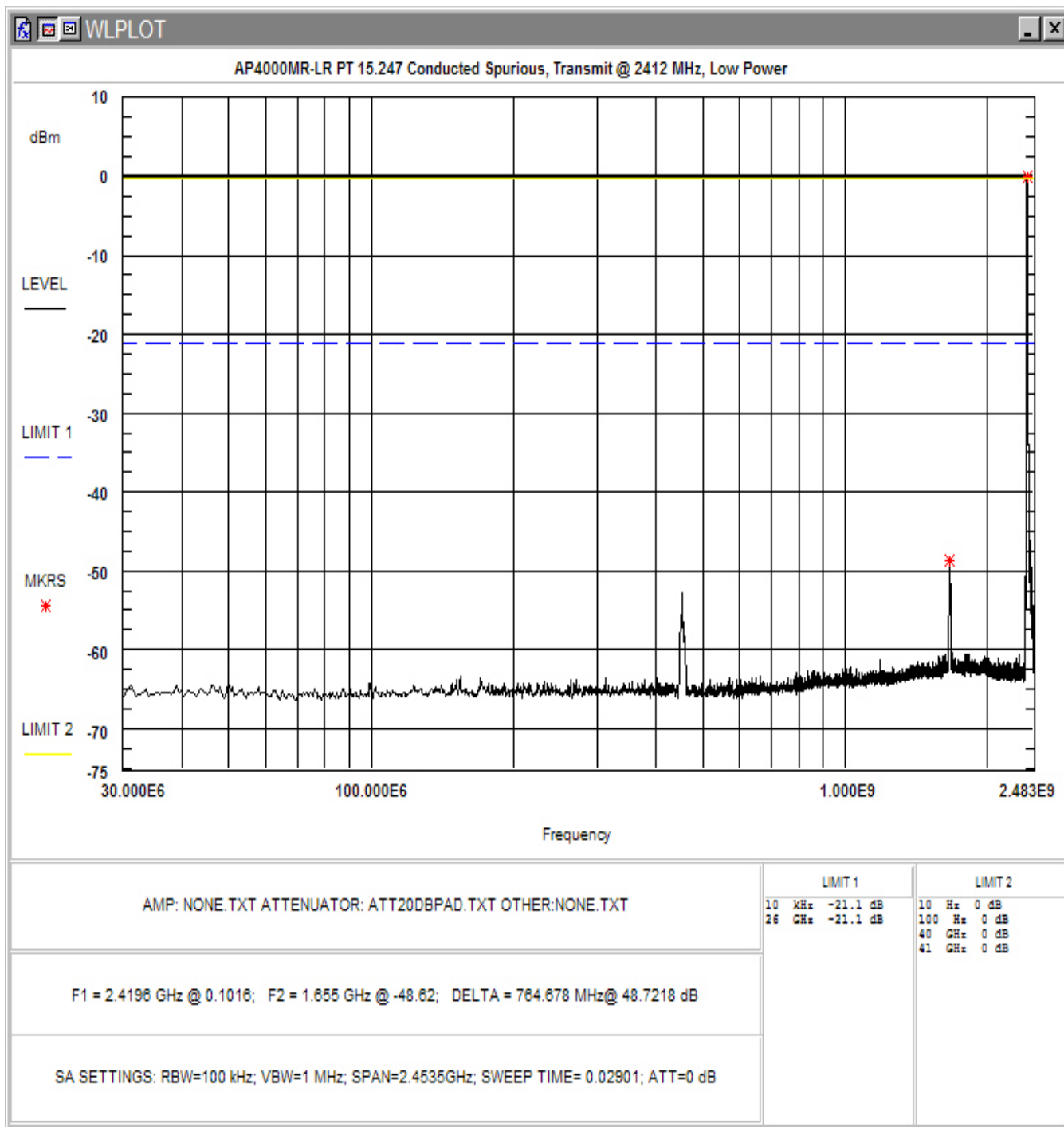

Figure 4-9. Conducted Spurious Emissions, Low Power: Low Channel 30 - 2483MHz

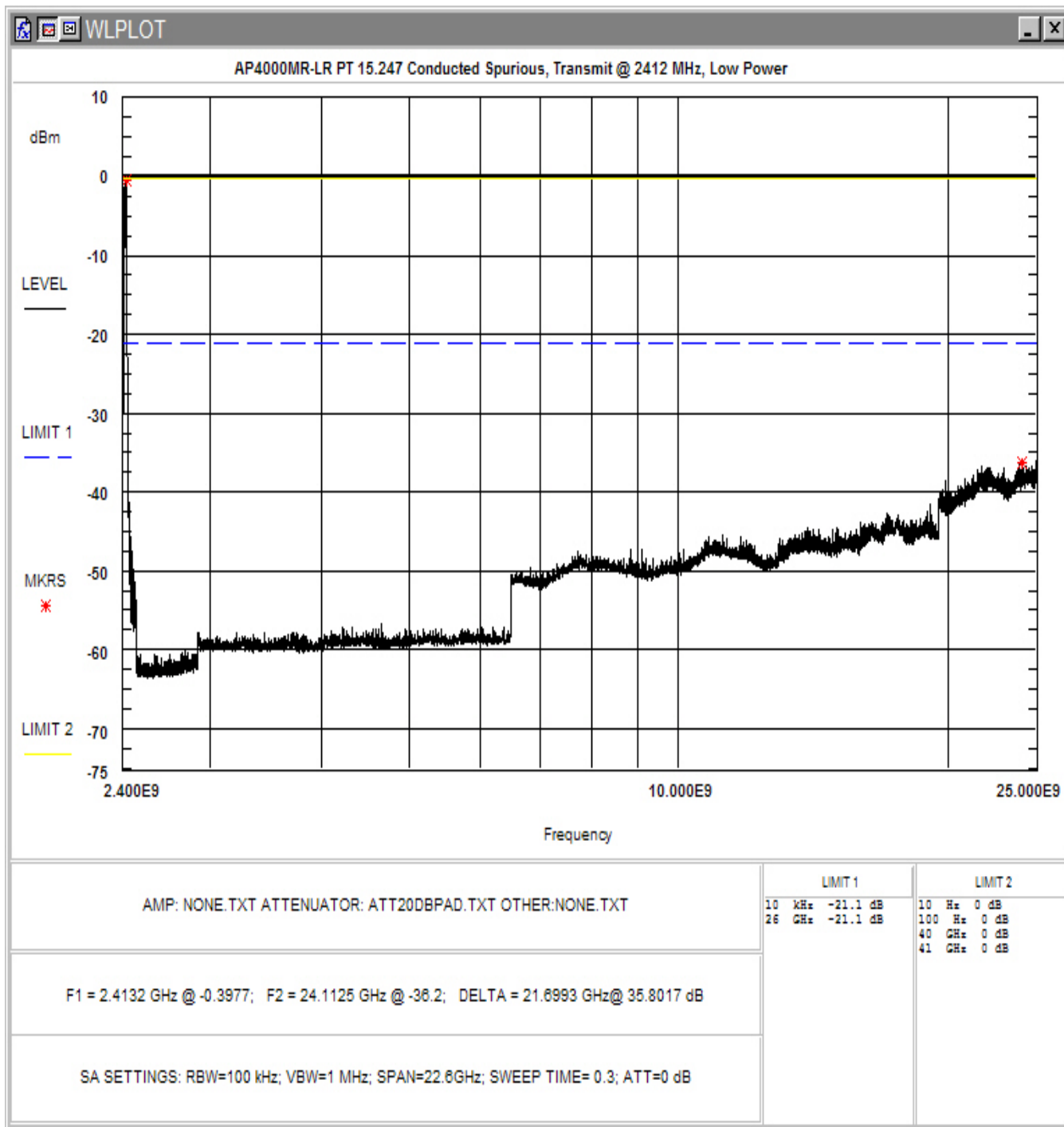

Figure 4-10. Conducted Spurious Emissions, Low Power: Low Channel 2.4– 25GHz

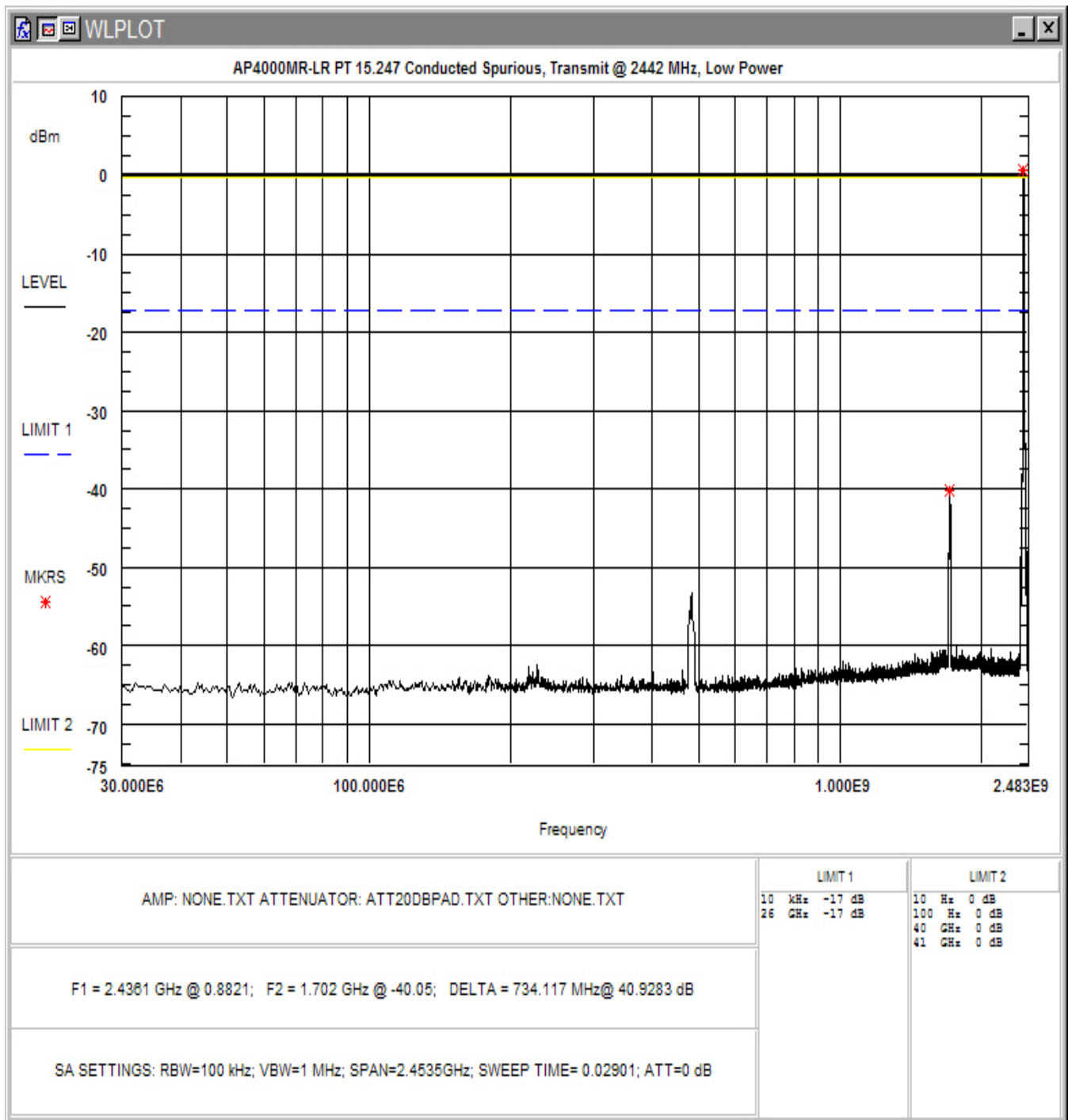

Figure 4-11. Conducted Spurious Emissions, Low Power: Mid Channel 30 – 2483MHz



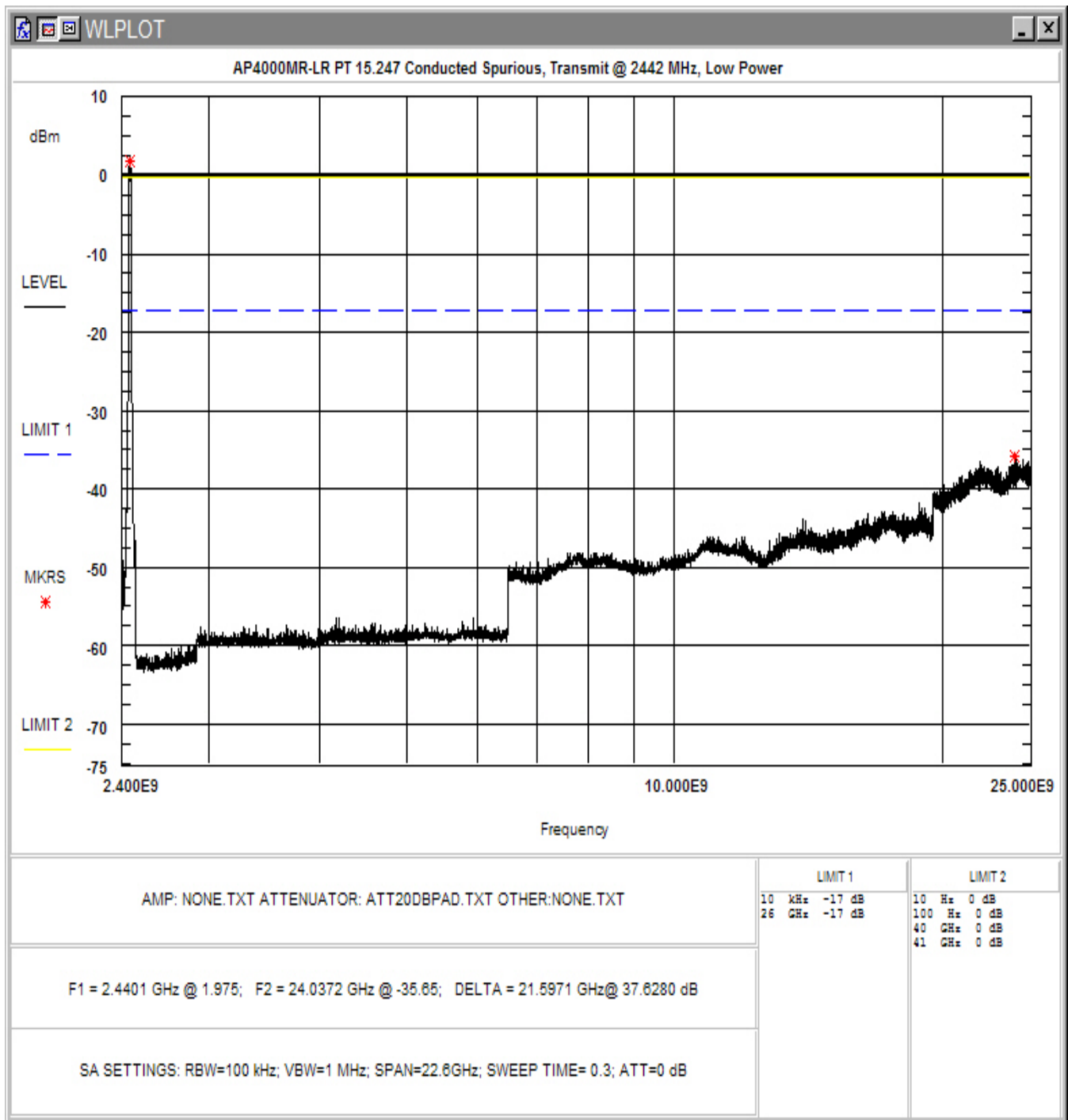

Figure 4-12. Conducted Spurious Emissions, Low Power: Mid Channel 2.4 - 25GHz

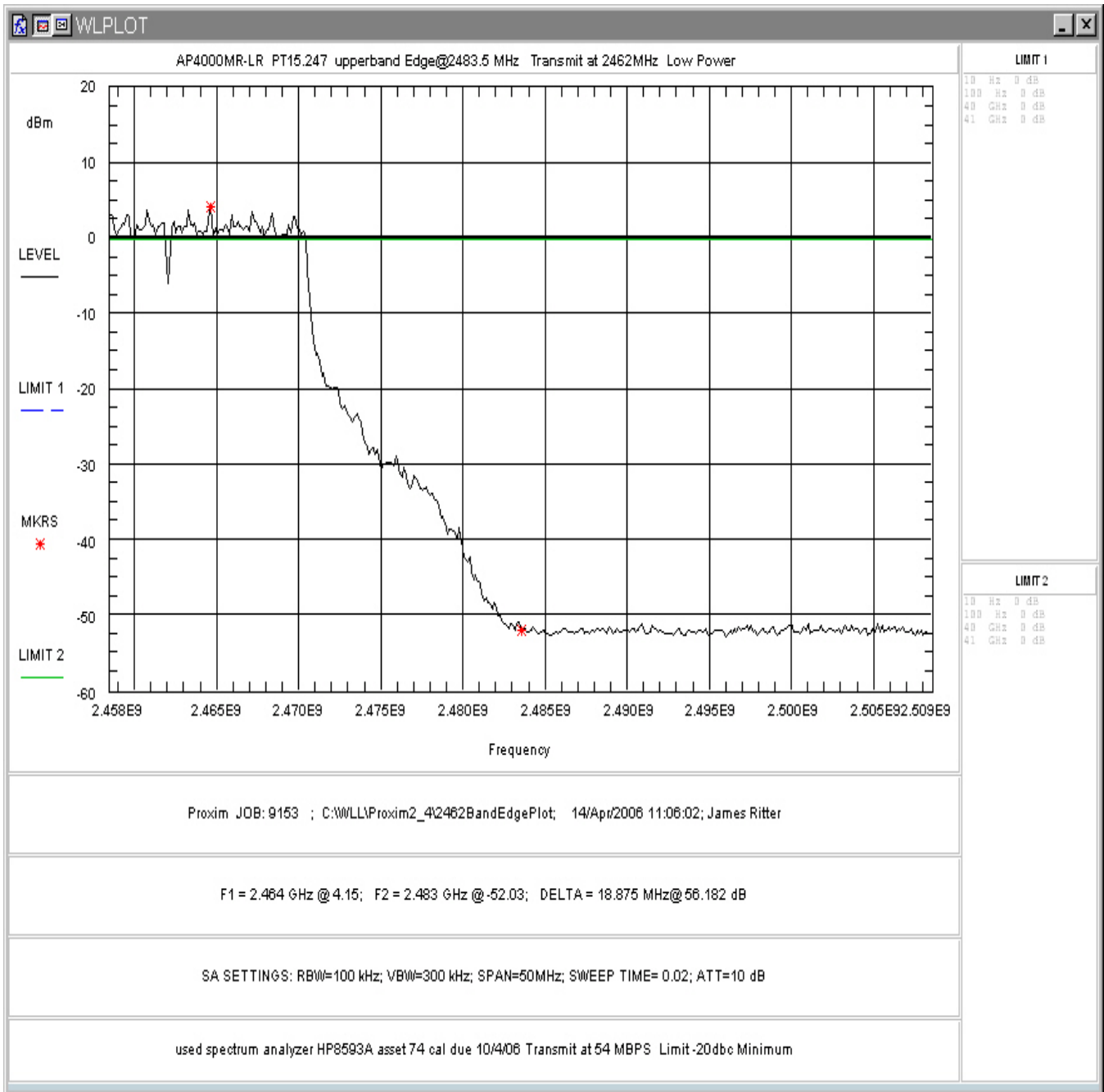

Figure 4-13. Conducted Spurious Emissions, Low Power: High Channel Band Edge

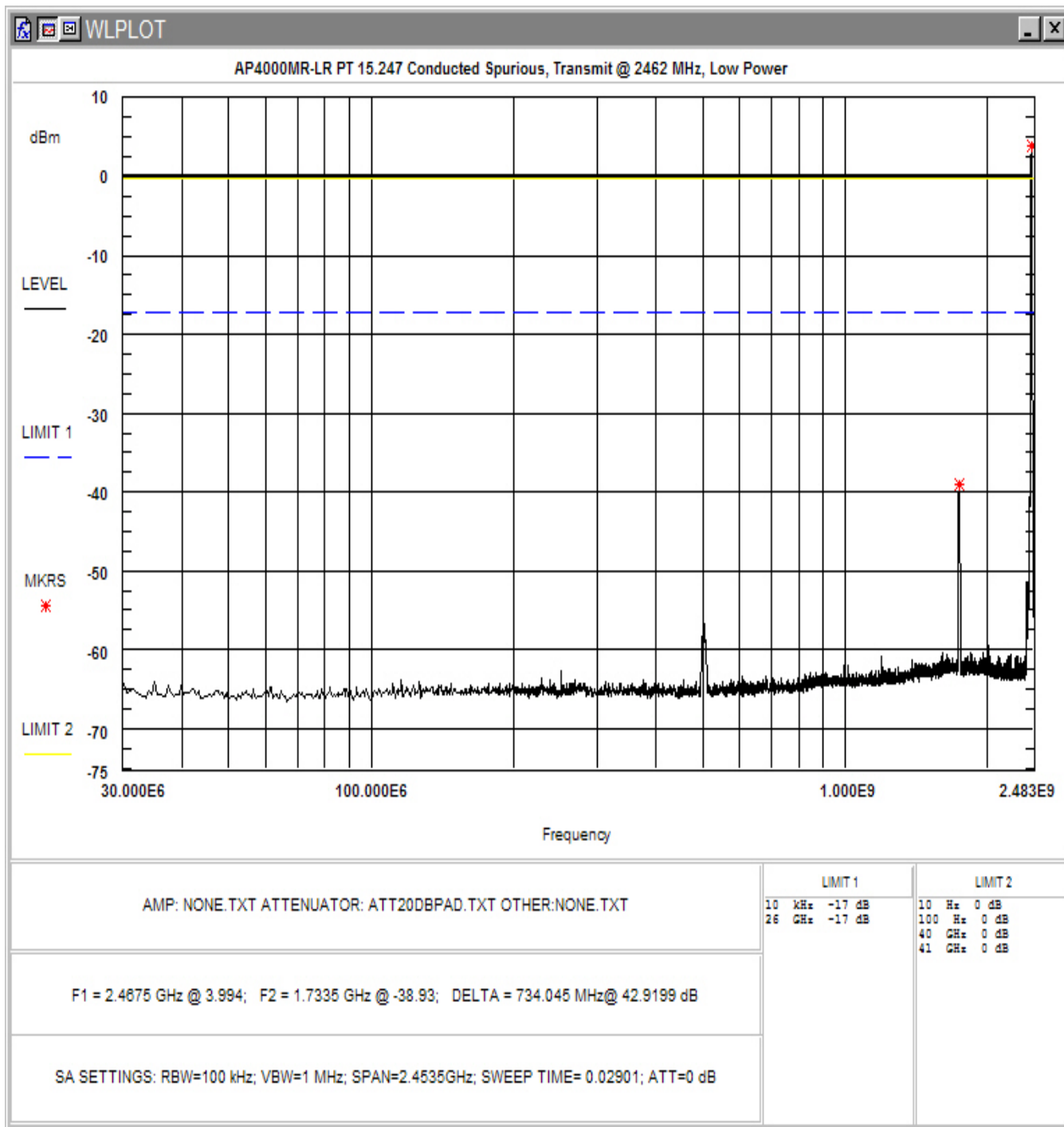

Figure 4-14. Conducted Spurious Emissions, Low Power: High Channel 30 – 2483MHz

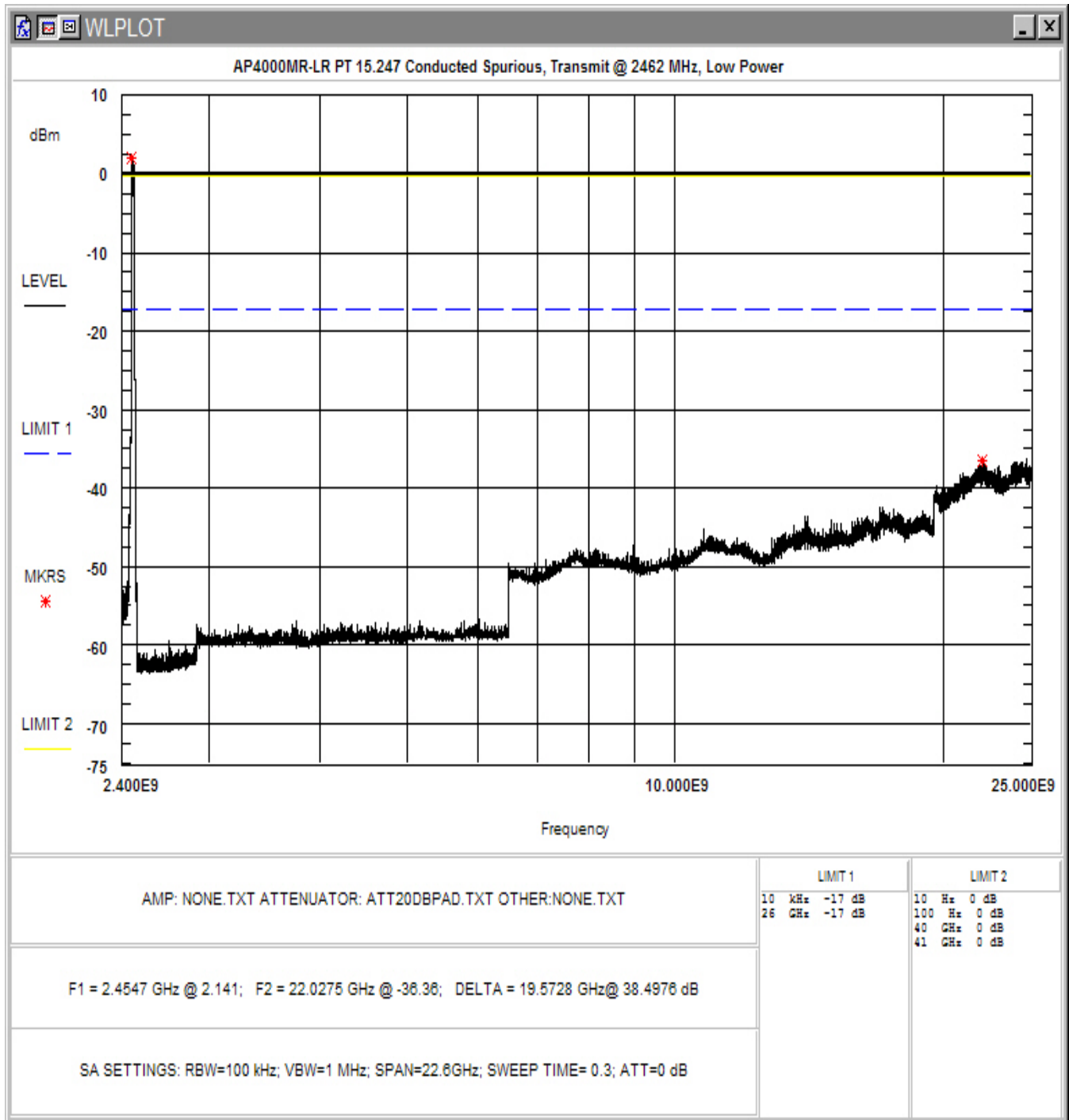

Figure 4-15. Conducted Spurious Emissions, Low Power: High Channel 2.4 - 25GHz

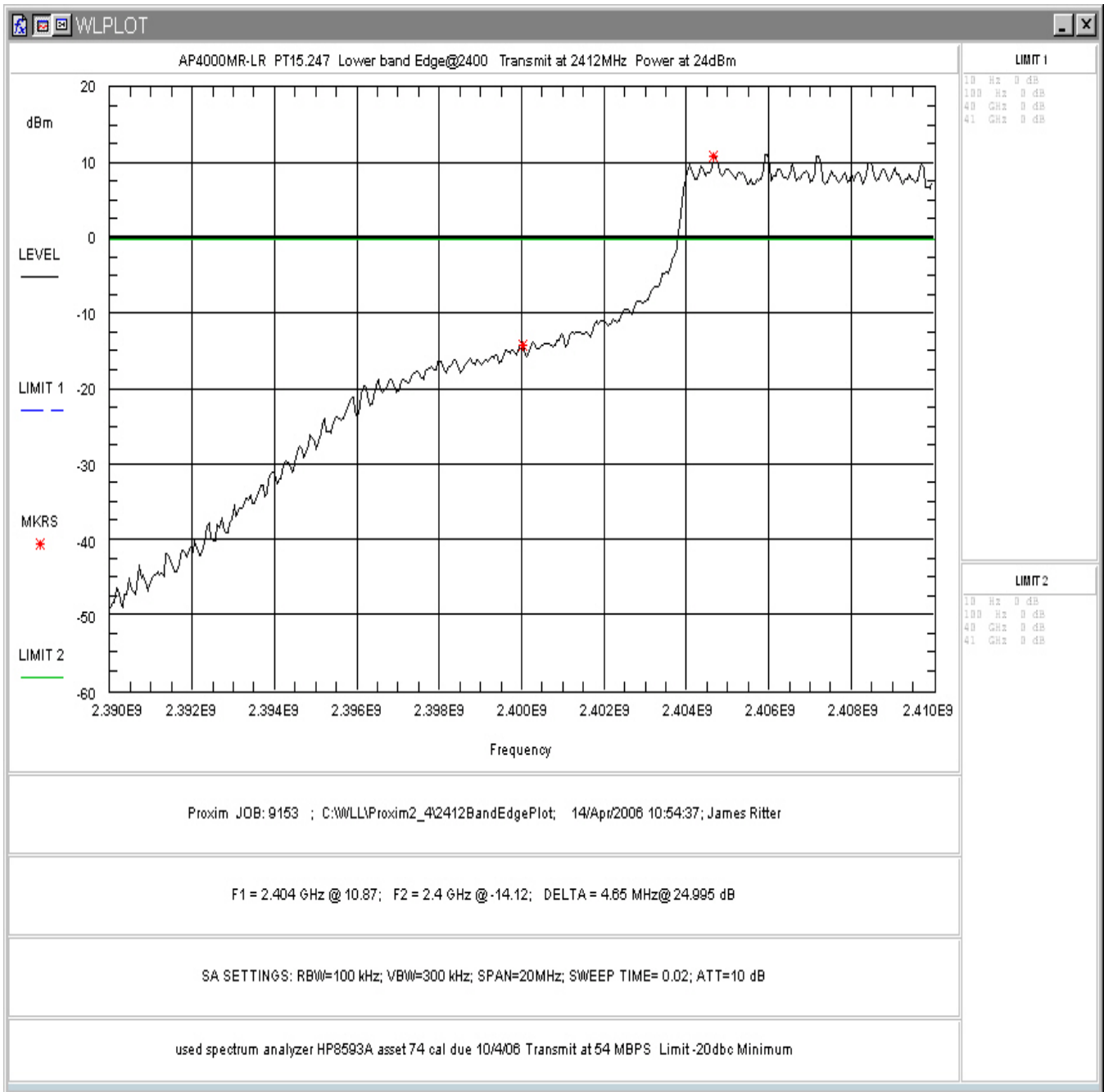

Figure 4-16. Conducted Spurious Emissions, High Power: Low Channel Band Edge

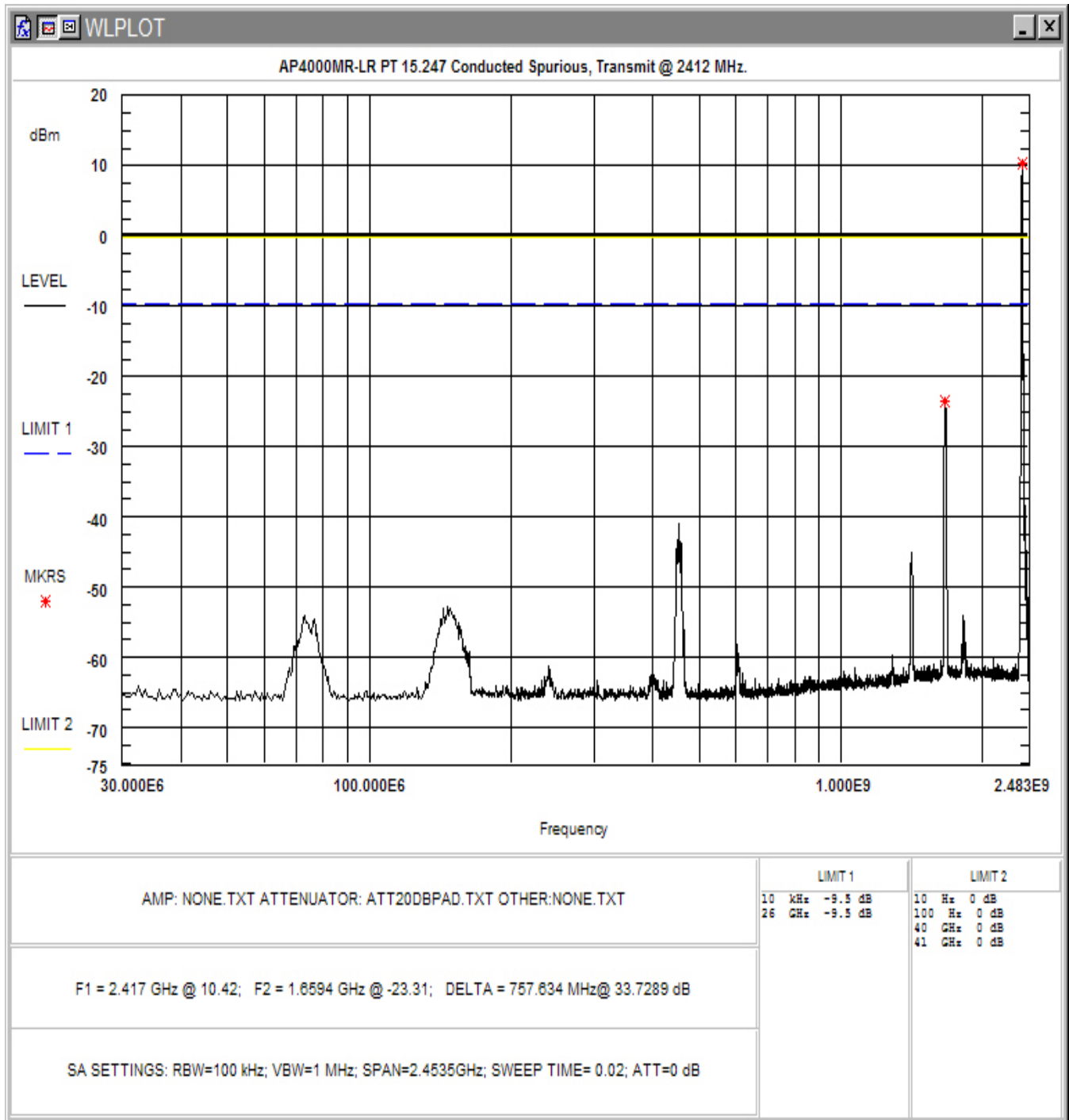

Figure 4-17. Conducted Spurious Emissions, High Power: Low Channel 30 - 2483MHz

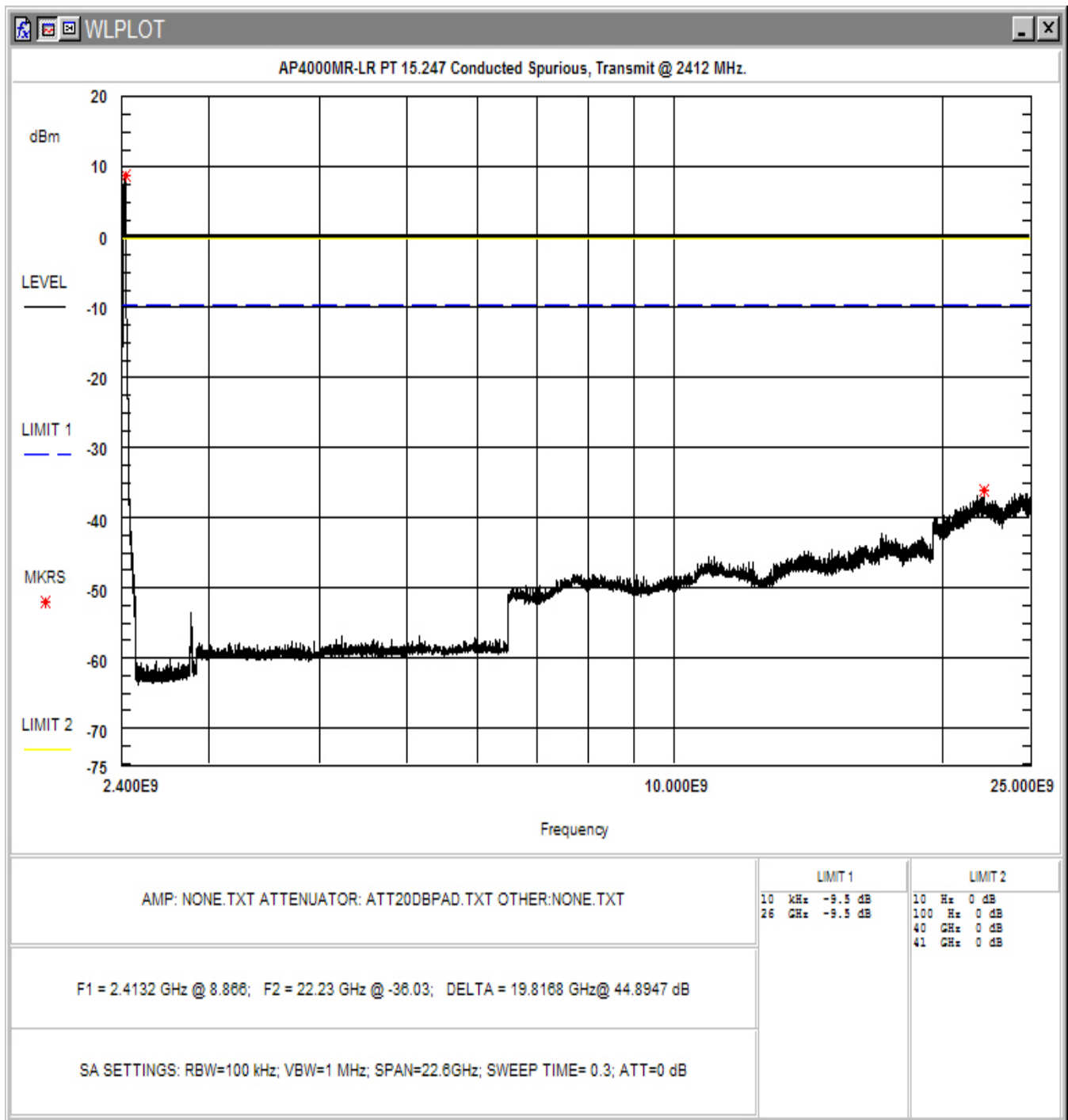

Figure 4-18. Conducted Spurious Emissions, High Power: Low Channel 2.4 – 25GHz

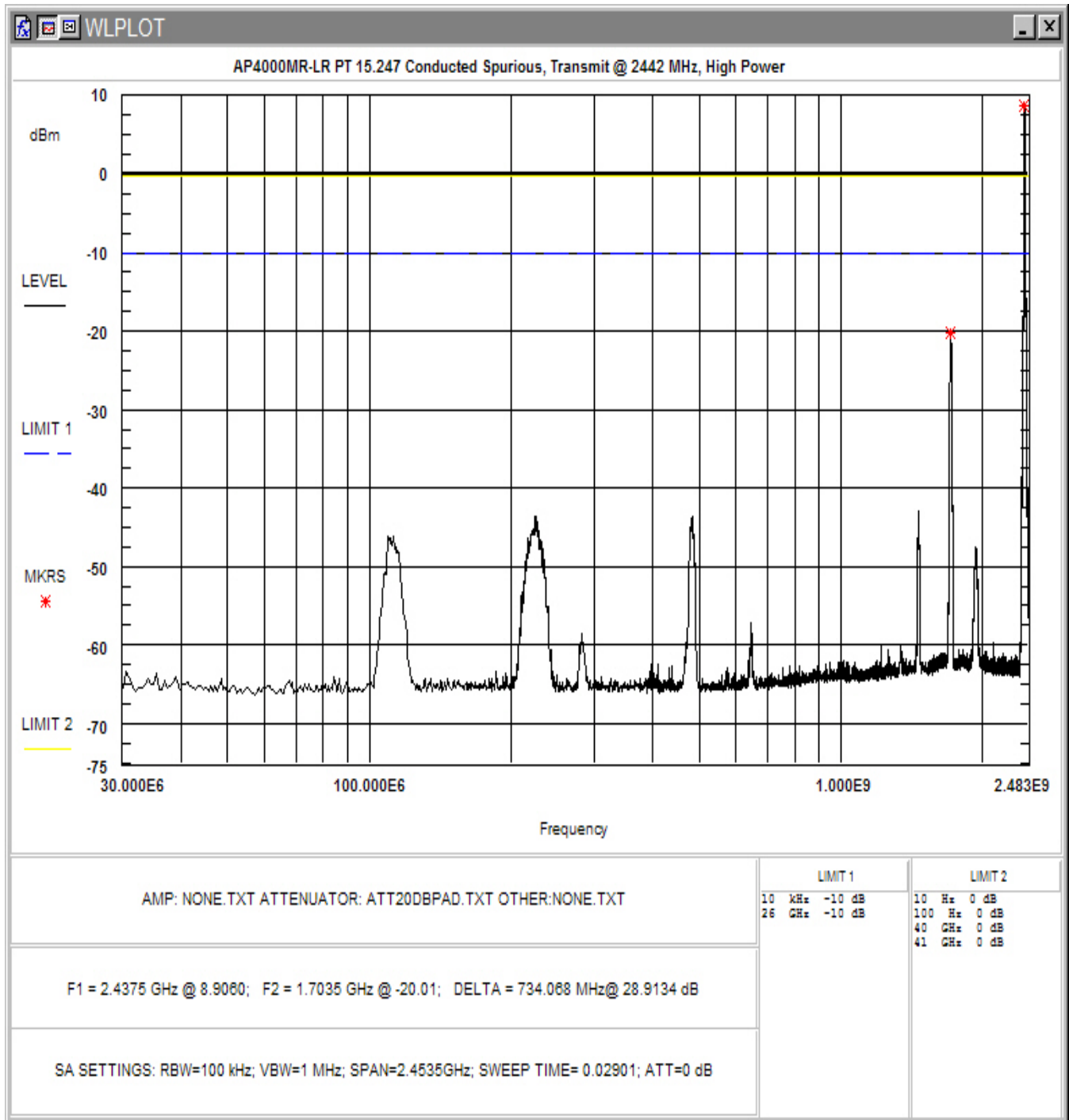

Figure 4-19. Conducted Spurious Emissions, High Power: Mid Channel 30 – 2483MHz



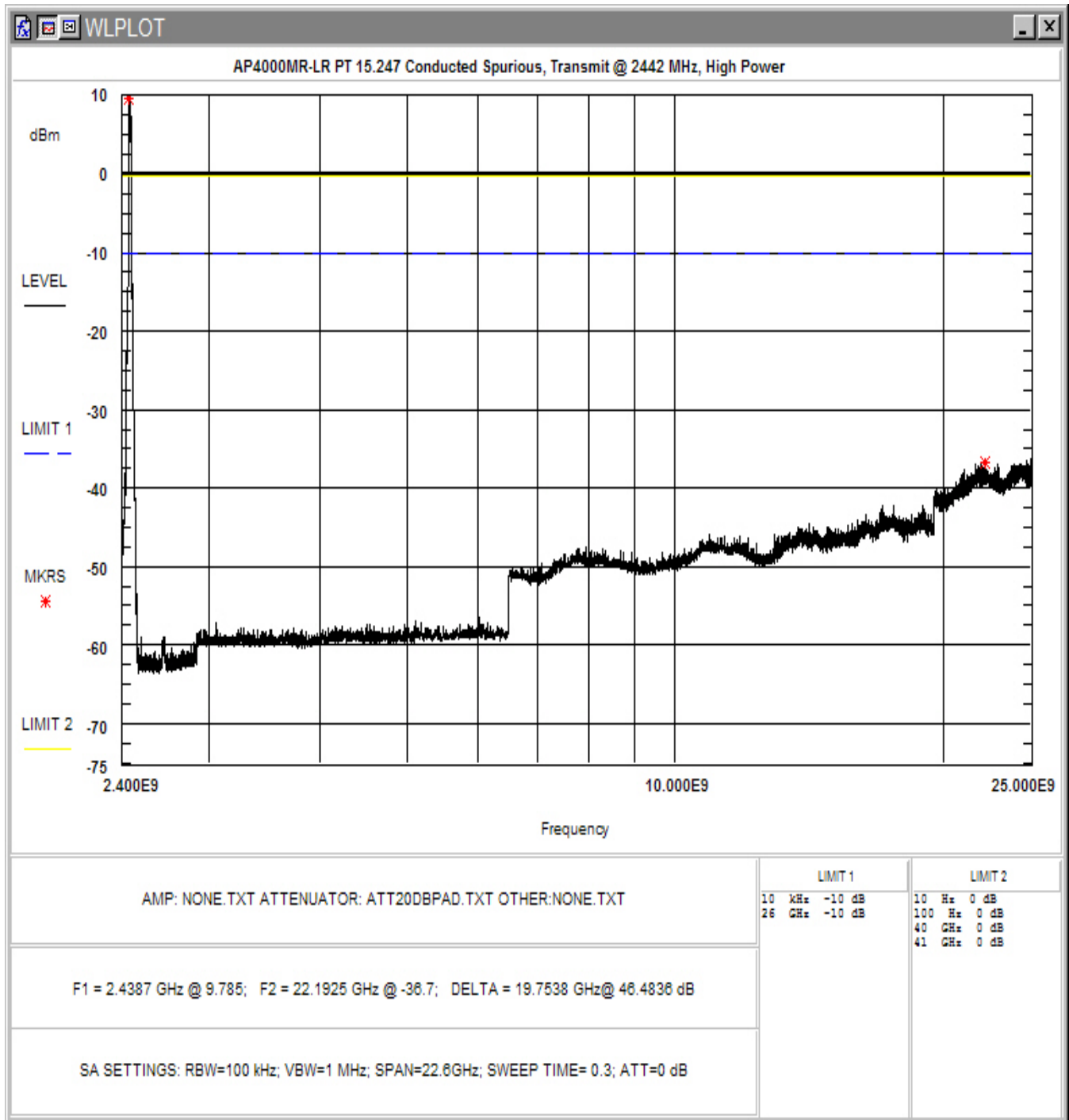

Figure 4-20. Conducted Spurious Emissions, High Power: Mid Channel 2.4 - 25GHz

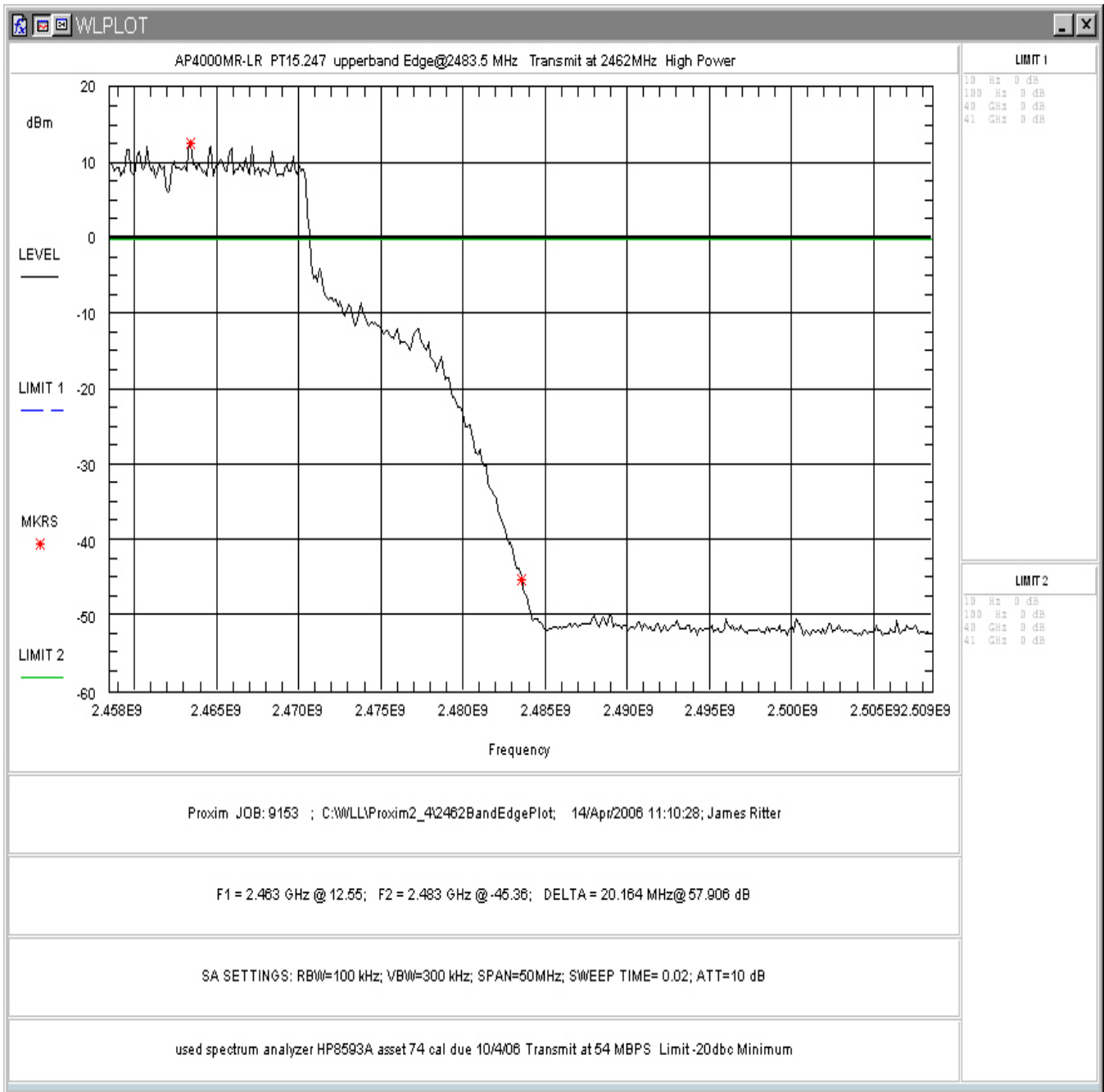

Figure 4-21. Conducted Spurious Emissions, High Power: High Channel Band Edge

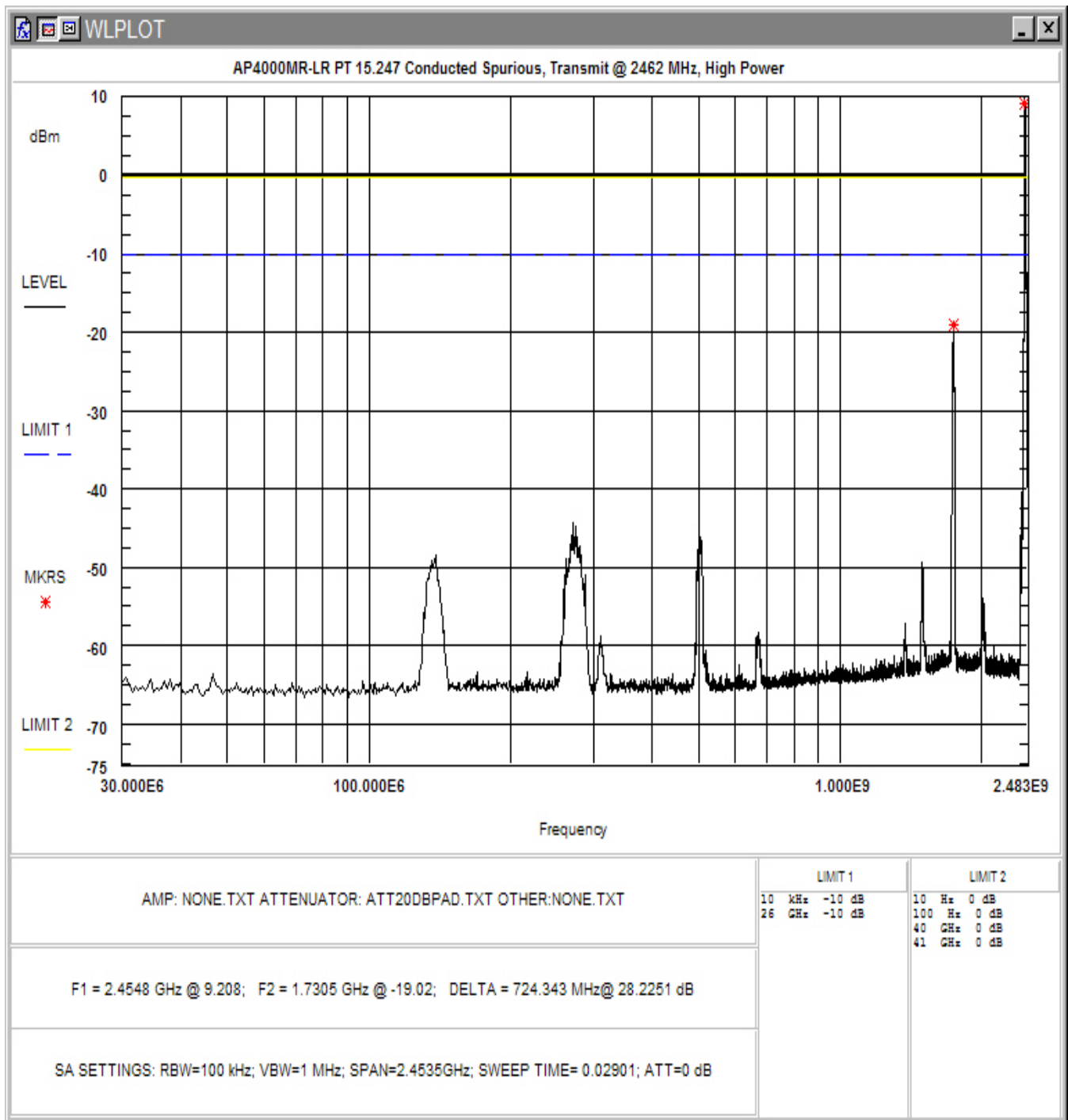

Figure 4-22. Conducted Spurious Emissions, High Power: High Channel 30 – 2483MHz

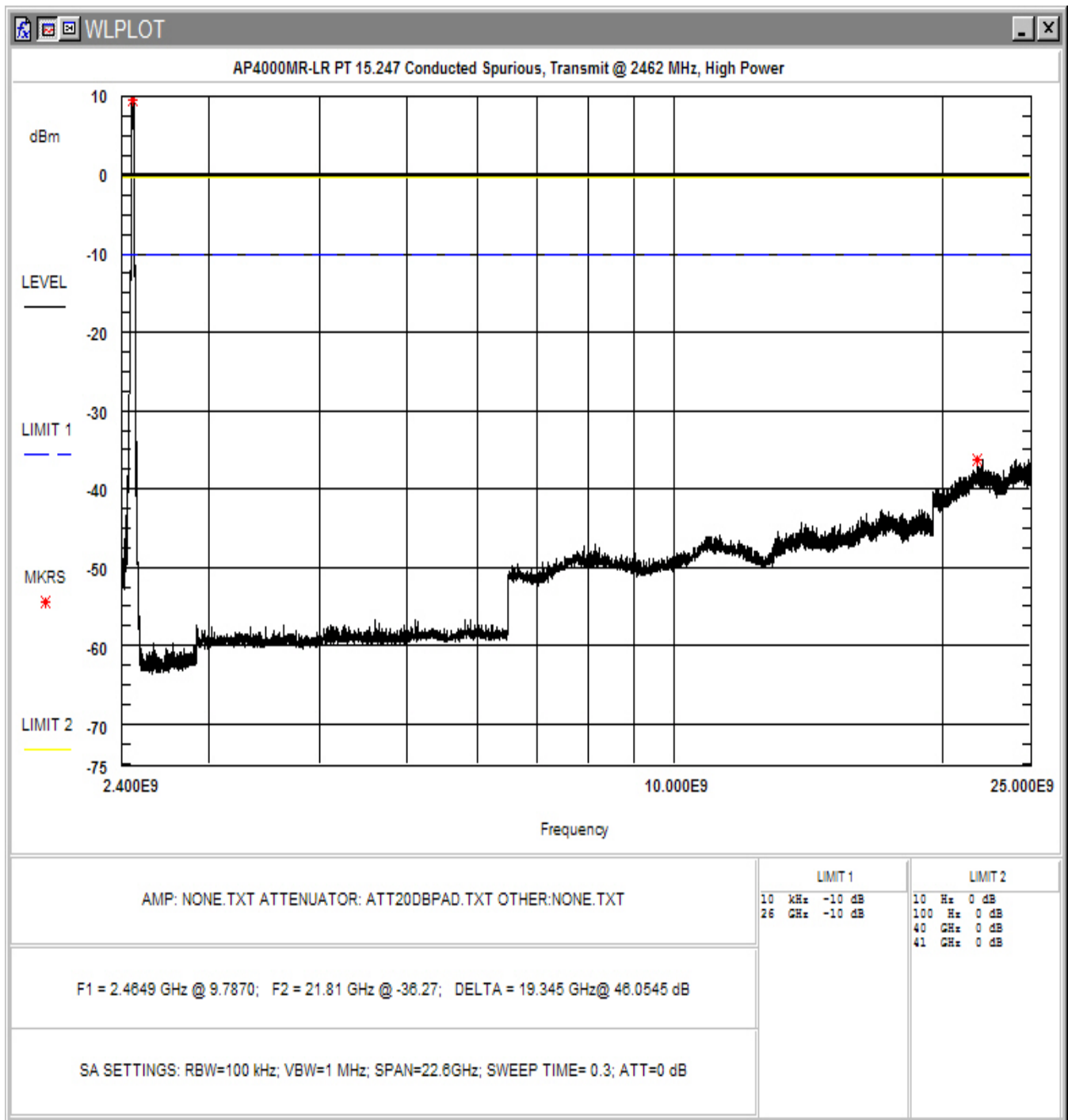

Figure 4-23. Conducted Spurious Emissions, High Power: High Channel 2.4 - 25GHz

#### 4.5 Radiated Spurious Emissions: (FCC Part §2.1053)

The EUT must comply with the requirements for radiated spurious emissions that fall within the restricted bands. These emissions must meet the limits specified in §15.209 and §15.35(b) for peak measurements.

##### 4.5.1 Test Procedure

The EUT was placed on motorized turntable for radiated testing on a 3-meter open field test site. The emissions from the EUT were measured continuously at every azimuth by rotating the turntable. Receiving antennas were mounted on an antenna mast to determine the height of maximum emissions. The height of the antenna was varied between 1 and 4 meters. The peripherals were placed on the table in accordance with ANSI C63.4-2001. Cables were varied in position to produce maximum emissions. Both the horizontal and vertical field components were measured.

The emissions were measured using the following resolution bandwidths:

Frequency Range	Resolution Bandwidth	Video Bandwidth
30MHz-1000 MHz	120kHz	>100 kHz
>1000 MHz	1 MHz	<30 Hz (Avg.) 1MHz (Peak)

The following is a sample calculation used in the data tables for calculating the final field strength of spurious emissions and comparing these levels to the specified limits.

##### Sample Calculation:

Spectrum Analyzer Voltage (SA Level):      V dBμV  
 Antenna Factor (Ant Corr):                      AFdB/m  
 Cable Loss Correction (Cable Corr):           CCdB  
 Amplifier Gain:                                      GdB  
 Electric Field (Corr Level):                      EdBμV/m = VdBμV + AFdB/m + CCdB - GdB  
 To convert to linear units:                        EμV/m = antilog (EdBμV/m/20)

Data are supplied in the following tables. Testing was performed to 25GHz. All detected emissions are reported in the following tables. Both peak and average measurements are listed.

**Table 5: Radiated Emission Test Data: Antenna A2.45LP17**

Frequency (MHz)	Polarity H/V	Az Deg	Ant. Height (m)	SA Level (dBµV)	Ant. Corr. (dB/m)	Cable Corr. (dB)	Amp Gain (dB)	Filter Corr (dB)	Corr. Level (dBµV/m)	Corr. Level (µV/m)	Limit (µV/m)	Margin (dB)	Notes
A2.45LP17													
<b>Bandedge Ch. 1</b>													
2390.000	V	45.0	1.0	56.7	28.9	2.9	38.1	0.0	50.4	330.4	500.0	-3.6	avg peak
2390.000	V	45.0	1.0	69.2	28.9	2.9	38.1	0.0	62.9	1393.4	5000.0	-11.1	peak
2390.000	H	130.0	1.0	55.2	28.9	2.9	38.1	0.0	48.9	278.0	500.0	-5.1	avg peak
2390.000	H	130.0	1.0	67.8	28.9	2.9	38.1	0.0	61.5	1186.0	5000.0	-12.5	peak
<b>Ch. 11</b>													
2483.500	V	0.0	1.0	57.6	29.1	3.0	38.1	0.0	51.6	378.5	500.0	-2.4	avg peak
2483.500	V	0.0	1.0	71.2	29.1	3.0	38.1	0.0	65.2	1811.9	5000.0	-8.8	peak
2483.500	H	0.0	1.0	56.7	29.1	3.0	38.1	0.0	50.7	341.3	500.0	-3.3	avg peak
2483.500	H	0.0	1.0	67.8	29.1	3.0	38.1	0.0	61.8	1225.0	5000.0	-12.2	peak
<b>Data below 2.4GHz: Ch1 (Same Ch 6 and Ch 11)</b>													
1197.730	V	0.0	1.0	41.6	25.5	2.3	39.0	0.8	31.1	36.0	500.0	-22.9	avg
1329.700	V	0.0	1.0	44.0	26.0	2.3	38.8	1.2	34.7	54.2	500.0	-19.3	avg
1462.150	V	0.0	1.0	45.4	26.5	2.3	38.7	1.7	37.1	72.0	500.0	-16.8	avg
1064.000	V	0.0	1.0	56.5	24.9	2.2	39.2	0.6	45.0	177.9	5000.0	-29.0	peak
1197.730	V	0.0	1.0	60.7	25.5	2.3	39.0	0.8	50.3	326.1	5000.0	-23.7	peak
1329.700	V	0.0	1.0	57.0	26.0	2.3	38.8	1.2	47.7	242.3	5000.0	-26.3	peak
1462.150	V	0.0	1.0	58.8	26.5	2.3	38.7	1.7	50.5	336.6	5000.0	-23.4	peak
1197.730	H	60.0	1.0	49.0	25.5	2.3	39.0	0.8	38.5	84.4	500.0	-15.5	avg
1329.700	H	60.0	1.0	43.5	26.0	2.3	38.8	1.2	34.2	51.2	500.0	-19.8	avg
1462.150	H	0.0	1.0	42.8	26.5	2.3	38.7	1.7	34.5	53.4	500.0	-19.4	avg
1064.000	H	60.0	1.0	57.5	24.9	2.2	39.2	0.6	46.0	199.7	5000.0	-28.0	peak
1197.730	H	60.0	1.0	61.4	25.5	2.3	39.0	0.8	50.9	351.9	5000.0	-23.1	peak
1329.700	H	60.0	1.0	56.0	26.0	2.3	38.8	1.2	46.7	215.9	5000.0	-27.3	peak
1462.150	H	0.0	1.0	56.0	26.5	2.3	38.7	1.7	47.7	243.9	5000.0	-26.2	peak
<b>Ch. 11 2462</b>													
4924.000	V	0.0	1.0	35.5	32.7	4.1	37.2	0.0	35.1	56.7	500.0	-18.9	avg
7386.000	V	0.0	1.0	35.4	37.1	5.1	37.6	0.0	40.0	99.9	500.0	-14.0	avg (amb)
12309.750	V	0.0	1.0	35.8	40.0	6.7	37.3	0.0	45.2	182.4	500.0	-8.8	avg (amb)
4924.000	V	0.0	1.0	47.5	32.7	4.1	37.2	0.0	47.1	225.5	5000.0	-26.9	peak
7386.000	V	0.0	1.0	47.5	37.1	5.1	37.6	0.0	52.1	402.3	5000.0	-21.9	peak (amb)
12309.750	V	0.0	1.0	48.4	40.0	6.7	37.3	0.0	57.8	778.3	5000.0	-16.2	peak (amb)
4924.000	H	0.0	1.0	36.2	32.7	4.1	37.2	0.0	35.8	61.4	500.0	-18.2	avg

Frequency (MHz)	Polarity H/V	Az Deg	Ant. Height (m)	SA Level (dBμV)	Ant. Corr. (dB/m)	Cable Corr. (dB)	Amp Gain (dB)	Filter Corr (dB)	Corr. Level (dBμV/m)	Corr. Level (μV/m)	Limit (μV/m)	Margin (dB)	Notes
7386.000	H	0.0	1.0	35.4	37.1	5.1	37.6	0.0	40.0	99.9	500.0	-14.0	avg (amb)
12309.750	H	0.0	1.0	35.6	40.0	6.7	37.3	0.0	45.0	178.3	500.0	-9.0	avg (amb)
4924.000	H	0.0	1.0	47.4	32.7	4.1	37.2	0.0	47.0	222.9	5000.0	-27.0	peak
7386.000	H	0.0	1.0	47.4	37.1	5.1	37.6	0.0	52.0	397.7	5000.0	-22.0	peak (amb)
12309.750	H	0.0	1.0	46.6	40.0	6.7	37.3	0.0	56.0	632.6	5000.0	-18.0	peak (amb)

Ch1	2412												
2483.500	V												amb
2483.500	V												amb
4824.000	V	30.0	1.0	36.4	32.5	4.1	37.2	0.0	35.8	61.4	500.0	-18.2	avg
12060.000	V	0.0	1.0	36.0	40.0	6.6	37.8	0.0	44.8	174.1	500.0	-9.2	avg (amb)
14472.000	V	0.0	1.0	36.1	41.3	7.5	36.9	0.0	48.0	251.4	500.0	-6.0	avg (amb)
4824.000	V	30.0	1.0	49.0	32.5	4.1	37.2	0.0	48.4	261.8	5000.0	-25.6	peak
12060.000	V	0.0	1.0	48.4	40.0	6.6	37.8	0.0	57.2	725.9	5000.0	-16.8	peak (amb)
14472.000	V	0.0	1.0	46.8	41.3	7.5	36.9	0.0	58.7	861.7	5000.0	-15.3	peak (amb)
2483.500	H												amb
2483.500	H												amb
4824.000	H	0.0	1.0	36.6	32.5	4.1	37.2	0.0	36.0	62.8	500.0	-18.0	avg
12060.000	H	0.0	1.0	36.3	40.0	6.6	37.8	0.0	45.1	180.2	500.0	-8.9	avg (amb)
14472.000	H	0.0	1.0	36.2	41.3	7.5	36.9	0.0	48.1	254.3	500.0	-5.9	avg (amb)
4824.000	H	0.0	1.0	50.0	32.5	4.1	37.2	0.0	49.4	293.8	5000.0	-24.6	peak
12060.000	H	0.0	1.0	46.8	40.0	6.6	37.8	0.0	55.6	603.8	5000.0	-18.4	peak (amb)
14472.000	H	0.0	1.0	47.0	41.3	7.5	36.9	0.0	58.9	881.7	5000.0	-15.1	peak (amb)

Ch6	2442												
2483.500	V	0.0	1.0	67.0	29.1	3.0	38.1	0.0	61.0	1117.2	5000.0	-13.0	peak (amb)
2483.500	V	0.0	1.0	54.9	29.1	3.0	38.1	0.0	48.9	277.4	500.0	-5.1	avg (amb)
4884.000	V	180.0	1.0	35.4	32.5	4.1	37.2	0.0	34.8	54.7	500.0	-19.2	avg
7326.000	V	0.0	1.0	35.0	37.1	5.0	37.6	0.0	39.6	95.1	500.0	-14.4	avg (amb)
12210.000	V	0.0	1.0	35.7	40.0	6.6	37.5	0.0	44.9	175.4	500.0	-9.1	avg (amb)
4884.000	V	180.0	1.0	47.5	32.5	4.1	37.2	0.0	46.9	220.3	5000.0	-27.1	peak
7326.000	V	0.0	1.0	47.7	37.1	5.0	37.6	0.0	52.3	410.5	5000.0	-21.7	peak (amb)

Frequency (MHz)	Polarity H/V	Az Deg	Ant. Height (m)	SA Level (dBµV)	Ant. Corr. (dB/m)	Cable Corr. (dB)	Amp Gain (dB)	Filter Corr (dB)	Corr. Level (dBµV/m)	Corr. Level (µV/m)	Limit (µV/m)	Margin (dB)	Notes
12210.000	V	0.0	1.0	47.9	40.0	6.6	37.5	0.0	57.1	714.7	5000.0	-16.9	peak (amb)
2483.500	H												amb
2483.500	H												amb
4884.000	H	0.0	1.0	33.6	32.6	4.1	37.2	0.0	33.1	45.1	500.0	-20.9	avg (amb)
7326.000	H	0.0	1.0	35.2	37.1	5.0	37.6	0.0	39.8	97.4	500.0	-14.2	avg (amb)
12210.000	H	0.0	1.0	35.5	40.0	6.6	37.5	0.0	44.7	171.4	500.0	-9.3	avg (amb)
4884.000	H	0.0	1.0	46.7	32.6	4.1	37.2	0.0	46.2	204.0	5000.0	-27.8	peak (amb)
7326.400	H	0.0	1.0	46.4	37.1	5.0	37.6	0.0	51.0	353.5	5000.0	-23.0	peak (amb)
12210.000	H	0.0	1.0	46.5	40.0	6.6	37.5	0.0	55.7	608.3	5000.0	-18.3	peak (amb)

**Table 6: Radiated Emission Test Data: Antenna A2412-0**

Frequency (MHz)	Polarity H/V	Az Deg	Ant. Height (m)	SA Level (dBµV)	Ant. Corr. (dB/m)	Cable Corr. (dB)	Amp Gain (dB)	Filter Corr (dB)	Corr. Level (dBµV/m)	Corr. Level (µV/m)	Limit (µV/m)	Margin (dB)	Notes
A2412-0													
<b>Bandedge Ch. 1</b>													
2390.000	V	208.0	1.0	58.8	28.9	2.9	38.1	0.0	52.5	420.8	500.0	-1.5	avg
2390.000	V	208.0	1.0	69.3	28.9	2.9	38.1	0.0	63.0	1409.6	5000.0	-11.0	peak
2390.000	H	125.0	1.0	56.9	28.9	2.9	38.1	0.0	50.6	338.1	500.0	-3.4	avg
2390.000	H	125.0	1.0	69.8	28.9	2.9	38.1	0.0	63.5	1493.1	5000.0	-10.5	peak
<b>Ch. 11</b>													
2483.500	V	200.0	1.0	57.8	29.1	3.0	38.1	0.0	51.8	387.4	500.0	-2.2	avg
2483.500	V	200.0	1.0	72.5	29.1	3.0	38.1	0.0	66.5	2104.4	5000.0	-7.5	peak
2483.500	H	235.0	1.0	57.0	29.1	3.0	38.1	0.0	51.0	353.3	500.0	-3.0	avg
2483.500	H	235.0	1.0	69.3	29.1	3.0	38.1	0.0	63.3	1455.9	5000.0	-10.7	peak
<b>Data below 2.4GHz: Ch1 (Same Ch 6 and Ch 11)</b>													
1197.730	V	92.0	1.0	44.6	25.5	2.3	39.0	0.8	34.1	50.9	500.0	-19.9	avg
1329.700	V	0.0	1.0	48.2	26.0	2.3	38.8	1.2	38.9	88.0	500.0	-15.1	avg
1462.150	V	0.0	1.0	45.5	26.5	2.3	38.7	1.7	37.2	72.8	500.0	-16.7	avg
1594.700	V	0.0	1.0	44.0	26.9	2.4	38.6	2.2	36.9	69.6	500.0	-17.1	avg
1197.730	V	92.0	1.0	58.6	25.5	2.3	39.0	0.8	48.1	254.9	5000.0	-25.9	peak
1329.700	V	0.0	1.0	63.8	26.0	2.3	38.8	1.2	54.5	530.1	5000.0	-19.5	peak



Frequency (MHz)	Polarity H/V	Az Deg	Ant. Height (m)	SA Level (dBµV)	Ant. Corr. (dB/m)	Cable Corr. (dB)	Amp Gain (dB)	Filter Corr (dB)	Corr. Level (dBµV/m)	Corr. Level (µV/m)	Limit (µV/m)	Margin (dB)	Notes
1462.150	V	0.0	1.0	59.5	26.5	2.3	38.7	1.7	51.2	364.9	5000.0	-22.7	peak
1594.700	V	0.0	1.0	59.0	26.9	2.4	38.6	2.2	51.9	391.6	5000.0	-22.1	peak
1197.730	H	150.0	1.0	49.4	25.5	2.3	39.0	0.8	38.9	88.4	500.0	-15.1	avg
1329.700	H	55.0	1.0	47.8	26.0	2.3	38.8	1.2	38.5	84.0	500.0	-15.5	avg
1462.150	H	70.0	1.0	45.0	26.5	2.3	38.7	1.7	36.7	68.7	500.0	-17.2	avg
1594.700	H	212.0	1.0	43.3	26.9	2.4	38.6	2.2	36.2	64.2	500.0	-17.8	avg
1197.730	H	150.0	1.0	60.8	25.5	2.3	39.0	0.8	50.3	328.4	5000.0	-23.7	peak
1329.700	H	55.0	1.0	60.9	26.0	2.3	38.8	1.2	51.6	379.6	5000.0	-22.4	peak
1462.150	H	70.0	1.0	58.0	26.5	2.3	38.7	1.7	49.7	307.0	5000.0	-24.2	peak
1594.700	H	212.0	1.0	56.3	26.9	2.4	38.6	2.2	49.2	287.0	5000.0	-24.8	peak

Ch. 11	2462												
4924.000	V	0.0	1.0	35.5	32.7	4.1	37.2	0.0	35.1	56.7	500.0	-18.9	avg
7386.000	V	0.0	1.0	35.4	37.1	5.1	37.6	0.0	40.0	99.9	500.0	-14.0	avg (amb)
12309.750	V	0.0	1.0	35.8	40.0	6.7	37.3	0.0	45.2	182.4	500.0	-8.8	avg (amb)
4924.000	V	0.0	1.0	47.5	32.7	4.1	37.2	0.0	47.1	225.5	5000.0	-26.9	peak peak
7386.000	V	0.0	1.0	47.5	37.1	5.1	37.6	0.0	52.1	402.3	5000.0	-21.9	(amb) peak
12309.750	V	0.0	1.0	48.4	40.0	6.7	37.3	0.0	57.8	778.3	5000.0	-16.2	(amb)
4924.000	H	0.0	1.0	36.2	32.7	4.1	37.2	0.0	35.8	61.4	500.0	-18.2	avg
7386.000	H	0.0	1.0	35.4	37.1	5.1	37.6	0.0	40.0	99.9	500.0	-14.0	avg (amb)
12309.750	H	0.0	1.0	35.6	40.0	6.7	37.3	0.0	45.0	178.3	500.0	-9.0	avg (amb)
4924.000	H	0.0	1.0	47.4	32.7	4.1	37.2	0.0	47.0	222.9	5000.0	-27.0	peak peak
7386.000	H	0.0	1.0	47.4	37.1	5.1	37.6	0.0	52.0	397.7	5000.0	-22.0	(amb) peak
12309.750	H	0.0	1.0	46.6	40.0	6.7	37.3	0.0	56.0	632.6	5000.0	-18.0	(amb)

Ch1	2412												
2483.500	V												amb
2483.500	V												amb
4824.000	V	10.0	1.0	38.8	32.5	4.1	37.2	0.0	38.2	81.1	500.0	-15.8	avg
12060.000	V	0.0	1.0	36.0	40.0	6.6	37.8	0.0	44.8	174.1	500.0	-9.2	avg (amb)
14472.000	V	0.0	1.0	36.1	41.3	7.5	36.9	0.0	48.0	251.4	500.0	-6.0	avg (amb)
4824.000	V	10.0	1.0	49.6	32.5	4.1	37.2	0.0	49.0	281.3	5000.0	-25.0	peak peak
12060.000	V	0.0	1.0	48.4	40.0	6.6	37.8	0.0	57.2	725.9	5000.0	-16.8	(amb) peak
14472.000	V	0.0	1.0	46.8	41.3	7.5	36.9	0.0	58.7	861.7	5000.0	-15.3	(amb)
2483.500	H												amb

Frequency (MHz)	Polarity H/V	Az Deg	Ant. Height (m)	SA Level (dBµV)	Ant. Corr. (dB/m)	Cable Corr. (dB)	Amp Gain (dB)	Filter Corr (dB)	Corr. Level (dBµV/m)	Corr. Level (µV/m)	Limit (µV/m)	Margin (dB)	Notes
2483.500	H												amb
4824.000	H	21.0	1.0	36.7	32.5	4.1	37.2	0.0	36.1	63.7	500.0	-17.9	avg
12060.000	H	0.0	1.0	36.3	40.0	6.6	37.8	0.0	45.1	180.2	500.0	-8.9	avg (amb)
14472.000	H	0.0	1.0	36.2	41.3	7.5	36.9	0.0	48.1	254.3	500.0	-5.9	avg (amb)
4824.000	H	21.0	1.0	46.8	32.5	4.1	37.2	0.0	46.2	203.8	5000.0	-27.8	peak
12060.000	H	0.0	1.0	46.8	40.0	6.6	37.8	0.0	55.6	603.8	5000.0	-18.4	peak (amb)
14472.000	H	0.0	1.0	47.0	41.3	7.5	36.9	0.0	58.9	881.7	5000.0	-15.1	peak (amb)

Ch6	2442												
2483.500	V	0.0	1.0	67.0	29.1	3.0	38.1	0.0	61.0	1117.2	5000.0	-13.0	peak (amb)
2483.500	V	0.0	1.0	54.9	29.1	3.0	38.1	0.0	48.9	277.4	500.0	-5.1	avg (amb)
4884.000	V	125.0	1.0	36.1	32.5	4.1	37.2	0.0	35.5	59.3	500.0	-18.5	avg
7326.000	V	0.0	1.0	35.0	37.1	5.0	37.6	0.0	39.6	95.1	500.0	-14.4	avg (amb)
12210.000	V	0.0	1.0	35.7	40.0	6.6	37.5	0.0	44.9	175.4	500.0	-9.1	avg (amb)
4884.000	V	125.0	1.0	46.9	32.5	4.1	37.2	0.0	46.3	205.6	5000.0	-27.7	peak
7326.000	V	0.0	1.0	47.7	37.1	5.0	37.6	0.0	52.3	410.5	5000.0	-21.7	peak (amb)
12210.000	V	0.0	1.0	47.9	40.0	6.6	37.5	0.0	57.1	714.7	5000.0	-16.9	peak (amb)
2483.500	H												amb
2483.500	H												amb
4884.000	H	0.0	1.0	33.6	32.6	4.1	37.2	0.0	33.1	45.1	500.0	-20.9	avg (amb)
7326.000	H	0.0	1.0	35.2	37.1	5.0	37.6	0.0	39.8	97.4	500.0	-14.2	avg (amb)
12210.000	H	0.0	1.0	35.5	40.0	6.6	37.5	0.0	44.7	171.4	500.0	-9.3	avg (amb)
4884.000	H	0.0	1.0	46.7	32.6	4.1	37.2	0.0	46.2	204.0	5000.0	-27.8	peak (amb)
7326.400	H	0.0	1.0	46.4	37.1	5.0	37.6	0.0	51.0	353.5	5000.0	-23.0	peak (amb)
12210.000	H	0.0	1.0	46.5	40.0	6.6	37.5	0.0	55.7	608.3	5000.0	-18.3	peak (amb)

**Table 7: Radiated Emission Test Data: Antenna A2.45FP18**

Frequency (MHz)	Polarity H/V	Az Deg	Ant. Height (m)	SA Level (dBµV)	Ant. Corr. (dB/m)	Cable Corr. (dB)	Amp Gain (dB)	Filter Corr (dB)	Corr. Level (dBµV/m)	Corr. Level (µV/m)	Limit (µV/m)	Margin (dB)	Notes
<b>A2.45FP18 Bandedge Ch. 1</b>													
2390.000	V	90.0	1.0	50.2	28.9	2.9	38.1	0.0	43.9	155.8	500.0	-10.1	avg
2390.000	V	250.0	1.0	68.3	28.9	2.9	38.1	0.0	62.0	1260.6	5000.0	-12.0	peak
2390.000	H	270.0	1.0	47.3	28.9	2.9	38.1	0.0	41.0	112.4	500.0	-13.0	avg
2390.000	H	270.0	1.0	64.0	28.9	2.9	38.1	0.0	57.7	765.7	5000.0	-16.3	peak
<b>Ch. 11</b>													
2483.500	V	260.0	1.0	54.3	29.1	3.0	38.1	0.0	48.3	258.9	500.0	-5.7	avg
2483.500	V	260.0	1.0	72.2	29.1	3.0	38.1	0.0	66.2	2032.9	5000.0	-7.8	peak
2483.500	H	270.0	1.0	54.8	29.1	3.0	38.1	0.0	48.8	274.2	500.0	-5.2	avg
2483.500	H	270.0	1.0	66.2	29.1	3.0	38.1	0.0	60.2	1018.9	5000.0	-13.8	peak
<b>Data below 2.4GHz: Ch1 (Same Ch 6 and Ch 11)</b>													
1197.730	V	92.0	1.0	43.8	25.5	2.3	39.0	0.8	33.3	46.4	500.0	-20.7	avg
1329.700	V	0.0	1.0	49.0	26.0	2.3	38.8	1.2	39.7	96.5	500.0	-14.3	avg
1462.150	V	0.0	1.0	46.2	26.5	2.3	38.7	1.7	37.9	78.9	500.0	-16.0	avg
1594.700	V	0.0	1.0	43.7	26.9	2.4	38.6	2.2	36.6	67.3	500.0	-17.4	avg
1197.730	V	92.0	1.0	58.4	25.5	2.3	39.0	0.8	47.9	249.1	5000.0	-26.1	peak
1329.700	V	0.0	1.0	62.8	26.0	2.3	38.8	1.2	53.5	472.4	5000.0	-20.5	peak
1462.150	V	0.0	1.0	59.3	26.5	2.3	38.7	1.7	51.0	356.6	5000.0	-22.9	peak
1594.700	V	0.0	1.0	58.0	26.9	2.4	38.6	2.2	50.9	349.0	5000.0	-23.1	peak
1197.730	H	150.0	1.0	48.7	25.5	2.3	39.0	0.8	38.2	81.5	500.0	-15.8	avg
1329.700	H	55.0	1.0	48.0	26.0	2.3	38.8	1.2	38.7	86.0	500.0	-15.3	avg
1462.150	H	70.0	1.0	44.5	26.5	2.3	38.7	1.7	36.2	64.9	500.0	-17.7	avg
1594.700	H	212.0	1.0	44.2	26.9	2.4	38.6	2.2	37.1	71.3	500.0	-16.9	avg
1197.730	H	150.0	1.0	59.8	25.5	2.3	39.0	0.8	49.3	292.7	5000.0	-24.7	peak
1329.700	H	55.0	1.0	60.1	26.0	2.3	38.8	1.2	50.8	346.2	5000.0	-23.2	peak
1462.150	H	70.0	1.0	57.8	26.5	2.3	38.7	1.7	49.5	300.0	5000.0	-24.4	peak
1594.700	H	212.0	1.0	57.5	26.9	2.4	38.6	2.2	50.4	329.5	5000.0	-23.6	peak

<b>Ch. 11</b>	<b>2462</b>												
4924.000	V	0.0	1.0	34.6	32.7	4.1	37.2	0.0	34.2	51.1	500.0	-19.8	avg
7386.000	V	0.0	1.0	35.4	37.1	5.1	37.6	0.0	40.0	99.9	500.0	-14.0	avg (amb)
12309.750	V	0.0	1.0	35.8	40.0	6.7	37.3	0.0	45.2	182.4	500.0	-8.8	avg (amb)
4924.000	V	0.0	1.0	46.8	32.7	4.1	37.2	0.0	46.4	208.1	5000.0	-27.6	peak
7386.000	V	0.0	1.0	47.5	37.1	5.1	37.6	0.0	52.1	402.3	5000.0	-21.9	peak (amb)
12309.750	V	0.0	1.0	48.4	40.0	6.7	37.3	0.0	57.8	778.3	5000.0	-16.2	peak (amb)
4924.000	H	0.0	1.0	37.2	32.7	4.1	37.2	0.0	36.8	68.9	500.0	-17.2	avg

7386.000	H	0.0	1.0	35.4	37.1	5.1	37.6	0.0	40.0	99.9	500.0	-14.0	avg (amb)
12309.750	H	0.0	1.0	35.6	40.0	6.7	37.3	0.0	45.0	178.3	500.0	-9.0	avg (amb)
4924.000	H	0.0	1.0	48.4	32.7	4.1	37.2	0.0	48.0	250.2	5000.0	-26.0	peak (amb)
7386.000	H	0.0	1.0	47.4	37.1	5.1	37.6	0.0	52.0	397.7	5000.0	-22.0	peak (amb)
12309.750	H	0.0	1.0	46.6	40.0	6.7	37.3	0.0	56.0	632.6	5000.0	-18.0	peak (amb)

<b>Ch1</b>	<b>2412</b>												
2483.500	V												amb
2483.500	V												amb
4824.000	V	22.0	1.0	38.6	32.5	4.1	37.2	0.0	38.0	79.3	500.0	-16.0	avg (amb)
12060.000	V	0.0	1.0	36.0	40.0	6.6	37.8	0.0	44.8	174.1	500.0	-9.2	avg (amb)
14472.000	V	0.0	1.0	36.1	41.3	7.5	36.9	0.0	48.0	251.4	500.0	-6.0	avg (amb)
4824.000	V	22.0	1.0	50.4	32.5	4.1	37.2	0.0	49.8	308.4	5000.0	-24.2	peak (amb)
12060.000	V	0.0	1.0	48.4	40.0	6.6	37.8	0.0	57.2	725.9	5000.0	-16.8	peak (amb)
14472.000	V	0.0	1.0	46.8	41.3	7.5	36.9	0.0	58.7	861.7	5000.0	-15.3	peak (amb)
2483.500	H												amb
2483.500	H												amb
4824.000	H	22.0	1.0	37.4	32.5	4.1	37.2	0.0	36.8	69.0	500.0	-17.2	avg (amb)
12060.000	H	0.0	1.0	36.3	40.0	6.6	37.8	0.0	45.1	180.2	500.0	-8.9	avg (amb)
14472.000	H	0.0	1.0	36.2	41.3	7.5	36.9	0.0	48.1	254.3	500.0	-5.9	avg (amb)
4824.000	H	22.0	1.0	48.5	32.5	4.1	37.2	0.0	47.9	247.8	5000.0	-26.1	peak (amb)
12060.000	H	0.0	1.0	46.8	40.0	6.6	37.8	0.0	55.6	603.8	5000.0	-18.4	peak (amb)
14472.000	H	0.0	1.0	47.0	41.3	7.5	36.9	0.0	58.9	881.7	5000.0	-15.1	peak (amb)

<b>Ch6</b>	<b>2442</b>												
2483.500	V												amb
2483.500	V												amb
4884.000	V	125.0	1.0	37.4	32.5	4.1	37.2	0.0	36.8	68.9	500.0	-17.2	avg (amb)
7326.000	V	0.0	1.0	35.0	37.1	5.0	37.6	0.0	39.6	95.1	500.0	-14.4	avg (amb)
12210.000	V	0.0	1.0	35.7	40.0	6.6	37.5	0.0	44.9	175.4	500.0	-9.1	avg (amb)
4884.000	V	125.0	1.0	47.9	32.5	4.1	37.2	0.0	47.3	230.7	5000.0	-26.7	peak (amb)
7326.000	V	0.0	1.0	47.7	37.1	5.0	37.6	0.0	52.3	410.5	5000.0	-21.7	peak (amb)
12210.000	V	0.0	1.0	47.9	40.0	6.6	37.5	0.0	57.1	714.7	5000.0	-16.9	peak (amb)
2483.500	H												amb
2483.500	H												amb

4884.000	H	0.0	1.0	35.7	32.6	4.1	37.2	0.0	35.2	57.5	500.0	-18.8	avg
7326.000	H	0.0	1.0	35.2	37.1	5.0	37.6	0.0	39.8	97.4	500.0	-14.2	avg (amb)
12210.000	H	0.0	1.0	35.5	40.0	6.6	37.5	0.0	44.7	171.4	500.0	-9.3	avg (amb)
4884.000	H	0.0	1.0	47.6	32.6	4.1	37.2	0.0	47.1	226.3	5000.0	-26.9	peak
7326.400	H	0.0	1.0	46.4	37.1	5.0	37.6	0.0	51.0	353.5	5000.0	-23.0	peak (amb)
12210.000	H	0.0	1.0	46.5	40.0	6.6	37.5	0.0	55.7	608.3	5000.0	-18.3	peak (amb)

#### 4.6 AC Powerline Conducted Emissions: (FCC Part §15.207)

The EUT was placed on an 80 cm high 1 x 1.5 m non-conductive table above a ground plane. Power to the EUT was provided through a Solar Corporation 50 Ω/50 μH Line Impedance Stabilization Network bonded to a 3 x 2 meter ground plane. The LISN has its AC input supplied from a filtered AC power source. Power and data cables were moved about to obtain maximum emissions.

The 50Ω output of the LISN was connected to the input of the spectrum analyzer and the emissions in the frequency range of 150 kHz to 30 MHz were measured. The detector function was set to quasi-peak, peak, or average as appropriate, and the resolution bandwidth during testing was at least 9 kHz, with all post-detector filtering no less than 10 times the resolution bandwidth for peak measurements.

Data is recorded in the following table.

**Table 8. Conducted Emissions Test Data; §15.207**

**LINE 1 - NEUTRAL**

Frequency (MHz)	Level QP (dBμV)	Cable Loss (dB)	LISN Corr (dB)	Limit QP (dBμV)	Level Corr (dBμV)	Margin QP (dB)	Level AVG (dBμV)	Cable Loss (dB)	Level Corr (dBμV)	Limit AVG (dBμV)	Margin AVG (dB)
3.543	29.6	10.5	0.7	56.0	40.8	-15.2	28.8	10.5	40.0	46.0	-6.0
3.694	26.6	10.5	0.7	56.0	37.8	-18.2	16.0	10.5	27.2	46.0	-18.8
11.955	25.9	11.8	1.6	60.0	39.3	-20.7	18.2	11.8	31.6	50.0	-18.4
18.304	29.9	12.3	2.8	60.0	45.0	-15.0	25.5	12.3	40.6	50.0	-9.4
20.381	30.3	12.4	3.2	60.0	45.9	-14.1	22.1	12.4	37.7	50.0	-12.3
26.610	31.8	12.7	4.6	60.0	49.1	-10.9	29.2	12.7	46.5	50.0	-3.5
26.854	31.7	12.7	4.7	60.0	49.1	-10.9	21.3	12.7	38.7	50.0	-11.3

**LINE 2 - PHASE**

Frequency (MHz)	Level QP (dBμV)	Cable Loss (dB)	LISN Corr (dB)	Limit QP (dBμV)	Level Corr (dBμV)	Margin QP (dB)	Level AVG (dBμV)	Cable Loss (dB)	Level Corr (dBμV)	Limit AVG (dBμV)	Margin AVG (dB)
1.818	22.5	10.5	0.5	56.0	33.5	-22.5	17.4	10.5	28.4	46.0	-17.6
3.523	28.4	10.5	0.9	56.0	39.8	-16.2	27.7	10.5	39.1	46.0	-6.9
10.794	26.2	11.7	1.8	60.0	39.7	-20.3	21.0	11.7	34.5	50.0	-15.5
17.694	30.7	12.2	3.6	60.0	46.6	-13.4	27.2	12.2	43.1	50.0	-6.9
18.244	31.2	12.3	3.8	60.0	47.2	-12.8	28.0	12.3	44.0	50.0	-6.0
20.259	31.0	12.4	4.2	60.0	47.5	-12.5	26.2	12.4	42.7	50.0	-7.3
26.660	32.1	12.7	5.7	60.0	50.4	-9.6	28.5	12.7	46.8	50.0	-3.2
26.854	31.8	12.7	5.7	60.0	50.2	-9.8	21.7	12.7	40.1	50.0	-9.9

#### 4.7 Co-Location Measurements

This device may operate concurrently with other radio transmitters. To determine if the mixing of signals from one radio to another produces harmonics above specification limits, the device was set up to operate with the following radios:

**Table 9. Co-Location Radio Measurement**

<b>Radio</b>	<b>Frequency/Rule Part</b>	<b>Note</b>	<b>First Order Products (nominal frequencies)</b>
2.4 GHz	Part 15.247	Unlicensed equipment to be certified	-
5.8 GHz	Part 15.247	Unlicensed co-located equipment	3.4, 8.2 GHz
4.9 GHz	Part 90	Unlicensed co-located equipment	2.5, 7.3 GHz

The equipment was configured for a single channel in each band. The device was set up in an anechoic chamber and all transmitters were set to operate normally. A scan of the spectrum was performed to identify any intermodulation products that may have been produced by mixing action occurring between the different transmitters. Particular attention was paid to the Restricted Bands of operation and measurements were collected as the equipment turntable was rotated through 360 degrees. Measurements were collected up to 18GHz as it would be expected that any harmonic product would lie at or below the first product.

No products were found that exceed the radiated emissions limits of Part 15.209.