

Prüfbericht-Nr.: <i>Test Report No.:</i>	10047890 001	Auftrags-Nr.: <i>Order No.:</i>	114023945	Seite 1 von 32 <i>Page 1 of 32</i>
Kunden-Referenz-Nr.: <i>Client Reference No.:</i>	N/A	Auftragsdatum: <i>Order date:</i>	June 26, 2014	
Auftraggeber: <i>Client:</i>	Denso Corporation, 1-1, Showa-cho, Kariya-shi, Aichi-ken, 448 Japan			
Prüfgegenstand: <i>Test item:</i>	Bluetooth Tag			
Bezeichnung / Typ-Nr.: <i>Identification / Type No.:</i>	KFDNX-BB			
Auftrags-Inhalt: <i>Order content:</i>	FCC Part 15C Test report			
Prüfgrundlage: <i>Test specification:</i>	FCC 47CFR Part 15: Subpart C Section 15.247			
Wareneingangsdatum: <i>Date of receipt:</i>	08/07/2014			
Prüfmuster-Nr.: <i>Test sample No.:</i>	A000100949-001 A000100949-002			
Prüfzeitraum: <i>Testing period:</i>	19-Aug-2014 - 20-Aug-2014			
Ort der Prüfung: <i>Place of testing:</i>	EMC Laboratory Taipei			
Prüflaboratorium: <i>Testing laboratory:</i>	TUV Rheinland Taiwan Ltd.			
Prüfergebnis*: <i>Test result*:</i>	Pass			
geprüft von / tested by:		kontrolliert von / reviewed by:		
2014-09-02 Ryan Chen/Project Engineer		2014-09-02 Rene Charton/Senior Project Manager		
<i>Datum</i> <i>Date</i>	<i>Name / Stellung</i> <i>Name / Position</i>	<i>Unterschrift</i> <i>Signature</i>	<i>Datum</i> <i>Date</i>	<i>Name / Stellung</i> <i>Name / Position</i>
Sonstiges / Other:				
Zustand des Prüfgegenstandes bei Anlieferung: <i>Condition of the test item at delivery:</i>		Prüfmuster vollständig und unbeschädigt <i>Test item complete and undamaged</i>		
* Legende: 1 = sehr gut 2 = gut 3 = befriedigend 4 = ausreichend 5 = mangelhaft P(ass) = entspricht o.g. Prüfgrundlage(n) F(ail) = entspricht nicht o.g. Prüfgrundlage(n) N/A = nicht anwendbar N/T = nicht getestet				
Legend: 1 = very good 2 = good 3 = satisfactory 4 = sufficient 5 = poor P(ass) = passed a.m. test specification(s) F(ail) = failed a.m. test specification(s) N/A = not applicable N/T = not tested				
Dieser Prüfbericht bezieht sich nur auf das o.g. Prüfmuster und darf ohne Genehmigung der Prüfstelle nicht auszugsweise vervielfältigt werden. Dieser Bericht berechtigt nicht zur Verwendung eines Prüfzeichens. <i>This test report only relates to the a. m. test sample. Without permission of the test center this test report is not permitted to be duplicated in extracts. This test report does not entitle to carry any test mark.</i>				

v04

TEST SUMMARY

5.1.1 ANTENNA REQUIREMENT

RESULT: Passed

5.1.2 PEAK OUTPUT POWER

RESULT: Passed

5.1.3 6dB BANDWIDTH AND 99% BANDWIDTH

RESULT: Passed

5.1.4 POWER DENSITY

RESULT: Passed

5.1.5 CONDUCTED SPURIOUS EMISSIONS AND FREQUENCY BAND EDGE MEASURED IN 100kHz BANDWIDTH

RESULT: Passed

5.1.6 SPURIOUS EMISSION

RESULT: Passed

6.1.1 ELECTROMAGNETIC FIELDS

RESULT: Passed

Contents

1.	GENERAL REMARKS	4
1.1	COMPLEMENTARY MATERIALS.....	4
2.	TEST SITES	5
2.1	TEST FACILITIES	5
2.2	LIST OF TEST AND MEASUREMENT INSTRUMENTS.....	6
2.3	TRACEABILITY	7
2.4	CALIBRATION	7
2.5	MEASUREMENT UNCERTAINTY	7
3.	GENERAL PRODUCT INFORMATION.....	8
3.1	PRODUCT FUNCTION AND INTENDED USE	8
3.2	SYSTEM DETAILS AND RATINGS.....	8
3.3	INDEPENDENT OPERATION MODES.....	9
3.4	NOISE GENERATING AND NOISE SUPPRESSING PARTS	9
3.5	SUBMITTED DOCUMENTS.....	9
4.	TEST SET-UP AND OPERATION MODES.....	10
4.1	PRINCIPLE OF CONFIGURATION SELECTION	10
4.2	TEST OPERATION AND TEST SOFTWARE.....	10
4.3	SPECIAL ACCESSORIES AND AUXILIARY EQUIPMENT	10
4.4	COUNTERMEASURES TO ACHIEVE EMC COMPLIANCE.....	11
4.5	TEST SETUP DIAGRAM	11
5.	TEST RESULTS	13
5.1	TRANSMITTER REQUIREMENT & TEST SUITES	13
5.1.1	<i>Antenna Requirement</i>	<i>13</i>
5.1.2	<i>Peak Output Power.....</i>	<i>14</i>
5.1.3	<i>6dB Bandwidth and 99% Bandwidth.....</i>	<i>17</i>
5.1.4	<i>Power Density.....</i>	<i>20</i>
5.1.5	<i>Conducted spurious emissions and Frequency Band Edge measured in 100kHz Bandwidth.....</i>	<i>23</i>
5.1.6	<i>Spurious Emission</i>	<i>27</i>
6.	SAFETY HUMAN EXPOSURE	28
6.1	RADIO FREQUENCY EXPOSURE COMPLIANCE	28
6.1.1	<i>Electromagnetic Fields.....</i>	<i>28</i>
7.	PHOTOGRAPHS OF THE TEST SET-UP.....	29

8.	LIST OF TABLES	32
9.	LIST OF PHOTOGRAPHS.....	32

1. General Remarks

1.1 Complementary Materials

All attachments are integral parts of this test report. This applies especially to the following appendix:

- Appendix P: Photo Documentation**
(File Name: 10047890APPENDIX P)
- Appendix D: Test Result of Radiated Emissions**
(File Name: 10047890APPENDIX D)

Test Specifications

The following standards were applied

Table 1: Applied Standard and Test Levels

Radio
FCC CFR47 Part 15: Subpart C Section 15.247
ANSI C63.10:2009, KDB558074 D01 DTS Meas Guidance v02

2. Test Sites

2.1 Test Facilities

TUV Rheinland Taiwan Ltd.

11F. No.758, Sec. 4, Bade Rd., Songshan Dist.
Taipei City 105
Taiwan (R.O.C.)

FCC Registration No.: 365730
TAF Accredited NCC Test Lab. No.:0759
TAF ISO17025 Certification effective periods: 2013-Jul-1st to 2016-Jun-30th



Testing Laboratory
0759

2.2 List of Test and Measurement Instruments

Table 2: List of Test and Measurement Equipment

Kind of Equipment	Manufacturer	Type	S/N	Calibrated until
EMI Test Receiver	R&S	ESCI 7	101062	1-Sep-14
Bilog Antenna	TESEQ	CBL6111D	29802	4-Jul-15
Spectrum Analyzer	R&S	FSV 40	100921	10-Dec-14
Horn Antenna	ETS-Lindgren	3117	138160	10-Jan-15
Horn Antenna (18GHz~40GHz)	COM-POWER	AH840	101031	29-Oct-15
Preamplifier (30MHz - 1GHz)	HP	8447F	2805A03335	2-Sep-14
Preamplifier (18 GHz - 40 GHz)	COM-POWER	PAM-840	461257	2-Sep-14
Pre-Amplifier (1GHz~18GHz)	EM Electronics	EM30180	60558	23-Oct-14
Loop Antenna	Schwarzbeck	FMZB 1513	1513-076	28-Sep-14
EMI Test Receiver	R&S	ESCI	101094	29-Aug-14
LISN (1 phase)	R&S	ENV216	101243	30-May-15
LISN	Rolf Heine	NNB-2/16Z	99080	30-Aug-14

2.3 Traceability

All measurement equipment calibrations are traceable to NML(Taiwan)/NIST(USA) or where calibration is performed outside Taiwan, to equivalent nationally recognized standards organizations.

2.4 Calibration

Equipment requiring calibration is calibrated periodically in a suitably accredited Calibration Lab. Additionally all equipment is verified for proper performance on a regular basis using in house standards or comparisons.

2.5 Measurement Uncertainty

The estimated combined standard uncertainty for radiated emissions and conducted emissions measurements:.

Table 3: Emission Measurement Uncertainty

Parameter	Uncertainty
Radio Frequency	$\pm 1 \times 10^{-7}$
RF power, conducted	± 1.5 dB
RF power density, conducted	± 3 dB
spurious emissions, conducted	± 3 dB
all emissions, radiated	± 6 dB
Temperature	± 1 °C
Humidity	± 5 %
DC and low frequency voltages	± 3 %

3. General Product Information

3.1 Product Function and Intended Use

This Bluetooth Proximity Tag features convenient use, easy operation, small size, and easy to take, used with smart phone for phone finder and alert features. Implement the latest technology of Bluetooth 4.0 LE for power saving to make convenient for long battery life for used. For details refer to the User Guide, Data Sheet and Circuit Diagram.

3.2 System Details and Ratings

Table 4: Basic Information of EUT

Item	EUT information
Kind of Equipment	Bluetooth Tag
Type Designation	KFDNX-BB
FCC ID	HYQKFD01

Table 5: Technical Specification of EUT

Technical Specification	Value
Operating Frequency	2402~2480 MHz
Channel Spacing	2 MHz
Channel number	40
Operation Voltage	3V DC
Modulation	GFSK
Channel number	40

3.3 Independent Operation Modes

Basic operation modes are:

- A. Transmitting
 - 1. Low channel
 - 2. Middle channel
 - 3. High channel
- B. Receiving
- C. Standby
- D. Off

3.4 Noise Generating and Noise Suppressing Parts

Refer to the Circuit Diagram.

3.5 Submitted Documents

- Circuit Diagram
- Instruction Manual
- Rating Label
- Technical Description

4. Test Set-up and Operation Modes

4.1 Principle of Configuration Selection

The equipment under test (EUT) was configured to measure its maximum power level. The test modes were adapted accordingly in reference to the instructions for use.

4.2 Test Operation and Test Software

Setup for testing: Test samples are provided with a LPT SPI interface which makes it possible to control them through a test software installed on a notebook computer.

This software was running on the laptop computer connected to the EUT. It was used to enable the operation modes listed in section 3.3 as appropriate

The samples were used as follows:

Conducted: A000100949-002

Radiation: A000100949-001

Full test was applied on all test modes, but only worst case was shown.

4.3 Special Accessories and Auxiliary Equipment

The product has been tested together with the following additional accessories:

Kind of Equipment	Manufacturer	Model Name	S/N
Laptop	HP	HSTNN-Q78C-3	CNF0339QBM

4.4 Countermeasures to achieve EMC Compliance

test sample which has been tested containing the noise suppression parts as in the Photo Appendix and the Test Setup Photos. No additional measures were employed to achieve compliance.

4.5 Test Setup Diagram

Diagram of Measurement Configuration for Radiation Test

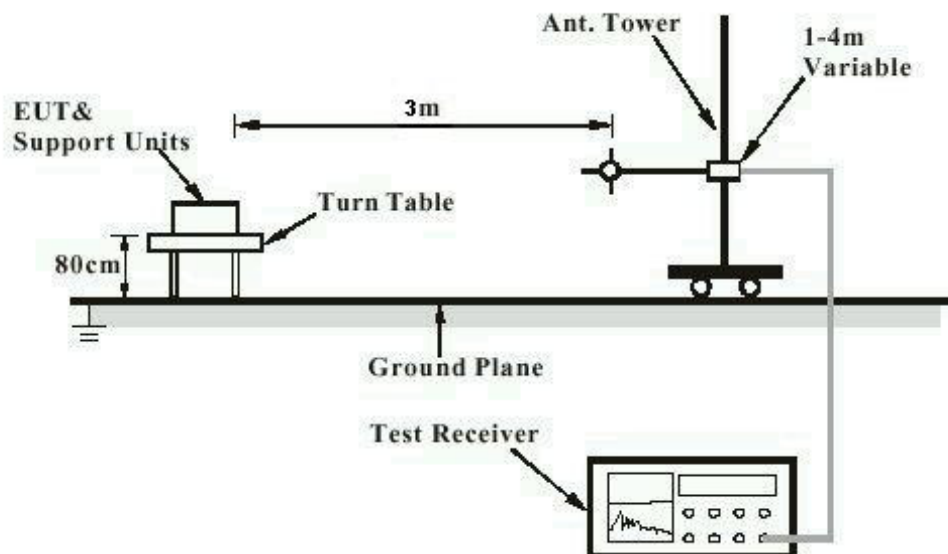

Diagram of Measurement Equipment Configuration for Mains Conduction Measurement (if applicable)

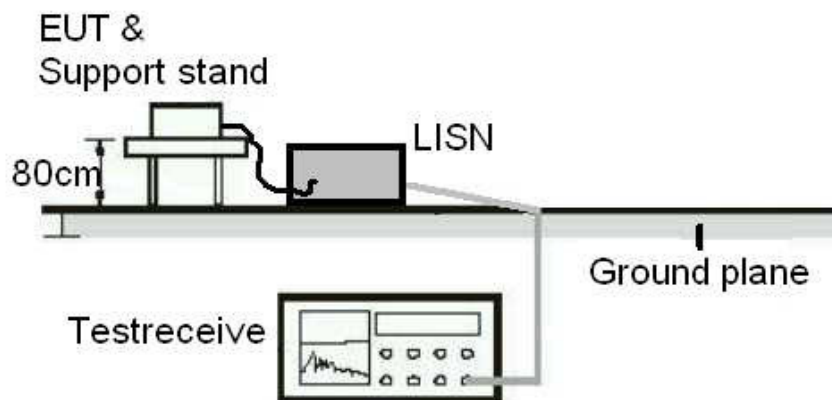
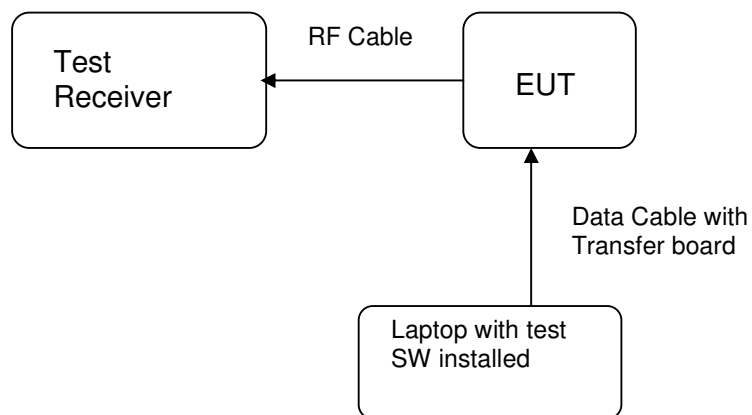

Diagram of Measurement Equipment Configuration for Conducted Transmitter Measurement



5. Test Results

5.1 Transmitter Requirement & Test Suites

5.1.1 Antenna Requirement

RESULT: **Passed**

Test standard	:	FCC Part 15.247(b)(4), Part 15.203 and RSS-Gen 7.1.4
Requirement	:	use of approved antennas only with directional gains that do not exceed 6 dBi

According to the manufacturer declaration, the EUT has an antenna with a directional gain of -0.5 dBi. The antenna is a printed PCB trace with no possibility of replacement with a non-approved antenna by the end-user. Therefore, the EUT is considered to comply with this provision.

Refer to EUT photo for details.

5.1.2 Peak Output Power

RESULT:
Passed

Test standard : FCC Part 15.247(b)(3), RSS-210 A8.4(4)
 Basic standard : ANSI C63.10:2009, KDB558074
 Limit : 1 Watt
 Kind of test site : Shielded room

Test setup

Test Channel : Low/ Middle/ High
 Operation Mode : A

 Ambient temperature : 22-26 °C
 Relative humidity : 50-65 %
 Atmospheric pressure : 100-103 kPa

Table 6: Test result of Peak Output Power, GFSK modulation

Channel	Channel Frequency (MHz)	Peak Output Power		Limit (W)
		(dBm)	(W)	
Low Channel	2402	6.69	0.0047	1
Mid Channel	2442	8.67	0.0074	1
High Channel	2480	10.52	0.0113	1

Test Plot of Peak Output Power, GFSK modulation

Low Channel

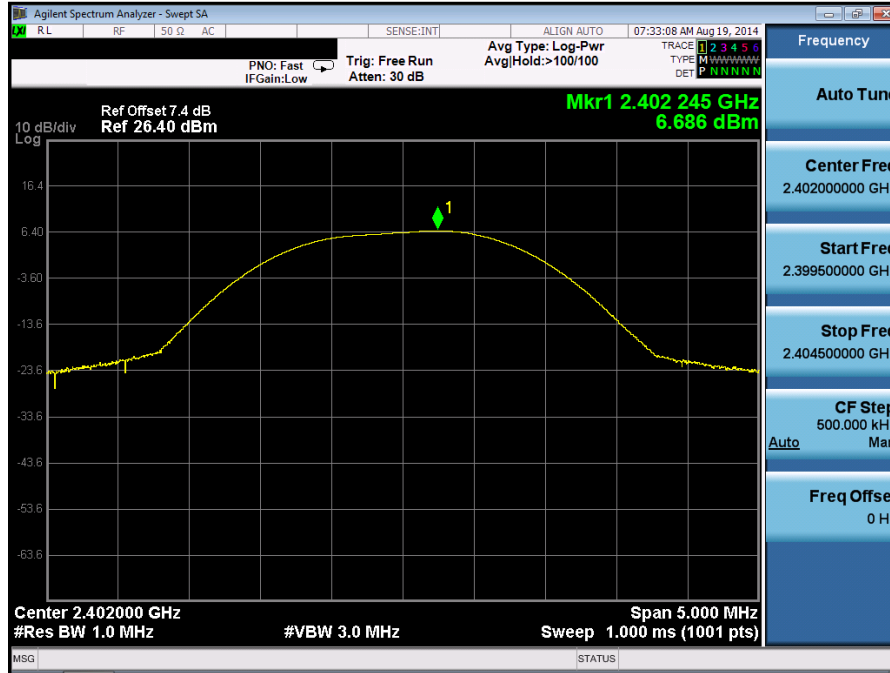

Middle Channel

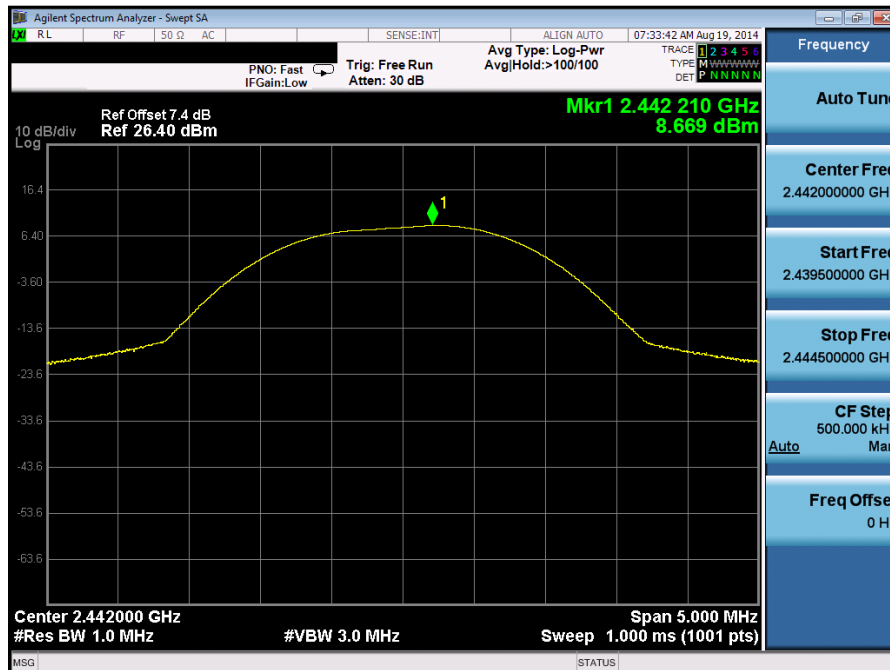

High Channel

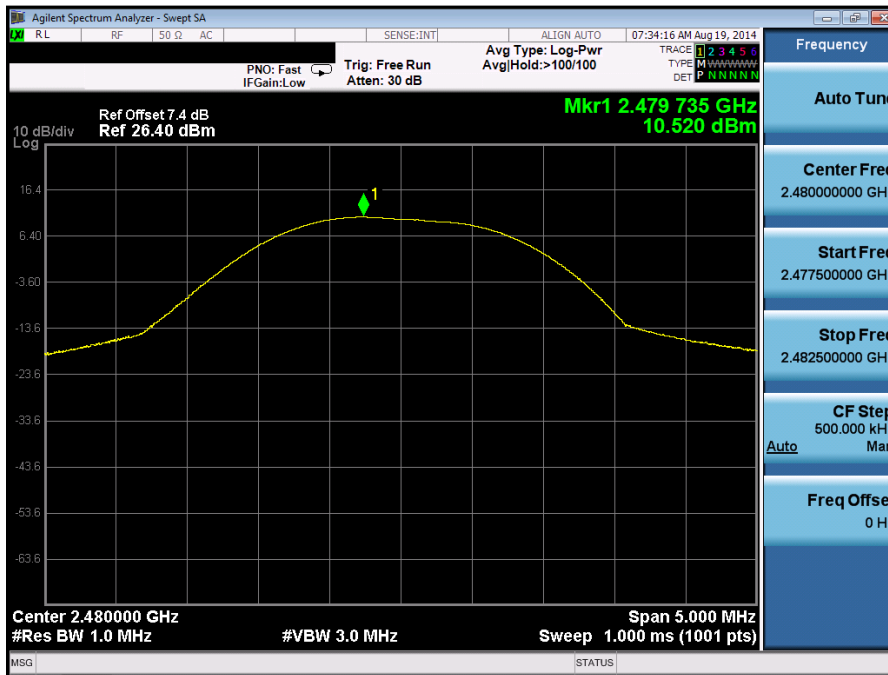

5.1.3 6dB Bandwidth and 99% Bandwidth

RESULT:
Passed

Test standard : FCC Part 15.247(a)(2), RSS-210 A8.2(1),
 RSS-Gen
 Basic standard : ANSI C63.10:2009, KDB558074
 Kind of test site : Shielded room

Test setup

Test Channel : Low/ Middle/ High
 Operation Mode : A

Ambient temperature : 22-26°C
 Relative humidity : 50-65%
 Atmospheric pressure : 100-103 kPa

Table 7: Test result of 6 dB Bandwidth, GFSK modulation

Channel	Channel Frequency (MHz)	6 dB Bandwidth (kHz)	Limit (kHz)	Result
Low Channel	2402	686.2	> 500	Pass
Mid Channel	2442	689.3	> 500	Pass
High Channel	2480	684.5	> 500	Pass

Table 8: Test result of 99% Bandwidth, GFSK modulation

Channel	Channel Frequency (MHz)	99% Bandwidth (MHz)
Low Channel	2402	1.0418
Mid Channel	2442	1.0416
High Channel	2480	1.0348

Test Plot of 6dB Bandwidth, GFSK modulation

Low Channel

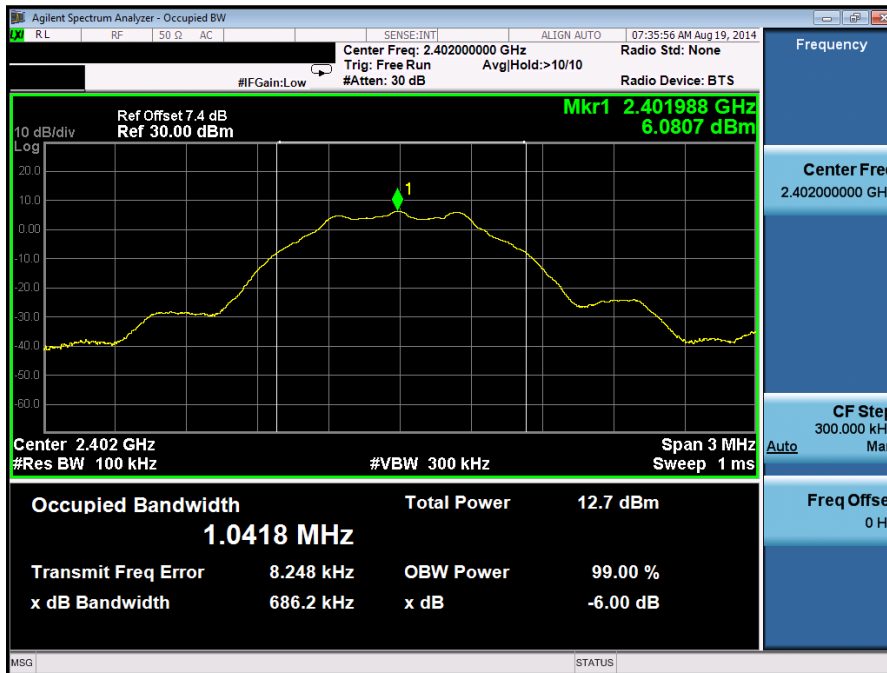

Middle Channel

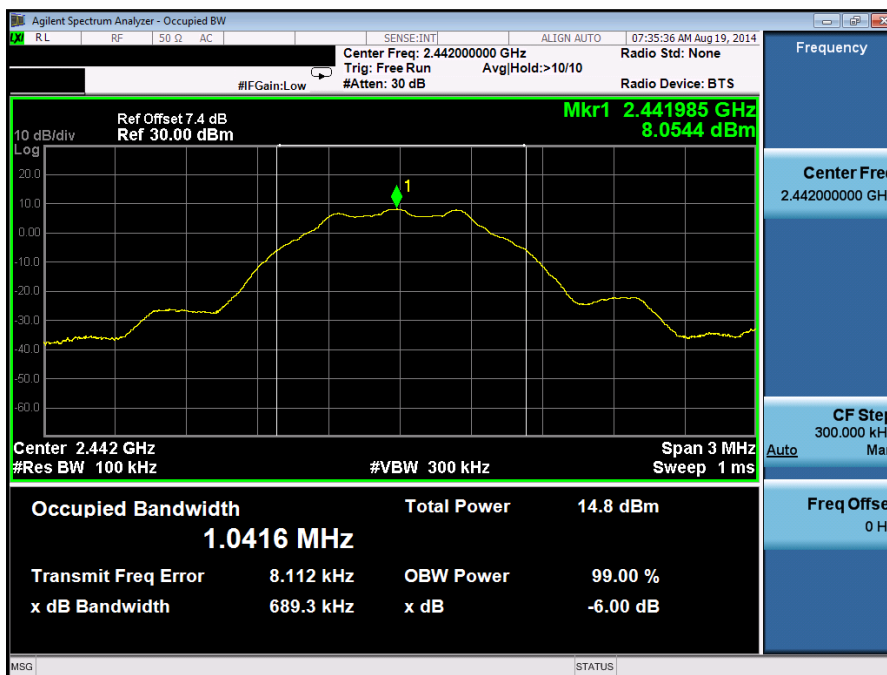

High Channel



5.1.4 Power Density

RESULT:**Passed**

Test standard : FCC Part 15.247(e) , RSS-210 A8.2(2)
Basic standard : ANSI C63.10:2009, KDB558074
Kind of test site : Shielded room

Test setup

Test Channel : Low/ Middle/ High
Operation Mode : A
Ambient temperature : 22-26°C
Relative humidity : 50-65%
Atmospheric pressure : 100-103 kPa

Table 9: Test result of Power Density, GFSK modulation

Channel	Channel Frequency (MHz)	Peak Power Density (dBm/3kHz)	Limit (dBm/3kHz)	Result
Low Channel	2402	-8.722	8	Pass
Mid Channel	2442	-5.2	8	Pass
High Channel	2480	-5.399	8	Pass

Test Plot of Power Density, GFSK modulation

Low Channel

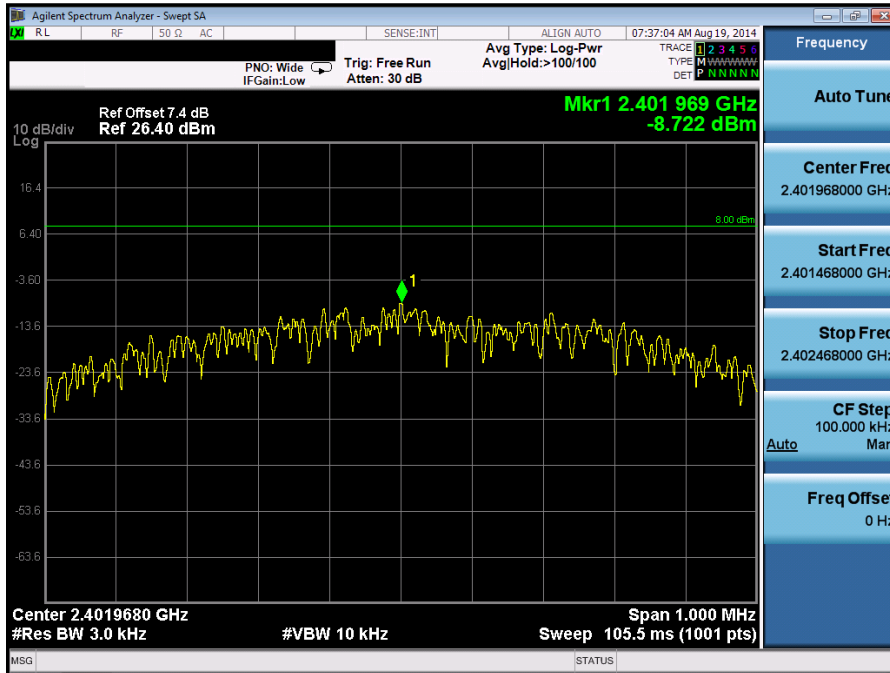

Middle Channel

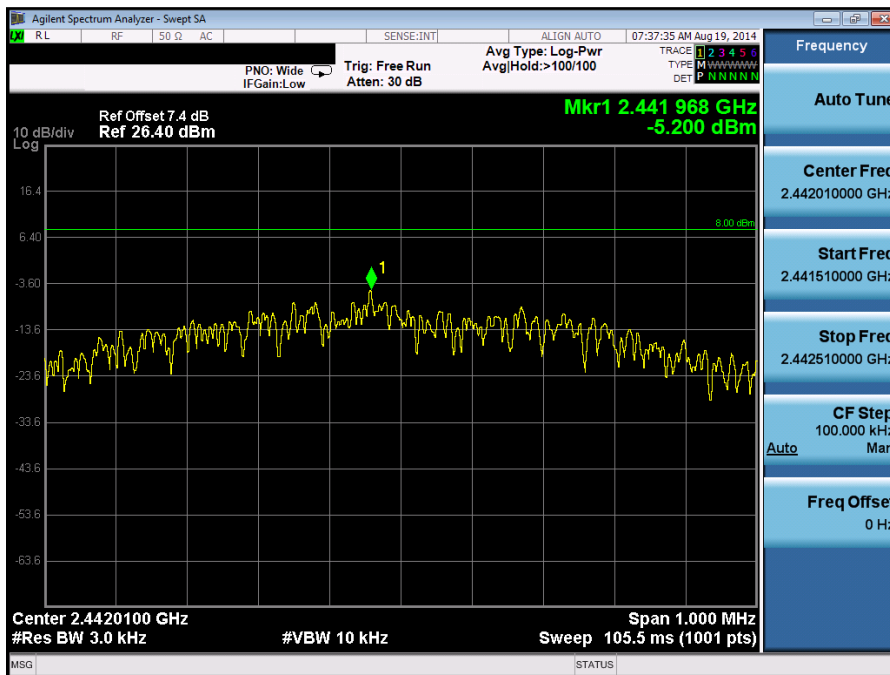

High Channel

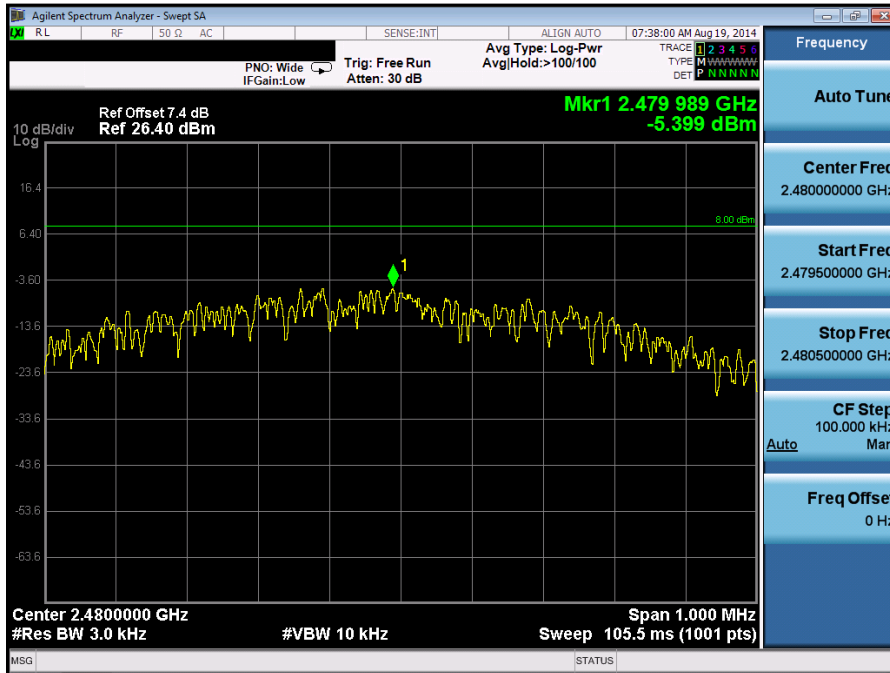

5.1.5 Conducted spurious emissions and Frequency Band Edge measured in 100kHz Bandwidth

RESULT: **Passed**

Test standard	:	FCC part 15.247(d), RSS-210 A8.5
Basic standard	:	ANSI C63.10:2009, KDB558074
Limit	:	20dB (below that in the 100kHz bandwidth within the band that contains the highest level of the desired power)
Kind of test site	:	Shielded room

Test setup

Test Channel	:	Low/ High
Operation mode	:	A
Ambient temperature	:	22-26°C
Relative humidity	:	50-65%
Atmospheric pressure	:	100-103 kPa

All emissions are more than 20dB below fundamental, details refer to following test plot, and compliance is achieved as well.

Due to the small size of the product and that there are no inductive components of significant size, 9kHz to 30MHz frequency range is not tested based on technical judgment.

Test Plot of 100kHz Conducted Emissions, GFSK modulation

Low Channel

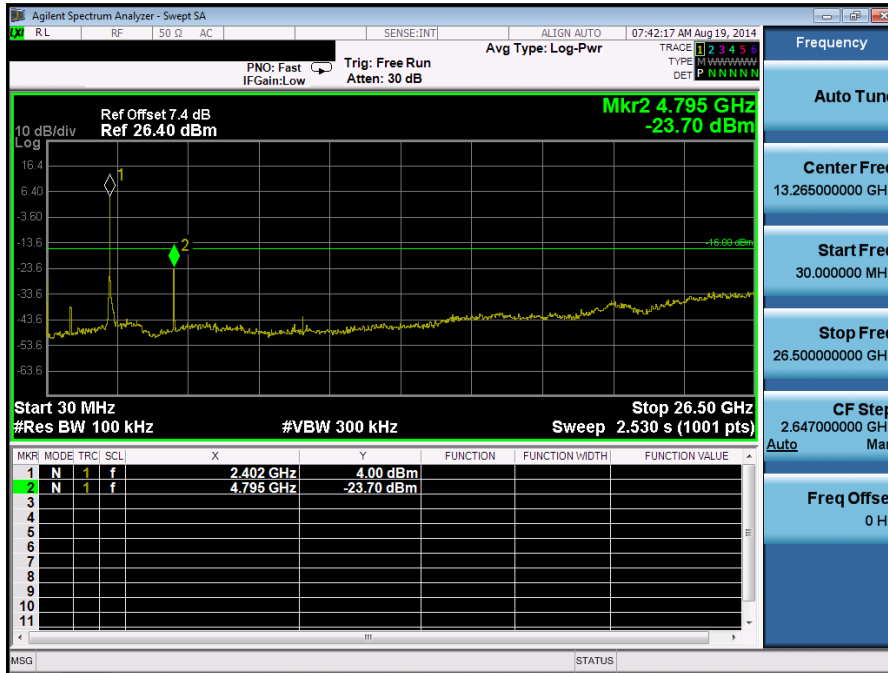

Middle Channel

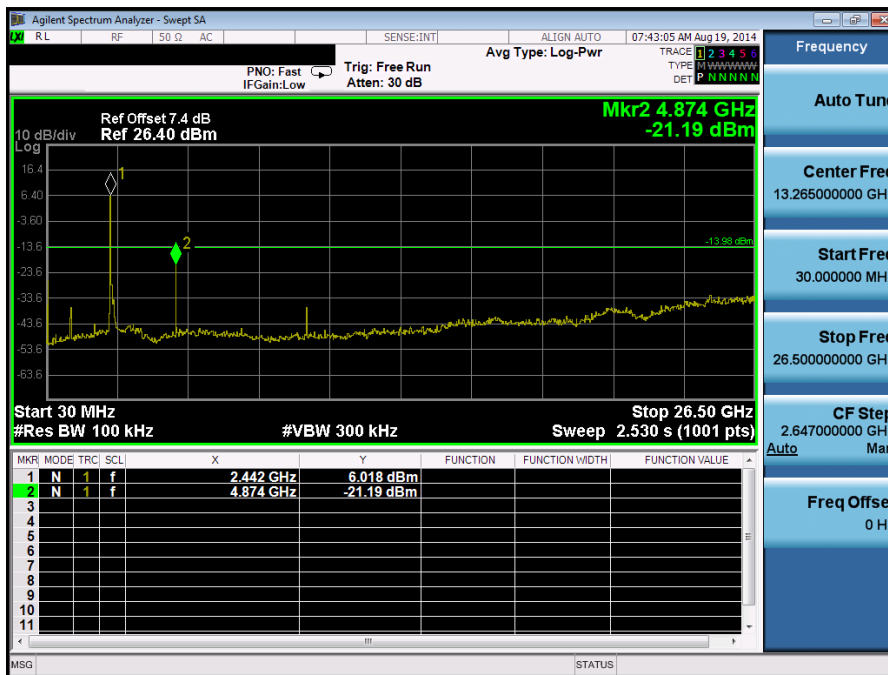

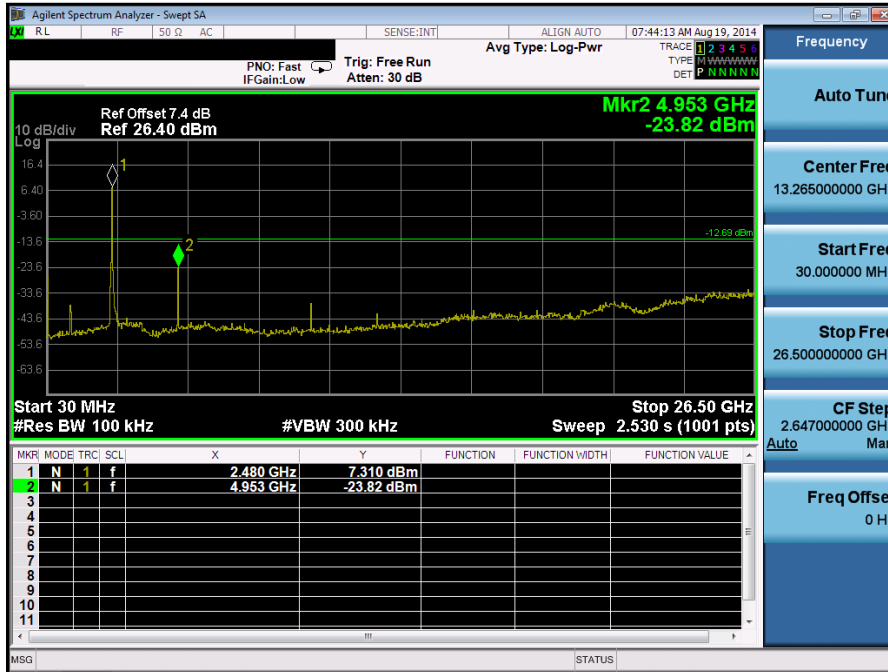
High Channel

Frequency

Auto Tune

Center Freq
13.265000000 GHz

Start Freq
30.000000 MHz

Stop Freq
26.500000000 GHz

CF Step
2.647000000 GHz
Auto Man

Freq Offset
0 Hz

Test Plot of 100kHz Bandwidth of Frequency Band Edge, GFSK modulation

Low Channel

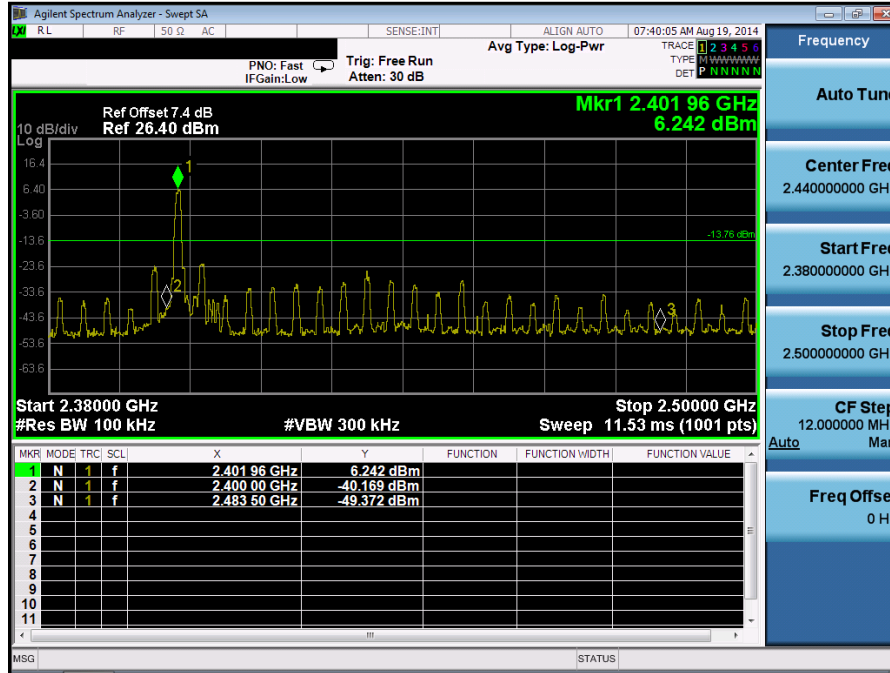

High Channel

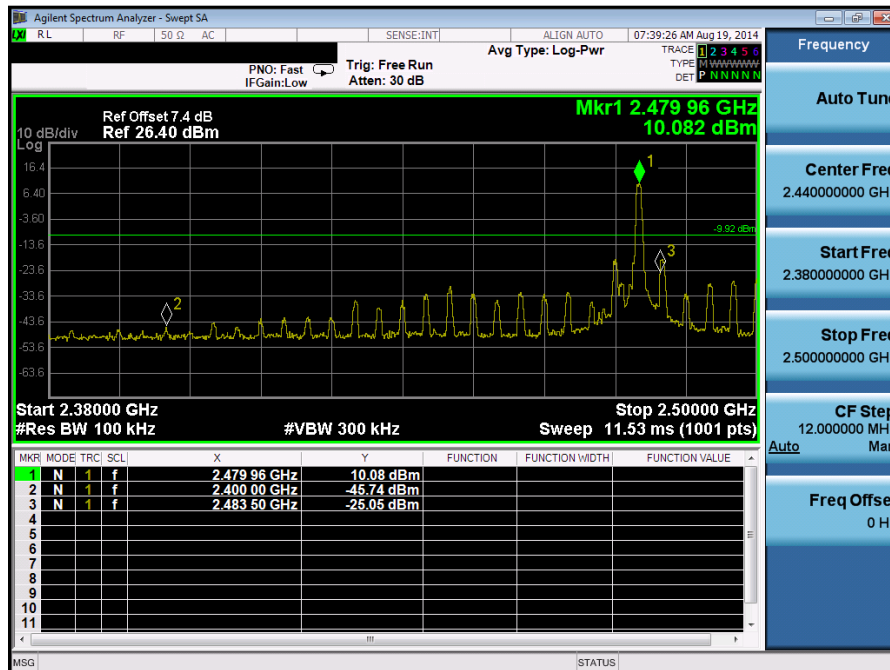

5.1.6 Spurious Emission

RESULT:**Passed**

Test standard	:	FCC part 15.247(d), FCC 15.205, FCC 15.209, RSS-210 2.2, RSS-210 A8.5 and RSS-Gen 7.2.1
Basic standard	:	ANSI C63.10: 2009
Limits	:	Radiated emissions which fall in the restricted bands, as defined in FCC 15.205(a), must comply with the radiated emission limits specified in FCC 15.209(a). Emission radiated outside the specified frequency bands must comply with the radiated emission limits specified in FCC 15.209(a) and FCC 15.249(a).
Kind of test site	:	3m Semi-Anechoic Chamber

Test setup

Test Channel	:	Low/ Middle/ High
Operation mode	:	A

Remark: Testing was carried out within frequency range 30MHz to the tenth harmonic.

For details refer to Appendix D.

The Radiated Emissions testing was performed in the X, Y and Z axis orientation. The X Axis orientation is the worst-case and recorded in this test report. Due to the small size of the product and that there are no inductive components of significant size, 9kHz to 30MHz frequency range is not tested based on technical judgment.

6. Safety Human exposure

6.1 Radio Frequency Exposure Compliance

6.1.1 Electromagnetic Fields

RESULT:
Passed

Test standard : FCC KDB Publication 447498 D01 v05

The maximum peak output power of the transmitter is 11.272 mW.
 Worst Case DutyCycle= 407us/621.6us=0.65
 Average power: 7.33 mW
 The separation between body and antenna is more than 5mm.

Hence the EUT is excluded from SAR evaluation.
 Please also refer to FCC KDB publication 447498 D01 v05: Mobile Portable RF Exposure

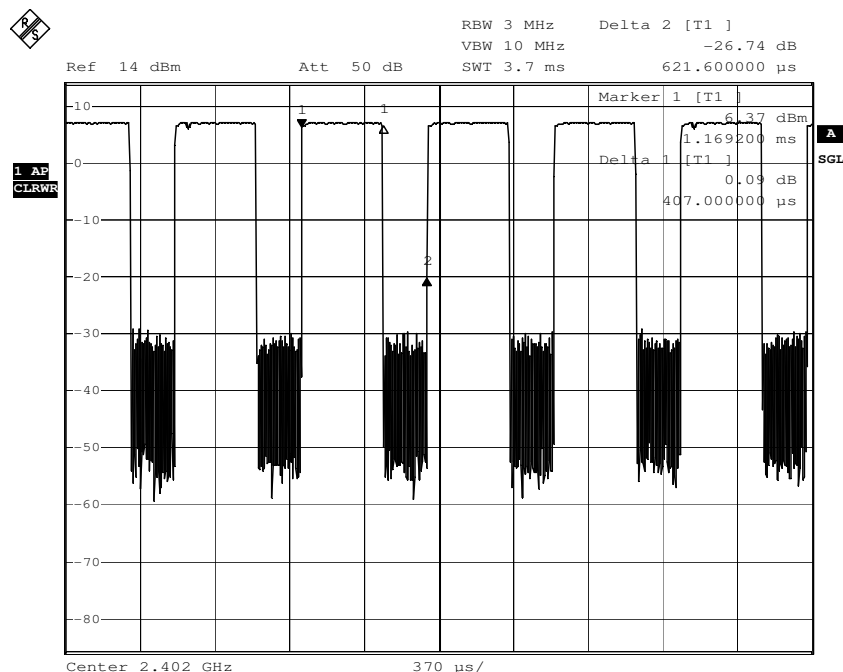

7. Photographs of the Test Set-Up

Photograph 1: Set-up for Spurious Emissions (Front View)

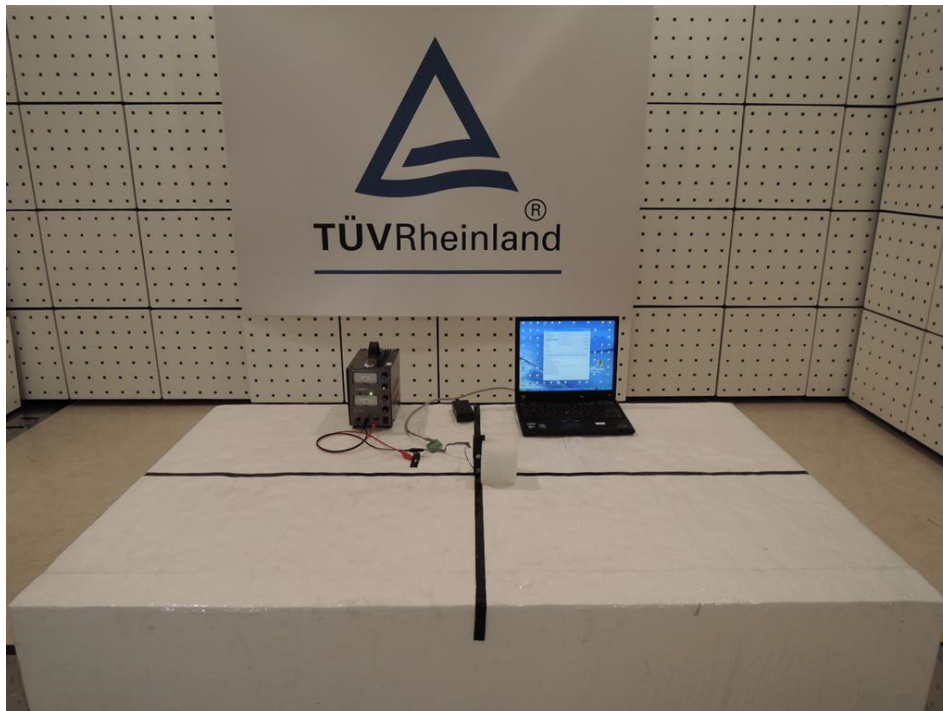

Photograph 2: Set-up for Spurious Emissions (Back View 1)

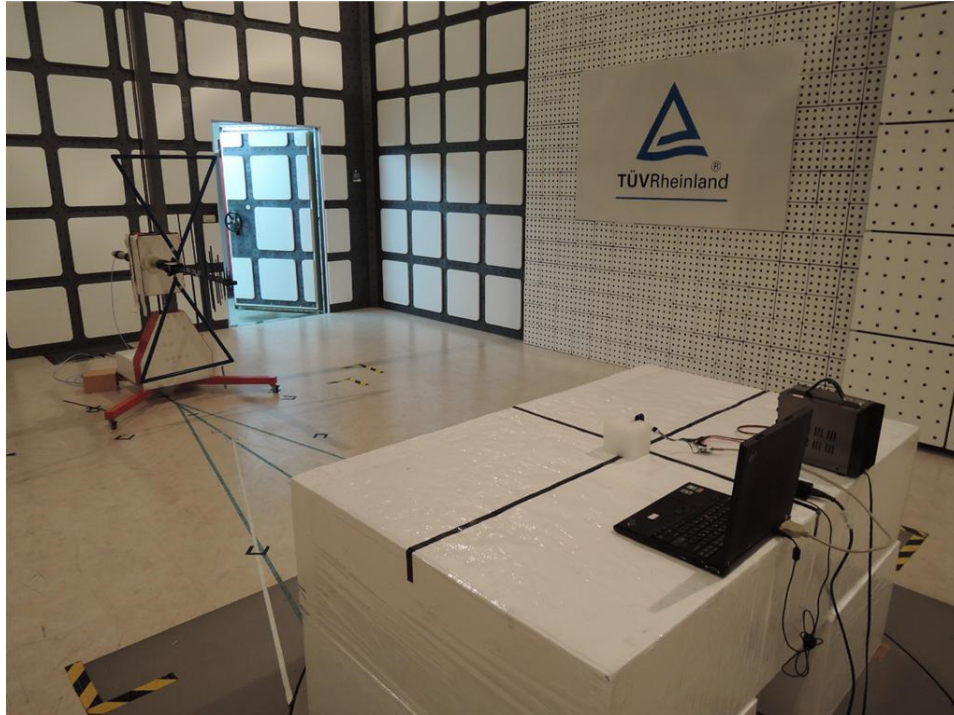

Photograph 3: Set-up for Spurious Emissions (Back View 2)

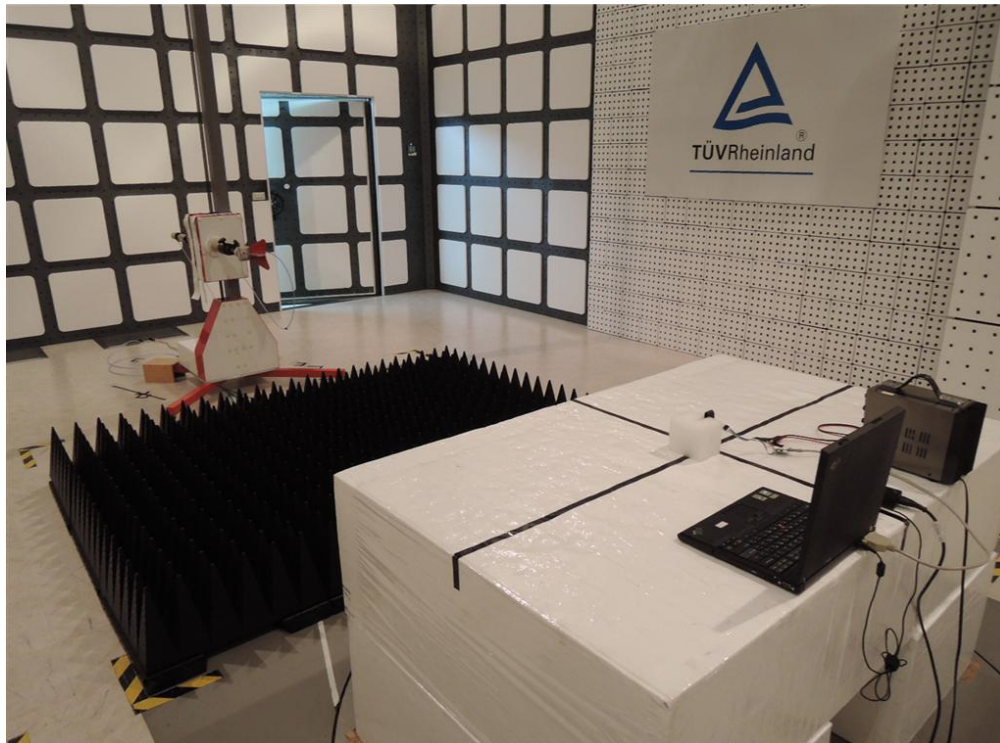

Photograph 4: Set-up for Conducted testing



8. List of Tables

Table 1: Applied Standard and Test Levels	4
Table 2: List of Test and Measurement Equipment	6
Table 3: Emission Measurement Uncertainty.....	7
Table 4: Basic Information of EUT	8
Table 5: Technical Specification of EUT	8
Table 6: Test result of Peak Output Power, GFSK modulation.....	14
Table 7: Test result of 6 dB Bandwidth, GFSK modulation.....	17
Table 8: Test result of 99% Bandwidth, GFSK modulation.....	17
Table 9: Test result of Power Density, GFSK modulation.....	20

9. List of Photographs

Photograph 1: Set-up for Spurious Emissions (Front View).....	29
Photograph 2: Set-up for Spurious Emissions (Back View 1)	30
Photograph 3: Set-up for Spurious Emissions (Back View 2)	31
Photograph 4: Set-up for Conducted testing	31