



RADIO TEST REPORT

Test Report No. : 11531217H-A-R1

Applicant : DENSO CORPORATION
Type of Equipment : Blind Spot Monitor Sensor
Model No. : DNSRR003
FCC ID : HYQDNSRR003
Test regulation : FCC Part 15 Subpart C: 2016
Test Result : Complied

1. This test report shall not be reproduced in full or partial, without the written approval of UL Japan, Inc.
2. The results in this report apply only to the sample tested.
3. This sample tested is in compliance with the above regulation.
4. The test results in this report are traceable to the national or international standards.
5. This test report must not be used by the customer to claim product certification, approval, or endorsement by NVLAP, NIST, or any agency of the Federal Government.
6. This test report covers Radio technical requirements. It does not cover administrative issues such as Manual or non-Radio test related Requirements. (if applicable)
7. This report is a revised version of 11531217H-A. 11531217H-A is replaced with this report.

Date of test: January 9 to 11, 2017

Representative test engineer:

Hironobu Ohnishi
Engineer
Consumer Technology Division

Approved by:

Motoya Imura
Engineer
Consumer Technology Division



This laboratory is accredited by the NVLAP LAB CODE 200572-0, U.S.A. The tests reported herein have been performed in accordance with its terms of accreditation.
*As for the range of Accreditation in NVLAP, you may refer to the WEB address,
http://japan.ul.com/resources/emc_accredited/

UL Japan, Inc.

Ise EMC Lab.

4383-326 Asama-cho, Ise-shi, Mie-ken 516-0021 JAPAN

Telephone : +81 596 24 8999

Facsimile : +81 596 24 8124

13-EM-F0429

REVISION HISTORY

Original Test Report No.: 11531217H-A

Revision	Test report No.	Date	Page revised	Contents
- (Original)	11531217H-A	February 9, 2017	-	-
1	11531217H-A-R1	February 24, 2017	P.8	Correction of Tested frequency in Clause 4.1.
1	11531217H-A-R1	February 24, 2017	P.8	Correction of Note *2) in Clause 4.1.

CONTENTS **PAGE**

SECTION 1: Customer information 4
SECTION 2: Equipment under test (E.U.T.)..... 4
SECTION 3: Test specification, procedures & results..... 5
SECTION 4: Operation of E.U.T. during testing..... 8
SECTION 5: Radiated emission (Electric Field Strength of Fundamental and Spurious Emission)10
SECTION 6: 20 dB Bandwidth, 99 % Occupied Bandwidth and Duty Cycle 12
APPENDIX 1: Test data 13
 Radiated Emission (Electric Field Strength of Fundamental and Spurious Emission)..... 13
 20dB Bandwidth, 99% Occupied Bandwidth 20
 Duty Cycle 23
APPENDIX 2: Test Instruments 24
APPENDIX 3: Photographs of test setup 26
 Radiated Emission (Fundamental emission)..... 26
 Radiated Emission (Spurious emission) 27
 Worst Case Position (Horizontal: Y-axis/ Vertical:X-axis)..... 28

SECTION 1: Customer information

Company Name : DENSO CORPORATION
Address : 1-1, Showa-cho, Kariya-shi, Aichi-ken, 448-8661 Japan
Telephone Number : +81-566-87-3456
Facsimile Number : +81-566-25-4683
Contact Person : Kiyohiko Sawada

SECTION 2: Equipment under test (E.U.T.)

2.1 Identification of E.U.T.

Type of Equipment : Blind Spot Monitor Sensor
Model No. : DNSRR003
Serial No. : Refer to Section 4, Clause 4.2
Rating : DC 12 V (Car battery)
Receipt Date of Sample : January 9, 2017
Country of Mass-production : Japan
Condition of EUT : Engineering prototype
(Not for Sale: This sample is equivalent to mass-produced items.)
Modification of EUT : No Modification by the test lab

2.2 Product Description

This Radar Sensor (DNSRR003) is a vehicle-mounted field disturbance sensor which uses millimeter wave for detecting obstacles located diagonally backward.

General Specification

Clock frequency(ies) in the system : Microcomputer: 240 MHz

Radio Specification

Radio Type : Transceiver
Frequency of Operation : 24.15 GHz
Modulation : Frequency modulation
Antenna Type : Internal Antenna
Antenna Connector : None
Antenna Gain : 9.3 dBi (Broad beam), 12.5 dBi (Narrow beam)
Steerable Antenna : Electronically
Usage location : Vehicle-mounted
Power Supply (inner) : DC 3.3 V

UL Japan, Inc.

Ise EMC Lab.

4383-326 Asama-cho, Ise-shi, Mie-ken 516-0021 JAPAN

Telephone : +81 596 24 8999

Facsimile : +81 596 24 8124

SECTION 3: Test specification, procedures & results

3.1 Test Specification

Test Specification : FCC Part 15 Subpart C
FCC Part 15 final revised on November 14, 2016 and effective December 14, 2016

Title : FCC 47CFR Part 15 Radio Frequency Device Subpart C Intentional Radiators
Section 15.207 Conducted limits
Section 15.249 Operation within the bands 902-928MHz,
2400-2483.5MHz, 5725-5875MHz and 24.0-24.25GHz

3.2 Procedures and results

Item	Test Procedure	Specification	Deviation	Worst margin	Results
Conducted Emission	FCC: ANSI C63.10-2013 6. Standard test methods	FCC: Section 15.207	N/A	-	N/A *1)
	IC: RSS-Gen 8.8	IC: RSS-Gen 8.8			
Electric Field Strength of Fundamental Emission	FCC: ANSI C63.10-2013 6. Standard test methods	FCC: Section 15.249(a)(c)(e)	N/A	8.2 dB 24150.00 MHz, Horizontal / Vertical, (Peak with Duty factor) Narrow beam (Right)	Complied
	IC: RSS-Gen 6.12	IC: RSS-310 3.10			
Electric Field Strength of Spurious Emission	FCC: ANSI C63.10-2013 6. Standard test methods 9. Procedures for testing millimeter-wave systems	FCC: Section 15.205(a)(b)(d) Section 15.209(a) Section 15.249(a)(c)(d)(e)	N/A	4.2 dB 24250.00 MHz, Vertical, (Peak with Duty factor) Broad beam / Narrow beam (Right)	Complied
	IC: RSS-Gen 6.13	IC: RSS-310 3.10 RSS-Gen 8.9			
20 dB Bandwidth	FCC: ANSI C63.10-2013 6. Standard test methods	FCC: Section 15.215	N/A	See data.	Complied
	IC: -	IC: Reference data			
Frequency Tolerance	FCC: ANSI C63.10-2013 6. Standard test methods	FCC: Section 15.249(b)	N/A	-	N/A *2)
	IC: -	IC: -			
99 % Occupied Bandwidth	FCC: -	FCC: Reference data	N/A	See data.	Complied
	IC: RSS-Gen 6.6	IC: -			

*1) The test is not applicable since the EUT is not the device that is designed to be connected to the public utility (AC) power line.

*2) The test is not applicable since the EUT does not operate with Fixed point-to-point operation within 24.05 GHz to 24.25 GHz.

Note: UL Japan, Inc.'s EMI Work Procedures No. 13-EM-W0420 and 13-EM-W0422.

FCC Part 15.31 (e)

The EUT provides stable voltage (DC 3.3 V) constantly to the RF part regardless of input voltage. Instead of a new battery, DC power supply was used for the test.

That does not affect to the test result, therefore the EUT complies with the requirement.

FCC Part 15.203 Antenna requirement

It is impossible for end users to replace the antenna, because the antenna is mounted inside of the EUT. Therefore, the equipment complies with the antenna requirement of Section 15.203.

UL Japan, Inc.

Ise EMC Lab.

4383-326 Asama-cho, Ise-shi, Mie-ken 516-0021 JAPAN

Telephone : +81 596 24 8999

Facsimile : +81 596 24 8124

3.3 Addition to standard

Other than above, no addition, exclusion nor deviation has been made from the standard.

3.4 Uncertainty

EMI

The following uncertainties have been calculated to provide a confidence level of 95 % using a coverage factor $k=2$.

Test distance	Radiated emission (+/-)
	9 kHz - 30 MHz
3m	3.8 dB
10m	3.7 dB

*Measurement distance

Polarity	Radiated emission (Below 1GHz)			
	(3 m*)(+/-)		(10 m*)(+/-)	
	30 – 200 MHz	200 – 1000MHz	30 – 200 MHz	200 – 1000MHz
Horizontal	5.0 dB	5.3 dB	5.0 dB	5.0 dB
Vertical	4.7 dB	5.9 dB	5.0 dB	5.1 dB

Radiated emission (Above 1GHz)				
(3 m*)(+/-)		(1 m*)(+/-)		(10 m*)(+/-)
1 – 6GHz	6 – 18GHz	10 – 26.5 GHz	26.5 – 40GHz	1 -18 GHz
5.2 dB	5.4 dB	5.5 dB	5.5 dB	5.4 dB

* Measurement distance

Radiated emission (+dB)	
40 GHz - 50 GHz	4.1 dB
50 GHz - 75 GHz	5.1 dB
75 GHz - 100 GHz	5.4 dB

Radiated emission test

[Electric Field Strength of Fundamental Emission]

The data listed in this test report has enough margin, more than the site margin.

[Electric Field Strength of Spurious Emission]

The data listed in this report meets the limits unless the uncertainty is taken into consideration.

UL Japan, Inc.

Ise EMC Lab.

4383-326 Asama-cho, Ise-shi, Mie-ken 516-0021 JAPAN

Telephone : +81 596 24 8999

Facsimile : +81 596 24 8124

3.5 Test Location

UL Japan, Inc. Ise EMC Lab. *NVLAP Lab. code: 200572-0
4383-326 Asama-cho, Ise-shi, Mie-ken 516-0021 JAPAN
Telephone : +81 596 24 8999 Facsimile : +81 596 24 8124

	IC Registration Number	Width x Depth x Height (m)	Size of reference ground plane (m) / horizontal conducting plane	Other rooms
No.1 semi-anechoic chamber	2973C-1	19.2 x 11.2 x 7.7m	7.0 x 6.0m	No.1 Power source room
No.2 semi-anechoic chamber	2973C-2	7.5 x 5.8 x 5.2m	4.0 x 4.0m	-
No.3 semi-anechoic chamber	2973C-3	12.0 x 8.5 x 5.9m	6.8 x 5.75m	No.3 Preparation room
No.3 shielded room	-	4.0 x 6.0 x 2.7m	N/A	-
No.4 semi-anechoic chamber	2973C-4	12.0 x 8.5 x 5.9m	6.8 x 5.75m	No.4 Preparation room
No.4 shielded room	-	4.0 x 6.0 x 2.7m	N/A	-
No.5 semi-anechoic chamber	-	6.0 x 6.0 x 3.9m	6.0 x 6.0m	-
No.6 shielded room	-	4.0 x 4.5 x 2.7m	4.0 x 4.5 m	-
No.6 measurement room	-	4.75 x 5.4 x 3.0m	4.75 x 4.15 m	-
No.7 shielded room	-	4.7 x 7.5 x 2.7m	4.7 x 7.5m	-
No.8 measurement room	-	3.1 x 5.0 x 2.7m	N/A	-
No.9 measurement room	-	8.0 x 4.6 x 2.8m	2.4 x 2.4m	-
No.11 measurement room	-	6.2 x 4.7 x 3.0m	4.8 x 4.6m	-

* Size of vertical conducting plane (for Conducted Emission test) : 2.0 x 2.0m for No.1, No.2, No.3, and No.4 semi-anechoic chambers and No.3 and No.4 shielded rooms.

3.6 Test data, Test instruments, and Test set up.

Refer to APPENDIX.

SECTION 4: Operation of E.U.T. during testing

4.1 Operating Modes

Test Item	Mode	Tested frequency
Electric Field Strength of Fundamental Emission Electric Field Strength of Spurious Emission 20 dB Bandwidth 99 % Occupied Bandwidth	Transmitting mode (Tx) Beam setting *1) - Broad beam - Narrow beam (Left) - Narrow beam (Right)	24.15 GHz FSK setting *2) - Hopping (Normal mode) - Hopping Off (Highest)
<p>*1) This EUT has three transmission beam patterns. The tests were performed in these three patterns.</p> <p>*2) There are FM and FSK modulation parts in one transmission burst. (Hopping mode) The additional test mode was applied to make sure the band-edge compliance. (Hopping Off mode)</p> <p>The system was configured in typical fashion (as a customer would normally use it) for testing.</p> <p>*EUT has the power settings by the software as follows; Power Settings: Same as Production model Software: mwr_24310050</p> <p>*This setting of software is the worst case. Any conditions under the normal use do not exceed the condition of setting. In addition, end users cannot change the settings of the output power of the product.</p>		

UL Japan, Inc.

Ise EMC Lab.

4383-326 Asama-cho, Ise-shi, Mie-ken 516-0021 JAPAN

Telephone : +81 596 24 8999

Facsimile : +81 596 24 8124

4.2 Configuration and peripherals

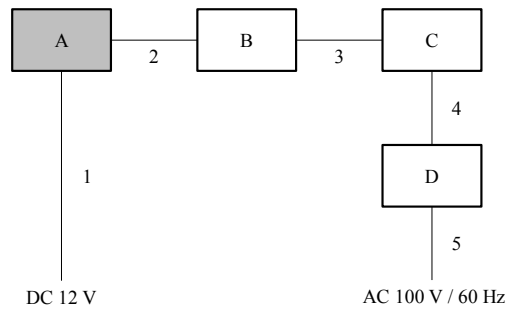

* Cabling and setup(s) were taken into consideration and test data was taken under worse case conditions.

Description of EUT

No.	Item	Model number	Serial number	Manufacturer	Remarks
A	Blind Spot Monitor Sensor	DNSRR003	8041	DENSO CORPORATION	EUT
B	CAN Interface	VN1610	007150-003583	Vector	-
C	Laptop	PR634MEA637A D71	9F013326H	TOSHIBA	-
D	AC Adapter	PA5044U-1ACA	G71C000E6410	TOSHIBA	-

List of cables used

No.	Name	Length (m)	Shield		Remarks
			Cable	Connector	
1	DC Cable	2.5	Unshielded	Unshielded	-
2	CAN Cable	2.0	Unshielded	Unshielded	-
3	USB Cable	1.0	Shielded	Shielded	-
4	DC Cable	1.7	Unshielded	Unshielded	-
5	AC Cable	0.9	Unshielded	Unshielded	-

UL Japan, Inc.

Ise EMC Lab.

4383-326 Asama-cho, Ise-shi, Mie-ken 516-0021 JAPAN

Telephone : +81 596 24 8999

Facsimile : +81 596 24 8124

SECTION 5: Radiated emission (Electric Field Strength of Fundamental and Spurious Emission)

Test Procedure and conditions

[For below 1 GHz]

EUT was placed on a urethane platform of nominal size, 0.5 m by 1.0 m, raised 0.8 m above the conducting ground plane. The Radiated Electric Field Strength has been measured in a Semi Anechoic Chamber with a ground plane.

[For above 1 GHz, up to 40 GHz]

EUT was placed on a urethane platform of nominal size, 0.5 m by 0.5 m, raised 1.5 m above the conducting ground plane. The Radiated Electric Field Strength has been measured in a Semi Anechoic Chamber with absorbent materials lined on a ground plane.

The height of the measuring antenna varied between 1 m and 4 m (frequency range 9 kHz – 30 MHz: loop antenna was fixed height at 1.0 m) and EUT was rotated a full revolution in order to obtain the maximum value of the electric field strength.

The measurements were performed for both vertical and horizontal antenna polarization with the Test Receiver, or the Spectrum Analyzer.

The measurements were made with the following detector function of the test receiver and the Spectrum analyzer (in linear voltage average mode).

The test was made with the detector (RBW/VBW) in the following table.

When using Spectrum analyzer, the test was made with adjusting span to zero by using peak hold.

Test Antennas are used as below;

Frequency	Below 30 MHz	30 MHz to 200 MHz	200 MHz to 1 GHz	Above 1 GHz
Antenna Type	Loop	Biconical	Logperiodic	Horn

Frequency	9 kHz – 150 kHz	150 kHz – 30 MHz	30 MHz – 1 GHz	1 GHz – 40 GHz	
Instrument used	Test Receiver	Test Receiver	Test Receiver	Spectrum Analyzer	
Detector	QP, Average	QP, Average	QP	Peak	Average *1)
IF Bandwidth	BW 200 Hz	BW 9 kHz	BW 120 kHz	RBW: 1 MHz VBW: 3 MHz	Pulsed emission - RBW: 1 MHz - Peak with duty Other than above - RBW: 1 MHz - VBW: 10 Hz
Test Distance	3 m	3 m	3 m	4.5 m *2) (1 GHz – 10 GHz) 1 m *3) (10 GHz – 26.5 GHz), 0.5 m *4) (26.5 GHz – 40 GHz)	

*1) For Pulsed emission (Fundamental and band-edge): The Average value was calculated by reducing Duty factor from Peak (Peak value – Duty factor). For Duty factor, please refer to page Duty factor measurement. Other than pulsed emission, aVBW was set to 10 Hz and linear voltage average mode was used.

*2) Distance Factor: $20 \times \log(4.5 \text{ m} / 3.0 \text{ m}) = 3.5 \text{ dB}$

*3) Distance Factor: $20 \times \log(1.0 \text{ m} / 3.0 \text{ m}) = -9.5 \text{ dB}$

*4) Distance Factor: $20 \times \log(0.5 \text{ m} / 3.0 \text{ m}) = -15.6 \text{ dB}$

UL Japan, Inc.

Ise EMC Lab.

4383-326 Asama-cho, Ise-shi, Mie-ken 516-0021 JAPAN

Telephone : +81 596 24 8999

Facsimile : +81 596 24 8124

[About fundamental measurement]

The carrier levels were confirmed at maximum direction of transmission. The maximum direction was searched under carefully since beam-widths are narrow.

The carrier levels were measured in the far field. The distance of the far field was calculated from follow equation.

$$r = \frac{2D^2}{\lambda}$$

where

r is the distance from the radiating element of the EUT to the edge of the far field, in m

D is the largest dimension of both the radiating element and the test antenna (horn), in m

(The antenna aperture size of test antenna was used for this calculation.)

Lambda is the wavelength of the emission under investigation [$300 / f(\text{MHz}) * 10^3$], in millimeter

Frequency [GHz]	Wavelength <i>Lambda</i> [mm]	Maximum Dimention			Far Field Boundary <i>r</i> [m]
		EUT [m]	Test Antenna (MHA-02) [m]	Maximum <i>D</i> [m]	
24.250	12.4	0.028	0.036	0.036	0.210

[Above 40 GHz]

The test was performed based on “Procedures for testing millimeter-wave systems” of ANSI C63.10-2013. The EUT was placed on an urethane platform, raised 1.5 m above the conducting ground plane. The measurements were performed on handheld method.

Set spectrum analyzer RBW, VBW, span, etc., to the proper values. Note these values. Enable two traces—one set to “clear write,” and the other set to “max hold.” Begin hand-held measurements with the test antenna (horn) at a distance of 1 m from the EUT in a horizontally polarized position. Slowly adjust its position, entirely covering the plane 1 m from the EUT. Observation of the two active traces on the spectrum analyzer will allow refined horn positioning at the point(s) of maximum field intensity. Repeat with the horn in a vertically polarized position. If the emission cannot be detected at 1 m, reduce the RBW to increase system sensitivity. Note the value. If the emission still cannot be detected, move the horn closer to the EUT, noting the distance at which a measurement is made.

Note the maximum level indicated on the spectrum analyzer. Adjust this level, if necessary, by the antenna gain, conversion loss of the external mixer and gain of LNA used, at the frequency under investigation. Calculate the field strength of the emission at the measurement distance from the Friis’ transmission equation.

Frequency	40 GHz – 50 GHz	50 GHz – 75 GHz	75 GHz – 100 GHz
Final measurement distance with 1 MHz Peak detector	0.5 m	0.25 m	0.25 m

Detector	Peak	Average *1)	
IF Bandwidth	RBW: 1 MHz VBW: 3 MHz	Pulsed emission - RBW: 1 MHz - Peak with duty	Other than pulsed - RBW: 1 MHz - VBW: 10 Hz

*1) For Pulsed emission: The Average value was calculated by reducing Duty factor from Peak (Peak value – Duty factor). For Duty factor, please refer to page Duty factor measurement. Other than pulsed emission, a VBW was set to 10 Hz and linear voltage average mode was used.

- The carrier level and noise levels were confirmed at each position of X and Y axes of EUT to see the position of maximum noise, and the test was made at the position that has the maximum noise.

The test results and limit are rounded off to one decimal place, so some differences might be observed.

Measurement range : 9 kHz – 100 GHz
Test data : APPENDIX
Test result : Pass

UL Japan, Inc.

Ise EMC Lab.

4383-326 Asama-cho, Ise-shi, Mie-ken 516-0021 JAPAN

Telephone : +81 596 24 8999

Facsimile : +81 596 24 8124

SECTION 6: 20 dB Bandwidth, 99 % Occupied Bandwidth and Duty Cycle

Test Procedure

The measurement was performed in the antenna height to gain the maximum of Electric field strength.

Test	Span	RBW	VBW	Sweep	Detector	Trace	Instrument used
20 dB Bandwidth	600 MHz	2 MHz 1 % to 5 % of OBW	6 MHz Three times of RBW	60 sec	Peak	Max Hold	Spectrum Analyzer
99 % Occupied Bandwidth	600 MHz, Enough width to display emission skirts	2 MHz, 1 % to 5 % of OBW	6 MHz, Three times of RBW	60 sec	Peak *1)	Max Hold *2)	Spectrum Analyzer
Duty Cycle	-	-	-	200 msec	-	Single	Oscilloscope

*1) Peak detector was applied as Worst-case measurement.
*2) The measurement was performed with Max Hold since the duty cycle was not 100 %.

Test data : APPENDIX
Test result : Pass

APPENDIX 1: Test data

Radiated Emission (Electric Field Strength of Fundamental and Spurious Emission)

Report No. 11531217H
Test place Ise EMC Lab.
Semi Anechoic Chamber No. 3 No. 3 No. 3
Date January 09, 2017 January 10, 2017 January 11, 2017
Temperature / Humidity 24 deg. C / 45 % RH 24 deg. C / 46 % RH 24 deg. C / 48 % RH
10 GHz - 40 GHz 40 GHz - 100 GHz 9 kHz - 10 GHz
Engineer Ryota Yamanaka
Mode Tx 24.15 GHz, Broad beam

[Fundamental, band-edge]

Peak													
Frequency [MHz]	Detector	Reading [dBuV]		Ant Factor [dB/m]	Loss [dB]	Gain [dB]	Duty Factor [dB]	Result (3 m) [dBuV/m]		Limit (3 m) dBuV/m	Margin [dB]		Remark Inside or Outside of Restricted Bands
		Hor	Ver					Hor	Ver		Hor	Ver	
24000.00	Peak	46.6	47.8	40.7	-0.3	32.1	-	54.9	56.1	73.9	19.0	17.8	Inside
24150.00	Peak	97.7	96.8	40.7	-0.3	32.0	-	106.1	105.2	127.9	21.8	22.7	Fundamental
24250.00	Peak	47.9	48.0	40.7	-0.3	31.9	-	56.4	56.5	73.9	17.5	17.4	Outside

Result = Reading + Ant Factor + Loss (Cable+Attenuator+Filter+Distance Factor) - Gain(Amplifier)

Peak with Duty factor

Frequency [MHz]	Detector	Reading [dBuV]		Ant Factor [dB/m]	Loss [dB]	Gain [dB]	Duty Factor [dB]	Result [dBuV/m]		Limit dBuV/m	Margin [dB]		Remark
		Hor	Ver					Hor	Ver		Hor	Ver	
24000.00	Peak	46.6	47.8	40.7	-0.3	32.1	-6.8	48.1	49.3	53.9	5.8	4.6	Inside
24150.00	Peak	97.7	96.8	40.7	-0.3	32.0	-6.8	99.3	98.4	107.9	8.6	9.5	Fundamental
24250.00	Peak	47.9	48.0	40.7	-0.3	31.9	-6.8	49.6	49.7	53.9	4.3	4.2	Outside

Result = Reading + Ant Factor + Loss (Cable+Attenuator+Filter+Distance Factor) - Gain(Amplifier) + Duty factor (Refer to Duty factor data sheet)

[Spurious emissions other than above]

Polarity	Frequency [MHz]	Detector	Reading [dBuV]	Ant.Fac. [dB/m]	Loss [dB]	Gain [dB]	Result [dBuV/m]	Limit [dBuV/m]	Margin [dB]	Remark
Hori.	39.320	QP	26.2	14.6	7.3	32.2	15.9	40.0	24.1	
Hori.	49.418	QP	29.2	11.1	7.4	32.2	15.5	40.0	24.5	
Hori.	55.614	QP	28.1	9.2	7.5	32.2	12.6	40.0	27.4	
Hori.	117.964	QP	25.8	12.7	8.3	32.2	14.6	43.5	28.9	
Hori.	240.000	QP	21.9	12.2	9.5	32.0	11.6	46.0	34.4	
Hori.	960.000	QP	21.0	22.3	13.7	30.6	26.4	46.0	19.6	
Hori.	48300.000	PK	43.4	41.7	-7.3	32.6	45.2	87.9	42.7	
Hori.	72450.000	PK	38.9	41.7	-4.4	21.0	55.2	87.9	32.7	
Hori.	96600.000	PK	46.1	45.6	-9.5	28.7	53.5	73.9	20.4	
Hori.	48300.000	AV	30.4	41.7	-7.3	32.6	32.2	67.9	35.7	NS, VBW 10 Hz Voltage Avg
Hori.	72450.000	AV	26.3	41.7	-4.4	21.0	42.6	67.9	25.3	NS, VBW 10 Hz Voltage Avg
Hori.	96600.000	AV	32.4	45.6	-9.5	28.7	39.8	53.9	14.1	NS, VBW 10 Hz Voltage Avg
Vert.	39.320	QP	30.3	14.6	7.3	32.2	20.0	40.0	20.0	
Vert.	49.148	QP	32.3	11.2	7.4	32.2	18.7	40.0	21.3	
Vert.	55.614	QP	32.8	9.2	7.5	32.2	17.3	40.0	22.7	
Vert.	117.964	QP	30.6	12.7	8.3	32.2	19.4	43.5	24.1	
Vert.	240.000	QP	21.9	12.2	9.5	32.0	11.6	46.0	34.4	
Vert.	960.000	QP	21.0	22.3	13.7	30.6	26.4	46.0	19.6	
Vert.	48300.000	PK	44.2	41.7	-7.3	32.6	46.0	87.9	41.9	
Vert.	72450.000	PK	39.0	41.7	-4.4	21.0	55.3	87.9	32.6	
Vert.	96600.000	PK	45.0	45.6	-9.5	28.7	52.4	73.9	21.5	
Vert.	48300.000	AV	30.5	41.7	-7.3	32.6	32.3	67.9	35.6	NS, VBW 10 Hz Voltage Avg
Vert.	72450.000	AV	26.3	41.7	-4.4	21.0	42.6	67.9	25.3	NS, VBW 10 Hz Voltage Avg
Vert.	96600.000	AV	32.4	45.6	-9.5	28.7	39.8	53.9	14.1	NS, VBW 10 Hz Voltage Avg

Result = Reading + Ant Factor + Loss (Cable+Attenuator+Filter+Mixer(above 50 GHz)+Distance factor(above 1 GHz)) - Gain(Amplifier)

*Other frequency noises omitted in this report were not seen or had enough margin (more than 20 dB).

*NS: No signal detected.

Distance factor: 1 GHz - 10 GHz 20log (4.5 m / 3.0 m) = 3.5 dB
10 GHz - 26.5 GHz 20log (1.0 m / 3.0 m) = -9.5 dB
26.5 GHz - 50 GHz 20log (0.5 m / 3.0 m) = -15.6 dB
50 GHz - 100 GHz 20log (0.25 m / 3.0 m) = -21.6 dB

UL Japan, Inc.

Ise EMC Lab.

4383-326 Asama-cho, Ise-shi, Mie-ken 516-0021 JAPAN

Telephone : +81 596 24 8999

Facsimile : +81 596 24 8124

Radiated Spurious Emission
(Reference Plot for band-edge)

Test place	Ise EMC Lab. No. 3 Semi Anechoic Chamber
Report No.	11531217H
Date	January 09, 2017
Temperature / Humidity	24 deg. C / 45 % RH
Engineer	Ryota Yamanaka
Mode	Tx 24.15 GHz, Broad beam

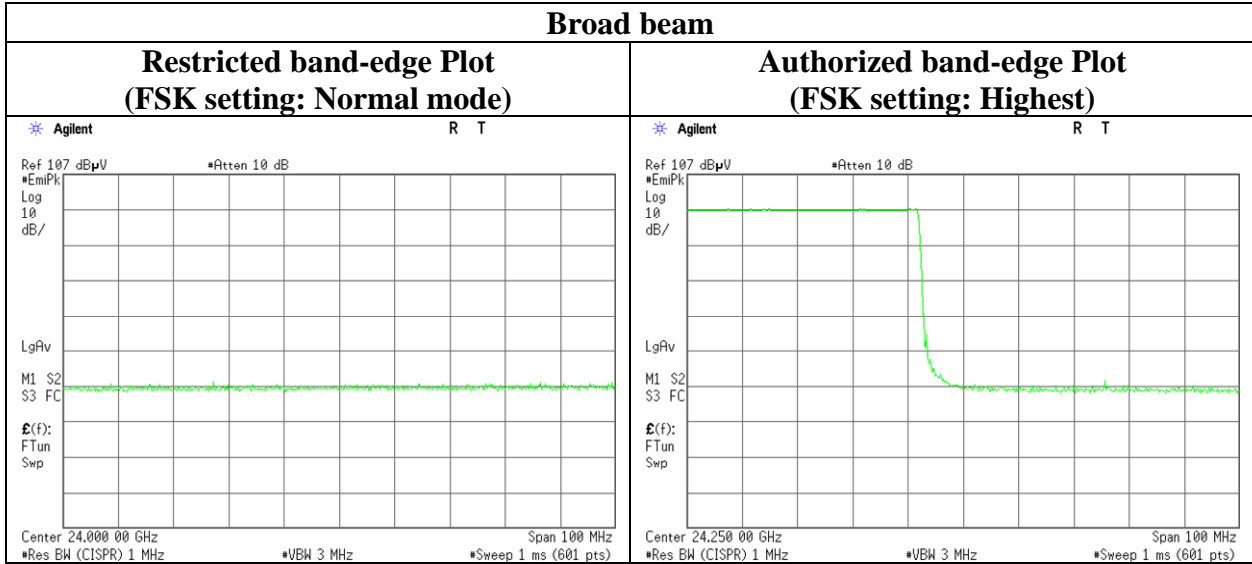

* Final result of restricted band edge was shown in tabular data.

The test was performed on two FSK settings in consideration of the worst case measurement.

Radiated Emission (Electric Field Strength of Fundamental and Spurious Emission)

Report No. 11531217H
Test place Ise EMC Lab.
Semi Anechoic Chamber No. 3 No. 3 No. 3
Date January 09, 2017 January 10, 2017 January 11, 2017
Temperature / Humidity 24 deg. C / 45 % RH 24 deg. C / 46 % RH 24 deg. C / 48 % RH
10 GHz - 40 GHz 40 GHz - 100 GHz 9 kHz - 10 GHz
Engineer Ryota Yamanaka
Mode Tx 24.15 GHz, Narrow beam(Left)

[Fundamental, band-edge]

Peak

Frequency [MHz]	Detector	Reading [dBuV]		Ant Factor [dB/m]	Loss [dB]	Gain [dB]	Duty Factor [dB]	Result (3 m) [dBuV/m]		Limit (3 m) dBuV/m	Margin [dB]		Remark Inside or Outside of Restricted Bands
		Hor	Ver					Hor	Ver		Hor	Ver	
24000.00	Peak	48.1	47.0	40.7	-0.3	32.1	-	56.4	55.3	73.9	17.5	18.6	Inside
24150.00	Peak	97.9	97.6	40.7	-0.3	32.0	-	106.3	106.0	127.9	21.6	21.9	Fundamental
24250.00	Peak	47.5	47.4	40.7	-0.3	31.9	-	56.0	55.9	73.9	17.9	18.0	Outside

Result = Reading + Ant Factor + Loss (Cable+Attenuator+Filter+Distance Factor) - Gain(Amplifier)

Peak with Duty factor

Frequency [MHz]	Detector	Reading [dBuV]		Ant Factor [dB/m]	Loss [dB]	Gain [dB]	Duty Factor [dB]	Result [dBuV/m]		Limit dBuV/m	Margin [dB]		Remark
		Hor	Ver					Hor	Ver		Hor	Ver	
24000.00	Peak	48.1	47.0	40.7	-0.3	32.1	-6.8	49.6	48.5	53.9	4.3	5.4	Inside
24150.00	Peak	97.9	97.6	40.7	-0.3	32.0	-6.8	99.5	99.2	107.9	8.4	8.7	Fundamental
24250.00	Peak	47.5	47.4	40.7	-0.3	31.9	-6.8	49.2	49.1	53.9	4.7	4.8	Outside

Result = Reading + Ant Factor + Loss (Cable+Attenuator+Filter+Distance Factor) - Gain(Amplifier) + Duty factor (Refer to Duty factor data sheet)

[Spurious emissions other than above]

Polarity	Frequency [MHz]	Detector	Reading [dBuV]	Ant.Fac. [dB/m]	Loss [dB]	Gain [dB]	Result [dBuV/m]	Limit [dBuV/m]	Margin [dB]	Remark
Hori.	39.320	QP	25.8	14.6	7.3	32.2	15.5	40.0	24.5	
Hori.	49.148	QP	29.2	11.2	7.4	32.2	15.6	40.0	24.4	
Hori.	55.633	QP	28.5	9.2	7.5	32.2	13.0	40.0	27.0	
Hori.	117.964	QP	25.8	12.7	8.3	32.2	14.6	43.5	28.9	
Hori.	240.000	QP	21.9	12.2	9.5	32.0	11.6	46.0	34.4	
Hori.	960.000	QP	21.0	22.3	13.7	30.6	26.4	46.0	19.6	
Hori.	48300.000	PK	43.3	41.7	-7.3	32.6	45.1	87.9	42.8	
Hori.	72450.000	PK	38.8	41.7	-4.4	21.0	55.1	87.9	32.8	
Hori.	96600.000	PK	45.8	45.6	-9.5	28.7	53.2	73.9	20.7	
Hori.	48300.000	AV	30.4	41.7	-7.3	32.6	32.2	67.9	35.7	NS, VBW 10 Hz Voltage Avg
Hori.	72450.000	AV	26.2	41.7	-4.4	21.0	42.5	67.9	25.4	NS, VBW 10 Hz Voltage Avg
Hori.	96600.000	AV	32.4	45.6	-9.5	28.7	39.8	53.9	14.1	NS, VBW 10 Hz Voltage Avg
Vert.	39.320	QP	29.9	14.6	7.3	32.2	19.6	40.0	20.4	
Vert.	49.148	QP	31.9	11.2	7.4	32.2	18.3	40.0	21.7	
Vert.	55.633	QP	32.7	9.2	7.5	32.2	17.2	40.0	22.8	
Vert.	117.935	QP	29.3	12.7	8.3	32.2	18.1	43.5	25.4	
Vert.	240.000	QP	21.9	12.2	9.5	32.0	11.6	46.0	34.4	
Vert.	960.000	QP	21.0	22.3	13.7	30.6	26.4	46.0	19.6	
Vert.	48300.000	PK	44.1	41.7	-7.3	32.6	45.9	87.9	42.0	
Vert.	72450.000	PK	39.1	41.7	-4.4	21.0	55.4	87.9	32.5	
Vert.	96600.000	PK	45.5	45.6	-9.5	28.7	52.9	73.9	21.0	
Vert.	48300.000	AV	30.4	41.7	-7.3	32.6	32.2	67.9	35.7	NS, VBW 10 Hz Voltage Avg
Vert.	72450.000	AV	26.2	41.7	-4.4	21.0	42.5	67.9	25.4	NS, VBW 10 Hz Voltage Avg
Vert.	96600.000	AV	32.4	45.6	-9.5	28.7	39.8	53.9	14.1	NS, VBW 10 Hz Voltage Avg

Result = Reading + Ant Factor + Loss (Cable+Attenuator+Filter+Mixer(above 50 GHz)+Distance factor(above 1 GHz)) - Gain(Amplifier)

*Other frequency noises omitted in this report were not seen or had enough margin (more than 20 dB).

*NS: No signal detected.

Distance factor: 1 GHz - 10 GHz 20log(4.5 m / 3.0 m) = 3.5 dB
10 GHz - 26.5 GHz 20log(1.0 m / 3.0 m) = -9.5 dB
26.5 GHz - 50 GHz 20log(0.5 m / 3.0 m) = -15.6 dB
50 GHz - 100 GHz 20log(0.25 m / 3.0 m) = -21.6 dB

UL Japan, Inc.

Ise EMC Lab.

4383-326 Asama-cho, Ise-shi, Mie-ken 516-0021 JAPAN

Telephone : +81 596 24 8999

Facsimile : +81 596 24 8124

Radiated Spurious Emission
(Reference Plot for band-edge)

Test place	Ise EMC Lab. No. 3 Semi Anechoic Chamber
Report No.	11531217H
Date	January 09, 2017
Temperature / Humidity	24 deg. C / 45 % RH
Engineer	Ryota Yamanaka
Mode	Tx 24.15 GHz, Narrow beam(Left)

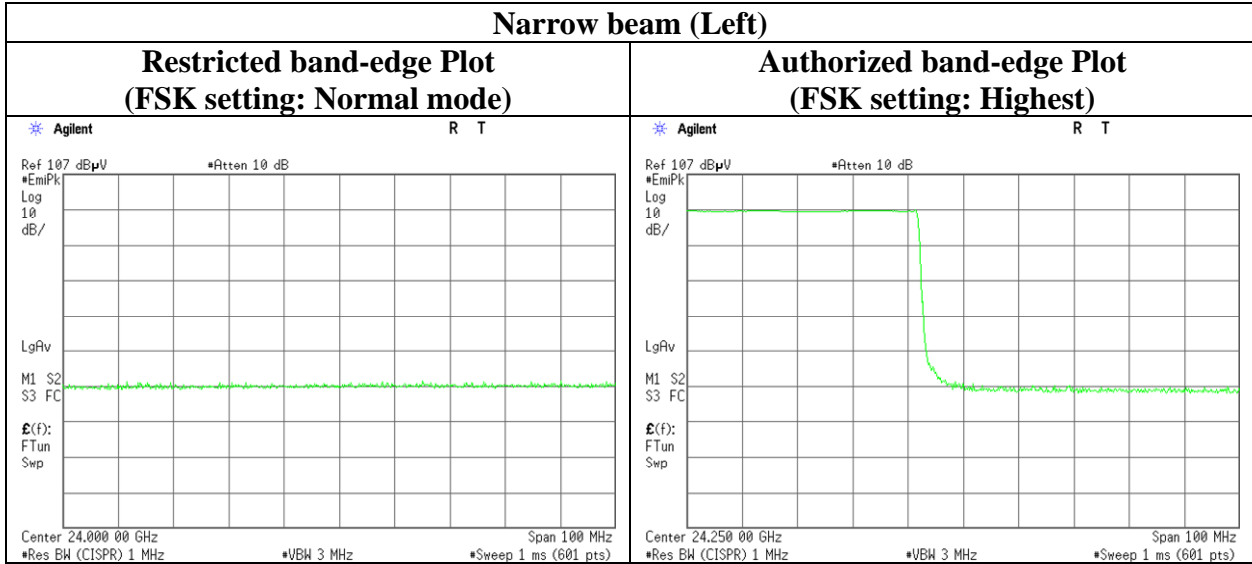

* Final result of restricted band edge was shown in tabular data.

The test was performed on two FSK settings in consideration of the worst case measurement.

Radiated Emission (Electric Field Strength of Fundamental and Spurious Emission)

Report No. 11531217H
Test place Ise EMC Lab.
Semi Anechoic Chamber No. 3 No. 3 No. 3
Date January 09, 2017 January 10, 2017 January 11, 2017
Temperature / Humidity 24 deg. C / 45 % RH 24 deg. C / 46 % RH 24 deg. C / 48 % RH
10 GHz - 40 GHz 40 GHz - 100 GHz 9 kHz - 10 GHz
Engineer Ryota Yamanaka
Mode Tx 24.15 GHz, Narrow beam(Right)

[Fundamental, band-edge]

Frequency [MHz]	Detector	Reading [dBuV]		Ant Factor [dB/m]	Loss [dB]	Gain [dB]	Duty Factor [dB]	Result (3 m) [dBuV/m]		Limit (3 m) [dBuV/m]	Margin [dB]		Remark Inside or Outside of Restricted Bands
		Hor	Ver					Hor	Ver		Hor	Ver	
24000.00	Peak	46.5	47.2	40.7	-0.3	32.1	-	54.8	55.5	73.9	19.1	18.4	Inside
24150.00	Peak	98.1	98.1	40.7	-0.3	32.0	-	106.5	106.5	127.9	21.4	21.4	Fundamental
24250.00	Peak	47.3	48.0	40.7	-0.3	31.9	-	55.8	56.5	73.9	18.1	17.4	Outside

Result = Reading + Ant Factor + Loss (Cable+Attenuator+Filter+Distance Factor) - Gain(Amplifier)

Peak with Duty factor

Frequency [MHz]	Detector	Reading [dBuV]		Ant Factor [dB/m]	Loss [dB]	Gain [dB]	Duty Factor [dB]	Result [dBuV/m]		Limit [dBuV/m]	Margin [dB]		Remark
		Hor	Ver					Hor	Ver		Hor	Ver	
24000.00	Peak	46.5	47.2	40.7	-0.3	32.1	-6.8	48.0	48.7	53.9	5.9	5.2	Inside
24150.00	Peak	98.1	98.1	40.7	-0.3	32.0	-6.8	99.7	99.7	107.9	8.2	8.2	Fundamental
24250.00	Peak	47.3	48.0	40.7	-0.3	31.9	-6.8	49.0	49.7	53.9	4.9	4.2	Outside

Result = Reading + Ant Factor + Loss (Cable+Attenuator+Filter+Distance Factor) - Gain(Amplifier) + Duty factor (Refer to Duty factor data sheet)

[Spurious emissions other than above]

Polarity	Frequency [MHz]	Detector	Reading [dBuV]	Ant. Fac. [dB/m]	Loss [dB]	Gain [dB]	Result [dBuV/m]	Limit [dBuV/m]	Margin [dB]	Remark
Hori.	39.334	QP	25.8	14.6	7.3	32.2	15.5	40.0	24.5	
Hori.	49.154	QP	28.6	11.2	7.4	32.2	15.0	40.0	25.0	
Hori.	55.633	QP	28.5	9.2	7.5	32.2	13.0	40.0	27.0	
Hori.	117.964	QP	25.0	12.7	8.3	32.2	13.8	43.5	29.7	
Hori.	240.000	QP	21.9	12.2	9.5	32.0	11.6	46.0	34.4	
Hori.	960.000	QP	21.0	22.3	13.7	30.6	26.4	46.0	19.6	
Hori.	48300.000	PK	44.0	41.7	-7.3	32.6	45.8	87.9	42.1	
Hori.	72450.000	PK	38.9	41.7	-4.4	21.0	55.2	87.9	32.7	
Hori.	96600.000	PK	46.0	45.6	-9.5	28.7	53.4	73.9	20.5	
Hori.	48300.000	AV	30.4	41.7	-7.3	32.6	32.2	67.9	35.7	NS, VBW 10 Hz Voltage Avg
Hori.	72450.000	AV	26.3	41.7	-4.4	21.0	42.6	67.9	25.3	NS, VBW 10 Hz Voltage Avg
Hori.	96600.000	AV	32.4	45.6	-9.5	28.7	39.8	53.9	14.1	NS, VBW 10 Hz Voltage Avg
Vert.	39.334	QP	29.6	14.6	7.3	32.2	19.3	40.0	20.7	
Vert.	49.154	QP	32.1	11.2	7.4	32.2	18.5	40.0	21.5	
Vert.	55.621	QP	33.5	9.2	7.5	32.2	18.0	40.0	22.0	
Vert.	117.935	QP	29.2	12.7	8.3	32.2	18.0	43.5	25.5	
Vert.	240.000	QP	21.9	12.2	9.5	32.0	11.6	46.0	34.4	
Vert.	960.000	QP	21.0	22.3	13.7	30.6	26.4	46.0	19.6	
Vert.	48300.000	PK	44.3	41.7	-7.3	32.6	46.1	87.9	41.8	
Vert.	72450.000	PK	39.0	41.7	-4.4	21.0	55.3	87.9	32.6	
Vert.	96600.000	PK	45.5	45.6	-9.5	28.7	52.9	73.9	21.0	
Vert.	48300.000	AV	30.4	41.7	-7.3	32.6	32.2	67.9	35.7	NS, VBW 10 Hz Voltage Avg
Vert.	72450.000	AV	26.2	41.7	-4.4	21.0	42.5	67.9	25.4	NS, VBW 10 Hz Voltage Avg
Vert.	96600.000	AV	32.4	45.6	-9.5	28.7	39.8	53.9	14.1	NS, VBW 10 Hz Voltage Avg

Result = Reading + Ant Factor + Loss (Cable+Attenuator+Filter+Mixer(above 50 GHz)+Distance factor(above 1 GHz)) - Gain(Amplifier)

*Other frequency noises omitted in this report were not seen or had enough margin (more than 20 dB).

*NS: No signal detected.

Distance factor: 1 GHz - 10 GHz $20\log(4.5\text{ m} / 3.0\text{ m}) = 3.5\text{ dB}$
10 GHz - 26.5 GHz $20\log(1.0\text{ m} / 3.0\text{ m}) = -9.5\text{ dB}$
26.5 GHz - 50 GHz $20\log(0.5\text{ m} / 3.0\text{ m}) = -15.6\text{ dB}$
50 GHz - 100 GHz $20\log(0.25\text{ m} / 3.0\text{ m}) = -21.6\text{ dB}$

UL Japan, Inc.

Ise EMC Lab.

4383-326 Asama-cho, Ise-shi, Mie-ken 516-0021 JAPAN

Telephone : +81 596 24 8999

Facsimile : +81 596 24 8124

Radiated Spurious Emission
(Reference Plot for band-edge)

Test place	Ise EMC Lab. No. 3 Semi Anechoic Chamber
Report No.	11531217H
Date	January 09, 2017
Temperature / Humidity	24 deg. C / 45 % RH
Engineer	Ryota Yamanaka
Mode	Tx 24.15 GHz, Narrow beam(Right)

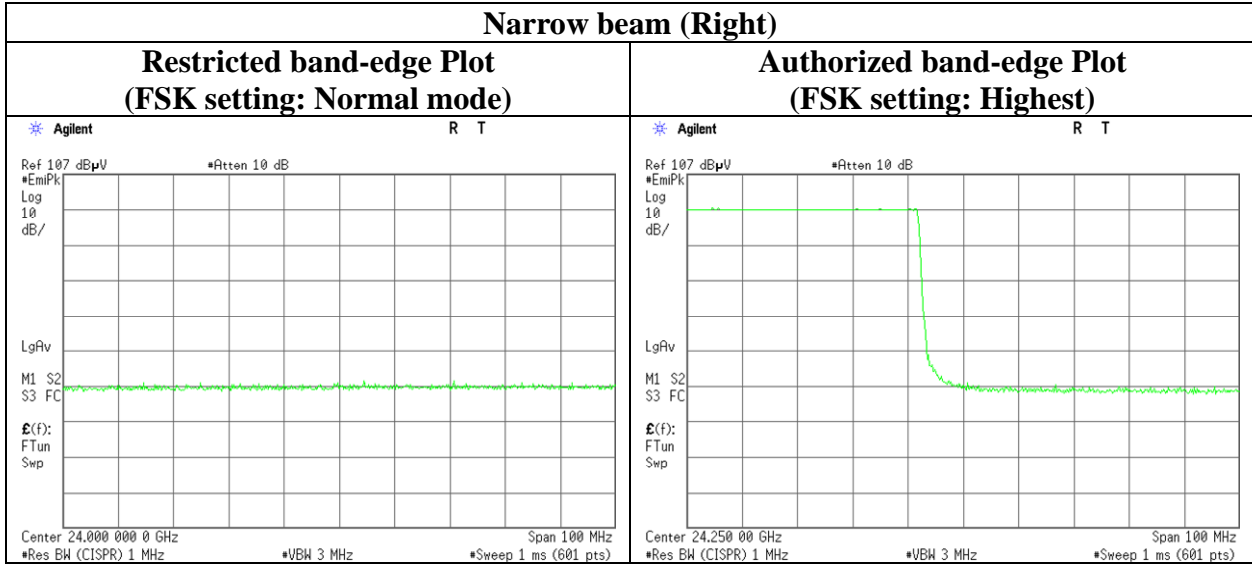

* Final result of restricted band edge was shown in tabular data.

The test was performed on two FSK settings in consideration of the worst case measurement.

Radiated Emission (Electric Field Strength of Fundamental and Spurious Emission)

Report No.	11531217H		
Test place	Ise EMC Lab.		
Semi Anechoic Chamber	No. 3	No. 3	No. 3
Date	January 09, 2017	January 10, 2017	January 11, 2017
Temperature / Humidity	24 deg. C / 45 % RH	24 deg. C / 46 % RH	24 deg. C / 48 % RH
	10 GHz - 40 GHz	40 GHz - 100 GHz	9 kHz - 10 GHz
Engineer	Ryota Yamanaka		
Mode	Tx 24.15 GHz, Narrow beam(Right)		

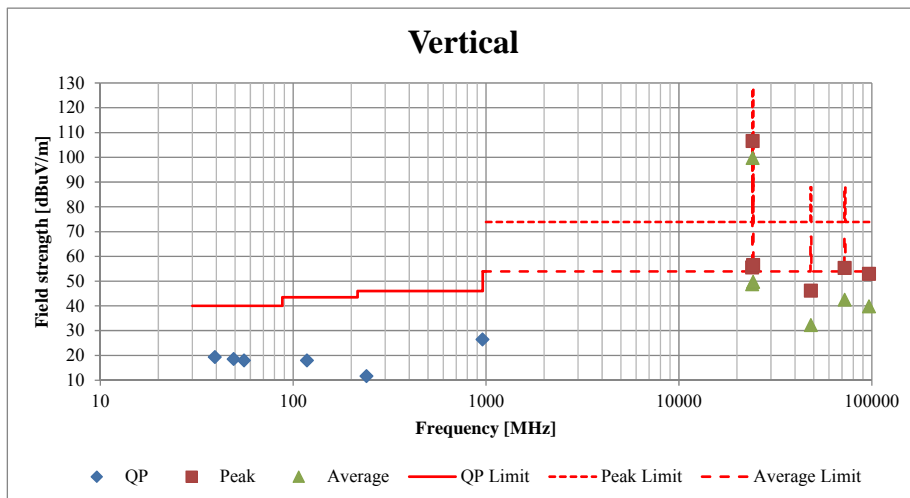
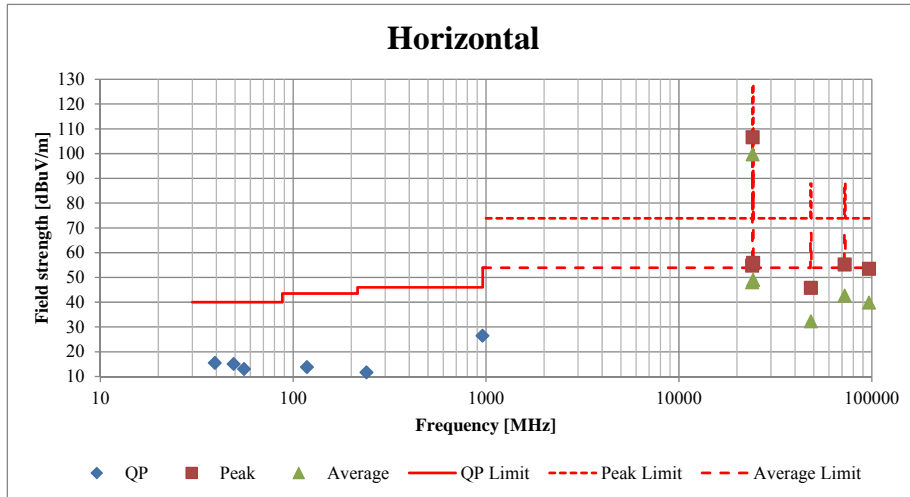

20dB Bandwidth, 99% Occupied Bandwidth

Test place : Ise EMC Lab. No. 3 Semi Anechoic Chamber
Report No. : 11531217H
Date : January 09, 2017
Temperature / Humidity : 24 deg. C / 45 % RH
Engineer : Ryota Yamanaka
Mode : Tx 24.15 GHz, Broad beam

Frequency [GHz]	FSK setting	20 dB Bandwidth [MHz]	99% Occupied Bandwidth [MHz]
24.15	Normal mode	187.949	183.1494
24.15	Highest	189.698	184.3637

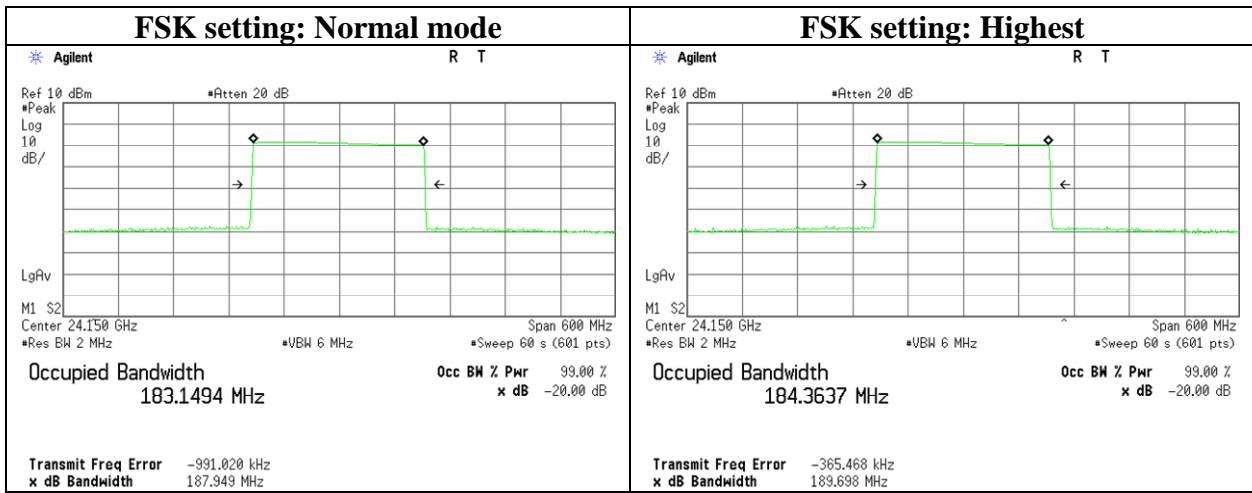

20dB Bandwidth, 99% Occupied Bandwidth

Test place : Ise EMC Lab. No. 3 Semi Anechoic Chamber
Report No. : 11531217H
Date : January 09, 2017
Temperature / Humidity : 24 deg. C / 45 % RH
Engineer : Ryota Yamanaka
Mode : Tx 24.15 GHz, Narrow beam(Left)

Frequency [GHz]	FSK setting	20 dB Bandwidth [MHz]	99% Occupied Bandwidth [MHz]
24.15	Normal mode	188.846	183.1535
24.15	Highest	190.255	184.2320

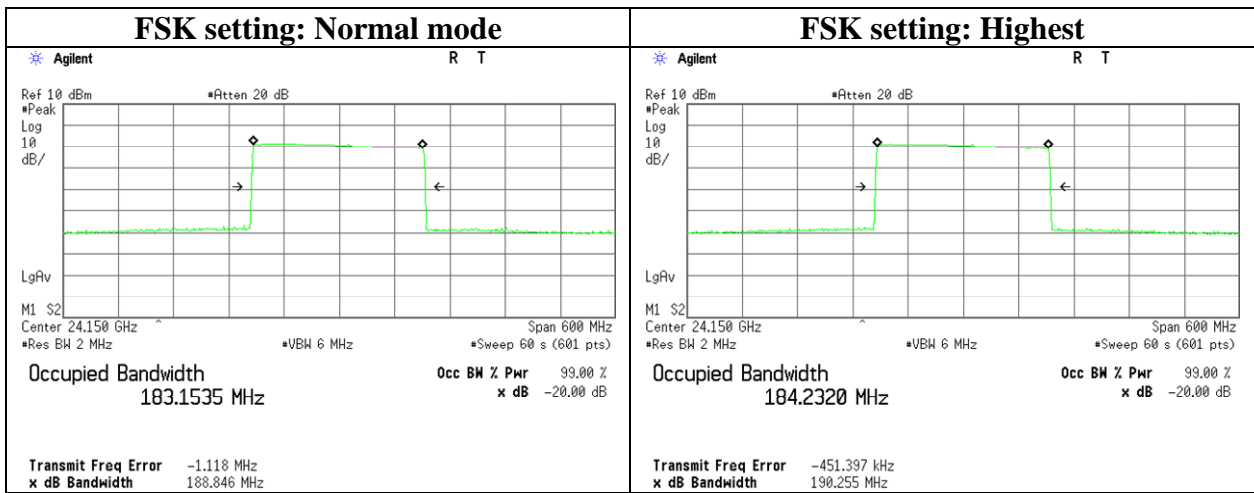

20dB Bandwidth, 99% Occupied Bandwidth

Test place : Ise EMC Lab. No. 3 Semi Anechoic Chamber
Report No. : 11531217H
Date : January 09, 2017
Temperature / Humidity : 24 deg. C / 45 % RH
Engineer : Ryota Yamanaka
Mode : Tx 24.15 GHz, Narrow beam(Right)

Frequency [GHz]	FSK setting	20 dB Bandwidth [MHz]	99% Occupied Bandwidth [MHz]
24.15	Normal mode	188.609	183.0303
24.15	Highest	190.301	184.3502

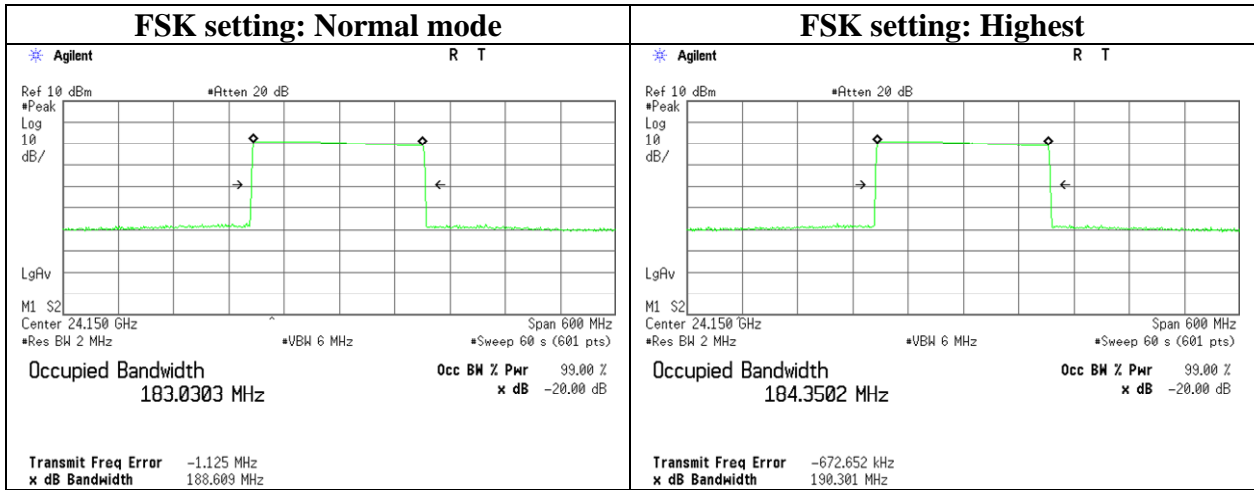

Duty Cycle

Test place	Ise EMC Lab. No. 3 Semi Anechoic Chamber
Report No.	11531217H
Date	January 11, 2017
Temperature / Humidity	24 deg. C / 48 % RH
Engineer	Ryota Yamanaka
Mode	Tx 24.15 GHz

Mode	Tx On time [ms]	Tx On + Off time [ms]	Duty factor [dB]
Broad beam	36.446	79.999	-6.83
Narrow beam (Left)	36.428	79.999	-6.83
Narrow beam (Right)	36.477	79.999	-6.82
Declared	36.400	80.000	-6.84

$$\text{Duty factor} = 20 * \log (\text{Tx On time} / \text{Tx On} + \text{Off time})$$

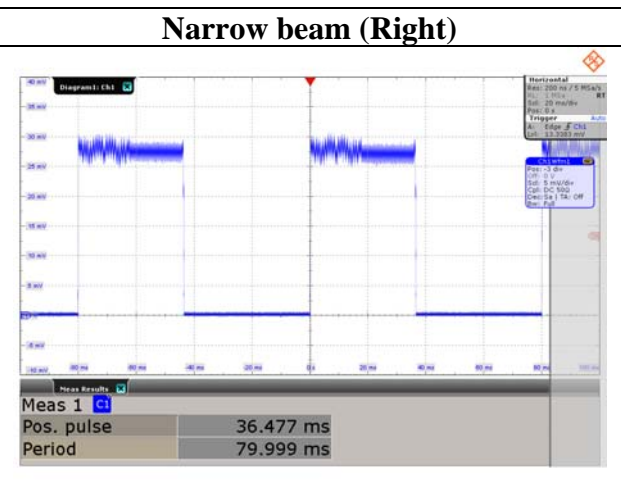
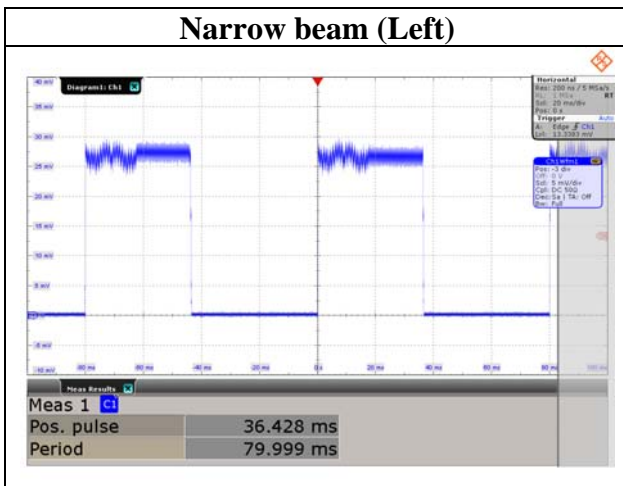
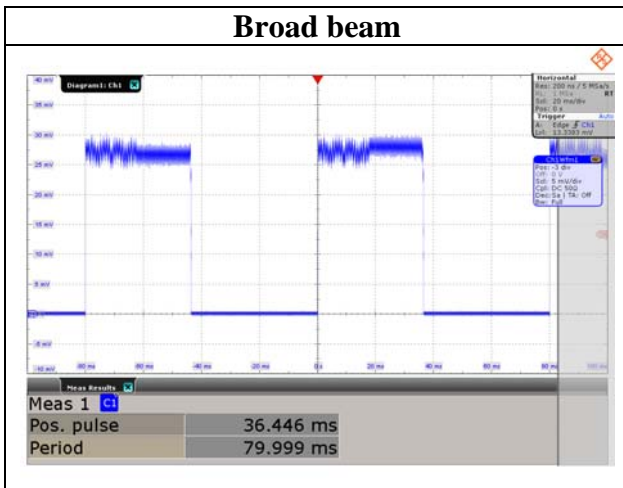

The declared duty factor and measured one were compared. The maximum duty factor of these results was applied to the average field strength measurement. (Worst case)

UL Japan, Inc.

Ise EMC Lab.

4383-326 Asama-cho, Ise-shi, Mie-ken 516-0021 JAPAN

Telephone : +81 596 24 8999

Facsimile : +81 596 24 8124

APPENDIX 2: Test Instruments

EMI test equipment (1/2)

Control No.	Instrument	Manufacturer	Model No	Serial No	Test Item	Calibration Date * Interval(month)
MAEC-03	Semi Anechoic Chamber(NSA)	TDK	Semi Anechoic Chamber 3m	DA-10005	RE	2016/10/20 * 12
MOS-13	Thermo-Hygrometer	Custom	CTH-180	1301	RE	2016/01/21 * 12
MJM-16	Measure	KOMELON	KMC-36	-	RE	-
COTS-MEMI	EMI measurement program	TSJ	TEPTO-DV	-	RE	-
MSA-10	Spectrum Analyzer	Agilent	E4448A	MY46180655	RE	2016/08/17 * 12
MHA-20	Horn Antenna 1-18GHz	Schwarzbeck	BBHA9120D	258	RE	2016/05/29 * 12
MCC-167	Microwave Cable	Junkosha	MWX221	1404S374(1m) / 1405S074(5m)	RE	2016/05/20 * 12
MPA-11	MicroWave System Amplifier	Agilent	83017A	MY39500779	RE	2016/03/24 * 12
MHA-02	Horn Antenna 18-26.5GHz	EMCO	3160-09	1265	RE	2016/02/29 * 12
MMM-08	DIGITAL HiTESTER	Hioki	3805	051201197	RE	2016/01/13 * 12
MHA-04	Horn Antenna 26.5-40GHz	EMCO	3160-10	1140	RE	2016/11/24 * 12
MCC-140	Microwave Cable	Junkosha	J12J101596-00	JAN-31-12-001	RE	2016/02/16 * 12
MPA-03	Microwave System Power Amplifier	Agilent	83050A	MY39500610	RE	2016/10/03 * 12
MHA-31	Horn Antenna	Oshima Prototype Engineering Co.	A16-186	1	RE	2016/09/01 * 12
MPA-25	Power Amplifier	SAGE Millimeter, Inc.	SBP-4035033018-2F2F-S1	12559-01	RE	2016/11/08 * 12
MHA-09	Horn Antenna	WiseWave	ARH1523-02	10766-01	RE	2016/10/18 * 12
MPA-23	Power Amplifier	SAGE Millimeter, Inc.	SBP-5037532015-1515-N1	11599-01	RE	2016/12/26 * 12
MRENT-131	Preselected Millimeter Mixer	Agilent	11974V	MY30013051	RE	2016/06/27 * 12
MCC-135	Microwave Cable	HUBER+SUHNER	SUCOFLEX102	37511/2	RE	2016/08/03 * 12
MCC-136	Microwave Cable	HUBER+SUHNER	SUCOFLEX102	37512/2	RE	2016/08/03 * 12
MPA-13	Pre Amplifier	SONOMA INSTRUMENT	310	260834	RE	2016/03/24 * 12
MCC-177	Microwave Cable	Junkosha	MMX221-00500DMSDMS	1502S304	DECT	2016/03/10 * 12
MHA-11	Horn Antenna	WiseWave	ARH1023-02	10766-01	RE	2016/10/18 * 12
MPA-18	Pre Amplifier	AmTechs Corporation	LNA-7511025	9601	RE	2016/08/19 * 12
MMX-02	Harmonic Mixer	Agilent	11970W	2521 A01909	RE	2016/06/20 * 12
MTR-08	Test Receiver	Rohde & Schwarz	ESCI	100767	RE	2016/09/15 * 12
MBA-03	Biconical Antenna	Schwarzbeck	BBA9106	1915	RE	2016/10/15 * 12
MLA-22	Logperiodic Antenna(200-1000MHz)	Schwarzbeck	VUSLP9111B	911B-191	RE	2016/01/30 * 12
MCC-51	Coaxial cable	UL Japan	-	-	RE	2016/07/26 * 12
MAT-98	Attenuator	KEYSIGHT	8491A	MY52462349	RE	2016/12/05 * 12

UL Japan, Inc.

Ise EMC Lab.

4383-326 Asama-cho, Ise-shi, Mie-ken 516-0021 JAPAN

Telephone : +81 596 24 8999

Facsimile : +81 596 24 8124

EMI test equipment (2/2)

Control No.	Instrument	Manufacturer	Model No	Serial No	Test Item	Calibration Date * Interval(month)
MLPA-01	Loop Antenna	Rohde & Schwarz	HFH2-Z2	100017	RE	2016/10/14 * 12
MCC-112	Coaxial cable	Fujikura/Suhner/TSJ	5D-2W(10m)/ SFM141(3m)/ suoform141-PE(1m)/ 421-010(1.5m)/ RFM-E321(Switcher)	-/00640	RE	2016/07/26 * 12
MCC-143	Coaxial Cable	UL Japan	-	-	RE	2016/06/20 * 12
OSC-01	Digital Oscilloscope	Rohde & Schwarz	RTO1004	200355	RE	2016/08/12 * 12
MDT-05	Detector	HEROTEK, INC.	DT1840P	484823	RE	Pre Check

The expiration date of the calibration is the end of the expired month.

[Below 40 GHz]

All equipment is calibrated with valid calibrations. Each measurement data is traceable to the national or international standards.

[Above 40 GHz]

Acceptance criteria for untraceable equipment was formulated according to ISO/IEC 17025 5.6.2.2.2, and the regular inspection was performed based on it annually.

For 40 GHz – 110 GHz, power sensor is calibrated by manufacturer, and the measured calibration data is used as in-house reference. The calibration data by manufacturer is checked for acceptance by a calorie meter except for some frequency bands. Electric power is checked with the calorie meter by measuring resistance and voltage of reference resistor.

As for some calibrations performed after the tested dates, those test equipment have been controlled by means of an unbroken chains of calibrations.

Test Item:

RE: Radiated emission, Bandwidth and Duty cycle tests

UL Japan, Inc.

Ise EMC Lab.

4383-326 Asama-cho, Ise-shi, Mie-ken 516-0021 JAPAN

Telephone : +81 596 24 8999

Facsimile : +81 596 24 8124