

RADIO TEST REPORT

Test Report No. 14839031H-A-R2

Customer	DENSO CORPORATION
Description of EUT	Cockpit Control Unit
Model Number of EUT	DNNS137
FCC ID	HYQDNNS137
Test Regulation	FCC Part 15 Subpart C
Test Result	Complied
Issue Date	June 24, 2024
Remarks	Wireless LAN (2.4 GHz band) part(s)

Representative Test Engineer



Shousei Hamaguchi
Engineer

Approved By



Ryota Yamanaka
Engineer



CERTIFICATE 5107.02

- The testing in which "Non-accreditation" is displayed is outside the accreditation scopes in UL Japan, Inc.
 There is no testing item of "Non-accreditation".

Report Cover Page - Form-ULID-003532 (DCS:13-EM-F0429) Issue# 23.0

ANNOUNCEMENT

- This test report shall not be reproduced in full or partial, without the written approval of UL Japan, Inc.
- The results in this report apply only to the sample tested. (Laboratory was not involved in sampling.)
- This sample tested is in compliance with the limits of the above regulation.
- The test results in this test report are traceable to the national or international standards.
- This test report must not be used by the customer to claim product certification, approval, or endorsement by the A2LA accreditation body.
- This test report covers Radio technical requirements.
It does not cover administrative issues such as Manual or non-Radio test related Requirements. (if applicable)
- The all test items in this test report are conducted by UL Japan, Inc. Ise EMC Lab.
- The opinions and the interpretations to the result of the description in this report are outside scopes where UL Japan, Inc. has been accredited.
- The information provided by the customer for this report is identified in SECTION 1.
- The laboratory is not responsible for information provided by the customer which can impact the validity of the results.
- For test report(s) referred in this report, the latest version (including any revisions) is always referred.

REVISION HISTORY

Original Test Report No.: 14839031H-A

This report is a revised version of 14839031H-A-R1. 14839031H-A-R1 is replaced with this report.

Revision	Test Report No.	Date	Page Revised Contents
- (Original)	14839031H-A	April 23, 2024	-
1	14839031H-A-R1	June 4, 2024	Correction of the following items in Radio Specification for Clause 2.2; - Antenna gain for WLAN - FM frequency for Broadcast
1	14839031H-A-R1	June 4, 2024	Correction of the FCC Part 15.203 Antenna requirement in Clause 3.2.
1	14839031H-A-R1	June 4, 2024	Replace of the Radiated Spurious Emission test data (Tx 11n-20 2412 MHz).
1	14839031H-A-R1	June 4, 2024	Change the Antenna Gain for Maximum Peak Output Power test data; from 0.58 to 2.19
1	14839031H-A-R1	June 4, 2024	Change the Antenna Gain for Conducted Spurious Emission test data; from 2.0 to 2.2
2	14839031H-A-R2	June 24, 2024	Correction of the RBDS frequency for Broadcast in Radio Specification for Clause 2.2
2	14839031H-A-R2	June 24, 2024	Correction of the test data due to correction of calculation formula in Maximum Peak Output Power (for Tx 11n-20/11n-40)

Reference: Abbreviations (Including words undescribed in this report)

A2LA	The American Association for Laboratory Accreditation	ICES	Interference-Causing Equipment Standard
AC	Alternating Current	IEC	International Electrotechnical Commission
AFH	Adaptive Frequency Hopping	IEEE	Institute of Electrical and Electronics Engineers
AM	Amplitude Modulation	IF	Intermediate Frequency
Amp, AMP	Amplifier	ILAC	International Laboratory Accreditation Conference
ANSI	American National Standards Institute	ISED	Innovation, Science and Economic Development Canada
Ant, ANT	Antenna	ISO	International Organization for Standardization
AP	Access Point	JAB	Japan Accreditation Board
ASK	Amplitude Shift Keying	LAN	Local Area Network
Atten., ATT	Attenuator	LIMS	Laboratory Information Management System
AV	Average	MCS	Modulation and Coding Scheme
BPSK	Binary Phase-Shift Keying	MRA	Mutual Recognition Arrangement
BR	Bluetooth Basic Rate	N/A	Not Applicable
BT	Bluetooth	NIST	National Institute of Standards and Technology
BT LE	Bluetooth Low Energy	NS	No signal detect.
BW	BandWidth	NSA	Normalized Site Attenuation
Cal Int	Calibration Interval	NVLAP	National Voluntary Laboratory Accreditation Program
CCK	Complementary Code Keying	OBW	Occupied Band Width
Ch., CH	Channel	OFDM	Orthogonal Frequency Division Multiplexing
CISPR	Comite International Special des Perturbations Radioelectriques	P/M	Power meter
CW	Continuous Wave	PCB	Printed Circuit Board
DBPSK	Differential BPSK	PER	Packet Error Rate
DC	Direct Current	PHY	Physical Layer
D-factor	Distance factor	PK	Peak
DFS	Dynamic Frequency Selection	PN	Pseudo random Noise
DQPSK	Differential QPSK	PRBS	Pseudo-Random Bit Sequence
DSSS	Direct Sequence Spread Spectrum	PSD	Power Spectral Density
EDR	Enhanced Data Rate	QAM	Quadrature Amplitude Modulation
EIRP, e.i.r.p.	Equivalent Isotropically Radiated Power	QP	Quasi-Peak
EMC	ElectroMagnetic Compatibility	QPSK	Quadri-Phase Shift Keying
EMI	ElectroMagnetic Interference	RBW	Resolution Band Width
EN	European Norm	RDS	Radio Data System
ERP, e.r.p.	Effective Radiated Power	RE	Radio Equipment
EU	European Union	RF	Radio Frequency
EUT	Equipment Under Test	RMS	Root Mean Square
Fac.	Factor	RSS	Radio Standards Specifications
FCC	Federal Communications Commission	Rx	Receiving
FHSS	Frequency Hopping Spread Spectrum	SA, S/A	Spectrum Analyzer
FM	Frequency Modulation	SG	Signal Generator
Freq.	Frequency	SVSWR	Site-Voltage Standing Wave Ratio
FSK	Frequency Shift Keying	TR	Test Receiver
GFSK	Gaussian Frequency-Shift Keying	Tx	Transmitting
GNSS	Global Navigation Satellite System	VBW	Video BandWidth
GPS	Global Positioning System	Vert.	Vertical
Hori.	Horizontal	WLAN	Wireless LAN

CONTENTS	PAGE
SECTION 1: Customer Information	5
SECTION 2: Equipment Under Test (EUT).....	5
SECTION 3: Test Specification, Procedures & Results	7
SECTION 4: Operation of EUT during testing	10
SECTION 5: Radiated Spurious Emission.....	15
SECTION 6: Antenna Terminal Conducted Tests	17
APPENDIX 1: Test Data	18
99 % Occupied Bandwidth and 6 dB Bandwidth.....	18
Maximum Peak Output Power	25
Average Output Power.....	29
Burst rate confirmation.....	32
Radiated Spurious Emission.....	34
Conducted Spurious Emission.....	55
Power Density	56
APPENDIX 2: Test Instruments	62
APPENDIX 3: Photographs of Test Setup	64
Radiated Spurious Emission.....	64
Antenna Terminal Conducted Tests	65

SECTION 1: Customer Information

Company Name	DENSO CORPORATION
Address	1-1, Showa-cho, Kariya-shi, Aichi-ken, 448-8661, Japan
Telephone Number	+81-566-26-5879
Contact Person	Takehiro Abeta

The information provided by the customer is as follows;

- Customer, Description of EUT, Model Number of EUT, FCC ID on the cover and other relevant pages
- Operating/Test Mode(s) (Mode(s)) on all the relevant pages
- SECTION 1: Customer Information
- SECTION 2: Equipment Under Test (EUT) other than the Receipt Date and Test Date
- SECTION 4: Operation of EUT during testing

SECTION 2: Equipment Under Test (EUT)

2.1 Identification of EUT

Description	Cockpit Control Unit
Model Number	DNNS137
Serial Number	Refer to SECTION 4.2
Condition	Production prototype (Not for Sale: This sample is equivalent to mass-produced items.)
Modification	No Modification by the test lab
Receipt Date	March 14, 2024
Test Date	March 21 to April 2, 2024

2.2 Product Description

General Specification

Rating	DC 13.2 V VDD DC 1.8 V, 3.3 V, 2.2 V
Operating temperature	5 deg. C to 35 deg. C

Radio Specification (1/2)

This report contains data provided by the customer which can impact the validity of results. UL Japan, Inc. is only responsible for the validity of results after the integration of the data provided by the customer. The data provided by the customer is marked "a)" in the table below.

WLAN (IEEE802.11b/11g/11n-20/n-40)

Equipment Type	Transceiver	
Frequency of Operation	20 MHz Band: 2412 MHz to 2462 MHz	
	40 MHz Band: 2432 MHz to 2452 MHz	
Type of Modulation	DSSS (CCK, DQPSK, DBPSK) OFDM (64QAM, 16QAM, QPSK, BPSK, 256QAM)	
Antenna Type	Inverted F Antenna	
Antenna Gain ^{a)}	Antenna 0:	0.71 dBi (Peak) (for Right)
	Antenna 1:	2.19 dBi (Peak) (for Left)

Radio Specification (2/2)

Bluetooth (BR / EDR)

Equipment Type	Transceiver	
Frequency of Operation	2402 MHz to 2480 MHz	
Type of Modulation	FHSS (GFSK, $\pi/4$ DQPSK, 8 DPSK)	
Antenna Type	Inverted F Antenna	
Antenna Gain	0.71 dBi (Peak) (for Right)	

WLAN (IEEE802.11a/11n-20/11ac-20/11n-40/11ac-40/11ac-80)

Equipment Type	Transceiver	
Frequency of Operation	20 MHz Band	5180 MHz to 5240 MHz 5745 MHz to 5825 MHz
	40 MHz Band	5190 MHz to 5230 MHz 5755 MHz to 5795 MHz
	80 MHz Band	5210 MHz 5775 MHz
Type of Modulation	OFDM (64QAM, 16QAM, QPSK, BPSK, 256QAM)	
Antenna Type	Inverted F Antenna	
Antenna Gain	Antenna 0:	1.66 dBi (Peak) (for Right)
	Antenna 1:	4.04 dBi (Peak) (for Left)

GNSS

Equipment Type	Receiver	
Frequency of Operation	GPS: 1575.42MHz GLONASS: 1598.0625 MHz to 1605.375 MHz	
Type of Modulation	BPSK	

Broadcast

Equipment Type	Receiver	
Frequency of Operation	AM: 522 kHz to 1710 kHz FM: 87.75 MHz to 107.9 MHz RBDS: 87.75 MHz to 107.9 MHz XM: 2333.465 MHz to 2344.045 MHz	

SECTION 3: Test Specification, Procedures & Results

3.1 Test Specification

Test Specification	FCC Part 15 Subpart C The latest version on the first day of the testing period
Title	FCC 47 CFR Part 15 Radio Frequency Device Subpart C Intentional Radiators Section 15.207 Conducted limits Section 15.247 Operation within the bands 902-928 MHz, 2400-2483.5 MHz, and 5725-5850 MHz

* Also the EUT complies with FCC Part 15 Subpart B.

3.2 Procedures and Results

Item	Test Procedure	Specification	Worst Margin	Results	Remarks
Conducted Emission	FCC: ANSI C63.10-2013 6. Standard test methods	FCC: Section 15.207	-	N/A	*1)
	ISED: RSS-Gen 8.8	ISED: RSS-Gen 8.8			
6dB Bandwidth	FCC: KDB 558074 D01 15.247 Meas Guidance v05r02	FCC: Section 15.247(a)(2)	See data.	Complied	Conducted
	ISED: -	ISED: RSS-247 5.2(a)			
Maximum Peak Output Power	FCC: KDB 558074 D01 15.247 Meas Guidance v05r02	FCC: Section 15.247(b)(3)		Complied	Conducted
	ISED: RSS-Gen 6.12	ISED: RSS-247 5.4(d)			
Power Density	FCC: KDB 558074 D01 15.247 Meas Guidance v05r02	FCC: Section 15.247(e)		Complied	Conducted
	ISED: -	ISED: RSS-247 5.2(b)			
Spurious Emission Restricted Band Edges	FCC: KDB 558074 D01 15.247 Meas Guidance v05r02	FCC: Section 15.247(d)	11.1 dB 4108.3.00 MHz, Vertical, AV	Complied	Conducted (below 30 MHz)/ Radiated (above 30 MHz) *2)
	ISED: RSS-Gen 6.13	ISED: RSS-247 5.5 RSS-Gen 8.9 RSS-Gen 8.10			
<p>Note: UL Japan, Inc.'s EMI Work Procedures: Work Instructions-ULID-003591 and Work Instructions-ULID-003593. * In case any questions arise about test procedure, ANSI C63.10: 2013 is also referred.</p> <p>*1) The test is not applicable since the EUT is not the device that is designed to be connected to the public utility (AC) power line. *2) Radiated test was selected over 30 MHz based on section 15.247(d) and KDB 558074 D01 15.247 Meas Guidance v05r02 8.5 and 8.6.</p>					

FCC Part 15.31 (e)

This EUT provides the stable voltage constantly to RF part regardless of input voltage.
Therefore, this EUT complies with the requirement.

FCC Part 15.203 Antenna requirement

It is impossible for end users to replace the antenna, because the antenna is mounted inside of the vehicle.

Therefore, the equipment complies with the antenna requirement of Section 15.203.

3.3 Addition to Standard

Item	Test Procedure	Specification	Worst Margin	Results	Remarks
99% Occupied Bandwidth	ISED: RSS-Gen 6.7	ISED: -	N/A	-	Conducted

Other than above, no addition, exclusion nor deviation has been made from the standard.

3.4 Uncertainty

Measurement uncertainty is not taken into account when stating conformity with a specified requirement. Note: When margins obtained from test results are less than the measurement uncertainty, the test results may exceed the limit.

The following uncertainties have been calculated to provide a confidence level of 95 % using a coverage factor $k = 2$.

Radiated emission

Measurement distance	Frequency range	Unit	Calculated Uncertainty (+/-)
3 m	9 kHz to 30 MHz	dB	3.3
10 m		dB	3.1
3 m	30 MHz to 200 MHz	Horizontal	4.7
		Vertical	4.7
	200 MHz to 1000 MHz	Horizontal	4.8
		Vertical	6.0
10 m	30 MHz to 200 MHz	Horizontal	5.2
		Vertical	5.1
	200 MHz to 1000 MHz	Horizontal	5.2
		Vertical	5.2
3 m	1 GHz to 6 GHz	dB	5.0
	6 GHz to 18 GHz	dB	5.2
1 m	10 GHz to 18 GHz	dB	5.3
	18 GHz to 26.5 GHz	dB	5.2
	26.5 GHz to 40 GHz	dB	4.7
0.5 m	26.5 GHz to 40 GHz	dB	4.8

Antenna Terminal Conducted

Item	Unit	Calculated Uncertainty (+/-)
Antenna terminated conducted emission / Power density / Burst power	dB	3.47
Adjacent channel power (ACP)	dB	2.28
Bandwidth (OBW)	%	0.96
Time readout (time span upto 100 msec)	%	0.11
Time readout (time span upto 1000 msec)	%	0.11
Time readout (time span upto 60 sec)	%	0.02
Power measurement (Power meter < 8 GHz)	dB	1.46
Power measurement (Call box < 6 GHz)	dB	1.69
Frequency readout (Frequency counter)	ppm	0.67
Frequency readout (Spectrum analyzer frequency readout function)	ppm	2.13
Temperature (constant temperature bath)	deg. C	0.69
Humidity (constant temperature bath)	%RH	2.98
Modulation characteristics	%	6.93
Frequency for mobile	ppm	0.08
Contention-based protocol	dB	2.26

3.5 Test Location

UL Japan, Inc. Ise EMC Lab.

4383-326 Asama-cho, Ise-shi, Mie-ken 516-0021 Japan

Telephone: +81-596-24-8999

A2LA Certificate Number: 5107.02 / FCC Test Firm Registration Number: 884919

ISED Lab Company Number: 2973C / CAB identifier: JP0002

Test site	Width x Depth x Height (m)	Size of reference ground plane (m) / horizontal conducting plane	Other rooms	Maximum measurement distance
No.1 semi-anechoic chamber	19.2 x 11.2 x 7.7	7.0 x 6.0	No.1 Power source room	10 m
No.2 semi-anechoic chamber	7.5 x 5.8 x 5.2	4.0 x 4.0	-	3 m
No.3 semi-anechoic chamber	12.0 x 8.5 x 5.9	6.8 x 5.75	No.3 Preparation room	3 m
No.3 shielded room	4.0 x 6.0 x 2.7	N/A	-	-
No.4 semi-anechoic chamber	12.0 x 8.5 x 5.9	6.8 x 5.75	No.4 Preparation room	3 m
No.4 shielded room	4.0 x 6.0 x 2.7	N/A	-	-
No.5 semi-anechoic chamber	6.0 x 6.0 x 3.9	6.0 x 6.0	-	-
No.5 measurement room	6.4 x 6.4 x 3.0	6.4 x 6.4	-	-
No.6 shielded room	4.0 x 4.5 x 2.7	4.0 x 4.5	-	-
No.6 measurement room	4.75 x 5.4 x 3.0	4.75 x 4.15	-	-
No.7 shielded room	4.7 x 7.5 x 2.7	4.7 x 7.5	-	-
No.8 measurement room	3.1 x 5.0 x 2.7	3.1 x 5.0	-	-
No.9 measurement room	8.8 x 4.6 x 2.8	2.4 x 2.4	-	-
No.10 shielded room	3.8 x 2.8 x 2.8	3.8 x 2.8	-	-
No.11 measurement room	4.0 x 3.4 x 2.5	N/A	-	-
No.12 measurement room	2.6 x 3.4 x 2.5	N/A	-	-
Large Chamber	16.9 x 22.1 x 10.17	16.9 x 22.1	-	10 m
Small Chamber	5.3 x 6.69 x 3.59	5.3 x 6.69	-	-

3.6 Test Data, Test Instruments, and Test Set Up

Refer to APPENDIX.

SECTION 4: Operation of EUT during testing

4.1 Operating Mode(s)

Mode	Remarks*
IEEE 802.11b (11b)	11 Mbps, PN9
IEEE 802.11g (11g)	54 Mbps, PN9
IEEE 802.11n SISO / MIMO 20 MHz BW (11n-20)	MCS 8 PN9
IEEE 802.11n SISO / MIMO 40 MHz BW (11n-40)	MCS 15 (Long GI), PN9
*The worst condition was determined based on the test result of Maximum Peak Output Power (Mid Channel)	
*Power of the EUT was set by the software as follows; Power Setting: Refer to the following table Software: CCU TEST Program Soc: Version: 20231214 (Date: 2023.12.14, Storage location: EUT memory) VCPU: Version: 20230421 (Date: 2023.04.21, Storage location: EUT memory)	
*This setting of software is the worst case. Any conditions under the normal use do not exceed the condition of setting. In addition, end users cannot change the settings of the output power of the product. Test operating mode was determined as follows according to "Section 1 of 6 802.11 a/b/g/n testing - Managing Complex Regulatory Approvals - " of TCB Council Workshop October 2009.	

[Power setting]

Mode	Power setting
11b	11 dBm
11g	5 dBm
11n-20 (SISO)	5 dBm
11n-40 (SISO)	5 dBm
11n-20 (MIMO)	8 dBm
11n-40 (MIMO)	8 dBm

*The Details of Operating Mode(s)

Test Item	Operating Mode	Tested Antenna	Tested Frequency
Radiated Spurious Emission (Below 1 GHz) Conducted Spurious Emission	Tx 11n-40 *1)	0 to 1 (Simultaneously)	2442 MHz
99% Occupied Bandwidth, 6dB Bandwidth, Maximum Peak Output Power, Radiated Spurious Emission (Above 1 GHz), Power Density	Tx 11b Tx 11g	1	2412 MHz 2437 MHz 2462 MHz
	Tx 11n-20	0 to 1 (Simultaneously)	2412 MHz 2437 MHz 2462 MHz
	Tx 11n-40	0 to 1 (Simultaneously)	2432 MHz 2442 MHz 2452 MHz
*1) The mode was tested as a representative, because it had the highest power at antenna terminal test.			

4.2 Configuration and Peripherals

Antenna Terminal Conducted test

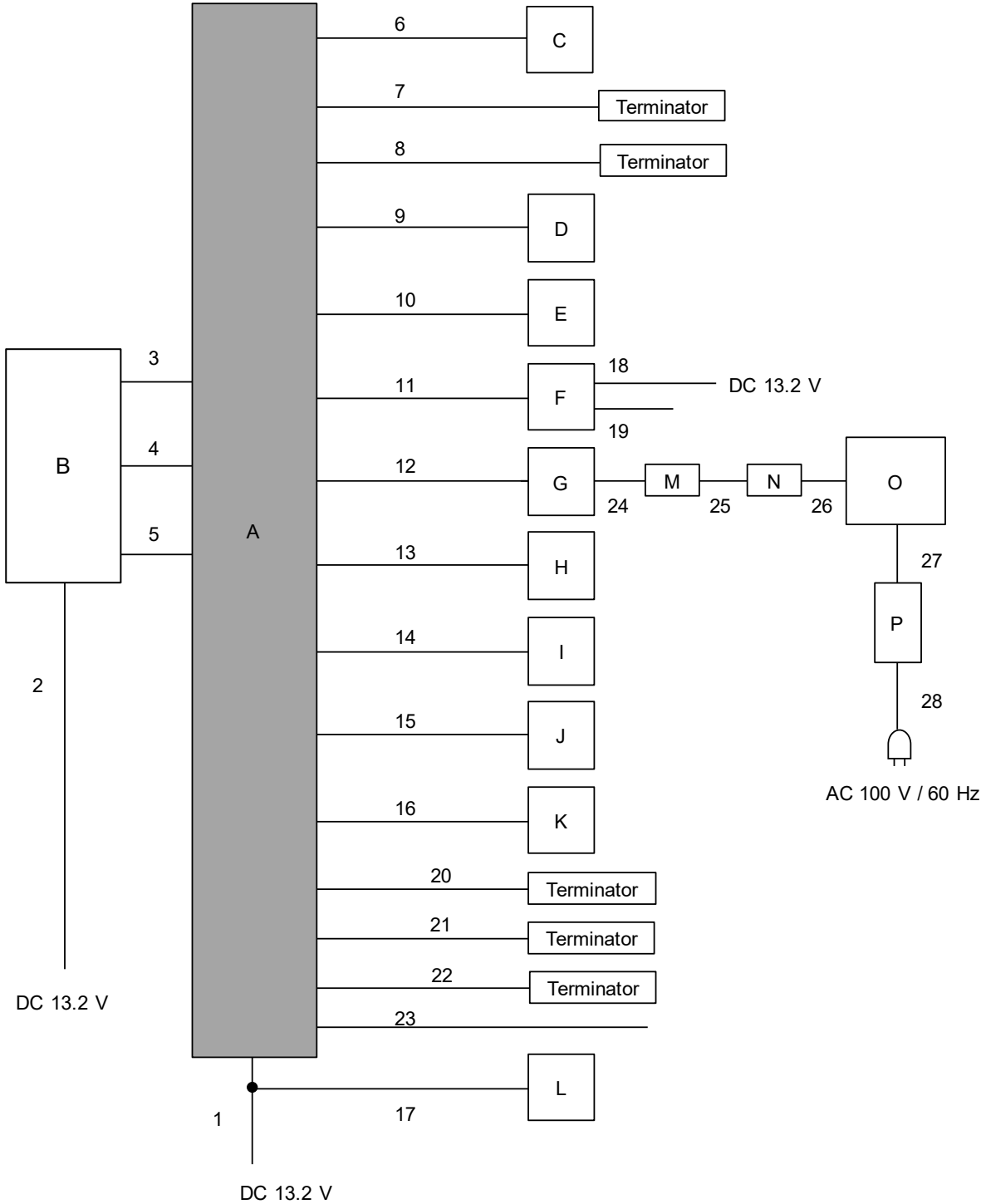

* Cabling and setup(s) were taken into consideration and test data was taken under worse case conditions.

Description of EUT and Support Equipment

No.	Item	Model number	Serial Number	Manufacturer	Remarks
A	Cockpit Control Unit	DNNS137	46872600100000000 0000003	DENSO CORPORATION	EUT
B	Display (CID)	137000-15890001	No.1	DENSO TEN CORPORATION	-
C	GPS Antenna	86277AL000	29550172	SUBARU CORPORATION	-
D	Camera Dummy	MAX96778COAXE VKIT	-	Maxim integrated	-
E	Ether Dummy	EtherBoard	-	DENSO CORPORATION	-
F	METER	5-157500-186	No.S44	DENSO CORPORATION	-
G	USB BOX	TAP8006 cable	No.12	HOSHIDEN	-
H	Speaker	AK-122	-	archill	-
I	Speaker	AK-122	-	archill	-
J	Speaker	AK-122	-	archill	-
K	Speaker	AK-122	-	archill	-
L	HEATER CONTROL Panel	137000-15990005	No.1	DENSO TEN CORPORATION	-
M	USB-LAN Adapter	LUA3-U2-ATX	26495621036190	BUFFALO INC.	-
N	USB-LAN Adapter	LUA3-U2-ATX	26495621036077	BUFFALO INC.	-
O	Laptop PC	X1 Carbon	R9-OH8OBW 15/9	LENOVO	-
P	AC Adapter	ADXL45NCC2A	11S45N0299Z1ZS944 B6KBR	LENOVO	-

List of Cables Used

No.	Name	Length (m)	Shield		Remarks
			Cable	Connector	
1	DC Cable	4.20	Unshielded	Unshielded	-
2	DC Cable	4.30	Unshielded	Unshielded	-
3	Antenna Cable	0.57	Shielded	Shielded	-
4	Antenna Cable	0.57	Shielded	Shielded	-
5	Display Signal Cable	0.57	Shielded	Shielded	-
6	GPS Antenna Cable	1.00	Shielded	Shielded	-
7	Radio Antenna Cable(AM/FM)	2.00	Shielded	Shielded	-
8	Radio Antenna Cable(XM)	2.00	Shielded	Shielded	-
9	Camera Cable	2.00	Shielded	Shielded	-
10	Ether Cable	2.00	Shielded	Shielded	-
11	METER Signal Cable	2.00	Unshielded	Unshielded	-
12	USB BOX Cable	2.00	Shielded	Shielded	-
13	Speaker Cable	6.30	Unshielded	Unshielded	-
14	Speaker Cable	6.30	Unshielded	Unshielded	-
15	Speaker Cable	6.30	Unshielded	Unshielded	-
16	Speaker Cable	6.30	Unshielded	Unshielded	-
17	DC Cable	4.60	Unshielded	Unshielded	-
18	DC Cable	4.60	Unshielded	Unshielded	-
19	Signal Cable	2.00	Unshielded	Unshielded	-
20	Signal Cable	2.00	Unshielded	Unshielded	-
21	Signal Cable	2.00	Unshielded	Unshielded	-
22	Signal Cable	2.00	Unshielded	Unshielded	-
23	Signal Cable	2.00	Unshielded	Unshielded	-
24	USB Cable	0.18	Shielded	Shielded	-
25	LAN Cable	2.00	Shielded	Shielded	-
26	USB Cable	0.18	Shielded	Shielded	-
27	DC Cable	1.70	Unshielded	Unshielded	-
28	AC Cable	1.00	Unshielded	Unshielded	-

Radiated Emission test

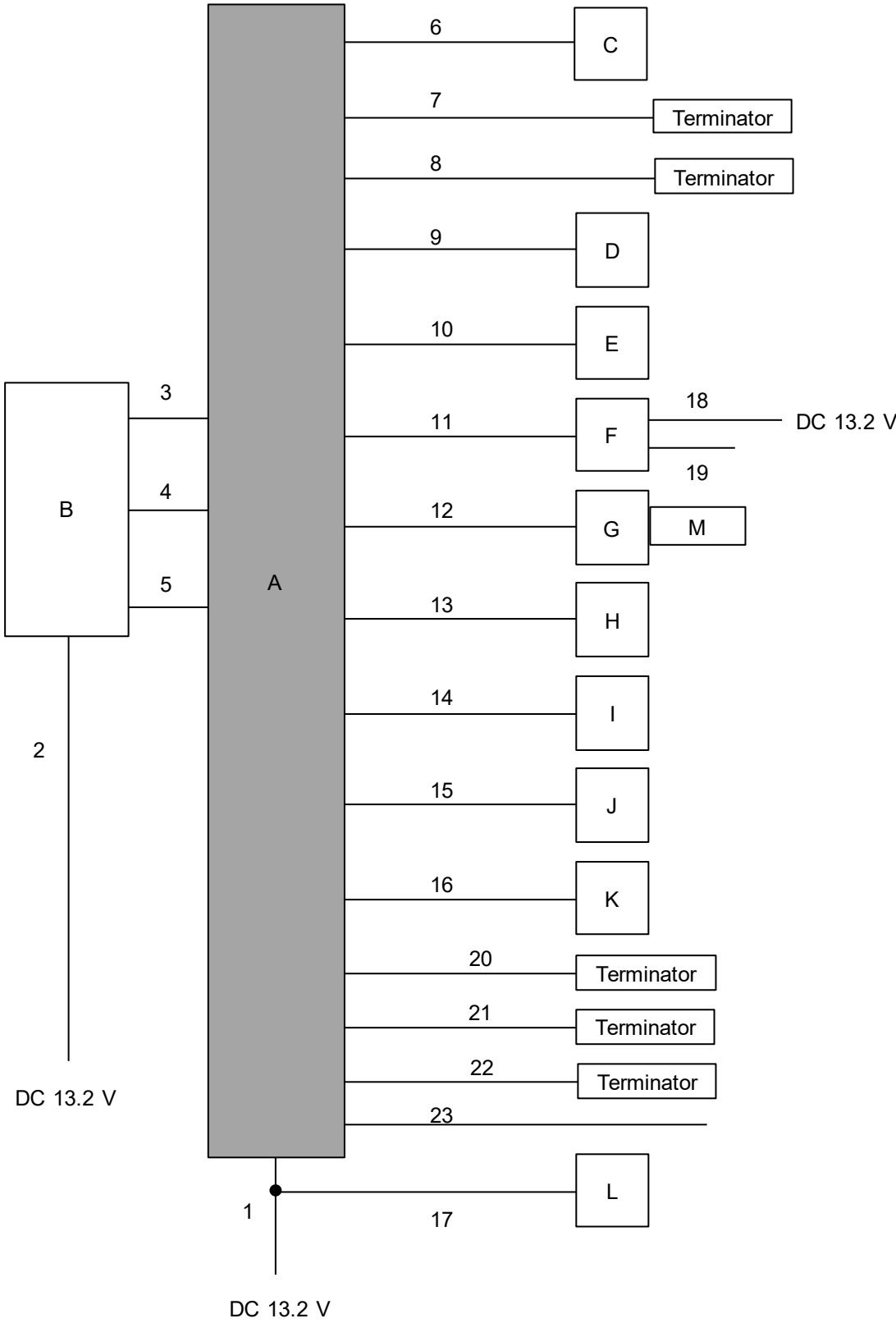

* Cabling and setup(s) were taken into consideration and test data was taken under worse case conditions.

Description of EUT and Support Equipment

No.	Item	Model number	Serial Number	Manufacturer	Remarks
A	Cockpit Control Unit	DNNS137	4687260010000000 00000003	DENSO CORPORATION	EUT
B	Display (CID)	137000-15890001	No.1	DENSO TEN CORPORATION	-
C	GPS Antenna	86277AL000	29550172	SUBARU CORPORATION	-
D	Camera Dummy	MAX96778COAXE VKIT	-	Maxim integrated	-
E	Ether Dummy	EtherBoard	-	DENSO CORPORATION	-
F	METER	5-157500-186	No.S44	DENSO CORPORATION	-
G	USB BOX	TAP8006 cable	No.12	HOSHIDEN	-
H	Speaker	AK-122	-	archill	-
I	Speaker	AK-122	-	archill	-
J	Speaker	AK-122	-	archill	-
K	Speaker	AK-122	-	archill	-
L	HEATER CONTROL Panel	137000-15990005	No.1	DENSO TEN CORPORATION	-
M	USB Memory	RUF3-K16GB	P10416	BUFFALO INC.	-

List of Cables Used

No.	Name	Length (m)	Shield		Remarks
			Cable	Connector	
1	DC Cable	4.20	Unshielded	Unshielded	-
2	DC Cable	4.30	Unshielded	Unshielded	-
3	Antenna Cable	0.57	Shielded	Shielded	-
4	Antenna Cable	0.57	Shielded	Shielded	-
5	Display Signal Cable	0.57	Shielded	Shielded	-
6	GPS Antenna Cable	1.00	Shielded	Shielded	-
7	Radio Antenna Cable(AM/FM)	2.00	Shielded	Shielded	-
8	Radio Antenna Cable(XM)	2.00	Shielded	Shielded	-
9	Camera Cable	2.00	Shielded	Shielded	-
10	Ether Cable	2.00	Shielded	Shielded	-
11	METER Signal Cable	2.00	Unshielded	Unshielded	-
12	USB BOX Cable	2.00	Shielded	Shielded	-
13	Speaker Cable	6.30	Unshielded	Unshielded	-
14	Speaker Cable	6.30	Unshielded	Unshielded	-
15	Speaker Cable	6.30	Unshielded	Unshielded	-
16	Speaker Cable	6.30	Unshielded	Unshielded	-
17	DC Cable	4.60	Unshielded	Unshielded	-
18	DC Cable	4.60	Unshielded	Unshielded	-
19	Signal Cable	2.00	Unshielded	Unshielded	-
20	Signal Cable	2.00	Unshielded	Unshielded	-
21	Signal Cable	2.00	Unshielded	Unshielded	-
22	Signal Cable	2.00	Unshielded	Unshielded	-
23	Signal Cable	2.00	Unshielded	Unshielded	-

SECTION 5: Radiated Spurious Emission

Test Procedure

It was measured based on "8.5 and 8.6 of KDB 558074 D01 15.247 Meas Guidance v05r02".

[For below 1 GHz]

EUT was placed on a urethane platform of nominal size, 1.0 m by 1.5 m, raised 0.8 m above the conducting ground plane. The Radiated Electric Field Strength has been measured in a Semi Anechoic Chamber with a ground plane.

[For above 1 GHz]

EUT was placed on a urethane platform of nominal size, 0.5 m by 0.5 m, raised 1.5 m above the conducting ground plane. The Radiated Electric Field Strength has been measured in a Semi Anechoic Chamber with absorbent materials lined on a ground plane. Test antenna was aimed at the EUT for receiving the maximum signal and always kept within the illumination area of the 3 dB beamwidth of the antenna.

The height of the measuring antenna varied between 1 m and 4 m and EUT was rotated a full revolution in order to obtain the maximum value of the electric field strength.

The measurements were performed for both vertical and horizontal antenna polarization with the Test Receiver, or the Spectrum Analyzer.

The measurements were made with the following detector function of the test receiver and the Spectrum analyzer (in linear mode).

The test was made with the detector (RBW/VBW) in the following table.

When using Spectrum analyzer, the test was made with adjusting span to zero by using peak hold.

Test Antennas are used as below;

Frequency	30 MHz to 200 MHz	200 MHz to 1 GHz	Above 1 GHz
Antenna Type	Biconical	Logperiodic	Horn

In any 100 kHz bandwidth outside the restricted band in which the spread spectrum intentional radiator is operating, the radio frequency power that is produced by the intentional radiator confirmed 20 dB below that in the 100 kHz bandwidth within the band that contains the highest level of the desired power, based on a radiated measurement.

20 dBc was applied to the frequency over the limit of FCC 15.209 / Table 4 of RSS-Gen 8.9(ISED) and outside the restricted band of FCC15.205 / Table 6 of RSS-Gen 8.10 (ISED).

Frequency	Below 1 GHz	Above 1 GHz		20 dBc
Instrument Used	Test Receiver	Spectrum Analyzer		Spectrum Analyzer
Detector	QP	PK	AV	PK
IF Bandwidth	BW 120 kHz	RBW: 1 MHz VBW: 3 MHz	11.12.2.5.1 RBW: 1 MHz VBW: 3 MHz Detector: Power Averaging (RMS) Trace: 100 traces 11.12.2.5.2 The duty cycle was less than 98% for detected noise, a duty factor was added to the 11.12.2.5.1 results.	RBW: 100 kHz VBW: 300 kHz

Figure 2: Test Setup

Below 1 GHz

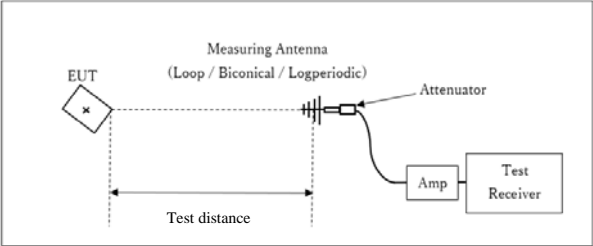

× : Center of turn table

Test Distance: 3 m

1 GHz to 10 GHz

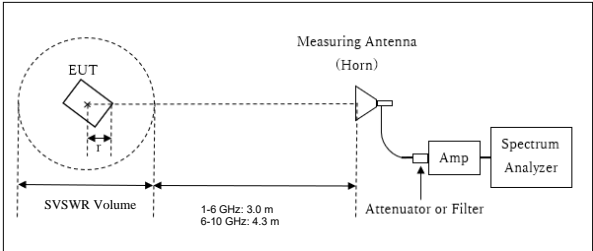

r : Radius of an outer periphery of EUT
 × : Center of turn table

[1 GHz to 6 GHz]
 Distance Factor: $20 \times \log(3.80 \text{ m} / 3.0 \text{ m}) = 2.06 \text{ dB}$
 * Test Distance: $(3 + \text{SVSWR Volume} / 2) - r = 3.8 \text{ m}$

SVSWR Volume : 2.0 m
 (SVSWR Volume has been calibrated based on CISPR 16-1-4.)
 $r = 0.2 \text{ m}$

[6 GHz to 10 GHz]
 Distance Factor: $20 \times \log(4.8 \text{ m} / 3.0 \text{ m}) = 4.09 \text{ dB}$
 * Test Distance: $(4.3 + \text{SVSWR Volume} / 2) - r = 4.8 \text{ m}$

SVSWR Volume : 1.4 m
 (SVSWR Volume has been calibrated based on CISPR 16-1-4.)
 $r = 0.2 \text{ m}$

10 GHz to 26.5 GHz

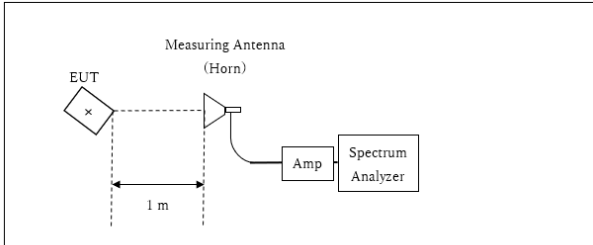

× : Center of turn table

Distance Factor: $20 \times \log(1.0 \text{ m} / 3.0 \text{ m}) = -9.54 \text{ dB}$
 *Test Distance: 1 m

The test was made on EUT at the normal use position.

The test results and limit are rounded off to one decimal place, so some differences might be observed.

Measurement Range : 30 MHz to 26.5 GHz
Test Data : APPENDIX
Test Result : Pass

SECTION 6: Antenna Terminal Conducted Tests

Test Procedure

The tests were made with below setting connected to the antenna port.

Test	Span	RBW	VBW	Sweep time	Detector	Trace	Instrument Used
6dB Bandwidth	20 MHz (11b/g/n-20)	100 kHz	300 kHz	Auto	Peak	Max Hold	Spectrum Analyzer
	40 MHz (11n-40)						
99% Occupied Bandwidth *1)	Enough width to display emission skirts	1 to 5 % of OBW	Three times of RBW	Auto	Peak	Max Hold	Spectrum Analyzer
Maximum Peak Output Power	-	-	-	Auto	Peak/Average *2)	-	Power Meter (Sensor: 50 MHz BW)
Peak Power Density	1.5 times the 6dB Bandwidth	3 kHz	10 kHz	Auto	Peak	Max Hold	Spectrum Analyzer *3)
Conducted Spurious Emission *4) *5)	9 kHz to 150 kHz	200 Hz	620 Hz	Auto	Peak	Max Hold	Spectrum Analyzer
	150 kHz to 30 MHz	10 kHz	30 kHz				

*1) Peak hold was applied as Worst-case measurement.

*2) Reference data

*3) Section 11.10.2 Method PKPSD (peak PSD) of "ANSI C63.10-2013".

*4) In the frequency range below 30MHz, RBW was narrowed to separate the noise contents.

Then, wide-band noise near the limit was checked separately, however the noise was not detected as shown in the chart.

(9 kHz - 150 kHz: RBW = 200 Hz, 150 kHz - 30 MHz: RBW = 9.1 kHz)

*5) The limits in CFR 47, Part 15, Subpart C, paragraph 15.209(a), are identical to those in RSS-Gen section 8.9, Table 6, since the measurements are performed in terms of magnetic field strength and converted to electric field strength levels (as reported in the table) using the free space impedance of 377 Ohms. For example, the measurement at frequency 9 kHz resulted in a level of 45.5 dBuV/m, which is equivalent to $45.5 - 51.5 = -6.0$ dBuA/m, which has the same margin, 3 dB, to the corresponding RSS-Gen Table 6 limit as it has to 15.209(a) limit.

The test results and limit are rounded off to two decimals place, so some differences might be observed. The equipment and cables were not used for factor 0 dB of the data sheets.

Test Data : APPENDIX
Test Result : Pass

APPENDIX 1: Test Data

99 % Occupied Bandwidth and 6 dB Bandwidth

Test place Ise EMC Lab. No.6 Measurement Room
Date April 1, 2024
Temperature / Humidity 24 deg. C / 52 % RH
Engineer Hiroki Numata
Mode Tx

Mode	Frequency [MHz]	99% Occupied Bandwidth [kHz]	6dB Bandwidth [MHz]	Limit for 6dB Bandwidth [MHz]
11b	2412	14143.0	7.652	> 0.5000
	2437	14157.8	7.652	> 0.5000
	2462	14161.0	7.648	> 0.5000
11g	2412	17092.9	16.507	> 0.5000
	2437	17124.4	16.518	> 0.5000
	2462	17122.6	16.518	> 0.5000

Mode	Antenna	Frequency [MHz]	99 % Occupied Bandwidth [kHz]	6 dB Bandwidth [MHz]	Limit for 6 dB Bandwidth [MHz]
11n-20	0	2412	17965.8	15.063	> 0.5000
		2437	17974.2	15.068	> 0.5000
		2462	17959.7	15.080	> 0.5000
	1	2412	17783.5	15.053	> 0.5000
		2437	17781.2	15.045	> 0.5000
		2462	17791.0	15.076	> 0.5000
11n-40	0	2432	37015.6	36.475	> 0.5000
		2442	36987.3	36.487	> 0.5000
		2452	36997.6	36.467	> 0.5000
	1	2432	37125.3	36.466	> 0.5000
		2442	37188.6	36.421	> 0.5000
		2452	37175.8	36.443	> 0.5000

99 % Occupied Bandwidth and 6 dB Bandwidth

11b

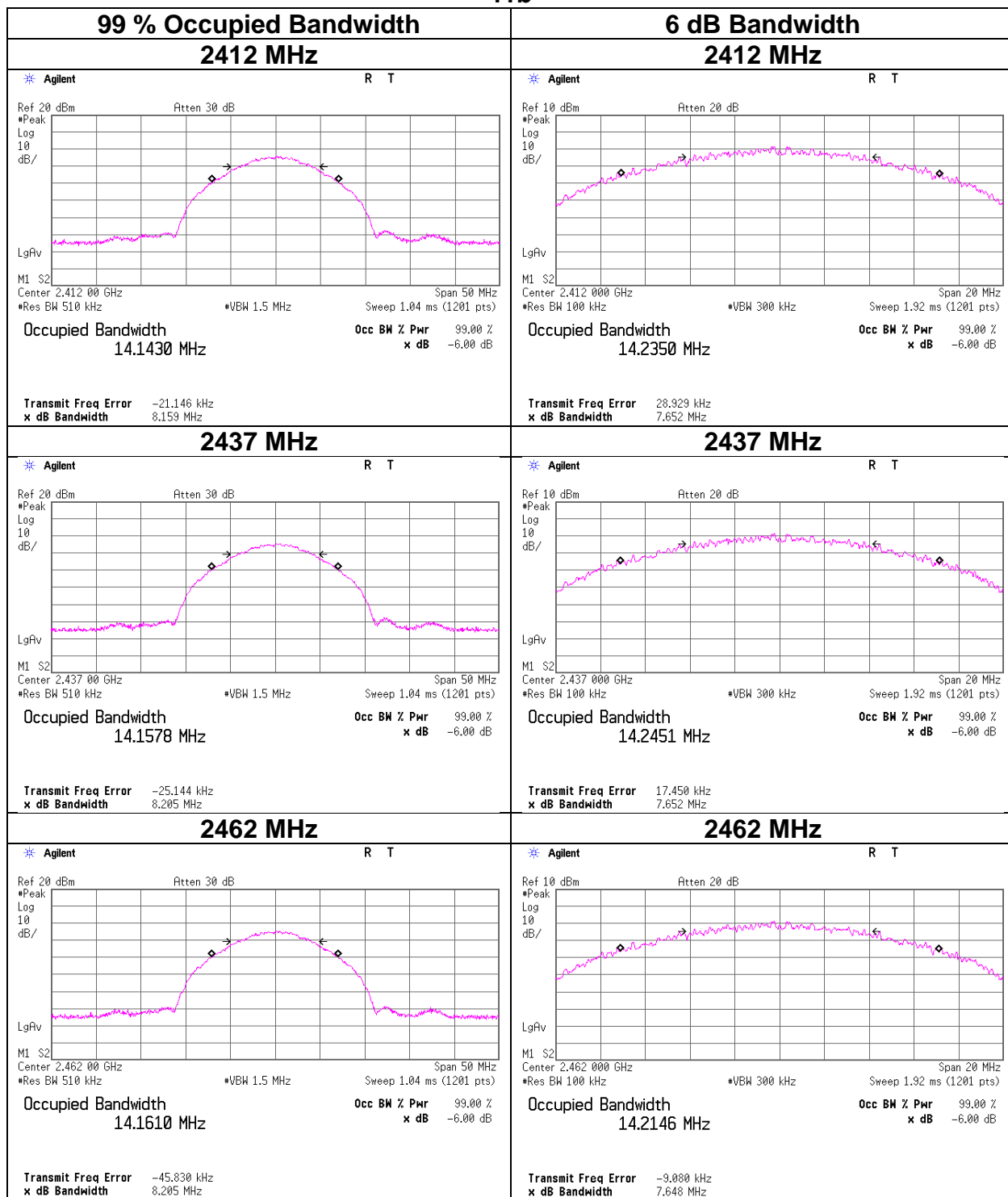

99 % Occupied Bandwidth and 6 dB Bandwidth

11g

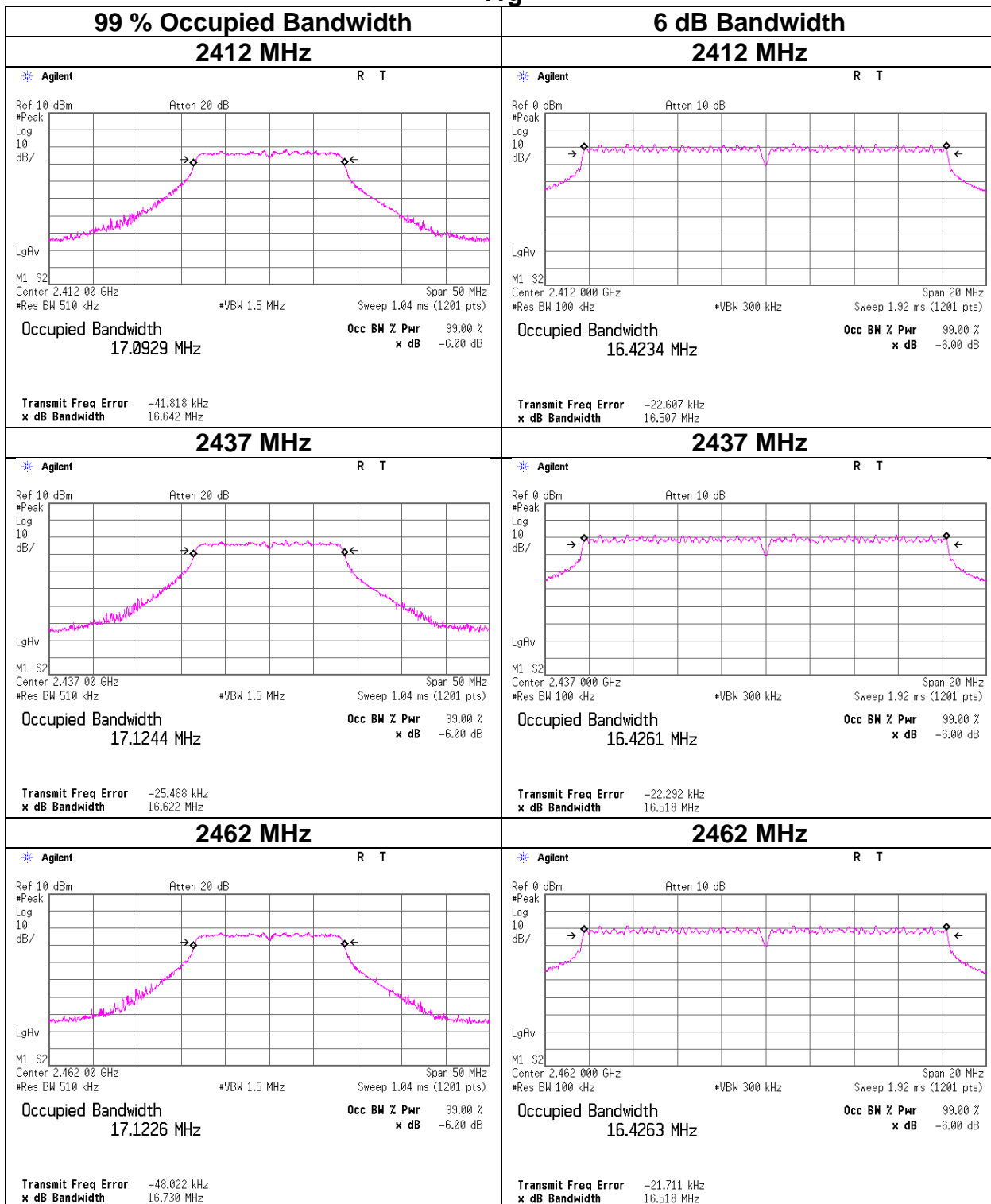

99 % Occupied Bandwidth and 6 dB Bandwidth

11n-20 Antenna 0

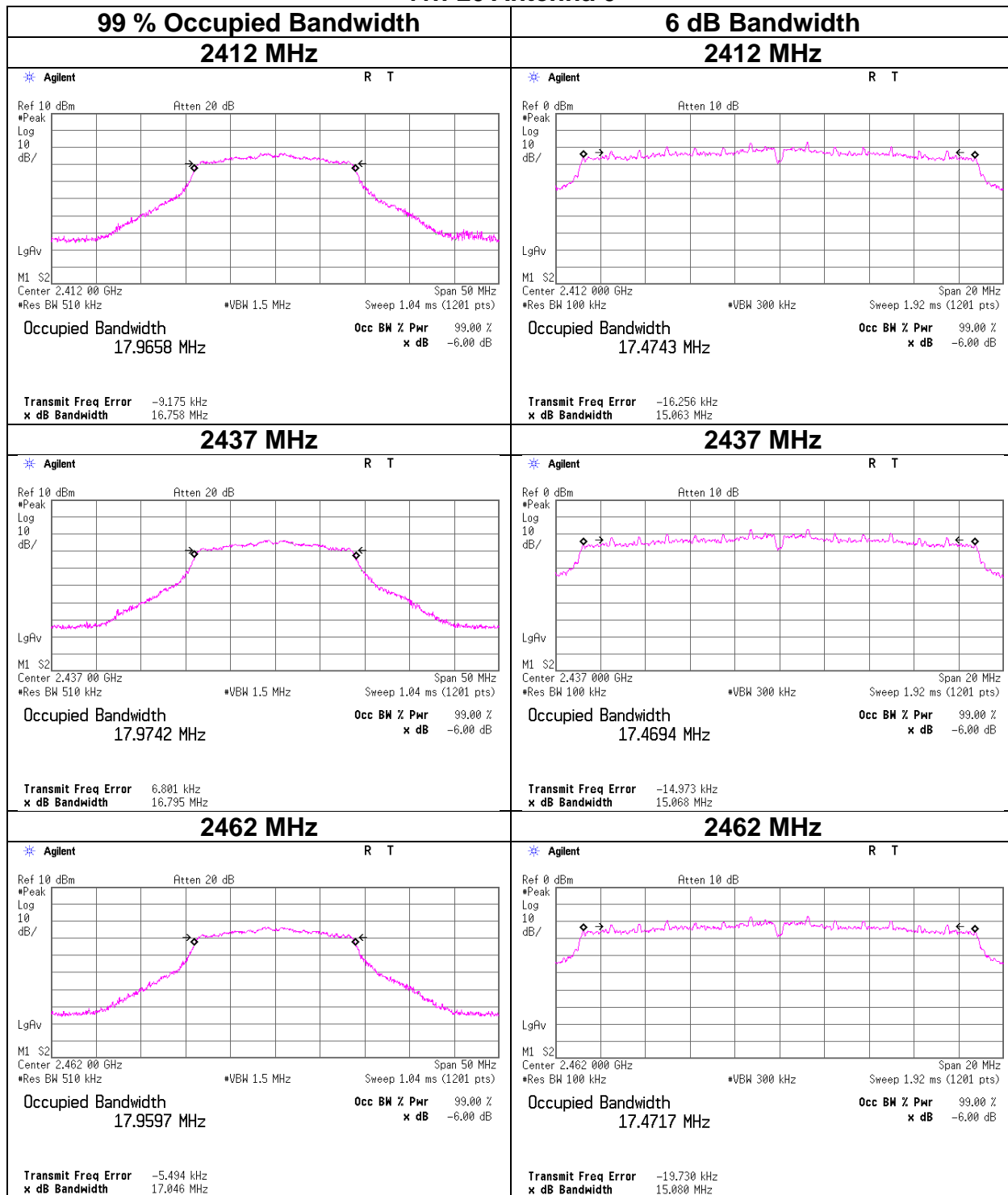

99 % Occupied Bandwidth and 6 dB Bandwidth

11n-20 Antenna 1

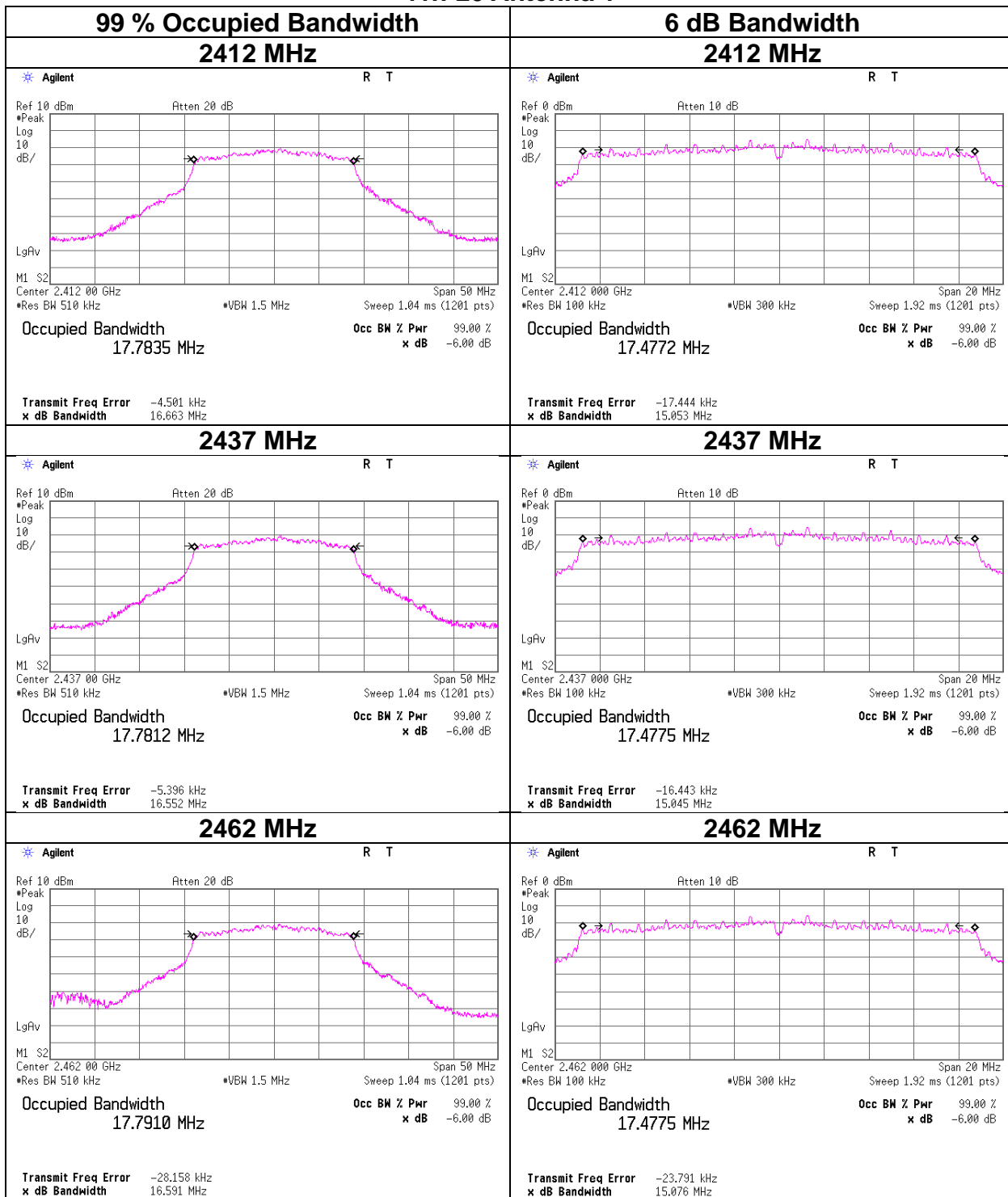

99 % Occupied Bandwidth and 6 dB Bandwidth

11n-40 Antenna 0

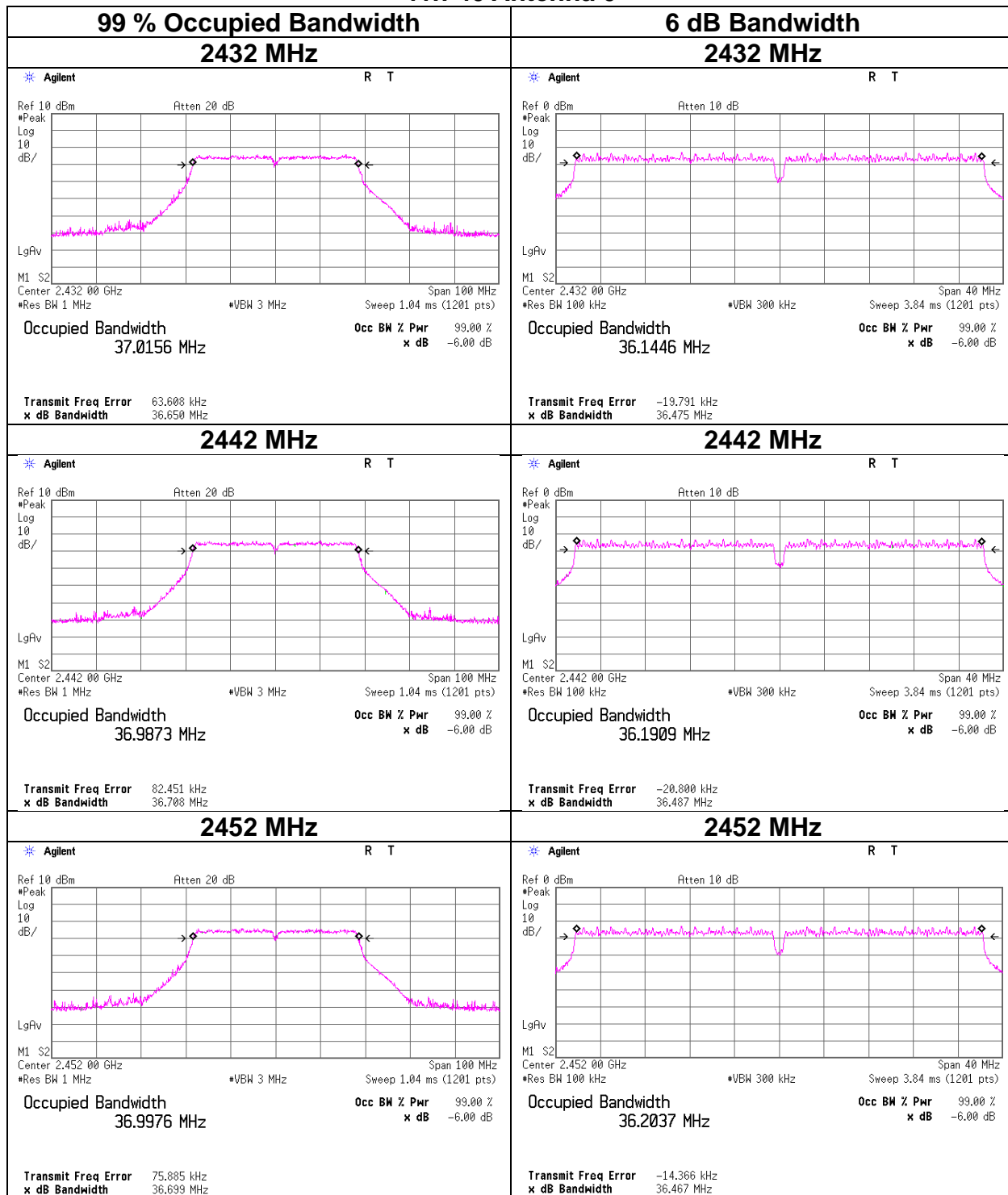

99 % Occupied Bandwidth and 6 dB Bandwidth

11n-40 Antenna 1

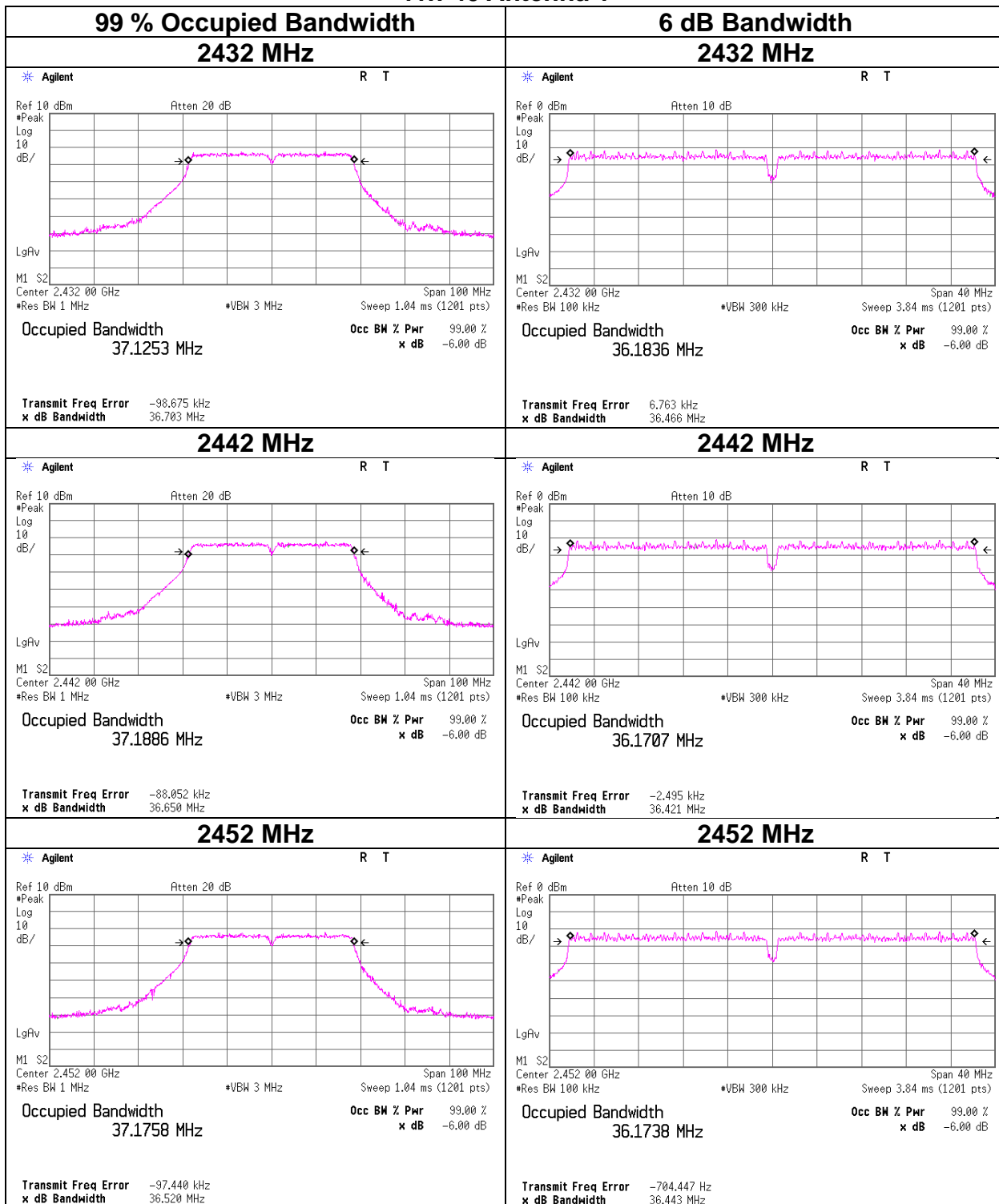

Maximum Peak Output Power

Test place	Ise EMC Lab. No.4 Measurement Room	
Date	March 21, 2024	March 28, 2024
Temperature / Humidity	21 deg. C / 42 % RH	22 deg. C / 51 % RH
Engineer	Junki Nagatomi	Tomoya Sone
Mode	Tx 11b	

Antenna 1				Conducted Power					e.i.r.p. for RSS-247					
Freq. [MHz]	Reading [dBm]	Cable Loss [dB]	Atten. Loss [dB]	Result		Limit		Margin [dB]	Antenna Gain [dBi]	Result		Limit		Margin [dB]
				[dBm]	[mW]	[dBm]	[mW]			[dBm]	[mW]	[dBm]	[mW]	
2412	1.80	1.80	10.10	13.70	23.45	30.00	1000	16.30	2.19	15.89	38.83	36.02	4000	20.13
2437	1.76	1.81	10.10	13.67	23.29	30.00	1000	16.33	2.19	15.86	38.57	36.02	4000	20.16
2462	1.71	1.81	10.10	13.62	23.03	30.00	1000	16.38	2.19	15.81	38.12	36.02	4000	20.21

Sample Calculation:

Result = Reading + Cable Loss (including the cable(s) customer supplied) + Attenuator Loss
e.i.r.p. Result = Conducted Power Result + Antenna Gain

Antenna1, 2437 MHz

Rate [Mbps]	Reading Ant1 [dBm]	Remark
1	1.51	
2	1.63	
5.5	1.68	
11	1.70	*

Maximum Peak Output Power

Test place	Ise EMC Lab. No.4 Measurement Room	
Date	March 21, 2024	March 28, 2024
Temperature / Humidity	21 deg. C / 42 % RH	22 deg. C / 51 % RH
Engineer	Junki Nagatomi	Tomoya Sone
Mode	Tx 11g	

Antenna 1				Conducted Power					e.i.r.p. for RSS-247					
Freq. [MHz]	Reading [dBm]	Cable Loss [dB]	Atten. Loss [dB]	Result		Limit		Margin [dB]	Antenna Gain [dBi]	Result		Limit		Margin [dB]
				[dBm]	[mW]	[dBm]	[mW]			[dBm]	[mW]	[dBm]	[mW]	
2412	3.66	1.80	10.10	15.56	35.99	30.00	1000	14.44	2.19	17.75	59.59	36.02	4000	18.27
2437	3.45	1.81	10.10	15.36	34.37	30.00	1000	14.64	2.19	17.55	56.91	36.02	4000	18.47
2462	3.32	1.81	10.10	15.23	33.36	30.00	1000	14.77	2.19	17.42	55.23	36.02	4000	18.60

Sample Calculation:

Result = Reading + Cable Loss (including the cable(s) customer supplied) + Attenuator Loss
e.i.r.p. Result = Conducted Power Result + Antenna Gain

Antenna 1, 2437 MHz

Rate	Reading	Remark
[Mbps]	[dBm]	
6	-1.74	
9	-1.72	
12	-1.71	
18	0.43	
24	0.47	
36	3.32	
48	3.30	
54	3.34	*

*: Worst Rate

All comparison were carried out on same frequency and measurement factors.

Maximum Peak Output Power

Test place Ise EMC Lab. No.4 Measurement Room
 Date March 21, 2024 March 28, 2024
 Temperature / Humidity 21 deg. C / 42 % RH 22 deg. C / 51 % RH
 Engineer Junki Nagatomi Tomoya Sone
 Mode Tx 11n-20

Antenna 0 + Antenna 1			Conducted Power					e.i.r.p. for RSS-247						
Freq. [MHz]	Antenna 0	Antenna 1	Result		Limit		Margin [dB]	Antenna 0	Antenna 1	Result		Limit		Margin [dB]
	Conducted Power Result [mW]	Conducted Power Result [mW]	[dBm]	[mW]	[dBm]	[mW]		e.i.r.p. Result [mW]	e.i.r.p. Result [mW]	[dBm]	[mW]	[dBm]	[mW]	
2412	7.61	11.54	12.82	19.14	27.04	506	14.22	8.96	19.11	14.48	28.06	36.02	4000.00	21.54
2437	7.30	10.70	12.55	17.99	27.41	551	14.86	8.59	17.71	14.20	26.30	36.02	4000.00	21.82
2462	7.73	10.52	12.61	18.25	26.90	490	14.29	9.10	17.43	14.24	26.53	36.02	4000.00	21.78

Sample Calculation:
 Conducted Power Result = Antenna 0 Conducted Power Result + Antenna 1 Conducted Power Result
 e.i.r.p. Result = Antenna 0 e.i.r.p. Result + Antenna 1 e.i.r.p. Result

Freq. [MHz]	Reading [dBm]	Cable Loss [dB]	Atten. Loss [dB]	Conducted Power Result		Antenna Gain [dBi]	e.i.r.p. Result	
				[dBm]	[mW]		[dBm]	[mW]
2412	-3.12	1.83	10.10	8.81	7.61	0.71	9.52	8.96
2437	-3.31	1.84	10.10	8.63	7.30	0.71	9.34	8.59
2462	-3.06	1.84	10.10	8.88	7.73	0.71	9.59	9.10

Freq. [MHz]	Reading [dBm]	Cable Loss [dB]	Atten. Loss [dB]	Conducted Power Result		Antenna Gain [dBi]	e.i.r.p. Result	
				[dBm]	[mW]		[dBm]	[mW]
2412	-1.28	1.80	10.10	10.62	11.54	2.19	12.81	19.11
2437	-1.62	1.81	10.10	10.29	10.70	2.19	12.48	17.71
2462	-1.69	1.81	10.10	10.22	10.52	2.19	12.41	17.43

Sample Calculation:
 Conducted Power Result = Reading + Cable Loss (including the cable(s) customer supplied) + Attenuator Loss
 e.i.r.p. Result = Conducted Power Result + Antenna Gain

2437 MHz

Tx	MCS Number	Antenna		Antenna		Total Reading Power		Remark
		[dBm]	[mW]	[dBm]	[mW]	[dBm]	[mW]	
SISO	0	2.78	1.90	-	-	2.78	1.90	
	1	2.70	1.86	-	-	2.70	1.86	
	2	0.46	1.11	-	-	0.46	1.11	
	3	0.48	1.12	-	-	0.48	1.12	
	4	-2.90	0.51	-	-	-2.90	0.51	
	5	-3.10	0.49	-	-	-3.10	0.49	
	6	-3.30	0.47	-	-	-3.30	0.47	
	7	-3.24	0.47	-	-	-3.24	0.47	
	0	-	-	0.94	1.24	0.94	1.24	
	1	-	-	0.96	1.25	0.96	1.25	
	2	-	-	-1.24	0.75	-1.24	0.75	
	3	-	-	-1.25	0.75	-1.25	0.75	
	4	-	-	-4.08	0.39	-4.08	0.39	
	5	-	-	-4.22	0.38	-4.22	0.38	
6	-	-	-4.96	0.32	-4.96	0.32		
7	-	-	-4.00	0.40	-4.00	0.40		
MIMO	0	2.82	1.91	1.23	1.33	5.11	3.24	
	1	2.71	1.87	1.28	1.34	5.06	3.21	
	2	0.55	1.13	0.52	1.13	3.54	2.26	
	3	0.54	1.13	0.53	1.13	3.54	2.26	
	4	-3.03	0.50	-2.57	0.55	0.21	1.05	
	5	-3.15	0.48	-2.32	0.59	0.29	1.07	
	6	-3.39	0.46	-3.39	0.46	-0.38	0.92	
	7	-2.29	0.59	-2.34	0.58	0.69	1.17	
	8	2.72	1.87	2.63	1.83	5.68	3.70	*
	9	2.64	1.84	2.71	1.87	5.68	3.70	
	10	0.49	1.12	0.46	1.11	3.48	2.23	
	11	0.45	1.11	0.41	1.10	3.44	2.21	
	12	-2.31	0.59	-2.40	0.58	0.65	1.16	
	13	-2.39	0.58	-2.08	0.62	0.78	1.20	
	14	-3.40	0.46	-2.86	0.52	-0.11	0.97	
15	-2.64	0.54	-2.51	0.56	0.43	1.10		

*Worst MCS
 All comparison were carried out on same frequency and measurement factors.

Maximum Peak Output Power

Test place Ise EMC Lab. No.4 Measurement Room
 Date March 21, 2024 March 28, 2024
 Temperature / Humidity 21 deg. C / 42 % RH 22 deg. C / 51 % RH
 Engineer Junki Nagatomi Tomoya Sone
 Mode Tx 11n-40

Antenna 0 + Antenna 1			Conducted Power						e.i.r.p. for RSS-247					
Freq. [MHz]	Antenna 0 Conducted Power Result [mW]	Antenna 1 Conducted Power Result [mW]	Result		Limit		Margin [dB]	Antenna 0 e.i.r.p. Result [mW]	Antenna 1 e.i.r.p. Result [mW]	Result		Limit		Margin [dB]
			[dBm]	[mW]	[dBm]	[mW]				[dBm]	[mW]	[dBm]	[mW]	
2432	25.53	42.19	18.31	67.72	30.00	1000	11.69	30.07	69.86	20.00	99.92	36.02	4000.00	16.02
2442	26.92	42.87	18.44	69.80	30.00	1000	11.56	31.70	70.99	20.12	102.69	36.02	4000.00	15.91
2452	26.07	40.38	18.22	66.45	30.00	1000	11.78	30.70	66.87	19.89	97.56	36.02	4000.00	16.13

Sample Calculation:

Conducted Power Result = Antenna 0 Conducted Power Result + Antenna 1 Conducted Power Result

e.i.r.p. Result = Antenna 0 e.i.r.p. Result + Antenna 1 e.i.r.p. Result

Antenna 0									
Freq. [MHz]	Reading [dBm]	Cable Loss [dB]	Atten. Loss [dB]	Conducted Power Result		Antenna Gain [dBi]	e.i.r.p. Result		Margin [dB]
				[dBm]	[mW]		[dBm]	[mW]	
2432	2.14	1.83	10.10	14.07	25.53	0.71	14.78	30.07	
2442	2.36	1.84	10.10	14.30	26.92	0.71	15.01	31.70	
2452	2.22	1.84	10.10	14.16	26.07	0.71	14.87	30.70	

Antenna 1									
Freq. [MHz]	Reading [dBm]	Cable Loss [dB]	Atten. Loss [dB]	Conducted Power Result		Antenna Gain [dBi]	e.i.r.p. Result		Margin [dB]
				[dBm]	[mW]		[dBm]	[mW]	
2432	4.35	1.80	10.10	16.25	42.19	2.19	18.44	69.86	
2442	4.41	1.81	10.10	16.32	42.87	2.19	18.51	70.99	
2452	4.15	1.81	10.10	16.06	40.38	2.19	18.25	66.87	

Sample Calculation:

Conducted Power Result = Reading + Cable Loss (including the cable(s) customer supplied) + Attenuator Loss

e.i.r.p. Result = Conducted Power Result + Antenna Gain

2437 MHz

Tx	MCS Number	Antenna 0		Antenna 1		Long GI Total Reading Power		Antenna 0		Antenna 1		Short GI Total Reading Power		Remark
		[dBm]	[mW]	[dBm]	[mW]	[dBm]	[mW]	[dBm]	[mW]	[dBm]	[mW]	[dBm]	[mW]	
SISO	0	-1.13	0.77	-	-	-1.13	0.77	-	-	-	-	-	-	
	1	-0.96	0.80	-	-	-0.96	0.80	-	-	-	-	-	-	
	2	0.16	1.04	-	-	0.16	1.04	-	-	-	-	-	-	
	3	-0.21	0.95	-	-	-0.21	0.95	-	-	-	-	-	-	
	4	2.52	1.79	-	-	2.52	1.79	-	-	-	-	-	-	
	5	2.86	1.93	-	-	2.86	1.93	-	-	-	-	-	-	
	6	2.32	1.71	-	-	2.32	1.71	-	-	-	-	-	-	
	7	2.22	1.67	-	-	2.22	1.67	-	-	-	-	-	-	
	0	-	-	0.73	1.18	0.73	1.18	-	-	-	-	-	-	
	1	-	-	0.86	1.22	0.86	1.22	-	-	-	-	-	-	
	2	-	-	1.81	1.52	1.81	1.52	-	-	-	-	-	-	
	3	-	-	1.53	1.42	1.53	1.42	-	-	-	-	-	-	
	4	-	-	4.23	2.65	4.23	2.65	-	-	-	-	-	-	
	5	-	-	4.52	2.83	4.52	2.83	-	-	-	-	-	-	
	6	-	-	4.30	2.69	4.30	2.69	-	-	-	-	-	-	
7	-	-	3.74	2.37	3.74	2.37	-	-	-	-	-	-		
MIMO	0	-0.89	0.82	0.71	1.18	3.00	1.99	-	-	-	-	-	-	
	1	-0.77	0.84	0.82	1.21	3.11	2.05	-	-	-	-	-	-	
	2	0.22	1.05	1.85	1.53	4.12	2.58	-	-	-	-	-	-	
	3	-0.16	0.96	1.50	1.41	3.76	2.38	-	-	-	-	-	-	
	4	2.90	1.95	4.22	2.64	6.62	4.59	-	-	-	-	-	-	
	5	3.02	2.01	4.42	2.77	6.79	4.77	-	-	-	-	-	-	
	6	2.63	1.83	4.19	2.63	6.49	4.46	-	-	-	-	-	-	
	7	2.10	1.62	3.82	2.41	6.06	4.03	-	-	-	-	-	-	
	8	-0.59	0.87	0.85	1.22	3.20	2.09	-	-	-	-	-	-	
	9	-0.97	0.80	0.86	1.22	3.05	2.02	-	-	-	-	-	-	
	10	0.51	1.13	1.81	1.52	4.22	2.64	-	-	-	-	-	-	
	11	0.02	1.01	1.57	1.44	3.88	2.44	-	-	-	-	-	-	
	12	2.64	1.84	4.37	2.74	6.60	4.57	-	-	-	-	-	-	
	13	2.55	1.80	4.15	2.60	6.44	4.40	-	-	-	-	-	-	
	14	2.60	1.82	4.27	2.67	6.53	4.50	-	-	-	-	-	-	
15	2.87	1.94	5.07	3.22	7.12	5.15	2.80	1.91	4.94	3.12	7.01	5.03	* Long GI	

*Worst MCS

All comparison were carried out on same frequency and measurement factors.

Average Output Power
(Reference data for RF Exposure)

Test place	Ise EMC Lab. No.4 Measurement Room
Date	March 28, 2024
Temperature / Humidity	22 deg. C / 51 % RH
Engineer	Tomoya Sone
Mode	Tx

11b **1 Mbps** Antenna 1

Freq. [MHz]	Reading [dBm]	Cable Loss [dB]	Atten. Loss [dB]	Result (Time average)		Duty factor [dB]	Result (Burst power average)	
				[dBm]	[mW]		[dBm]	[mW]
				2412	-0.75		1.80	10.10
2437	-0.90	1.81	10.10	11.01	12.62	0.01	11.02	12.65
2462	-0.89	1.81	10.10	11.02	12.65	0.01	11.03	12.68

11g **6 Mbps** Antenna 1

Freq. [MHz]	Reading [dBm]	Cable Loss [dB]	Atten. Loss [dB]	Result (Time average)		Duty factor [dB]	Result (Burst power average)	
				[dBm]	[mW]		[dBm]	[mW]
				2412	-6.13		1.80	10.10
2437	-6.35	1.81	10.10	5.56	3.60	0.07	5.63	3.66
2462	-6.55	1.81	10.10	5.36	3.44	0.07	5.43	3.49

Sample Calculation:

Result (Time average) = Reading + Cable Loss (including the cable(s) customer supplied) + Attenuator Loss

Result (Burst power average) = Time average + Duty factor

The average output power was measured with the lowest order modulation and lowest data rate configuration in each IEEE 802.11 mode based on KDB 248227 D01.

Average Output Power
(Reference data for RF Exposure)

Test place Ise EMC Lab. No.4 Measurement Room
Date March 28, 2024
Temperature / Humidity 22 deg. C / 51 % RH
Engineer Tomoya Sone
Mode Tx 11n-20

Antenna 0 + Antenna 1 MCS0

Freq. [MHz]	Antenna 1 Result [mW]	Antenna 2 Result [mW]	Result (Burst average)	
			[dBm]	[mW]
2412	2.61	3.90	8.13	6.51
2437	2.48	3.62	7.85	6.10
2462	2.61	3.53	7.89	6.15

Antenna 0

Freq. [MHz]	Reading [dBm]	Cable Loss [dB]	Atten. Loss [dB]	Result (Time average)		Duty factor [dB]	Result (Burst power average)	
				[dBm]	[mW]		[dBm]	[mW]
2412	-7.85	1.83	10.10	4.08	2.56	0.08	4.16	2.61
2437	-8.08	1.84	10.10	3.86	2.43	0.08	3.94	2.48
2462	-7.85	1.84	10.10	4.09	2.57	0.08	4.17	2.61

Antenna 1

Freq. [MHz]	Reading [dBm]	Cable Loss [dB]	Atten. Loss [dB]	Result (Time average)		Duty factor [dB]	Result (Burst power average)	
				[dBm]	[mW]		[dBm]	[mW]
2412	-6.07	1.80	10.10	5.83	3.83	0.08	5.91	3.90
2437	-6.40	1.81	10.10	5.51	3.56	0.08	5.59	3.62
2462	-6.51	1.81	10.10	5.40	3.47	0.08	5.48	3.53

Sample Calculation:

Result (Time average) = Reading + Cable Loss (including the cable(s) customer supplied) + Attenuator Loss

Result (Burst power average) = Time average + Duty factor

Average Output Power
(Reference data for RF Exposure)

Test place Ise EMC Lab. No.4 Measurement Room
Date March 28, 2024
Temperature / Humidity 22 deg. C / 51 % RH
Engineer Tomoya Sone
Mode Tx 11n-40

Antenna 0 + Antenna 1 MCS0

Freq. [MHz]	Antenna 1	Antenna 2	Result (Burst average)	
	Result [mW]	Result [mW]	[dBm]	[mW]
2432	3.48	4.98	9.27	8.46
2442	3.69	5.17	9.47	8.86
2452	3.57	4.79	9.22	8.35

Antenna 0

Freq. [MHz]	Reading [dBm]	Cable Loss [dB]	Atten. Loss [dB]	Result (Time average)		Duty factor [dB]	Result (Burst power average)	
				[dBm]	[mW]		[dBm]	[mW]
2432	-6.73	1.83	10.10	5.20	3.31	0.21	5.41	3.48
2442	-6.48	1.84	10.10	5.46	3.52	0.21	5.67	3.69
2452	-6.63	1.84	10.10	5.31	3.40	0.21	5.52	3.57

Antenna 1

Freq. [MHz]	Reading [dBm]	Cable Loss [dB]	Atten. Loss [dB]	Result (Time average)		Duty factor [dB]	Result (Burst power average)	
				[dBm]	[mW]		[dBm]	[mW]
2432	-5.14	1.80	10.10	6.76	4.74	0.21	6.97	4.98
2442	-4.99	1.81	10.10	6.92	4.92	0.21	7.13	5.17
2452	-5.32	1.81	10.10	6.59	4.56	0.21	6.80	4.79

Sample Calculation:

Result (Time average) = Reading + Cable Loss (including the cable(s) customer supplied) + Attenuator Loss

Result (Burst power average) = Time average + Duty factor

Burst rate confirmation

Test place Ise EMC Lab. No.4 Semi Anechoic Chamber
Date March 26, 2024
Temperature / Humidity 24 deg. C / 33 % RH
Engineer Tomoya Sone
Mode Tx

11b 11 Mbps

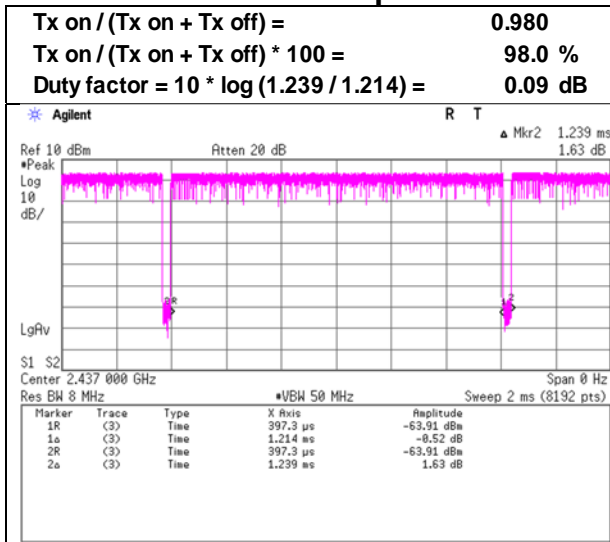

11g 54 Mbps

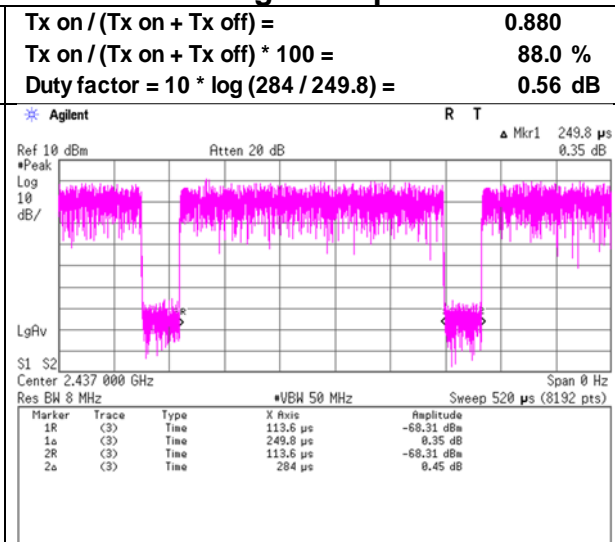

11n-20 MCS 8

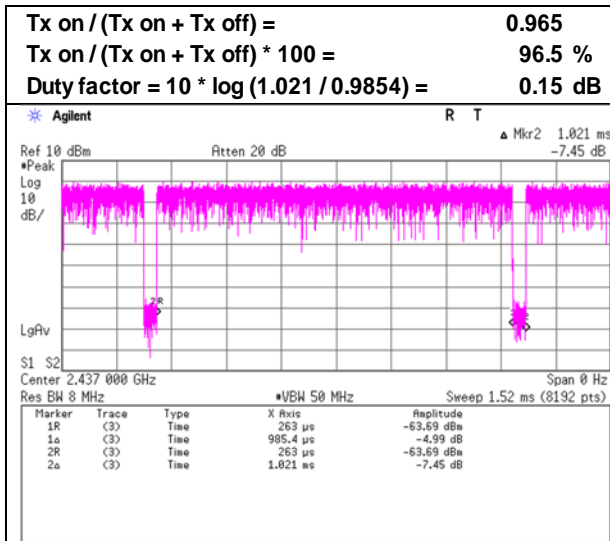

11n-40 MCS 15

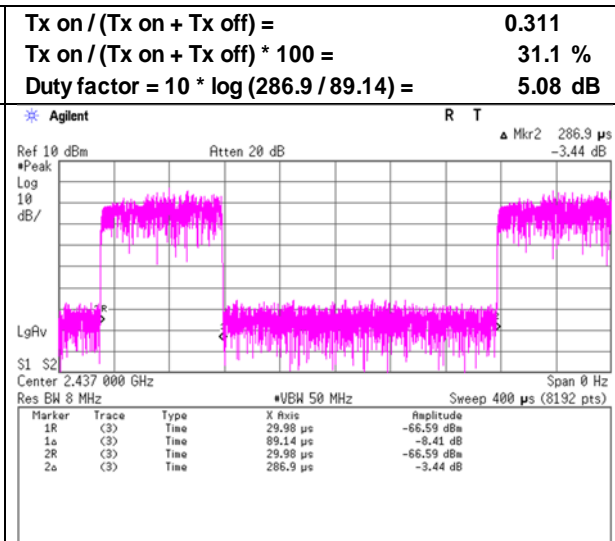

* Since the burst rate is not different between the channels, the data has been obtained on the representative channel.

Burst rate confirmation

Test place	Ise EMC Lab. No.4 Semi Anechoic Chamber
Date	March 26, 2024
Temperature / Humidity	24 deg. C / 33 % RH
Engineer	Tomoya Sone
Mode	Tx

11b 1 Mbps

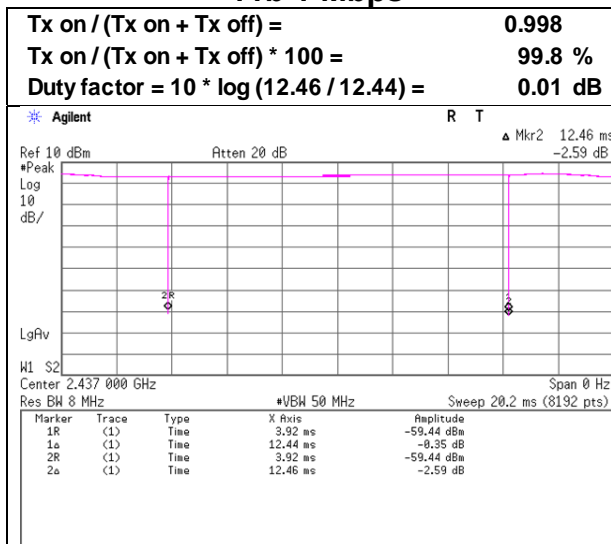

11g 6 Mbps

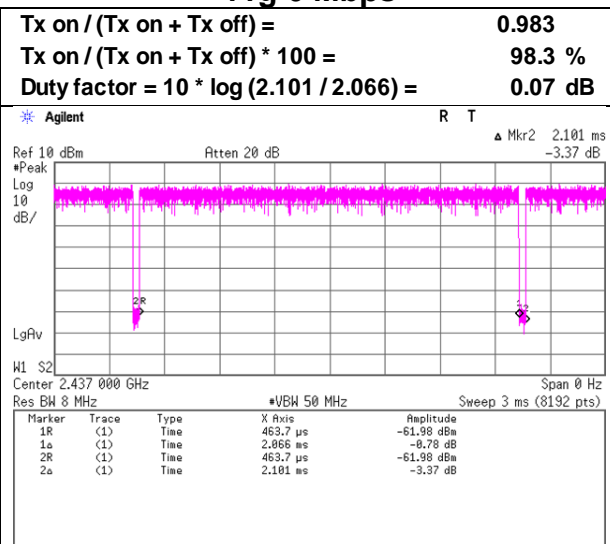

11n-20 MCS 0

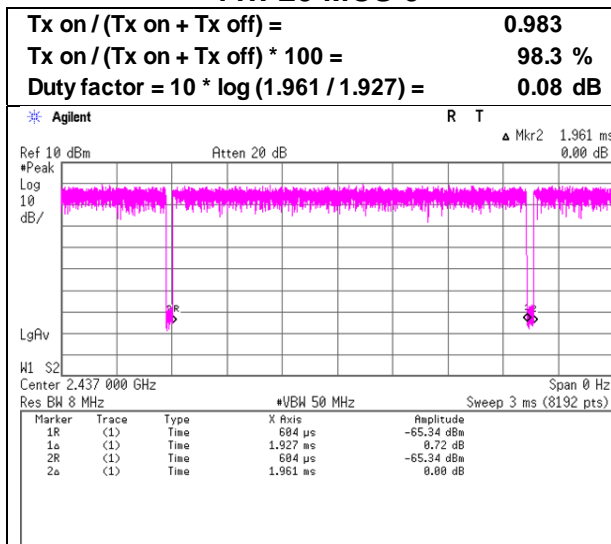

11n-40 MCS 0

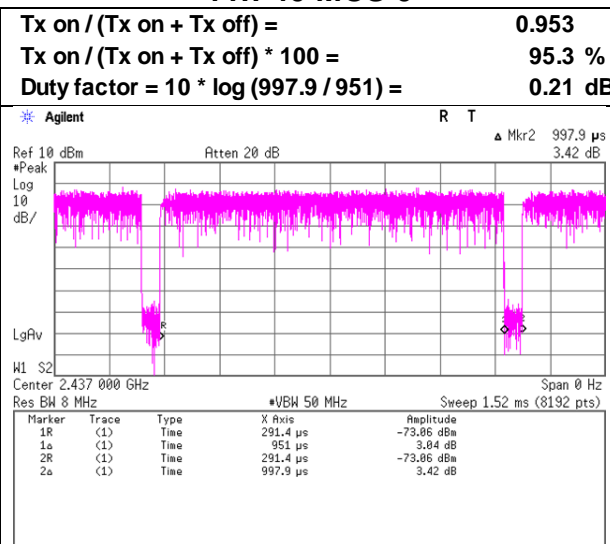

* Since the burst rate is not different between the channels, the data has been obtained on the representative channel.

Radiated Spurious Emission

Test place	Ise EMC Lab.		
Semi Anechoic Chamber	No.4	No.4	No.4
Date	March 25, 2024	March 25, 2024	March 28, 2024
Temperature / Humidity	20 deg. C / 40 % RH	23 deg. C / 37 % RH	23 deg. C / 37 % RH
Engineer	Shousei Hamaguchi	Tomoya Sone	Shousei Hamaguchi
Mode	(1 GHz to 6 GHz) Tx 11b 2412 MHz	(6 GHz to 10 GHz)	(10 GHz to 26.5 GHz)

Polarity	Frequency	Reading (QP / PK)	Reading (AV)	Ant. Factor	Loss	Gain	Duty Factor	Result (QP / PK)	Result (AV)	Limit (QP / PK)	Limit (AV)	Margin (QP / PK)	Margin (AV)	Remark
[Hori/Vert]	[MHz]	[dBuV]	[dBuV]	[dB/m]	[dB]	[dB]	[dB]	[dBuV/m]	[dBuV/m]	[dBuV/m]	[dBuV/m]	[dB]	[dB]	
Hori.	2390.0	42.9	32.4	27.8	5.4	31.8	0.1	44.3	33.9	73.9	53.9	29.6	20.0	*1)
Hori.	4108.3	44.9	35.7	30.0	7.5	31.0	-	51.4	42.1	73.9	53.9	22.6	11.8	
Hori.	4824.0	39.8	30.1	31.4	7.6	30.8	-	47.9	38.3	73.9	53.9	26.0	15.7	Floor noise
Hori.	7236.0	41.1	32.0	35.7	11.0	32.1	-	55.7	46.6	73.9	53.9	18.2	7.4	Floor noise
Hori.	9648.0	40.0	31.0	35.8	12.1	32.3	-	55.6	46.5	73.9	53.9	18.3	7.4	Floor noise
Vert.	2390.0	42.7	34.4	27.8	5.4	31.8	0.1	44.1	35.9	73.9	53.9	29.8	18.1	*1)
Vert.	4108.3	45.3	36.2	30.0	7.5	31.0	-	51.8	42.6	73.9	53.9	22.1	11.3	
Vert.	4824.0	39.8	30.1	31.4	7.6	30.8	-	47.9	38.3	73.9	53.9	26.0	15.7	Floor noise
Vert.	7236.0	41.0	31.8	35.7	11.0	32.1	-	55.5	46.4	73.9	53.9	18.4	7.5	Floor noise
Vert.	9648.0	39.9	30.9	35.8	12.1	32.3	-	55.5	46.5	73.9	53.9	18.4	7.4	Floor noise

Result (QP / PK) = Reading + Ant Factor + Loss (Cable+Attenuator+Filter+Distance factor(above 1 GHz)) - Gain(Amplifier)
 Result (AV)= Reading + Ant Factor + Loss (Cable+Attenuator+Filter+Distance factor(above 1 GHz)) - Gain(Amplifier) + Duty factor
 *Other frequency noises omitted in this report were not seen or had enough margin (more than 20 dB).
 *QP detector was used up to 1GHz.
 *1) Not Out of Band emission(Leakage Power)

20dBc Data Sheet

Polarity	Frequency	Reading (PK)	Ant. Factor	Loss	Gain	Result	Limit	Margin	Remark
[Hori/Vert]	[MHz]	[dBuV]	[dB/m]	[dB]	[dB]	[dBuV/m]	[dBuV/m]	[dB]	
Hori.	2412.0	96.1	27.8	5.4	31.8	97.5	-	-	Carrier
Hori.	2400.0	50.7	27.8	5.4	31.8	52.1	77.5	25.4	
Vert.	2412.0	93.7	27.8	5.4	31.8	95.1	-	-	Carrier
Vert.	2400.0	48.4	27.8	5.4	31.8	49.8	75.1	25.3	

Result = Reading + Ant Factor + Loss (Cable+Attenuator+Filter+Distance factor(above 1 GHz)) - Gain(Amplifier)
 Distance factor:
 1 GHz - 6 GHz 20log (3.8 m / 3.0 m) = 2.06 dB
 6 GHz - 10 GHz 20log (4.8 m / 3.0 m) = 4.09 dB
 10 GHz - 40 GHz 20log (1.0 m / 3.0 m) = -9.54 dB

Radiated Spurious Emission (Reference Plot for band-edge)

Test place	Ise EMC Lab.
Semi Anechoic Chamber	No.4
Date	March 25, 2024
Temperature / Humidity	20 deg. C / 40 % RH
Engineer	Shousei Hamaguchi
	(1 GHz to 6 GHz)
Mode	Tx 11b 2412 MHz

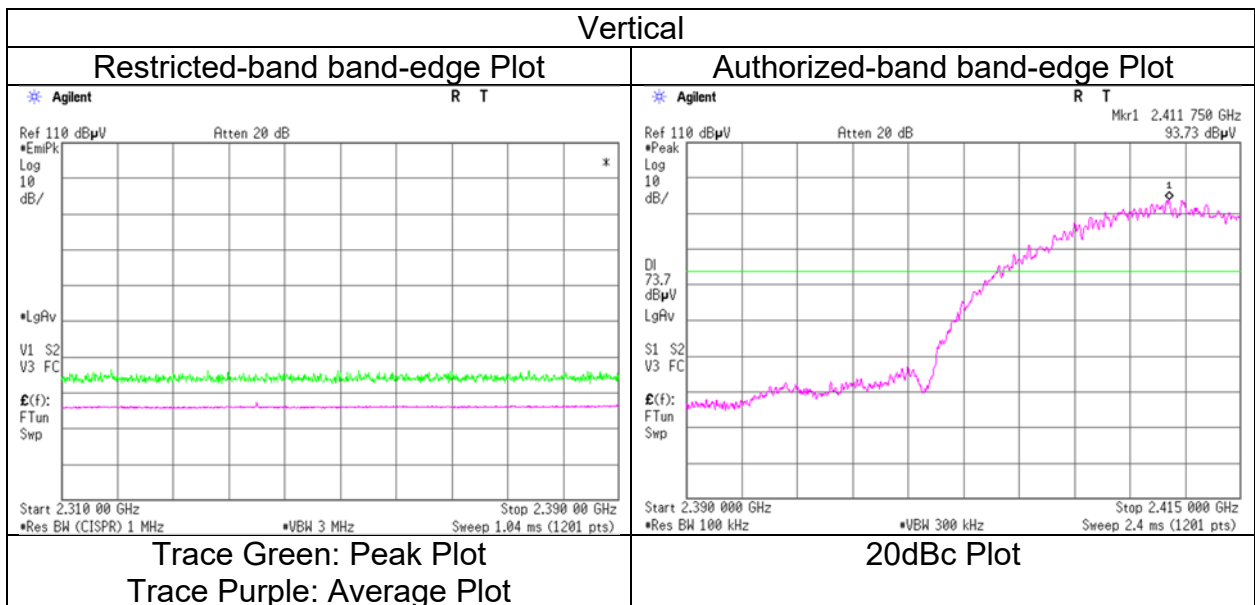
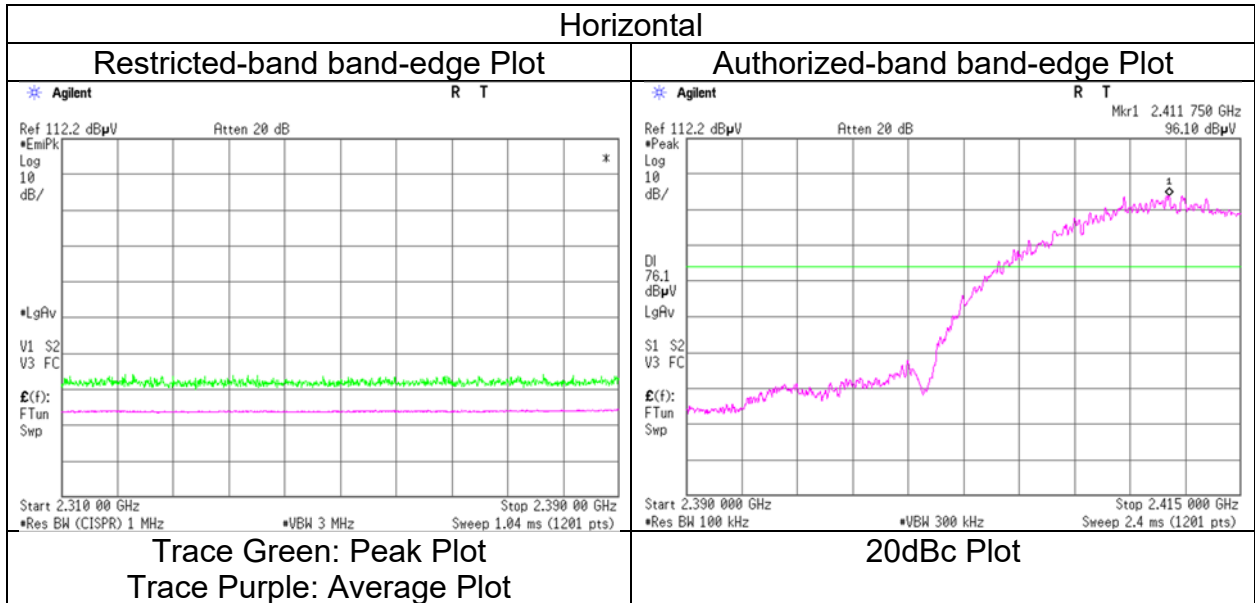

* The measurement was conducted for a sufficiently long time enough to detect any possible spurious emissions.
Final result of restricted band edge and authorized band edge were shown in tabular data.

Radiated Spurious Emission

Test place	Ise EMC Lab.		
Semi Anechoic Chamber	No.4	No.4	No.4
Date	March 25, 2024	March 25, 2024	March 28, 2024
Temperature / Humidity	20 deg. C / 40 % RH	23 deg. C / 37 % RH	23 deg. C / 37 % RH
Engineer	Shousei Hamaguchi	Tomoya Sone	Shousei Hamaguchi
Mode	(1 GHz to 6 GHz) Tx 11b 2437 MHz	(6 GHz to 10 GHz)	(10 GHz to 26.5 GHz)

Polarity	Frequency	Reading (QP / PK)	Reading (AV)	Ant. Factor	Loss	Gain	Duty Factor	Result (QP / PK)	Result (AV)	Limit (QP / PK)	Limit (AV)	Margin (QP / PK)	Margin (AV)	Remark
[Hori/Vert]	[MHz]	[dBuV]	[dBuV]	[dB/m]	[dB]	[dB]	[dB]	[dBuV/m]	[dBuV/m]	[dBuV/m]	[dBuV/m]	[dB]	[dB]	
Hori.	4108.3	44.8	35.8	30.0	7.5	31.0	-	51.3	42.2	73.9	53.9	22.6	11.7	
Hori.	4874.0	40.3	31.8	31.4	7.7	30.8	-	48.5	40.1	73.9	53.9	25.4	13.9	Floor noise
Hori.	7311.0	40.8	31.9	35.6	11.0	32.1	-	55.4	46.5	73.9	53.9	18.5	7.4	Floor noise
Hori.	9748.0	40.0	30.8	36.0	12.1	32.4	-	55.8	46.6	73.9	53.9	18.1	7.3	Floor noise
Vert.	4108.3	45.4	36.2	30.0	7.5	31.0	-	51.8	42.6	73.9	53.9	22.1	11.3	
Vert.	4874.0	40.3	31.8	31.4	7.7	30.8	-	48.5	40.1	73.9	53.9	25.4	13.9	Floor noise
Vert.	7311.0	40.8	31.8	35.6	11.0	32.1	-	55.3	46.4	73.9	53.9	18.6	7.5	Floor noise
Vert.	9748.0	39.9	30.8	36.0	12.1	32.4	-	55.7	46.5	73.9	53.9	18.2	7.4	Floor noise

Result (QP / PK) = Reading + Ant Factor + Loss (Cable+Attenuator+Filter+Distance factor(above 1 GHz)) - Gain(Amplifier)
 Result (AV)= Reading + Ant Factor + Loss (Cable+Attenuator+Filter+Distance factor(above 1 GHz)) - Gain(Amplifier) + Duty factor
 *Other frequency noises omitted in this report were not seen or had enough margin (more than 20 dB).
 *QP detector was used up to 1GHz.

Distance factor: 1 GHz - 6 GHz 20log (3.8 m / 3.0 m) = 2.06 dB
 6 GHz - 10 GHz 20log (4.8 m / 3.0 m) = 4.09 dB
 10 GHz - 40 GHz 20log (1.0 m / 3.0 m) = -9.54 dB

Radiated Spurious Emission

Test place	Ise EMC Lab.		
Semi Anechoic Chamber	No.4	No.4	No.4
Date	March 25, 2024	March 25, 2024	March 28, 2024
Temperature / Humidity	20 deg. C / 40 % RH	23 deg. C / 37 % RH	23 deg. C / 37 % RH
Engineer	Shousei Hamaguchi	Tomoya Sone	Shousei Hamaguchi
Mode	(1 GHz to 6 GHz) Tx 11b 2462 MHz	(6 GHz to 10 GHz)	(10 GHz to 26.5 GHz)

Polarity	Frequency	Reading	Reading	Ant.	Loss	Gain	Duty	Result	Result	Limit	Limit	Margin	Margin	Remark
[Hori/Vert]	[MHz]	(QP / PK)	(AV)	Factor			Factor	(QP / PK)	(AV)	(QP / PK)	(AV)	(QP / PK)	(AV)	
		[dBuV]	[dBuV]	[dB/m]	[dB]	[dB]	[dB]	[dBuV/m]	[dBuV/m]	[dBuV/m]	[dBuV/m]	[dB]	[dB]	
Hori.	2483.5	43.7	33.5	27.7	5.4	31.7	0.1	45.1	35.0	73.9	53.9	28.8	18.9	*1)
Hori.	4108.3	44.8	35.7	30.0	7.5	31.0	-	51.2	42.2	73.9	53.9	22.7	11.7	
Hori.	4924.0	39.4	29.9	31.5	7.7	30.8	-	47.7	38.2	73.9	53.9	26.2	15.7	Floor noise
Hori.	7386.0	41.5	31.8	35.6	11.1	32.1	-	56.0	46.3	73.9	53.9	17.9	7.6	Floor noise
Hori.	9848.0	40.4	31.8	36.2	12.2	32.4	-	56.4	47.7	73.9	53.9	17.5	6.2	Floor noise
Vert.	2483.5	42.9	34.7	27.7	5.4	31.7	0.1	44.3	36.2	73.9	53.9	29.6	17.7	*1)
Vert.	4108.3	45.5	36.2	30.0	7.5	31.0	-	51.9	42.6	73.9	53.9	22.0	11.3	
Vert.	4924.0	39.4	29.9	31.5	7.7	30.8	-	47.7	38.2	73.9	53.9	26.2	15.7	Floor noise
Vert.	7386.0	41.4	31.8	35.6	11.1	32.1	-	55.9	46.3	73.9	53.9	18.0	7.6	Floor noise
Vert.	9848.0	40.4	31.7	36.2	12.2	32.4	-	56.3	47.6	73.9	53.9	17.6	6.3	Floor noise

Result (QP / PK) = Reading + Ant Factor + Loss (Cable+Attenuator+Filter+Distance factor(above 1 GHz)) - Gain(Amplifier)

Result (AV)= Reading + Ant Factor + Loss (Cable+Attenuator+Filter+Distance factor(above 1 GHz)) - Gain(Amplifier) + Duty factor

*Other frequency noises omitted in this report were not seen or had enough margin (more than 20 dB).

*QP detector was used up to 1GHz.

*1) Not Out of Band emission(Leakage Power)

Distance factor:	1 GHz - 6 GHz	20log (3.8 m / 3.0 m) = 2.06 dB
	6 GHz - 10 GHz	20log (4.8 m / 3.0 m) = 4.09 dB
	10 GHz - 40 GHz	20log (1.0 m / 3.0 m) = -9.54 dB

Radiated Spurious Emission (Reference Plot for band-edge)

Test place
Semi Anechoic Chamber
Date
Temperature / Humidity
Engineer
Mode

Ise EMC Lab.
No.4
March 25, 2024
20 deg. C / 40 % RH
Shousei Hamaguchi
(1 GHz to 6 GHz)
Tx 11b 2462 MHz

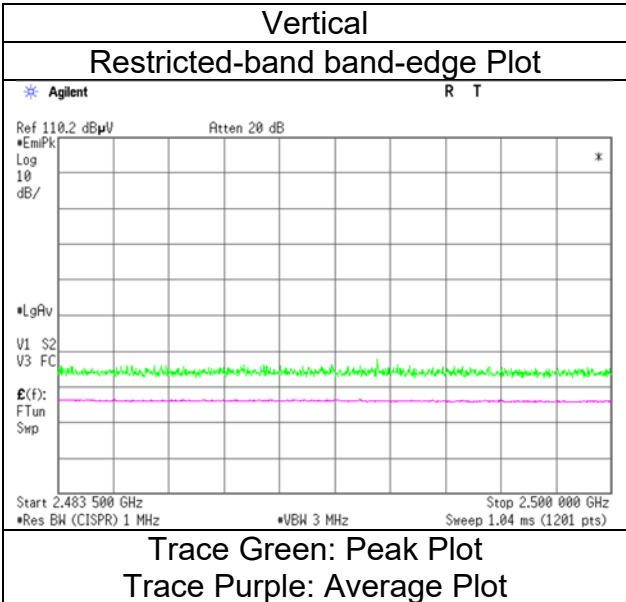
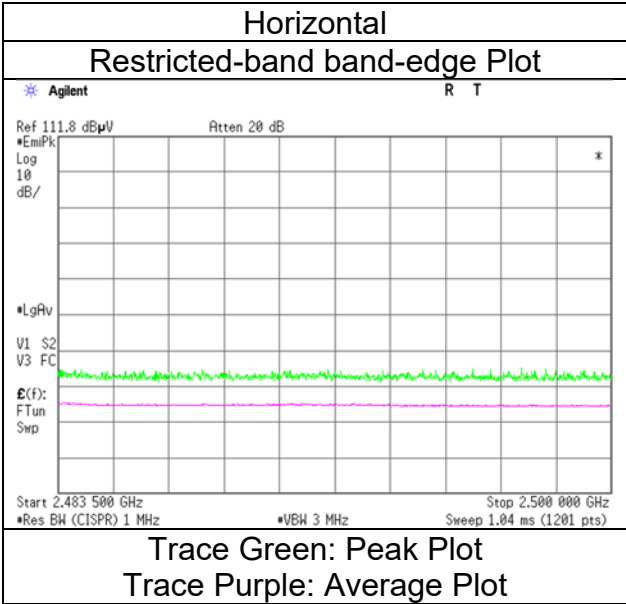

* The measurement was conducted for a sufficiently long enough time to detect any possible spurious emissions.
Final result of restricted band edge was shown in tabular data.

Radiated Spurious Emission

Test place	Ise EMC Lab.	No.4
Semi Anechoic Chamber	No.4	No.4
Date	March 25, 2024	March 28, 2024
Temperature / Humidity	20 deg. C / 40 % RH	23 deg. C / 37 % RH
Engineer	Shousei Hamaguchi	Shousei Hamaguchi
Mode	(1 GHz to 6 GHz)	(6 GHz to 26.5 GHz)
	Tx 11g 2412 MHz	

Polarity	Frequency	Reading (QP / PK)	Reading (AV)	Ant. Factor	Loss	Gain	Duty Factor	Result (QP / PK)	Result (AV)	Limit (QP / PK)	Limit (AV)	Margin (QP / PK)	Margin (AV)	Remark
[Hori/Vert]	[MHz]	[dBuV]	[dBuV]	[dB/m]	[dB]	[dB]	[dB]	[dBuV/m]	[dBuV/m]	[dBuV/m]	[dBuV/m]	[dB]	[dB]	
Hori.	2390.0	45.3	35.5	27.8	5.4	31.8	0.6	46.7	37.5	73.9	53.9	27.2	16.4	*1)
Hori.	4108.3	44.6	35.5	30.0	7.5	31.0	-	51.1	42.0	73.9	53.9	22.8	11.9	
Hori.	4824.0	39.8	30.1	31.4	7.6	30.8	-	47.9	38.3	73.9	53.9	26.0	15.7	Floor noise
Hori.	7236.0	41.0	32.0	35.7	11.0	32.1	-	55.6	46.5	73.9	53.9	18.3	7.4	Floor noise
Hori.	9648.0	40.1	31.0	35.8	12.1	32.3	-	55.6	46.5	73.9	53.9	18.3	7.4	Floor noise
Vert.	2390.0	44.0	34.8	27.8	5.4	31.8	0.6	45.4	36.8	73.9	53.9	28.5	17.1	*1)
Vert.	4108.3	45.4	36.2	30.0	7.5	31.0	-	51.9	42.7	73.9	53.9	22.0	11.2	
Vert.	4824.0	39.8	30.1	31.4	7.6	30.8	-	47.9	38.3	73.9	53.9	26.0	15.7	Floor noise
Vert.	7236.0	41.0	32.0	35.7	11.0	32.1	-	55.6	46.5	73.9	53.9	18.3	7.4	Floor noise
Vert.	9648.0	40.1	31.0	35.8	12.1	32.3	-	55.6	46.5	73.9	53.9	18.3	7.4	Floor noise

Result (QP / PK) = Reading + Ant Factor + Loss (Cable+Attenuator+Filter+Distance factor(above 1 GHz)) - Gain(Amplifier)
 Result (AV)= Reading + Ant Factor + Loss (Cable+Attenuator+Filter+Distance factor(above 1 GHz)) - Gain(Amplifier) + Duty factor
 *Other frequency noises omitted in this report were not seen or had enough margin (more than 20 dB).
 *QP detector was used up to 1GHz.
 *1) Not Out of Band emission(Leakage Power)

20dBc Data Sheet

Polarity	Frequency	Reading (PK)	Ant. Factor	Loss	Gain	Result	Limit	Margin	Remark
[Hori/Vert]	[MHz]	[dBuV]	[dB/m]	[dB]	[dB]	[dBuV/m]	[dBuV/m]	[dB]	
Hori.	2412.0	87.5	27.8	5.4	31.8	88.8	-	-	Carrier
Hori.	2400.0	54.1	27.8	5.4	31.8	55.5	68.8	13.3	
Vert.	2412.0	84.4	27.8	5.4	31.8	85.8	-	-	Carrier
Vert.	2400.0	51.6	27.8	5.4	31.8	53.0	65.8	12.7	

Result = Reading + Ant Factor + Loss (Cable+Attenuator+Filter+Distance factor(above 1 GHz)) - Gain(Amplifier)
 Distance factor:
 1 GHz - 6 GHz 20log (3.8 m / 3.0 m) = 2.06 dB
 6 GHz - 10 GHz 20log (4.8 m / 3.0 m) = 4.09 dB
 10 GHz - 40 GHz 20log (1.0 m / 3.0 m) = -9.54 dB

**Radiated Spurious Emission
 (Reference Plot for band-edge)**

Test place
 Semi Anechoic Chamber
 Date
 Temperature / Humidity
 Engineer
 Mode

Ise EMC Lab.
 No.4
 March 25, 2024
 20 deg. C / 40 % RH
 Shousei Hamaguchi
 (1 GHz to 6 GHz)
 Tx 11g 2412 MHz

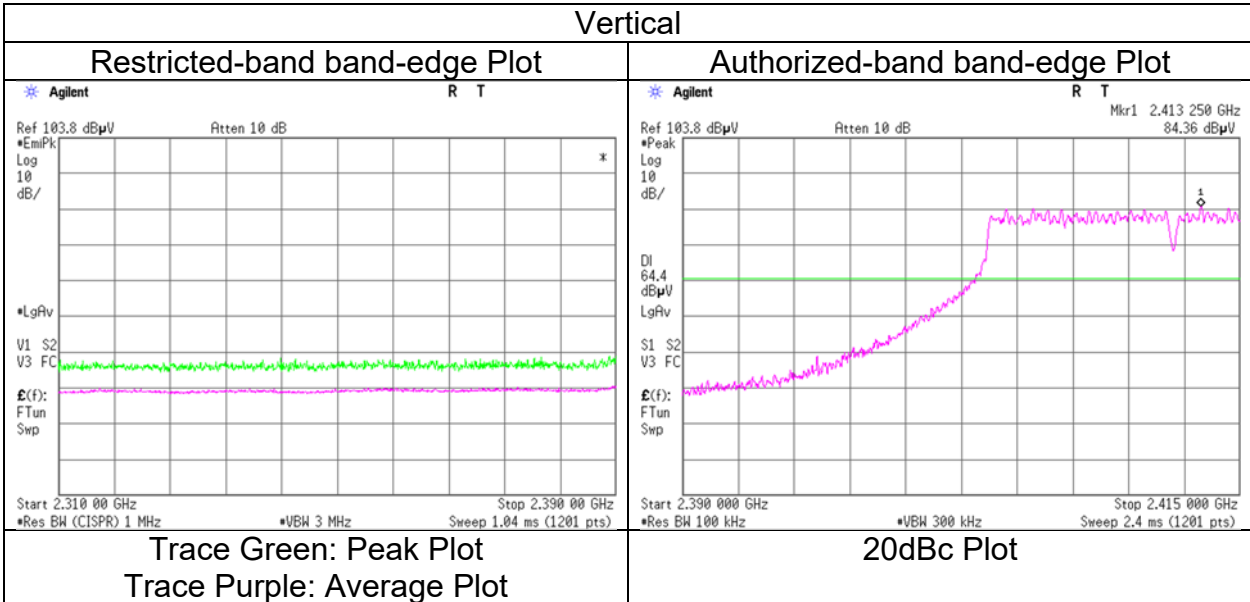
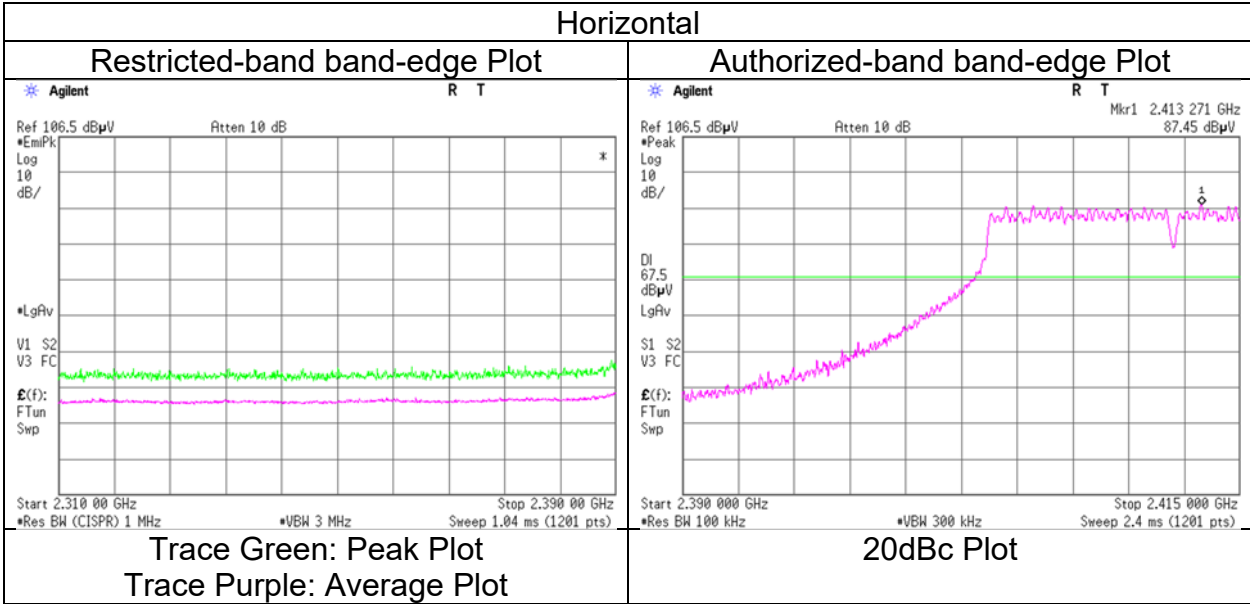

* The measurement was conducted for a sufficiently long enough time to detect any possible spurious emissions.
 Final result of restricted band edge was shown in tabular data.

Radiated Spurious Emission

Test place	Ise EMC Lab.	
Semi Anechoic Chamber	No.4	No.4
Date	March 25, 2024	March 28, 2024
Temperature / Humidity	20 deg. C / 40 % RH	23 deg. C / 37 % RH
Engineer	Shousei Hamaguchi	Shousei Hamaguchi
Mode	(1 GHz to 6 GHz)	(6 GHz to 26.5 GHz)
	Tx 11g 2437 MHz	

Polarity	Frequency	Reading (QP / PK)	Reading (AV)	Ant. Factor	Loss	Gain	Duty Factor	Result (QP / PK)	Result (AV)	Limit (QP / PK)	Limit (AV)	Margin (QP / PK)	Margin (AV)	Remark
[Hori/Vert]	[MHz]	[dBuV]	[dBuV]	[dB/m]	[dB]	[dB]	[dB]	[dBuV/m]	[dBuV/m]	[dBuV/m]	[dBuV/m]	[dB]	[dB]	
Hori.	4108.3	44.8	35.8	30.0	7.5	31.0	-	51.2	42.2	73.9	53.9	22.7	11.7	
Hori.	4874.0	40.3	31.8	31.4	7.7	30.8	-	48.5	40.1	73.9	53.9	25.4	13.9	Floor noise
Hori.	7311.0	40.8	31.9	35.6	11.0	32.1	-	55.4	46.5	73.9	53.9	18.5	7.5	Floor noise
Hori.	9748.0	40.0	30.9	36.0	12.1	32.4	-	55.8	46.6	73.9	53.9	18.1	7.3	Floor noise
Vert.	4108.3	45.4	36.2	30.0	7.5	31.0	-	51.8	42.6	73.9	53.9	22.1	11.3	
Vert.	4874.0	40.3	31.9	31.4	7.7	30.8	-	48.5	40.1	73.9	53.9	25.4	13.8	Floor noise
Vert.	7311.0	40.8	31.9	35.6	11.0	32.1	-	55.4	46.5	73.9	53.9	18.5	7.5	Floor noise
Vert.	9748.0	40.0	30.9	36.0	12.1	32.4	-	55.8	46.6	73.9	53.9	18.1	7.3	Floor noise

Result (QP / PK) = Reading + Ant Factor + Loss (Cable+Attenuator+Filter+Distance factor(above 1 GHz)) - Gain(Amplifier)
 Result (AV)= Reading + Ant Factor + Loss (Cable+Attenuator+Filter+Distance factor(above 1 GHz)) - Gain(Amplifier) + Duty factor
 *Other frequency noises omitted in this report were not seen or had enough margin (more than 20 dB).
 *QP detector was used up to 1GHz.

Distance factor:	1 GHz - 6 GHz	20log (3.8 m / 3.0 m) = 2.06 dB
	6 GHz - 10 GHz	20log (4.8 m / 3.0 m) = 4.09 dB
	10 GHz - 40 GHz	20log (1.0 m / 3.0 m) = -9.54 dB

Radiated Spurious Emission

Test place	Ise EMC Lab.	No.4
Semi Anechoic Chamber	No.4	No.4
Date	March 25, 2024	March 28, 2024
Temperature / Humidity	20 deg. C / 40 % RH	23 deg. C / 37 % RH
Engineer	Shousei Hamaguchi	Shousei Hamaguchi
Mode	(1 GHz to 6 GHz)	(6 GHz to 26.5 GHz)
	Tx 11g 2462 MHz	

Polarity	Frequency	Reading (QP / PK)	Reading (AV)	Ant. Factor	Loss	Gain	Duty Factor	Result (QP / PK)	Result (AV)	Limit (QP / PK)	Limit (AV)	Margin (QP / PK)	Margin (AV)	Remark
[Hori/Vert]	[MHz]	[dBuV]	[dBuV]	[dB/m]	[dB]	[dB]	[dB]	[dBuV/m]	[dBuV/m]	[dBuV/m]	[dBuV/m]	[dB]	[dB]	
Hori.	2483.5	42.6	33.8	27.7	5.4	31.7	0.6	44.0	35.8	73.9	53.9	29.9	18.1	*1)
Hori.	4108.3	44.6	35.8	30.0	7.5	31.0	-	51.0	42.2	73.9	53.9	22.9	11.7	
Hori.	4924.0	39.4	29.9	31.5	7.7	30.8	-	47.7	38.2	73.9	53.9	26.2	15.7	Floor noise
Hori.	7386.0	41.4	31.9	35.6	11.1	32.1	-	55.9	46.4	73.9	53.9	18.0	7.6	Floor noise
Hori.	9848.0	40.4	31.8	36.2	12.2	32.4	-	56.3	47.7	73.9	53.9	17.6	6.2	Floor noise
Vert.	2483.5	43.9	34.7	27.7	5.4	31.7	0.6	45.3	36.6	73.9	53.9	28.6	17.3	*1)
Vert.	4108.3	45.4	36.3	30.0	7.5	31.0	-	51.8	42.7	73.9	53.9	22.1	11.2	
Vert.	4924.0	39.4	29.9	31.5	7.7	30.8	-	47.7	38.2	73.9	53.9	26.2	15.7	Floor noise
Vert.	7386.0	41.4	31.9	35.6	11.1	32.1	-	55.9	46.4	73.9	53.9	18.0	7.6	Floor noise
Vert.	9848.0	40.4	31.8	36.2	12.2	32.4	-	56.3	47.7	73.9	53.9	17.6	6.2	Floor noise

Result (QP / PK) = Reading + Ant Factor + Loss (Cable+Attenuator+Filter+Distance factor(above 1 GHz)) - Gain(Amplifier)

Result (AV)= Reading + Ant Factor + Loss (Cable+Attenuator+Filter+Distance factor(above 1 GHz)) - Gain(Amplifier) + Duty factor

*Other frequency noises omitted in this report were not seen or had enough margin (more than 20 dB).

*QP detector was used up to 1GHz.

*1) Not Out of Band emission(Leakage Power)

Distance factor:	1 GHz - 6 GHz	20log (3.8 m / 3.0 m) = 2.06 dB
	6 GHz - 10 GHz	20log (4.8 m / 3.0 m) = 4.09 dB
	10 GHz - 40 GHz	20log (1.0 m / 3.0 m) = -9.54 dB

**Radiated Spurious Emission
 (Reference Plot for band-edge)**

Test place
 Semi Anechoic Chamber
 Date
 Temperature / Humidity
 Engineer
 Mode

Ise EMC Lab.
 No.4
 March 25, 2024
 20 deg. C / 40 % RH
 Shousei Hamaguchi
 (1 GHz to 6 GHz)
 Tx 11g 2462 MHz

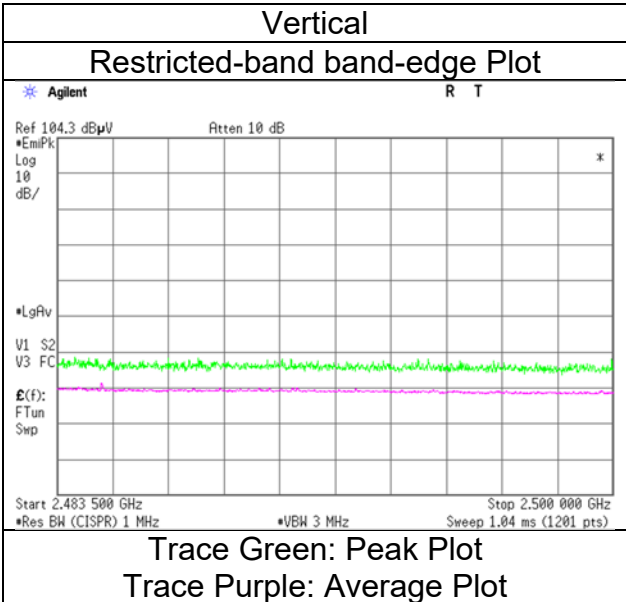
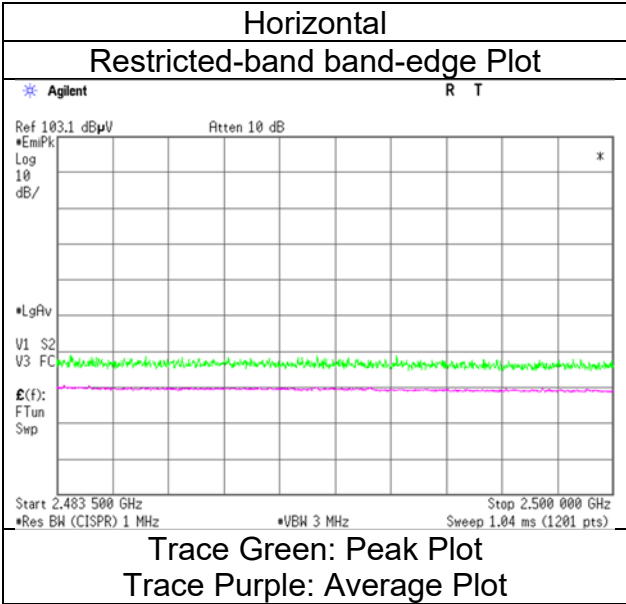

* The measurement was conducted for a sufficiently long enough time to detect any possible spurious emissions.
 Final result of restricted band edge was shown in tabular data.

Radiated Spurious Emission

Test place	Ise EMC Lab.	No.4
Semi Anechoic Chamber	No.4	No.4
Date	March 25, 2024	March 28, 2024
Temperature / Humidity	20 deg. C / 40 % RH	23 deg. C / 37 % RH
Engineer	Shousei Hamaguchi	Shousei Hamaguchi
Mode	(1 GHz to 6 GHz)	(6 GHz to 26.5 GHz)
	Tx 11n-20 2412 MHz	

Polarity	Frequency	Reading (QP / PK)	Reading (AV)	Ant. Factor	Loss	Gain	Duty Factor	Result (QP / PK)	Result (AV)	Limit (QP / PK)	Limit (AV)	Margin (QP / PK)	Margin (AV)	Remark
[Hori/Vert]	[MHz]	[dBuV]	[dBuV]	[dB/m]	[dB]	[dB]	[dB]	[dBuV/m]	[dBuV/m]	[dBuV/m]	[dBuV/m]	[dB]	[dB]	
Hori.	2390.0	43.5	34.4	27.8	5.4	31.8	0.2	44.9	36.0	73.9	53.9	29.0	17.9	*1)
Hori.	4108.3	44.6	35.6	30.0	7.5	31.0	-	51.0	42.0	73.9	53.9	22.9	11.9	
Vert.	2390.0	43.0	34.6	27.8	5.4	31.8	0.2	44.4	36.1	73.9	53.9	29.5	17.8	*1)
Vert.	4108.3	45.4	36.3	30.0	7.5	31.0	-	51.8	42.7	73.9	53.9	22.1	11.2	

Result (QP / PK) = Reading + Ant Factor + Loss (Cable+Attenuator+Filter+Distance factor(above 1 GHz)) - Gain(Amplifier)

Result (AV)= Reading + Ant Factor + Loss (Cable+Attenuator+Filter+Distance factor(above 1 GHz)) - Gain(Amplifier) + Duty factor

*Other frequency noises omitted in this report were not seen or had enough margin (more than 20 dB).

*QP detector was used up to 1GHz.

*1) Not Out of Band emission(Leakage Power)

20dBc Data Sheet

Polarity	Frequency	Reading (PK)	Ant Factor	Loss	Gain	Result	Limit	Margin	Remark
[Hori/Vert]	[MHz]	[dBuV]	[dB/m]	[dB]	[dB]	[dBuV/m]	[dBuV/m]	[dB]	
Hori.	2412.0	89.8	27.8	5.4	31.8	91.2	-	-	Carrier
Hori.	2400.0	56.7	27.8	5.4	31.8	58.1	71.2	13.2	
Vert.	2412.0	88.7	27.8	5.4	31.8	90.1	-	-	Carrier
Vert.	2400.0	52.9	27.8	5.4	31.8	54.3	70.1	15.8	

Result = Reading + Ant Factor + Loss (Cable+Attenuator+Filter+Distance factor(above 1 GHz)) - Gain(Amplifier)

Distance factor:
 1 GHz - 6 GHz 20log (3.8 m / 3.0 m) = 2.06 dB
 6 GHz - 10 GHz 20log (4.8 m / 3.0 m) = 4.09 dB
 10 GHz - 40 GHz 20log (1.0 m / 3.0 m) = -9.54 dB

**Radiated Spurious Emission
 (Reference Plot for band-edge)**

Test place	Ise EMC Lab.
Semi Anechoic Chamber	No.4
Date	March 25, 2024
Temperature / Humidity	20 deg. C / 40 % RH
Engineer	Shousei Hamaguchi
	(1 GHz to 6 GHz)
Mode	Tx 11n-20 2412 MHz

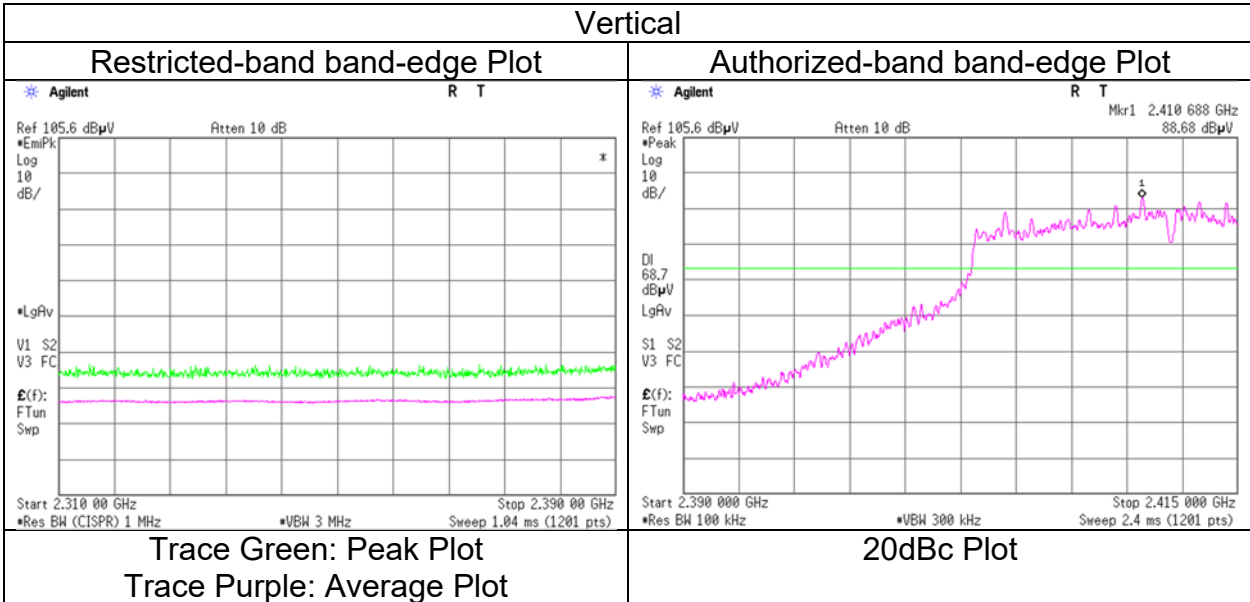
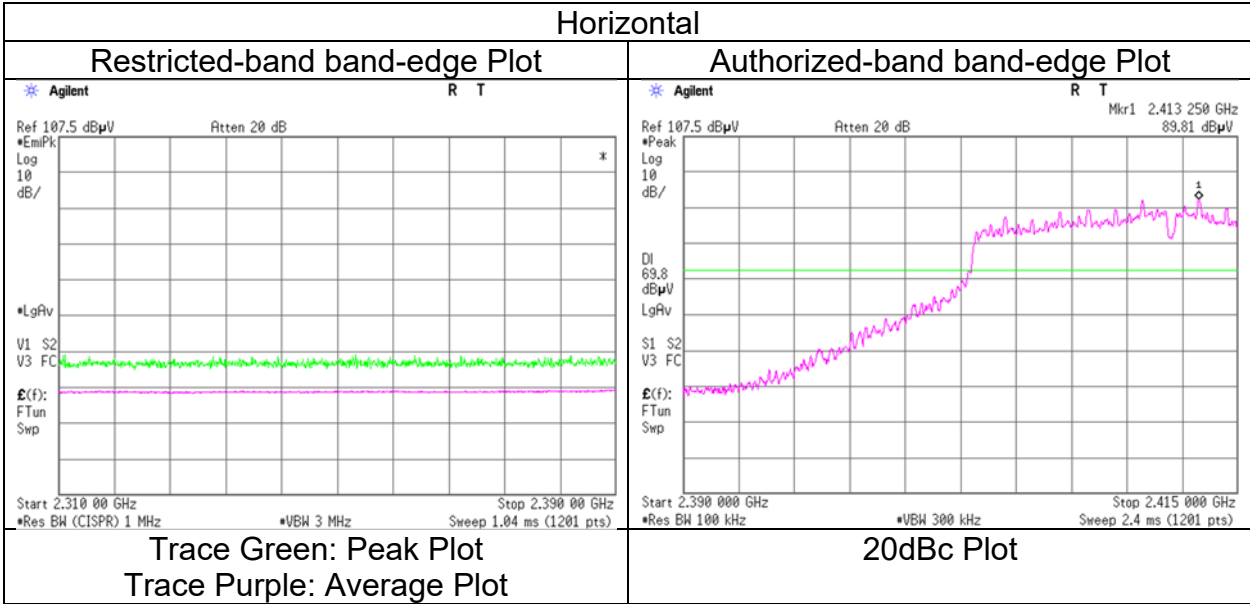

* The measurement was conducted for a sufficiently long enough time to detect any possible spurious emissions.
 Final result of restricted band edge was shown in tabular data.

Radiated Spurious Emission

Test place	Ise EMC Lab.	
Semi Anechoic Chamber	No.4	No.4
Date	March 25, 2024	March 28, 2024
Temperature / Humidity	20 deg. C / 40 % RH	23 deg. C / 37 % RH
Engineer	Shousei Hamaguchi	Shousei Hamaguchi
	(1 GHz to 6 GHz)	(6 GHz to 26.5 GHz)
Mode	Tx 11n-20 2437 MHz	

Polarity	Frequency	Reading (QP / PK)	Reading (AV)	Ant. Factor	Loss	Gain	Duty Factor	Result (QP / PK)	Result (AV)	Limit (QP / PK)	Limit (AV)	Margin (QP / PK)	Margin (AV)	Remark
[Hori/Vert]	[MHz]	[dBuV]	[dBuV]	[dB/m]	[dB]	[dB]	[dB]	[dBuV/m]	[dBuV/m]	[dBuV/m]	[dBuV/m]	[dB]	[dB]	
Hori.	4108.3	44.5	35.7	30.0	7.5	31.0	-	50.9	42.1	73.9	53.9	23.0	11.8	
Vert.	4108.3	45.3	36.1	30.0	7.5	31.0	-	51.8	42.6	73.9	53.9	22.1	11.3	

Result (QP / PK) = Reading + Ant Factor + Loss (Cable+Attenuator+Filter+Distance factor(above 1 GHz)) - Gain(Amplifier)
 Result (AV)= Reading + Ant Factor + Loss (Cable+Attenuator+Filter+Distance factor(above 1 GHz)) - Gain(Amplifier) + Duty factor
 *Other frequency noises omitted in this report were not seen or had enough margin (more than 20 dB).
 *QP detector was used up to 1GHz.

Distance factor:

1 GHz - 6 GHz	$20\log(3.8\text{ m} / 3.0\text{ m}) = 2.06\text{ dB}$
6 GHz - 10 GHz	$20\log(4.8\text{ m} / 3.0\text{ m}) = 4.09\text{ dB}$
10 GHz - 40 GHz	$20\log(1.0\text{ m} / 3.0\text{ m}) = -9.54\text{ dB}$

Radiated Spurious Emission

Test place	Ise EMC Lab.	No.4
Semi Anechoic Chamber	No.4	No.4
Date	March 25, 2024	March 28, 2024
Temperature / Humidity	20 deg. C / 40 % RH	23 deg. C / 37 % RH
Engineer	Shousei Hamaguchi	Shousei Hamaguchi
Mode	(1 GHz to 6 GHz)	(6 GHz to 26.5 GHz)
	Tx 11n-20 2462 MHz	

Polarity	Frequency	Reading (QP / PK)	Reading (AV)	Ant. Factor	Loss	Gain	Duty Factor	Result (QP / PK)	Result (AV)	Limit (QP / PK)	Limit (AV)	Margin (QP / PK)	Margin (AV)	Remark
[Hori/Vert]	[MHz]	[dBuV]	[dBuV]	[dB/m]	[dB]	[dB]	[dB]	[dBuV/m]	[dBuV/m]	[dBuV/m]	[dBuV/m]	[dB]	[dB]	
Hori.	2483.5	44.5	35.7	27.7	5.4	31.7	0.2	45.9	37.3	73.9	53.9	28.0	16.6	*1)
Hori.	4108.3	44.9	35.7	30.0	7.5	31.0	-	51.3	42.1	73.9	53.9	22.6	11.8	
Vert.	2483.5	43.1	35.0	27.7	5.4	31.7	0.2	44.5	36.6	73.9	53.9	29.4	17.4	*1)
Vert.	4108.3	45.3	36.3	30.0	7.5	31.0	-	51.7	42.7	73.9	53.9	22.2	11.2	

Result (QP / PK) = Reading + Ant Factor + Loss (Cable+Attenuator+Filter+Distance factor(above 1 GHz)) - Gain(Amplifier)

Result (AV)= Reading + Ant Factor + Loss (Cable+Attenuator+Filter+Distance factor(above 1 GHz)) - Gain(Amplifier) + Duty factor

*Other frequency noises omitted in this report were not seen or had enough margin (more than 20 dB).

*QP detector was used up to 1GHz.

*1) Not Out of Band emission(Leakage Power)

Distance factor:	1 GHz - 6 GHz	20log (3.8 m / 3.0 m) = 2.06 dB
	6 GHz - 10 GHz	20log (4.8 m / 3.0 m) = 4.09 dB
	10 GHz - 40 GHz	20log (1.0 m / 3.0 m) = -9.54 dB

**Radiated Spurious Emission
 (Reference Plot for band-edge)**

Test place
 Semi Anechoic Chamber
 Date
 Temperature / Humidity
 Engineer
 Mode

Ise EMC Lab.
 No.4
 March 25, 2024
 20 deg. C / 40 % RH
 Shousei Hamaguchi
 (1 GHz to 6 GHz)
 Tx 11n-20 2462 MHz

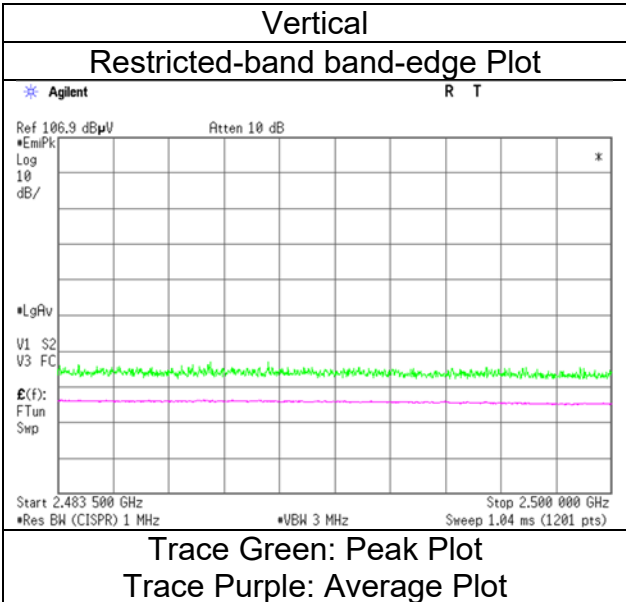
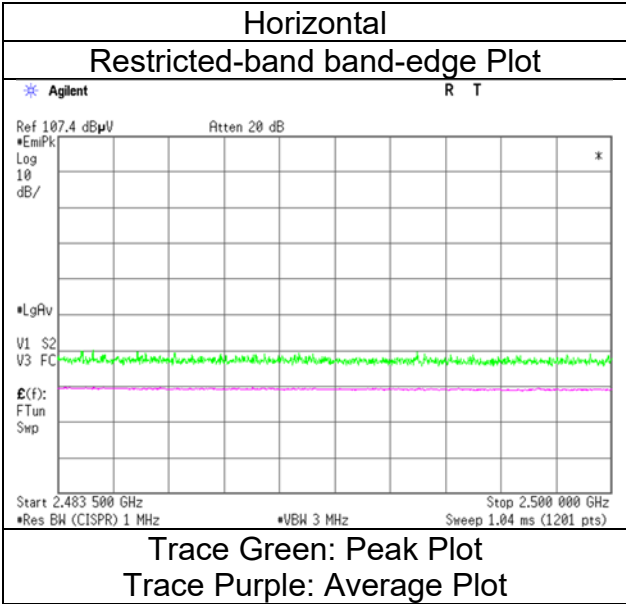

* The measurement was conducted for a sufficiently long enough time to detect any possible spurious emissions.
 Final result of restricted band edge was shown in tabular data.

Radiated Spurious Emission

Test place	Ise EMC Lab.	No.4
Semi Anechoic Chamber	No.4	No.4
Date	March 25, 2024	March 28, 2024
Temperature / Humidity	20 deg. C / 40 % RH	23 deg. C / 37 % RH
Engineer	Shousei Hamaguchi	Shousei Hamaguchi
	(1 GHz to 6 GHz)	(6 GHz to 26.5 GHz)
Mode	Tx 11n-40 2432 MHz	

Polarity	Frequency	Reading (QP / PK)	Reading (AV)	Ant. Factor	Loss	Gain	Duty Factor	Result (QP / PK)	Result (AV)	Limit (QP / PK)	Limit (AV)	Margin (QP / PK)	Margin (AV)	Remark
[Hori/Vert]	[MHz]	[dBuV]	[dBuV]	[dB/m]	[dB]	[dB]	[dB]	[dBuV/m]	[dBuV/m]	[dBuV/m]	[dBuV/m]	[dB]	[dB]	
Hori.	2390.0	43.2	34.0	27.8	5.4	31.8	5.1	44.6	40.5	73.9	53.9	29.3	13.4	*1)
Hori.	4108.3	44.7	35.7	30.0	7.5	31.0	-	51.2	42.2	73.9	53.9	22.7	11.7	
Hori.	4844.0	39.5	32.1	31.4	7.6	30.8	-	47.7	40.3	73.9	53.9	26.2	13.7	Floor noise
Hori.	7296.0	42.2	33.3	35.7	11.0	32.1	-	56.8	47.8	73.9	53.9	17.1	6.1	Floor noise
Hori.	9728.0	40.1	31.8	36.0	12.1	32.4	-	55.8	47.5	73.9	53.9	18.1	6.4	Floor noise
Vert.	2390.0	44.0	34.9	27.8	5.4	31.8	5.1	45.4	41.4	73.9	53.9	28.5	12.5	*1)
Vert.	4108.3	45.3	36.1	30.0	7.5	31.0	-	51.8	42.6	73.9	53.9	22.1	11.4	
Vert.	4844.0	39.5	32.1	31.4	7.6	30.8	-	47.7	40.3	73.9	53.9	26.2	13.7	Floor noise
Vert.	7296.0	42.2	33.3	35.7	11.0	32.1	-	56.8	47.8	73.9	53.9	17.1	6.1	Floor noise
Vert.	9728.0	40.1	31.8	36.0	12.1	32.4	-	55.8	47.5	73.9	53.9	18.1	6.4	Floor noise

Result (QP / PK) = Reading + Ant Factor + Loss (Cable+Attenuator+Filter+Distance factor(above 1 GHz)) - Gain(Amplifier)
 Result (AV)= Reading + Ant Factor + Loss (Cable+Attenuator+Filter+Distance factor(above 1 GHz)) - Gain(Amplifier) + Duty factor
 *Other frequency noises omitted in this report were not seen or had enough margin (more than 20 dB).
 *QP detector was used up to 1GHz
 *1) Not Out of Band emission(Leakage Power)

20dBc Data Sheet

Polarity	Frequency	Reading (PK)	Ant. Factor	Loss	Gain	Result	Limit	Margin	Remark
[Hori/Vert]	[MHz]	[dBuV]	[dB/m]	[dB]	[dB]	[dBuV/m]	[dBuV/m]	[dB]	
Hori.	2432.0	84.8	27.8	5.4	31.8	86.2	-	-	Carrier
Hori.	2400.0	41.4	27.8	5.4	31.8	42.8	66.2	23.4	
Vert.	2432.0	83.5	27.8	5.4	31.8	84.8	-	-	Carrier
Vert.	2400.0	42.0	27.8	5.4	31.8	43.4	64.8	21.5	

Result = Reading + Ant Factor + Loss (Cable+Attenuator+Filter+Distance factor(above 1 GHz)) - Gain(Amplifier)
 Distance factor:
 1 GHz - 6 GHz 20log (3.8 m / 3.0 m) = 2.06 dB
 6 GHz - 10 GHz 20log (4.8 m / 3.0 m) = 4.09 dB
 10 GHz - 40 GHz 20log (1.0 m / 3.0 m) = -9.54 dB

**Radiated Spurious Emission
 (Reference Plot for band-edge)**

Test place	Ise EMC Lab.
Semi Anechoic Chamber	No.4
Date	March 25, 2024
Temperature / Humidity	20 deg. C / 40 % RH
Engineer	Shousei Hamaguchi
	(1 GHz to 6 GHz)
Mode	Tx 11n-40 2432 MHz

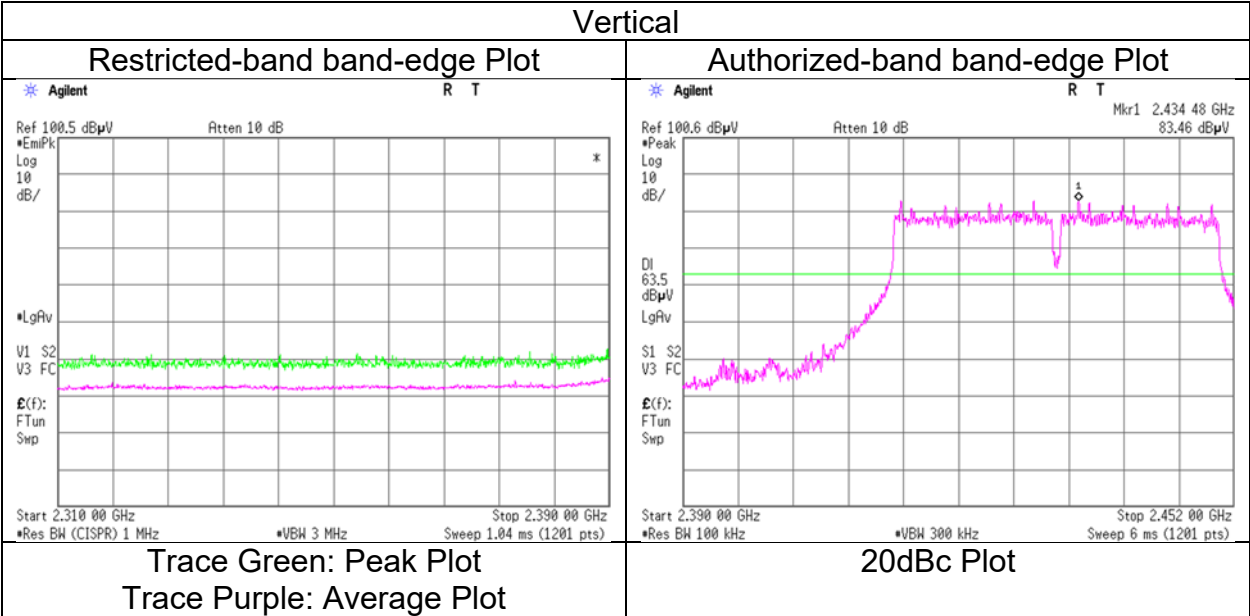
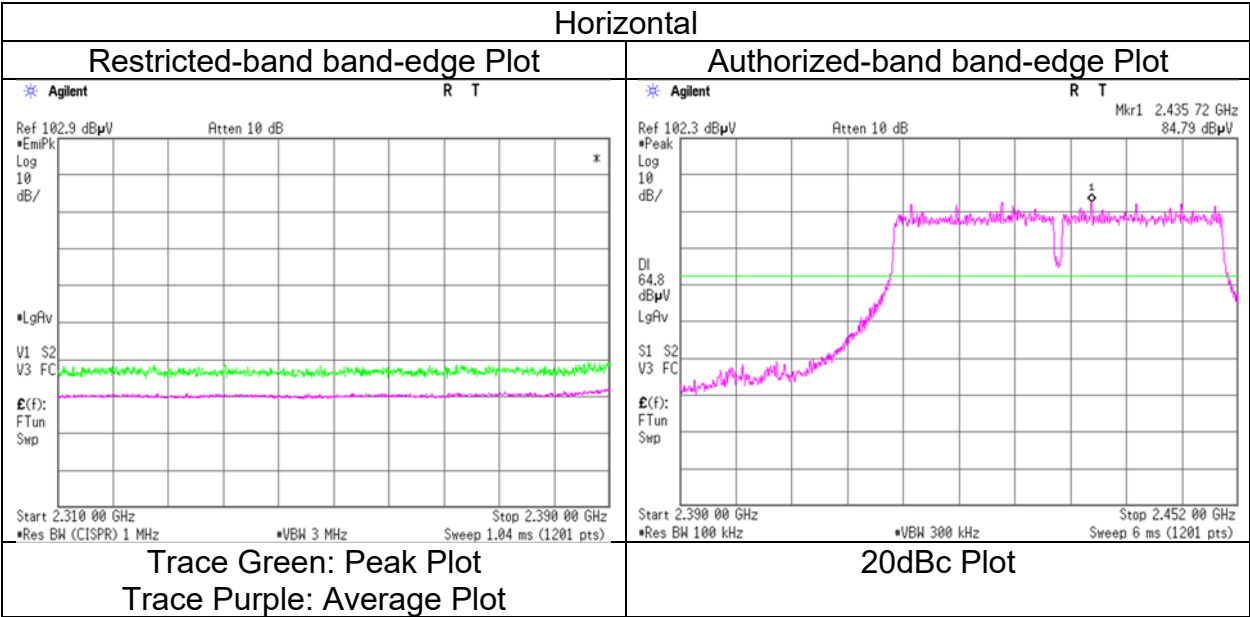

* The measurement was conducted for a sufficiently long enough time to detect any possible spurious emissions.
 Final result of restricted band edge was shown in tabular data.

Radiated Spurious Emission

Test place	Ise EMC Lab.	No.4
Semi Anechoic Chamber	No.4	No.4
Date	March 25, 2024	March 28, 2024
Temperature / Humidity	20 deg. C / 40 % RH	23 deg. C / 37 % RH
Engineer	Shousei Hamaguchi	Shousei Hamaguchi
Mode	(1 GHz to 6 GHz) Tx 11n-40 2442 MHz	(6 GHz to 26.5 GHz) No.4 March 31, 2024 20 deg. C / 46 % RH Shousei Hamaguchi (Below 1 GHz)

Polarity	Frequency	Reading (QP / PK)	Reading (AV)	Ant. Factor	Loss	Gain	Duty Factor	Result (QP / PK)	Result (AV)	Limit (QP / PK)	Limit (AV)	Margin (QP / PK)	Margin (AV)	Remark
[Hori/Vert]	[MHz]	[dBuV]	[dBuV]	[dB/m]	[dB]	[dB]	[dB]	[dBuV/m]	[dBuV/m]	[dBuV/m]	[dBuV/m]	[dB]	[dB]	
Hori.	48.5	22.1	-	11.7	7.3	32.1	-	9.0	-	40.0	-	31.0	-	
Hori.	73.6	30.8	-	6.4	7.6	32.1	-	12.7	-	40.0	-	27.3	-	
Hori.	99.0	27.9	-	10.2	7.8	32.0	-	13.8	-	43.5	-	29.7	-	
Hori.	295.9	37.2	-	13.6	9.5	32.0	-	28.4	-	46.0	-	17.6	-	
Hori.	358.9	27.3	-	15.1	9.9	32.1	-	20.2	-	46.0	-	25.8	-	
Hori.	624.4	20.5	-	19.4	11.4	32.3	-	19.0	-	46.0	-	27.0	-	
Hori.	4108.3	44.6	35.6	30.0	7.5	31.0	-	51.1	42.0	73.9	53.9	22.8	11.9	
Hori.	4884.0	39.7	31.7	31.4	7.7	30.8	-	47.9	40.0	73.9	53.9	26.0	13.9	Floor noise
Hori.	7326.0	41.6	32.0	35.6	11.0	32.1	-	56.2	46.5	73.9	53.9	17.7	7.4	Floor noise
Hori.	9768.0	40.0	31.2	36.0	12.1	32.4	-	55.8	47.0	73.9	53.9	18.1	6.9	Floor noise
Vert.	48.5	29.1	-	11.7	7.3	32.1	-	16.0	-	40.0	-	24.0	-	
Vert.	73.6	33.8	-	6.4	7.6	32.1	-	15.7	-	40.0	-	24.3	-	
Vert.	99.0	32.5	-	10.2	7.8	32.0	-	18.4	-	43.5	-	25.1	-	
Vert.	295.9	29.2	-	13.6	9.5	32.0	-	20.4	-	46.0	-	25.6	-	
Vert.	358.9	26.8	-	15.1	9.9	32.1	-	19.7	-	46.0	-	26.3	-	
Vert.	624.4	20.3	-	19.4	11.4	32.3	-	18.8	-	46.0	-	27.2	-	
Vert.	4108.3	45.3	36.2	30.0	7.5	31.0	-	51.8	42.7	73.9	53.9	22.1	11.2	
Vert.	4884.0	39.7	31.7	31.4	7.7	30.8	-	47.9	40.0	73.9	53.9	26.0	13.9	Floor noise
Vert.	7326.0	41.6	32.0	35.6	11.0	32.1	-	56.2	46.5	73.9	53.9	17.7	7.4	Floor noise
Vert.	9768.0	40.0	31.2	36.0	12.1	32.4	-	55.8	47.0	73.9	53.9	18.1	6.9	Floor noise

Result (QP / PK) = Reading + Ant Factor + Loss (Cable+Attenuator+Filter+Distance factor(above 1 GHz)) - Gain(Amplifier)

Result (AV)= Reading + Ant Factor + Loss (Cable+Attenuator+Filter+Distance factor(above 1 GHz)) - Gain(Amplifier) + Duty factor

*Other frequency noises omitted in this report were not seen or had enough margin (more than 20 dB).

*QP detector was used up to 1GHz.

Distance factor: 1 GHz - 6 GHz 20log (3.8 m / 3.0 m) = 2.06 dB
 6 GHz - 10 GHz 20log (4.8 m / 3.0 m) = 4.09 dB
 10 GHz - 40 GHz 20log (1.0 m / 3.0 m) = -9.54 dB

Radiated Spurious Emission

Test place	Ise EMC Lab.	
Semi Anechoic Chamber	No.4	No.4
Date	March 25, 2024	March 28, 2024
Temperature / Humidity	20 deg. C / 40 % RH	23 deg. C / 37 % RH
Engineer	Shousei Hamaguchi	Shousei Hamaguchi
Mode	(1 GHz to 6 GHz)	(6 GHz to 26.5 GHz)
	Tx 11n-40 2452 MHz	

Polarity	Frequency	Reading (QP / PK)	Reading (AV)	Ant. Factor	Loss	Gain	Duty Factor	Result (QP / PK)	Result (AV)	Limit (QP / PK)	Limit (AV)	Margin (QP / PK)	Margin (AV)	Remark
[Hori/Vert]	[MHz]	[dBuV]	[dBuV]	[dB/m]	[dB]	[dB]	[dB]	[dBuV/m]	[dBuV/m]	[dBuV/m]	[dBuV/m]	[dB]	[dB]	
Hori.	2483.5	47.9	33.3	27.7	5.4	31.7	5.1	49.3	39.8	73.9	53.9	24.6	14.1	*1)
Hori.	2485.7	46.7	33.1	27.7	5.4	31.7	-	48.1	34.5	73.9	53.9	25.9	19.4	
Hori.	4108.3	44.6	35.6	30.0	7.5	31.0	-	51.0	42.0	73.9	53.9	22.9	11.9	
Hori.	4904.0	40.1	31.7	31.4	7.7	30.8	-	48.4	40.0	73.9	53.9	25.6	13.9	Floor noise
Hori.	7356.0	40.6	33.2	35.6	11.1	32.1	-	55.2	47.7	73.9	53.9	18.7	6.2	Floor noise
Hori.	9808.0	41.7	31.8	36.1	12.2	32.4	-	57.6	47.7	73.9	53.9	16.3	6.2	Floor noise
Vert.	2483.5	45.8	32.6	27.7	5.4	31.7	5.1	47.2	39.1	73.9	53.9	26.7	14.8	*1)
Vert.	2484.5	46.0	32.9	27.7	5.4	31.7	-	47.4	34.4	73.9	53.9	26.5	19.6	
Vert.	4108.3	45.5	36.4	30.0	7.5	31.0	-	51.9	42.9	73.9	53.9	22.0	11.1	
Vert.	4904.0	40.1	31.7	31.4	7.7	30.8	-	48.4	40.0	73.9	53.9	25.6	13.9	Floor noise
Vert.	7356.0	40.6	33.2	35.6	11.1	32.1	-	55.2	47.7	73.9	53.9	18.7	6.2	Floor noise
Vert.	9808.0	41.7	31.8	36.1	12.2	32.4	-	57.6	47.7	73.9	53.9	16.3	6.2	Floor noise

Result (QP / PK) = Reading + Ant Factor + Loss (Cable+Attenuator+Filter+Distance factor(above 1 GHz)) - Gain(Amplifier)
 Result (AV)= Reading + Ant Factor + Loss (Cable+Attenuator+Filter+Distance factor(above 1 GHz)) - Gain(Amplifier) + Duty factor
 *Other frequency noises omitted in this report were not seen or had enough margin (more than 20 dB).
 *QP detector was used up to 1GHz.
 *1) Not Out of Band emission(Leakage Power)

Distance factor: 1 GHz - 6 GHz 20log (3.8 m / 3.0 m) = 2.06 dB
 6 GHz - 10 GHz 20log (4.8 m / 3.0 m) = 4.09 dB
 10 GHz - 40 GHz 20log (1.0 m / 3.0 m) = -9.54 dB

**Radiated Spurious Emission
(Reference Plot for band-edge)**

Test place
Semi Anechoic Chamber
Date
Temperature / Humidity
Engineer

Mode

Ise EMC Lab.
No.4
March 25, 2024
20 deg. C / 40 % RH
Shousei Hamaguchi
(1 GHz to 6 GHz)
Tx 11n-40 2452 MHz

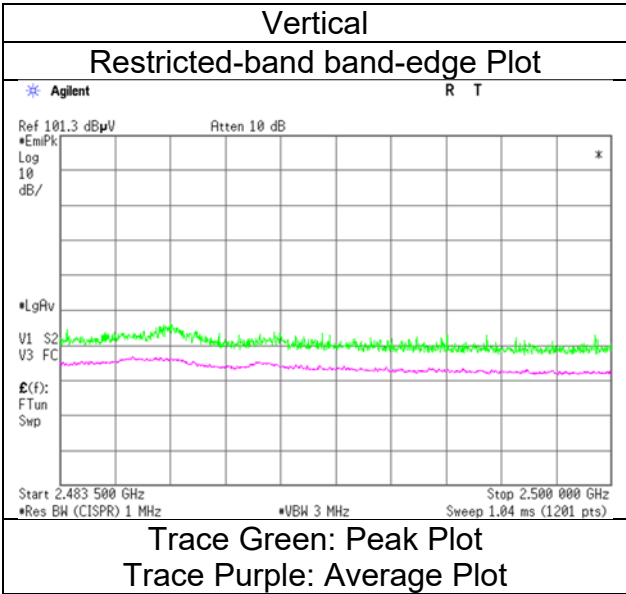
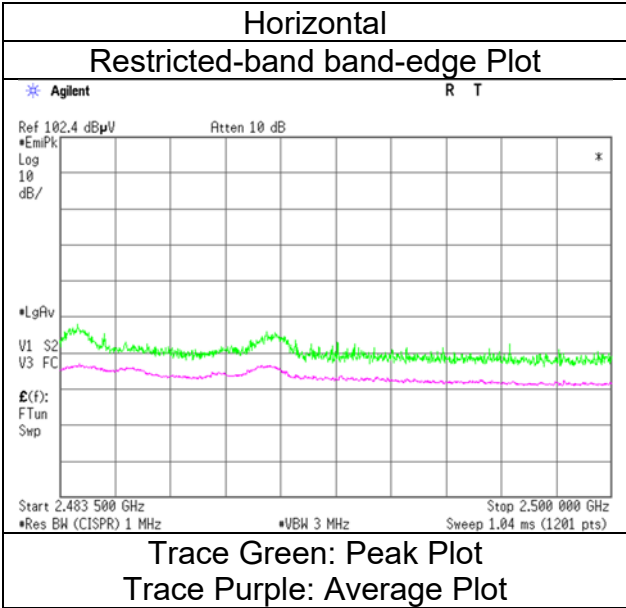

* The measurement was conducted for a sufficiently long enough time to detect any possible spurious emissions.
Final result of restricted band edge was shown in tabular data.

Radiated Spurious Emission
(Plot data, Worst case mode for Maximum Peak Output Power)

Test place	Ise EMC Lab.	No.4	No.4
Semi Anechoic Chamber	No.4	No.4	No.4
Date	March 25, 2024	March 28, 2024	March 31, 2024
Temperature / Humidity	20 deg. C / 40 % RH	23 deg. C / 37 % RH	20 deg. C / 46 % RH
Engineer	Shousei Hamaguchi	Shousei Hamaguchi	Shousei Hamaguchi
Mode	(1 GHz to 6 GHz) Tx 11n-40 2442 MHz	(6 GHz to 26.5 GHz)	(Below 1 GHz)

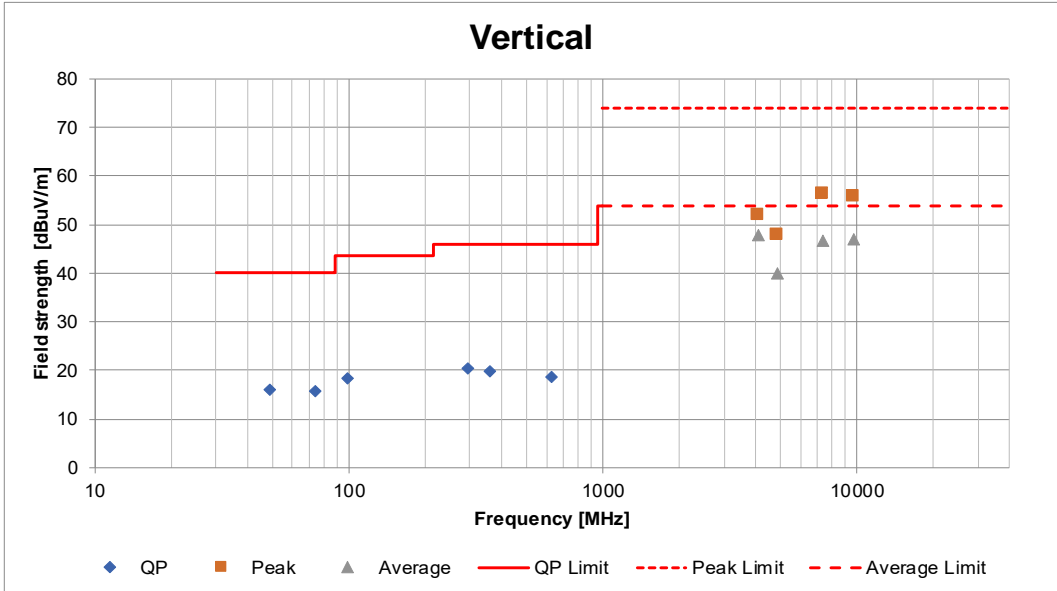
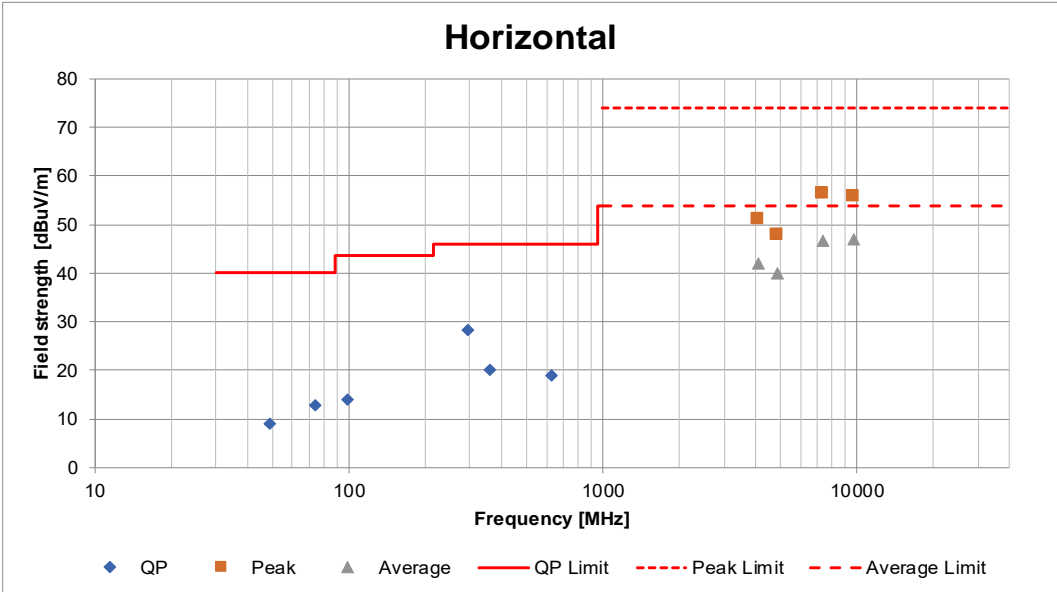

*These plots data contain sufficient number to show the trend of characteristic features for EUT.

Conducted Spurious Emission

Test place Ise EMC Lab. No.6 Measurement Room
 Date April 2, 2024
 Temperature / Humidity 24 deg. C / 52 % RH
 Engineer Hiroki Numata
 Mode Tx 11n-40 2442 MHz

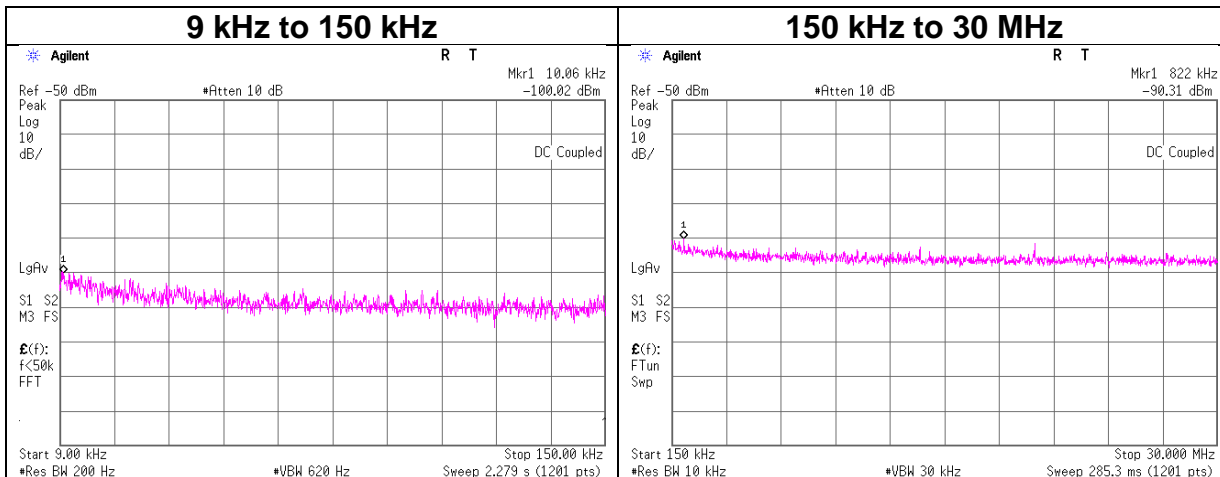

Frequency [kHz]	Reading [dBm]	Cable Loss [dB]	Attenuator Loss [dB]	Antenna Gain [dBi]	N (Number of Output)	EIRP [dBm]	Distance [m]	Ground bounce [dB]	E (field strength) [dBuV/m]	Limit [dBuV/m]	Margin [dB]	Remark
10.06	-100.0	0.01	9.8	2.2	2	-85.0	300	6.0	-23.7	47.5	71.2	
822.00	-90.3	0.02	9.8	2.2	2	-75.2	30	6.0	6.0	29.3	23.3	

$E [dBuV/m] = EIRP [dBm] - 20 \log (Distance [m]) + Ground\ bounce [dB] + 104.8 [dBuV/m]$

$EIRP [dBm] = Reading [dBm] + Cable\ loss [dB] + Attenuator\ Loss [dB] + Antenna\ gain [dBi] + 10 * \log (N)$

N: Number of output

Power Density

Test place	Ise EMC Lab. No.6 Measurement Room
Date	April 1, 2024
Temperature / Humidity	24 deg. C / 52 % RH
Engineer	Hiroki Numata
Mode	Tx

11b Antenna 1

Freq. [MHz]	Reading [dBm / 3 kHz]	Cable Loss [dB]	Atten. Loss [dB]	Result [dBm / 3 kHz]	Limit [dBm / 3 kHz]	Margin [dB]
2412	-12.19	2.16	10.10	0.07	8.00	7.93
2437	-15.86	2.16	10.10	-3.60	8.00	11.60
2462	-11.60	2.17	10.10	0.67	8.00	7.33

11g Antenna 1

Freq. [MHz]	Reading [dBm / 3 kHz]	Cable Loss [dB]	Atten. Loss [dB]	Result [dBm / 3 kHz]	Limit [dBm / 3 kHz]	Margin [dB]
2412	-32.72	2.16	10.10	-20.46	8.00	28.46
2437	-33.17	2.16	10.10	-20.91	8.00	28.91
2462	-32.25	2.17	10.10	-19.98	8.00	27.98

Sample Calculation:

Result = Reading + Cable Loss (including the cable(s) customer supplied) + Attenuator Loss

Power Density

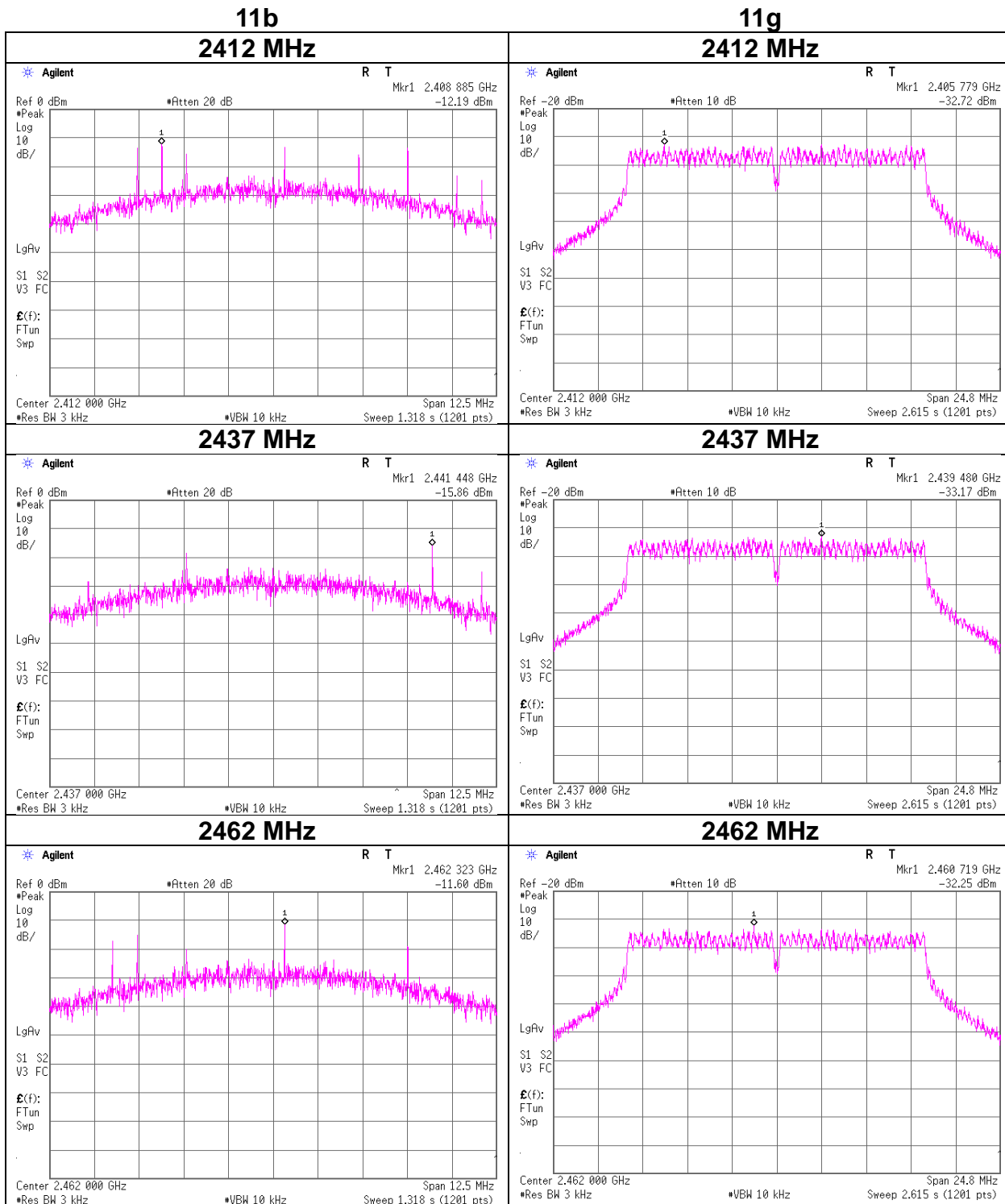

Power Density

11n-20 Antenna 0

11n-20 Antenna 1

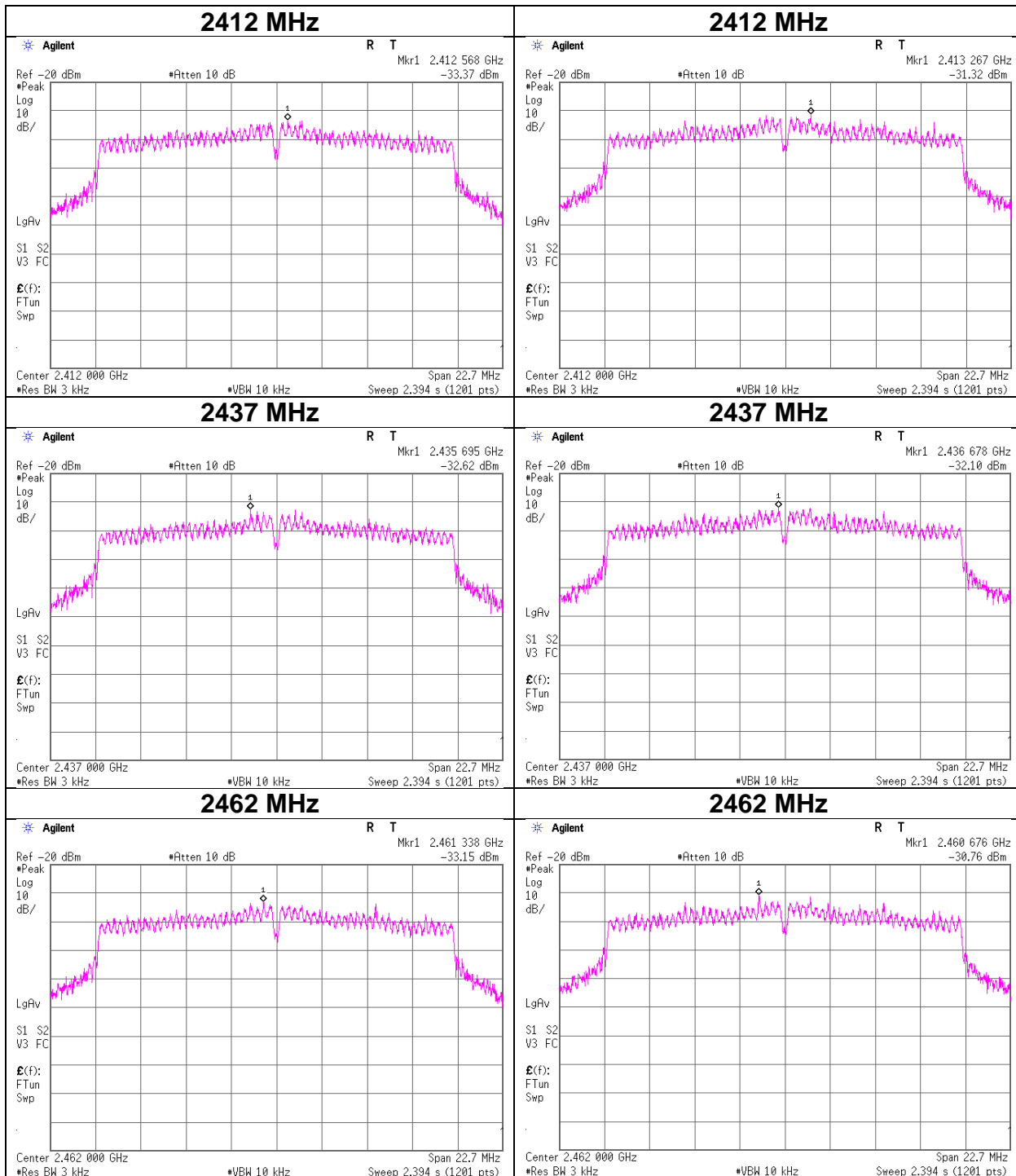

Power Density

Test place Ise EMC Lab. No.6 Measurement Room
 Date April 1, 2024
 Temperature / Humidity 24 deg. C / 52 % RH
 Engineer Hiroki Numata
 Mode Tx 11n-40

Antenna 0 +1

Freq. [MHz]	Antenna 1 Result	Antenna 2 Result	Result		Limit	Margin
	[mW / 3 kHz]	[mW / 3 kHz]	[dBm / 3 kHz]	[mW / 3 kHz]	[dBm / 3 kHz]	[dB]
2412	0.003	0.006	-20.85	0.008	8.00	28.85
2437	0.003	0.005	-20.91	0.008	8.00	28.91
2462	0.003	0.007	-20.02	0.010	8.00	28.02

Sample Calculation:

Result = Antenna 0 + 1

Antenna 0

Freq. [MHz]	Reading	Cable Loss [dB]	Atten. Loss [dB]	Result		Limit [dBm / 3 kHz]	Margin [dB]
	[dBm / 3 kHz]			[dBm / 3 kHz]	[mW / 3 kHz]		
2432	-37.93	2.17	10.10	-25.66	0.003	8.00	33.66
2442	-37.52	2.17	10.10	-25.25	0.003	8.00	33.25
2452	-37.54	2.18	10.10	-25.26	0.003	8.00	33.26

Antenna 1

Freq. [MHz]	Reading	Cable Loss [dB]	Atten. Loss [dB]	Result		Limit [dBm / 3 kHz]	Margin [dB]
	[dBm / 3 kHz]			[dBm / 3 kHz]	[mW / 3 kHz]		
2432	-34.85	2.16	10.10	-22.59	0.006	8.00	30.59
2442	-35.17	2.16	10.10	-22.91	0.005	8.00	30.91
2452	-33.83	2.17	10.10	-21.56	0.007	8.00	29.56

Sample Calculation:

Result = Reading + Cable Loss (including the cable(s) customer supplied) + Attenuator Loss

Power Density

11n-40 Antenna 0
2432 MHz

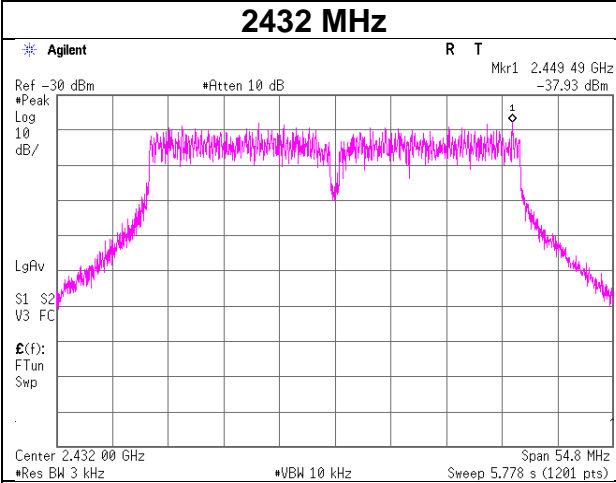

11n-40 Antenna 1
2432 MHz

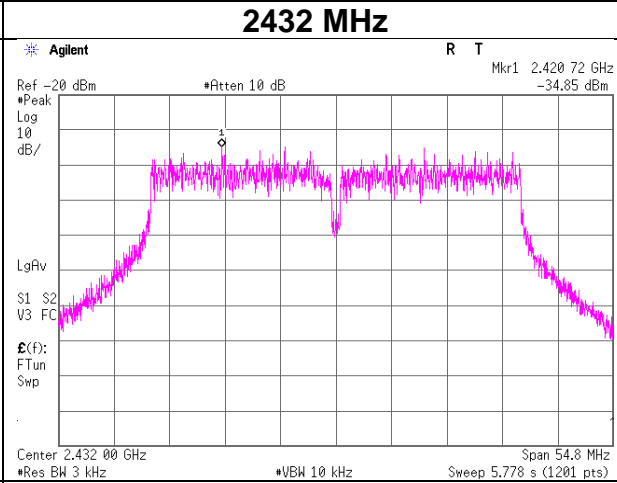

2442 MHz

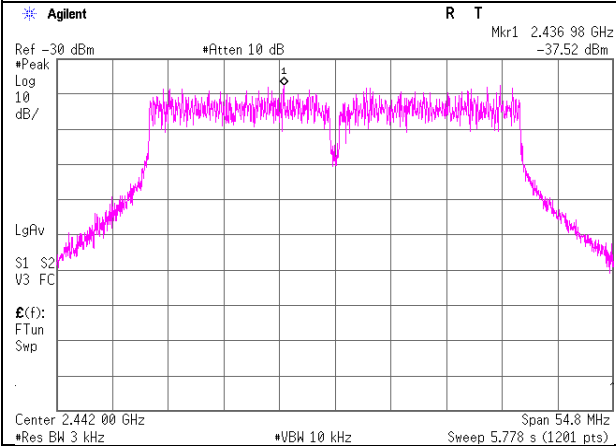

2442 MHz

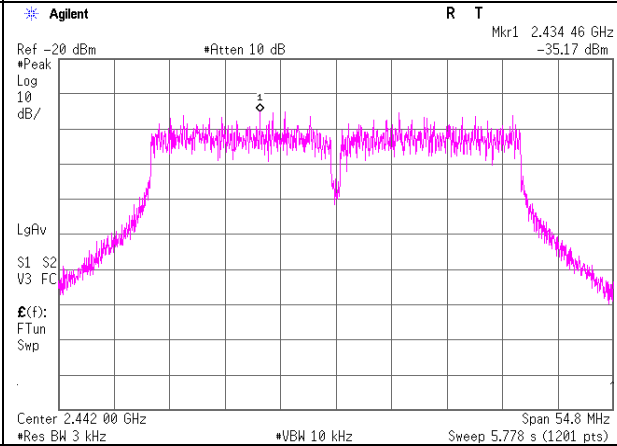

2452 MHz

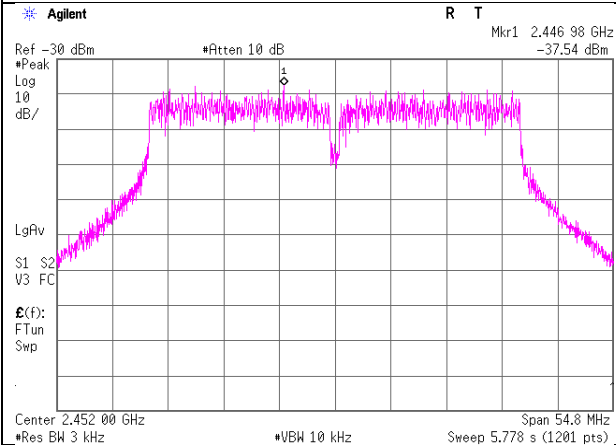

2452 MHz

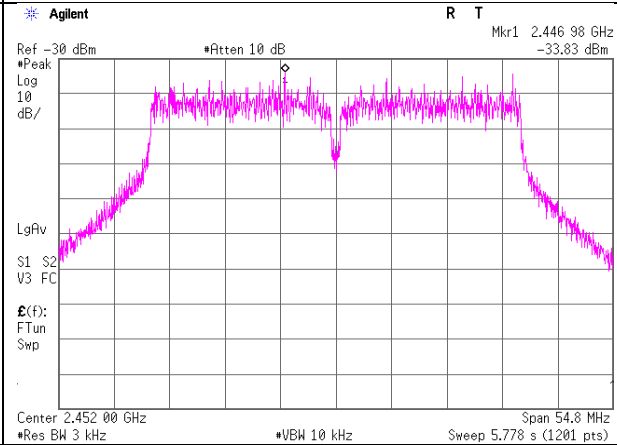

APPENDIX 2: Test Instruments

Test equipment

Test Item	LIMS ID	Description	Manufacturer	Model	Serial	Last Calibration Date	Cal Int
AT	141156	Attenuator(10dB)	Weinschel Corp	2	BL1173	11/17/2023	12
AT	141173	Attenuator(10dB) (above1GHz)	HIROSE ELECTRIC CO.,LTD.	AT-110	-	12/11/2023	12
AT	141327	Coaxial Cable	UL Japan	-	-	02/09/2024	12
AT	141329	Microwave Cable 1G-40GHz	Suhner	SUCOFLEX102	28635/2	04/08/2024	12
AT	141545	DIGITAL HiTESTER	HIOKI E.E. CORPORATION	3805	51201148	02/01/2024	12
AT	141558	Digital Tester(TRUE RMS MULTIMETER)	Fluke Corporation	115	17930030	05/29/2023	12
AT	141809	Power Meter	Anritsu Corporation	ML2495A	825002	05/26/2023	12
AT	141830	Power sensor	Anritsu Corporation	MA2411B	738285	05/26/2023	12
AT	141885	Spectrum Analyzer	Keysight Technologies Inc	E4448A	US44300523	11/29/2023	12
AT	141901	Spectrum Analyzer	Keysight Technologies Inc	E4440A	MY48250080	01/26/2024	12
AT	142011	AC4_Semi Anechoic Chamber(NSA)	TDK	Semi Anechoic Chamber 3m	DA-10005	12/13/2023	24
AT	197219	Microwave cable	Huber+Suhner	SF126E/11PC35/ 11PC35/2000MM	536999/126E	03/19/2024	12
AT	244710	Thermo-Hygrometer	HIOKI E.E. CORPORATION	LR5001	231202104	01/25/2024	12
AT	244712	Thermo-Hygrometer	HIOKI E.E. CORPORATION	LR5001	231202106	01/25/2024	12
RE	141267	Logperiodic Antenna (200-1000MHz)	Schwarzbeck Mess- Elektronik OHG	VUSLP9111B	9111B-192	09/21/2023	12
RE	141296	High Pass Filter 3.5-18.0GHz	UL Japan	HPF SELECTOR	002	09/01/2023	12
RE	141331	Attenuator(6dB)	TME	UFA-01	-	02/17/2024	12
RE	141397	Coaxial Cable	UL Japan	-	-	11/22/2023	12
RE	141425	Biconical Antenna	Schwarzbeck Mess- Elektronik OHG	VHA9103+BBA9106	VHA 91031302	08/10/2023	12
RE	141506	Horn Antenna 15-40GHz	Schwarzbeck Mess- Elektronik OHG	BBHA9170	BBHA9170307	08/09/2023	12
RE	141508	Horn Antenna 1-18GHz	Schwarzbeck Mess- Elektronik OHG	BBHA9120D	557	05/17/2023	12
RE	141545	DIGITAL HiTESTER	HIOKI E.E. CORPORATION	3805	51201148	02/01/2024	12
RE	141581	MicroWave System Amplifier	Keysight Technologies Inc	83017A	00650	10/05/2023	12
RE	141583	Pre Amplifier	SONOMA INSTRUMENT	310	260833	04/04/2024	12
RE	141901	Spectrum Analyzer	Keysight Technologies Inc	E4440A	MY48250080	01/26/2024	12
RE	141951	EMI Test Receiver	Rohde & Schwarz	ESR26	101408	04/10/2023	12
RE	141978	Spectrum Analyzer	Keysight Technologies Inc	E4448A	MY46180899	03/06/2023 *1)	12
RE	142011	AC4_Semi Anechoic Chamber(NSA)	TDK	Semi Anechoic Chamber 3m	DA-10005	12/13/2023	24
RE	142017	AC4_Semi Anechoic Chamber(SVSWR)	TDK	Semi Anechoic Chamber 3m	DA-10005	10/11/2023	12
RE	142230	Measure, Tape, Steel	KOMELON	KMC-36	-	-	-
RE	178648	EMI measurement program	TSJ (Techno Science Japan)	TEPTO-DV	-	-	-
RE	234602	Microwave Cable	Huber+Suhner	SF126E/11PC35/ 11PC35/ 1000M,5000M	537063/126E / 537074/126E	03/08/2024	12
RE	238713	Double Ridge Horn Antenna	Schwarzbeck Mess- Elektronik OHG	BBHA 9120 C	688	08/10/2023	12
RE	244710	Thermo-Hygrometer	HIOKI E.E. CORPORATION	LR5001	231202104	01/25/2024	12

*Hyphens for Last Calibration Date and Cal Int (month) are instruments that Calibration is not required (e.g. software), or instruments checked in advance before use.

The expiration date of the calibration is the end of the expired month.

As for some calibrations performed after the tested dates, those test equipment have been controlled by means of an unbroken chains of calibrations.

The expiration*1) This test equipment was used for the tests before the expiration date of the calibration.

All equipment is calibrated with valid calibrations. Each measurement data is traceable to the national or international standards.

Test item:

AT: Antenna Terminal Conducted test

RE: Radiated Emission