



# RADIO TEST REPORT

**Test Report No. : 14071795S-A-R1**

**Applicant** : DENSO CORPORATION  
**Type of EUT** : Cockpit Control Unit  
**Model Number of EUT** : DNNS124  
**FCC ID** : HYQDNN124  
**Test regulation** : FCC Part 15 Subpart C: 2021  
\*Bluetooth (BR/EDR) part  
**Test Result** : Complied (Refer to SECTION 3)

1. This test report shall not be reproduced in full or partial, without the written approval of UL Japan, Inc.
2. The results in this report apply only to the sample tested.
3. This sample tested is in compliance with the limits of the above regulation.
4. The test results in this test report are traceable to the national or international standards.
5. This test report must not be used by the customer to claim product certification, approval, or endorsement by the A2LA accreditation body.
6. This test report covers Radio technical requirements.  
It does not cover administrative issues such as Manual or non-Radio test related Requirements. (if applicable)
7. The all test items in this test report are conducted by UL Japan, Inc. Shonan EMC Lab.
8. The opinions and the interpretations to the result of the description in this report are outside scopes where UL Japan has been accredited.
9. The information provided from the customer for this report is identified in SECTION 1.
10. This report is a revised version of 14071795S-A. 14071795S-A is replaced with this report.

**Date of test:** February 8 to August 12, 2021

**Representative test engineer:**   
Shiro Kobayashi  
Engineer

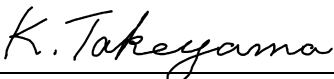
**Approved by:**   
Kazutaka Takeyama  
Leader



CERTIFICATE 1266.03

- The testing in which "Non-accreditation" is displayed is outside the accreditation scopes in UL Japan.  
 There is no testing item of "Non-accreditation".

**UL Japan, Inc.**  
**Shonan EMC Lab.**

1-22-3 Megumigaoka, Hiratsuka-shi, Kanagawa-ken, 259-1220 JAPAN  
Telephone : +81 463 50 6400  
Facsimile : +81 463 50 6401

## **REVISION HISTORY**

**Original Test Report No.: 14071795S-A**

Revision	Test report No.	Date	Page revised	Contents
- (Original)	14071795S-A	November 25, 2021	-	-
1	14071795S-A-R1	December 2, 2021	P.11	Deletion of “± 2 dB (Deviation)” Power settings of BR and EDR

---

**UL Japan, Inc.**

**Shonan EMC Lab.**

1-22-3 Megumigaoka, Hiratsuka-shi, Kanagawa-ken, 259-1220 JAPAN

Telephone : +81 463 50 6400

Facsimile : +81 463 50 6401

## Reference: Abbreviations (Including words undescribed in this report)

A2LA	The American Association for Laboratory Accreditation	MCS	Modulation and Coding Scheme
AC	Alternating Current	MRA	Mutual Recognition Arrangement
AFH	Adaptive Frequency Hopping	N/A	Not Applicable
AM	Amplitude Modulation	NIST	National Institute of Standards and Technology
Amp, AMP	Amplifier	NS	No signal detect.
ANSI	American National Standards Institute	NSA	Normalized Site Attenuation
Ant, ANT	Antenna	NVLAP	National Voluntary Laboratory Accreditation Program
AP	Access Point	OBW	Occupied Band Width
ASK	Amplitude Shift Keying	OFDM	Orthogonal Frequency Division Multiplexing
Atten., ATT	Attenuator	P/M	Power meter
AV	Average	PCB	Printed Circuit Board
BPSK	Binary Phase-Shift Keying	PER	Packet Error Rate
BR	Bluetooth Basic Rate	PHY	Physical Layer
BT	Bluetooth	PK	Peak
BT LE	Bluetooth Low Energy	PN	Pseudo random Noise
BW	BandWidth	PRBS	Pseudo-Random Bit Sequence
Cal Int	Calibration Interval	PSD	Power Spectral Density
CCK	Complementary Code Keying	QAM	Quadrature Amplitude Modulation
Ch., CH	Channel	QP	Quasi-Peak
CISPR	Comite International Special des Perturbations Radioelectriques	QPSK	Quadri-Phase Shift Keying
CW	Continuous Wave	RBW	Resolution Band Width
DBPSK	Differential BPSK	RDS	Radio Data System
DC	Direct Current	RE	Radio Equipment
D-factor	Distance factor	RF	Radio Frequency
DFS	Dynamic Frequency Selection	RMS	Root Mean Square
DQPSK	Differential QPSK	RSS	Radio Standards Specifications
DSSS	Direct Sequence Spread Spectrum	Rx	Receiving
EDR	Enhanced Data Rate	SA, S/A	Spectrum Analyzer
EIRP, e.i.r.p.	Equivalent Isotropically Radiated Power	SG	Signal Generator
EMC	ElectroMagnetic Compatibility	SVSWR	Site-Voltage Standing Wave Ratio
EMI	ElectroMagnetic Interference	TR	Test Receiver
EN	European Norm	Tx	Transmitting
ERP, e.r.p.	Effective Radiated Power	VBW	Video BandWidth
EU	European Union	Vert.	Vertical
EUT	Equipment Under Test	WLAN	Wireless LAN
Fac.	Factor		
FCC	Federal Communications Commission		
FHSS	Frequency Hopping Spread Spectrum		
FM	Frequency Modulation		
Freq.	Frequency		
FSK	Frequency Shift Keying		
GFSK	Gaussian Frequency-Shift Keying		
GNSS	Global Navigation Satellite System		
GPS	Global Positioning System		
Hori.	Horizontal		
ICES	Interference-Causing Equipment Standard		
IEC	International Electrotechnical Commission		
IEEE	Institute of Electrical and Electronics Engineers		
IF	Intermediate Frequency		
ILAC	International Laboratory Accreditation Conference		
ISED	Innovation, Science and Economic Development Canada		
ISO	International Organization for Standardization		
JAB	Japan Accreditation Board		
LAN	Local Area Network		
LIMS	Laboratory Information Management System		

**UL Japan, Inc.**

**Shonan EMC Lab.**

1-22-3 Megumigaoka, Hiratsuka-shi, Kanagawa-ken, 259-1220 JAPAN

Telephone : +81 463 50 6400

Facsimile : +81 463 50 6401

<b>CONTENTS</b>	<b>PAGE</b>
<b>SECTION 1: Customer information.....</b>	<b>5</b>
<b>SECTION 2: Equipment under test (EUT).....</b>	<b>5</b>
<b>SECTION 3: Test specification, procedures &amp; results.....</b>	<b>7</b>
<b>SECTION 4: Operation of EUT during testing.....</b>	<b>11</b>
<b>SECTION 5: Radiated Spurious Emission .....</b>	<b>20</b>
<b>SECTION 6: Antenna Terminal Conducted Tests.....</b>	<b>22</b>
<b>APPENDIX 1: Test data .....</b>	<b>23</b>
20 dB Bandwidth, 99 % Occupied Bandwidth and Carrier Frequency Separation .....	23
Number of Hopping Frequency .....	27
Dwell time.....	29
Maximum Peak Output Power .....	32
Average Output Power.....	34
Radiated Spurious Emission .....	36
Conducted Spurious Emission .....	57
Conducted Emission Band Edge compliance .....	63
<b>APPENDIX 2: Test instruments .....</b>	<b>65</b>
<b>APPENDIX 3: Photographs of test setup .....</b>	<b>68</b>
Radiated Spurious Emission .....	68
Antenna Terminal Conducted Tests.....	70



## 2.2 Product Description

Model: DNNS124 (referred to as the EUT in this report) is a Cockpit Control Unit.

### Radio Specification

Clock frequency(Maximum) : 40 MHz

Bluetooth (BR/EDR)	
Frequency of operation	2402 MHz - 2480 MHz
Channel spacing	1 MHz
Modulation	FHSS (GFSK, $\pi/4$ -DQPSK, 8DPSK)
Antenna type	External Antenna
Antenna Gain	2.55 dBi (Max)

	IEEE802.11b	IEEE802.11g	IEEE802.11n (20 MHz band)	IEEE802.11n (40 MHz band)
Frequency of operation	2412 MHz - 2462 MHz	2412 MHz - 2462 MHz	2412 MHz - 2462 MHz 5180 MHz - 5240 MHz 5745 MHz - 5825 MHz	5190 MHz - 5230 MHz 5755 MHz - 5795 MHz
Channel spacing	5 MHz		2.4 GHz band 5 MHz 5 GHz band 20 MHz	5 GHz band 40 MHz
Modulation	DSSS: DBPSK, DQPSK, CCK	OFDM: BPSK, QPSK, 16QAM, 64QAM		
	IEEE802.11a	IEEE802.11ac (20 MHz band)	IEEE802.11ac (40 MHz band)	IEEE802.11ac (80 MHz band)
Frequency of operation	5180 MHz - 5240 MHz 5745 MHz - 5825 MHz	5180 MHz - 5240 MHz 5745 MHz - 5825 MHz	5190 MHz - 5230 MHz 5755 MHz - 5795 MHz	5210 MHz 5775 MHz
Channel spacing	20 MHz		40 MHz	80 MHz
Modulation	OFDM BPSK, QPSK, 16QAM, 64QAM, 256QAM (*256QAM is only for IEEE802.11ac 80 MHz band)			
Antenna type	External Antenna			
Antenna Gain	Main Antenna: Chain0 : 2.55 dBi (2.4 GHz), 0.02 dBi (5 GHz) Sub Antenna: Chain1 : -2.10 dBi (2.4 GHz), -5.26 dBi (5 GHz)			

### [AM/FM Radio]

	AM	FM (incl. RBDS)
Equipment type	Receiver	
Frequency of operation	522 kHz to 1629 kHz	87 MHz to 108 MHz

#### FM tuner specification

Intermediate frequency: 220 kHz

\*The EUT is the modified version of model and the difference from DNNS122 is as below.

- Deletion of XM PCB
- Change of Tuner PCB

The radio specification other than above is identical to the original test report (13692701S-A-R1).

For verifying the equivalence between DNNS124 and DNNS122, spot-check tests were performed on RF Output power and Radiated Spurious Emission.

As a result, the deviation of worst value was within  $\pm 0.5$  dB at RF Output power test and Band Edge and harmonic of fundamental frequency were  $\pm 3.0$  dB at Radiated Spurious Emission test, and the equivalence between DNNS124 and DNNS122 was confirmed.

Therefore the data of DNNS122 are included in this report.

### **SECTION 3: Test specification, procedures & results**

#### **3.1 Test Specification**

Test Specification : FCC Part 15 Subpart C  
FCC Part 15 final revised on May 3, 2021 and effective July 2, 2021

Title : FCC 47 CFR Part 15 Radio Frequency Device Subpart C Intentional Radiators  
Section 15.207 Conducted limits  
Section 15.247 Operation within the bands 902-928 MHz, 2400-2483.5 MHz,  
and 5725-5850 MHz

\* Also the EUT complies with FCC Part 15 Subpart B.

### 3.2 Procedures and results

Item	Test Procedure	Specification	Worst Margin	Results	Remarks
Conducted Emission	FCC: ANSI C63.10-2013 6. Standard test methods ----- ISED: RSS-Gen 8.8	FCC: Section 15.207 ----- ISED: RSS-Gen 8.8	-	N/A	*1)
Carrier Frequency Separation	FCC: KDB 558074 D01 15.247 Meas Guidance v05r02 ISED: -	FCC: Section15.247(a)(1) ----- ISED: RSS-247 5.1 (b)	See data.	Complied a)	Conducted
20 dB Bandwidth	FCC: KDB 558074 D01 15.247 Meas Guidance v05r02 ISED: -	FCC: Section15.247(a)(1) ----- ISED: RSS-247 5.1 (a)		Complied a)	Conducted
Number of Hopping Frequency	FCC: KDB 558074 D01 15.247 Meas Guidance v05r02 ISED: -	FCC: Section15.247(a)(1)(iii) ----- ISED: RSS-247 5.1 (d)		Complied b)	Conducted
Dwell time	FCC: KDB 558074 D01 15.247 Meas Guidance v05r02 ISED: -	FCC: Section15.247(a)(1)(iii) ----- ISED: RSS-247 5.1 (d)		Complied c)	Conducted
Maximum Peak Output Power	FCC: KDB 558074 D01 15.247 Meas Guidance v05r02 ISED: RSS-Gen 6.12	FCC: Section15.247(a)(b)(1) ----- ISED: RSS-247 5.4 (b)		Complied d)	Conducted
Spurious Emission & Band Edge Compliance	FCC: KDB 558074 D01 15.247 Meas Guidance v05r02 ISED: RSS-Gen 6.13	FCC: Section15.247(d) ----- ISED: RSS-247 5.5 RSS-Gen 8.9 RSS-Gen 8.10		<b>DNNS124</b> 10.7 dB 57.200 MHz, QP, Vert. Tx Hopping Off 3DH5 2441 MHz	Complied e) / f)
<p>Note: UL Japan, Inc.'s EMI Work Procedures No. 13-EM-W0420 and 13-EM-W0422.  *1) The test was not applicable since the EUT does not have AC mains.  *2) Radiated test was selected over 30 MHz based on section 15.247(d).  a) Refer to APPENDIX 1 (data of 20 dB Bandwidth, 99 % Occupied Bandwidth and Carrier Frequency Separation)  b) Refer to APPENDIX 1 (data of Number of Hopping Frequency)  c) Refer to APPENDIX 1 (data of Dwell time)  d) Refer to APPENDIX 1 (data of Maximum Peak Output Power)  e) Refer to APPENDIX 1 (data of Conducted Spurious Emission)  f) Refer to APPENDIX 1 (data of Radiated Spurious Emission)</p> <p>Symbols:  Complied                    The data of this test item has enough margin, more than the measurement uncertainty.  Complied#                    The data of this test item meets the limits unless the measurement uncertainty is taken into consideration.</p>					

\* In case any questions arise about test procedure, ANSI C63.10: 2013 is also referred.

#### **FCC Part 15.31 (e)**

The EUT provides stable voltage constantly to the wireless transmitter regardless of input voltage. Instead of a new battery, DC power supply was used for the test. Therefore, this EUT complies with the requirement.

#### **FCC Part 15.203 Antenna requirement**

It is impossible for end users to replace the antenna, because the antenna is mounted inside of the vehicle. Therefore, the equipment complies with the antenna requirement of Section 15.203.

**UL Japan, Inc.**

**Shonan EMC Lab.**

1-22-3 Megumigaoka, Hiratsuka-shi, Kanagawa-ken, 259-1220 JAPAN

Telephone : +81 463 50 6400

Facsimile : +81 463 50 6401



### 3.3 Addition to standard

Item	Test Procedure	Specification	Worst margin	Results	Remarks
99 % Occupied Bandwidth	ISED: RSS-Gen 6.7	ISED: -	N/A	- a)	Conducted
a) Refer to APPENDIX 1 (data of 20 dB Bandwidth, 99 % Occupied Bandwidth and Carrier Frequency Separation)					

Other than above, no addition, exclusion nor deviation has been made from the standard.

### 3.4 Uncertainty

There is no applicable rule of uncertainty in this applied standard. Therefore, the results are derived depending on whether or not laboratory uncertainty is applied.

The following uncertainties have been calculated to provide a confidence level of 95 % using a coverage factor  $k=2$ .

Shonan EMC Lab.

Item	Frequency range	Uncertainty (+/-)			
		No. 1 SAC / SR	No. 2 SAC / SR	No. 3 SAC / SR	No. 4,5,6,8 SR
Conducted emission (AC Mains) LISN	150 kHz-30 MHz	2.6 dB	2.6 dB	2.56dB	2.9 dB
Radiated emission (Measurement distance: 3 m)	9 kHz-30 MHz	3.0 dB	2.7 dB	2.7 dB	-
	30 MHz-200 MHz	4.6 dB	4.6 dB	4.6 dB	-
	200 MHz-1 GHz	6.0 dB	6.0 dB	6.0 dB	-
	1 GHz-6 GHz	4.8 dB	4.8 dB	4.8 dB	-
	6 GHz-18 GHz	5.4 dB	5.4 dB	5.4 dB	-
	18 GHz-40 GHz	5.3 dB	5.3 dB	5.3 dB	-
Radiated emission (Measurement distance: 1 m)	1 GHz-18 GHz	5.7 dB	5.7 dB	5.7 dB	-
	18 GHz-40 GHz	5.6 dB	5.6 dB	5.6 dB	-

SAC=Semi-Anechoic Chamber

SR= Shielded Room is applied besides radiated emission

Antenna terminal test	Uncertainty (+/-)
Power Measurement above 1 GHz (Average Detector)_SPM-06	1.4 dB
Power Measurement above 1 GHz (Peak Detector)_SPM-06	1.6 dB
Power Measurement above 1 GHz (Average Detector)_SPM-07	0.89 dB
Power Measurement above 1 GHz (Peak Detector)_SPM-07	1.2 dB
Power Measurement above 1 GHz (Average Detector)_SPM-13	0.91 dB
Power Measurement above 1 GHz (Peak Detector)_SPM-13	1.2 dB
Spurious emission (Conducted) below 1GHz	0.87 dB
Spurious emission (Conducted) 1 GHz-3 GHz	0.96 dB
Spurious emission (Conducted) 3 GHz-18 GHz	3.0 dB
Spurious emission (Conducted) 18 GHz-26.5 GHz	2.6 dB
Spurious emission (Conducted) 26.5 GHz-40 GHz	2.2 dB
Bandwidth Measurement	0.012 %
Duty cycle and Time Measurement	0.27 %
Temperature_SCH-01	0.87 deg.C.
Humidity_SCH-01	4.3 %
Temperature_SCH-02	2.0 deg.C.
Humidity_SCH-02	6.6 %
Voltage	0.86 %

### 3.5 Test Location

UL Japan, Inc. Shonan EMC Lab.

1-22-3, Megumigaoka, Hiratsuka-shi, Kanagawa-ken 259-1220 JAPAN

Telephone: +81 463 50 6400, Facsimile: +81 463 50 6401

A2LA Certificate Number: 1266.03

(FCC test firm registration number: 626366, ISED lab company number: 2973D / CAB identifier: JP0001)

Test site	IC Registration Number	Width x Depth x Height (m)	Size of reference ground plane (m) / horizontal conducting plane	Maximum measurement distance
No.1 Semi-anechoic chamber	2973D-1	20.6 x 11.3 x 7.65	20.6 x 11.3	10 m
No.2 Semi-anechoic chamber	2973D-2	20.6 x 11.3 x 7.65	20.6 x 11.3	10 m
No.3 Semi-anechoic chamber	2973D-3	12.7 x 7.7 x 5.35	12.7 x 7.7	5 m
No.4 Semi-anechoic chamber	-	8.1 x 5.1 x 3.55	8.1 x 5.1	-
No.1 Shielded room	-	6.8 x 4.1 x 2.7	6.8 x 4.1	-
No.2 Shielded room	-	6.8 x 4.1 x 2.7	6.8 x 4.1	-
No.3 Shielded room	-	6.3 x 4.7 x 2.7	6.3 x 4.7	-
No.4 Shielded room	-	4.4 x 4.7 x 2.7	4.4 x 4.7	-
No.5 Shielded room	-	7.8 x 6.4 x 2.7	7.8 x 6.4	-
No.6 Shielded room	-	7.8 x 6.4 x 2.7	7.8 x 6.4	-
No.8 Shielded room	-	3.45 x 5.5 x 2.4	3.45 x 5.5	-
No.1 Measurement room	-	2.55 x 4.1 x 2.5	-	-

### 3.6 Test data, Test instruments, and Test set up

Refer to APPENDIX.

## **SECTION 4: Operation of EUT during testing**

### **4.1 Operating Mode(s)**

Bluetooth (BT): Transmitting (Tx), Payload: PRBS9

Details of Operating Mode(s)

<b>Test Item</b>	<b>Mode</b>	<b>Tested frequency</b>
Spurious Emission (Conducted / Radiated *1))	Tx (Hopping Off) DH5, 3DH5	2402 MHz 2441 MHz 2480 MHz
Carrier Frequency Separation	Tx (Hopping On) DH5, 3DH5	2402 MHz 2441 MHz 2480 MHz
20 dB Bandwidth	Tx (Hopping Off) DH5, 3DH5	2402 MHz 2441 MHz 2480 MHz
Number of Hopping Frequency	Tx (Hopping On) DH5, 3DH5	-
Dwell time	Tx (Hopping On), -DH1, DH3, DH5 -3DH1, 3DH3, 3DH5	-
Maximum Peak Output Power *1)	Tx (Hopping Off) DH5, 2DH5, 3DH5	2402 MHz 2441 MHz 2480 MHz
Band Edge Compliance (Conducted)	Tx DH5, 3DH5 -Hopping On -Hopping Off	2402 MHz 2480 MHz
99 % Occupied Bandwidth	Tx DH5, 3DH5 -Hopping On -Hopping Off	2402 MHz 2441 MHz 2480 MHz
<p>*1) Test for spot check was performed on below mode.  Radiated Spurious Emission: Tx DH5, 3DH5 (Band Edge Compliance)  Tx 3DH5, 2402 MHz, 2441 MHz (Other Spurious Emission)  Maximum Peak Output Power: Tx DH5, 2DH5, 3DH5</p> <p>*As a result of preliminary test, the formal test was performed with the above modes, which had the maximum payload length (except Dwell time test)  *2DH mode (2Mb/s EDR: pi/4DQPSK) was excluded for other tests than power measurement by using 3DH mode (3 Mb/s EDR: 8DPSK) as a representative.  * It is considered that the non-tested packet type (e.g. inquiry) can be omitted as it is complied with above all the test items based on Bluetooth Core specification.</p> <p>Power settings: BR (Burst power): -1.7 dBm  EDR (Burst power): -2.2 dBm</p> <p>Software: DNNS122:  MSoC Ver.F61WHM010-708  (Date:2020.11.12, Storage location: EUT memory)  DNNS124:  MSoC Ver.F67WHM010-708  (Date:2020.11.12, Storage location: EUT memory)</p> <p>*This setting of software is the worst case.  Any conditions under the normal use do not exceed the condition of setting.  In addition, end users cannot change the settings of the output power of the product.</p>		

**UL Japan, Inc.**

**Shonan EMC Lab.**

1-22-3 Megumigaoka, Hiratsuka-shi, Kanagawa-ken, 259-1220 JAPAN

Telephone : +81 463 50 6400

Facsimile : +81 463 50 6401

## 4.2 Configuration and peripherals

### DNNS122

<Radiated Emission test>

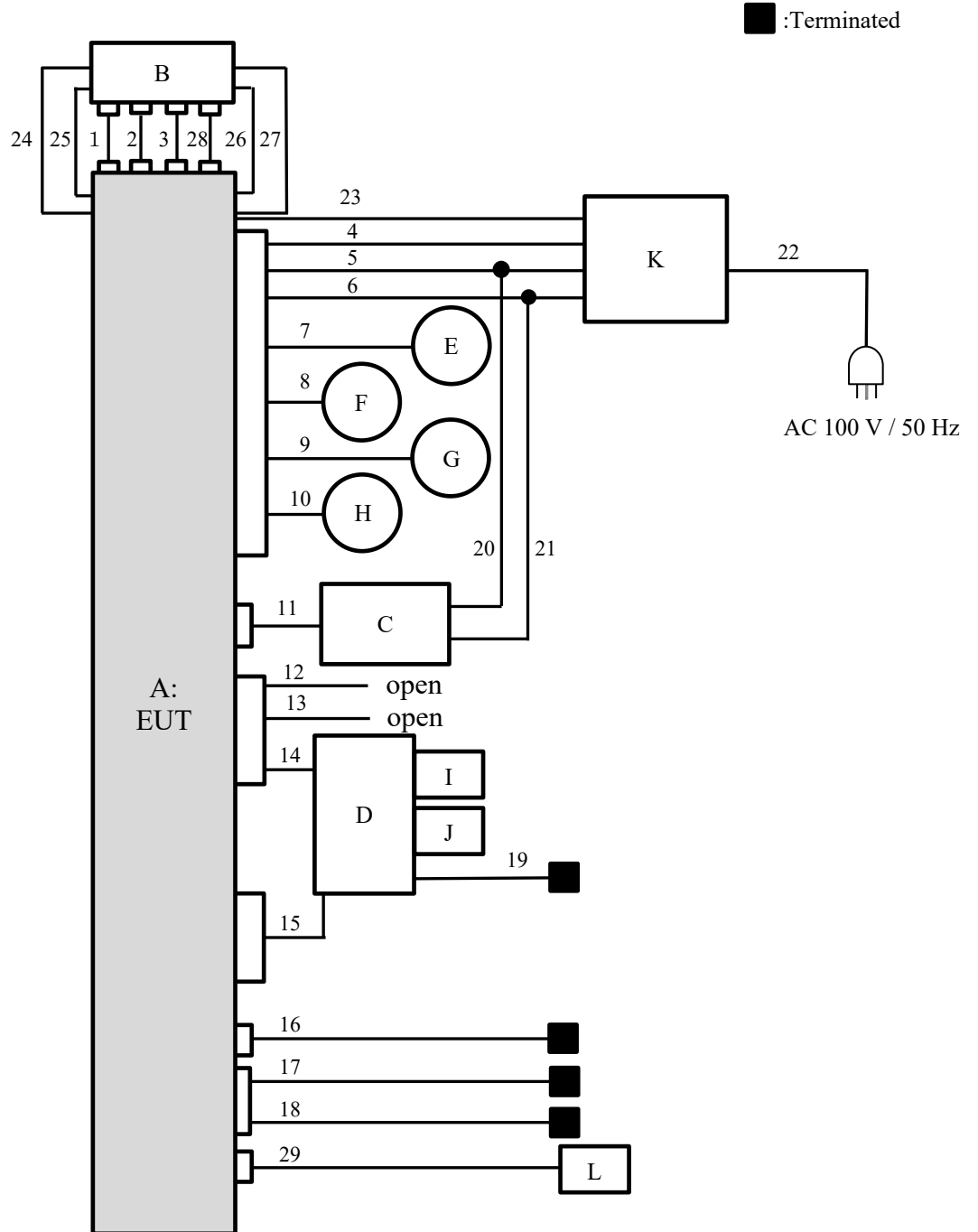

\* Cabling and setup(s) were taken into consideration and test data was taken under worst case conditions.

**UL Japan, Inc.**

**Shonan EMC Lab.**

1-22-3 Megumigaoka, Hiratsuka-shi, Kanagawa-ken, 259-1220 JAPAN

Telephone : +81 463 50 6400

Facsimile : +81 463 50 6401

**Description of EUT and Support equipment**

No.	Item	Model number	Serial number	Manufacturer	Remarks
A	Cockpit Control Unit	DNNS122	CP1.5-K3-GZ1-US-High-065	DENSO CORPORATION	EUT
B	Center Information Display	DNNS132	GZ1-SD-HM LHD-077	DENSO CORPORATION	-
C	Meter	85002AN02A	-	DENSO CORPORATION	-
D	AUX-BOX	86257 AN00A	No.12	HOSIDEN	-
E	Speaker Front L	20FHI-SPRE-03	-	DENSO CORPORATION	-
F	Speaker Front R	20FHI-SPRE-03	-	DENSO CORPORATION	-
G	Speaker Rear L	20FHI-SPRE-03	-	DENSO CORPORATION	-
H	Speaker Rear R	20FHI-SPRE-03	-	DENSO CORPORATION	-
I	USB Memory	USM4GU	-	SONY	-
J	USB Memory	JF V33	526394 0345	Transcend	-
K	DC Power Supply	PAN35-10A	NA000955	KIKUSUI	-
L	GPS Antenna	86277AL150	28590081	SUBARU	-

**List of cables used**

No.	Name	Length (m)	Shield		Remarks
			Cable	Connector	
1	CCU-CID-POW	0.2	Unshielded	Unshielded	-
2	CCU-CID-LVDS	0.2	Shielded	Shielded	-
3	CCU-CID-BT	0.2	Shielded	Shielded	-
4	DC power(+B)	1.8	Unshielded	Unshielded	-
5	DC power(+IG)	1.8	Unshielded	Unshielded	-
6	DC power(GND)	1.8	Unshielded	Unshielded	-
7	Speaker L	1.8	Unshielded	Unshielded	-
8	Speaker R	1.8	Unshielded	Unshielded	-
9	Speaker Rear L	1.8	Unshielded	Unshielded	-
10	Speaker Rear R	1.8	Unshielded	Unshielded	-
11	Meter	1.8	Unshielded	Unshielded	-
12	USB(Blue)	1.5	Shielded	Shielded	-
13	USB(Brown)	0.15	Shielded	Shielded	-
14	USB(Green)	0.5	Shielded	Shielded	-
15	Power Supply	1.0	Unshielded	Unshielded	-
16	XM	1.0	Shielded	Shielded	-
17	AM/FM	2.0	Shielded	Shielded	-
18	AM/FM	2.0	Shielded	Shielded	-
19	Mini Jack	2.0	Unshielded	Unshielded	-
20	DC power(+IG)	1.2	Unshielded	Unshielded	-
21	DC power(GND)	1.2	Unshielded	Unshielded	-
22	AC	2.0	Unshielded	Unshielded	-
23	GND	2.4	Unshielded	Unshielded	-
24	GND	0.2	Unshielded	Unshielded	-
25	GND	0.2	Unshielded	Unshielded	-
26	GND	0.2	Unshielded	Unshielded	-
27	GND	0.2	Unshielded	Unshielded	-
28	CCU-CID-Wifi	0.2	Shielded	Shielded	-
29	GPS	0.8	Shielded	Shielded	-

**UL Japan, Inc.**

**Shonan EMC Lab.**

1-22-3 Megumigaoka, Hiratsuka-shi, Kanagawa-ken, 259-1220 JAPAN

Telephone : +81 463 50 6400

Facsimile : +81 463 50 6401

DNNS122

<Antenna Terminal Conducted test>

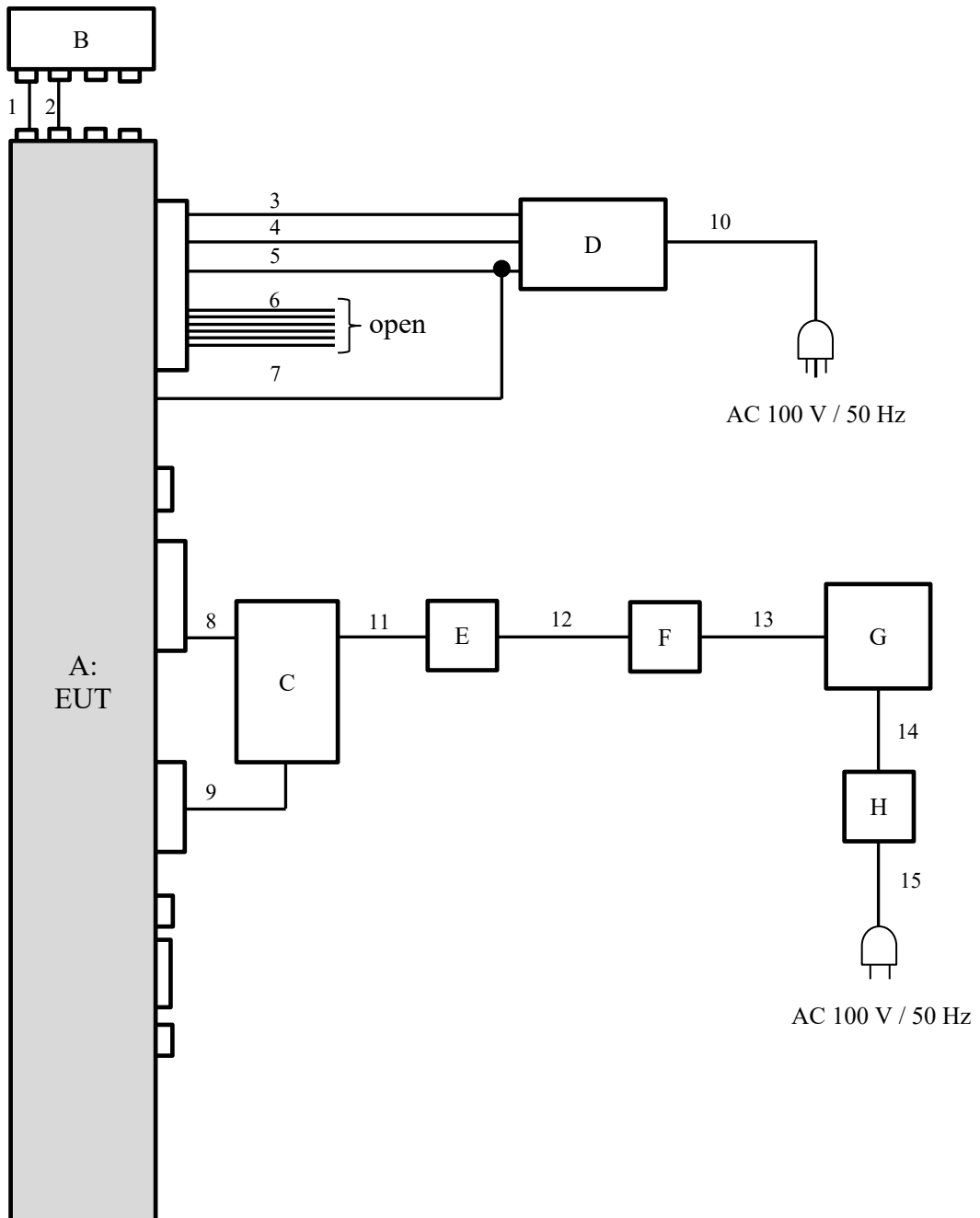

**Description of EUT and Support equipment**

No.	Item	Model number	Serial number	Manufacturer	Remarks
A	Cockpit Control Unit	DNNS122	CP1.5-K3-GZ1-US-High-065	DENSO CORPORATION	EUT
B	Center Information Display	DNNS132	GZ1-SD-HM LHD-077	DENSO CORPORATION	-
C	AUX-BOX	86257 AN00A	No.2	HOSIDEN	-
D	DC Power supply	PAN35-10A	ML002085	KIKUSUI	-
E	USB-LAN Converter	LUA3-U2-ATX	26495680102812	Buffalo	-
F	USB-LAN Converter	LUA3-U2-ATX	26495680815712	Buffalo	-
G	Laptop PC	ThinkPad L580	PF-1PLZHX 19/05	Lenovo	-
H	AC Adaptor	ADLX45YCC2A	8SSA10E75844C1SG94BG7T0	Lenovo	-

**List of cables used**

No.	Name	Length (m)	Shield		Remarks
			Cable	Connector	
1	CCU-CID-POW	1.0	Unshielded	Unshielded	-
2	CCU-CID-LVDS	2.0	Shielded	Shielded	-
3	DC power(+B)	1.8	Unshielded	Unshielded	-
4	DC power(+IG)	1.8	Unshielded	Unshielded	-
5	DC power(GND)	1.8	Unshielded	Unshielded	-
6	Signal	1.0	Unshielded	Unshielded	-
7	GND	2.4	Unshielded	Unshielded	-
8	USB(Green)	0.5	Shielded	Shielded	-
9	Power Supply	1.0	Unshielded	Unshielded	-
10	AC	3.0	Unshielded	Unshielded	-
11	USB	0.4	Shielded	Shielded	-
12	LAN	2.0	Shielded	Shielded	-
13	USB	0.4	Shielded	Shielded	-
14	DC	1.0	Unshielded	Unshielded	-
15	AC	1.8	Unshielded	Unshielded	-

**UL Japan, Inc.**

**Shonan EMC Lab.**

1-22-3 Megumigaoka, Hiratsuka-shi, Kanagawa-ken, 259-1220 JAPAN

Telephone : +81 463 50 6400

Facsimile : +81 463 50 6401

**DNNS124**

<Radiated Emission test>

■ : Terminated

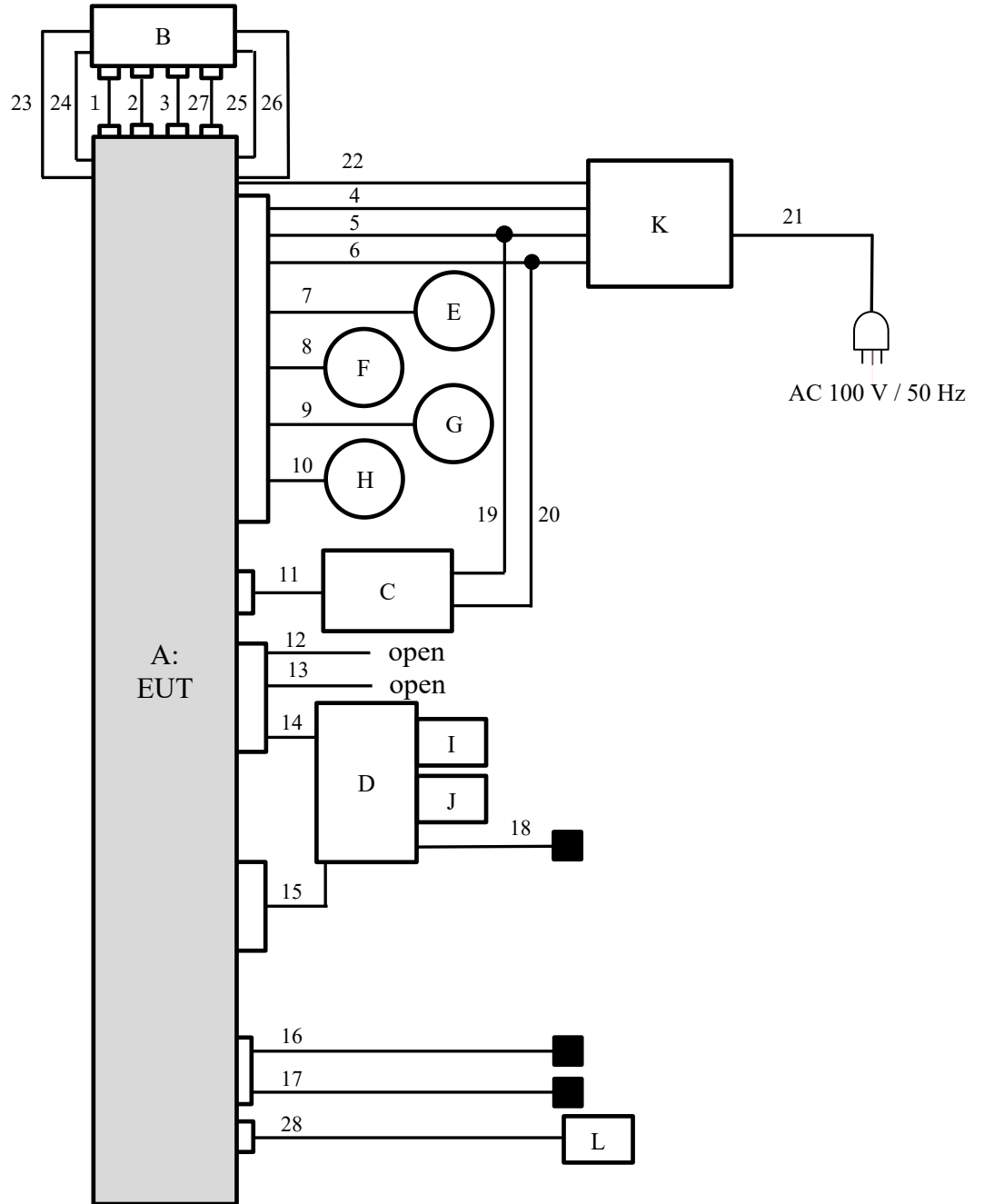

\* Cabling and setup(s) were taken into consideration and test data was taken under worst case conditions.



**Description of EUT and Support equipment**

No.	Item	Model number	Serial number	Manufacturer	Remarks
A	Cockpit Control Unit	DNNS124	CP1.5-K3-TM3-ROW-High-178	DENSO CORPORATION	EUT
B	Center Information Display	DNNS132	GZ1-SD-HM LHD-077	DENSO CORPORATION	-
C	Meter	85002AN02A	-	DENSO CORPORATION	-
D	AUX-BOX	86257 AN00A	No.2	HOSIDEN	-
E	Speaker Front L	20FHI-SPRE-03	-	DENSO CORPORATION	-
F	Speaker Front R	20FHI-SPRE-03	-	DENSO CORPORATION	-
G	Speaker Rear L	20FHI-SPRE-03	-	DENSO CORPORATION	-
H	Speaker Rear R	20FHI-SPRE-03	-	DENSO CORPORATION	-
I	USB Memory	USM4GU	-	SONY	-
J	USB Memory	USM4GL-W	-	SONY	-
K	DC Power Supply	PAN35-10A	NA000955	KIKUSUI	-
L	GPS Antenna	86277AL150	03590040	SUBARU	-

**List of cables used**

No.	Name	Length (m)	Shield		Remarks
			Cable	Connector	
1	CCU-CID-POW	0.2	Unshielded	Unshielded	-
2	CCU-CID-LVDS	0.2	Shielded	Shielded	-
3	CCU-CID-BT	0.2	Shielded	Shielded	-
4	DC power(+B)	1.8	Unshielded	Unshielded	-
5	DC power(+IG)	1.8	Unshielded	Unshielded	-
6	DC power(GND)	1.8	Unshielded	Unshielded	-
7	Speaker L	1.8	Unshielded	Unshielded	-
8	Speaker R	1.8	Unshielded	Unshielded	-
9	Speaker Rear L	1.8	Unshielded	Unshielded	-
10	Speaker Rear R	1.8	Unshielded	Unshielded	-
11	Meter	1.8	Unshielded	Unshielded	-
12	USB(Blue)	2.0	Shielded	Shielded	-
13	USB(Brown)	0.15	Shielded	Shielded	-
14	USB(Green)	0.4	Shielded	Shielded	-
15	Power Supply	1.0	Unshielded	Unshielded	-
16	AM/FM	2.0	Shielded	Shielded	-
17	AM/FM	2.0	Shielded	Shielded	-
18	Mini Jack	2.0	Unshielded	Unshielded	-
19	DC power(+IG)	1.2	Unshielded	Unshielded	-
20	DC power(GND)	1.2	Unshielded	Unshielded	-
21	AC	1.8	Unshielded	Unshielded	-
22	GND	2.4	Unshielded	Unshielded	-
23	GND	0.15	Unshielded	Unshielded	-
24	GND	0.15	Unshielded	Unshielded	-
25	GND	0.15	Unshielded	Unshielded	-
26	GND	0.15	Unshielded	Unshielded	-
27	CCU-CID-Wifi	0.2	Shielded	Shielded	-
28	GPS	0.8	Shielded	Shielded	-

**UL Japan, Inc.**

**Shonan EMC Lab.**

1-22-3 Megumigaoka, Hiratsuka-shi, Kanagawa-ken, 259-1220 JAPAN

Telephone : +81 463 50 6400

Facsimile : +81 463 50 6401

**DNNS124**

**<Antenna Terminal Conducted test>**

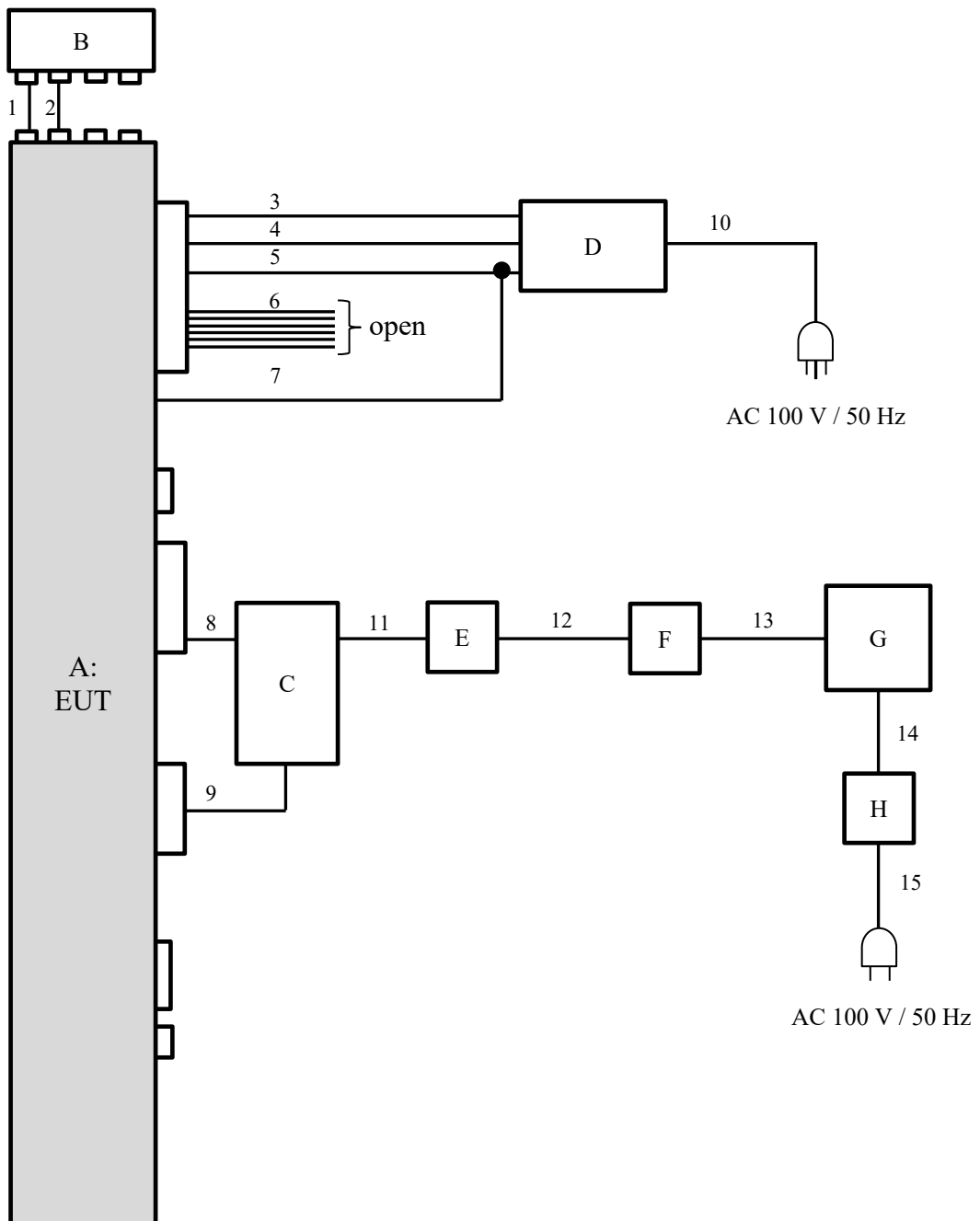

**Description of EUT and Support equipment**

No.	Item	Model number	Serial number	Manufacturer	Remarks
A	Cockpit Control Unit	DNNS124	CP1.5-K3-TM3-ROW-High-177	DENSO CORPORATION	EUT
B	Center Information Display	DNNS132	GZ1-SD-HM LHD-024	DENSO CORPORATION	-
C	AUX-BOX	86257 AN00A	No.5	HOSIDEN	-
D	DC Power supply	PAN35-10A	ML002085	KIKUSUI	-
E	USB-LAN Converter	LUA3-U2-ATX	26495680815712	Buffalo	-
F	USB-LAN Converter	LUA3-U2-ATX	26495680102812	Buffalo	-
G	Laptop PC	ThinkPad L580	PF-1PLZHX 19/05	Lenovo	-
H	AC Adaptor	ADLX45YCC2A	8SSA10E75844C1SG94BG7T0	Lenovo	-

**List of cables used**

No.	Name	Length (m)	Shield		Remarks
			Cable	Connector	
1	CCU-CID-POW	1.0	Unshielded	Unshielded	-
2	CCU-CID-LVDS	1.5	Shielded	Shielded	-
3	DC power(+B)	1.8	Unshielded	Unshielded	-
4	DC power(+IG)	1.8	Unshielded	Unshielded	-
5	DC power(GND)	1.8	Unshielded	Unshielded	-
6	Signal	1.8	Unshielded	Unshielded	-
7	GND	2.4	Unshielded	Unshielded	-
8	USB(Green)	0.5	Shielded	Shielded	-
9	Power Supply	1.8	Unshielded	Unshielded	-
10	AC	1.8	Unshielded	Unshielded	-
11	USB	0.4	Shielded	Shielded	-
12	LAN	1.0	Unshielded	Unshielded	-
13	USB	0.4	Shielded	Shielded	-
14	DC	1.0	Unshielded	Unshielded	-
15	AC	1.8	Unshielded	Unshielded	-

**UL Japan, Inc.**

**Shonan EMC Lab.**

1-22-3 Megumigaoka, Hiratsuka-shi, Kanagawa-ken, 259-1220 JAPAN

Telephone : +81 463 50 6400

Facsimile : +81 463 50 6401

## **SECTION 5: Radiated Spurious Emission**

### **Test Procedure**

[For below 1 GHz]

EUT was placed on a urethane platform of nominal size \*1), raised 0.8 m above the conducting ground plane. The Radiated Electric Field Strength has been measured in a Semi Anechoic Chamber with a ground plane.

\*1) DNSS122: 1.0 m by 1.5 m, DNNS124: 1.0 m by 2.0 m

[For above 1 GHz]

EUT was placed on a urethane platform of nominal size, 0.5 m by 0.5 m, raised 1.5 m above the conducting ground plane. The Radiated Electric Field Strength has been measured in a Semi Anechoic Chamber with absorbent materials lined on a ground plane.

The height of the measuring antenna varied between 1 m and 4 m and EUT was rotated a full revolution in order to obtain the maximum value of the electric field strength.

Test antenna was aimed at the EUT for receiving the maximum signal and always kept within the illumination area of the 3 dB beamwidth of the antenna.

The measurements were performed for both vertical and horizontal antenna polarization with the Test Receiver, or the Spectrum Analyzer.

The measurements were made with the following detector function of the test receiver and the Spectrum analyzer (in linear mode).

The test was made with the detector (RBW/VBW) in the following table.

When using Spectrum analyzer, the test was made with adjusting span to zero by using peak hold.

### **Test Antennas are used as below;**

Frequency	30 MHz to 200 MHz	200 MHz to 1 GHz	Above 1 GHz
Antenna Type	Biconical	Logperiodic	Horn

In any 100 kHz bandwidth outside the restricted band in which the spread spectrum intentional radiator is operating, the radio frequency power that is produced by the intentional radiator confirmed 20 dB below that in the 100 kHz bandwidth within the band that contains the highest level of the desired power, based on a radiated measurement.

### **20 dBc was applied to the frequency over the limit of FCC 15.209 / Table 4 of RSS-Gen 8.9 (ISED) and outside the restricted band of FCC15.205 / Table 6 of RSS-Gen 8.10 (ISED).**

Frequency	Below 1 GHz	Above 1 GHz		20 dBc
Instrument used	Test Receiver	Spectrum Analyzer		Spectrum Analyzer
Detector	QP	PK	AV *1)	PK
IF Bandwidth	BW 120 kHz	RBW: 1 MHz VBW: 3 MHz	RBW: 1 MHz VBW: 1/T (T: burst length, refer to Burst rate confirmation sheet) Detector: Peak	RBW: 100 kHz VBW: 300 kHz

\*1) Average Power Measurement was performed based on KDB 558074 D01 15.247 Meas Guidance v05r02.

**UL Japan, Inc.**

**Shonan EMC Lab.**

1-22-3 Megumigaoka, Hiratsuka-shi, Kanagawa-ken, 259-1220 JAPAN

Telephone : +81 463 50 6400

Facsimile : +81 463 50 6401

**Figure 2: Test Setup**

Below 1 GHz

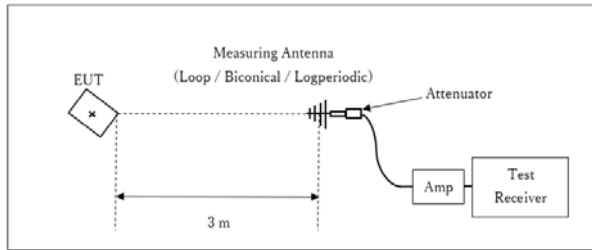

× : Center of turn table

Test Distance: 3 m

1 GHz - 10 GHz

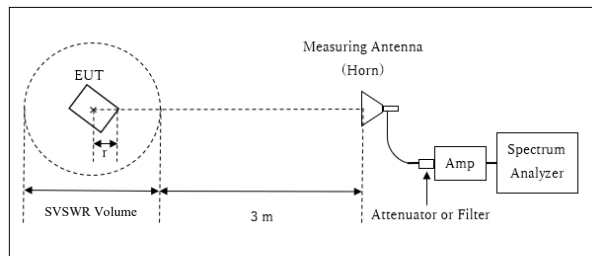

r : Radius of an outer periphery of EUT  
 × : Center of turn table

Distance Factor:  $20 \times \log(3.80 \text{ m} / 3.0 \text{ m}) = 2.06 \text{ dB}$   
 \* Test Distance:  $(3 + \text{SVSWR Volume} / 2) - r = 3.80 \text{ m}$

SVSWR Volume : 2.0 m  
 (SVSWR Volume has been calibrated based on CISPR 16-1-4.)  
 r = 0.20 m

10 GHz - 26.5 GHz

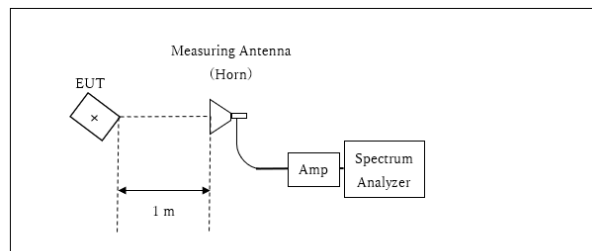

× : Center of turn table

Distance Factor:  $20 \times \log(1.0 \text{ m} / 3.0 \text{ m}) = -9.54 \text{ dB}$   
 \*Test Distance: 1 m

The test was made on EUT at the normal use position.

The test results and limit are rounded off to one decimal place, so some differences might be observed.

**Measurement range** : 30 MHz - 26.5 GHz  
**Test data** : APPENDIX  
**Test result** : Pass

## **SECTION 6: Antenna Terminal Conducted Tests**

### **Test Procedure**

The tests were made with below setting connected to the antenna port.

<b>Test</b>	<b>Span</b>	<b>RBW</b>	<b>VBW</b>	<b>Sweep time</b>	<b>Detector</b>	<b>Trace</b>	<b>Instrument used</b>
20 dB Bandwidth	3 MHz	30 kHz	100 kHz	Auto	Peak	Max Hold	Spectrum Analyzer
99 % Occupied Bandwidth *1)	Enough width to display emission skirts	1 to 5 % of OBW	Three times of RBW	Auto	Peak	Max Hold	Spectrum Analyzer
Maximum Peak Output Power	-	-	-	Auto	Peak Average *2)	-	Power Meter (Sensor: 160 MHz BW)
Carrier Frequency Separation	3 MHz	300 kHz	1 MHz	Auto	Peak	Max Hold	Spectrum Analyzer
Number of Hopping Frequency	30 MHz	300 kHz	1 MHz	Auto	Peak	Max Hold	Spectrum Analyzer
Dwell Time	Zero Span	100 kHz, 1 MHz	300 kHz, 3 MHz	As necessary capture the entire dwell time per hopping channel	Peak	Clear Write	Spectrum Analyzer
Conducted Spurious Emission *3) *4)	9 kHz to 150 kHz	200 Hz	620 Hz	Auto	Peak	Max Hold	Spectrum Analyzer
	150 kHz to 30 MHz	10 kHz	30 kHz				
	30 MHz to 25 GHz	100 kHz	300 kHz				
Conducted Spurious Emission Band Edge compliance	10 MHz	100 kHz	300 kHz	Auto	Peak	Max Hold	Spectrum Analyzer

\*1) Peak hold was applied as Worst-case measurement.

\*2) Reference data

\*3) In the frequency range below 30 MHz, RBW was narrowed to separate the noise contents.

Then, wide-band noise near the limit was checked separately, however the noise was not detected as shown in the chart.  
(9 kHz -150 kHz: RBW = 200 Hz, 150 kHz - 30 MHz: RBW = 10 kHz)

\*4) The limits in CFR 47, Part 15, Subpart C, paragraph 15.209(a), are identical to those in RSS-Gen section 8.9, Table 6, since the measurements are performed in terms of magnetic field strength and converted to electric field strength levels (as reported in the table) using the free space impedance of 377 Ohms. For example, the measurement at frequency 9 kHz resulted in a level of 45.5 dBuV/m, which is equivalent to  $45.5 - 51.5 = -6.0$  dBuA/m, which has the same margin, 3 dB, to the corresponding RSS-Gen Table 6 limit as it has to 15.209(a) limit.

The test results and limit are rounded off to two decimals place, so some differences might be observed.  
The equipment and cables were not used for factor 0 dB of the data sheets.

**Test data : APPENDIX**

**Test result : Pass**

## APPENDIX 1: Test data

### 20 dB Bandwidth, 99 % Occupied Bandwidth and Carrier Frequency Separation (Test model number: DNNS122)

Report No. 14071795S-A-R1  
Test place Shonan EMC Lab. No.5 Shielded Room  
Date February 9, 2021  
Temperature / Humidity 22 deg. C / 35 % RH  
Engineer Yosuke Murakami  
Mode Tx, Hopping Off, Tx, Hopping On

Mode	Freq. [MHz]	20dB Bandwidth [MHz]	99% Occupied Bandwidth [kHz]	Carrier Frequency Separation [MHz]	Limit for Carrier Frequency separation [MHz]
DH5	2402.0	1.032	903.9	1.000	$\geq 0.688$
DH5	2441.0	1.029	901.9	1.000	$\geq 0.686$
DH5	2480.0	1.034	904.2	1.000	$\geq 0.689$
DH5	Hopping On	-	78600.7	-	-
3DH5	2402.0	1.311	1186.1	1.000	$\geq 0.874$
3DH5	2441.0	1.311	1178.3	1.000	$\geq 0.874$
3DH5	2480.0	1.313	1188.2	1.000	$\geq 0.875$
3DH5	Hopping On	-	78758.8	-	-

Limit: Two-thirds of 20 dB Bandwidth or 25 kHz (whichever is greater).

No limit applies to 20 dB Bandwidth.

**20 dB Bandwidth and 99 % Occupied Bandwidth**  
 (Test model number: DNNS122)

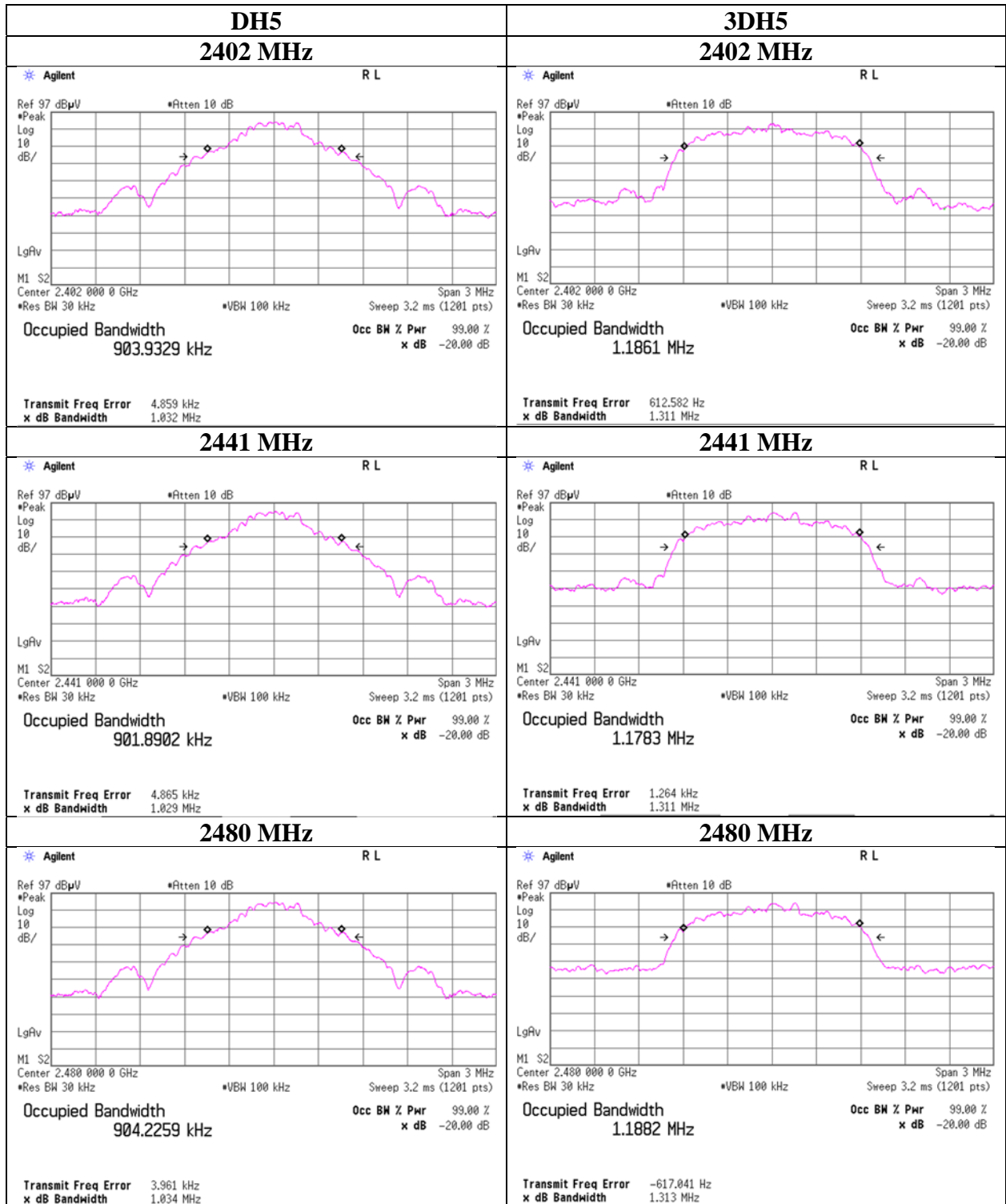



**20 dB Bandwidth and 99 % Occupied Bandwidth**  
 (Test model number: DNNS122)

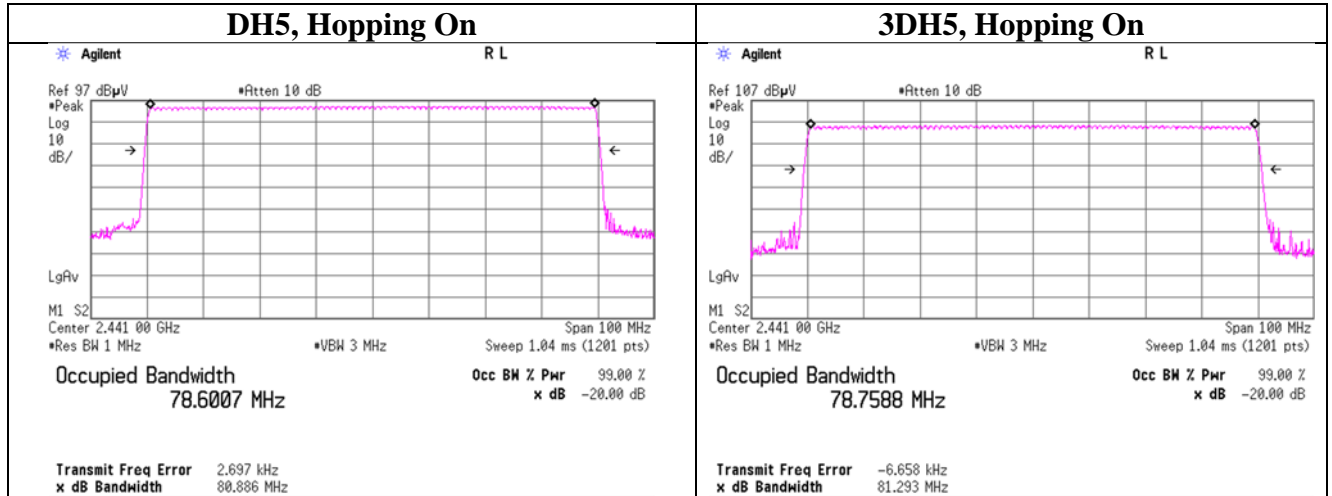

**UL Japan, Inc.**

**Shonan EMC Lab.**

1-22-3 Megumigaoka, Hiratsuka-shi, Kanagawa-ken, 259-1220 JAPAN

Telephone : +81 463 50 6400

Facsimile : +81 463 50 6401

**Carrier Frequency Separation**  
 (Test model number: DNNS122)

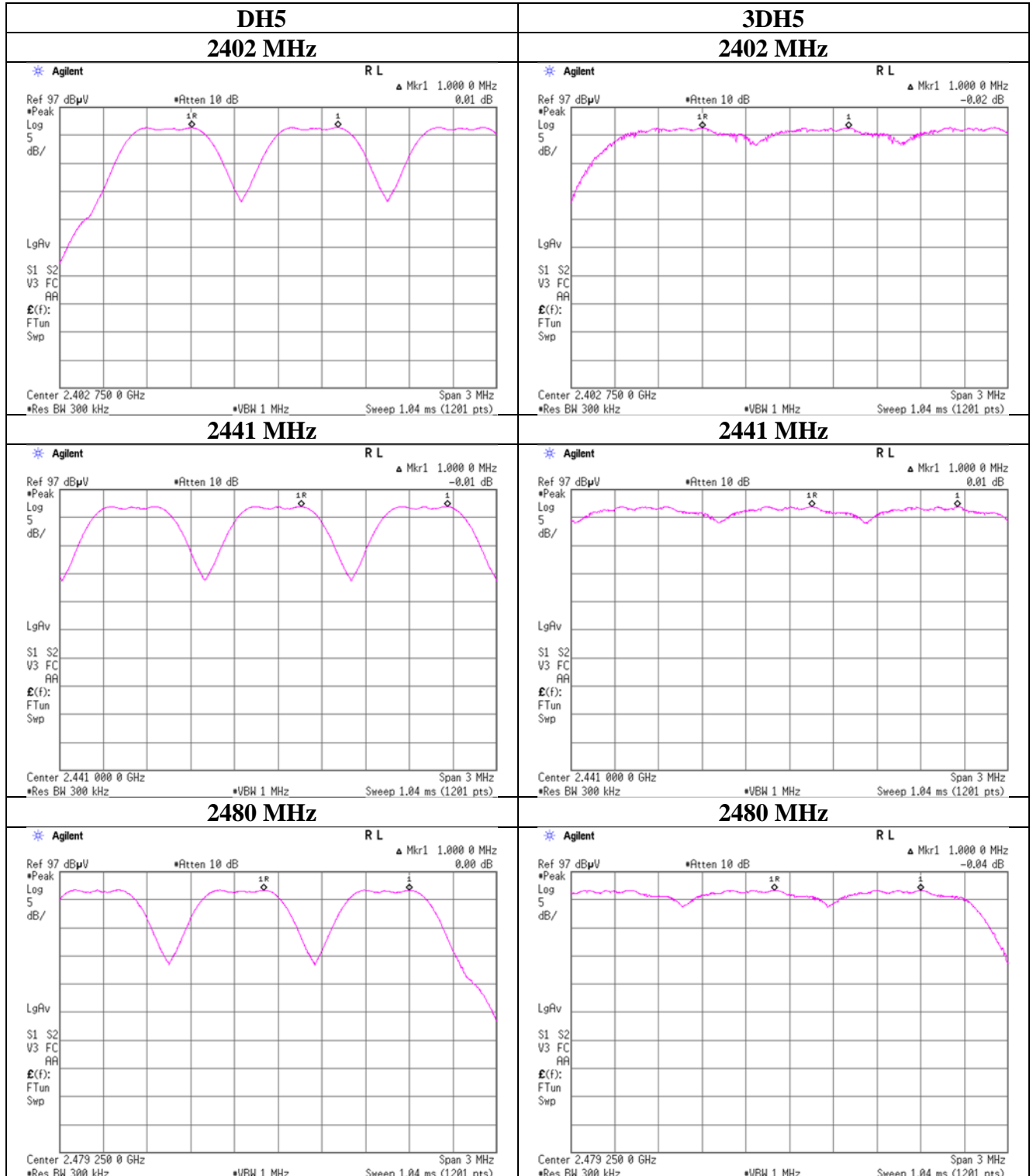

**Number of Hopping Frequency**  
(Test model number: DNNS122)

Report No. 14071795S-A-R1  
Test place Shonan EMC Lab. No.5 Shielded Room  
Date February 9, 2021  
Temperature / Humidity 22 deg. C / 35 % RH  
Engineer Yosuke Murakami  
Mode Tx, Hopping On

Mode	Number of channel [channels]	Limit [channels]
DH5	79	$\geq 15$
3DH5	79	$\geq 15$

Test was not performed at AFH mode whose number of hopping channel is 20 channels because this Bluetooth radio is in compliance of Bluetooth Specification.

**Number of Hopping Frequency**  
 (Test model number: DNNS122)

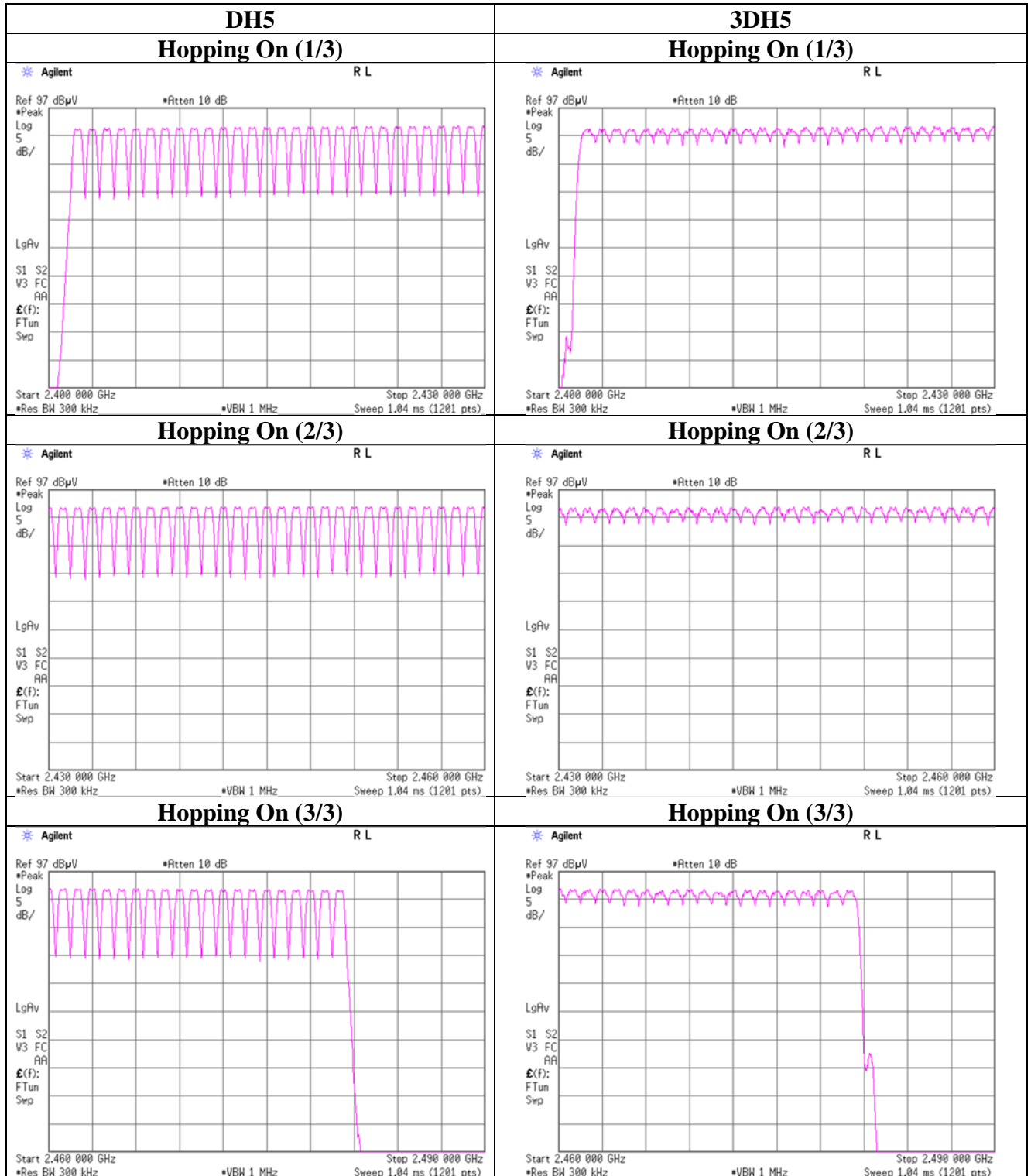

**Dwell time**  
(Test model number: DNNS122)

Report No. 14071795S-A-R1  
Test place Shonan EMC Lab. No.5 Shielded Room  
Date February 9, 2021  
Temperature / Humidity 22 deg. C / 35 % RH  
Engineer Yosuke Murakami  
Mode Tx, Hopping On

Mode	Number of transmission in a 31.6(79 Hopping x 0.4) / 12.8 (32 Hopping x 0.4) second period				Length of transmission [msec]	Result [msec]	Limit [msec]	
DH1	49.8 times	/	5 sec.	x 31.6 sec. =	315 times	0.401	126	400
DH3	26.6 times	/	5 sec.	x 31.6 sec. =	169 times	1.657	280	400
DH5	20.2 times	/	5 sec.	x 31.6 sec. =	128 times	2.904	372	400
3DH1	49.8 times	/	5 sec.	x 31.6 sec. =	315 times	0.406	128	400
3DH3	26.0 times	/	5 sec.	x 31.6 sec. =	165 times	1.659	274	400
3DH5	19.8 times	/	5 sec.	x 31.6 sec. =	126 times	2.909	367	400

Sample Calculation

Result = Number of transmission x Length of transmission

\*Average data of 5 tests.(except Inquiry)

Mode	Sampling [times]					Average [times]
	1	2	3	4	5	
DH1	50	49	52	49	49	49.8
DH3	26	26	28	26	27	26.6
DH5	21	18	22	19	21	20.2
3DH1	50	50	49	51	49	49.8
3DH3	27	23	27	32	21	26
3DH5	20	22	17	21	19	19.8

Sample Calculation

Average = Summation (Sampling 1 to 5) / 5

This device complies with the Bluetooth protocol for FHSS operation, employing a pseudo random channel selection and hopping rate to ensure that the occupancy time in  $N \times 0.4s$ , where  $N$  is the number of channels being used in the hopping sequence ( $20 \leq N \leq 79$ ), is always less than  $0.4s$  regardless of packet size. This is confirmed in the test report for  $N = 79$ .

**Dwell time**  
 (Test model number: DNNS122)

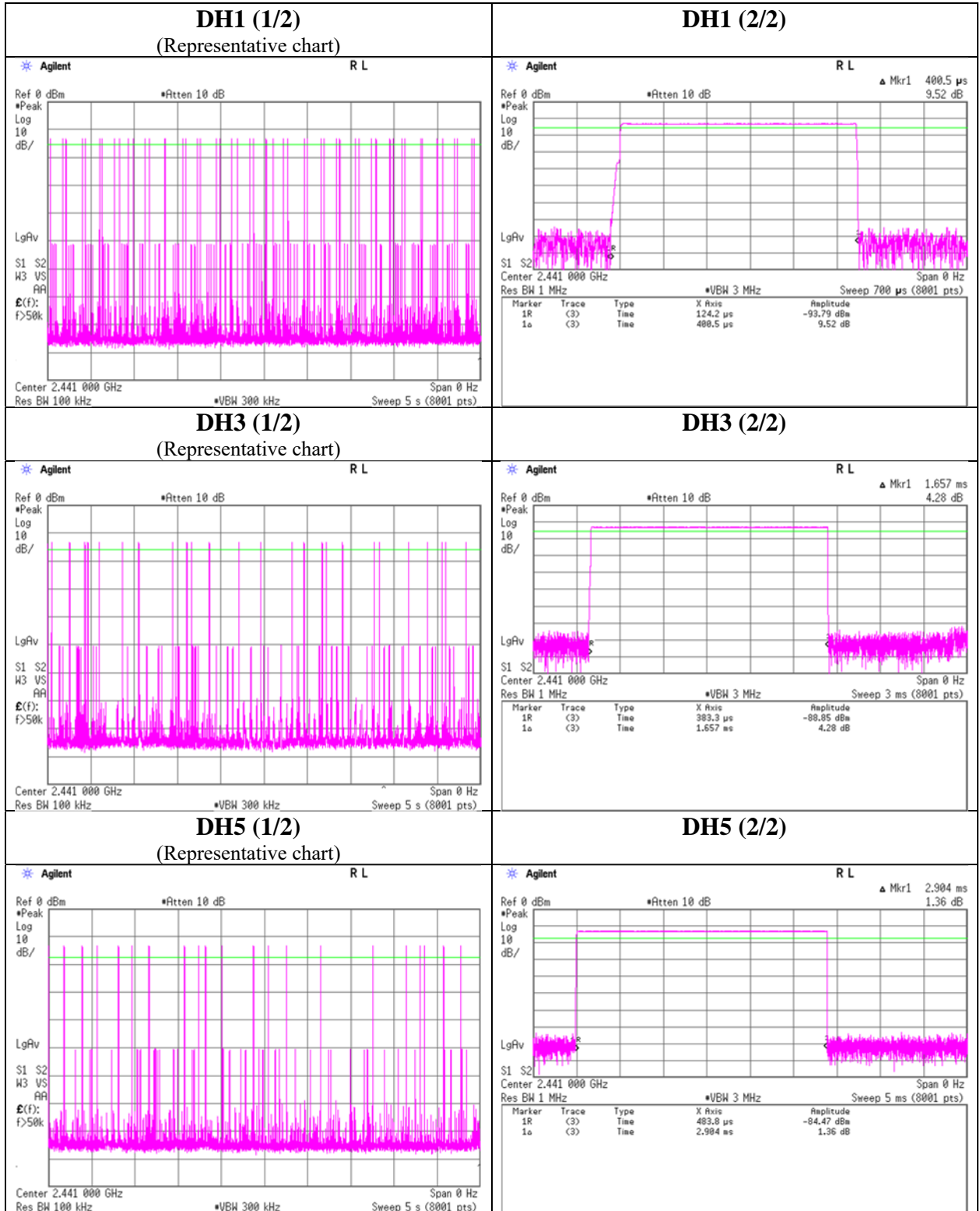

**Dwell time**  
 (Test model number: DNNS122)

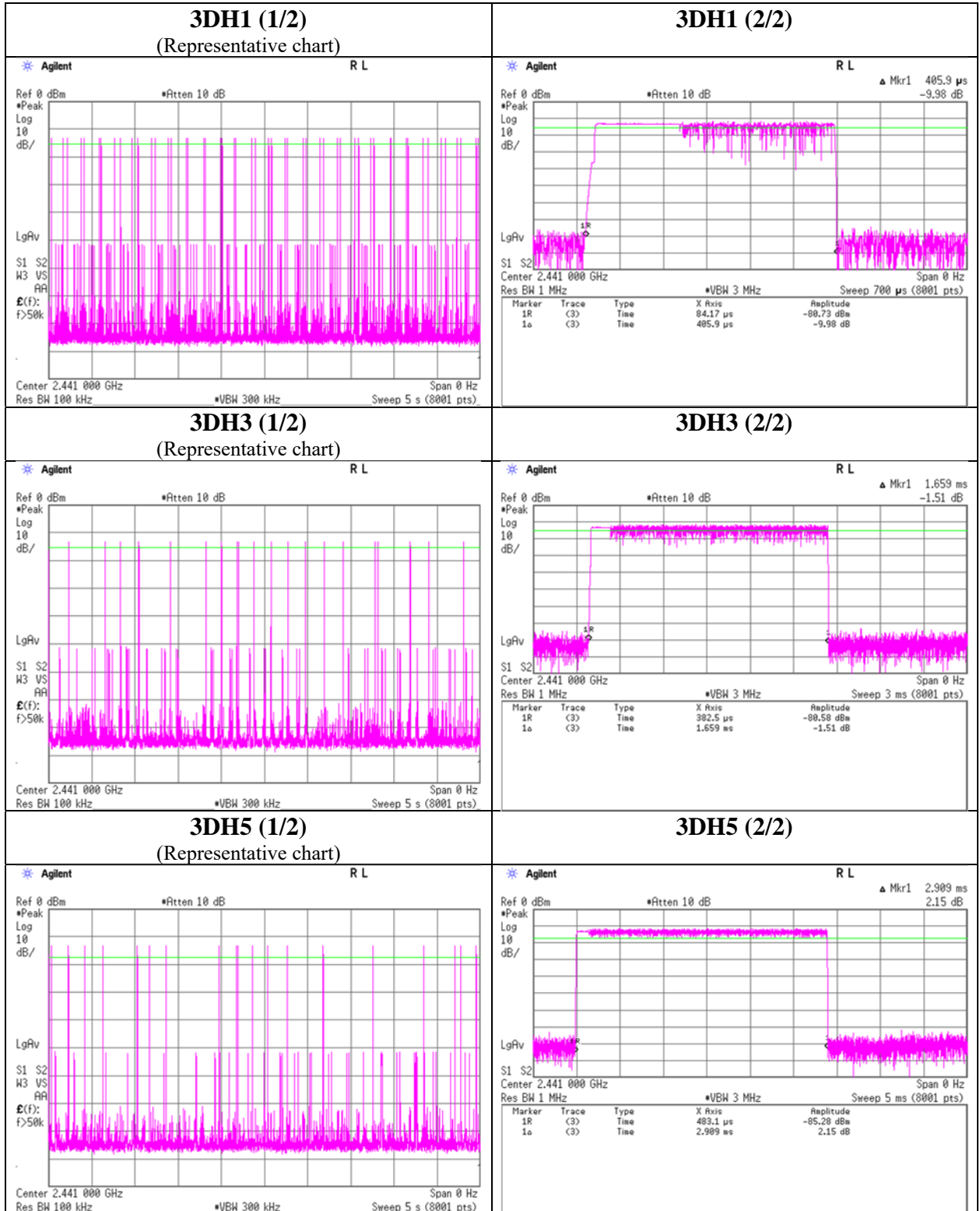

**UL Japan, Inc.**

**Shonan EMC Lab.**

1-22-3 Megumigaoka, Hiratsuka-shi, Kanagawa-ken, 259-1220 JAPAN

Telephone : +81 463 50 6400

Facsimile : +81 463 50 6401

**Maximum Peak Output Power**  
(Test model number: DNNS122)

Report No. 14071795S-A-R1  
Test place Shonan EMC Lab. No.5 Shielded Room  
Date February 8, 2021  
Temperature / Humidity 23 deg. C / 58 % RH  
Engineer Yosuke Murakami  
Mode Tx, Hopping Off

Mode	Freq. [MHz]	Reading [dBm]	Cable Loss [dB]	Atten. Loss [dB]	Conducted Power					e.i.r.p. for RSS-247					
					Result		Limit		Margin [dB]	Antenna Gain [dBi]	Result		Limit		Margin [dB]
					[dBm]	[mW]	[dBm]	[mW]			[dBm]	[mW]	[dBm]	[mW]	
DH5	2402.0	-12.61	1.52	9.88	-1.21	0.76	20.96	125	22.17	2.55	1.34	1.36	36.02	4000	34.68
DH5	2441.0	-12.09	1.52	9.88	-0.69	0.85	20.96	125	21.65	2.55	1.86	1.53	36.02	4000	34.16
DH5	2480.0	-12.25	1.53	9.88	-0.84	0.82	20.96	125	21.80	2.55	1.71	1.48	36.02	4000	34.31
2DH5	2402.0	-11.06	1.52	9.88	0.34	1.08	20.96	125	20.62	2.55	2.89	1.95	36.02	4000	33.13
2DH5	2441.0	-10.72	1.52	9.88	0.68	1.17	20.96	125	20.28	2.55	3.23	2.10	36.02	4000	32.79
2DH5	2480.0	-11.18	1.53	9.88	0.23	1.05	20.96	125	20.73	2.55	2.78	1.90	36.02	4000	33.24
3DH5	2402.0	-10.75	1.52	9.88	0.65	1.16	20.96	125	20.31	2.55	3.20	2.09	36.02	4000	32.82
3DH5	2441.0	-10.30	1.52	9.88	1.10	1.29	20.96	125	19.86	2.55	3.65	2.32	36.02	4000	32.37
3DH5	2480.0	-10.90	1.53	9.88	0.51	1.12	20.96	125	20.45	2.55	3.06	2.02	36.02	4000	32.96

Sample Calculation:  
Result = Reading + Cable Loss (including the cable(s) customer supplied) + Attenuator Loss  
e.i.r.p. Result = Conducted Power Result + Antenna Gain

Test was not performed at AFH mode, because the decrease of number of channel (min: 20 ch) at AFH mode does not influence on the output power and bandwidth of the EUT.  
As this device had AFH mode and frequency separation could not meet the requirement of over 20 dB BW without 2/3 relaxation, 125 mW power limit was applied to it.



**Maximum Peak Output Power(Spot-check test)**  
(Test model number: DNNS124)

Report No. 14071795S-A-R1  
Test place Shonan EMC Lab. No.3 Shielded Room  
Date August 12, 2021  
Temperature / Humidity 24 deg. C / 54 % RH  
Engineer Takahiro Kawakami  
Mode Tx, Hopping Off

Mode	Freq. [MHz]	Reading [dBm]	Cable Loss [dB]	Atten. Loss [dB]	Conducted Power					e.i.r.p. for RSS-247					
					Result		Limit		Margin [dB]	Antenna Gain [dBi]	Result		Limit		Margin [dB]
					[dBm]	[mW]	[dBm]	[mW]			[dBm]	[mW]	[dBm]	[mW]	
DH5	2402.0	-12.97	2.11	10.05	-0.81	0.83	20.96	125	21.77	2.55	1.74	1.49	36.02	4000	34.28
DH5	2441.0	-12.47	2.12	10.05	-0.30	0.93	20.96	125	21.26	2.55	2.25	1.68	36.02	4000	33.77
DH5	2480.0	-12.63	2.13	10.05	-0.45	0.90	20.96	125	21.41	2.55	2.10	1.62	36.02	4000	33.92
2DH5	2402.0	-11.56	2.11	10.05	0.60	1.15	20.96	125	20.36	2.55	3.15	2.07	36.02	4000	32.87
2DH5	2441.0	-11.19	2.12	10.05	0.98	1.25	20.96	125	19.98	2.55	3.53	2.25	36.02	4000	32.49
2DH5	2480.0	-11.66	2.13	10.05	0.52	1.13	20.96	125	20.44	2.55	3.07	2.03	36.02	4000	32.95
3DH5	2402.0	-11.47	2.11	10.05	0.69	1.17	20.96	125	20.27	2.55	3.24	2.11	36.02	4000	32.78
3DH5	2441.0	-11.02	2.12	10.05	1.15	1.30	20.96	125	19.81	2.55	3.70	2.34	36.02	4000	32.32
3DH5	2480.0	-11.48	2.13	10.05	0.70	1.17	20.96	125	20.26	2.55	3.25	2.11	36.02	4000	32.77

Sample Calculation:  
Result = Reading + Cable Loss (including the cable(s) customer supplied) + Attenuator Loss  
e.i.r.p. Result = Conducted Power Result + Antenna Gain

Test was not performed at AFH mode, because the decrease of number of channel (min: 20 ch) at AFH mode does not influence on the output power and bandwidth of the EUT.  
As this device had AFH mode and frequency separation could not meet the requirement of over 20 dB BW without 2/3 relaxation, 125 mW power limit was applied to it.

**Average Output Power**  
**(Reference data for RF Exposure)**  
(Test model number: DNNS122)

Report No. 14071795S-A-R1  
Test place Shonan EMC Lab. No.5 Shielded Room  
Date February 8, 2021  
Temperature / Humidity 23 deg. C / 58 % RH  
Engineer Yosuke Murakami  
Mode Tx, Hopping Off

Mode	Freq. [MHz]	Reading [dBm]	Cable Loss [dB]	Atten. Loss [dB]	Result (Time average)		Duty factor [dB]	Result (Burst power average)	
					[dBm]	[mW]		[dBm]	[mW]
DH5	2402.0	-14.58	1.52	9.88	-3.18	0.48	1.12	-2.06	0.62
DH5	2441.0	-13.97	1.52	9.88	-2.57	0.55	1.12	-1.45	0.72
DH5	2480.0	-14.14	1.53	9.88	-2.73	0.53	1.12	-1.61	0.69
2DH5	2402.0	-15.06	1.52	9.88	-3.66	0.43	1.11	-2.55	0.56
2DH5	2441.0	-14.49	1.52	9.88	-3.09	0.49	1.11	-1.98	0.63
2DH5	2480.0	-14.67	1.53	9.88	-3.26	0.47	1.11	-2.15	0.61
3DH5	2402.0	-15.05	1.52	9.88	-3.65	0.43	1.11	-2.54	0.56
3DH5	2441.0	-14.48	1.52	9.88	-3.08	0.49	1.11	-1.97	0.64
3DH5	2480.0	-14.64	1.53	9.88	-3.23	0.48	1.11	-2.12	0.61

Sample Calculation:

Result (Time average) = Reading + Cable Loss (including the cable(s) customer supplied) + Attenuator Loss

Result (Burst power average) = Time average + Duty factor

\*The equipment and cables were not used for factor 0 dB of the data sheets.

**Burst Rate Confirmation**  
(Test model number: DNNS122)

Report No. 14071795S-A-R1  
Test place Shonan EMC Lab. No.5 Shielded Room  
Date February 8, 2021  
Temperature / Humidity 23 deg. C / 58 % RH  
Engineer Yosuke Murakami  
Mode Tx, Hopping Off

**DH5**

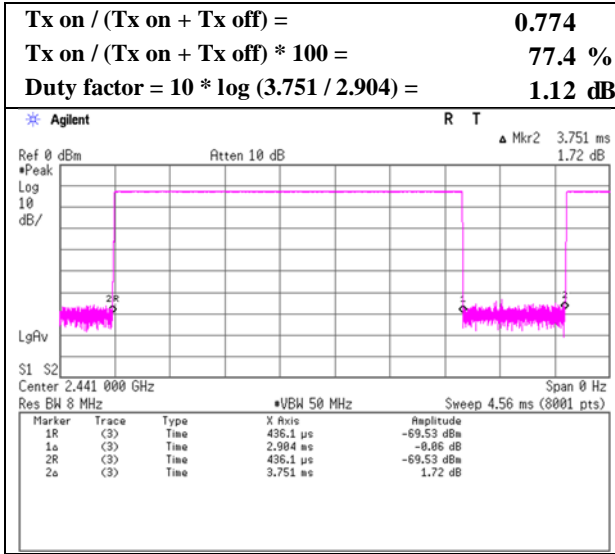

**2DH5**

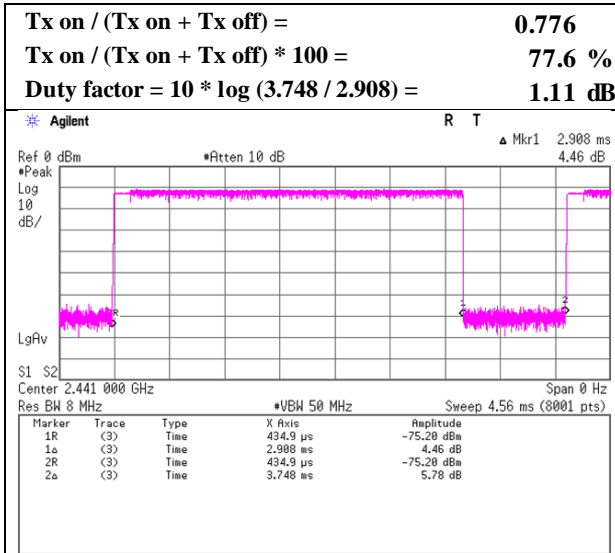

**3DH5**

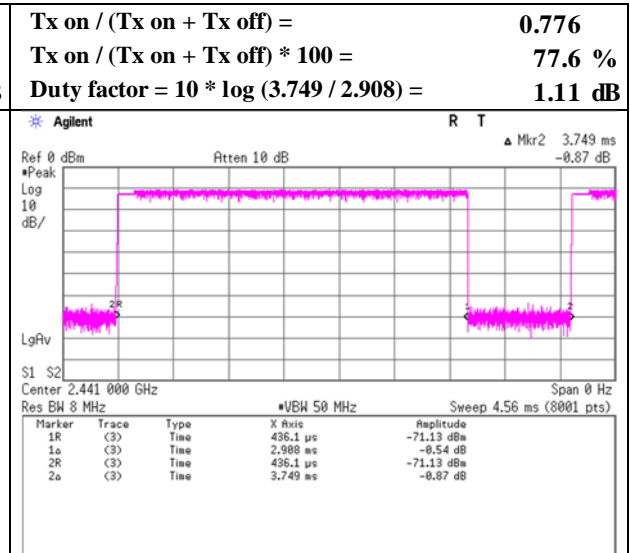

**Radiated Spurious Emission**  
(Test model number: DNNS122)

Report No. 14071795S-A-R1  
Test place Shonan EMC Lab.  
Semi Anechoic Chamber 1 1  
Date February 8, 2021 February 9, 2021 February 11, 2021  
Temperature / Humidity 22 deg.C, 36 %RH 24 deg.C, 33 %RH 20 deg.C, 30 %RH  
Engineer Toshinori Yamada Toshinori Yamada Yasumasa Owaki  
( 30 MHz -1 GHz, 18 GHz -26.5 GHz ) ( 1 GHz -10 GHz ) ( 10 GHz -18 GHz )  
Mode Tx, Hopping Off, DH5 2402 MHz

(\* PK: Peak, AV: Average, QP: Quasi-Peak)

Polarity	Frequency [MHz]	Detector	Reading [dBuV]	Ant.Fac. [dB/m]	Loss [dB]	Gain [dB]	Distance Factor [dB]	Result [dBuV/m]	Limit [dBuV/m]	Margin [dB]	Height [cm]	Angle [deg]	Remark
Hori.	367.973	QP	41.40	15.06	7.00	31.82	0.00	31.64	46.0	14.3	100	305	-
Hori.	431.995	QP	44.60	16.08	7.37	31.90	0.00	36.15	46.0	9.8	100	328	-
Hori.	479.999	QP	44.50	17.22	7.63	31.94	0.00	37.41	46.0	8.5	100	228	-
Hori.	599.851	QP	42.70	19.26	8.24	32.08	0.00	38.12	46.0	7.8	100	176	-
Hori.	959.989	QP	32.70	22.18	9.86	31.02	0.00	33.72	46.0	12.2	145	272	-
Hori.	2390.000	PK	45.38	27.93	14.88	39.55	2.06	50.70	73.9	23.2	134	269	-
Hori.	4804.000	PK	44.46	31.47	7.63	39.73	2.06	45.89	73.9	28.0	150	0	-
Hori.	7206.000	PK	44.67	36.90	9.32	39.51	2.06	53.44	73.9	20.4	150	0	-
Hori.	2390.000	AV	34.09	27.93	14.88	39.55	2.06	39.41	53.9	14.4	134	269	VBW:360 Hz
Hori.	4804.000	AV	34.78	31.47	7.63	39.73	2.06	36.21	53.9	17.6	150	0	VBW:360 Hz
Hori.	7206.000	AV	34.43	36.90	9.32	39.51	2.06	43.20	53.9	10.7	150	0	VBW:360 Hz
Vert.	42.822	QP	39.00	13.82	7.34	31.83	0.00	28.33	40.0	11.6	100	354	-
Vert.	65.733	QP	40.80	7.10	7.27	31.83	0.00	23.34	40.0	16.6	100	151	-
Vert.	86.139	QP	38.20	7.44	8.42	31.82	0.00	22.24	40.0	17.7	100	305	-
Vert.	431.992	QP	39.00	16.08	7.37	31.90	0.00	30.55	46.0	15.4	141	133	-
Vert.	599.831	QP	45.90	19.26	8.24	32.08	0.00	41.32	46.0	4.6	103	105	-
Vert.	2390.000	PK	45.57	27.93	14.88	39.55	2.06	50.89	73.9	23.0	157	271	-
Vert.	4804.000	PK	44.36	31.47	7.63	39.73	2.06	45.79	73.9	28.1	150	0	-
Vert.	7206.000	PK	44.48	36.90	9.32	39.51	2.06	53.25	73.9	20.6	150	0	-
Vert.	2390.000	AV	34.35	27.93	14.88	39.55	2.06	39.67	53.9	14.2	157	271	VBW:360 Hz
Vert.	4804.000	AV	34.18	31.47	7.63	39.73	2.06	35.61	53.9	18.2	150	0	VBW:360 Hz
Vert.	7206.000	AV	34.23	36.90	9.32	39.51	2.06	43.00	53.9	10.9	150	0	VBW:360 Hz

Result = Reading + Ant.Fac. + Loss (Cable+(Attenuator or Filter)(below 18 GHz)) - Gain(Amplifier) + Distance factor

Distance factor : 1 GHz - 10 GHz : 20log(3.80 m / 3.0 m) = 2.06 dB

10 GHz - 40 GHz : 20log(1.0 m / 3.0 m) = -9.54 dB

**20 dBc Data Sheet (RBW 100 kHz, VBW 300 kHz)**

Polarity	Frequency [MHz]	Detector	Reading [dBuV]	Ant.Fac. [dB/m]	Loss [dB]	Gain [dB]	Distance Factor [dB]	Result [dBuV/m]	Limit [dBuV/m]	Margin [dB]	Remark
Hori.	2402.000	PK	86.00	27.92	14.90	39.56	2.06	91.32	-	-	Carrier
Hori.	2400.000	PK	37.08	27.92	14.89	39.56	2.06	42.39	71.3	28.9	-
Vert.	2402.000	PK	80.98	27.92	14.90	39.56	2.06	86.30	-	-	Carrier
Vert.	2400.000	PK	36.34	27.92	14.89	39.56	2.06	41.65	66.3	24.6	-

Result = Reading + Ant.Fac. + Loss (Cable+(Attenuator or Filter)(below 18 GHz)) - Gain(Amplifier) + Distance factor

Distance factor : 1 GHz - 10 GHz : 20log(3.80 m / 3.0 m) = 2.06 dB

10 GHz - 40 GHz : 20log(1.0 m / 3.0 m) = -9.54 dB

**Radiated Spurious Emission**  
**(Reference Plot for band-edge)**  
 (Test model number: DNNS122)

Report No.	14071795S-A-R1
Test place	Shonan EMC Lab.
Semi Anechoic Chamber	1
Date	February 9, 2021
Temperature / Humidity	24 deg.C, 33 %RH
Engineer	Toshinori Yamada
Mode	Tx, Hopping Off, DH5 2402 MHz

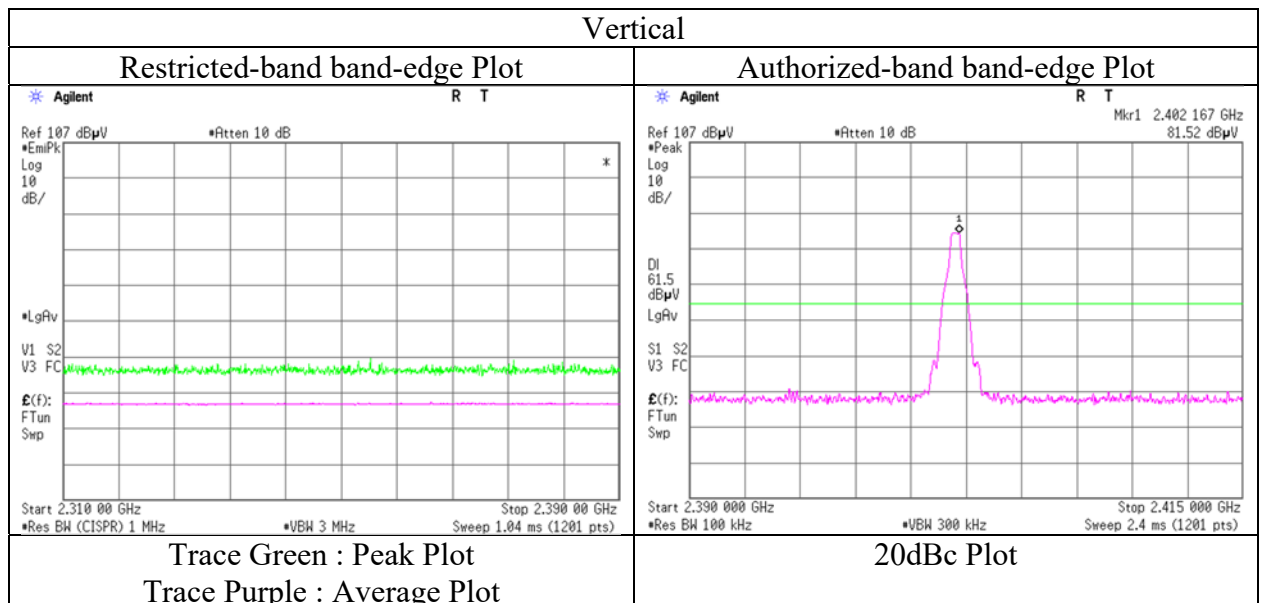
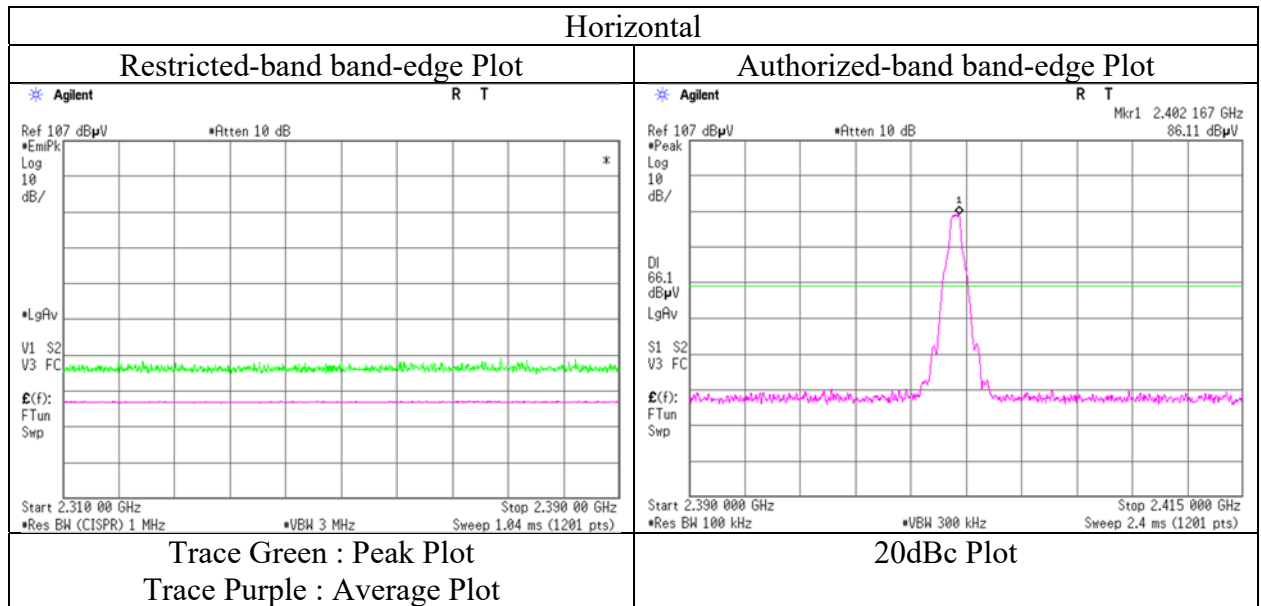

\* The measurement was conducted for a sufficiently long enough time to detect any possible spurious emissions. Final result of restricted band edge was shown in tabular data.

**Radiated Spurious Emission**  
(Test model number: DNNS122)

Report No. 14071795S-A-R1  
Test place Shonan EMC Lab.  
Semi Anechoic Chamber 1 1  
Date February 8, 2021 February 9, 2021 February 11, 2021  
Temperature / Humidity 22 deg.C, 36 %RH 24 deg.C, 33 %RH 20 deg.C, 30 %RH  
Engineer Toshinori Yamada Toshinori Yamada Yasumasa Owaki  
( 30 MHz -1 GHz, 18 GHz -26.5 GHz ) ( 1 GHz -10 GHz ) ( 10 GHz -18 GHz )  
Mode Tx, Hopping Off, DH5 2441 MHz

(\* PK: Peak, AV: Average, QP: Quasi-Peak)

Polarity	Frequency [MHz]	Detector	Reading [dBuV]	Ant.Fac. [dB/m]	Loss [dB]	Gain [dB]	Distance Factor [dB]	Result [dBuV/m]	Limit [dBuV/m]	Margin [dB]	Height [cm]	Angle [deg]	Remark
Hori.	367.366	QP	40.90	15.06	6.99	31.82	0.00	31.13	46.0	14.8	102	307	-
Hori.	431.957	QP	44.90	16.08	7.37	31.90	0.00	36.45	46.0	9.5	100	305	-
Hori.	480.061	QP	44.20	17.22	7.63	31.94	0.00	37.11	46.0	8.8	100	87	-
Hori.	600.004	QP	42.60	19.26	8.24	32.08	0.00	38.02	46.0	7.9	100	263	-
Hori.	959.998	QP	33.40	22.18	9.86	31.02	0.00	34.42	46.0	11.5	147	274	-
Hori.	4882.000	PK	44.49	31.51	7.68	39.72	2.06	46.02	73.9	27.8	150	0	-
Hori.	7323.000	PK	44.41	36.94	9.41	39.57	2.06	53.25	73.9	20.6	150	0	-
Hori.	4882.000	AV	34.68	31.51	7.68	39.72	2.06	36.21	53.9	17.6	150	0	VBW:360 Hz
Hori.	7323.000	AV	34.59	36.94	9.41	39.57	2.06	43.43	53.9	10.4	150	0	VBW:360 Hz
Vert.	42.544	QP	38.80	13.92	7.33	31.83	0.00	28.22	40.0	11.7	100	250	-
Vert.	65.867	QP	41.30	7.08	7.28	31.83	0.00	23.83	40.0	16.1	100	144	-
Vert.	86.293	QP	38.70	7.48	8.41	31.82	0.00	22.77	40.0	17.2	100	264	-
Vert.	432.064	QP	38.80	16.08	7.37	31.90	0.00	30.35	46.0	15.6	155	138	-
Vert.	599.866	QP	46.20	19.26	8.24	32.08	0.00	41.62	46.0	<b>4.3</b>	100	87	-
Vert.	4882.000	PK	44.67	31.51	7.68	39.72	2.06	46.20	73.9	27.7	150	0	-
Vert.	7323.000	PK	44.78	36.94	9.41	39.57	2.06	53.62	73.9	20.2	150	0	-
Vert.	4882.000	AV	34.43	31.51	7.68	39.72	2.06	35.96	53.9	17.9	150	0	VBW:360 Hz
Vert.	7323.000	AV	34.48	36.94	9.41	39.57	2.06	43.32	53.9	10.5	150	0	VBW:360 Hz

Result = Reading + Ant.Fac. + Loss (Cable+(Attenuator or Filter)(below 18 GHz)) - Gain(Amplifier) + Distance factor

Distance factor : 1 GHz - 10 GHz : 20log(3.80 m / 3.0 m) = 2.06 dB

10 GHz - 40 GHz : 20log(1.0 m / 3.0 m) = -9.54 dB

**UL Japan, Inc.**

**Shonan EMC Lab.**

1-22-3 Megumigaoka, Hiratsuka-shi, Kanagawa-ken, 259-1220 JAPAN

Telephone : +81 463 50 6400

Facsimile : +81 463 50 6401

**Radiated Spurious Emission**  
(Test model number: DNNS122)

Report No. 14071795S-A-R1  
Test place Shonan EMC Lab.  
Semi Anechoic Chamber 1 1  
Date February 8, 2021 February 9, 2021 February 11, 2021  
Temperature / Humidity 22 deg.C, 36 %RH 24 deg.C, 33 %RH 20 deg.C, 30 %RH  
Engineer Toshinori Yamada Toshinori Yamada Yasumasa Owaki  
( 30 MHz -1 GHz, 18 GHz -26.5 GHz ) ( 1 GHz -10 GHz ) ( 10 GHz -18 GHz )  
Mode Tx, Hopping Off, DH5 2480 MHz

(\* PK: Peak, AV: Average, QP: Quasi-Peak)

Polarity	Frequency [MHz]	Detector	Reading [dBuV]	Ant.Fac. [dB/m]	Loss [dB]	Gain [dB]	Distance Factor [dB]	Result [dBuV/m]	Limit [dBuV/m]	Margin [dB]	Height [cm]	Angle [deg]	Remark
Hori.	368.209	QP	40.50	15.06	7.00	31.82	0.00	30.74	46.0	15.2	100	311	-
Hori.	431.952	QP	45.10	16.08	7.37	31.90	0.00	36.65	46.0	9.3	100	298	-
Hori.	480.081	QP	44.00	17.22	7.63	31.94	0.00	36.91	46.0	9.0	100	94	-
Hori.	600.002	QP	42.80	19.26	8.24	32.08	0.00	38.22	46.0	7.7	100	260	-
Hori.	959.998	QP	33.70	22.18	9.86	31.02	0.00	34.72	46.0	11.2	143	267	-
Hori.	2483.500	PK	46.60	27.84	14.99	39.58	2.06	51.91	73.9	21.9	144	263	-
Hori.	4960.000	PK	44.68	31.69	7.75	39.71	2.06	46.47	73.9	27.4	150	0	-
Hori.	7440.000	PK	44.52	37.02	9.49	39.62	2.06	53.47	73.9	20.4	150	0	-
Hori.	2483.500	AV	34.11	27.84	14.99	39.58	2.06	39.42	53.9	14.4	144	263	VBW:360 Hz
Hori.	4960.000	AV	34.45	31.69	7.75	39.71	2.06	36.24	53.9	17.6	150	0	VBW:360 Hz
Hori.	7440.000	AV	34.67	37.02	9.49	39.62	2.06	43.62	53.9	10.2	150	0	VBW:360 Hz
Vert.	42.888	QP	39.20	13.79	7.34	31.83	0.00	28.50	40.0	11.5	100	38	-
Vert.	65.640	QP	41.20	7.12	7.26	31.83	0.00	23.75	40.0	16.2	100	133	-
Vert.	86.273	QP	38.00	7.47	8.41	31.82	0.00	22.06	40.0	17.9	100	271	-
Vert.	432.057	QP	39.20	16.08	7.37	31.90	0.00	30.75	46.0	15.2	134	137	-
Vert.	600.002	QP	46.00	19.26	8.24	32.08	0.00	41.42	46.0	4.5	100	109	-
Vert.	2483.500	PK	45.21	27.84	14.99	39.58	2.06	50.52	73.9	23.3	110	328	-
Vert.	4960.000	PK	44.45	31.69	7.75	39.71	2.06	46.24	73.9	27.6	150	0	-
Vert.	7440.000	PK	44.68	37.02	9.49	39.62	2.06	53.63	73.9	20.2	150	0	-
Vert.	2483.500	AV	33.98	27.84	14.99	39.58	2.06	39.29	53.9	14.6	110	328	VBW:360 Hz
Vert.	4960.000	AV	34.61	31.69	7.75	39.71	2.06	36.40	53.9	17.5	150	0	VBW:360 Hz
Vert.	7440.000	AV	34.78	37.02	9.49	39.62	2.06	43.73	53.9	10.1	150	0	VBW:360 Hz

Result = Reading + Ant.Fac. + Loss (Cable+(Attenuator or Filter)(below 18 GHz)) - Gain(Amplifier) + Distance factor

Distance factor : 1 GHz - 10 GHz : 20log(3.80 m / 3.0 m) = 2.06 dB

10 GHz - 40 GHz : 20log(1.0 m / 3.0 m) = -9.54 dB

**Radiated Spurious Emission**  
**(Reference Plot for band-edge)**  
**(Test model number: DNNS122)**

Report No. 14071795S-A-R1  
Test place Shonan EMC Lab.  
Semi Anechoic Chamber 1  
Date February 9, 2021  
Temperature / Humidity 24 deg.C, 33 %RH  
Engineer Yosuke Murakami  
Mode Tx, Hopping Off, DH5 2480 MHz

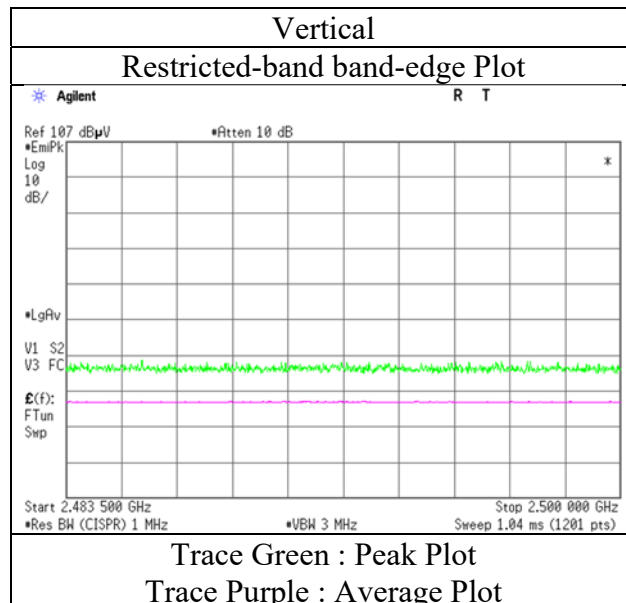
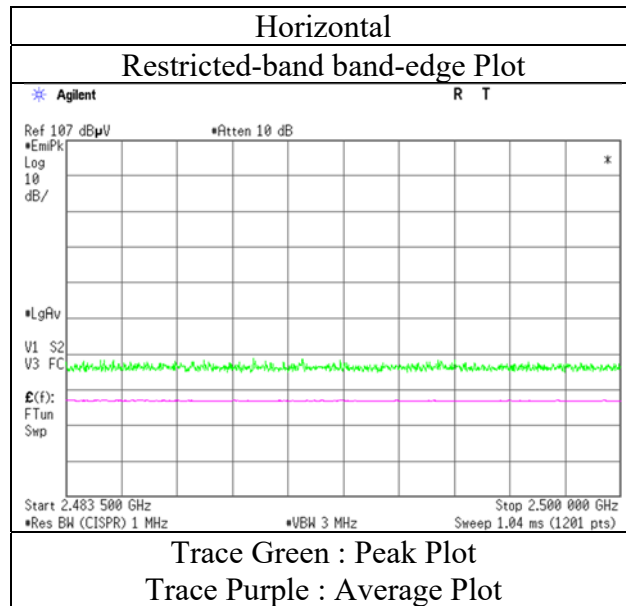

\* The measurement was conducted for a sufficiently long enough time to detect any possible spurious emissions. Final result of restricted band edge was shown in tabular data.



**Radiated Spurious Emission**  
(Test model number: DNNS122)

Report No. 14071795S-A-R1  
Test place Shonan EMC Lab.  
Semi Anechoic Chamber 1 1  
Date February 8, 2021 February 9, 2021 February 11, 2021  
Temperature / Humidity 22 deg.C, 36 %RH 24 deg.C, 33 %RH 20 deg.C, 30 %RH  
Engineer Toshinori Yamada Toshinori Yamada Yasumasa Owaki  
( 30 MHz -1 GHz, 18 GHz -26.5 GHz ) ( 1 GHz -10 GHz ) ( 10 GHz -18 GHz )  
Mode Tx, Hopping Off, 3DH5 2402 MHz

(\* PK: Peak, AV: Average, QP: Quasi-Peak)

Polarity	Frequency [MHz]	Detector	Reading [dBuV]	Ant.Fac. [dB/m]	Loss [dB]	Gain [dB]	Distance Factor [dB]	Result [dBuV/m]	Limit [dBuV/m]	Margin [dB]	Height [cm]	Angle [deg]	Remark
Hori.	365.708	QP	40.20	15.06	6.98	31.82	0.00	30.42	46.0	15.5	100	312	-
Hori.	431.994	QP	45.30	16.08	7.37	31.90	0.00	36.85	46.0	9.1	100	299	-
Hori.	480.075	QP	44.10	17.22	7.63	31.94	0.00	37.01	46.0	8.9	100	101	-
Hori.	599.969	QP	43.30	19.26	8.24	32.08	0.00	38.72	46.0	7.2	100	105	-
Hori.	959.953	QP	33.30	22.18	9.86	31.02	0.00	34.32	46.0	11.6	144	275	-
Hori.	2390.000	PK	45.68	27.93	14.88	39.55	2.06	51.00	73.9	22.9	148	263	-
Hori.	4804.000	PK	44.62	31.47	7.63	39.73	2.06	46.05	73.9	27.8	150	0	-
Hori.	7206.000	PK	44.10	36.90	9.32	39.51	2.06	52.87	73.9	21.0	150	0	-
Hori.	2390.000	AV	34.05	27.93	14.88	39.55	2.06	39.37	53.9	14.5	148	263	VBW:360 Hz
Hori.	4804.000	AV	33.83	31.47	7.63	39.73	2.06	35.26	53.9	18.6	150	0	VBW:360 Hz
Hori.	7206.000	AV	33.61	36.90	9.32	39.51	2.06	42.38	53.9	11.5	150	0	VBW:360 Hz
Vert.	42.901	QP	39.40	13.79	7.34	31.83	0.00	28.70	40.0	11.3	100	356	-
Vert.	65.402	QP	41.10	7.16	7.25	31.83	0.00	23.68	40.0	16.3	100	139	-
Vert.	86.172	QP	37.60	7.45	8.42	31.82	0.00	21.65	40.0	18.3	100	280	-
Vert.	431.994	QP	38.70	16.08	7.37	31.90	0.00	30.25	46.0	15.7	100	164	-
Vert.	599.851	QP	46.30	19.26	8.24	32.08	0.00	41.72	46.0	4.2	100	105	-
Vert.	2390.000	PK	44.83	27.93	14.88	39.55	2.06	50.15	73.9	23.7	156	272	-
Vert.	4804.000	PK	44.67	31.47	7.63	39.73	2.06	46.10	73.9	27.8	150	0	-
Vert.	5192.099	PK	48.73	32.13	7.93	39.72	2.06	51.13	73.9	22.7	100	0	-
Vert.	7206.000	PK	44.65	36.90	9.32	39.51	2.06	53.42	73.9	20.4	150	0	-
Vert.	2390.000	AV	34.11	27.93	14.88	39.55	2.06	39.43	53.9	14.4	156	272	VBW:360 Hz
Vert.	4804.000	AV	33.85	31.47	7.63	39.73	2.06	35.28	53.9	18.6	150	0	VBW:360 Hz
Vert.	5192.099	AV	36.89	32.13	7.93	39.72	2.06	39.29	53.9	14.6	100	0	VBW:10 Hz
Vert.	7206.000	AV	33.34	36.90	9.32	39.51	2.06	42.11	53.9	11.7	150	0	VBW:360 Hz

Result = Reading + Ant.Fac. + Loss (Cable+(Attenuator or Filter)(below 18 GHz)) - Gain(Amplifier) + Distance factor

Distance factor : 1 GHz - 10 GHz : 20log(3.80 m / 3.0 m) = 2.06 dB

10 GHz - 40 GHz : 20log(1.0 m / 3.0 m) = -9.54 dB

**20 dBc Data Sheet (RBW 100 kHz, VBW 300 kHz)**

Polarity	Frequency [MHz]	Detector	Reading [dBuV]	Ant.Fac. [dB/m]	Loss [dB]	Gain [dB]	Distance Factor [dB]	Result [dBuV/m]	Limit [dBuV/m]	Margin [dB]	Remark
Hori.	2402.000	PK	84.40	27.92	14.90	39.56	2.06	89.72	-	-	Carrier
Hori.	2400.000	PK	37.06	27.92	14.89	39.56	2.06	42.37	69.7	27.3	-
Vert.	2402.000	PK	81.17	27.92	14.90	39.56	2.06	86.49	-	-	Carrier
Vert.	2400.000	PK	36.24	27.92	14.89	39.56	2.06	41.55	66.4	24.8	-

Result = Reading + Ant.Fac. + Loss (Cable+(Attenuator or Filter)(below 18 GHz)) - Gain(Amplifier) + Distance factor

Distance factor : 1 GHz - 10 GHz : 20log(3.80 m / 3.0 m) = 2.06 dB

10 GHz - 40 GHz : 20log(1.0 m / 3.0 m) = -9.54 dB

**UL Japan, Inc.**

**Shonan EMC Lab.**

1-22-3 Megumigaoka, Hiratsuka-shi, Kanagawa-ken, 259-1220 JAPAN

Telephone : +81 463 50 6400

Facsimile : +81 463 50 6401

**Radiated Spurious Emission**  
**(Reference Plot for band-edge)**  
**(Test model number: DNNS122)**

Report No. 14071795S-A-R1  
Test place Shonan EMC Lab.  
Semi Anechoic Chamber 1  
Date February 9, 2021  
Temperature / Humidity 24 deg.C, 33 %RH  
Engineer Toshinori Yamada  
Mode Tx, Hopping Off, 3DH5 2402 MHz

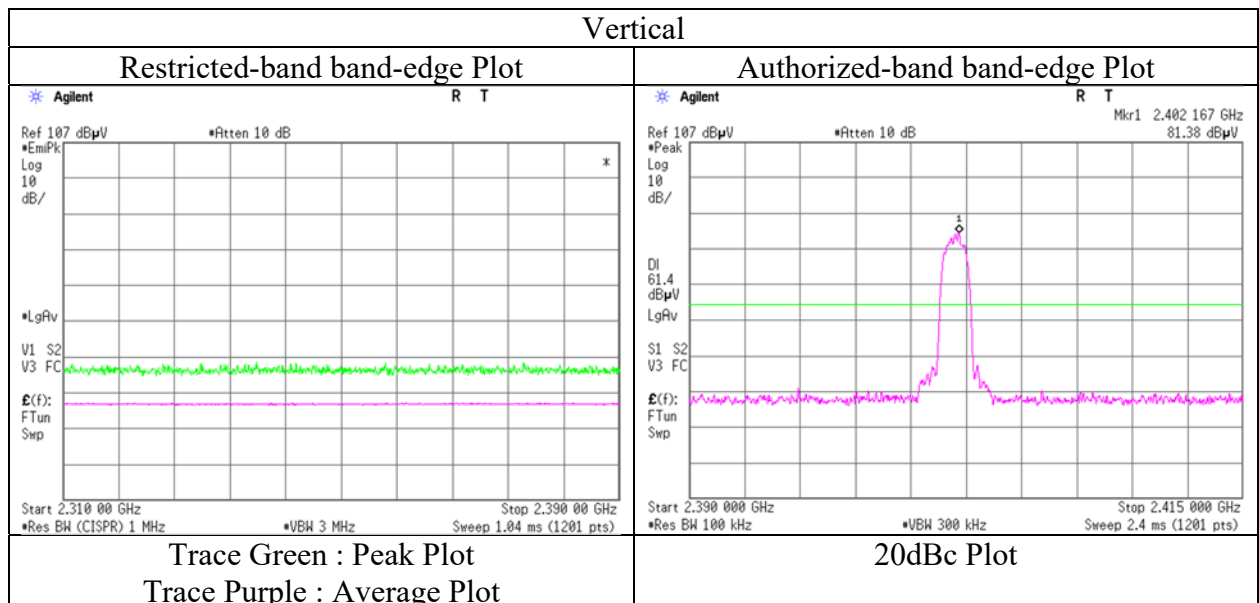
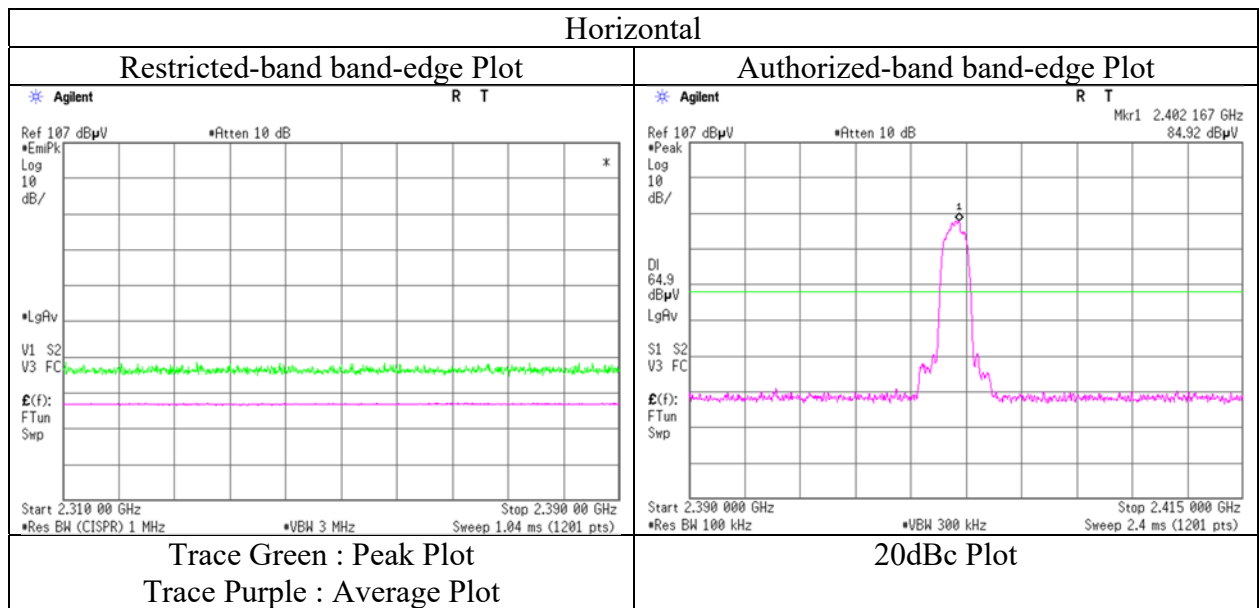

\* The measurement was conducted for a sufficiently long enough time to detect any possible spurious emissions. Final result of restricted band edge was shown in tabular data.

**Radiated Spurious Emission**  
(Test model number: DNNS122)

Report No. 14071795S-A-R1  
Test place Shonan EMC Lab.  
Semi Anechoic Chamber 1 1  
Date February 8, 2021 February 9, 2021 February 11, 2021  
Temperature / Humidity 22 deg.C, 36 %RH 24 deg.C, 33 %RH 20 deg.C, 30 %RH  
Engineer Toshinori Yamada Toshinori Yamada Yasumasa Owaki  
( 30 MHz -1 GHz, 18 GHz -26.5 GHz ) ( 1 GHz -10 GHz ) ( 10 GHz -18 GHz )  
Mode Tx, Hopping Off, 3DH5 2441 MHz

(\* PK: Peak, AV: Average, QP: Quasi-Peak)

Polarity	Frequency [MHz]	Detector	Reading [dBuV]	Ant.Fac. [dB/m]	Loss [dB]	Gain [dB]	Distance Factor [dB]	Result [dBuV/m]	Limit [dBuV/m]	Margin [dB]	Height [cm]	Angle [deg]	Remark
Hori.	368.159	QP	39.50	15.06	7.00	31.82	0.00	29.74	46.0	16.2	100	307	-
Hori.	432.084	QP	45.50	16.08	7.37	31.90	0.00	37.05	46.0	8.9	100	183	-
Hori.	480.114	QP	44.40	17.22	7.63	31.94	0.00	37.31	46.0	8.6	100	288	-
Hori.	599.987	QP	43.00	19.26	8.24	32.08	0.00	38.42	46.0	7.5	100	153	-
Hori.	959.982	QP	33.50	22.18	9.86	31.02	0.00	34.52	46.0	11.4	153	272	-
Hori.	4882.000	PK	44.42	31.51	7.68	39.72	2.06	45.95	73.9	27.9	150	0	-
Hori.	7323.000	PK	43.69	36.94	9.41	39.57	2.06	52.53	73.9	21.3	150	0	-
Hori.	4882.000	AV	33.79	31.51	7.68	39.72	2.06	35.32	53.9	18.5	150	0	VBW:360 Hz
Hori.	7323.000	AV	33.69	36.94	9.41	39.57	2.06	42.53	53.9	11.3	150	0	VBW:360 Hz
Vert.	42.881	QP	39.20	13.79	7.34	31.83	0.00	28.50	40.0	11.5	100	358	-
Vert.	65.808	QP	41.20	7.09	7.27	31.83	0.00	23.73	40.0	16.2	100	162	-
Vert.	86.187	QP	38.20	7.45	8.42	31.82	0.00	22.25	40.0	17.7	100	288	-
Vert.	431.999	QP	36.40	16.08	7.37	31.90	0.00	27.95	46.0	18.0	100	284	-
Vert.	599.857	QP	46.30	19.26	8.24	32.08	0.00	41.72	46.0	<b>4.2</b>	100	100	-
Vert.	4882.000	PK	44.28	31.51	7.68	39.72	2.06	45.81	73.9	28.0	150	0	-
Vert.	7323.000	PK	44.25	36.94	9.41	39.57	2.06	53.09	73.9	20.8	150	0	-
Vert.	4882.000	AV	33.81	31.51	7.68	39.72	2.06	35.34	53.9	18.5	150	0	VBW:360 Hz
Vert.	7323.000	AV	33.24	36.94	9.41	39.57	2.06	42.08	53.9	11.8	150	0	VBW:360 Hz

Result = Reading + Ant.Fac. + Loss (Cable+(Attenuator or Filter)(below 18 GHz)) - Gain(Amplifier) + Distance factor

Distance factor : 1 GHz - 10 GHz : 20log(3.80 m / 3.0 m) = 2.06 dB

10 GHz - 40 GHz : 20log(1.0 m / 3.0 m) = -9.54 dB

**UL Japan, Inc.**

**Shonan EMC Lab.**

1-22-3 Megumigaoka, Hiratsuka-shi, Kanagawa-ken, 259-1220 JAPAN

Telephone : +81 463 50 6400

Facsimile : +81 463 50 6401

**Radiated Spurious Emission**  
(Test model number: DNNS122)

Report No. 14071795S-A-R1  
Test place Shonan EMC Lab.  
Semi Anechoic Chamber 1 1  
Date February 8, 2021 February 9, 2021 February 11, 2021  
Temperature / Humidity 22 deg.C, 36 %RH 24 deg.C, 33 %RH 20 deg.C, 30 %RH  
Engineer Toshinori Yamada Toshinori Yamada Yasumasa Owaki  
( 30 MHz -1 GHz, 18 GHz -26.5 GHz ) ( 1 GHz -10 GHz ) ( 10 GHz -18 GHz )  
Mode Tx, Hopping Off, 3DH5 2480 MHz

(\* PK: Peak, AV: Average, QP: Quasi-Peak)

Polarity	Frequency [MHz]	Detector	Reading [dBuV]	Ant.Fac. [dB/m]	Loss [dB]	Gain [dB]	Distance Factor [dB]	Result [dBuV/m]	Limit [dBuV/m]	Margin [dB]	Height [cm]	Angle [deg]	Remark
Hori.	367.057	QP	40.10	15.06	6.99	31.82	0.00	30.33	46.0	15.6	101	119	-
Hori.	432.000	QP	44.10	16.08	7.37	31.90	0.00	35.65	46.0	10.3	100	299	-
Hori.	480.002	QP	44.40	17.22	7.63	31.94	0.00	37.31	46.0	8.6	100	228	-
Hori.	599.838	QP	43.10	19.26	8.24	32.08	0.00	38.52	46.0	7.4	150	160	-
Hori.	959.998	QP	32.30	22.18	9.86	31.02	0.00	33.32	46.0	12.6	150	266	-
Hori.	2483.500	PK	45.75	27.84	14.99	39.58	2.06	51.06	73.9	22.8	142	264	-
Hori.	4960.000	PK	44.67	31.69	7.75	39.71	2.06	46.46	73.9	27.4	150	0	-
Hori.	7440.000	PK	43.56	37.02	9.49	39.62	2.06	52.51	73.9	21.3	150	0	-
Hori.	2483.500	AV	34.38	27.84	14.99	39.58	2.06	39.69	53.9	14.2	142	264	VBW:360 Hz
Hori.	4960.000	AV	33.64	31.69	7.75	39.71	2.06	35.43	53.9	18.4	150	0	VBW:360 Hz
Hori.	7440.000	AV	33.28	37.02	9.49	39.62	2.06	42.23	53.9	11.6	150	0	VBW:360 Hz
Vert.	42.944	QP	39.20	13.77	7.34	31.83	0.00	28.48	40.0	11.5	100	331	-
Vert.	65.832	QP	41.60	7.09	7.28	31.83	0.00	24.14	40.0	15.8	100	166	-
Vert.	86.189	QP	37.90	7.45	8.42	31.82	0.00	21.95	40.0	18.0	100	265	-
Vert.	432.110	QP	36.90	16.08	7.37	31.90	0.00	28.45	46.0	17.5	100	125	-
Vert.	599.843	QP	46.10	19.26	8.24	32.08	0.00	41.52	46.0	4.4	100	201	-
Vert.	2483.500	PK	44.68	27.84	14.99	39.58	2.06	49.99	73.9	23.9	100	331	-
Vert.	4960.000	PK	44.48	31.69	7.75	39.71	2.06	46.27	73.9	27.6	150	0	-
Vert.	7440.000	PK	44.19	37.02	9.49	39.62	2.06	53.14	73.9	20.7	150	0	-
Vert.	2483.500	AV	34.11	27.84	14.99	39.58	2.06	39.42	53.9	14.4	100	331	VBW:360 Hz
Vert.	4960.000	AV	33.65	31.69	7.75	39.71	2.06	35.44	53.9	18.4	150	0	VBW:360 Hz
Vert.	7440.000	AV	33.45	37.02	9.49	39.62	2.06	42.40	53.9	11.5	150	0	VBW:360 Hz

Result = Reading + Ant.Fac. + Loss (Cable+(Attenuator or Filter)(below 18 GHz)) - Gain(Amplifier) + Distance factor

Distance factor : 1 GHz - 10 GHz : 20log(3.80 m / 3.0 m) = 2.06 dB

10 GHz - 40 GHz : 20log(1.0 m / 3.0 m) = -9.54 dB

**Radiated Spurious Emission**  
**(Reference Plot for band-edge)**  
**(Test model number: DNNS122)**

Report No. 14071795S-A-R1  
Test place Shonan EMC Lab.  
Semi Anechoic Chamber 1  
Date February 9, 2021  
Temperature / Humidity 24 deg.C, 33 %RH  
Engineer Toshinori Yamada  
Mode Tx, Hopping Off, 3DH5 2480 MHz

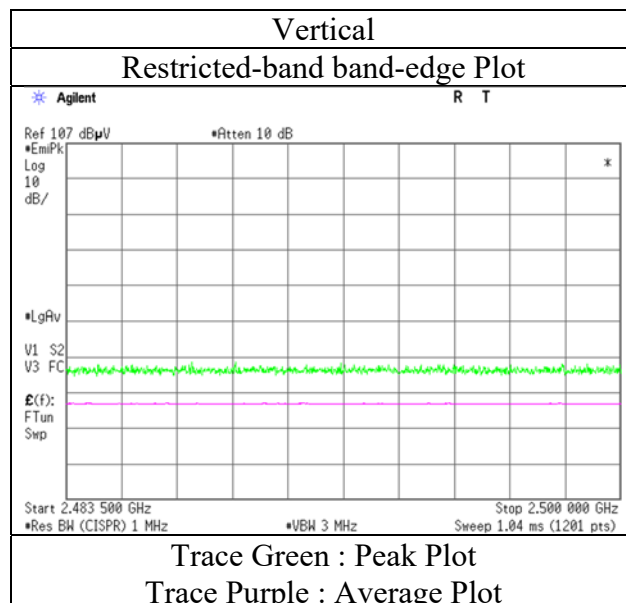
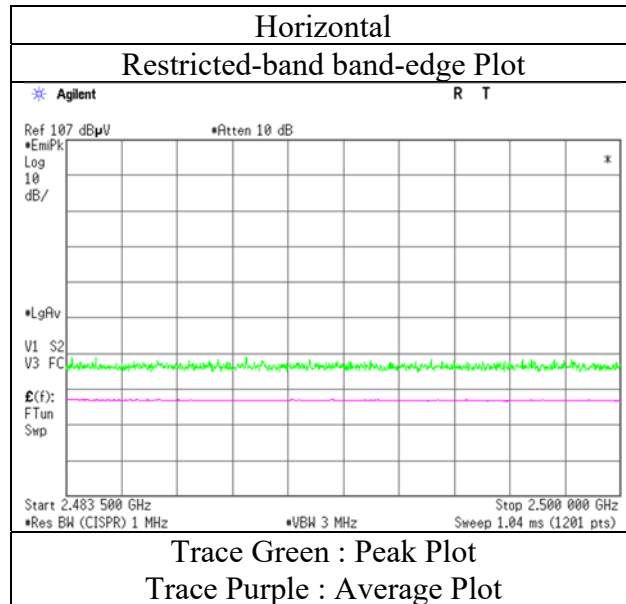

\* The measurement was conducted for a sufficiently long enough time to detect any possible spurious emissions. Final result of restricted band edge was shown in tabular data.

**Radiated Spurious Emission**  
**(Plot data, Worst case)**  
 (Test model number: DNNS122)

Report No.	14071795S-A-R1		
Test place	Shonan EMC Lab.		
Semi Anechoic Chamber	1	1	1
Date	February 8, 2021	February 9, 2021	February 11, 2021
Temperature / Humidity	22 deg.C, 36 %RH	24 deg.C, 33 %RH	20 deg.C, 30 %RH
Engineer	Toshinori Yamada	Toshinori Yamada	Yasumasa Owaki
	( 30 MHz -1 GHz, 18 GHz -26.5 GHz )	( 1 GHz -10 GHz )	( 10 GHz -18 GHz )
Mode	Tx, Hopping Off, 3DH5 2441 MHz		

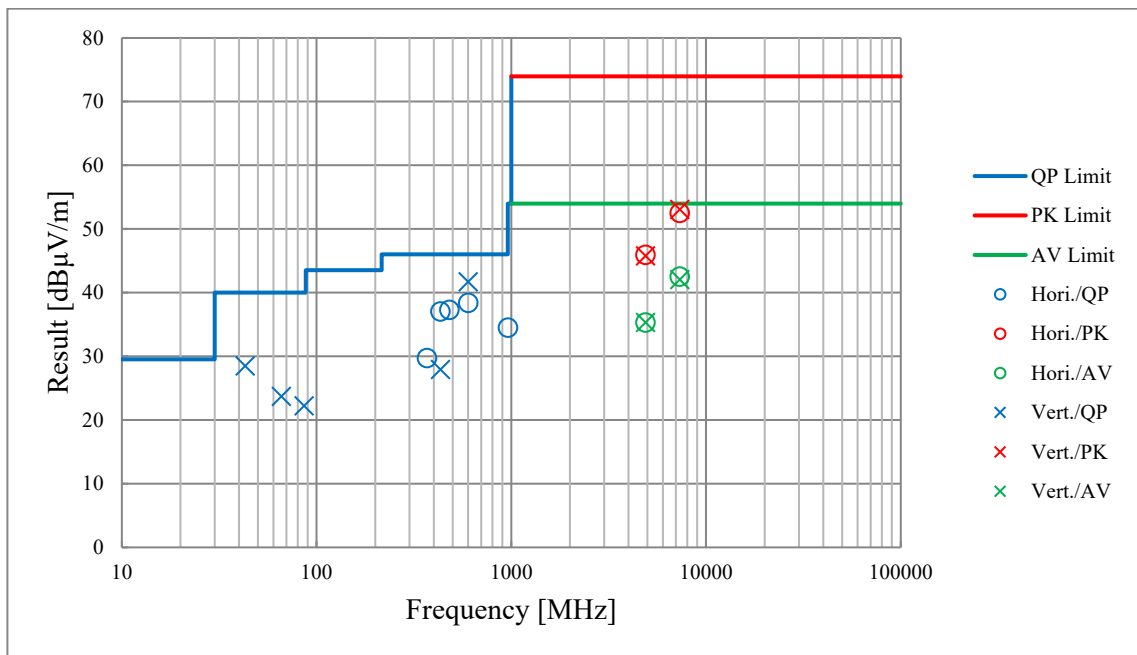

\*These plots data contains sufficient number to show the trend of characteristic features for EUT.

**Radiated Spurious Emission**  
(Test model number: DNNS124)

Report No. 14071795S-A-R1  
Test place Shonan EMC Lab.  
Semi Anechoic Chamber 3  
Date August 6, 2021  
Temperature / Humidity 20 deg.C, 53 %RH  
Engineer Shiro Kobayashi  
( 1 GHz -2.8 GHz )  
Mode Tx, Hopping Off, DH5 2402 MHz

(\* PK: Peak, AV: Average, QP: Quasi-Peak)

Polarity	Frequency [MHz]	Detector	Reading [dBuV]	Ant.Fac. [dB/m]	Loss [dB]	Gain [dB]	Distance Factor [dB]	Result [dBuV/m]	Limit [dBuV/m]	Margin [dB]	Height [cm]	Angle [deg]	Remark
Hori.	2390.000	PK	47.20	28.33	14.43	41.62	2.06	50.40	73.9	23.5	152	280	-
Hori.	2390.000	AV	35.57	28.33	14.43	41.62	2.06	38.77	53.9	<b>15.1</b>	152	280	VBW: 360 Hz
Vert.	2390.000	PK	47.41	28.33	14.43	41.62	2.06	50.61	73.9	23.2	110	327	-
Vert.	2390.000	AV	35.58	28.33	14.43	41.62	2.06	38.78	53.9	<b>15.1</b>	110	327	VBW: 360 Hz

Result = Reading + Ant.Fac. + Loss (Cable+(Attenuator or Filter)(below 18 GHz)) - Gain(Amplifier) + Distance factor

Distance factor : 1 GHz - 10 GHz : 20log(3.80 m / 3.0 m) = 2.06 dB

10 GHz - 40 GHz : 20log(1.0 m / 3.0 m) = -9.54 dB

\*These results have sufficient margin without taking account Duty cycle correction factor.

**20 dBc Data Sheet (RBW 100 kHz, VBW 300 kHz)**

Polarity	Frequency [MHz]	Detector	Reading [dBuV]	Ant.Fac. [dB/m]	Loss [dB]	Gain [dB]	Distance Factor [dB]	Result [dBuV/m]	Limit [dBuV/m]	Margin [dB]	Remark
Hori.	2402.000	PK	87.84	28.31	14.45	41.63	2.06	91.03	-	-	Carrier
Hori.	2400.000	PK	38.94	28.31	14.45	41.63	2.06	42.13	71.0	28.8	-
Vert.	2402.000	PK	84.41	28.31	14.45	41.63	2.06	87.60	-	-	Carrier
Vert.	2400.000	PK	36.82	28.31	14.45	41.63	2.06	40.01	67.6	27.5	-

Result = Reading + Ant.Fac. + Loss (Cable+(Attenuator or Filter)(below 18 GHz)) - Gain(Amplifier) + Distance factor

Distance factor : 1 GHz - 10 GHz : 20log(3.80 m / 3.0 m) = 2.06 dB

10 GHz - 40 GHz : 20log(1.0 m / 3.0 m) = -9.54 dB

**Radiated Spurious Emission**  
**(Reference Plot for band-edge)**  
**(Test model number: DNNS124)**

Report No.	14071795S-A-R1
Test place	Shonan EMC Lab.
Semi Anechoic Chamber	3
Date	August 6, 2021
Temperature / Humidity	20 deg.C, 53 %RH
Engineer	Shiro Kobayashi ( 1 GHz -2.8 GHz )
Mode	Tx, Hopping Off, DH5 2402 MHz

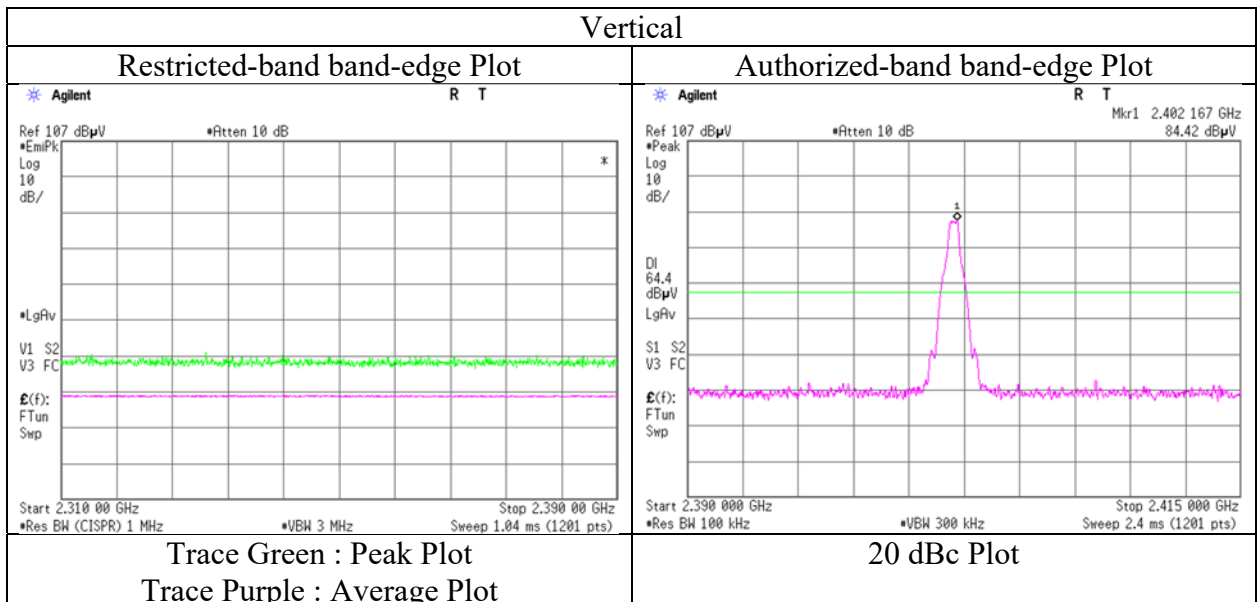
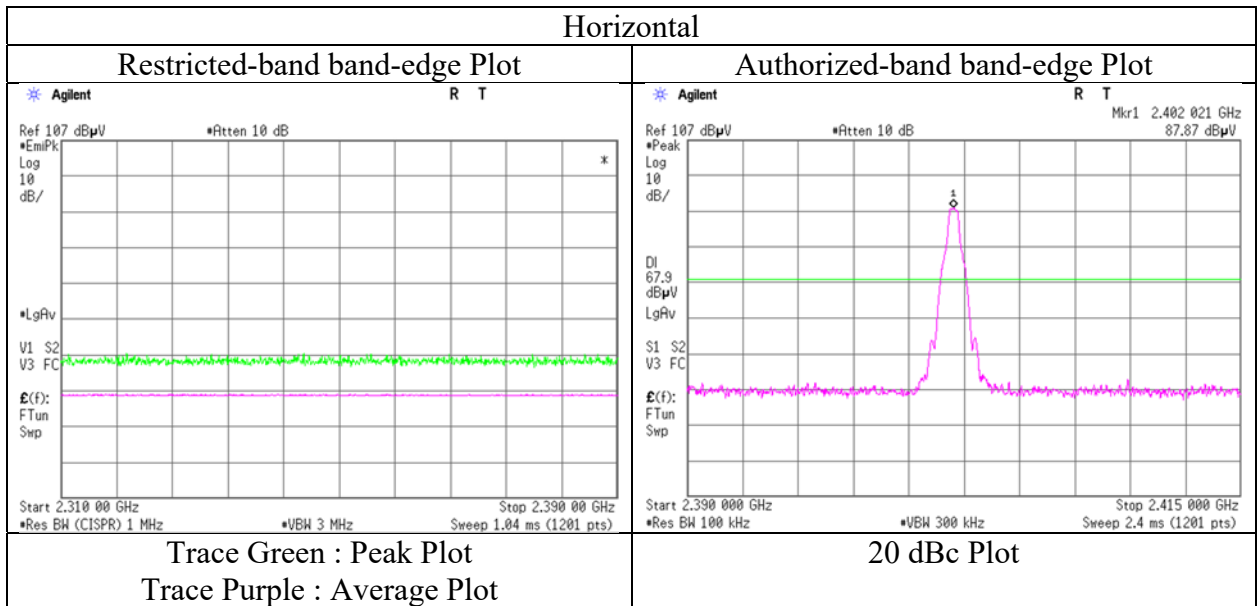

\* The measurement was conducted for a sufficiently long enough time to detect any possible spurious emissions. Final result of restricted band edge was shown in tabular data.



**Radiated Spurious Emission**  
(Test model number: DNNS124)

Report No. 14071795S-A-R1  
Test place Shonan EMC Lab.  
Semi Anechoic Chamber 3  
Date August 6, 2021  
Temperature / Humidity 20 deg.C, 53 %RH  
Engineer Shiro Kobayashi  
( 1 GHz -2.8 GHz )  
Mode Tx, Hopping Off, DH5 2480 MHz

(\* PK: Peak, AV: Average, QP: Quasi-Peak)

Polarity	Frequency [MHz]	Detector	Reading [dBuV]	Ant.Fac. [dB/m]	Loss [dB]	Gain [dB]	Distance Factor [dB]	Result [dBuV/m]	Limit [dBuV/m]	Margin [dB]	Height [cm]	Angle [deg]	Remark
Hori.	2483.500	PK	48.11	28.24	14.53	41.65	2.06	51.29	73.9	22.6	183	276	-
Hori.	2483.500	AV	36.49	28.24	14.53	41.65	2.06	39.67	53.9	<b>14.2</b>	183	276	VBW: 360 Hz
Vert.	2483.500	PK	47.81	28.24	14.53	41.65	2.06	50.99	73.9	22.9	102	30	-
Vert.	2483.500	AV	36.30	28.24	14.53	41.65	2.06	39.48	53.9	14.4	102	30	VBW: 360 Hz

Result = Reading + Ant.Fac. + Loss (Cable+(Attenuator or Filter)(below 18 GHz)) - Gain(Amplifier) + Distance factor

Distance factor : 1 GHz - 10 GHz : 20log (3.80 m / 3.0 m) = 2.06 dB

10 GHz - 40 GHz : 20log (1.0 m / 3.0 m) = -9.54 dB

\*These results have sufficient margin without taking account Duty cycle correction factor.

**Radiated Spurious Emission**  
**(Reference Plot for band-edge)**  
**(Test model number: DNNS124)**

Report No. 14071795S-A-R1  
Test place Shonan EMC Lab.  
Semi Anechoic Chamber 3  
Date August 6, 2021  
Temperature / Humidity 20 deg.C, 53 %RH  
Engineer Shiro Kobayashi  
( 1 GHz -2.8 GHz )  
Mode Tx, Hopping Off, DH5 2480 MHz

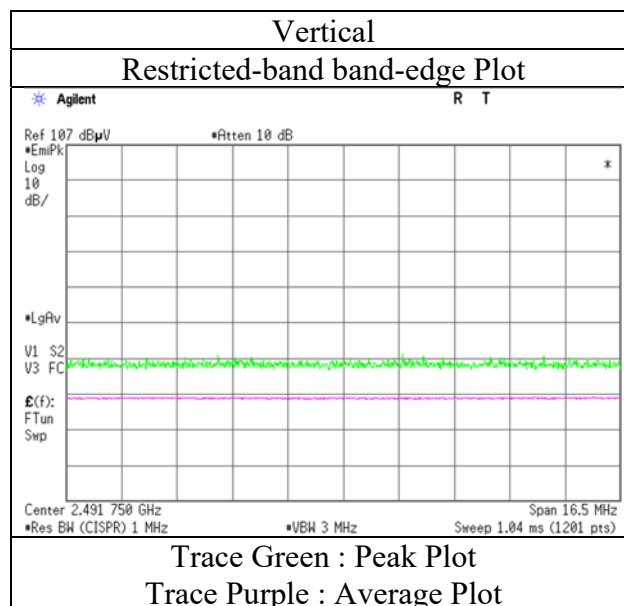
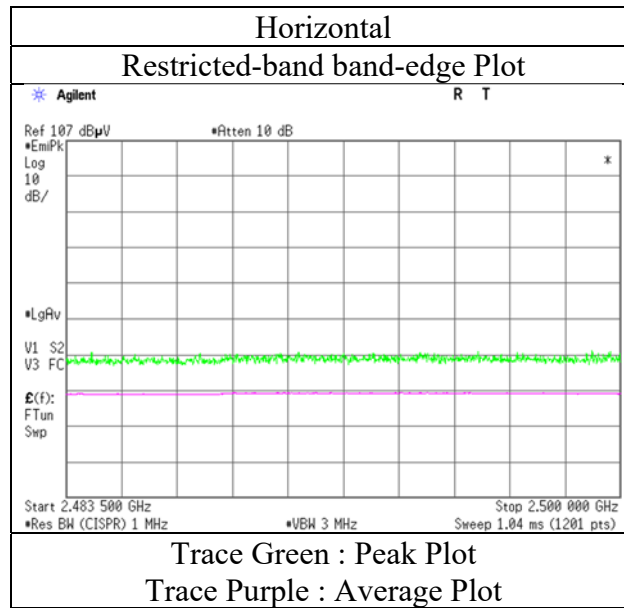

\* The measurement was conducted for a sufficiently long enough time to detect any possible spurious emissions. Final result of restricted band edge was shown in tabular data.

**Radiated Spurious Emission**  
(Test model number: DNNS124)

Report No. 14071795S-A-R1  
Test place Shonan EMC Lab.  
Semi Anechoic Chamber 3 3  
Date August 10, 2021 August 6, 2021 August 10, 2021  
Temperature / Humidity 20 deg.C, 51 %RH 20 deg.C, 53 %RH 23 deg.C, 60 %RH  
Engineer Yasumasa Owaki Shiro Kobayashi Takahiro Kawakami  
( 30 MHz -1 GHz ) ( 1 GHz -10 GHz ) ( 10 GHz -26.5 GHz )  
Mode Tx, Hopping Off, 3DH5 2402 MHz

(\* PK: Peak, AV: Average, QP: Quasi-Peak)

Polarity	Frequency [MHz]	Detector	Reading [dBuV]	Ant.Fac. [dB/m]	Loss [dB]	Gain [dB]	Distance Factor [dB]	Result [dBuV/m]	Limit [dBuV/m]	Margin [dB]	Height [cm]	Angle [deg]	Remark
Hori.	287.795	QP	41.00	13.56	8.51	31.98	0.00	31.09	46.0	14.9	152	320	-
Hori.	308.900	QP	42.20	13.86	8.62	31.97	0.00	32.71	46.0	13.2	111	221	-
Hori.	334.910	QP	39.30	14.85	8.75	31.94	0.00	30.96	46.0	15.0	100	5	-
Hori.	363.935	QP	40.80	15.28	8.89	31.93	0.00	33.04	46.0	12.9	100	300	-
Hori.	599.855	QP	35.50	19.42	9.89	31.90	0.00	32.91	46.0	13.0	172	156	-
Hori.	2390.000	PK	47.84	28.33	14.43	41.62	2.06	51.04	73.9	22.8	155	233	-
Hori.	4804.000	PK	47.96	31.77	7.02	42.89	2.06	45.92	73.9	27.9	150	0	-
Hori.	7206.000	PK	48.41	37.37	8.49	43.39	2.06	52.94	73.9	20.9	150	0	-
Hori.	2390.000	AV	36.11	28.33	14.43	41.62	2.06	39.31	53.9	14.5	155	233	VBW: 360 Hz
Hori.	4804.000	AV	36.94	31.77	7.02	42.89	2.06	34.90	53.9	19.0	150	0	VBW: 360 Hz
Hori.	7206.000	AV	36.75	37.37	8.49	43.39	2.06	41.28	53.9	12.6	150	0	VBW: 360 Hz
Vert.	51.495	QP	41.60	10.68	6.77	32.17	0.00	26.88	40.0	13.1	100	247	-
Vert.	57.205	QP	45.20	8.92	6.65	32.16	0.00	28.61	40.0	11.3	100	220	-
Vert.	67.035	QP	47.00	6.97	6.60	32.16	0.00	28.41	40.0	11.5	100	234	-
Vert.	208.075	QP	42.30	11.44	8.06	32.04	0.00	29.76	43.5	13.7	100	163	-
Vert.	211.650	QP	43.40	11.20	8.08	32.03	0.00	30.65	43.5	12.8	100	174	-
Vert.	599.855	QP	33.70	19.42	9.89	31.90	0.00	31.11	46.0	14.8	100	175	-
Vert.	2390.000	PK	47.78	28.33	14.43	41.62	2.06	50.98	73.9	22.9	107	328	-
Vert.	4804.000	PK	47.68	31.77	7.02	42.89	2.06	45.64	73.9	28.2	150	0	-
Vert.	5192.107	PK	51.75	32.30	7.28	43.09	2.06	50.30	73.9	23.6	102	28	-
Vert.	7206.000	PK	48.16	37.37	8.49	43.39	2.06	52.69	73.9	21.2	150	0	-
Vert.	2390.000	AV	36.09	28.33	14.43	41.62	2.06	39.29	53.9	14.6	107	328	VBW: 360 Hz
Vert.	4804.000	AV	37.18	31.77	7.02	42.89	2.06	35.14	53.9	18.7	150	0	VBW: 360 Hz
Vert.	5192.107	AV	37.81	32.30	7.28	43.09	2.06	36.36	53.9	17.5	102	28	VBW: 10 Hz
Vert.	7206.000	AV	36.86	37.37	8.49	43.39	2.06	41.39	53.9	12.5	150	0	VBW: 360 Hz

Result = Reading + Ant.Fac. + Loss (Cable+(Attenuator or Filter)(below 18 GHz)) - Gain(Amplifier) + Distance factor

Distance factor : 1 GHz - 10 GHz : 20log(3.80 m / 3.0 m) = 2.06 dB

10 GHz - 40 GHz : 20log(1.0 m / 3.0 m) = -9.54 dB

\*These results have sufficient margin without taking account Duty cycle correction factor.

**20 dBc Data Sheet (RBW 100 kHz, VBW 300 kHz)**

Polarity	Frequency [MHz]	Detector	Reading [dBuV]	Ant.Fac. [dB/m]	Loss [dB]	Gain [dB]	Distance Factor [dB]	Result [dBuV/m]	Limit [dBuV/m]	Margin [dB]	Remark
Hori.	2402.000	PK	88.18	28.31	14.45	41.63	2.06	91.37	-	-	Carrier
Hori.	2400.000	PK	39.54	28.31	14.45	41.63	2.06	42.73	71.3	28.5	-
Vert.	2402.000	PK	84.30	28.31	14.45	41.63	2.06	87.49	-	-	Carrier
Vert.	2400.000	PK	39.34	28.31	14.45	41.63	2.06	42.53	67.4	24.8	-

Result = Reading + Ant.Fac. + Loss (Cable+(Attenuator or Filter)(below 18 GHz)) - Gain(Amplifier) + Distance factor

Distance factor : 1 GHz - 10 GHz : 20log(3.80 m / 3.0 m) = 2.06 dB

10 GHz - 40 GHz : 20log(1.0 m / 3.0 m) = -9.54 dB

**UL Japan, Inc.**

**Shonan EMC Lab.**

1-22-3 Megumigaoka, Hiratsuka-shi, Kanagawa-ken, 259-1220 JAPAN

Telephone : +81 463 50 6400

Facsimile : +81 463 50 6401

**Radiated Spurious Emission**  
**(Reference Plot for band-edge)**  
**(Test model number: DNNS124)**

Report No. 14071795S-A-R1  
Test place Shonan EMC Lab.  
Semi Anechoic Chamber 3  
Date August 6, 2021  
Temperature / Humidity 20 deg.C, 53 %RH  
Engineer Shiro Kobayashi  
( 1 GHz -10 GHz )  
Mode Tx, Hopping Off, 3DH5 2402 MHz

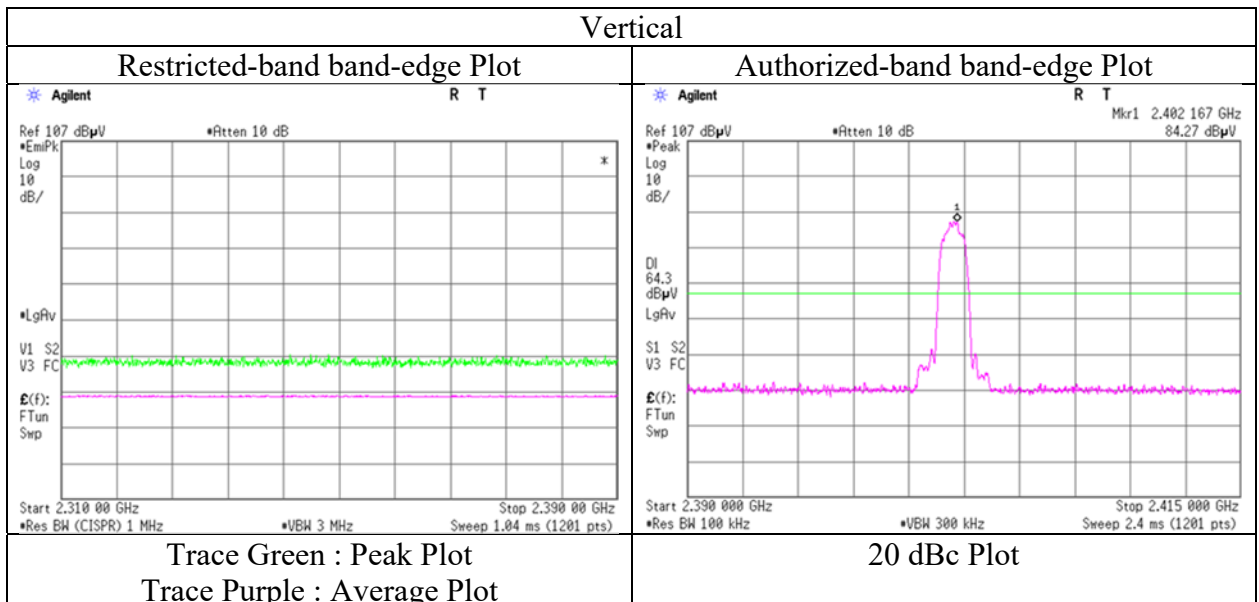
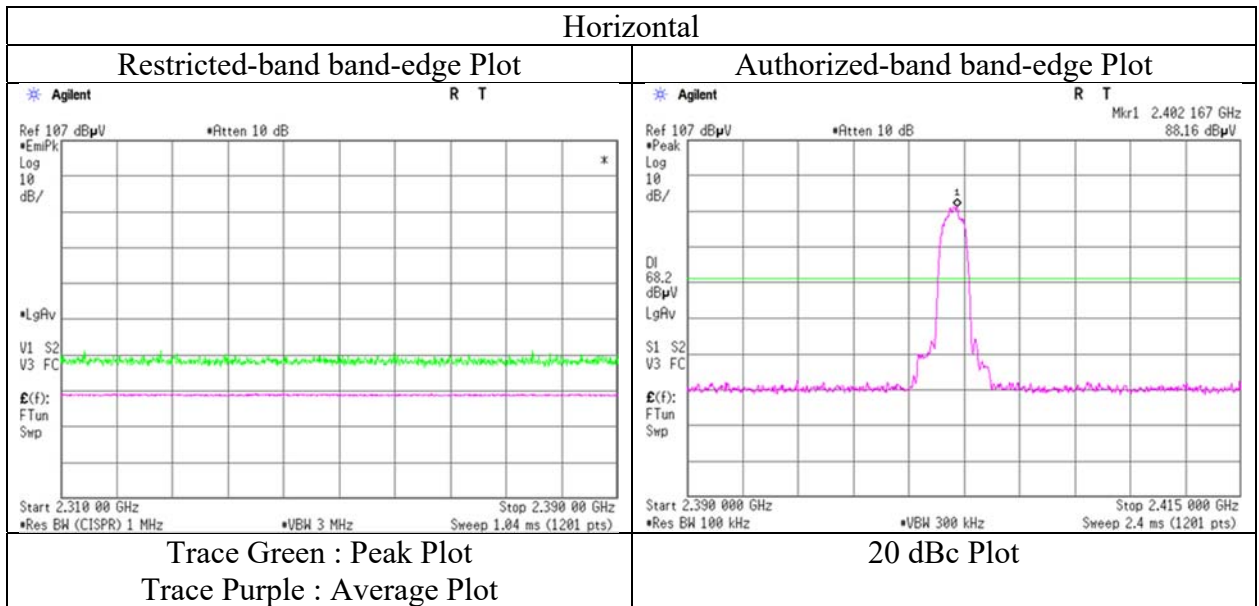

\* The measurement was conducted for a sufficiently long enough time to detect any possible spurious emissions. Final result of restricted band edge was shown in tabular data.

**Radiated Spurious Emission**  
(Test model number: DNNS124)

Report No. 14071795S-A-R1  
Test place Shonan EMC Lab.  
Semi Anechoic Chamber 3 3  
Date August 10, 2021 August 6, 2021 August 10, 2021  
Temperature / Humidity 20 deg.C, 51 %RH 20 deg.C, 53 %RH 23 deg.C, 60 %RH  
Engineer Yasumasa Owaki Shiro Kobayashi Takahiro Kawakami  
( 30 MHz -1 GHz ) ( 1 GHz -10 GHz ) ( 10 GHz -26.5 GHz )  
Mode Tx, Hopping Off, 3DH5 2441 MHz

(\* PK: Peak, AV: Average, QP: Quasi-Peak)

Polarity	Frequency [MHz]	Detector	Reading [dBuV]	Ant.Fac. [dB/m]	Loss [dB]	Gain [dB]	Distance Factor [dB]	Result [dBuV/m]	Limit [dBuV/m]	Margin [dB]	Height [cm]	Angle [deg]	Remark
Hori.	287.825	QP	40.80	13.56	8.51	31.98	0.00	30.89	46.0	15.1	147	319	-
Hori.	308.775	QP	41.70	13.86	8.62	31.97	0.00	32.21	46.0	13.7	129	224	-
Hori.	326.800	QP	39.20	14.54	8.71	31.95	0.00	30.50	46.0	15.5	100	359	-
Hori.	363.805	QP	41.00	15.28	8.89	31.93	0.00	33.24	46.0	12.7	100	300	-
Hori.	369.135	QP	39.50	15.26	8.91	31.93	0.00	31.74	46.0	14.2	100	301	-
Hori.	599.855	QP	35.30	19.42	9.89	31.90	0.00	32.71	46.0	13.2	177	155	-
Hori.	4882.000	PK	47.83	31.87	7.08	42.89	2.06	45.95	73.9	27.9	150	0	-
Hori.	7323.000	PK	47.46	37.54	8.57	43.52	2.06	52.11	73.9	21.7	150	0	-
Hori.	4882.000	AV	36.79	31.87	7.08	42.89	2.06	34.91	53.9	18.9	150	0	VBW: 360 Hz
Hori.	7323.000	AV	36.48	37.54	8.57	43.52	2.06	41.13	53.9	12.7	150	0	VBW: 360 Hz
Vert.	51.890	QP	42.80	10.55	6.77	32.17	0.00	27.95	40.0	12.0	100	239	-
Vert.	57.200	QP	45.80	8.92	6.65	32.16	0.00	29.21	40.0	10.7	100	247	-
Vert.	67.400	QP	46.70	6.91	6.62	32.16	0.00	28.07	40.0	11.9	100	233	-
Vert.	207.635	QP	43.00	11.45	8.05	32.04	0.00	30.46	43.5	13.0	100	163	-
Vert.	599.855	QP	33.70	19.42	9.89	31.90	0.00	31.11	46.0	14.8	100	178	-
Vert.	4882.000	PK	47.69	31.87	7.08	42.89	2.06	45.81	73.9	28.0	150	0	-
Vert.	7323.000	PK	47.43	37.54	8.57	43.52	2.06	52.08	73.9	21.8	150	0	-
Vert.	4882.000	AV	36.81	31.87	7.08	42.89	2.06	34.93	53.9	18.9	150	0	VBW: 360 Hz
Vert.	7323.000	AV	36.56	37.54	8.57	43.52	2.06	41.21	53.9	12.6	150	0	VBW: 360 Hz

Result = Reading + Ant.Fac. + Loss (Cable+(Attenuator or Filter)(below 18 GHz)) - Gain(Amplifier) + Distance factor

Distance factor : 1 GHz - 10 GHz : 20log(3.80 m / 3.0 m) = 2.06 dB

10 GHz - 40 GHz : 20log(1.0 m / 3.0 m) = -9.54 dB

\*These results have sufficient margin without taking account Duty cycle correction factor.

**Radiated Spurious Emission**  
(Test model number: DNNS124)

Report No. 14071795S-A-R1  
Test place Shonan EMC Lab.  
Semi Anechoic Chamber 3  
Date August 6, 2021  
Temperature / Humidity 20 deg.C, 53 %RH  
Engineer Shiro Kobayashi  
( 1 GHz -2.8 GHz )  
Mode Tx, Hopping Off, 3DH5 2480 MHz

(\* PK: Peak, AV: Average, QP: Quasi-Peak)

Polarity	Frequency [MHz]	Detector	Reading [dBuV]	Ant.Fac. [dB/m]	Loss [dB]	Gain [dB]	Distance Factor [dB]	Result [dBuV/m]	Limit [dBuV/m]	Margin [dB]	Height [cm]	Angle [deg]	Remark
Hori.	2483.500	PK	47.10	28.24	14.53	41.65	2.06	50.28	73.9	23.6	182	277	-
Hori.	2483.500	AV	36.25	28.24	14.53	41.65	2.06	39.43	53.9	14.4	182	277	VBW: 360 Hz
Vert.	2483.500	PK	46.97	28.24	14.53	41.65	2.06	50.15	73.9	23.7	124	26	-
Vert.	2483.500	AV	36.33	28.24	14.53	41.65	2.06	39.51	53.9	<b>14.3</b>	124	26	VBW: 360 Hz

Result = Reading + Ant.Fac. + Loss (Cable+(Attenuator or Filter)(below 18 GHz)) - Gain(Amplifier) + Distance factor

Distance factor : 1 GHz - 10 GHz : 20log(3.80 m / 3.0 m) = 2.06 dB

10 GHz - 40 GHz : 20log(1.0 m / 3.0 m) = -9.54 dB

\*These results have sufficient margin without taking account Duty cycle correction factor.

**Radiated Spurious Emission**  
**(Reference Plot for band-edge)**  
**(Test model number: DNNS124)**

Report No. 14071795S-A-R1  
Test place Shonan EMC Lab.  
Semi Anechoic Chamber 3  
Date August 6, 2021  
Temperature / Humidity 20 deg.C, 53 %RH  
Engineer Shiro Kobayashi  
( 1 GHz -2.8 GHz )  
Mode Tx, Hopping Off, 3DH5 2480 MHz

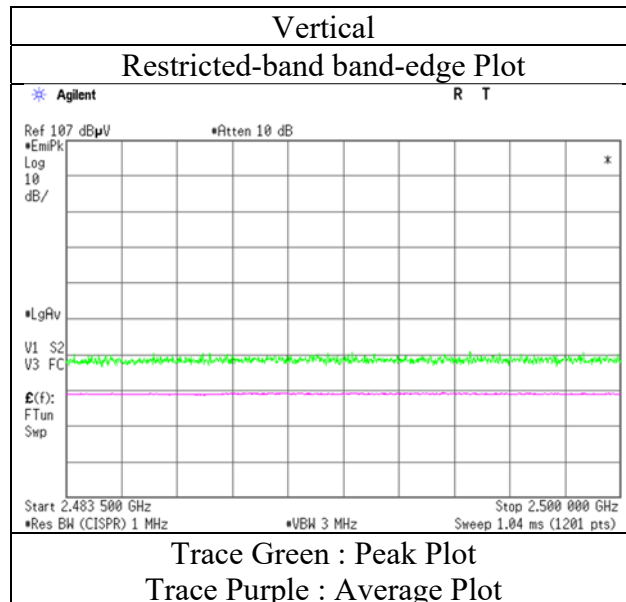
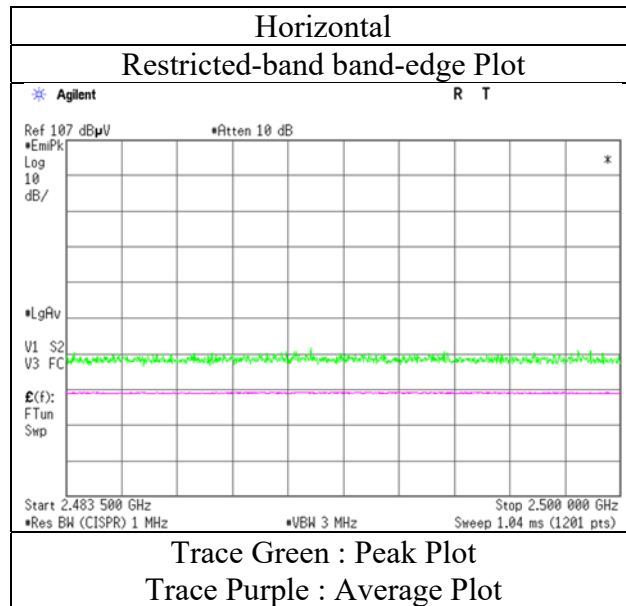

\* The measurement was conducted for a sufficiently long enough time to detect any possible spurious emissions. Final result of restricted band edge was shown in tabular data.

**Radiated Spurious Emission**  
**(Plot data, Worst case)**  
 (Test model number: DNNS124)

Report No.	14071795S-A-R1		
Test place	Shonan EMC Lab.		
Semi Anechoic Chamber	3	3	3
Date	August 10, 2021	August 6, 2021	August 10, 2021
Temperature / Humidity	20 deg.C, 51 %RH	20 deg.C, 53 %RH	23 deg.C, 60 %RH
Engineer	Yasumasa Owaki ( 30 MHz -1 GHz )	Shiro Kobayashi ( 1 GHz -10 GHz )	Takahiro Kawakami ( 10 GHz -26.5 GHz )
Mode	Tx, Hopping Off, 3DH5 2441 MHz		

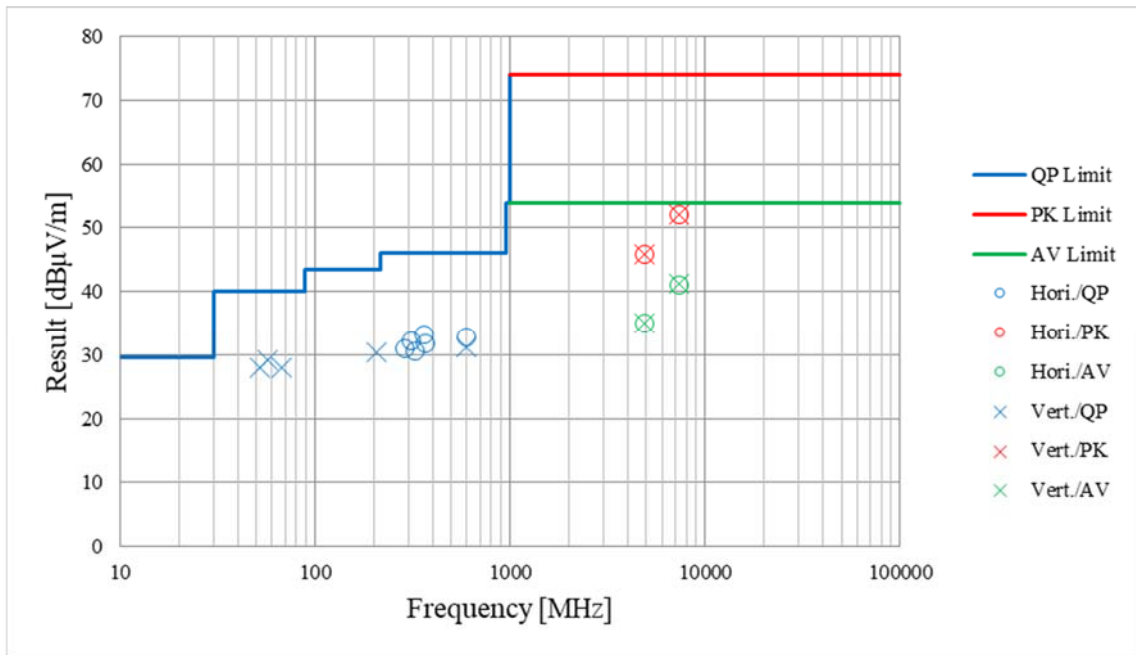

\*These plots data contains sufficient number to show the trend of characteristic features for EUT.



**Conducted Spurious Emission**  
 (Test model number: DNNS122)

Report No. 14071795S-A-R1  
 Test place Shonan EMC Lab. No.5 Shielded Room  
 Date February 9, 2021  
 Temperature / Humidity 22 deg. C / 35 % RH  
 Engineer Yosuke Murakami  
 Mode Tx, Hopping Off, DH5

**2402 MHz**

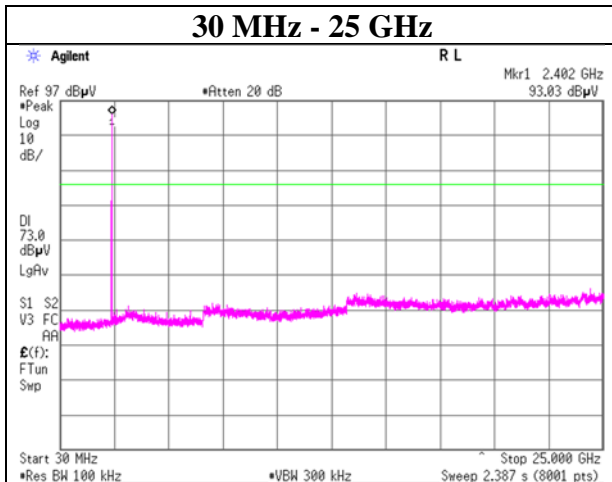
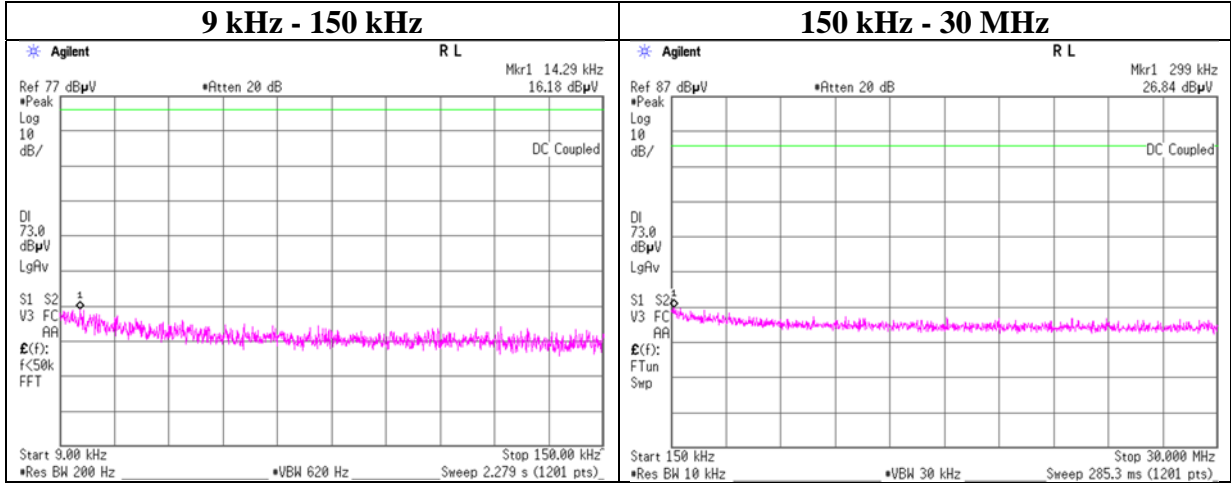

**Conducted Spurious Emission**  
 (Test model number: DNNS122)

Report No.	14071795S-A-R1
Test place	Shonan EMC Lab. No.5 Shielded Room
Date	February 9, 2021
Temperature / Humidity	22 deg. C / 35 % RH
Engineer	Yosuke Murakami
Mode	Tx, Hopping Off, DH5

**2441 MHz**

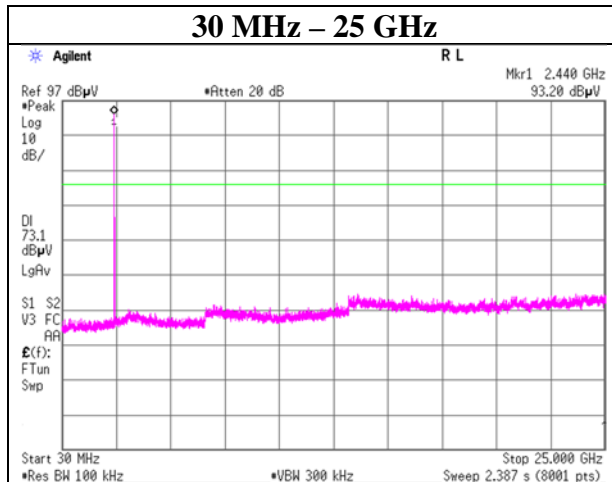
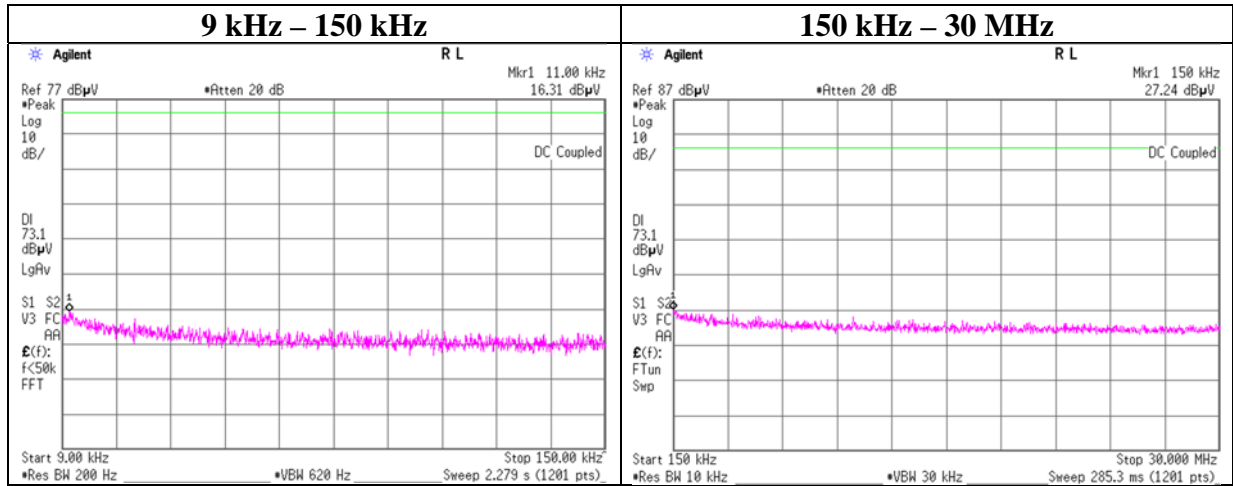

**Conducted Spurious Emission**  
 (Test model number: DNNS122)

Report No.	14071795S-A-R1
Test place	Shonan EMC Lab. No.5 Shielded Room
Date	February 9, 2021
Temperature / Humidity	22 deg. C / 35 % RH
Engineer	Yosuke Murakami
Mode	Tx, Hopping Off, DH5

**2480 MHz**

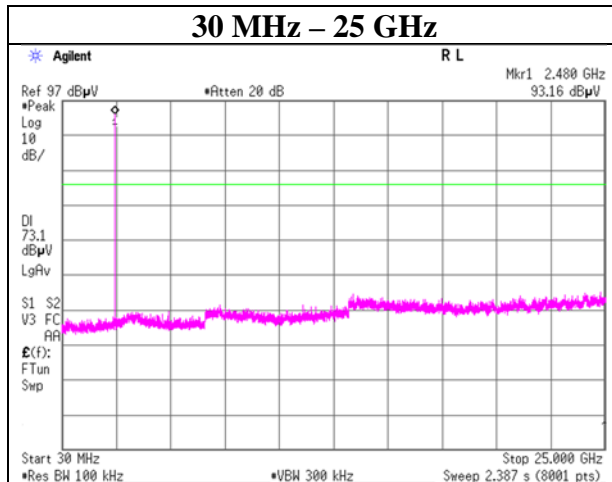
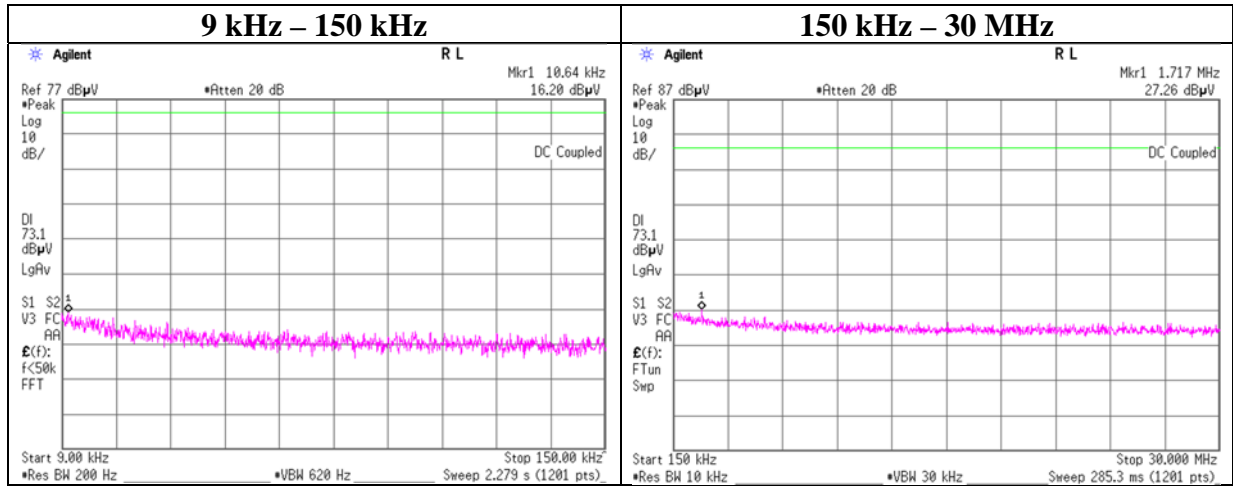

**Conducted Spurious Emission**  
(Test model number: DNNS122)

Report No. 14071795S-A-R1  
Test place Shonan EMC Lab. No.5 Shielded Room  
Date February 9, 2021  
Temperature / Humidity 22 deg. C / 35 % RH  
Engineer Yosuke Murakami  
Mode Tx, Hopping Off, 3DH5

**2402 MHz**

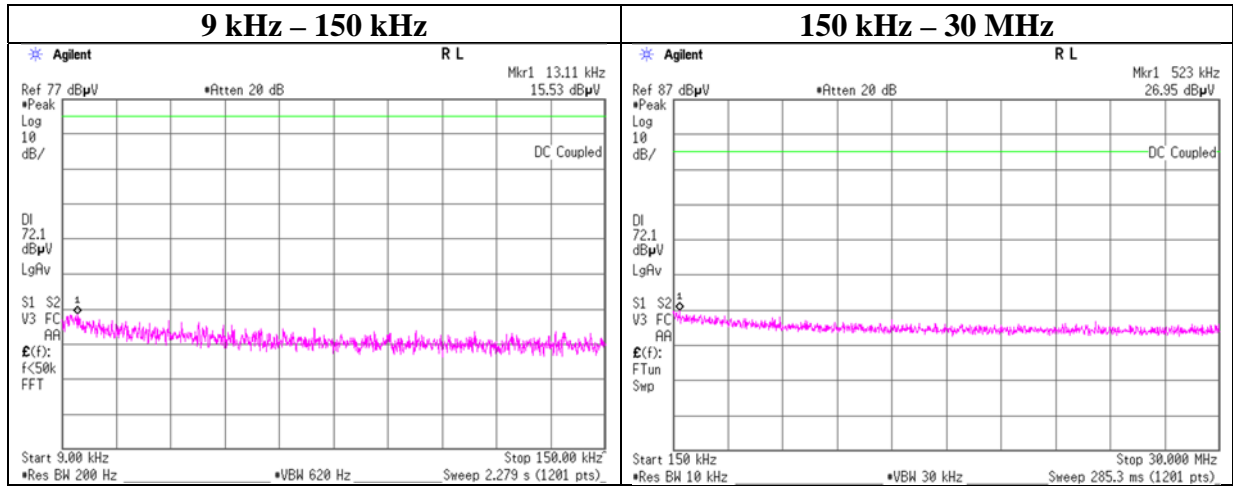

**30 MHz - 25 GHz**

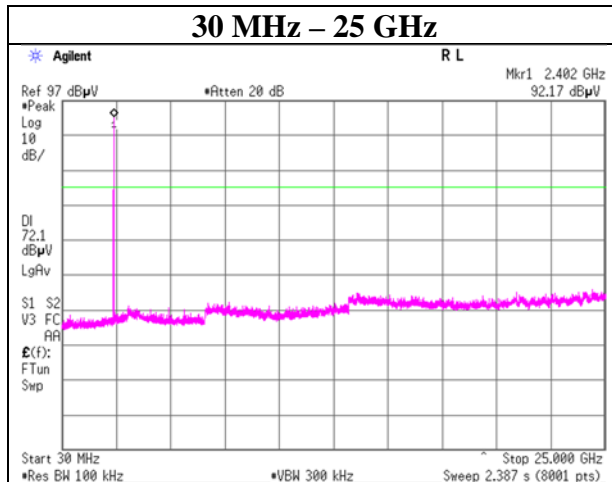

**Conducted Spurious Emission**  
 (Test model number: DNNS122)

Report No.	14071795S-A-R1
Test place	Shonan EMC Lab. No.5 Shielded Room
Date	February 9, 2021
Temperature / Humidity	22 deg. C / 35 % RH
Engineer	Yosuke Murakami
Mode	Tx, Hopping Off, 3DH5

**2441 MHz**

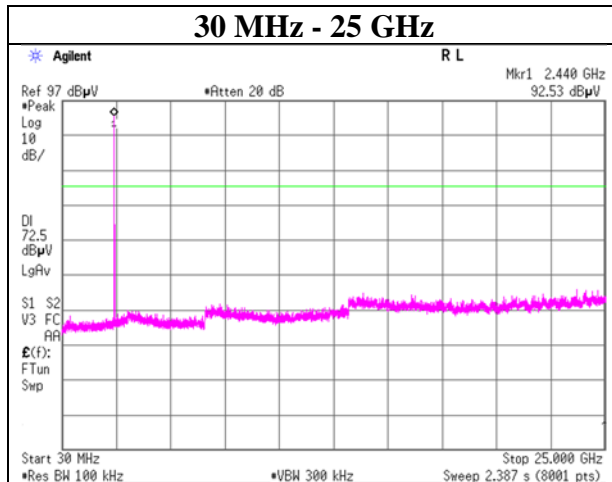
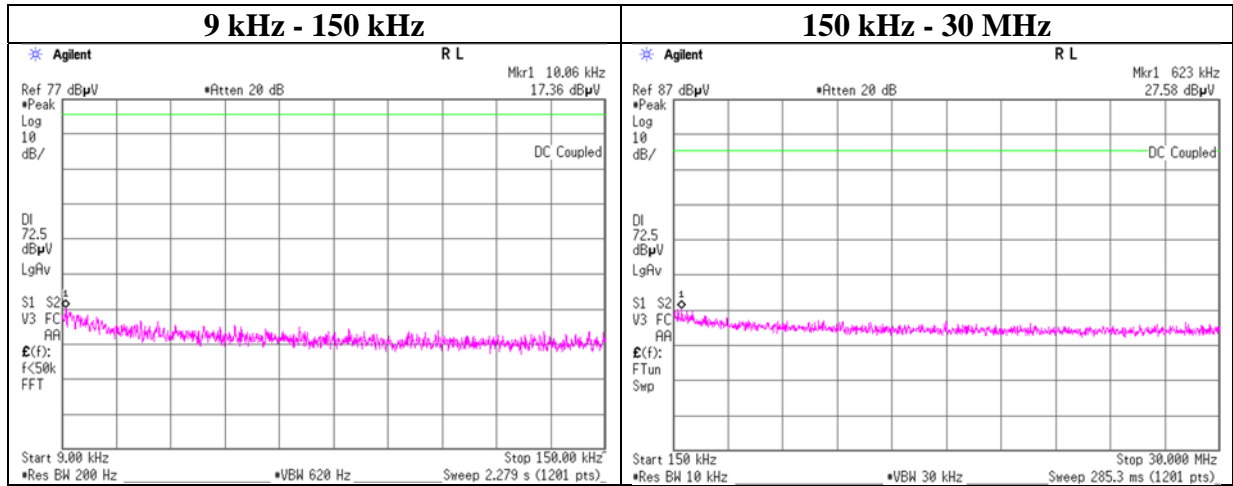

**Conducted Spurious Emission**  
 (Test model number: DNNS122)

Report No. 14071795S-A-R1  
 Test place Shonan EMC Lab. No.5 Shielded Room  
 Date February 9, 2021  
 Temperature / Humidity 22 deg. C / 35 % RH  
 Engineer Yosuke Murakami  
 Mode Tx, Hopping Off, 3DH5

**2480 MHz**

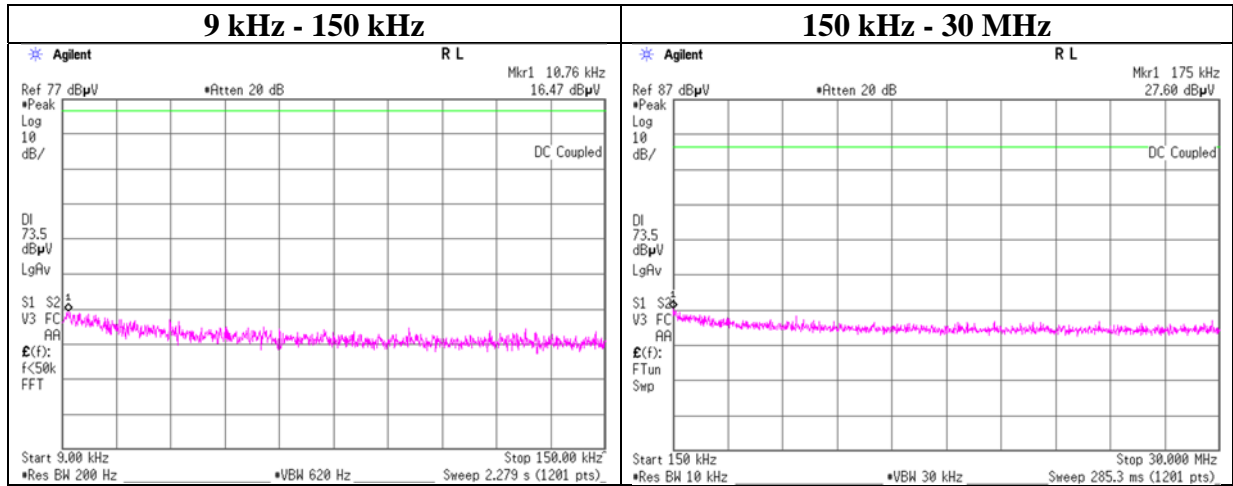

**30 MHz - 25 GHz**

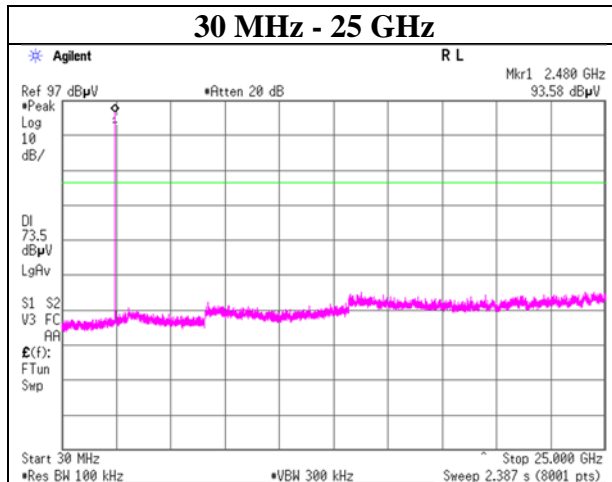

**Conducted Emission Band Edge compliance**  
 (Test model number: DNNS122)

Report No. 14071795S-A-R1  
 Test place Shonan EMC Lab. No.5 Shielded Room  
 Date February 9, 2021  
 Temperature / Humidity 22 deg. C / 35 % RH  
 Engineer Yosuke Murakami  
 Mode Tx DH5

**Hopping On**

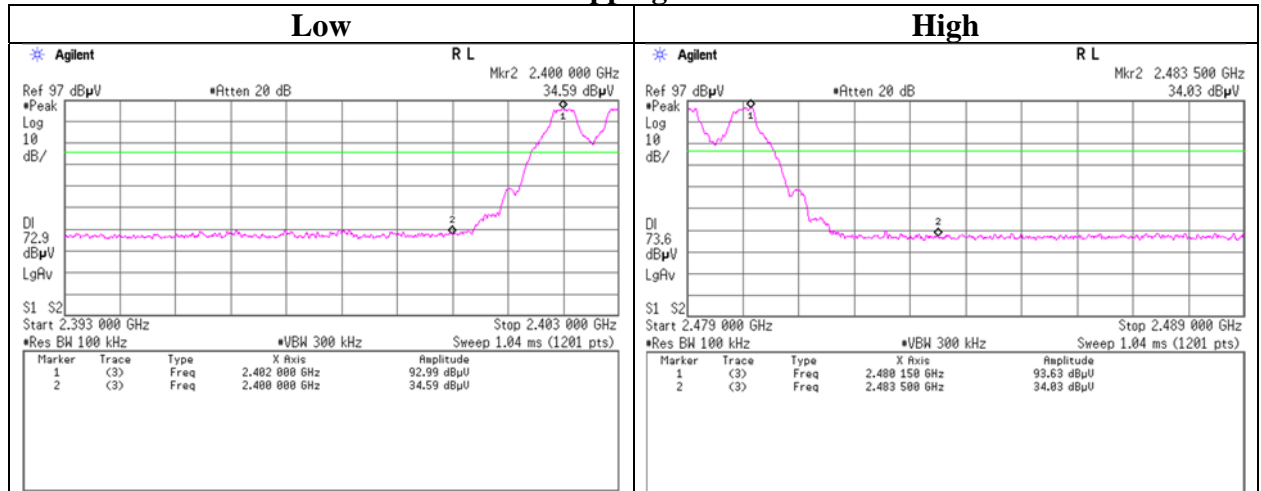

**Hopping Off**

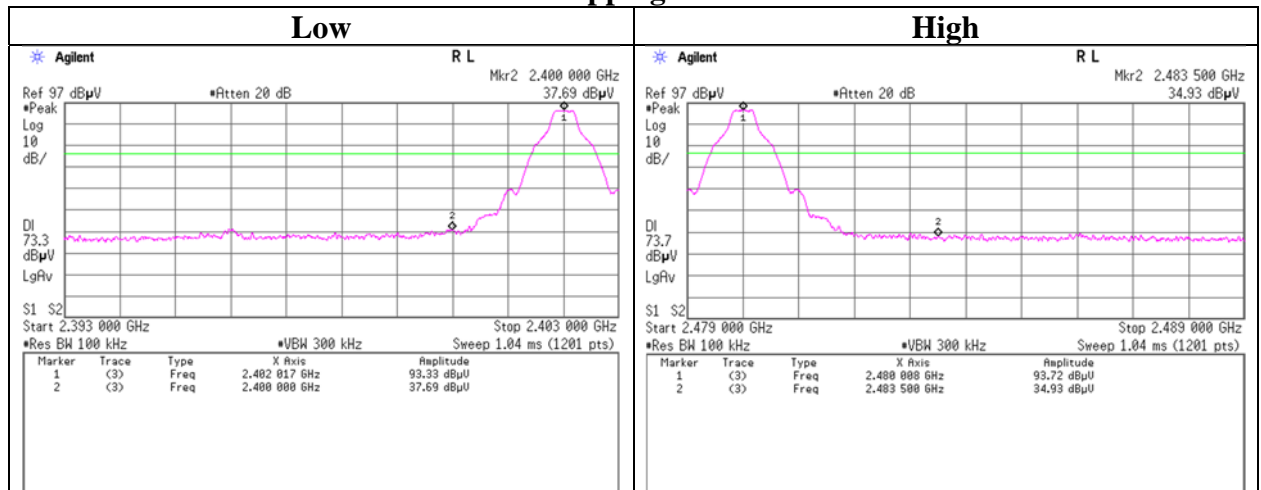

**Conducted Emission Band Edge compliance**  
 (Test model number: DNNS122)

Report No. 14071795S-A-R1  
 Test place Shonan EMC Lab. No.5 Shielded Room  
 Date February 9, 2021  
 Temperature / Humidity 22 deg. C / 35 % RH  
 Engineer Yosuke Murakami  
 Mode Tx 3DH5

**Hopping On**

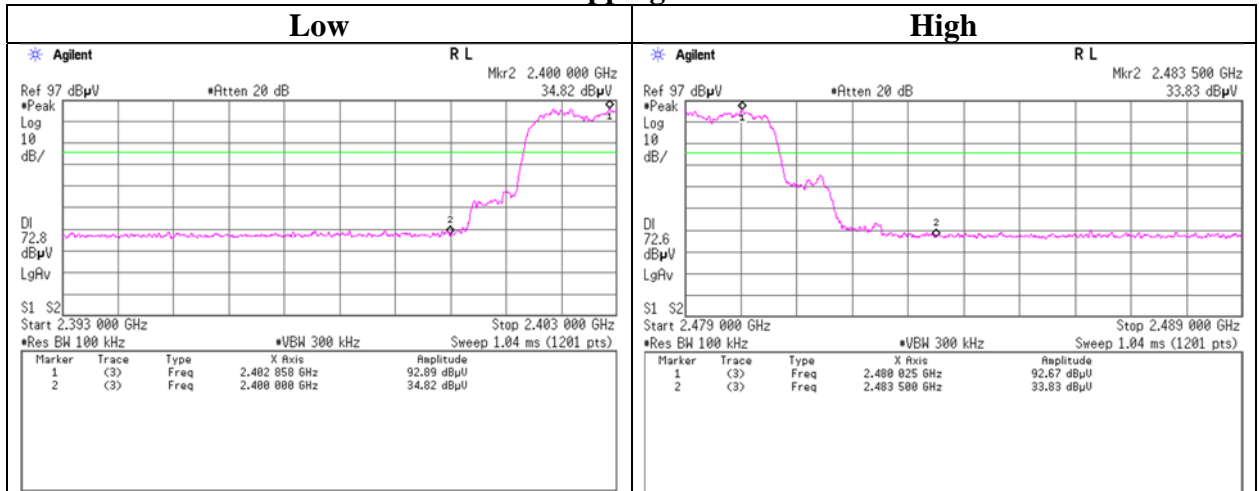

**Hopping Off**

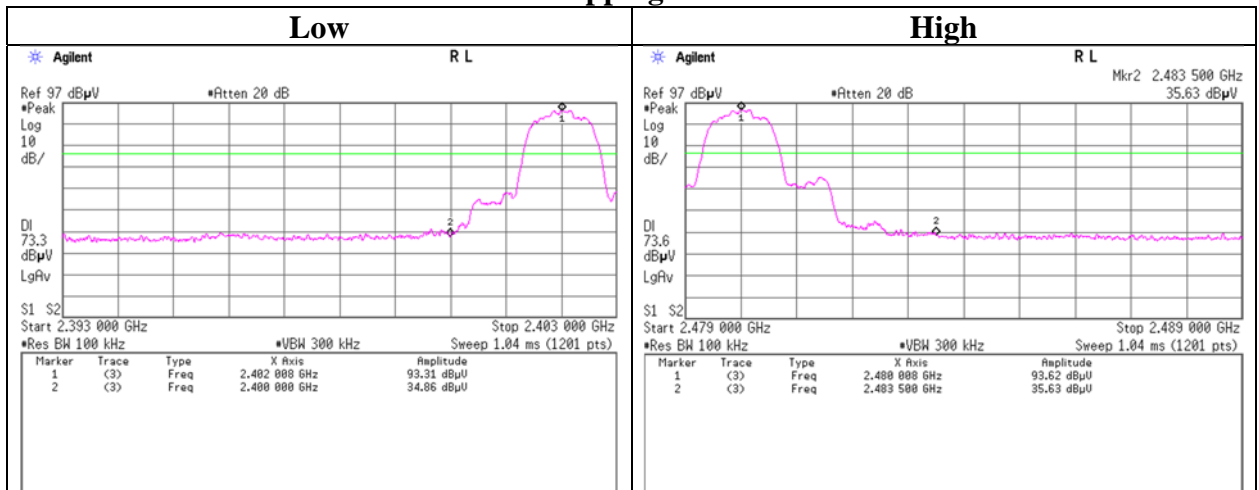



## APPENDIX 2: Test instruments

Used on February 8 to 11, 2021 (DNNS122)

Test Item	Local ID	LIMS ID	Description	Manufacturer	Model	Serial	Last Calibration Date	Cal Int
AT	KTS-07	145111	Digital Tester	SANWA	PC500	7019232	2020/10/21	12
AT	SAT10-16	160494	Attenuator	Weinschel Corp.	54A-10	83420	2020/12/21	12
AT	SCC-G63	196946	Coaxial Cable	Huber+Suhner	SUCOFLEX 102	803411/2	2020/03/10	12
AT	SOS-27	191845	Humidity Indicator	CUSTOM. Inc	CTH-201	-	2020/09/29	12
AT	SPM-07	146247	Power Meter	Keysight Technologies Inc	8990B	MY5100272	2020/05/27	12
AT	SPSS-04	146310	Power sensor	Keysight Technologies Inc	N1923A	MY5326009	2020/05/27	12
AT	KSA-08	145089	Spectrum Analyzer	Keysight Technologies Inc	E4446A	MY46180525	2020/11/24	12
AT	STM-G10	171617	Terminator	Weinschel - API Technologies Corp	M1459A	92420	2020/06/03	12
RE	COTS-SEMI-5	170932	EMI Software	TSJ (Techno Science Japan)	TEPTO-DV3(RE,CE,ME,PE)	-	-	-
RE	KAT6-04	144899	Attenuator	Inmet	18N-6dB	-	2020/12/10	12
RE	KJM-09	145929	Measure	KOMELON	KMC-36	-	-	-
RE	SAEC-01(NSA)	145597	Semi-Anechoic Chamber	TDK	SAEC-01(NSA)	1	2020/04/08	12
RE	SAEC-01(SVSWR)	145561	Semi-Anechoic Chamber	TDK	SAEC-01(SVSWR)	1	2020/05/04	12
RE	SAF-01	145003	Pre Amplifier	SONOMA	310N	290211	2020/02/19	12
RE	SAF-04	145127	Pre Amplifier	Toyo Corporation	TPA0118-36	2072554	2020/06/02	12
RE	SAF-08	145007	Pre Amplifier	Toyo Corporation	HAP18-26W	19	2020/03/03	12
RE	SAT10-05	145136	Attenuator	Keysight Technologies Inc	8493C-010	74864	2020/10/05	12
RE	SAT3-09	144959	Attenuator	JFW	50HF-003N	-	2020/08/18	12
RE	SBA-01	145161	Biconical Antenna	Schwarzbeck Mess - Elektronik	BBA9106	91032664	2020/04/04	12
RE	SCC-A1/A3/A5/A7/A8/A13/SRSE-01	144967	Coaxial Cable&RF Selector	Fujikura/Fujikura/Suhner/Suhner/Suhner/Suhner/TOYO	8D2W/12DSFA/141PE/141PE/141PE/141PE/NS4906	-/0901-269(RF Selector)	2020/04/12	12
RE	SCC-A2/A4/A6/A7/A8/A13/SRSE-01	144968	Coaxial Cable&RF Selector	Fujikura/Fujikura/Suhner/Suhner/Suhner/Suhner/TOYO	8D2W/12DSFA/141PE/141PE/141PE/141PE/NS4906	-/0901-269(RF Selector)	2020/04/12	12
RE	SCC-G05	145039	Coaxial Cable	Junkosha	J12J102207-00	APR-30-15-037	2021/01/26	12
RE	SCC-G19	145178	Coaxial Cable	Suhner	SUCOFLEX 102A	1188/2A	2020/03/04	12
RE	SCC-G40	166491	Coaxial Cable	Junkosha	MWX221-01000NFSNMS/B	1612S005	2021/01/19	12
RE	SCC-G62	196985	Coaxial Cable	Huber+Suhner	SUCOFLEX 102	803650/2	2020/03/10	12
RE	SCC-G68	200008	Coaxial Cable	Huber+Suhner	SUCOFLEX 104	575616/4	2020/07/07	12
RE	SFL-02	145301	Highpass Filter	MICRO-TRONICS	HPM50111	51	2020/10/05	12
RE	SHA-01	145383	Horn Antenna	Schwarzbeck Mess - Elektronik	BBHA9120D	9120D-725	2020/05/27	12
RE	SHA-04	145512	Horn Antenna	ETS-Lindgren	3160-09	00094868	2020/06/15	12
RE	SHA-08	194683	Horn Antenna	Schwarzbeck Mess - Elektronik	BBHA 9120 C	694	2020/02/17	12
RE	SLA-05	145527	Logperiodic Antenna	Schwarzbeck Mess - Elektronik	VUSLP9111B	193	2020/04/04	12
RE	SOS-20	191837	Humidity Indicator	CUSTOM. Inc	CTH-201	-	2020/09/28	12
RE	SSA-03	145801	Spectrum Analyzer	Keysight Technologies Inc	E4448A	MY48250152	2020/08/12	12
RE	STR-01	145790	Test Receiver	Rohde & Schwarz	ESU40	100093	2020/04/24	12
RE	STS-01	145792	Digital Hitester	HIOKI E.E. CORPORATION	3805-50	80997812	2020/10/19	12

UL Japan, Inc.

Shonan EMC Lab.

1-22-3 Megumigaoka, Hiratsuka-shi, Kanagawa-ken, 259-1220 JAPAN

Telephone : +81 463 50 6400

Facsimile : +81 463 50 6401

Used on August 6 to 12, 2021 (DNNS124) 1/2

Test Item	Local ID	LIMS ID	Description	Manufacturer	Model	Serial	Last Calibration Date	Cal Int
AT	SAT10-22	204926	Attenuator	Weinschel Corp.	54A-10	-	2021/02/09	12
AT	SCC-G67	196949	Coaxial Cable	Huber+Suhner	SUCOFLEX 102	803480/2	2021/03/01	12
AT	SOS-24	191841	Humidity Indicator	CUSTOM. Inc	CTH-201	-	2020/10/01	12
AT	SPM-13	169910	Power Meter	Keysight Technologies Inc	8990B	MY51000448	2021/01/25	12
AT	SPSS-07	169912	Power sensor	Keysight Technologies Inc	N1923A	MY57290005	2021/01/25	12
AT,RE	STS-03	146210	Digital Hitester	HIOKI E.E. CORPORATION	3805-50	80997823	2020/10/19	12
RE	COTS-SEMI-5	170932	EMI Software	TSJ (Techno Science Japan)	TEPTO-DV3(RE,CE,ME,PE)	-	-	-
RE	KJM-02	146432	Measure	TAJIMA	GL19-55	-	-	-
RE	SAEC-03(NSA)	145565	Semi-Anechoic Chamber	TDK	SAEC-03(NSA)	3	2021/04/27	12
RE	SAEC-03(SVSWR)	145566	Semi-Anechoic Chamber	TDK	SAEC-03(SVSWR)	3	2021/05/21	12
RE	SAF-03	145126	Pre Amplifier	SONOMA	310N	290213	2021/02/10	12
RE	SAF-06	145005	Pre Amplifier	Toyo Corporation	TPA0118-36	1440491	2021/02/08	12
RE	SAF-08	145007	Pre Amplifier	Toyo Corporation	HAP18-26W	19	2021/03/01	12
RE	SAF-10	145129	Pre Amplifier	Toyo Corporation	HAP26-40W	10	2021/03/01	12

**UL Japan, Inc.**

**Shonan EMC Lab.**

1-22-3 Megumigaoka, Hiratsuka-shi, Kanagawa-ken, 259-1220 JAPAN

Telephone : +81 463 50 6400

Facsimile : +81 463 50 6401

Used on August 6 to 12, 2021 (DNNS124) 2/2

Test Item	Local ID	LIMS ID	Description	Manufacturer	Model	Serial	Last Calibration Date	Cal Int
RE	SAT10-06	145137	Attenuator	Keysight Technologies Inc	8493C-010	74865	2020/10/05	12
RE	SAT6-13	167094	Attenuator	JFW	50HF-006N	-	2021/02/10	12
RE	SBA-03	145023	Biconical Antenna	Schwarzbeck Mess-Elektronik OHG	BBA9106	91032666	2021/05/15	12
RE	SCC-C1/C2/C3/C4/C5/C10/SRSE-03	145171	Coaxial Cable&RF Selector	Fujikura/Fujikura/Suhner/Suhner/Suhner/TOYO	8D2W/12DSFA/141PE/141PE/141PE/NS4906	-/0901-271(RF Selector)	2021/04/12	12
RE	SCC-G15	145176	Coaxial Cable	Suhner	SUCOFLEX 102	32703/2	2021/03/01	12
RE	SCC-G40	166491	Coaxial Cable	Junkosha	MWX221-01000NFSNMS/B	1612S005	2021/01/19	12
RE	SCC-G43	156380	Coaxial Cable	Huber+Suhner	SUCOFLEX_104_E	SN MY 13406/4E	2021/05/17	12
RE	SCC-G57	179540	Coaxial Cable	Huber+Suhner	SUCOFLEX 102	802815/2	2021/05/18	12
RE	SCC-G58	183047	Coaxial Cable	Huber+Suhner	SUCOFLEX 104	800287/4A	2021/05/17	12
RE	SCC-G70	200010	Coaxial Cable	Huber+Suhner	SUCOFLEX 104	575618/4	2021/07/06	12
RE	SFL-02	145301	Highpass Filter	MICRO-TRONICS	HPM50111	51	2020/10/05	12
RE	SHA-03	145501	Horn Antenna	Schwarzbeck Mess-Elektronik OHG	BBHA9120D	9120D-739	2021/06/14	12
RE	SHA-04	145512	Horn Antenna	ETS-Lindgren	3160-09	00094868	2021/06/14	12
RE	SHA-06	145514	Horn Antenna	ETS-Lindgren	3160-10	00092383	2021/06/14	12
RE	SHA-10	194685	Horn Antenna	Schwarzbeck Mess-Elektronik OHG	BBHA 9120 C	711	2021/03/03	12
RE	SLA-07	145529	Logperiodic Antenna	Schwarzbeck Mess-Elektronik OHG	VUSLP9111B	196	2021/05/15	12
RE	SOS-23	191840	Humidity Indicator	CUSTOM. Inc	CTH-201	-	2021/08/02	12
RE	SSA-02	145800	Spectrum Analyzer	Keysight Technologies Inc	E4448A	MY48250106	2021/04/13	12
RE	STR-08	150463	Test Receiver	Rohde & Schwarz	ESW44	101581	2020/12/02	12

\*Hyphens for Last Calibration Date and Cal Int (month) are instruments that Calibration is not required (e.g. software), or instruments checked in advance before use.

The expiration date of the calibration is the end of the expired month.

As for some calibrations performed after the tested dates, those test equipment have been controlled by means of an unbroken chains of calibrations.

All equipment is calibrated with valid calibrations. Each measurement data is traceable to the national or international standards.

Test item: RE: Radiated Emission test  
AT: Antenna Terminal Conducted test