



EMI TEST REPORT

Test Report No. : 13523460H-A

Applicant : **DENSO CORPORATION**
Type of EUT : **Remote Keyless Entry System and TPMS (Receiver)**
Model Number of EUT : **23ABP**
FCC ID : **HYQ23ABP**
Test regulation : **FCC Part 15 Subpart B: 2020**
Test Result : **Complied (Refer to SECTION 3.2)**

1. This test report shall not be reproduced in full or partial, without the written approval of UL Japan, Inc.
2. The results in this report apply only to the sample tested.
3. This sample tested is in compliance with the limits of the above regulation.
4. The test results in this test report are traceable to the national or international standards.
5. This test report must not be used by the customer to claim product certification, approval, or endorsement by the A2LA accreditation body.
6. This test report covers EMC technical requirements. It does not cover administrative issues such as Manual or non-EMC test related Requirements. (if applicable)
7. The all test items in this test report are conducted by UL Japan, Inc. Ise EMC Lab.
8. The opinions and the interpretations to the result of the description in this report are outside scopes where UL Japan has been accredited.
9. The information provided from the customer for this report is identified in SECTION 1.

Date of test: October 8 and 9, 2020

Representative test engineer: T. Nakagawa
Tomohisa Nakagawa
Engineer
Consumer Technology Division

Approved by: M. Imura
Motoya Imura
Leader
Consumer Technology Division



CERTIFICATE 5107.02

- The testing in which "Non-accreditation" is displayed is outside the accreditation scopes in UL Japan.
 There is no testing item of "Non-accreditation".

UL Japan, Inc.
Ise EMC Lab.

4383-326 Asama-cho, Ise-shi, Mie-ken 516-0021 JAPAN
Telephone : +81 596 24 8999
Facsimile : +81 596 24 8124

REVISION HISTORY

Original Test Report No.: 13523460H-A

Revision	Test report No.	Date	Page revised	Contents
- (Original)	13523460H-A	October 20, 2020	-	-

UL Japan, Inc.

Ise EMC Lab.

4383-326 Asama-cho, Ise-shi, Mie-ken 516-0021 JAPAN

Telephone : +81 596 24 8999

Facsimile : +81 596 24 8124

Reference: Abbreviations (Including words undescribed in this report)

AAN	Asymmetric Artificial Network	ILAC	International Laboratory Accreditation Conference
AC	Alternating Current	ISED	Innovation, Science and Economic Development Canada
AM	Amplitude Modulation	ISN	Impedance Stabilization Network
AMN	Artificial Mains Network	ISO	International Organization for Standardization
Amp, AMP	Amplifier	JAB	Japan Accreditation Board
ANSI	American National Standards Institute	LAN	Local Area Network
Ant, ANT	Antenna	LCL	Longitudinal Conversion Loss
AP	Access Point	LIMS	Laboratory Information Management System
ASK	Amplitude Shift Keying	LISN	Line Impedance Stabilization Network
Atten., ATT	Attenuator	MRA	Mutual Recognition Arrangement
AV	Average	N/A	Not Applicable
BPSK	Binary Phase-Shift Keying	NIST	National Institute of Standards and Technology
BR	Bluetooth Basic Rate	NS	No signal detect.
BT	Bluetooth	NSA	Normalized Site Attenuation
BT LE	Bluetooth Low Energy	NVLAP	National Voluntary Laboratory Accreditation Program
BW	BandWidth	OBW	Occupied Band Width
C.F	Correction Factor	OFDM	Orthogonal Frequency Division Multiplexing
Cal Int	Calibration Interval	PK	Peak
CAV	CISPR AV	PLT	long-term flicker severity
CCK	Complementary Code Keying	POHC(A)	Partial Odd Harmonic Current
CDN	Coupling Decoupling Network	Pol., Pola.	Polarization
Ch., CH	Channel	PR-ASK	Phase Reversal ASK
CISPR	Comite International Special des Perturbations Radioelectriques	PST	short-term flicker severity
Corr.	Correction	QAM	Quadrature Amplitude Modulation
CPE	Customer premise equipment	QP	Quasi-Peak
CW	Continuous Wave	QPSK	Quadri-Phase Shift Keying
DBPSK	Differential BPSK	r.m.s., RMS	Root Mean Square
DC	Direct Current	RBW	Resolution Band Width
DET	Detector	RE	Radio Equipment
D-factor	Distance factor	REV	Reverse
Dmax	maximum absolute voltage change during an observation period	RF	Radio Frequency
DQPSK	Differential QPSK	RFID	Radio Frequency Identifier
DSSS	Direct Sequence Spread Spectrum	RSS	Radio Standards Specifications
EDR	Enhanced Data Rate	Rx	Receiving
e.i.r.p., EIRP	Equivalent Isotropically Radiated Power	SINAD	Ratio of (Signal + Noise + Distortion) to (Noise + Distortion)
EM clamp	Electromagnetic clamp	S/N	Signal to Noise ratio
EMC	ElectroMagnetic Compatibility	SA, S/A	Spectrum Analyzer
EMI	ElectroMagnetic Interference	SG	Signal Generator
EMS	ElectroMagnetic Susceptibility	SVSWR	Site-Voltage Standing Wave Ratio
EN	European Norm	THC(A)	Total Harmonic Current
e.r.p., ERP	Effective Radiated Power	THD(%)	Total Harmonic Distortion
EU	European Union	TR	Test Receiver
EUT	Equipment Under Test	Tx	Transmitting
Fac.	Factor	VBW	Video BandWidth
FCC	Federal Communications Commission	Vert.	Vertical
FHSS	Frequency Hopping Spread Spectrum	WLAN	Wireless LAN
FM	Frequency Modulation	xDSL	Generic term for all types of DSL technology (DSL: Digital Subscriber Line)
Freq.	Frequency		
FSK	Frequency Shift Keying		
Fund	Fundamental		
FWD	Forward		
GFSK	Gaussian Frequency-Shift Keying		
GNSS	Global Navigation Satellite System		
GPS	Global Positioning System		
Hori.	Horizontal		
ICES	Interference-Causing Equipment Standard		
I/O	Input/Output		
IEC	International Electrotechnical Commission		
IEEE	Institute of Electrical and Electronics Engineers		
IF	Intermediate Frequency		

UL Japan, Inc.

Ise EMC Lab.

4383-326 Asama-cho, Ise-shi, Mie-ken 516-0021 JAPAN

Telephone : +81 596 24 8999

Facsimile : +81 596 24 8124

CONTENTS **PAGE**

SECTION 1: Customer information5
SECTION 2: Equipment under test (EUT).....5
SECTION 3: Test specification, procedures & results7
SECTION 4: Operation of EUT during testing.....10
SECTION 5: Radiated Emission.....12
APPENDIX 1: Test data14
 Radiated Emission 14
APPENDIX 2: Test instruments20
APPENDIX 3: Photographs of test setup21
 Radiated Emission21
 Worst Case Position (Horizontal: X-axis / Vertical: X-axis).....23

SECTION 1: Customer information

Company Name : DENSO CORPORATION
Address : 1-1, Showa-cho, Kariya-shi, Aichi-ken, 448-8661, Japan
Telephone Number : +81-566-63-7723
Facsimile Number : +81-566-25-4792
Contact Person : KOUJI MURAYAMA

The information provided from the customer is as follows;

- Applicant, Type of EUT, Model Number of EUT, FCC ID on the cover and other relevant pages
- Operating/Test Mode(s) (Mode(s)) on all the relevant pages
- SECTION 1: Customer information
- SECTION 2: Equipment under test (EUT) other than the Receipt Date
- SECTION 4: Operation of EUT during testing

* The laboratory is exempted from liability of any test results affected from the above information in SECTION 2 and 4.

SECTION 2: Equipment under test (EUT)

2.1 Identification of EUT

Type : Remote Keyless Entry System and TPMS (Receiver)
Model Number : 23ABP
Serial Number : Refer to SECTION 4.2
Receipt Date : October 5, 2020
Country of Mass-production : Japan, China, United States of America
Condition of EUT : Engineering prototype
(Not for Sale: This sample is equivalent to mass-produced items.)
Modification : No Modification by the test lab

2.2 Product Description

Model: 23ABP (referred to as the EUT in this report) is a Remote Keyless Entry System and TPMS (Receiver).

23ABP has 6 variations. For details of variations, see “Theory of Operation”.

Feature of EUT:

<RKES mode>

RKE System is mainly used for locking or unlocking the doors of the vehicle. The transmitter sends a radio wave signal, while the button is pushed. The receiver becomes active in response to the signal from the transmitter.

<TPMS mode>

Tire Pressure Monitoring System is used for monitoring and indicating information of air pressure in vehicle's tires. Transmitter sends receiver the data that informs air pressure in vehicle's tire to the receiver. The data also includes the information of temperature, battery voltage and identity code of transmitter. The receiver judges the data, and if the data of air pressure and others is not in a normal condition, the receiver sends signal to a warning lamp. Then, the warning lamp warns drivers.

Type of receiving system	:	Super-heterodyne
Frequency of Operation	:	RKES (CH1): 433.58 MHz RKES (CH2): 434.42 MHz TPMS: 433.90 MHz
Oscillator Frequency	:	30.265 MHz Crystal
Type of Modulation	:	RKES: FSK (F1D) TPMS: FSK (F1D)
Power Supply	:	DC 12.0 V
Antenna Type	:	Internal antenna (Inverse F antenna / Inverse L antenna)
Voltage Controlled Oscillator	:	RKES (CH1): 1733.20 MHz RKES (CH2): 1736.56 MHz TPMS: 1734.48 MHz

- * RKES : Remote Keyless Entry System
- TPMS : Tire Pressure Monitoring System

SECTION 3: Test specification, procedures & results

3.1 Test Specification

Test Specification : FCC Part 15 Subpart B
FCC Part 15 final revised on June 26, 2020 and effective July 27, 2020
Title : FCC 47CFR Part15 Radio Frequency Device
Subpart B Unintentional Radiators

3.2 Procedures and results

Item	Test Procedure	Limits	Deviation	Worst margin	Result	Remarks
Conducted emission	FCC: ANSI C63.4: 2014 7. AC power - line conducted emission measurements	FCC:Part 15 Subpart B 15.107(a)	N/A	N/A	N/A	*1)
	ISED: RSS-Gen 7.1	ISED: RSS-Gen 7.2				
Radiated emission	FCC: ANSI C63.4: 2014 8. Radiated emission measurements	FCC: Part 15 Subpart B 15.109(a)	N/A	21.82 dB 868.280 MHz, Vertical, QP <Mode 2>	Complied a)	-
	ISED: RSS-Gen 7.1	ISED: RSS-Gen 7.3				
Antenna Terminal	FCC: ANSI C63.4: 2014 12. Measurement of unintentional radiators other than ITE	FCC: Part 15 Subpart B 15.111(a)	N/A	N/A	N/A	*2)
	ISED: - RSS-Gen 7.1	ISED: RSS-Gen 7.4				
<p>*Note: UL Japan, Inc's EMI Work Procedure 13-EM-W0420. *1) The test is not applicable since the EUT is not the device that is designed to be connected to the public utility (AC) power line. *2) The receiving antenna (of this EUT) is installed inside the EUT and cannot be removed (permanently attached). Therefore, Radiated emission test was performed.</p> <p>a) Refer to APPENDIX 1 (data of Radiated Emission)</p>						
<p>Symbols: Complied The data of this test item has enough margin, more than the measurement uncertainty. Complied# The data of this test item meets the limits unless the measurement uncertainty is taken into consideration.</p>						

3.3 Addition to standard

No addition, exclusion nor deviation has been made from the standard.

3.4 Uncertainty

There is no applicable rule of uncertainty in this applied standard. Therefore, the results are derived depending on whether or not laboratory uncertainty is applied.

The following uncertainties have been calculated to provide a confidence level of 95 % using a coverage factor $k = 2$.

Radiated emission

Measurement distance	Frequency range	Uncertainty (+/-)	
3 m	30 MHz to 200 MHz	(Horizontal)	4.8 dB
		(Vertical)	5.0 dB
	200 MHz to 1000 MHz	(Horizontal)	5.2 dB
		(Vertical)	6.3 dB
10 m	30 MHz to 200 MHz	(Horizontal)	4.8 dB
		(Vertical)	4.8 dB
	200 MHz to 1000 MHz	(Horizontal)	5.0 dB
		(Vertical)	5.0 dB
3 m	1 GHz to 6 GHz	4.9 dB	
	6 GHz to 18 GHz	5.2 dB	
1 m	10 GHz to 26.5 GHz	5.5 dB	
	26.5 GHz to 40 GHz	5.5 dB	
0.5 m	26.5 GHz to 40 GHz	5.5 dB	
10 m	1 GHz to 18 GHz	5.2 dB	

3.5 Test Location

UL Japan, Inc. Ise EMC Lab.

4383-326 Asama-cho, Ise-shi, Mie-ken 516-0021 JAPAN

Telephone: +81 596 24 8999, Facsimile: +81 596 24 8124

* A2LA Certificate Number: 5107.02/ FCC Test Firm Registration Number: 199967 / ISED Lab Company Number: 2973C

Test site	Width x Depth x Height (m)	Size of reference ground plane (m) / horizontal conducting plane	Other rooms	Maximum measurement distance
No.1 semi-anechoic chamber	19.2 x 11.2 x 7.7	7.0 x 6.0	No.1 Power source room	10 m
No.2 semi-anechoic chamber	7.5 x 5.8 x 5.2	4.0 x 4.0	-	3 m
No.3 semi-anechoic chamber	12.0 x 8.5 x 5.9	6.8 x 5.75	No.3 Preparation room	3 m
No.3 shielded room	4.0 x 6.0 x 2.7	N/A	-	-
No.4 semi-anechoic chamber	12.0 x 8.5 x 5.9	6.8 x 5.75	No.4 Preparation room	3 m
No.4 shielded room	4.0 x 6.0 x 2.7	N/A	-	-
No.5 semi-anechoic chamber	6.0 x 6.0 x 3.9	6.0 x 6.0	-	-
No.5 measurement room	6.4 x 6.4 x 3.0	6.4 x 6.4	-	-
No.6 shielded room	4.0 x 4.5 x 2.7	4.0 x 4.5	-	-
No.6 measurement room	4.75 x 5.4 x 3.0	4.75 x 4.15	-	-
No.7 shielded room	4.7 x 7.5 x 2.7	4.7 x 7.5	-	-
No.8 measurement room	3.1 x 5.0 x 2.7	3.1 x 5.0	-	-
No.9 measurement room	8.8 x 4.6 x 2.8	2.4 x 2.4	-	-
No.11 measurement room	6.2 x 4.7 x 3.0	4.8 x 4.6	-	-

* Size of vertical conducting plane (for Conducted Emission test) : 2.0 m x 2.0 m for No.1, No.2, No.3, and No.4 semi-anechoic chambers and No.3 and No.4 shielded rooms.

3.6 Test data, Test instruments, and Test set up

Refer to APPENDIX.

UL Japan, Inc.

Ise EMC Lab.

4383-326 Asama-cho, Ise-shi, Mie-ken 516-0021 JAPAN

Telephone : +81 596 24 8999

Facsimile : +81 596 24 8124

SECTION 4: Operation of EUT during testing

4.1 Operating Mode(s)

Mode	Remarks
Mode1) RKES Receiving mode (433.58 MHz)	-
Mode2) RKES Receiving mode (434.42 MHz)	
Mode3) TPMS Receiving mode (433.90 MHz)	
* EUT was set by the software as follows; Software: 19CY Ver.1.0 82h00h	

*The test signal level was confirmed to be sufficient to stabilize the local oscillator of the EUT.

*Tuning was confirmed to be locked on each mode by checking local oscillator frequency to be stable using a search-coil.

*The tests were performed only with variation No.1 which was the worst variation, after the test results were compared among Variation No.1 to 6 (the table in "Theory of Operation Variation") at pre-check.

As a result, enough margin for the limit was observed.

4.2 Configuration and peripherals

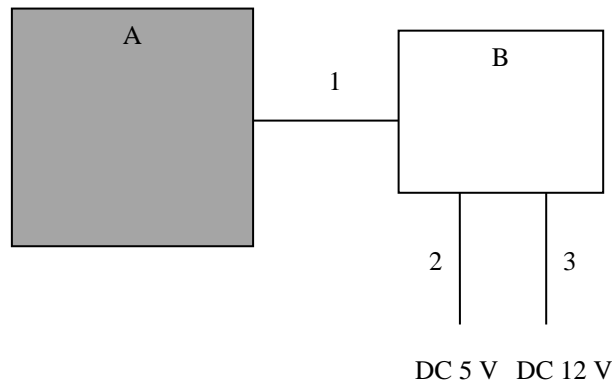

- * Cabling and setup(s) were taken into consideration and test data was taken under worse case conditions.
- * Item No. A includes Receiver Antenna.

Description of EUT and Support equipment

No.	Item	Model number	Serial number	Manufacturer	Remarks
A	Remote Keyless Entry System and TPMS (Receiver)	23ABP	1 *1)	DENSO CORPORATION	EUT
B	Jig	TPMS-RKE/SMART check bench	3	DENSO CORPORATION	-

List of cables used

No.	Name	Length (m)	Shield		Remarks
			Cable	Connector	
1	Signal Cable and power	1.2	Unshielded	Unshielded	-
2	DC Cable	1.0	Unshielded	Unshielded	-
3	DC Cable	1.6	Unshielded	Unshielded	-

*1) Variations owing to antenna matching (Inverse F Antenna Type) *See "Theory of Operation" for details. TYPE1 which was used for the tests has (a) "Resistance 0 ohm", (b) "Nothing", (c) "Nothing" and (d) "Nothing". The result of Radiated emission test was mainly from characteristics of Local Oscillator. If the range of (a), (b), (c), and (d) becomes "Capacitor 0.1-1000pF" or "Inductor 1nH to 100nH", there is no influence on the result of Radiated emission test.

SECTION 5: Radiated Emission

5.1 Operating environment

Test place : No.3 semi anechoic chamber
Temperature : See data
Humidity : See data

5.2 Test configuration

EUT was placed on a urethane platform of nominal size, 1.0 m by 1.5 m, raised 0.8 m above the conducting ground plane.

The EUT was set on the edge of the tabletop.

Test was made with the antenna positioned in both the horizontal and vertical planes of polarization. The measurement antenna was varied in height above the conducting ground plane to obtain the maximum signal strength.

Photographs of the set up are shown in Appendix 3.

5.3 Test conditions

Frequency range : 30 MHz - 200 MHz (Biconical antenna) / 200 MHz - 1000 MHz (Logperiodic antenna)
1000 MHz - 10000 MHz (Horn antenna)
Test distance : 3 m
EUT position : Table top
EUT operation mode : See Clause 4.1

5.4 Test procedure

The height of the measuring antenna varied between 1 and 4 m and EUT was rotated a full revolution in order to obtain the maximum value of the electric field intensity.

The measurements were performed for both vertical and horizontal antenna polarization with the Test Receiver.

The radiated emission measurements were made with the following detector function of the Test Receiver.

For above 1 GHz, test antenna was aimed at the EUT for receiving the maximum signal and always kept within the illumination area of the 3 dB beamwidth of the antenna.

Frequency	Below 1GHz	Above 1GHz *1)
Instrument used	Test Receiver	Test Receiver
IF Bandwidth	QP: BW 120 kHz	PK: BW 1 MHz, CISPR AV: BW 1 MHz

*1) The measurement data was adjusted to a 3 m distance using the following Distance Factor.

Distance Factor: See Figure 2.

Figure 2: Test Setup

Below 1 GHz

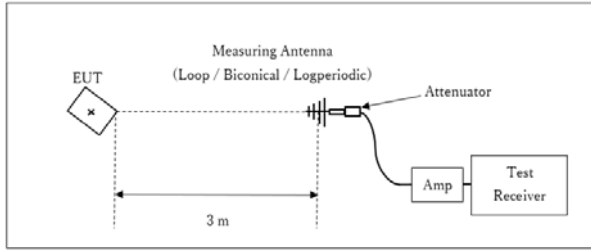

x : Center of turn table

Test Distance: 3 m

1 GHz - 10 GHz

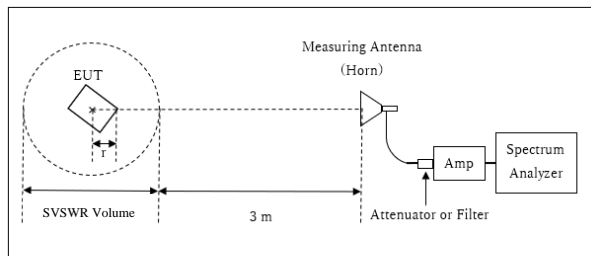

r : Radius of an outer periphery of EUT

x : Center of turn table

Distance Factor: $20 \times \log(3.8 \text{ m}^*/3.0 \text{ m}) = 2.06 \text{ dB}$
* Test Distance: $(3 + \text{SVSWR Volume} / 2) - r = 3.8 \text{ m}$

SVSWR Volume: 2 m
(SVSWR Volume has been calibrated based on CISPR 16-1-4.)
 $r = 0.2 \text{ m}$

- The noise levels were confirmed at each position of X, Y and Z axes of EUT to see the position of maximum noise, and the test was made at the position that has the maximum noise.

5.5 Test result

Summary of the test results: Pass

The limit is rounded down to one decimal place.

The test result is rounded off to one or two decimal places, so some differences might be observed.

Date: October 8, 2020
October 9, 2020

Test engineer: Tomohisa Nakagawa
Akihiko Maeda

APPENDIX 1: Test data

Radiated Emission

Report No. 13523460H
Test place Ise EMC Lab.
Semi Anechoic Chamber No.3
Date October 8, 2020
Temperature / Humidity 22 deg. C / 61 % RH
Engineer Tomohisa Nakagawa
(Below 1 GHz)
Mode Mode 1

Limit : FCC_Part 15 Subpart B(15.109)_Class B

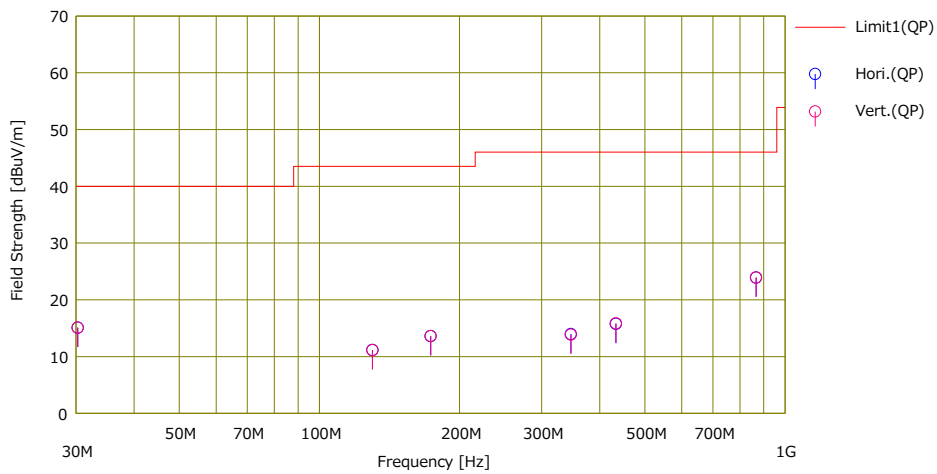

No.	Freq. [MHz]	Reading	Ant Fac	Loss	Gain	Result	Limit	Margh	Polz	Height	Angle	Ant. Type	Comment
		[dBP]				[dBP]	[dBP]	[dBuV/m]					
1	30.265	21.80	18.36	7.12	32.21	15.07	40.00	24.93	Hori.	100	0	BA	
2	129.990	20.90	13.83	8.51	32.10	11.14	43.50	32.36	Hori.	100	0	BA	
3	173.320	20.80	15.88	8.96	32.04	13.60	43.50	29.90	Hori.	100	0	BA	
4	346.640	20.60	14.95	10.39	31.98	13.96	46.00	32.04	Hori.	100	0	LA22	
5	433.300	20.60	16.15	10.99	31.99	15.75	46.00	30.25	Hori.	100	0	LA22	
6	866.600	19.90	21.67	13.42	31.08	23.91	46.00	22.09	Hori.	100	0	LA22	
7	30.265	21.80	18.36	7.12	32.21	15.07	40.00	24.93	Vert.	100	0	BA	
8	129.990	20.90	13.83	8.51	32.10	11.14	43.50	32.36	Vert.	100	0	BA	
9	173.320	20.80	15.88	8.96	32.04	13.60	43.50	29.90	Vert.	100	0	BA	
10	346.640	20.50	14.95	10.39	31.98	13.86	46.00	32.14	Vert.	100	0	LA22	
11	433.300	20.70	16.15	10.99	31.99	15.85	46.00	30.15	Vert.	100	0	LA22	
12	866.600	19.90	21.67	13.42	31.08	23.91	46.00	22.09	Vert.	100	0	LA22	

CHART: WITH FACTOR

ANT TYPE: - 30 MHz: LOOP, 30 MHz - 200 MHz: BICONICAL, 200 MHz - 1000 MHz: LOGPERIODIC, 1000 MHz -: HORN

CALCULATION: RESULT = READING + ANT FACTOR + LOSS(CABLE + ATT) - GAIN(AMP)

Except for the above table: adequate margin data below the limits.

UL Japan, Inc.

Ise EMC Lab.

4383-326 Asama-cho, Ise-shi, Mie-ken 516-0021 JAPAN

Telephone : +81 596 24 8999

Facsimile : +81 596 24 8124

Radiated Emission

Report No. 13523460H
Test place Ise EMC Lab.
Semi Anechoic Chamber No.3
Date October 8, 2020
Temperature / Humidity 22 deg. C / 61 % RH
Engineer Tomohisa Nakagawa
(Below 1 GHz)
Mode Mode 2

Limit : FCC_Part 15 Subpart B(15.109)_Class B

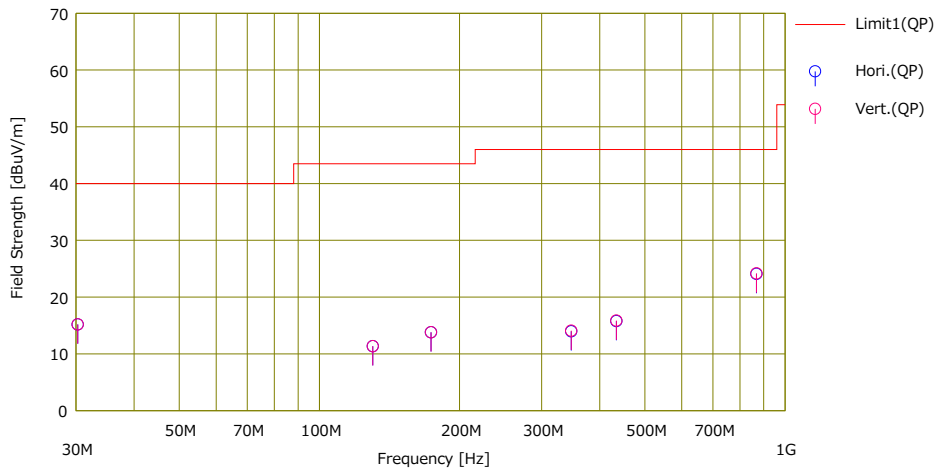

No.	Freq. [MHz]	Reading	Ant.Foc	Loss	Gain	Result	Limit	Margin	Pola.	Height	Angle	Ant. Type	Comment
		(QP)	[dB/m]	[dB]	[dB]	(QP)	(QP)	(QP)					
		[dBuV]				[dBuV/m]	[dBuV/m]	[dB]	[H/V]	[m]	[deg]		
1	30.265	21.90	18.36	7.12	32.21	15.17	40.00	24.83	Hori.	100	0	BA	
2	130.242	21.10	13.84	8.51	32.10	11.35	43.50	32.15	Hori.	100	0	BA	
3	173.656	21.00	15.89	8.96	32.04	13.81	43.50	29.69	Hori.	100	0	BA	
4	347.312	20.60	14.97	10.39	31.98	13.98	46.00	32.02	Hori.	100	0	LA22	
5	434.140	20.60	16.16	11.00	31.99	15.77	46.00	30.23	Hori.	100	0	LA22	
6	868.280	20.10	21.62	13.43	31.07	24.08	46.00	21.92	Hori.	100	0	LA22	
7	30.265	21.90	18.36	7.12	32.21	15.17	40.00	24.83	Vert.	100	0	BA	
8	130.242	21.10	13.84	8.51	32.10	11.35	43.50	32.15	Vert.	100	0	BA	
9	173.656	21.00	15.89	8.96	32.04	13.81	43.50	29.69	Vert.	100	0	BA	
10	347.312	20.70	14.97	10.39	31.98	14.08	46.00	31.92	Vert.	100	0	LA22	
11	434.140	20.70	16.16	11.00	31.99	15.87	46.00	30.13	Vert.	100	0	LA22	
12	868.280	20.20	21.62	13.43	31.07	24.18	46.00	21.82	Vert.	100	0	LA22	

CHART: WITH FACTOR

ANT TYPE: - 30 MHz: LOOP, 30 MHz - 200 MHz: BICONICAL, 200 MHz - 1000 MHz: LOGPERIODIC, 1000 MHz -: HORN

CALCULATION: RESULT = READING + ANT FACTOR + LOSS(CABLE + ATT) - GAIN(AMP)

Except for the above table: adequate margin data below the limits.

UL Japan, Inc.

Ise EMC Lab.

4383-326 Asama-cho, Ise-shi, Mie-ken 516-0021 JAPAN

Telephone : +81 596 24 8999

Facsimile : +81 596 24 8124

Radiated Emission

Report No. 13523460H
Test place Ise EMC Lab.
Semi Anechoic Chamber No.3
Date October 8, 2020
Temperature / Humidity 22 deg. C / 61 % RH
Engineer Tomohisa Nakagawa
(Below 1 GHz)
Mode Mode 3

Limit : FCC_Part 15 Subpart B(15.109)_Class B

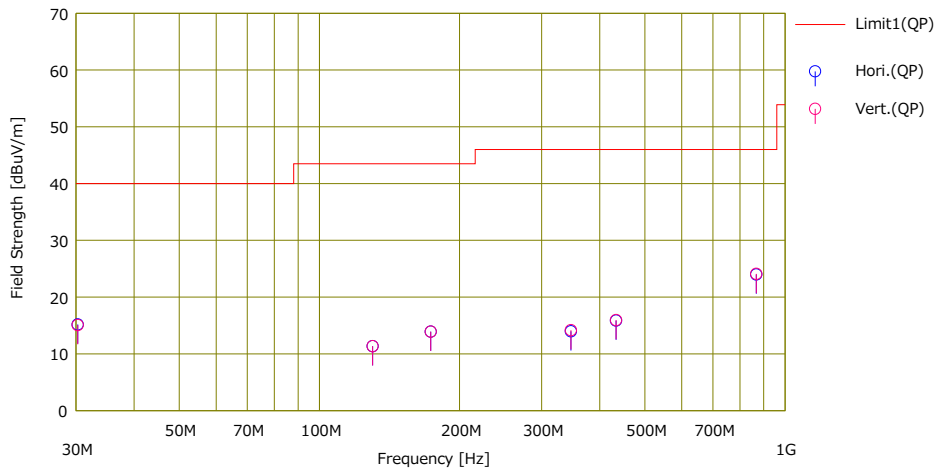

No.	Freq. [MHz]	Reading	Ant.Foc	Loss	Gain	Result	Limit	Margin	Pola.	Height	Angle	Ant. Type	Comment
		(QP)	[dB/m]	[dB]	[dB]	(QP)	(QP)	(QP)					
		[dBuV]				[dBuV/m]	[dBuV/m]	[dB]	[H/V]	[m]	[deg]		
1	30.265	21.90	18.36	7.12	32.21	15.17	40.00	24.83	Hori.	100	0	BA	
2	130.086	21.10	13.84	8.51	32.10	11.35	43.50	32.15	Hori.	100	0	BA	
3	173.448	21.10	15.88	8.96	32.04	13.90	43.50	29.60	Hori.	100	0	BA	
4	346.896	20.60	14.96	10.39	31.98	13.97	46.00	32.03	Hori.	100	0	LA22	
5	433.620	20.70	16.15	10.99	31.99	15.85	46.00	30.15	Hori.	100	0	LA22	
6	867.240	20.00	21.64	13.42	31.08	23.98	46.00	22.02	Hori.	100	0	LA22	
7	30.265	21.80	18.36	7.12	32.21	15.07	40.00	24.93	Vert.	100	0	BA	
8	130.086	21.10	13.84	8.51	32.10	11.35	43.50	32.15	Vert.	100	0	BA	
9	173.448	21.10	15.88	8.96	32.04	13.90	43.50	29.60	Vert.	100	0	BA	
10	346.896	20.80	14.96	10.39	31.98	14.17	46.00	31.83	Vert.	100	0	LA22	
11	433.620	20.80	16.15	10.99	31.99	15.95	46.00	30.05	Vert.	100	0	LA22	
12	867.240	20.10	21.64	13.42	31.08	24.08	46.00	21.92	Vert.	100	0	LA22	

CHART: WITH FACTOR

ANT TYPE: - 30 MHz: LOOP, 30 MHz - 200 MHz: BICONICAL, 200 MHz - 1000 MHz: LOGPERIODIC, 1000 MHz -: HORN

CALCULATION: RESULT = READING + ANT FACTOR + LOSS(CABLE + ATT) - GAIN(AMP)

Except for the above table: adequate margin data below the limits.

UL Japan, Inc.

Ise EMC Lab.

4383-326 Asama-cho, Ise-shi, Mie-ken 516-0021 JAPAN

Telephone : +81 596 24 8999

Facsimile : +81 596 24 8124

Radiated Emission

Report No. 13523460H
Test place Ise EMC Lab.
Semi Anechoic Chamber No.3
Date October 9, 2020
Temperature / Humidity 21 deg. C / 65 % RH
Engineer Akihiko Maeda
(Above 1 GHz)
Mode Mode 1

Limit : FCC_Part 15 Subpart B(15.109)_Class B

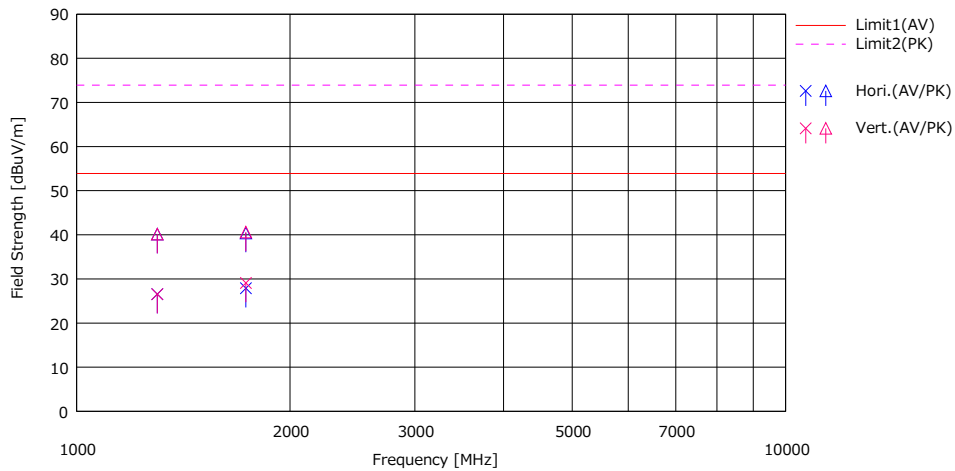

No.	Freq. [MHz]	Reading		Ant.Fac [dB/m]	Loss [dB]	Gain [dB]	Result		Limit		Margin		Pola [H/V]	Height [cm]	Angle [deg]	Ant. Type	Comment
		(AV) [dBuV]	(PK) [dBuV]				(AV) [dBuV/m]	(PK) [dBuV/m]	(AV) [dBuV/m]	(PK) [dBuV/m]	(AV) [dB]	(PK) [dB]					
1	1299.900	31.50	45.10	25.82	3.85	34.62	26.55	40.15	53.90	73.90	27.35	33.75	Hori.	100	0	H2O	
2	1733.200	32.30	44.80	24.99	4.15	33.54	27.90	40.40	53.90	73.90	26.00	33.50	Hori.	100	273	H2O	
3	1299.900	31.50	45.10	25.82	3.85	34.62	26.55	40.15	53.90	73.90	27.35	33.75	Vert.	100	0	H2O	
4	1733.200	33.50	45.00	24.99	4.15	33.54	29.10	40.60	53.90	73.90	24.80	33.30	Vert.	100	37	H2O	

CHART: WITH FACTOR

ANT TYPE: - 30 MHz: LOOP, 30 MHz - 200 MHz: BICONICAL, 200 MHz - 1000 MHz: LOGPERIODIC, 1000 MHz -: HORN

CALCULATION: RESULT = READING + ANT FACTOR + LOSS(CABLE + D-factor) - GAIN(AMP)

Except for the above table: adequate margin data below the limits.

UL Japan, Inc.

Ise EMC Lab.

4383-326 Asama-cho, Ise-shi, Mie-ken 516-0021 JAPAN

Telephone : +81 596 24 8999

Facsimile : +81 596 24 8124

Radiated Emission

Report No. 13523460H
Test place Ise EMC Lab.
Semi Anechoic Chamber No.3
Date October 9, 2020
Temperature / Humidity 21 deg. C / 65 % RH
Engineer Akihiko Maeda
(Above 1 GHz)
Mode Mode 2

Limit : FCC_Part 15 Subpart B(15.109)_Class B

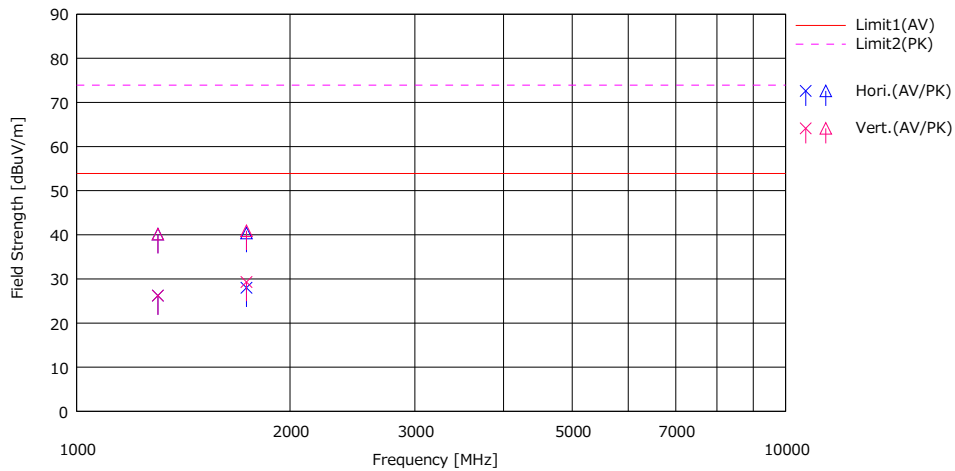

No.	Freq. [MHz]	Reading		Ant.Fac [dB/m]	Loss [dB]	Gain [dB]	Result		Limit		Margin		Pola [H/V]	Height [cm]	Angle [deg]	Ant. Type	Comment
		(AV) [dBuV]	(PK) [dBuV]				(AV) [dBuV/m]	(PK) [dBuV/m]	(AV) [dBuV/m]	(PK) [dBuV/m]	(AV) [dB]	(PK) [dB]					
1	1302.420	31.20	45.10	25.81	3.85	34.62	26.24	40.14	53.90	73.90	27.66	33.76	Hori.	100	0	H2O	
2	1736.560	32.40	44.80	24.99	4.15	33.54	28.00	40.40	53.90	73.90	25.90	33.50	Hori.	100	270	H2O	
3	1302.420	31.20	45.10	25.81	3.85	34.62	26.24	40.14	53.90	73.90	27.66	33.76	Vert.	100	0	H2O	
4	1736.560	33.70	45.30	24.99	4.15	33.54	29.30	40.90	53.90	73.90	24.60	33.00	Vert.	100	38	H2O	

CHART: WITH FACTOR

ANT TYPE: - 30 MHz: LOOP, 30 MHz - 200 MHz: BICONICAL, 200 MHz - 1000 MHz: LOGPERIODIC, 1000 MHz -: HORN

CALCULATION: RESULT = READING + ANT FACTOR + LOSS(CABLE + D-factor) - GAIN(AMP)

Except for the above table: adequate margin data below the limits.

UL Japan, Inc.

Ise EMC Lab.

4383-326 Asama-cho, Ise-shi, Mie-ken 516-0021 JAPAN

Telephone : +81 596 24 8999

Facsimile : +81 596 24 8124

Radiated Emission

Report No. 13523460H
Test place Ise EMC Lab.
Semi Anechoic Chamber No.3
Date October 9, 2020
Temperature / Humidity 21 deg. C / 65 % RH
Engineer Akihiko Maeda
(Above 1 GHz)
Mode Mode 3

Limit : FCC_Part 15 Subpart B(15.109)_Class B

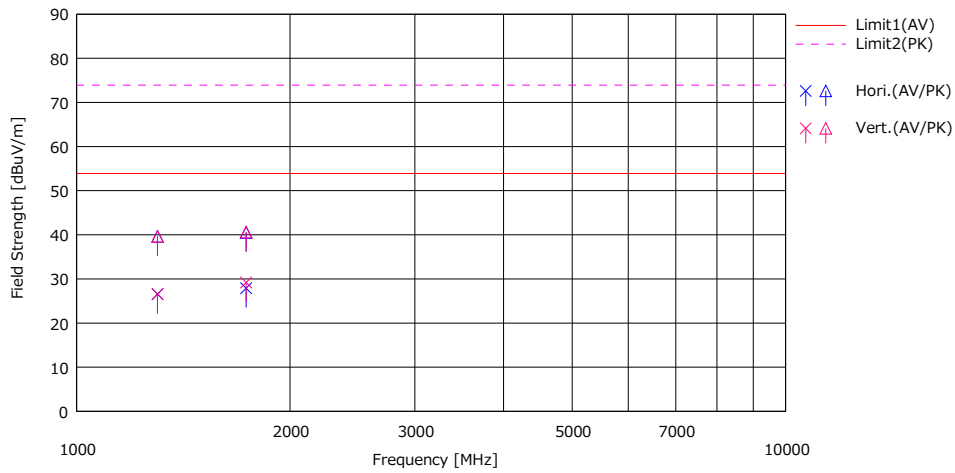

No.	Freq. [MHz]	Reading		Ant.Fac [dB/m]	Loss [dB]	Gain [dB]	Result		Limit		Margin		Pola [H/V]	Height [cm]	Angle [deg]	Ant. Type	Comment
		(AV) [dBuV]	(PK) [dBuV]				(AV) [dBuV/m]	(PK) [dBuV/m]	(AV) [dBuV/m]	(PK) [dBuV/m]	(AV) [dB]	(PK) [dB]					
1	1300.860	31.50	44.60	25.82	3.85	34.62	26.55	39.65	53.90	73.90	27.35	34.25	Hori.	100	0	H2O	
2	1734.480	32.30	44.90	24.99	4.15	33.54	27.90	40.50	53.90	73.90	26.00	33.40	Hori.	100	275	H2O	
3	1300.860	31.50	44.60	25.82	3.85	34.62	26.55	39.65	53.90	73.90	27.35	34.25	Vert.	100	0	H2O	
4	1734.480	33.60	45.00	24.99	4.15	33.54	29.20	40.60	53.90	73.90	24.70	33.30	Vert.	100	36	H2O	

CHART: WITH FACTOR

ANT TYPE: - 30 MHz: LOOP, 30 MHz - 200 MHz: BICONICAL, 200 MHz - 1000 MHz: LOGPERIODIC, 1000 MHz -: HORN

CALCULATION: RESULT = READING + ANT FACTOR + LOSS(CABLE + D-factor) - GAIN(AMP)

Except for the above table: adequate margin data below the limits.

UL Japan, Inc.

Ise EMC Lab.

4383-326 Asama-cho, Ise-shi, Mie-ken 516-0021 JAPAN

Telephone : +81 596 24 8999

Facsimile : +81 596 24 8124

APPENDIX 2: Test instruments

Test equipment

Test Item	Local ID	LIMS ID	Description	Manufacturer	Model	Serial	Last Calibration Date	Cal Int
RE	MAEC-03	142008	AC3_Semi Anechoic Chamber(NSA)	TDK	Semi Anechoic Chamber 3m	DA-10005	05/22/2020	24
RE	MOS-13	141554	Thermo-Hygrometer	CUSTOM. Inc	CTH-201	1301	01/07/2020	12
RE	MMM-08	141532	DIGITAL HiTESTER	Hioki	3805	51201197	01/06/2020	12
RE	MJM-16	142183	Measure	KOMELON	KMC-36	-	-	-
RE	COTS-ME MI-02	178648	EMI measurement program	TSJ (Techno Science Japan)	TEPTO-DV	-	-	-
RE	MAT-95	142314	Attenuator	Pasternack	PE7390-6	D/C 1504	06/17/2020	12
RE	MBA-03	141424	Biconical Antenna	Schwarzbeck Mess - Elektronik	VHA9103+BBA9106	1915	08/13/2020	12
RE	MCC-51	141323	Coaxial cable	UL Japan	-	-	07/06/2020	12
RE	MLA-22	141266	Logperiodic Antenna (200-1000MHz)	Schwarzbeck Mess - Elektronik	VUSLP9111B	9111B-191	08/13/2020	12
RE	MPA-13	141582	Pre Amplifier	SONOMA INSTRUMENT	310	260834	02/10/2020	12
RE	MTR-08	141949	Test Receiver	Rohde & Schwarz	ESCI	100767	08/18/2020	12
RE	MAEC-03-SVSWR	142013	AC3_Semi Anechoic Chamber(SVSWR)	TDK	Semi Anechoic Chamber 3m	DA-10005	04/08/2019	24
RE	MTR-10	141951	EMI Test Receiver	Rohde & Schwarz	ESR26	101408	03/10/2020	12
RE	MHA-20	141507	Horn Antenna 1-18GHz	Schwarzbeck Mess - Elektronik	BBHA9120D	258	10/01/2020	12
RE	MCC-231	177964	Microwave Cable	Junkosha INC.	MMX221	1901S329(1m)/1902S579(5m)	03/02/2020	12
RE	MPA-11	141580	MicroWave System Amplifier	Keysight Technologies Inc	83017A	MY39500779	03/24/2020	12

*Hyphens for Last Calibration Date and Cal Int (month) are instruments that Calibration is not required (e.g. software), or instruments checked in advance before use.

The expiration date of the calibration is the end of the expired month.

As for some calibrations performed after the tested dates, those test equipment have been controlled by means of an unbroken chains of calibrations.

All equipment is calibrated with valid calibrations. Each measurement data is traceable to the national or international standards.

Test item:

RE: Radiated emission

UL Japan, Inc.

Ise EMC Lab.

4383-326 Asama-cho, Ise-shi, Mie-ken 516-0021 JAPAN

Telephone : +81 596 24 8999

Facsimile : +81 596 24 8124