



EMI TEST REPORT

Test Report No. : 11695037H-R1

Applicant : DENSO CORPORATION
Type of Equipment : Tire Pressure Monitoring System (Receiver)
Model No. : 23AAR
FCC ID : HYQ23AAR
Test regulation : FCC Part 15 Subpart B: 2016
Test Result : Complied

1. This test report shall not be reproduced in full or partial, without the written approval of UL Japan, Inc.
2. The results in this report apply only to the sample tested.
3. This sample tested is in compliance with the limits of the above regulation.
4. The test results in this test report are traceable to the national or international standards.
5. This test report must not be used by the customer to claim product certification, approval, or endorsement by NVLAP, NIST, or any agency of the Federal Government.
6. This test report covers EMC technical requirements. It does not cover administrative issues such as Manual or non-EMC test related Requirements. (if applicable)
7. This report is a revised version of 11695037H .11695037H is replaced with this report.

Date of test: March 27 to 31 2017

Representative test engineer:

Hiroyuki Furutaka
Engineer

Consumer Technology Division

Approved by:

Motoya Imura
Engineer

Consumer Technology Division

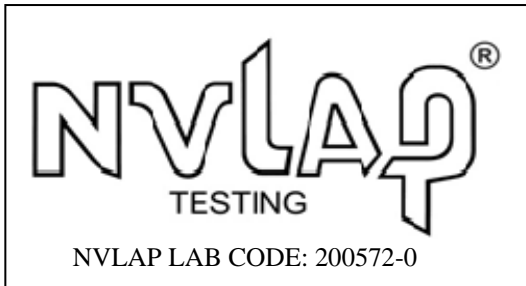

This laboratory is accredited by the NVLAP LAB CODE 200572-0, U.S.A. The tests reported herein have been performed in accordance with its terms of accreditation.
*As for the range of Accreditation in NVLAP, you may refer to the WEB address,
http://japan.ul.com/resources/emc_accredited/

UL Japan, Inc.
Ise EMC Lab.

4383-326 Asama-cho, Ise-shi, Mie-ken 516-0021 JAPAN
Telephone : +81 596 24 8999
Facsimile : +81 596 24 8124

CONTENTS	PAGE
SECTION 1: Customer information	4
SECTION 2: Equipment under test (E.U.T.)	4
SECTION 3: Test specification, procedures & results	5
SECTION 4: Operation of E.U.T. during testing	8
SECTION 5: Radiated Emission	10
SECTION 6: Antenna Terminal.....	11
APPENDIX 1: Test data	12
Radiated Emission	12
Antenna Terminal Conducted Emission.....	16
Radiated Emission (Reference data)	18
APPENDIX 2: Test instruments	28
APPENDIX 3: Photographs of test setup.....	29
Radiated Emission	29
Worst Case Position.....	33

UL Japan, Inc.

Ise EMC Lab.

4383-326 Asama-cho, Ise-shi, Mie-ken 516-0021 JAPAN

Telephone : +81 596 24 8999

Facsimile : +81 596 24 8124

SECTION 1: Customer information

Company Name : DENSO CORPORATION
Address : 1-1, Showa-cho, Kariya-shi, Aichi-ken, 448-8661, Japan
Telephone Number : +81-566-61-7252
Facsimile Number : +81-566-25-4837
Contact Person : HIROMICHI HANAI

SECTION 2: Equipment under test (E.U.T.)

2.1 Identification of E.U.T.

Type of Equipment : Tire Pressure Monitoring System (Receiver)
Model No. : 23AAR
Serial No. : Refer to Section 4, Clause 4.2
Receipt Date of Sample : March 27, 2017
Country of Mass-production : Japan, China, United States of America
Condition of EUT : Engineering prototype
(Not for Sale: This sample is equivalent to mass-produced items.)
Modification of EUT : No Modification by the test lab

2.2 Product description

Model No: 23AAR (referred to as the EUT in this report) is the Tire Pressure Monitoring System (Receiver). 23AAR has 16 variations. For details of variations, see "Theory of Operation".

Feature of EUT:

Tire Pressure Monitoring System is used for monitoring and indicating information of air pressure in vehicle's tires. Transmitter sends receiver the data that informs air pressure in vehicle's tire to the receiver. The data also includes the information of temperature, battery voltage and identity code of transmitter. The receiver judges the data, and if the data of air pressure and others is not in a normal condition, the receiver sends signal to a warning lamp. Then, the warning lamp warns drivers.

Type of receiving system : Super-heterodyne
Frequency of Operation : 433.90 MHz
Oscillator Frequency : 21.948717 MHz Crystal
Type of Modulation : FSK (F1D)
Power Supply : DC 12.0 V
Antenna Type : ANT1: Internal antenna (Inverse F antenna)
ANT2: External antenna

UL Japan, Inc.

Ise EMC Lab.

4383-326 Asama-cho, Ise-shi, Mie-ken 516-0021 JAPAN

Telephone : +81 596 24 8999

Facsimile : +81 596 24 8124

SECTION 3: Test specification, procedures & results

3.1 Test specification

Test specification : FCC Part 15 Subpart B
FCC Part 15 final revised on November 14, 2016 and effective December 14, 2016

Title : FCC 47CFR Part15 Radio Frequency Device
Subpart B Unintentional Radiators

3.2 Procedures and results

Item	Test Procedure	Limits	Deviation	Worst margin	Result
Conducted emission	FCC: ANSI C63.4: 2014 7. AC power - line conducted emission measurements	FCC:Part 15 Subpart B 15.107(a)	N/A *1)	N/A	N/A
	IC: RSS-Gen 8.8	IC: RSS-Gen 8.8			
Radiated emission	FCC: ANSI C63.4: 2014 8. Radiated emission measurements	FCC: Part 15 Subpart B 15.109(a)	N/A	27.1 dB 1229.128 MHz Horizontal/Vertical AV	Complied
	IC: RSS-Gen 7	IC: RSS-Gen 7.1.2			
Antenna Terminal	FCC: ANSI C63.4: 2014 12. Measurement of unintentional radiators other than ITE	FCC: Part 15 Subpart B 15.111(a)	N/A	28.1 dB 1214.996 MHz PK	Complied
	IC: RSS-Gen 7	IC: RSS-Gen 7.1.3			
*Note: UL Japan, Inc's EMI Work Procedure 13-EM-W0420.					
*1) The test is not applicable since the EUT is not the device that is designed to be connected to the public utility (AC) power line.					

3.3 Addition to standard

No addition, exclusion nor deviation has been made from the standard.

UL Japan, Inc.

Ise EMC Lab.

4383-326 Asama-cho, Ise-shi, Mie-ken 516-0021 JAPAN

Telephone : +81 596 24 8999

Facsimile : +81 596 24 8124

3.4 Uncertainty

EMI

The following uncertainties have been calculated to provide a confidence level of 95 % using a coverage factor $k = 2$.

Test distance	Radiated emission (+/-)
	9 kHz - 30 MHz
3 m	3.8 dB
10 m	3.7 dB

*Measurement distance

Polarity	Radiated emission (Below 1 GHz)			
	(3 m*)(+/-)		(10 m*)(+/-)	
	30 MHz - 200 MHz	200 MHz - 1000 MHz	30 MHz - 200 MHz	200 MHz - 1000 MHz
Horizontal	5.0 dB	5.3 dB	5.0 dB	5.0 dB
Vertical	4.7 dB	5.9 dB	5.0 dB	5.1 dB

Radiated emission (Above 1 GHz)				
(3 m*)(+/-)		(1 m*)(+/-)		(10 m*)(+/-)
1 GHz - 6 GHz	6 GHz - 18 GHz	10 GHz - 26.5 GHz	26.5 GHz - 40 GHz	1 GHz - 18 GHz
5.2 dB	5.4 dB	5.5 dB	5.5 dB	5.4 dB

* Measurement distance

Antenna terminal conducted emission and Power density (+dB)			Antenna terminal conducted emission (+dB)	
Below 1 GHz	1 GHz - 3 GHz	3 GHz - 18 GHz	18 GHz - 26.5 GHz	26.5 GHz - 40 GHz
1.4 dB	1.5 dB	2.8 dB	2.8 dB	2.9 dB

Radiated emission test (3 m)

The data listed in this test report has enough margin, more than the site margin.

Antenna terminal conducted emission test

The data listed in this test report has enough margin, more than the site margin.

3.5 Test Location

UL Japan, Inc. Ise EMC Lab. *NVLAP Lab. code: 200572-0
4383-326 Asama-cho, Ise-shi, Mie-ken 516-0021 JAPAN
Telephone : +81 596 24 8999 Facsimile : +81 596 24 8124

	IC Registration Number	Width x Depth x Height (m)	Size of reference ground plane (m) / horizontal conducting plane	Other rooms
No.1 semi-anechoic chamber	2973C-1	19.2 x 11.2 x 7.7m	7.0 x 6.0m	No.1 Power source room
No.2 semi-anechoic chamber	2973C-2	7.5 x 5.8 x 5.2m	4.0 x 4.0m	-
No.3 semi-anechoic chamber	2973C-3	12.0 x 8.5 x 5.9m	6.8 x 5.75m	No.3 Preparation room
No.3 shielded room	-	4.0 x 6.0 x 2.7m	N/A	-
No.4 semi-anechoic chamber	2973C-4	12.0 x 8.5 x 5.9m	6.8 x 5.75m	No.4 Preparation room
No.4 shielded room	-	4.0 x 6.0 x 2.7m	N/A	-
No.5 semi-anechoic chamber	-	6.0 x 6.0 x 3.9m	6.0 x 6.0m	-
No.6 shielded room	-	4.0 x 4.5 x 2.7m	4.0 x 4.5 m	-
No.6 measurement room	-	4.75 x 5.4 x 3.0m	4.75 x 4.15 m	-
No.7 shielded room	-	4.7 x 7.5 x 2.7m	4.7 x 7.5m	-
No.8 measurement room	-	3.1 x 5.0 x 2.7m	N/A	-
No.9 measurement room	-	8.8 x 4.6 x 2.8m	2.4 x 2.4m	-
No.11 measurement room	-	6.2 x 4.7 x 3.0m	4.8 x 4.6m	-

* Size of vertical conducting plane (for Conducted Emission test): 2.0 x 2.0 m for No.1, No.2, No.3, and No.4 semi-anechoic chambers and No.3 and No.4 shielded rooms.

3.6 Test data, Test instruments, and Test set up

Refer to APPENDIX.

SECTION 4: Operation of E.U.T. during testing

4.1 Operating modes

The mode used: TPMS Receiving mode (433.90 MHz)

* Refer to the table in “Theory of Operation_Variation_23AAR” for test mode.

Regarding TPMS Receiving mode (433.90 MHz), internal antenna receiving was tested with Variation No. 3, because there was no difference in noise level compared to the other representative variants (Variation No. 3, 4, 7, 11, and 15) of the table in “Theory of Operation”.

Also, external antenna receiving was tested with Variation No. 3 as representative, because there was no difference in circuit construction by variations.

Among Variation No.1 to 16,

- the difference due to the feeding point and antenna variation of the internal antenna was confirmed with Variation No. 3, 4, 7, 11 and 15.
- regarding External antenna, variants with External antenna were tested, which were the worst condition for EMI.

As a result, enough margin for the limit was observed.

4.2 Configuration and peripherals

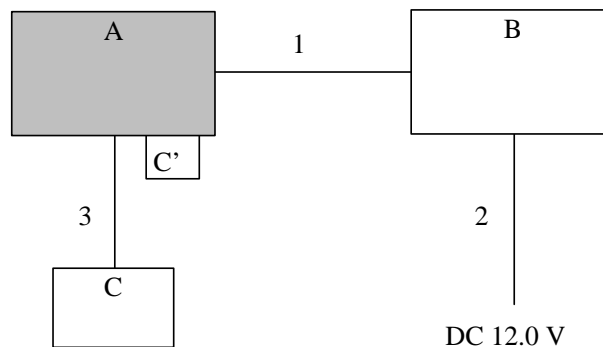

*Cabling and setup were taken into consideration and test data was taken under worse case conditions.

*Tuning was confirmed to be locked on each mode by checking local oscillator frequency to be stable using a search-coil.

UL Japan, Inc.

Ise EMC Lab.

4383-326 Asama-cho, Ise-shi, Mie-ken 516-0021 JAPAN

Telephone : +81 596 24 8999

Facsimile : +81 596 24 8124

Description of EUT and Support equipment

No.	Item	Model number	Serial number	Manufacturer	Remarks
A	Tire Pressure Monitoring System (Receiver)	23AAR	001 (Variation No. 3) *1)	DENSO CORPORATION	EUT
			002 (Variation No. 4)		
			003 (Variation No. 7)		
			004 (Variation No. 11)		
			005 (Variation No. 15)		
B	TPMS-RKE/SMART checker bench	-	1419489-01	DENSO CORPORATION	-
C	Antenna	-	12J25	DENSO CORPORATION	*2)
C'	Terminal Jig	-	-	DENSO CORPORATION	*3)

List of cables used

No.	Name	Length (m)	Shield		Remarks
			Cable	Connector	
1	DC and Signal Cable	1.2	Unshielded	Unshielded	-
2	DC Cable	1.0	Unshielded	Unshielded	-
3	Antenna Cable	1.5	Shielded	Shielded	*2)

*2) Used for External Antenna only.

*3) Used for Internal Antenna only.

*1) **Variations owing to antenna matching (Inverse F Antenna Type)** *See "Theory of Operation" for details.

TYPE1 which was used for the tests has 306 "Nothing" and 307 "Nothing".

The result of Radiated emission test was mainly from characteristics of Local Oscillator.

If the range of 306, 307, 308 and 309 becomes "Capacitor 0.1 - 1000pF", or "Inductor 1 - 100nH", there is no influence on the result of Radiated emission test.

UL Japan, Inc.

Ise EMC Lab.

4383-326 Asama-cho, Ise-shi, Mie-ken 516-0021 JAPAN

Telephone : +81 596 24 8999

Facsimile : +81 596 24 8124

SECTION 5: Radiated Emission

5.1 Operating environment

Test place : No. 3 semi anechoic chamber
Temperature : See data
Humidity : See data

5.2 Test configuration

EUT was placed on a urethane platform of nominal size, 1.0 m by 1.5 m, raised 0.8 m above the conducting ground plane.

The EUT was set on the edge of the tabletop.

Test was made with the antenna positioned in both the horizontal and vertical planes of polarization. The measurement antenna was varied in height above the conducting ground plane to obtain the maximum signal strength.

Photographs of the set up are shown in Appendix 3.

5.3 Test conditions

Frequency range : 30 MHz - 200 MHz (Biconical antenna) / 200 MHz - 1000 MHz (Logperiodic antenna)
1000 MHz - 2000 MHz (Horn antenna)
Test distance : 3 m
EUT position : Table top
EUT operation mode : See Clause 4.1

5.4 Test procedure

The height of the measuring antenna varied between 1 and 4m and EUT was rotated a full revolution in order to obtain the maximum value of the electric field intensity.

The measurements were performed for both vertical and horizontal antenna polarization with the Test Receiver.

The radiated emission measurements were made with the following detector function of the Test Receiver.

Frequency	Below 1 GHz	Above 1 GHz *1)
Instrument used	Test Receiver	Test Receiver
IF Bandwidth	QP: BW 120 kHz	PK: BW 1 MHz, CISPR AV: BW 1 MHz

*1) The measurement data was adjusted to a 3 m distance using the following Distance Factor.

Distance Factor: $20 \times \log(4.2 \text{ m} / 3 \text{ m}) = 2.92 \text{ dB}$

- The noise levels were confirmed at each position of X, Y and Z axes of EUT to see the position of maximum noise, and the test was made at the position that has the maximum noise.

5.5 Test result

Summary of the test results: Pass

Date: March 27, 2017
March 29, 2017
Test engineer: Hiroyuki Furutaka
Tomoki Matsui

UL Japan, Inc.

Ise EMC Lab.

4383-326 Asama-cho, Ise-shi, Mie-ken 516-0021 JAPAN

Telephone : +81 596 24 8999

Facsimile : +81 596 24 8124

SECTION 6: Antenna Terminal

6.1 Operating environment

Test place : No.1 semi anechoic chamber
Temperature : See data
Humidity : See data

6.2 Test configuration

EUT was placed on a wooden table of nominal size, 1.0 m by 1.5 m, raised 0.8 m from the ground.

6.3 Test conditions

Frequency range : 30 MHz - 1000 MHz / 1000 MHz - 2000 MHz
Test distance : N/A
EUT position : Table top
EUT operation mode : See Clause 4.1

6.4 Test procedure

The Antenna Terminal was measured with a spectrum analyzer connected to the antenna port.

Frequency	Below 1 GHz	Above 1 GHz
Instrument used	Spectrum Analyzer	Spectrum Analyzer
IF Bandwidth	PK: RBW:100 kHz/VBW: 100 kHz	PK: RBW:1 MHz/VBW: 3 MHz

6.5 Test result

Summary of the test results: Pass

Date: March 31, 2017

Test engineer: Hiroyuki Furutaka

APPENDIX 1: Test data

Radiated Emission
TPMS (433.9MHz) Variation No. 3 Internal Antenna
(Below 1GHz)

DATA OF RADIATED EMISSION TEST

UL Japan, Inc. Ise EMC Lab. No.3 Semi Anechoic Chamber
Date : 2017/03/29

Report No. : 11695037H
Temp./Humi. : 23deg.C. / 25% RH
Engineer : Tomoki Matsui

Mode / Remarks : TPMS Receiving

LIMIT : FCC15.109(a) 3m, below 1GHz:QP, above 1GHz:AV
Except for the data below : adequate margin data below the limits.

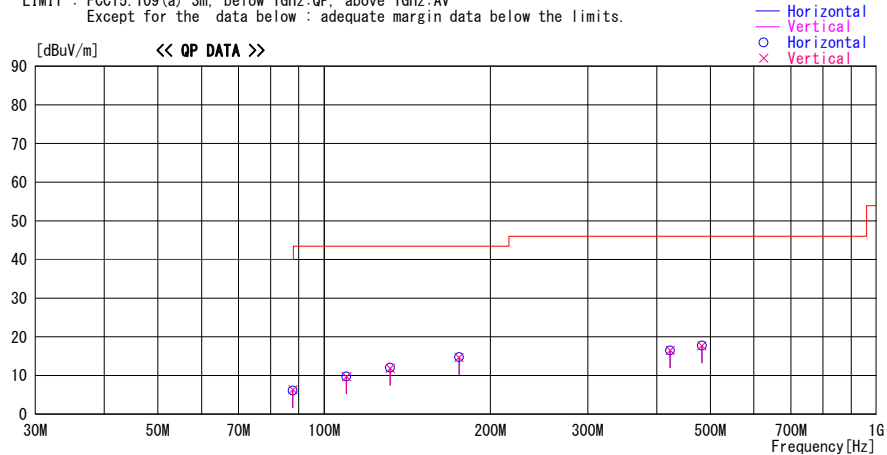

Frequency [MHz]	Reading [dBuV]	DET	Antenna	Loss&	Level	Angle	Height	Polar.	Limit	Margin	Comment
			Factor [dB/m]	Gain [dB]							
87.795	22.4	QP	8.1	-24.2	6.3	0	100	Vert.	40.0	33.7	
87.795	22.2	QP	8.1	-24.2	6.1	0	300	Hori.	40.0	33.9	
109.743	22.2	QP	11.4	-23.9	9.7	0	100	Vert.	43.5	33.8	
109.743	22.2	QP	11.4	-23.9	9.7	0	300	Hori.	43.5	33.8	
131.692	21.7	QP	13.9	-23.7	11.9	0	100	Vert.	43.5	31.6	
131.692	21.8	QP	13.9	-23.7	12.0	0	300	Hori.	43.5	31.5	
175.589	21.6	QP	16.2	-23.1	14.7	0	100	Vert.	43.5	28.8	
175.589	21.6	QP	16.2	-23.1	14.7	0	300	Hori.	43.5	28.8	
423.200	21.5	QP	16.2	-21.2	16.5	0	100	Hori.	46.0	29.5	
423.200	21.5	QP	16.2	-21.2	16.5	0	100	Vert.	46.0	29.5	
482.871	21.2	QP	17.3	-20.8	17.7	0	100	Vert.	46.0	28.3	
482.871	21.2	QP	17.3	-20.8	17.7	0	100	Hori.	46.0	28.3	

CHART: WITH FACTOR ANT TYPE: -30 MHz: LOOP, 30 MHz - 200 MHz: BICONICAL, 200 MHz - 1000 MHz: LOGPERIODIC, 1000 MHz-: HORN
CALCULATION : RESULT = READING + ANT FACTOR + LOSS & GAIN(CABLE + ATTEN - GAIN(AMP))

*The limit is rounded down to one decimal place.
*The test result is rounded off to one or two decimal places, so some differences might be observed.

Radiated Emission
TPMS (433.9MHz) Variation No. 3 Internal Antenna
(Above 1GHz)

DATA OF RADIATED EMISSION TEST

UL Japan, Inc. Head Office EMC Lab. No.3 Semi Anechoic Chamber
Date : 2017/03/27

Report No. : 11695037H
Temp./Humi. : 23deg.C. / 34% RH
Engineer : Hiroyuki Furutaka

Mode / Remarks : TPMS Receiving

LIMIT : FCC15.109(a) 3m, below 1GHz:QP, above 1GHz:PK
FCC15.109(a) 3m, below 1GHz:QP, above 1GHz:AV

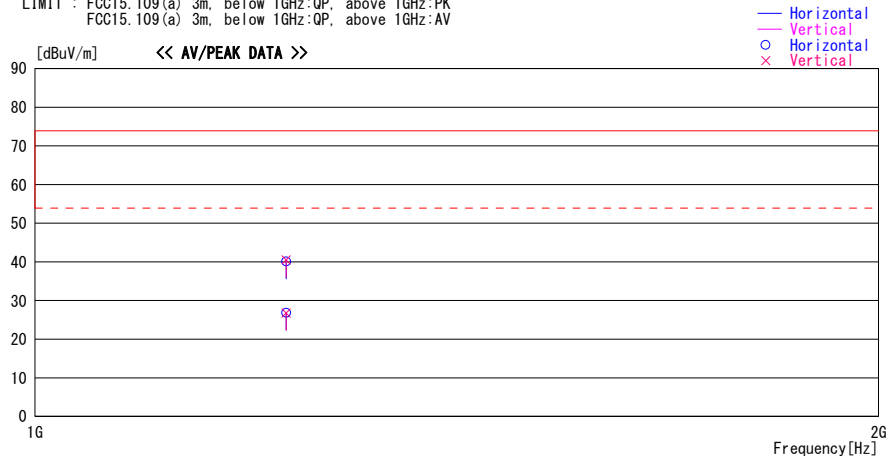

Frequency [MHz]	Reading [dBuV]	DET	Antenna	Loss&	Level	Angle	Height	Polar.	Limit	Margin	Comment
			Factor	Gain							
			[dB/m]	[dB]	[dBuV/m]	[Deg]	[cm]		[dBuV/m]	[dB]	
1229.128	45.5	PK	24.4	-29.4	40.5	0	100	Vert.	73.9	33.4	
1229.128	31.8	AV	24.4	-29.4	26.8	0	100	Vert.	53.9	27.1	
1229.128	45.1	PK	24.4	-29.4	40.1	0	100	Hori.	73.9	33.8	
1229.128	31.8	AV	24.4	-29.4	26.8	0	100	Hori.	53.9	27.1	

CHART: WITH FACTOR ANT TYPE: -30 MHz: LOOP, 30 MHz - 200 MHz: BICONICAL, 200 MHz - 1000 MHz: LOGPERIODIC, 1000 MHz-: HORN
CALCULATION : RESULT = READING + ANT FACTOR + LOSS & GAIN (CABLE - GAIN(AMP) + D. FACTOR)

*The limit is rounded down to one decimal place.
*The test result is rounded off to one or two decimal places, so some differences might be observed.

Radiated Emission
TPMS (433.9MHz) Variation No. 3 External Antenna
(Below 1GHz)

DATA OF RADIATED EMISSION TEST

UL Japan, Inc. Ise EMC Lab. No.3 Semi Anechoic Chamber
Date : 2017/03/29

Report No. : 11695037H
Temp./Humi. : 23deg.C. / 25% RH
Engineer : Tomoki Matsui

Mode / Remarks : TPMS Receiving

LIMIT : FCC15.109(a) 3m. below 1GHz:QP, above 1GHz:AV
Except for the data below : adequate margin data below the limits.

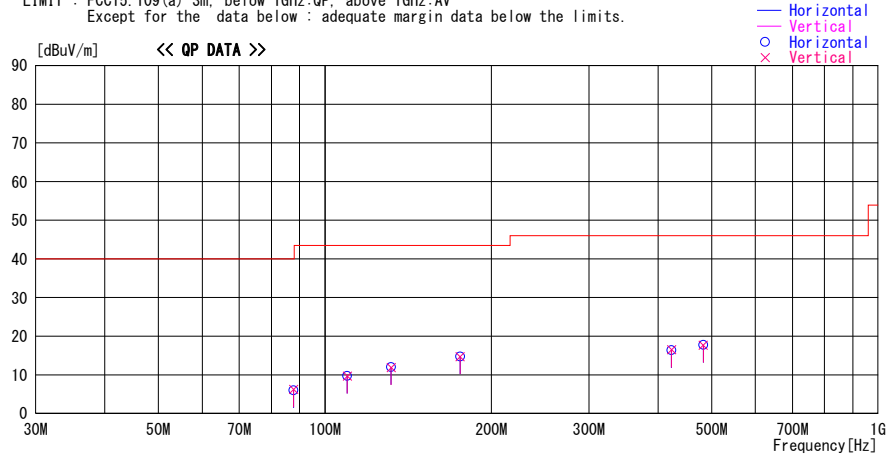

Frequency [MHz]	Reading [dBuV]	DET	Antenna	Loss&	Level	Angle	Height	Polar.	Limit	Margin	Comment
			Factor [dB/m]	Gain [dB]							
87.795	22.3	QP	8.1	-24.2	6.2	0	100	Vert.	40.0	33.8	
87.795	22.1	QP	8.1	-24.2	6.0	0	300	Hori.	40.0	34.0	
109.743	22.2	QP	11.4	-23.9	9.7	0	100	Vert.	43.5	33.8	
109.743	22.2	QP	11.4	-23.9	9.7	0	300	Hori.	43.5	33.8	
131.692	21.7	QP	13.9	-23.7	11.9	0	100	Vert.	43.5	31.6	
131.692	21.8	QP	13.9	-23.7	12.0	0	300	Hori.	43.5	31.5	
175.589	21.6	QP	16.2	-23.1	14.7	0	100	Vert.	43.5	28.8	
175.589	21.6	QP	16.2	-23.1	14.7	0	300	Hori.	43.5	28.8	
423.200	21.4	QP	16.2	-21.2	16.4	0	100	Hori.	46.0	29.6	
423.200	21.5	QP	16.2	-21.2	16.5	0	100	Vert.	46.0	29.5	
482.871	21.2	QP	17.3	-20.8	17.7	0	100	Vert.	46.0	28.3	
482.871	21.2	QP	17.3	-20.8	17.7	0	100	Hori.	46.0	28.3	

CHART: WITH FACTOR ANT TYPE: -30 MHz: LOOP, 30 MHz - 200 MHz: BICONICAL, 200 MHz - 1000 MHz: LOGPERIODIC, 1000 MHz-: HORN
CALCULATION : RESULT = READING + ANT FACTOR + LOSS & GAIN(CABLE + ATTEN - GAIN(AMP))

*The limit is rounded down to one decimal place.
*The test result is rounded off to one or two decimal places, so some differences might be observed.

Radiated Emission
TPMS (433.9MHz) Variation No. 3 External Antenna
(Above 1GHz)

DATA OF RADIATED EMISSION TEST

UL Japan, Inc. Head Office EMC Lab. No.3 Semi Anechoic Chamber
Date : 2017/03/27

Report No. : 11695037H
Temp./Humi. : 23deg.C. / 34% RH
Engineer : Hiroyuki Furutaka

Mode / Remarks : TPMS Receiving

LIMIT : FCC15.109(a) 3m, below 1GHz:QP, above 1GHz:PK
FCC15.109(a) 3m, below 1GHz:QP, above 1GHz:AV

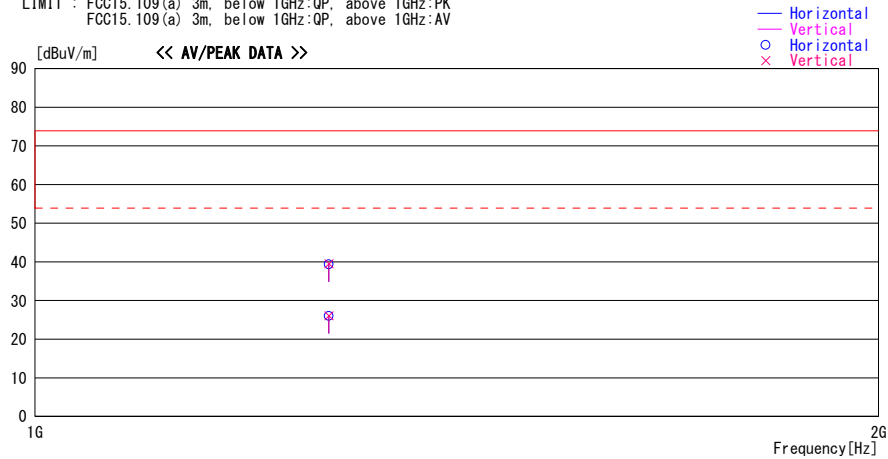

Frequency [MHz]	Reading [dBuV]	DET	Antenna	Loss&	Level	Angle	Height	Polar.	Limit	Margin	Comment
			Factor	Gain							
			[dB/m]	[dB]	[dBuV/m]	[Deg]	[cm]		[dBuV/m]	[dB]	
1273.025	44.2	PK	24.5	-29.3	39.4	0	100	Hori.	73.9	34.5	
1273.025	44.3	PK	24.5	-29.3	39.5	0	100	Vert.	73.9	34.4	
1273.025	30.8	AV	24.5	-29.3	26.0	0	100	Hori.	53.9	27.9	
1273.025	30.9	AV	24.5	-29.3	26.1	0	100	Vert.	53.9	27.8	

CHART : WITH FACTOR ANT TYPE: -30 MHz: LOOP, 30 MHz - 200 MHz: BICONICAL, 200 MHz - 1000 MHz: LOGPERIODIC, 1000 MHz--: HORN
CALCULATION : RESULT = READING + ANT FACTOR + LOSS & GAIN (CABLE - GAIN(AMP) + D.FACTOR)

*The limit is rounded down to one decimal place.
*The test result is rounded off to one or two decimal places, so some differences might be observed.

Antenna Terminal Conducted Emission
TPMS (433.9MHz) Variation No. 3 External Antenna
(Below 1GHz)

UL Japan, Inc. Ise EMC Lab. No.5 Semi Anechoic Chamber
Date : 2017/03/31

Report No. : 11695037H
Temp./Humi. : 22deg. C / 42% RH
Engineer : Hiroyuki Furutaka

Mode / Remarks : TPMS Receiving External Antenna

LIMIT : FCC15.111 Antenna terminal measurement
Except for the data below : adequate margin data below the limits.

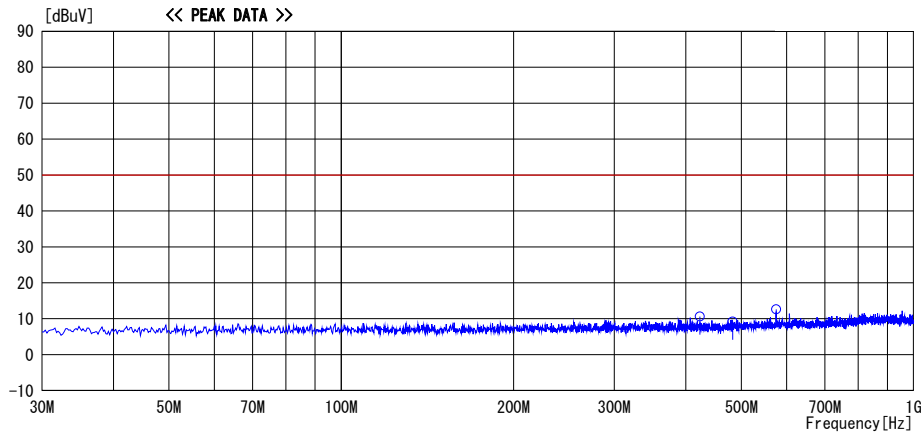

Frequency [MHz]	Reading [dBuV]	DET	Antenna	Loss&	Level [dBuV]	Polar.	Limit *1) [dBuV]	Margin [dB]	Comment
			Factor [dB/m]	Gain [dB]					
423.200	29.8	PK	0.0	-19.2	10.6	-	50.0	39.4	
482.871	28.3	PK	0.0	-19.1	9.2	-	50.0	40.8	
575.233	31.4	PK	0.0	-18.8	12.6	-	50.0	37.4	

*1) 2nW = -57dBm = 50dBuV

CHART:WITH FACTOR ANT TYPE: -30MHz:LOOP, 30-200MHz:BICONICAL, 200MHz-1000MHz:LOGPERIODIC, 1000MHz-:HORN
CALCULATION : RESULT = READING + ANT FACTOR + LOSS & GAIN(CABLE + ATTEN. - GAIN(AMP))

Antenna Terminal Conducted Emission
TPMS (433.9MHz) Variation No. 3 External Antenna
(Above 1GHz)

UL Japan, Inc. Ise EMC Lab. No.1 Semi Anechoic Chamber
Date : 2017/03/31

Report No. : 11695037H
Temp./Humi. : 22deg. C / 42% RH
Engineer : Hiroyuki Furutaka

Mode / Remarks : TPMS Receiving External Antenna

LIMIT : FCC15.111 Antenna terminal measurement
Except for the data below : adequate margin data below the limits.

— Horizontal
Vertical

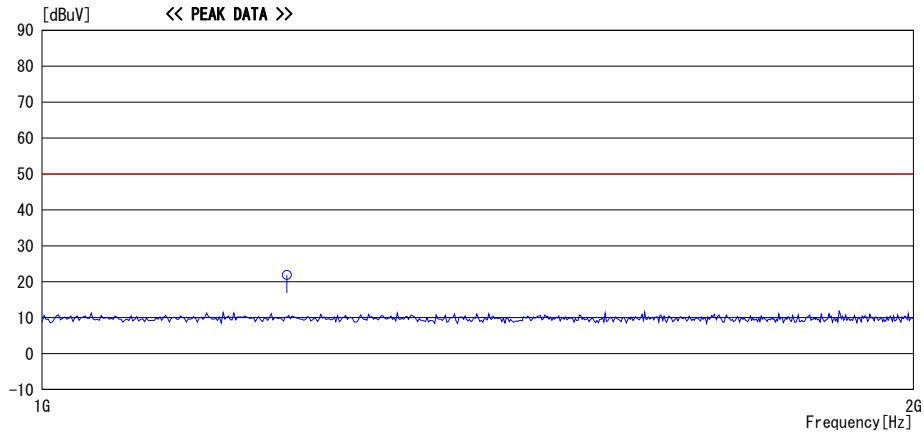

Frequency [MHz]	Reading [dBuV]	DET	Antenna		Level [dBuV]	Polar.	Limit *1)		Margin [dB]	Comment
			Factor [dB/m]	Loss & Gain [dB]			[dBuV]	[dB]		
1214.996	47.0	PK	0.0	-25.1	21.9	-	50.0	28.1		

*1) 2nW = -57dBm = 50dBuV

CHART: WITH FACTOR ANT TYPE: -30MHz: LOOP, 30-200MHz: BICONICAL, 200MHz-1000MHz: LOGPERIODIC, 1000MHz-: HORN
CALCULATION : RESULT = READING + ANT FACTOR + LOSS & GAIN (CABLE + ATTEN. - GAIN (AMP))

Radiated Emission (Reference data)
TPMS (433.9MHz) Variation No. 4 Internal Antenna
(Below 1GHz)

DATA OF RADIATED EMISSION TEST

UL Japan, Inc. Ise EMC Lab. No.3 Semi Anechoic Chamber
Date : 2017/03/29

Report No. : 11695037H
Temp./Humi. : 23deg.C. / 25% RH
Engineer : Tomoki Matsui

Mode / Remarks : TPMS Receiving

LIMIT : FCC15.109(a) 3m. below 1GHz:QP, above 1GHz:AV
Except for the data below : adequate margin data below the limits.

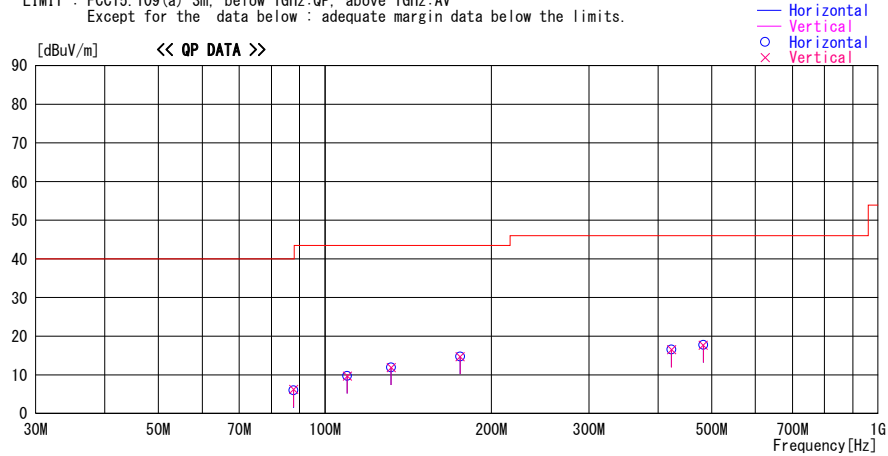

Frequency [MHz]	Reading [dBuV]	DET	Antenna	Loss&	Level	Angle	Height	Polar.	Limit	Margin	Comment
			Factor [dB/m]	Gain [dB]							
87.795	22.3	QP	8.1	-24.2	6.2	0	100	Vert.	40.0	33.8	
87.795	22.1	QP	8.1	-24.2	6.0	0	300	Hori.	40.0	34.0	
109.743	22.2	QP	11.4	-23.9	9.7	0	100	Vert.	43.5	33.8	
109.743	22.2	QP	11.4	-23.9	9.7	0	300	Hori.	43.5	33.8	
131.692	21.7	QP	13.9	-23.7	11.9	0	100	Vert.	43.5	31.6	
131.692	21.7	QP	13.9	-23.7	11.9	0	300	Hori.	43.5	31.6	
175.589	21.6	QP	16.2	-23.1	14.7	0	100	Vert.	43.5	28.8	
175.589	21.6	QP	16.2	-23.1	14.7	0	300	Hori.	43.5	28.8	
423.200	21.6	QP	16.2	-21.2	16.6	0	100	Hori.	46.0	29.4	
423.200	21.5	QP	16.2	-21.2	16.5	0	100	Vert.	46.0	29.5	
482.871	21.2	QP	17.3	-20.8	17.7	0	100	Vert.	46.0	28.3	
482.871	21.2	QP	17.3	-20.8	17.7	0	100	Hori.	46.0	28.3	

CHART : WITH FACTOR ANT TYPE: -30 MHz: LOOP, 30 MHz - 200 MHz: BICONICAL, 200 MHz - 1000 MHz: LOGPERIODIC, 1000 MHz-: HORN
CALCULATION : RESULT = READING + ANT FACTOR + LOSS & GAIN(CABLE + ATTEN - GAIN(AMP))

*The limit is rounded down to one decimal place.
*The test result is rounded off to one or two decimal places, so some differences might be observed.

Radiated Emission (Reference data)
TPMS (433.9MHz) Variation No. 4 Internal Antenna
(Above 1GHz)

DATA OF RADIATED EMISSION TEST

UL Japan, Inc. Head Office EMC Lab. No.3 Semi Anechoic Chamber
Date : 2017/03/27

Report No. : 11695037H
Temp./Humi. : 23deg.C. / 34% RH
Engineer : Hiroyuki Furutaka

Mode / Remarks : TPMS Receiving

LIMIT : FCC15.109(a) 3m, below 1GHz:QP, above 1GHz:PK
FCC15.109(a) 3m, below 1GHz:QP, above 1GHz:AV

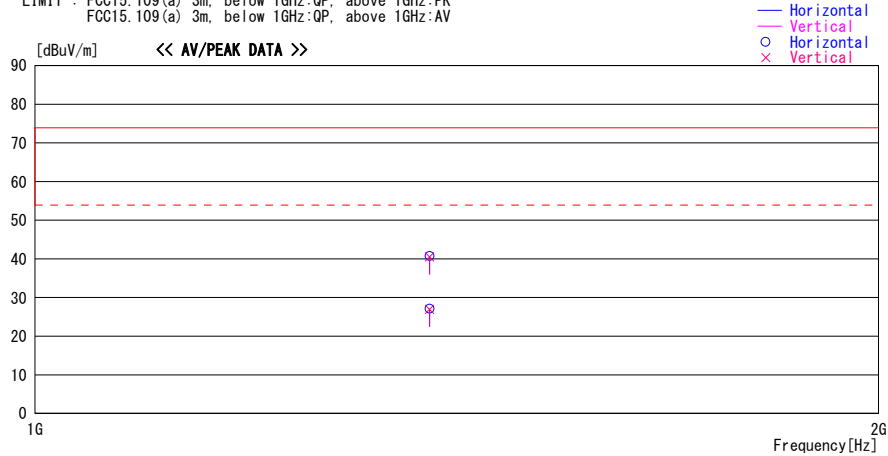

Frequency [MHz]	Reading [dBuV]	DET	Antenna	Loss&	Level	Angle	Height	Polar.	Limit	Margin	Comment
			Factor	Gain							
			[dB/m]	[dB]	[dBuV/m]	[Deg]	[cm]		[dBuV/m]	[dB]	
1382.769	44.8	PK	24.8	-28.9	40.7	0	100	Hori.	73.9	33.2	
1382.769	44.6	PK	24.8	-28.9	40.5	0	100	Vert.	73.9	33.4	
1382.769	31.2	AV	24.8	-28.9	27.1	0	100	Hori.	53.9	26.8	
1382.769	31.1	AV	24.8	-28.9	27.0	0	100	Vert.	53.9	26.9	

CHART: WITH FACTOR ANT TYPE: -30 MHz: LOOP, 30 MHz - 200 MHz: BICONICAL, 200 MHz - 1000 MHz: LOGPERIODIC, 1000 MHz-: HORN
CALCULATION : RESULT = READING + ANT FACTOR + LOSS & GAIN (CABLE - GAIN(AMP) + D.FACTOR)

*The limit is rounded down to one decimal place.
*The test result is rounded off to one or two decimal places, so some differences might be observed.

Radiated Emission (Reference data)
TPMS (433.9MHz) Variation No. 4 External Antenna
(Below 1GHz)

DATA OF RADIATED EMISSION TEST

UL Japan, Inc. Ise EMC Lab. No.3 Semi Anechoic Chamber
Date : 2017/03/29

Report No. : 11695037H
Temp./Humi. : 23deg.C. / 25% RH
Engineer : Tomoki Matsui

Mode / Remarks : TPMS Receiving

LIMIT : FCC15.109(a) 3m. below 1GHz:QP, above 1GHz:AV
Except for the data below : adequate margin data below the limits.

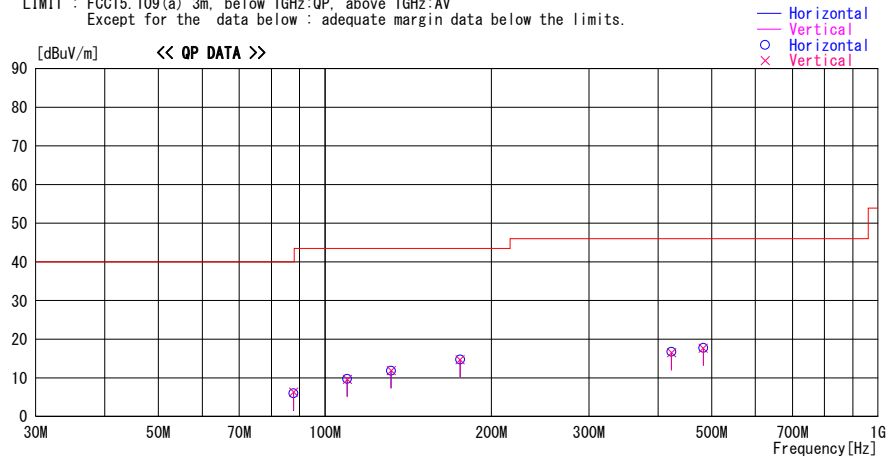

Frequency [MHz]	Reading [dBuV]	DET	Antenna	Loss&	Level	Angle	Height	Polar.	Limit	Margin	Comment
			Factor [dB/m]	Gain [dB]							
87.795	22.4	QP	8.1	-24.2	6.3	0	100	Vert.	40.0	33.7	
87.795	22.1	QP	8.1	-24.2	6.0	0	300	Hori.	40.0	34.0	
109.743	22.1	QP	11.4	-23.9	9.6	0	100	Vert.	43.5	33.9	
109.743	22.2	QP	11.4	-23.9	9.7	0	300	Hori.	43.5	33.8	
131.692	21.7	QP	13.9	-23.7	11.9	0	100	Vert.	43.5	31.6	
131.692	21.6	QP	13.9	-23.7	11.8	0	300	Hori.	43.5	31.7	
175.589	21.6	QP	16.2	-23.1	14.7	0	100	Vert.	43.5	28.8	
175.589	21.6	QP	16.2	-23.1	14.7	0	300	Hori.	43.5	28.8	
423.200	21.7	QP	16.2	-21.2	16.7	0	100	Hori.	46.0	29.3	
423.200	21.5	QP	16.2	-21.2	16.5	0	100	Vert.	46.0	29.5	
482.871	21.2	QP	17.3	-20.8	17.7	0	100	Vert.	46.0	28.3	
482.871	21.2	QP	17.3	-20.8	17.7	0	100	Hori.	46.0	28.3	

CHART : WITH FACTOR ANT TYPE: -30 MHz: LOOP, 30 MHz - 200 MHz: BICONICAL, 200 MHz - 1000 MHz: LOGPERIODIC, 1000 MHz--: HORN
CALCULATION : RESULT = READING + ANT FACTOR + LOSS & GAIN (CABLE + ATTEN - GAIN(AMP))

*The limit is rounded down to one decimal place.
*The test result is rounded off to one or two decimal places, so some differences might be observed.

Radiated Emission (Reference data)
TPMS (433.9MHz) Variation No. 4 External Antenna
(Above 1GHz)

DATA OF RADIATED EMISSION TEST

UL Japan, Inc. Head Office EMC Lab. No.3 Semi Anechoic Chamber
Date : 2017/03/27

Report No. : 11695037H
Temp./Humi. : 23deg.C. / 34% RH
Engineer : Hiroyuki Furutaka

Mode / Remarks : TPMS Receiving

LIMIT : FCC15.109(a) 3m, below 1GHz:QP, above 1GHz:PK
FCC15.109(a) 3m, below 1GHz:QP, above 1GHz:AV

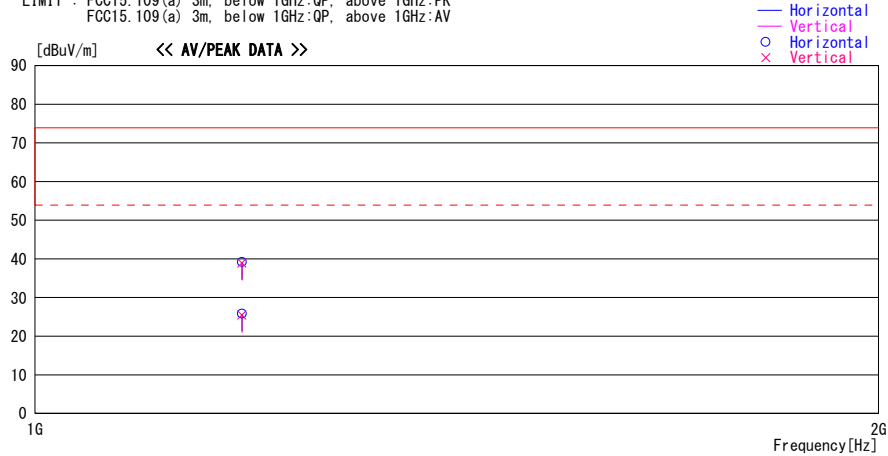

Frequency [MHz]	Reading [dBuV]	DET	Antenna	Loss&	Level	Angle	Height	Polar.	Limit	Margin	Comment
			Factor	Gain							
			[dB/m]	[dB]	[dBuV/m]	[Deg]	[cm]		[dBuV/m]	[dB]	
1185.230	44.7	PK	24.2	-29.7	39.2	0	100	Hori.	73.9	34.7	
1185.230	44.5	PK	24.2	-29.7	39.0	0	100	Vert.	73.9	34.9	
1185.230	31.3	AV	24.2	-29.7	25.8	0	100	Hori.	53.9	28.1	
1185.230	31.0	AV	24.2	-29.7	25.5	0	100	Vert.	53.9	28.4	

CHART: WITH FACTOR ANT TYPE: -30 MHz: LOOP, 30 MHz - 200 MHz: BICONICAL, 200 MHz - 1000 MHz: LOGPERIODIC, 1000 MHz-: HORN
CALCULATION : RESULT = READING + ANT FACTOR + LOSS & GAIN (CABLE - GAIN(AMP) + D. FACTOR)

*The limit is rounded down to one decimal place.
*The test result is rounded off to one or two decimal places, so some differences might be observed.

Radiated Emission (Reference data)
TPMS (433.9MHz) Variation No. 7 External Antenna
(Below 1GHz)

DATA OF RADIATED EMISSION TEST

UL Japan, Inc. Ise EMC Lab. No.3 Semi Anechoic Chamber
Date : 2017/03/29

Report No. : 11695037H
Temp./Humi. : 23deg.C. / 25% RH
Engineer : Tomoki Matsui

Mode / Remarks : TPMS Receiving

LIMIT : FCC15.109(a) 3m, below 1GHz:QP, above 1GHz:AV
Except for the data below : adequate margin data below the limits.

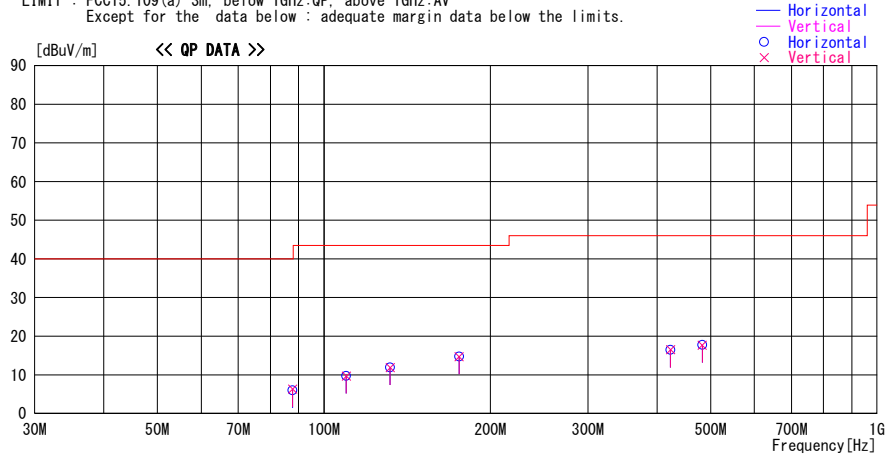

Frequency [MHz]	Reading [dBuV]	DET	Antenna	Loss&	Level	Angle	Height	Polar.	Limit	Margin	Comment
			Factor [dB/m]	Gain [dB]							
87.795	22.4	QP	8.1	-24.2	6.3	0	100	Vert.	40.0	33.7	
87.795	22.1	QP	8.1	-24.2	6.0	0	300	Hori.	40.0	34.0	
109.743	22.2	QP	11.4	-23.9	9.7	0	100	Vert.	43.5	33.8	
109.743	22.2	QP	11.4	-23.9	9.7	0	300	Hori.	43.5	33.8	
131.692	21.7	QP	13.9	-23.7	11.9	0	100	Vert.	43.5	31.6	
131.692	21.7	QP	13.9	-23.7	11.9	0	300	Hori.	43.5	31.6	
175.589	21.6	QP	16.2	-23.1	14.7	0	100	Vert.	43.5	28.8	
175.589	21.6	QP	16.2	-23.1	14.7	0	300	Hori.	43.5	28.8	
423.200	21.5	QP	16.2	-21.2	16.5	0	100	Hori.	46.0	29.5	
423.200	21.5	QP	16.2	-21.2	16.5	0	100	Vert.	46.0	29.5	
482.871	21.2	QP	17.3	-20.8	17.7	0	100	Vert.	46.0	28.3	
482.871	21.2	QP	17.3	-20.8	17.7	0	100	Hori.	46.0	28.3	

CHART: WITH FACTOR ANT TYPE: -30 MHz: LOOP, 30 MHz - 200 MHz: BICONICAL, 200 MHz - 1000 MHz: LOGPERIODIC, 1000 MHz-: HORN
CALCULATION : RESULT = READING + ANT FACTOR + LOSS & GAIN(CABLE + ATTEN - GAIN(AMP))

*The limit is rounded down to one decimal place.
*The test result is rounded off to one or two decimal places, so some differences might be observed.

Radiated Emission (Reference data)
TPMS (433.9MHz) Variation No. 7 External Antenna
(Above 1GHz)

DATA OF RADIATED EMISSION TEST

UL Japan, Inc. Head Office EMC Lab. No.3 Semi Anechoic Chamber
Date : 2017/03/27

Report No. : 11695037H
Temp./Humi. : 23deg.C. / 34% RH
Engineer : Hiroyuki Furutaka

Mode / Remarks : TPMS Receiving

LIMIT : FCC15.109(a) 3m, below 1GHz:QP, above 1GHz:PK
FCC15.109(a) 3m, below 1GHz:QP, above 1GHz:AV

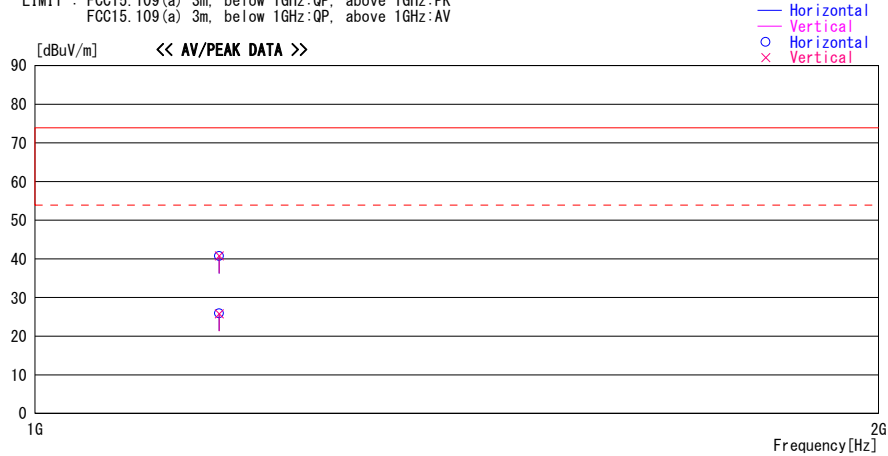

Frequency [MHz]	Reading [dBuV]	DET	Antenna	Loss&	Level	Angle	Height	Polar.	Limit	Margin	Comment
			Factor	Gain							
			[dB/m]	[dB]	[dBuV/m]	[Deg]	[cm]		[dBuV/m]	[dB]	
1163.282	46.3	PK	24.1	-29.7	40.7	0	100	Hori.	73.9	33.2	
1163.282	46.4	PK	24.1	-29.7	40.8	0	100	Vert.	73.9	33.1	
1163.282	31.5	AV	24.1	-29.7	25.9	0	100	Hori.	53.9	28.0	
1163.282	31.4	AV	24.1	-29.7	25.8	0	100	Vert.	53.9	28.1	

CHART : WITH FACTOR ANT TYPE: -30 MHz: LOOP, 30 MHz - 200 MHz: BICONICAL, 200 MHz - 1000 MHz: LOGPERIODIC, 1000 MHz-: HORN
CALCULATION : RESULT = READING + ANT FACTOR + LOSS & GAIN (CABLE - GAIN(AMP) + D.FACTOR)

*The limit is rounded down to one decimal place.
*The test result is rounded off to one or two decimal places, so some differences might be observed.

Radiated Emission (Reference data)
TPMS (433.9MHz) Variation No. 11 External Antenna
(Below 1GHz)

DATA OF RADIATED EMISSION TEST

UL Japan, Inc. Head Office EMC Lab. No.3 Semi Anechoic Chamber
Date : 2017/03/27

Report No. : 11695037H
Temp./Humi. : 23deg.C. / 34% RH
Engineer : Hiroyuki Furutaka

Mode / Remarks : TPMS Receiving

LIMIT : FCC15.109(a) 3m. below 1GHz:QP, above 1GHz:AV
Except for the data below : adequate margin data below the limits.

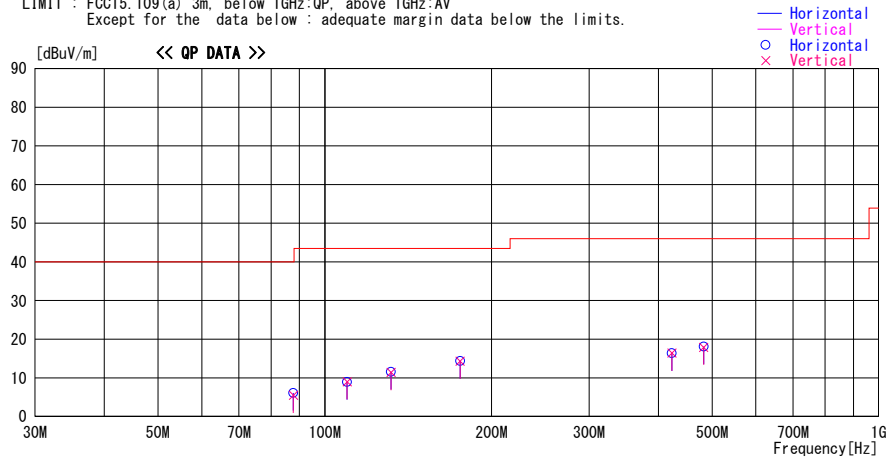

Frequency [MHz]	Reading [dBuV]	DET	Antenna	Loss&	Level	Angle	Height	Polar.	Limit	Margin	Comment
			Factor	Gain							
			[dB/m]	[dB]	[dBuV/m]	[Deg]	[cm]		[dBuV/m]	[dB]	
87.795	21.6	QP	8.1	-24.2	5.5	0	100	Vert.	40.0	34.5	
87.795	22.2	QP	8.1	-24.2	6.1	0	300	Hori.	40.0	33.9	
109.743	21.4	QP	11.4	-23.9	8.9	0	300	Hori.	43.5	34.6	
109.743	21.5	QP	11.4	-23.9	9.0	0	100	Vert.	43.5	34.5	
131.692	21.2	QP	13.9	-23.7	11.4	0	100	Vert.	43.5	32.1	
131.692	21.4	QP	13.9	-23.7	11.6	0	300	Hori.	43.5	31.9	
175.589	21.2	QP	16.2	-23.1	14.3	0	100	Vert.	43.5	29.2	
175.589	21.3	QP	16.2	-23.1	14.4	0	300	Hori.	43.5	29.1	
423.200	21.4	QP	16.2	-21.2	16.4	0	100	Vert.	46.0	29.6	
423.200	21.4	QP	16.2	-21.2	16.4	0	100	Hori.	46.0	29.6	
482.871	21.4	QP	17.3	-20.8	17.9	0	100	Vert.	46.0	28.1	
482.871	21.6	QP	17.3	-20.8	18.1	0	100	Hori.	46.0	27.9	

CHART: WITH FACTOR ANT TYPE: -30 MHz: LOOP, 30 MHz - 200 MHz: BICONICAL, 200 MHz - 1000 MHz: LOGPERIODIC, 1000 MHz-: HORN
CALCULATION : RESULT = READING + ANT FACTOR + LOSS & GAIN (CABLE + ATTEN - GAIN (AMP))

*The limit is rounded down to one decimal place.
*The test result is rounded off to one or two decimal places, so some differences might be observed.

Radiated Emission (Reference data)
TPMS (433.9MHz) Variation No. 11 External Antenna
(Above 1GHz)

DATA OF RADIATED EMISSION TEST

UL Japan, Inc. Head Office EMC Lab. No.3 Semi Anechoic Chamber
Date : 2017/03/27

Report No. : 11695037H
Temp./Humi. : 23deg.C. / 34% RH
Engineer : Hiroyuki Furutaka

Mode / Remarks : TPMS Receiving

LIMIT : FCC15.109(a) 3m, below 1GHz:QP, above 1GHz:PK
FCC15.109(a) 3m, below 1GHz:QP, above 1GHz:AV

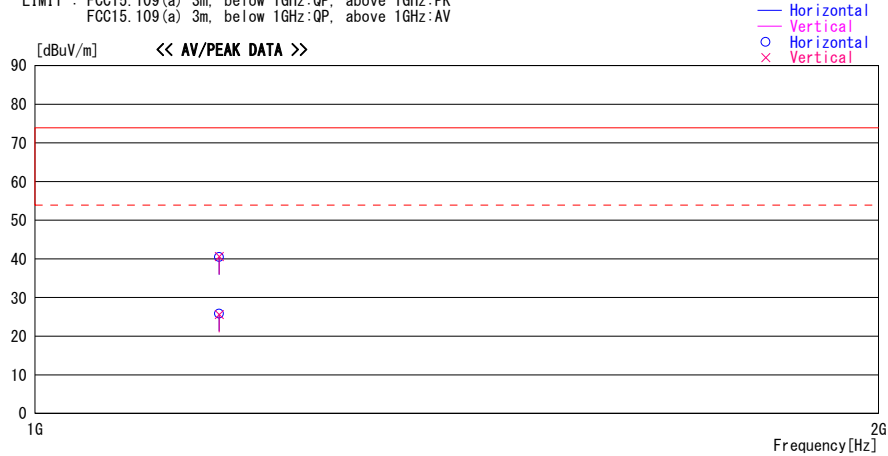

Frequency [MHz]	Reading [dBuV]	DET	Antenna	Loss&	Level	Angle	Height	Polar.	Limit	Margin	Comment
			Factor	Gain							
			[dB/m]	[dB]	[dBuV/m]	[Deg]	[cm]		[dBuV/m]	[dB]	
1163.282	46.1	PK	24.1	-29.7	40.5	0	100	Hori.	73.9	33.4	
1163.282	46.2	PK	24.1	-29.7	40.6	0	100	Vert.	73.9	33.3	
1163.282	31.4	AV	24.1	-29.7	25.8	0	100	Hori.	53.9	28.1	
1163.282	31.2	AV	24.1	-29.7	25.6	0	100	Vert.	53.9	28.3	

CHART: WITH FACTOR ANT TYPE: -30 MHz: LOOP, 30 MHz - 200 MHz: BICONICAL, 200 MHz - 1000 MHz: LOGPERIODIC, 1000 MHz--: HORN
CALCULATION : RESULT = READING + ANT FACTOR + LOSS & GAIN (CABLE - GAIN(AMP) + D.FACTOR)

*The limit is rounded down to one decimal place.
*The test result is rounded off to one or two decimal places, so some differences might be observed.

Radiated Emission (Reference data)
TPMS (433.9MHz) Variation No. 15 External Antenna
(Below 1GHz)

DATA OF RADIATED EMISSION TEST

UL Japan, Inc. Head Office EMC Lab. No.3 Semi Anechoic Chamber
Date : 2017/03/27

Report No. : 11695037H
Temp./Humi. : 23deg.C. / 34% RH
Engineer : Hiroyuki Furutaka

Mode / Remarks : TPMS Receiving

LIMIT : FCC15.109(a) 3m, below 1GHz:QP, above 1GHz:AV
Except for the data below : adequate margin data below the limits.

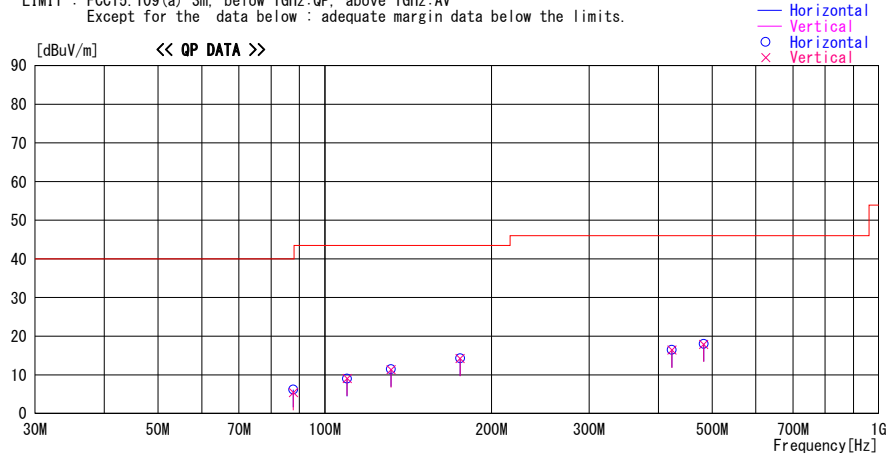

Frequency [MHz]	Reading [dBuV]	DET	Antenna	Loss&	Level	Angle	Height	Polar.	Limit	Margin	Comment
			Factor	Gain							
			[dB/m]	[dB]	[dBuV/m]	[Deg]	[cm]		[dBuV/m]	[dB]	
87.795	21.5	QP	8.1	-24.2	5.4	0	100	Vert.	40.0	34.6	
87.795	22.3	QP	8.1	-24.2	6.2	0	300	Hori.	40.0	33.8	
109.743	21.5	QP	11.4	-23.9	9.0	0	300	Hori.	43.5	34.5	
109.743	21.6	QP	11.4	-23.9	9.1	0	100	Vert.	43.5	34.4	
131.692	21.1	QP	13.9	-23.7	11.3	0	100	Vert.	43.5	32.2	
131.692	21.3	QP	13.9	-23.7	11.5	0	300	Hori.	43.5	32.0	
175.589	21.1	QP	16.2	-23.1	14.2	0	100	Vert.	43.5	29.3	
175.589	21.2	QP	16.2	-23.1	14.3	0	300	Hori.	43.5	29.2	
423.200	21.4	QP	16.2	-21.2	16.4	0	100	Vert.	46.0	29.6	
423.200	21.5	QP	16.2	-21.2	16.5	0	100	Hori.	46.0	29.5	
482.871	21.4	QP	17.3	-20.8	17.9	0	100	Vert.	46.0	28.1	
482.871	21.5	QP	17.3	-20.8	18.0	0	100	Hori.	46.0	28.0	

CHART: WITH FACTOR ANT TYPE: -30 MHz: LOOP, 30 MHz - 200 MHz: BICONICAL, 200 MHz - 1000 MHz: LOGPERIODIC, 1000 MHz-: HORN
CALCULATION : RESULT = READING + ANT FACTOR + LOSS & GAIN(CABLE + ATTEN - GAIN(AMP))

*The limit is rounded down to one decimal place.
*The test result is rounded off to one or two decimal places, so some differences might be observed.

Radiated Emission (Reference data)
TPMS (433.9MHz) Variation No. 15 External Antenna
(Above 1GHz)

DATA OF RADIATED EMISSION TEST

UL Japan, Inc. Head Office EMC Lab. No.3 Semi Anechoic Chamber
Date : 2017/03/27

Report No. : 11695037H
Temp./Humi. : 23deg.C. / 34% RH
Engineer : Hiroyuki Furutaka

Mode / Remarks : TPMS Receiving

LIMIT : FCC15.109(a) 3m, below 1GHz:QP, above 1GHz:PK
FCC15.109(a) 3m, below 1GHz:QP, above 1GHz:AV

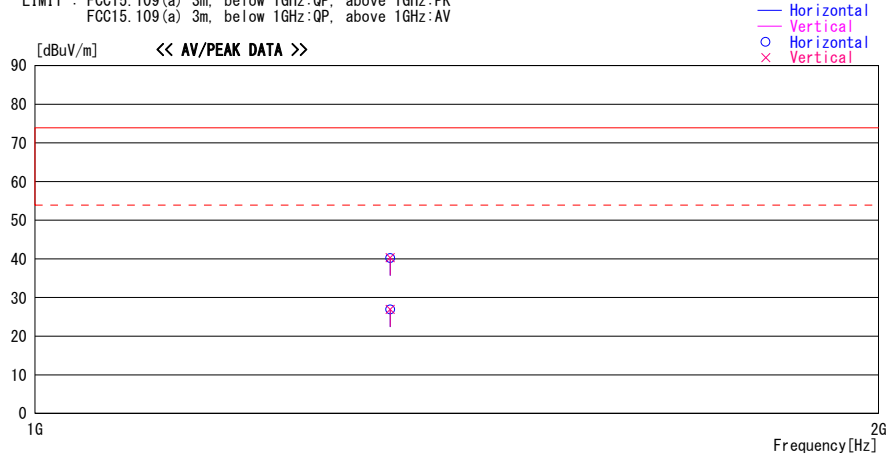

Frequency [MHz]	Reading [dBuV]	DET	Antenna	Loss&	Level	Angle	Height	Polar.	Limit	Margin	Comment
			Factor	Gain							
			[dB/m]	[dB]	[dBuV/m]	[Deg]	[cm]		[dBuV/m]	[dB]	
1338.871	44.6	PK	24.7	-29.1	40.2	0	100	Hori.	73.9	33.7	
1338.871	44.7	PK	24.7	-29.1	40.3	0	100	Vert.	73.9	33.6	
1338.871	31.3	AV	24.7	-29.1	26.9	0	100	Hori.	53.9	27.0	
1338.871	31.4	AV	24.7	-29.1	27.0	0	100	Vert.	53.9	26.9	

CHART: WITH FACTOR ANT TYPE: -30 MHz: LOOP, 30 MHz - 200 MHz: BICONICAL, 200 MHz - 1000 MHz: LOGPERIODIC, 1000 MHz-: HORN
CALCULATION : RESULT = READING + ANT FACTOR + LOSS & GAIN (CABLE - GAIN(AMP) + D. FACTOR)

*The limit is rounded down to one decimal place.
*The test result is rounded off to one or two decimal places, so some differences might be observed.

APPENDIX 2: Test instruments

EMI test equipment

Control No.	Instrument	Manufacturer	Model No	Serial No	Test Item	Calibration Date * Interval(month)
MAEC-03	Semi Anechoic Chamber(NSA)	TDK	Semi Anechoic Chamber 3m	DA-10005	RE	2016/10/20 * 12
MOS-13	Thermo-Hygrometer	Custom	CTH-180	1301	RE	2017/01/20 * 12
MJM-16	Measure	KOMELON	KMC-36	-	RE	-
COTS-MEMI	EMI measurement program	TSJ	TEPTO-DV	-	RE	-
MRENT-126	Spectrum Analyzer	KEYSIGHT	E4440A	MY46185516	RE	2016/07/01 * 12
MHA-20	Horn Antenna 1-18GHz	Schwarzbeck	BBHA9120D	258	RE	2016/05/29 * 12
MCC-167	Microwave Cable	Junkosha	MWX221	1404S374(1m) / 1405S074(5m)	RE	2016/05/20 * 12
MPA-11	MicroWave System Amplifier	Agilent	83017A	MY39500779	RE	2017/03/21 * 12
MMM-08	DIGITAL HiTESTER	Hioki	3805	051201197	RE	2017/01/19 * 12
MTR-08	Test Receiver	Rohde & Schwarz	ESCI	100767	RE	2016/09/15 * 12
MBA-03	Biconical Antenna	Schwarzbeck	BBA9106	1915	RE	2016/10/15 * 12
MLA-22	Logperiodic Antenna(200-1000MHz)	Schwarzbeck	VUSLP9111B	911B-191	RE	2017/01/26 * 12
MCC-51	Coaxial cable	UL Japan	-	-	RE	2016/07/26 * 12
MAT-98	Attenuator	KEYSIGHT	8491A	MY52462349	RE	2016/12/05 * 12
MPA-13	Pre Amplifier	SONOMA INSTRUMENT	310	260834	RE	2017/03/27 * 12
MAEC-01	Semi Anechoic Chamber(NSA)	TDK	Semi Anechoic Chamber 10m	DA-06881	AT	2016/09/30 * 12
MOS-27	Thermo-Hygrometer	CUSTOM	CTH-201	A08Q26	AT	2017/01/20 * 12
MJM-25	Measure	KOMELON	KMC-36	-	AT	-
MPA-01	Pre Amplifier	Agilent	8449B	3008A01671	AT	2017/02/03 * 12
MCC-141	Microwave Cable	Junkosha	MWX221	1305S002R(1m) / 1405S146(5m)	AT	2016/06/21 * 12
MMM-03	Digital Tester	Fluke	FLUKE 26-3	78030621	AT	2016/08/23 * 12
MAT-20	Attenuator(10dB)(above 1GHz)	HIROSE ELECTRIC CO.,LTD.	AT-110	-	AT	2016/12/15 * 12
MAEC-05	Semi Anechoic Chamber(Unifomity)	TDK	Semi Anechoic Chamber		AT	
MCC-52	Coaxial cable	UL Japan	-	-	AT	2017/02/22 * 12
MAT-10	Attenuator(10dB)	Weinschel Corp	2	BL1173	AT	2016/11/28 * 12
MSA-15	Spectrum Analyzer	Agilent	E4440A	MY46187105	AT	2016/10/13 * 12
MPA-14	Pre Amplifier	SONOMA INSTRUMENT	310	260833	AT	2017/03/27 * 12

The expiration date of the calibration is the end of the expired month.

All equipment is calibrated with valid calibrations. Each measurement data is traceable to the national or international standards.

As for some calibrations performed after the tested dates, those test equipment have been controlled by means of an unbroken chains of calibrations.

Test Item:

RE: Radiated emission

AT: Antenna Terminal

UL Japan, Inc.

Ise EMC Lab.

4383-326 Asama-cho, Ise-shi, Mie-ken 516-0021 JAPAN

Telephone : +81 596 24 8999

Facsimile : +81 596 24 8124