



RADIO TEST REPORT

Test Report No. : 13035531H-R1

Applicant : DENSO CORPORATION
Type of Equipment : Smart Card Key
Model No. : 14CGM
FCC ID : HYQ14CGM
Test regulation : FCC Part 15 Subpart C: 2019
Test Result : Complied (Refer to SECTION 3.2)

1. This test report shall not be reproduced in full or partial, without the written approval of UL Japan, Inc.
2. The results in this report apply only to the sample tested.
3. This sample tested is in compliance with above regulation.
4. The test results in this report are traceable to the national or international standards.
5. This test report covers Radio technical requirements. It does not cover administrative issues such as Manual or non-Radio test related Requirements. (if applicable)
6. The all test items in this test report are conducted by UL Japan, Inc. Ise EMC Lab.
7. This test report must not be used by the customer to claim product certification, approval, or endorsement by NVLAP, NIST, or any agency of the Federal Government.
8. The information provided from the customer for this report is identified in SECTION 1.
9. This report is a revised version of 13035531H. 13035531H is replaced with this report.

Date of test: September 25 and 26, 2019

Representative test engineer: 
Akihiko Maeda
Engineer
Consumer Technology Division

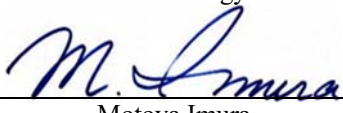
Approved by: 
Motoya Imura
Leader
Consumer Technology Division



This laboratory is accredited by the NVLAP LAB CODE 200572-0, U.S.A. The tests reported herein have been performed in accordance with its terms of accreditation. *As for the range of Accreditation in NVLAP, you may refer to the WEB address, http://japan.ul.com/resources/emc_accredited/

- The testing in which "Non-accreditation" is displayed is outside the accreditation scopes in UL Japan.
 There is no testing item of "Non-accreditation".

UL Japan, Inc.
Ise EMC Lab.

4383-326 Asama-cho, Ise-shi, Mie-ken 516-0021 JAPAN
Telephone : +81 596 24 8999
Facsimile : +81 596 24 8124

REVISION HISTORY

Original Test Report No.: 13035531H

Revision	Test report No.	Date	Page revised	Contents
- (Original)	13035531H	October 7, 2019	-	-
1	13035531H-R1	October 10, 2019	P.10	Correction of “List of cables used” in Clause 4.2

UL Japan, Inc.

Ise EMC Lab.

4383-326 Asama-cho, Ise-shi, Mie-ken 516-0021 JAPAN

Telephone : +81 596 24 8999

Facsimile : +81 596 24 8124

Reference: Abbreviations (Including words undescribed in this report)

A2LA	The American Association for Laboratory Accreditation	MCS	Modulation and Coding Scheme
AC	Alternating Current	MRA	Mutual Recognition Arrangement
AFH	Adaptive Frequency Hopping	N/A	Not Applicable
AM	Amplitude Modulation	NIST	National Institute of Standards and Technology
Amp, AMP	Amplifier	NS	No signal detect.
ANSI	American National Standards Institute	NSA	Normalized Site Attenuation
Ant, ANT	Antenna	NVLAP	National Voluntary Laboratory Accreditation Program
AP	Access Point	OBW	Occupied Band Width
ASK	Amplitude Shift Keying	OFDM	Orthogonal Frequency Division Multiplexing
Atten., ATT	Attenuator	P/M	Power meter
AV	Average	PCB	Printed Circuit Board
BPSK	Binary Phase-Shift Keying	PER	Packet Error Rate
BR	Bluetooth Basic Rate	PHY	Physical Layer
BT	Bluetooth	PK	Peak
BT LE	Bluetooth Low Energy	PN	Pseudo random Noise
BW	BandWidth	PRBS	Pseudo-Random Bit Sequence
Cal Int	Calibration Interval	PSD	Power Spectral Density
CCK	Complementary Code Keying	QAM	Quadrature Amplitude Modulation
Ch., CH	Channel	QP	Quasi-Peak
CISPR	Comite International Special des Perturbations Radioelectriques	QPSK	Quadri-Phase Shift Keying
CW	Continuous Wave	RBW	Resolution Band Width
DBPSK	Differential BPSK	RDS	Radio Data System
DC	Direct Current	RE	Radio Equipment
D-factor	Distance factor	RF	Radio Frequency
DFS	Dynamic Frequency Selection	RMS	Root Mean Square
DQPSK	Differential QPSK	RSS	Radio Standards Specifications
DSSS	Direct Sequence Spread Spectrum	Rx	Receiving
EDR	Enhanced Data Rate	SA, S/A	Spectrum Analyzer
EIRP, e.i.r.p.	Equivalent Isotropically Radiated Power	SG	Signal Generator
EMC	ElectroMagnetic Compatibility	SVSWR	Site-Voltage Standing Wave Ratio
EMI	ElectroMagnetic Interference	TR	Test Receiver
EN	European Norm	Tx	Transmitting
ERP, e.r.p.	Effective Radiated Power	VBW	Video BandWidth
EU	European Union	Vert.	Vertical
EUT	Equipment Under Test	WLAN	Wireless LAN
Fac.	Factor		
FCC	Federal Communications Commission		
FHSS	Frequency Hopping Spread Spectrum		
FM	Frequency Modulation		
Freq.	Frequency		
FSK	Frequency Shift Keying		
GFSK	Gaussian Frequency-Shift Keying		
GNSS	Global Navigation Satellite System		
GPS	Global Positioning System		
Hori.	Horizontal		
ICES	Interference-Causing Equipment Standard		
IEC	International Electrotechnical Commission		
IEEE	Institute of Electrical and Electronics Engineers		
IF	Intermediate Frequency		
ILAC	International Laboratory Accreditation Conference		
ISED	Innovation, Science and Economic Development Canada		
ISO	International Organization for Standardization		
JAB	Japan Accreditation Board		
LAN	Local Area Network		
LIMS	Laboratory Information Management System		

UL Japan, Inc.

Ise EMC Lab.

4383-326 Asama-cho, Ise-shi, Mie-ken 516-0021 JAPAN

Telephone : +81 596 24 8999

Facsimile : +81 596 24 8124

CONTENTS	PAGE
SECTION 1: Customer information.....	5
SECTION 2: Equipment under test (E.U.T.).....	5
SECTION 3: Test specification, procedures & results.....	6
SECTION 4: Operation of E.U.T. during testing.....	9
SECTION 5: Radiated emission (Electric Field Strength of Fundamental and Spurious Emission)..	11
SECTION 6: Automatically deactivate	13
SECTION 7: -20 dB and 99 % Occupied Bandwidth	13
APPENDIX 1: Test data	14
Automatically deactivate.....	14
Radiated Emission (Electric Field Strength of Fundamental and Spurious Emission).....	15
-20dB and 99% Occupied Bandwidth.....	18
APPENDIX 2: Test instruments	20
APPENDIX 3: Photographs of test setup	21
Radiated emission	21
Worst case position	23

SECTION 1: Customer information

Company Name : DENSO CORPORATION
Address : 1-1, Showa-cho, Kariya-shi, Aichi-ken, 448-8661, Japan
Telephone Number : +81-566-20-3955
Facsimile Number : +81-566-25-4837
Contact Person : TAKAYUKI HATTORI

The information provided from the customer is as follows;

- Applicant, Type of Equipment, Model No. FCC ID on the cover and other relevant pages
- Operating/Test Mode(s) (Mode(s)) on all the relevant pages
- SECTION 1: Customer information
- SECTION 2: Equipment under test (E.U.T.)
- SECTION 4: Operation of E.U.T. during testing

* The laboratory is exempted from liability of any test results affected from the above information in SECTION 2 and 4.

SECTION 2: Equipment under test (E.U.T.)

2.1 Identification of E.U.T.

Type of Equipment : Smart Card Key
Model No. : 14CGM
Serial No. : Refer to Section 4, Clause 4.2
Rating : DC 3.0 V
Receipt Date of Sample : September 12, 2019
(Information from test lab.)
Country of Mass-production : Japan, China and United States of America
Condition of EUT : Production prototype
(Not for Sale: This sample is equivalent to mass-produced items.)
Modification of EUT : No Modification by the test lab

2.2 Product Description

Model: 14CGM (referred to as the EUT in this report) is a Smart Card Key.

Radio Specification

Radio Type : Transceiver
Frequency of Operation : 315.10 MHz / 314.35 MHz*
*These two different frequencies are not emitted simultaneously.
Modulation : FSK (F1D)
Type of Battery : One lithium battery
Antenna type : Built-in type (Fixed)
Clock frequency (Maximum) : 18.370 MHz Crystal

Radio Type : Receiver
Frequency of Operation : 134.2 kHz *1)

*1) The test of receiver part was performed separately from this test report, and the conformability is confirmed.

SECTION 3: Test specification, procedures & results

3.1 Test Specification

Test Specification : FCC Part 15 Subpart C
FCC Part 15 final revised on July 19, 2019 and effective August 19, 2019 except 15.258

Title : FCC 47CFR Part15 Radio Frequency Device Subpart C Intentional Radiators
Section 15.231 Periodic operation in the band 40.66-40.70 MHz and above 70 MHz.

3.2 Procedures and results

Item	Test Procedure	Specification	Worst margin	Results	Remarks
Conducted emission	FCC: ANSI C63.10:2013 6 Standard test methods ----- ISED: RSS-Gen 8.8	FCC: Section 15.207 ----- ISED: RSS-Gen 8.8	N/A	N/A	*1)
Automatically Deactivate	FCC: ANSI C63.10:2013 6 Standard test methods ----- ISED: -	FCC: Section 15.231(a)(1) ----- ISED: RSS-210 A1.1	N/A	Complied a)	Radiated
Electric Field Strength of Fundamental Emission	FCC: ANSI C63.10:2013 6 Standard test methods ----- ISED: RSS-Gen 6.12	FCC: Section 15.231(b) ----- ISED: RSS-210 A1.2	10.8 dB 315.10 MHz / 314.35 MHz, Horizontal PK with Duty factor	Complied b)	Radiated
Electric Field Strength of Spurious Emission	FCC: ANSI C63.10:2013 6 Standard test methods ----- ISED: RSS-Gen 6.13	FCC: Section 15.205 Section 15.209 Section 15.231(b) ----- ISED: RSS-210 A1.2, 4.4 RSS-Gen 8.9	6.1 dB 2835.900 MHz Horizontal PK with Duty factor <315.10 MHz>	Complied b)	Radiated
-20dB Bandwidth	FCC: ANSI C63.10:2013 6 Standard test methods ----- ISED: -	FCC: Section 15.231(c) ----- ISED: Reference data	N/A	Complied c)	Radiated

Note: UL Japan, Inc.'s EMI Work Procedures No. 13-EM-W0420 and 13-EM-W0422.

*1) The test is not applicable since the EUT does not have AC Mains.

a) Refer to APPENDIX 1 (data of Automatically deactivate)

b) Refer to APPENDIX 1 (data of Radiated Emission (Electric Field Strength of Fundamental and Spurious Emission))

c) Refer to APPENDIX 1 (data of -20dB and 99% Occupied Bandwidth)

Symbols:

Complied The data of this test item has enough margin, more than the measurement uncertainty.

Complied# The data of this test item meets the limits unless the measurement uncertainty is taken into consideration.

FCC Part 15.31 (e)

This test was performed with the New Battery (DC 3.0 V) and the constant voltage was supplied to the EUT during the tests. Therefore, the EUT complies with the requirement.

FCC Part 15.203 Antenna requirement

It is impossible for end users to replace the antenna, because the antenna is mounted inside of the EUT. Therefore, the equipment complies with the antenna requirement of Section 15.203.

UL Japan, Inc.

Ise EMC Lab.

4383-326 Asama-cho, Ise-shi, Mie-ken 516-0021 JAPAN

Telephone : +81 596 24 8999

Facsimile : +81 596 24 8124

3.3 Addition to standard

Item	Test Procedure	Specification	Worst margin	Results	Remarks
99 % Occupied Bandwidth	ISED: RSS-Gen 6.7	ISED: RSS-210 A1.3	N/A	-	Radiated
Note: UL Japan, Inc.'s EMI Work Procedures No. 13-EM-W0420 and 13-EM-W0422.					

Other than above, no addition, exclusion nor deviation has been made from the standard.

3.4 Uncertainty

There is no applicable rule of uncertainty in this applied standard. Therefore, the following results are derived depending on whether or not laboratory uncertainty is applied.

The following uncertainties have been calculated to provide a confidence level of 95 % using a coverage factor $k = 2$.

Polarity	Radiated emission (Below 1 GHz)			
	(3 m*)(+/-)		(10 m*)(+/-)	
	30 MHz to 200 MHz	200 MHz to 1000 MHz	30 MHz to 200 MHz	200 MHz to 1000 MHz
Horizontal	4.8 dB	5.2 dB	4.8 dB	5.0 dB
Vertical	5.0 dB	6.3 dB	4.9 dB	5.0 dB

Radiated emission (Above 1 GHz)				
(3 m*)(+/-)		(1 m*)(+/-)		(10 m*)(+/-)
1 GHz to 6 GHz	6 GHz to 18 GHz	10 GHz to 26.5 GHz	26.5 GHz to 40 GHz	1 GHz to 18 GHz
5.0 dB	5.3 dB	5.8 dB	5.8 dB	5.2 dB

* Measurement distance

Automatically Deactivate
0.10 %

Bandwidth
0.96 %

3.5 Test Location

UL Japan, Inc. Ise EMC Lab.

*NVLAP Lab. code: 200572-0 / FCC Test Firm Registration Number: 199967 / ISED Lab Company Number: 2973C

4383-326 Asama-cho, Ise-shi, Mie-ken 516-0021 JAPAN

Telephone: +81 596 24 8999, Facsimile: +81 596 24 8124

Test site	Width x Depth x Height (m)	Size of reference ground plane (m) / horizontal conducting plane	Other rooms	Maximum measurement distance
No.1 semi-anechoic chamber	19.2 x 11.2 x 7.7	7.0 x 6.0	No.1 Power source room	10 m
No.2 semi-anechoic chamber	7.5 x 5.8 x 5.2	4.0 x 4.0	-	3 m
No.3 semi-anechoic chamber	12.0 x 8.5 x 5.9	6.8 x 5.75	No.3 Preparation room	3 m
No.3 shielded room	4.0 x 6.0 x 2.7	N/A	-	-
No.4 semi-anechoic chamber	12.0 x 8.5 x 5.9	6.8 x 5.75	No.4 Preparation room	3 m
No.4 shielded room	4.0 x 6.0 x 2.7	N/A	-	-
No.5 semi-anechoic chamber	6.0 x 6.0 x 3.9	6.0 x 6.0	-	-
No.5 measurement room	6.4 x 6.4 x 3.0	6.4 x 6.4	-	-
No.6 shielded room	4.0 x 4.5 x 2.7	4.0 x 4.5	-	-
No.6 measurement room	4.75 x 5.4 x 3.0	4.75 x 4.15	-	-
No.7 shielded room	4.7 x 7.5 x 2.7	4.7 x 7.5	-	-
No.8 measurement room	3.1 x 5.0 x 2.7	3.1 x 5.0	-	-
No.9 measurement room	8.8 x 4.6 x 2.8	2.4 x 2.4	-	-
No.11 measurement room	6.2 x 4.7 x 3.0	4.8 x 4.6	-	-

* Size of vertical conducting plane (for Conducted Emission test) : 2.0 x 2.0 m for No.1, No.2, No.3, and No.4 semi-anechoic chambers and No.3 and No.4 shielded rooms.

3.6 Test data, Test instruments, and Test set up

Refer to APPENDIX.

UL Japan, Inc.

Ise EMC Lab.

4383-326 Asama-cho, Ise-shi, Mie-ken 516-0021 JAPAN

Telephone : +81 596 24 8999

Facsimile : +81 596 24 8124

SECTION 4: Operation of E.U.T. during testing

4.1 Operating Mode(s)

Test Item	Mode
Automatically Deactivate	Normal use mode, 315.10 MHz *1) Normal use mode, 314.35 MHz *1)
Electric Field Strength of Fundamental Emission Electric Field Strength of Spurious Emission -20dB & 99% Occupied Bandwidth	Transmitting mode (Tx), 315.10 MHz *2) Transmitting mode (Tx), 314.35 MHz *2)
* The system was configured in typical fashion (as a customer would normally use it) for testing. *1) The EUT transmits only when it receives 134.2 kHz radio signal. End users cannot change the settings of the output power of the product. *2) The software of this mode is the same as one of normal product, except that EUT continues to transmit when transmitter button is being pressed. This button was attached just for testing (for making continuous transmission).	

4.2 Configuration and peripherals

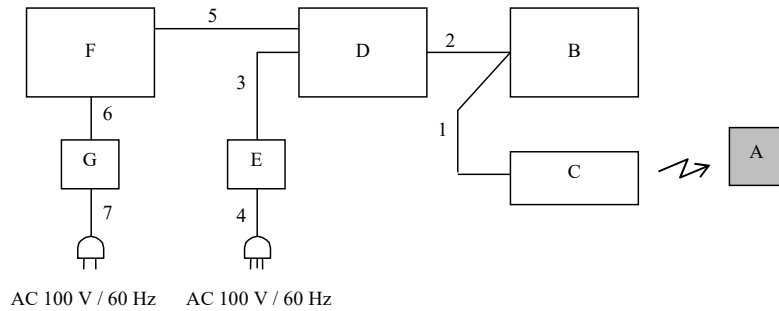

* Cabling and setup(s) were taken into consideration and test data was taken under worse case conditions.

Description of EUT and Support equipment

No.	Item	Model number	Serial number	Manufacturer	Remarks
A	Smart Card Key	14CGM	No.2 *1) No.1 *2)	DENSO CORPORATION	EUT
B	Jig Box	-	-	-	*1)
C	Door handle	-	-	-	*1)
D	Test Bench	-	-	DENSO CORPORATION	*1)
E	AC Adapter	PA1232	0016600	Microsystems	*1)
F	Laptop PC	PROBOOK	5CD909629B	hp	*1)
G	AC Adapter	856948-002	P0CGCBPMC1 0C	hp	*1)

*1) Used for Normal use mode

*2) Used for Transmitting mode

List of cables used

No.	Name	Length (m)	Shield		Remarks
			Cable	Connector	
1	Signal Cable	3.0	Unshielded	Unshielded	-
2	DC and Signal Cable	1.5	Unshielded	Unshielded	-
3	DC Cable	1.3	Unshielded	Unshielded	-
4	AC Cable	2.0	Unshielded	Unshielded	-
5	USB Cable	1.8	Shielded	Shielded	-
6	DC Cable	1.7	Unshielded	Unshielded	-
7	AC Cable	0.9	Unshielded	Unshielded	-

SECTION 5: Radiated emission (Electric Field Strength of Fundamental and Spurious Emission)

Test Procedure and conditions

[For below 30 MHz]

The noise level was checked by moving a search-coil (Loop Antenna) close to the EUT.

[For 30 MHz to 1 GHz]

EUT was placed on a urethane platform of nominal size, 0.5 m by 1.0 m, raised 0.8 m above the conducting ground plane. The Radiated Electric Field Strength has been measured in a Semi Anechoic Chamber with a ground plane.

[For above 1 GHz]

EUT was placed on a urethane platform of nominal size, 0.5 m by 0.5 m, raised 1.5 m above the conducting ground plane.

The Radiated Electric Field Strength has been measured in a Semi Anechoic Chamber with absorbent materials lined on a ground plane.

The measuring antenna height was varied between 1 and 4 m and EUT was rotated a full revolution in order to obtain the maximum value of the electric field strength.

Test antenna was aimed at the EUT for receiving the maximum signal and always kept within the illumination area of the 3 dB beamwidth of the antenna.

The measurements were performed for both vertical and horizontal antenna polarization.

The radiated emission measurements were made with the following detector function of the test receiver / spectrum analyzer.

Test Antennas are used as below;

Frequency	Below 30 MHz	30 MHz to 200 MHz	200 MHz to 1 GHz	Above 1 GHz
Antenna Type	Loop	Biconical	Logperiodic	Horn

	From 9 kHz to 90 kHz and From 110 kHz to 150 kHz	From 90 kHz to 110 kHz	From 150 kHz to 490 kHz	From 490 kHz to 30 MHz	From 30 MHz to 1 GHz	Above 1 GHz
Detector Type	Peak	Peak	Peak	Peak	Peak and Peak with Duty factor	Peak and Peak with Duty factor
IF Bandwidth	200 Hz	200 Hz	9.0 kHz	9.0 kHz	120 kHz	PK: S/A: RBW 1 MHz, VBW: 3 MHz

[Test Setup]

Below 1 GHz

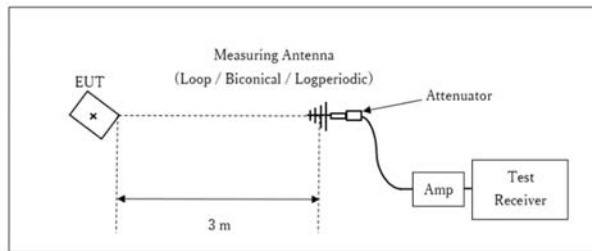

× : Center of turn table

Test Distance: 3 m

1 GHz - 10 GHz

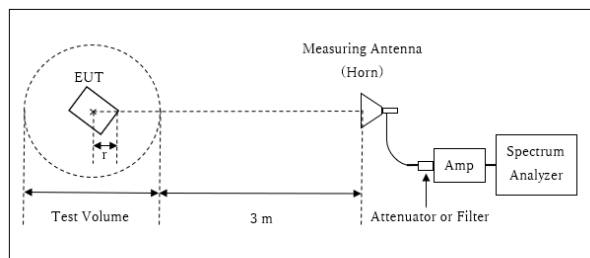

r : Radius of an outer periphery of EUT
 × : Center of turn table

Distance Factor: $20 \times \log(4.0 \text{ m} / 3.0 \text{ m}) = 2.5 \text{ dB}$

* Test Distance: $(3 + \text{Test Volume} / 2) - r = 4.0 \text{ m}$

Test Volume : 2.0 m

(Test Volume has been calibrated based on CISPR 16-1-4.)

r = 0.0 m

* The test was performed with r = 0.0 m since EUT is small and it was the rather conservative condition.

- The carrier level (or, noise levels) was (or were) measured at each position of all three axes X, Y and Z, and the position that has the maximum noise was determined.

Noise levels of all the frequencies were measured at the position.

This EUT has two modes which mechanical key is inserted or not. The worst case was confirmed with and without mechanical key, as a result, the test without mechanical key was the worst case. Therefore the test without mechanical key was performed only.

*The result is rounded off to the second decimal place, so some differences might be observed.

Measurement range : 9 kHz - 3.2 GHz
Test data : APPENDIX
Test result : Pass

UL Japan, Inc.

Ise EMC Lab.

4383-326 Asama-cho, Ise-shi, Mie-ken 516-0021 JAPAN

Telephone : +81 596 24 8999

Facsimile : +81 596 24 8124

SECTION 6: Automatically deactivate

Test Procedure

The measurement was performed with Electric field strength using a spectrum analyzer.

Test data : APPENDIX
Test result : Pass

SECTION 7: -20 dB and 99 % Occupied Bandwidth

Test Procedure

The test was measured with a spectrum analyzer using a test fixture.

Test	Span	RBW	VBW	Sweep	Detector	Trace	Instrument used
20 dB Bandwidth	150 kHz	1.5 kHz	5.1 kHz	Auto	Peak	Max Hold	Spectrum Analyzer
99 % Occupied Bandwidth	Enough width to display emission skirts	1 to 5 % of OBW	Three times of RBW	Auto	Peak	Max Hold	Spectrum Analyzer

Peak hold was applied as Worst-case measurement.

Test data : APPENDIX
Test result : Pass

APPENDIX 1: Test data

Automatically deactivate

Report No. 13035531H
Test place Ise EMC Lab.
Semi Anechoic Chamber No.1
Date September 26, 2019
Temperature / Humidity 21 deg. C / 57 % RH
Engineer Shinya Watanabe
Mode Normal use mode

Tx Freq	Time of Transmitting [sec]	Limit [sec]	Result
315.10 MHz	0.1950	5.00	Pass
314.35 MHz	0.1900	5.00	Pass

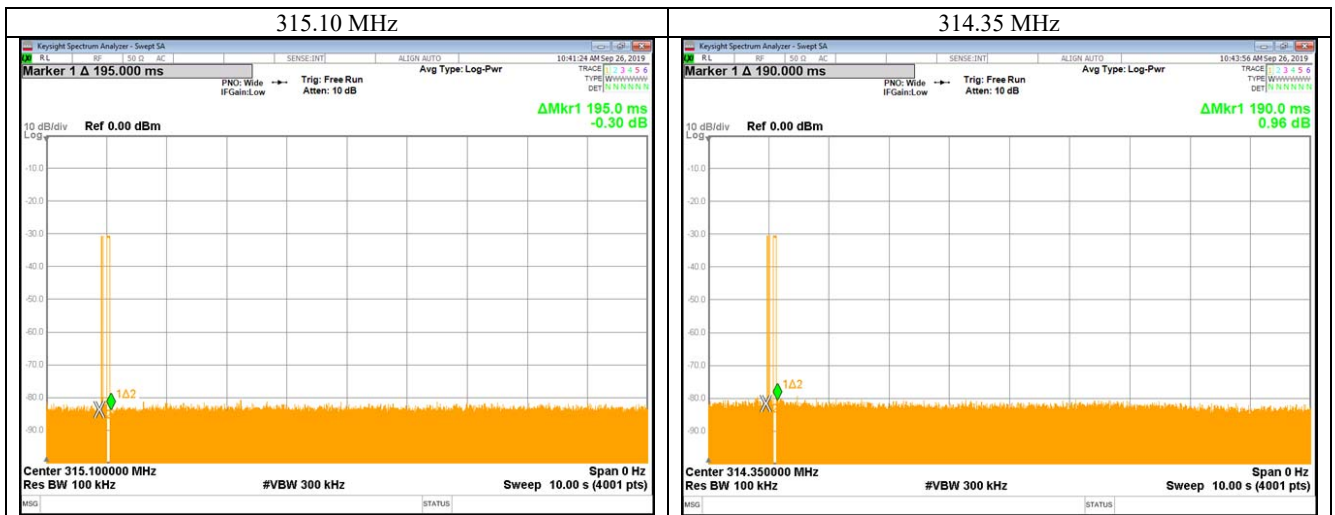

UL Japan, Inc.

Ise EMC Lab.

4383-326 Asama-cho, Ise-shi, Mie-ken 516-0021 JAPAN

Telephone : +81 596 24 8999

Facsimile : +81 596 24 8124

Radiated Emission (Electric Field Strength of Fundamental and Spurious Emission)

Report No. 13035531H
Test place Ise EMC Lab.
Semi Anechoic Chamber No.3 No.3
Date September 25, 2019 September 25, 2019
Temperature / Humidity 24 deg. C / 59 % RH 24 deg. C / 59 % RH
Engineer Akihiko Maeda Koji Yamamoto
(Below 1 GHz) (Above 1 GHz)
Mode Transmitting mode, 315.10 MHz

QP or PK

Frequency [MHz]	Detector	Reading [dBuV]		Ant Factor [dB/m]	Loss [dB]	Gain [dB]	Duty Factor [dB]	Result [dBuV/m]		Limit [dBuV/m]	Margin [dB]		Remark Inside or Outside of Restricted Bands
		Hor	Ver					Hor	Ver		Hor	Ver	
315.100	PK	72.7	69.4	13.9	10.1	31.9	-	64.8	61.5	95.6	30.8	34.1	Carrier
630.200	PK	35.2	35.9	19.5	12.1	32.0	-	34.8	35.5	75.6	40.9	40.2	Outside
945.300	PK	29.5	29.0	22.0	13.7	30.7	-	34.5	34.0	75.6	41.1	41.6	Outside
1260.400	PK	47.2	46.6	25.9	6.1	34.7	-	44.5	43.9	75.6	31.1	31.8	Outside
1575.500	PK	42.0	43.3	25.7	5.5	34.0	-	39.3	40.6	73.9	34.6	33.3	Inside
1890.600	PK	46.5	46.1	26.0	5.5	33.2	-	44.9	44.4	75.6	30.7	31.2	Outside
2205.700	PK	44.8	44.6	27.7	5.6	32.8	-	45.2	45.0	73.9	28.7	28.9	Inside
2520.800	PK	44.8	44.0	28.0	5.7	32.7	-	45.8	44.9	75.6	29.8	30.7	Outside
2835.900	PK	45.5	43.2	29.0	5.8	32.5	-	47.8	45.5	73.9	26.1	28.4	Inside
3151.000	PK	43.7	44.8	29.0	5.9	32.4	-	46.2	47.3	75.6	29.4	28.3	Outside

PK with Duty factor

Frequency [MHz]	Detector	Reading [dBuV]		Ant Factor [dB/m]	Loss [dB]	Gain [dB]	Duty Factor [dB]	Result [dBuV/m]		Limit [dBuV/m]	Margin [dB]		Remark
		Hor	Ver					Hor	Ver		Hor	Ver	
315.100	PK	72.7	69.4	13.9	10.1	31.9	0.0	64.8	61.5	75.6	10.8	14.1	Carrier
630.200	PK	35.2	35.9	19.5	12.1	32.0	0.0	34.8	35.5	55.6	20.9	20.2	Outside
945.300	PK	29.5	29.0	22.0	13.7	30.7	0.0	34.5	34.0	55.6	21.1	21.6	Outside
1260.400	PK	47.2	46.6	25.9	6.1	34.7	0.0	44.5	43.9	55.6	11.1	11.8	Outside
1575.500	PK	42.0	43.3	25.7	5.5	34.0	0.0	39.3	40.6	53.9	14.6	13.3	Inside
1890.600	PK	46.5	46.1	26.0	5.5	33.2	0.0	44.9	44.4	55.6	10.7	11.2	Outside
2205.700	PK	44.8	44.6	27.7	5.6	32.8	0.0	45.2	45.0	53.9	8.7	8.9	Inside
2520.800	PK	44.8	44.0	28.0	5.7	32.7	0.0	45.8	44.9	55.6	9.8	10.7	Outside
2835.900	PK	45.5	43.2	29.0	5.8	32.5	0.0	47.8	45.5	53.9	6.1	8.4	Inside
3151.000	PK	43.7	44.8	29.0	5.9	32.4	0.0	46.2	47.3	55.6	9.4	8.3	Outside

*Other frequency noises omitted in this report were not seen or had enough margin (more than 20dB).

Sample calculation:

Result of PK = Reading + Ant Factor + Loss {Cable + Attenuator + Filter (above 1GHz) +Distance factor (above 1 GHz)} - Gain (Amplifier)

Result of PK with Duty factor = Reading + Ant Factor + Loss {Cable + Attenuator + Filter (above 1 GHz) +Distance factor (above 1 GHz)} - Gain (Amplifier) + Duty factor

For above 1GHz : Distance Factor: $20 \times \log(4.0 \text{ m}/3.0 \text{ m}) = 2.50 \text{ dB}$

*Other frequency noises omitted in this report were not seen or had enough margin (more than 20dB).

Since the peak emission result satisfied the average limit, duty factor was omitted.

Although Duty of this product was 100% or less, the result of AV (PK with Duty factor) was calculated by applying Duty 100% as worst.

UL Japan, Inc.

Ise EMC Lab.

4383-326 Asama-cho, Ise-shi, Mie-ken 516-0021 JAPAN

Telephone : +81 596 24 8999

Facsimile : +81 596 24 8124

Radiated Emission (Electric Field Strength of Fundamental and Spurious Emission)

Report No. 13035531H
Test place Ise EMC Lab.
Semi Anechoic Chamber No.3 No.3
Date September 25, 2019 September 25, 2019
Temperature / Humidity 24 deg. C / 59 % RH 24 deg. C / 59 % RH
Engineer Akihiko Maeda Koji Yamamoto
(Below 1 GHz) (Above 1 GHz)
Mode Transmitting mode, 314.35 MHz

QP or PK

Frequency [MHz]	Detector	Reading [dBuV]		Ant Factor [dB/m]	Loss [dB]	Gain [dB]	Duty Factor [dB]	Result [dBuV/m]		Limit [dBuV/m]	Margin [dB]		Remark Inside or Outside of Restricted Bands
		Hor	Ver					Hor	Ver		Hor	Ver	
314.350	PK	72.7	69.2	13.9	10.1	31.9	-	64.7	61.2	95.5	30.8	34.3	Carrier
628.700	PK	36.2	35.6	19.5	12.1	32.0	-	35.8	35.2	75.5	39.8	40.4	Outside
943.050	PK	30.0	28.6	22.0	13.7	30.7	-	35.0	33.6	75.5	40.5	41.9	Outside
1257.400	PK	47.0	46.3	25.9	6.1	34.7	-	44.2	43.5	75.5	31.3	32.0	Outside
1571.750	PK	44.7	44.2	25.8	5.5	34.0	-	42.1	41.6	73.9	31.8	32.3	Inside
1886.100	PK	44.5	46.5	26.1	5.5	33.2	-	42.9	44.8	75.5	32.6	30.7	Outside
2200.450	PK	44.8	43.6	27.6	5.6	32.8	-	45.1	43.9	73.9	28.8	30.0	Inside
2514.800	PK	44.1	43.9	27.9	5.7	32.7	-	45.0	44.8	75.5	30.5	30.7	Outside
2829.150	PK	44.7	43.4	29.0	5.8	32.5	-	46.9	45.7	73.9	27.0	28.2	Inside
3143.500	PK	42.7	43.0	29.0	5.9	32.4	-	45.3	45.5	75.5	30.2	30.0	Outside

PK with Duty factor

Frequency [MHz]	Detector	Reading [dBuV]		Ant Factor [dB/m]	Loss [dB]	Gain [dB]	Duty Factor [dB]	Result [dBuV/m]		Limit [dBuV/m]	Margin [dB]		Remark
		Hor	Ver					Hor	Ver		Hor	Ver	
314.350	PK	72.7	69.2	13.9	10.1	31.9	0.0	64.7	61.2	75.5	10.8	14.3	Carrier
628.700	PK	36.2	35.6	19.5	12.1	32.0	0.0	35.8	35.2	55.5	19.8	20.4	Outside
943.050	PK	30.0	28.6	22.0	13.7	30.7	0.0	35.0	33.6	55.5	20.5	21.9	Outside
1257.400	PK	47.0	46.3	25.9	6.1	34.7	0.0	44.2	43.5	55.5	11.3	12.0	Outside
1571.750	PK	44.7	44.2	25.8	5.5	34.0	0.0	42.1	41.6	53.9	11.8	12.3	Inside
1886.100	PK	44.5	46.5	26.1	5.5	33.2	0.0	42.9	44.8	55.5	12.6	10.7	Outside
2200.450	PK	44.8	43.6	27.6	5.6	32.8	0.0	45.1	43.9	53.9	8.8	10.0	Inside
2514.800	PK	44.1	43.9	27.9	5.7	32.7	0.0	45.0	44.8	55.5	10.5	10.7	Outside
2829.150	PK	44.7	43.4	29.0	5.8	32.5	0.0	46.9	45.7	53.9	7.0	8.2	Inside
3143.500	PK	42.7	43.0	29.0	5.9	32.4	0.0	45.3	45.5	55.5	10.2	10.0	Outside

*Other frequency noises omitted in this report were not seen or had enough margin (more than 20dB).

Sample calculation:

Result of PK = Reading + Ant Factor + Loss {Cable + Attenuator + Filter (above 1GHz) +Distance factor (above 1 GHz)} - Gain (Amplifier)

Result of PK with Duty factor = Reading + Ant Factor + Loss {Cable + Attenuator + Filter (above 1 GHz) +Distance factor (above 1 GHz)} - Gain (Amplifier) + Duty factor

For above 1GHz : Distance Factor: $20 \times \log(4.0 \text{ m}/3.0 \text{ m}) = 2.50 \text{ dB}$

*Other frequency noises omitted in this report were not seen or had enough margin (more than 20dB).

Since the peak emission result satisfied the average limit, duty factor was omitted.

Although Duty of this product was 100% or less, the result of AV (PK with Duty factor) was calculated by applying Duty 100% as worst.

UL Japan, Inc.

Ise EMC Lab.

4383-326 Asama-cho, Ise-shi, Mie-ken 516-0021 JAPAN

Telephone : +81 596 24 8999

Facsimile : +81 596 24 8124

Radiated Spurious Emission
(Plot data, Worst case)

Report No. 13035531H
Test place Ise EMC Lab.
Semi Anechoic Chamber No.3
Date September 25, 2019 September 25, 2019
Temperature / Humidity 24 deg. C / 59 % RH 24 deg. C / 59 % RH
Engineer Akihiko Maeda Koji Yamamoto
(Below 1 GHz) (Above 1 GHz)
Mode Transmitting mode, 315.10 MHz

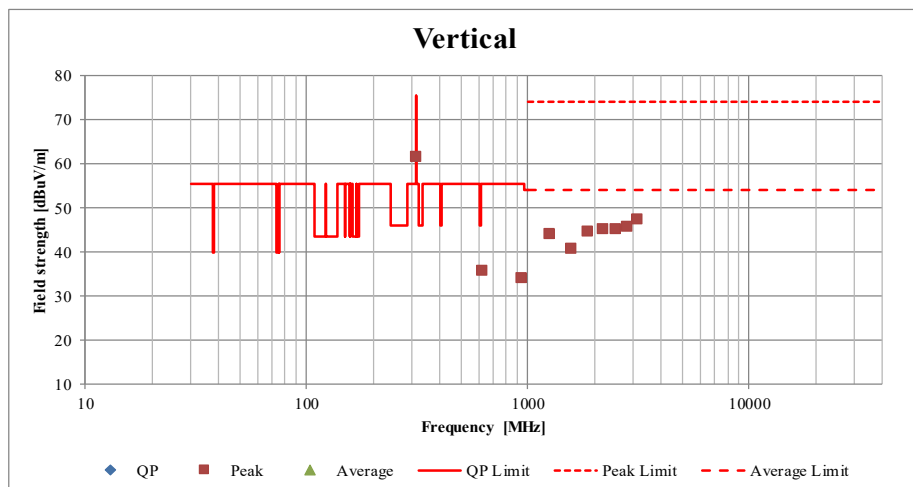
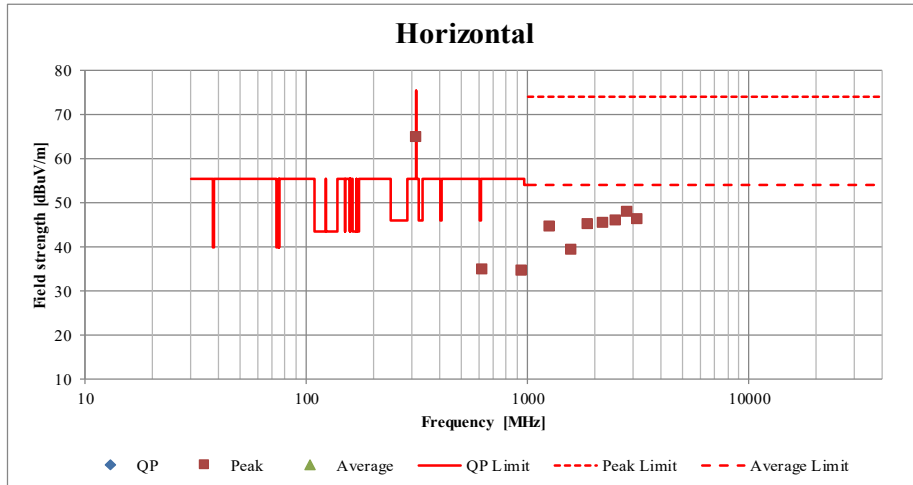

*These plots data contains sufficient number to show the trend of characteristic features for EUT.

-20dB and 99% Occupied Bandwidth

Report No. 13035531H
Test place Ise EMC Lab.
Semi Anechoic Chamber No.3
Date September 25, 2019
Temperature / Humidity 24 deg. C / 59 % RH
Engineer Akihiko Maeda
Mode Transmitting mode, 315.10 MHz / 314.35 MHz

Bandwidth Limit : Fundamental Frequency **314.35** MHz x 0.25% = 785.88 kHz

* The above limit was calculated from more stringent nominal frequency.

* Method of KDB 926416 for systems employing non sweeping frequencies was referred.

315.10 MHz

-20dB Bandwidth [kHz]
37.236

314.35 MHz

-20dB Bandwidth [kHz]
37.270

-20dB Bandwidth [kHz]	Bandwidth Limit [kHz]	Result
74.506	785.88	Pass

Bandwidth Limit : Fundamental Frequency **315.10** MHz x 0.25% = 787.75 kHz

99% Occupied Bandwidth [kHz]	Bandwidth Limit [kHz]	Result
36.4537	787.75	Pass

Bandwidth Limit : Fundamental Frequency **314.35** MHz x 0.25% = 785.88 kHz

99% Occupied Bandwidth [kHz]	Bandwidth Limit [kHz]	Result
36.5259	785.88	Pass

-20dB and 99% Occupied Bandwidth

Report No.	13035531H
Test place	Ise EMC Lab.
Semi Anechoic Chamber	No.3
Date	September 25, 2019
Temperature / Humidity	24 deg. C / 59 % RH
Engineer	Akihiko Maeda
Mode	Transmitting mode, 315.10 MHz / 314.35 MHz

[315.10 MHz]

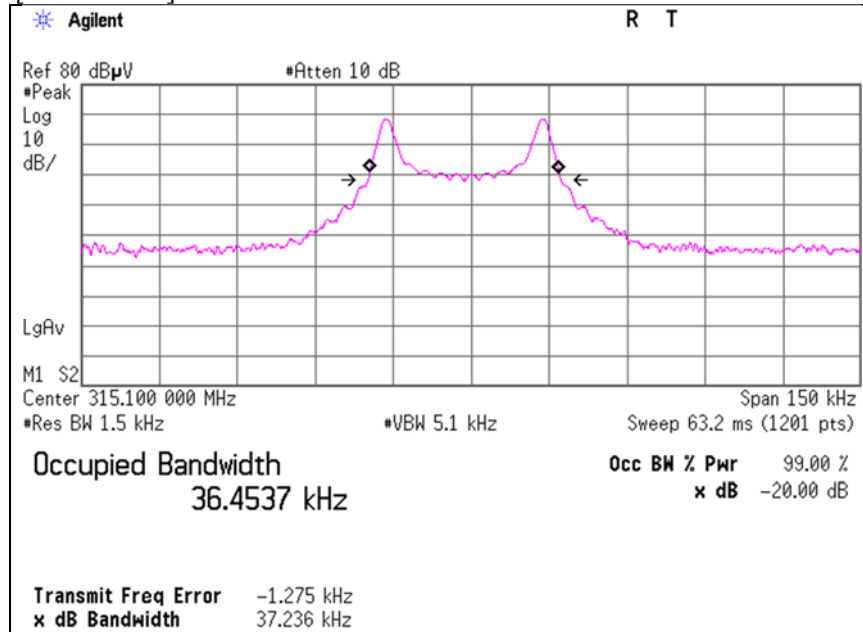

[314.35 MHz]

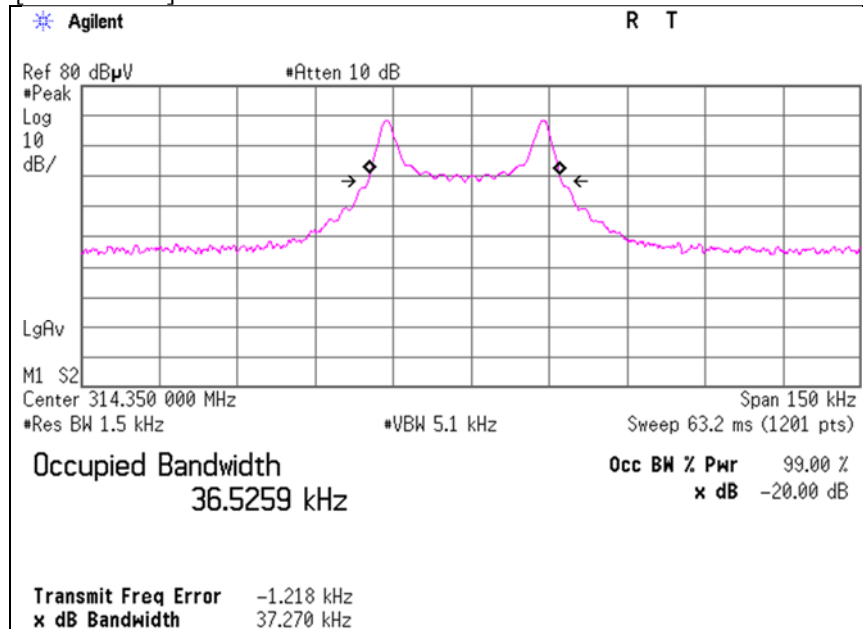

APPENDIX 2: Test instruments

Test Instruments

Test item	LIMS ID	Description	Manufacturer	Model	Serial	Last Calibration Date	Calibration Due Date	Cal Int
RE	142008	AC3_Semi Anechoic Chamber(NSA)	TDK	Semi Anechoic Chamber 3m	DA-10005	06/26/2018	06/30/2020	24
RE	141554	Thermo-Hygrometer	CUSTOM	CTH-180	1301	01/11/2019	01/31/2020	12
RE	141582	Pre Amplifier	SONOMA INSTRUMENT	310	260834	02/08/2019	02/29/2020	12
RE	141323	Coaxial cable	UL Japan	-	-	07/02/2019	07/31/2020	12
RE	142314	Attenuator	Pasternack	PE7390-6	D/C 1504	06/11/2019	06/30/2020	12
RE	141266	Logperiodic Antenna(200-1000MHz)	Schwarzbeck	VUSLP9111B	9111B-191	08/24/2019	08/31/2020	12
RE	141424	Biconical Antenna	Schwarzbeck	VHA9103+BBA9106	1915	08/24/2019	08/31/2020	12
RE	141532	DIGITAL HiTESTER	HIOKI	3805	51201197	01/29/2019	01/31/2020	12
RE	142183	Measure	KOMELON	KMC-36	-	-	-	-
RE	141899	Spectrum Analyzer	AGILENT	E4448A	MY46180655	08/07/2019	08/31/2020	12
RE	141942	Test Receiver	Rohde & Schwarz	ESCI	100300	08/08/2019	08/31/2020	12
RE	141566	Thermo-Hygrometer	CUSTOM	CTH-201	A08Q26	01/11/2019	01/31/2020	12
RE	177964	Microwave Cable	Junkosha INC.	MMX221	1901S329(1m)/1902S579(5m)	03/05/2019	03/31/2020	12
RE	141580	MicroWave System Amplifier	AGILENT	83017A	MY39500779	03/05/2019	03/31/2020	12
RE	141297	High Pass Filter(1.1-10GHz)	TOKYO KEIKI	TF219CD1	1001	01/10/2019	01/31/2020	12
RE	141511	Horn Antenna 1-18GHz	Schwarzbeck	BBHA9120D	253	04/12/2019	04/30/2020	12
RE	183868	Spectrum Analyzer	KEYSIGHT	N9020A	MY54500302	09/04/2019	09/30/2020	12
RE	142645	Loop Antenna	UL Japan	-	-	-	-	-

*Hyphens for Last Calibration Date, Calibration Due Date and Cal Int (month) are instruments that Calibration is not required (e.g. software), or instruments checked in advance before use.

The expiration date of the calibration is the end of the expired month.

All equipment is calibrated with valid calibrations. Each measurement data is traceable to the national or international standards.

As for some calibrations performed after the tested dates, those test equipment have been controlled by means of an unbroken chains of calibrations.

Test item:

RE: Radiated emission, 99 % Occupied Bandwidth, -20 dB bandwidth, and Automatically deactivate tests

UL Japan, Inc.

Ise EMC Lab.

4383-326 Asama-cho, Ise-shi, Mie-ken 516-0021 JAPAN

Telephone : +81 596 24 8999

Facsimile : +81 596 24 8124