



RADIO TEST REPORT

Test Report No. : 13523439H-A-R1

Applicant : DENSO CORPORATION
Type of EUT : Smart Card Key
Model Number of EUT : 14CBP
FCC ID : HYQ14CBP
Test regulation : FCC Part 15 Subpart C: 2020
Test Result : Complied (Refer to SECTION 3.2)

1. This test report shall not be reproduced in full or partial, without the written approval of UL Japan, Inc.
2. The results in this report apply only to the sample tested.
3. This sample tested is in compliance with the limits of the above regulation.
4. The test results in this test report are traceable to the national or international standards.
5. This test report must not be used by the customer to claim product certification, approval, or endorsement by the A2LA accreditation body.
6. This test report covers Radio technical requirements. It does not cover administrative issues such as Manual or non-Radio test related Requirements. (if applicable)
7. The all test items in this test report are conducted by UL Japan, Inc. Ise EMC Lab.
8. The opinions and the interpretations to the result of the description in this report are outside scopes where UL Japan has been accredited.
9. The information provided from the customer for this report is identified in Section 1.
10. This report is a revised version of 13523439H-A. 13523439H-A is replaced with this report.

Date of test: October 14 and 22, 2020

Representative test engineer: 
Shinya Watanabe
Engineer
Consumer Technology Division

Approved by: 
Motoya Imura
Leader
Consumer Technology Division



CERTIFICATE 5107.02

- The testing in which "Non-accreditation" is displayed is outside the accreditation scopes in UL Japan.
 There is no testing item of "Non-accreditation".

UL Japan, Inc.
Ise EMC Lab.

4383-326 Asama-cho, Ise-shi, Mie-ken 516-0021 JAPAN
Telephone : +81 596 24 8999
Facsimile : +81 596 24 8124

REVISION HISTORY

Original Test Report No.: 13523439H-A

Revision	Test report No.	Date	Page revised	Contents
- (Original)	13523439H-A	November 5, 2020	-	-
1	13523439H-A-R1	November 26, 2020	P.15	Correction of 9 th Harmonic Frequency; From 2809.900 to 2808.900

UL Japan, Inc.

Ise EMC Lab.

4383-326 Asama-cho, Ise-shi, Mie-ken 516-0021 JAPAN

Telephone : +81 596 24 8999

Facsimile : +81 596 24 8124

Reference: Abbreviations (Including words undescribed in this report)

A2LA	The American Association for Laboratory Accreditation	MCS	Modulation and Coding Scheme
AC	Alternating Current	MRA	Mutual Recognition Arrangement
AFH	Adaptive Frequency Hopping	N/A	Not Applicable
AM	Amplitude Modulation	NIST	National Institute of Standards and Technology
Amp, AMP	Amplifier	NS	No signal detect.
ANSI	American National Standards Institute	NSA	Normalized Site Attenuation
Ant, ANT	Antenna	NVLAP	National Voluntary Laboratory Accreditation Program
AP	Access Point	OBW	Occupied Band Width
ASK	Amplitude Shift Keying	OFDM	Orthogonal Frequency Division Multiplexing
Atten., ATT	Attenuator	P/M	Power meter
AV	Average	PCB	Printed Circuit Board
BPSK	Binary Phase-Shift Keying	PER	Packet Error Rate
BR	Bluetooth Basic Rate	PHY	Physical Layer
BT	Bluetooth	PK	Peak
BT LE	Bluetooth Low Energy	PN	Pseudo random Noise
BW	BandWidth	PRBS	Pseudo-Random Bit Sequence
Cal Int	Calibration Interval	PSD	Power Spectral Density
CCK	Complementary Code Keying	QAM	Quadrature Amplitude Modulation
Ch., CH	Channel	QP	Quasi-Peak
CISPR	Comite International Special des Perturbations Radioelectriques	QPSK	Quadri-Phase Shift Keying
CW	Continuous Wave	RBW	Resolution Band Width
DBPSK	Differential BPSK	RDS	Radio Data System
DC	Direct Current	RE	Radio Equipment
D-factor	Distance factor	RF	Radio Frequency
DFS	Dynamic Frequency Selection	RMS	Root Mean Square
DQPSK	Differential QPSK	RSS	Radio Standards Specifications
DSSS	Direct Sequence Spread Spectrum	Rx	Receiving
EDR	Enhanced Data Rate	SA, S/A	Spectrum Analyzer
EIRP, e.i.r.p.	Equivalent Isotropically Radiated Power	SG	Signal Generator
EMC	ElectroMagnetic Compatibility	SVSWR	Site-Voltage Standing Wave Ratio
EMI	ElectroMagnetic Interference	TR	Test Receiver
EN	European Norm	Tx	Transmitting
ERP, e.r.p.	Effective Radiated Power	VBW	Video BandWidth
EU	European Union	Vert.	Vertical
EUT	Equipment Under Test	WLAN	Wireless LAN
Fac.	Factor		
FCC	Federal Communications Commission		
FHSS	Frequency Hopping Spread Spectrum		
FM	Frequency Modulation		
Freq.	Frequency		
FSK	Frequency Shift Keying		
GFSK	Gaussian Frequency-Shift Keying		
GNSS	Global Navigation Satellite System		
GPS	Global Positioning System		
Hori.	Horizontal		
ICES	Interference-Causing Equipment Standard		
IEC	International Electrotechnical Commission		
IEEE	Institute of Electrical and Electronics Engineers		
IF	Intermediate Frequency		
ILAC	International Laboratory Accreditation Conference		
ISED	Innovation, Science and Economic Development Canada		
ISO	International Organization for Standardization		
JAB	Japan Accreditation Board		
LAN	Local Area Network		
LIMS	Laboratory Information Management System		

UL Japan, Inc.

Ise EMC Lab.

4383-326 Asama-cho, Ise-shi, Mie-ken 516-0021 JAPAN

Telephone : +81 596 24 8999

Facsimile : +81 596 24 8124

CONTENTS	PAGE
SECTION 1: Customer information.....	5
SECTION 2: Equipment under test (EUT).....	5
SECTION 3: Test specification, procedures & results.....	6
SECTION 4: Operation of EUT during testing.....	9
SECTION 5: Radiated emission (Electric Field Strength of Fundamental and Spurious Emission)..	11
SECTION 6: Automatically deactivate	13
SECTION 7: -20 dB and 99 % Occupied Bandwidth	13
APPENDIX 1: Test data	14
Automatically deactivate.....	14
Radiated Emission (Electric Field Strength of Fundamental and Spurious Emission).....	15
-20 dB and 99 % Occupied Bandwidth.....	18
APPENDIX 2: Test instruments	20
APPENDIX 3: Photographs of test setup	21
Radiated emission	21
Worst case position	23

SECTION 1: Customer information

Company Name : DENSO CORPORATION
Address : 1-1, Showa-cho, Kariya-shi, Aichi-ken, 448-8661, Japan
Telephone Number : +81-566-20-3955
Facsimile Number : +81-566-25-4837
Contact Person : TAKAYUKI HATTORI

The information provided from the customer is as follows;

- Applicant, Type of EUT, Model Number of EUT, FCC ID on the cover and other relevant pages
- Operating/Test Mode(s) (Mode(s)) on all the relevant pages
- SECTION 1: Customer information
- SECTION 2: Equipment under test (EUT) other than the Receipt Date
- SECTION 4: Operation of EUT during testing

* The laboratory is exempted from liability of any test results affected from the above information in SECTION 2 and 4.

SECTION 2: Equipment under test (EUT)

2.1 Identification of EUT

Type : Smart Card Key
Model Number : 14CBP
Serial Number : Refer to SECTION 4.2
Rating : DC 3.0 V
Receipt Date : October 12, 2019
Country of Mass-production : Japan, China and United States of America
Condition : Production prototype
(Not for Sale: This sample is equivalent to mass-produced items.)
Modification : No Modification by the test lab

2.2 Product Description

Model: 14CBP (referred to as the EUT in this report) is a Smart Card Key.

Radio Specification

Radio Type : Transceiver
Frequency of Operation : 312.10 MHz / 314.35 MHz*
*These two different frequencies are not emitted simultaneously.
Modulation : FSK (F1D)
Type of Battery : One lithium battery
Antenna type : Built-in type (Fixed)
Clock frequency (Maximum) : 32 MHz

Radio Type : Receiver
Frequency of Operation : 134.2 kHz *1)

*1) The test of receiver part was performed separately from this test report, and the conformability is confirmed.

SECTION 3: Test specification, procedures & results

3.1 Test Specification

Test Specification : FCC Part 15 Subpart C
FCC Part 15 final revised on October 13, 2020

Title : FCC 47CFR Part15 Radio Frequency Device Subpart C Intentional Radiators
Section 15.231 Periodic operation in the band 40.66-40.70 MHz and above 70 MHz.

3.2 Procedures and results

Item	Test Procedure	Specification	Worst margin	Results	Remarks
Conducted emission	FCC: ANSI C63.10:2013 6 Standard test methods ----- ISED: RSS-Gen 8.8	FCC: Section 15.207 ----- ISED: RSS-Gen 8.8	N/A	N/A	*1)
Automatically Deactivate	FCC: ANSI C63.10:2013 6 Standard test methods ----- ISED: -	FCC: Section 15.231(a)(1) ----- ISED: RSS-210 A1.1	N/A	Complied a)	Radiated
Electric Field Strength of Fundamental Emission	FCC: ANSI C63.10:2013 6 Standard test methods ----- ISED: RSS-Gen 6.12	FCC: Section 15.231(b) ----- ISED: RSS-210 A1.2	10.1 dB 312.10 MHz Horizontal PK with Duty Factor	Complied b)	Radiated
Electric Field Strength of Spurious Emission	FCC: ANSI C63.10:2013 6 Standard test methods ----- ISED: RSS-Gen 6.13	FCC: Section 15.205 Section 15.209 Section 15.231(b) ----- ISED: RSS-210 A1.2 RSS-Gen 8.9	10.1 dB 1571.750 MHz Vertical PK with Duty Factor <314.35 MHz>	Complied b)	Radiated
-20dB Bandwidth	FCC: ANSI C63.10:2013 6 Standard test methods ----- ISED: -	FCC: Section 15.231(c) ----- ISED: Reference data	N/A	Complied c)	Radiated

Note: UL Japan, Inc.'s EMI Work Procedures No. 13-EM-W0420 and 13-EM-W0422.

*1) The test is not applicable since the EUT does not have AC Mains.

a) Refer to APPENDIX 1 (data of Automatically deactivate)

b) Refer to APPENDIX 1 (data of Radiated Emission (Electric Field Strength of Fundamental and Spurious Emission))

c) Refer to APPENDIX 1 (data of -20 dB and 99 % Occupied Bandwidth)

Symbols:

Complied The data of this test item has enough margin, more than the measurement uncertainty.

Complied# The data of this test item meets the limits unless the measurement uncertainty is taken into consideration.

FCC Part 15.31 (e)

This test was performed with the New Battery (DC 3.0 V) and the constant voltage was supplied to the EUT during the tests. Therefore, the EUT complies with the requirement.

FCC Part 15.203 Antenna requirement

It is impossible for end users to replace the antenna, because the antenna is mounted inside of the EUT. Therefore, the equipment complies with the antenna requirement of Section 15.203.

UL Japan, Inc.

Ise EMC Lab.

4383-326 Asama-cho, Ise-shi, Mie-ken 516-0021 JAPAN

Telephone : +81 596 24 8999

Facsimile : +81 596 24 8124

3.3 Addition to standard

Item	Test Procedure	Specification	Worst margin	Results	Remarks
99 % Occupied Bandwidth	ISED: RSS-Gen 6.7	ISED: RSS-210 A1.3	N/A	-	Radiated

Note: UL Japan, Inc.'s EMI Work Procedures No. 13-EM-W0420 and 13-EM-W0422.

Other than above, no addition, exclusion nor deviation has been made from the standard.

3.4 Uncertainty

There is no applicable rule of uncertainty in this applied standard. Therefore, the following results are derived depending on whether or not laboratory uncertainty is applied.

The following uncertainties have been calculated to provide a confidence level of 95 % using a coverage factor $k = 2$.

Radiated emission

Measurement distance	Frequency range	Uncertainty (+/-)	
3 m	9 kHz to 30 MHz	3.3 dB	
10 m		3.2 dB	
3 m	30 MHz to 200 MHz	(Horizontal)	4.8 dB
		(Vertical)	5.0 dB
	200 MHz to 1000 MHz	(Horizontal)	5.2 dB
		(Vertical)	6.3 dB
10 m	30 MHz to 200 MHz	(Horizontal)	4.8 dB
		(Vertical)	4.8 dB
	200 MHz to 1000 MHz	(Horizontal)	5.0 dB
		(Vertical)	5.0 dB
3 m	1 GHz to 6 GHz	4.9 dB	
	6 GHz to 18 GHz	5.2 dB	
1 m	10 GHz to 26.5 GHz	5.5 dB	
	26.5 GHz to 40 GHz	5.5 dB	
10 m	1 GHz to 18 GHz	5.2 dB	

Antenna Terminal test

Test Item	Uncertainty (+/-)
Automatically Deactivate	0.10 %
-20 dB Emission Bandwidth / 99 % Occupied Bandwidth	0.96 %

3.5 Test Location

UL Japan, Inc. Ise EMC Lab.

*A2LA Certificate Number: 5107.02 / FCC Test Firm Registration Number: 199967 / ISED Lab Company Number: 2973C
4383-326 Asama-cho, Ise-shi, Mie-ken 516-0021 JAPAN
Telephone: +81 596 24 8999, Facsimile: +81 596 24 8124

Test site	Width x Depth x Height (m)	Size of reference ground plane (m) / horizontal conducting plane	Other rooms	Maximum measurement distance
No.1 semi-anechoic chamber	19.2 x 11.2 x 7.7	7.0 x 6.0	No.1 Power source room	10 m
No.2 semi-anechoic chamber	7.5 x 5.8 x 5.2	4.0 x 4.0	-	3 m
No.3 semi-anechoic chamber	12.0 x 8.5 x 5.9	6.8 x 5.75	No.3 Preparation room	3 m
No.3 shielded room	4.0 x 6.0 x 2.7	N/A	-	-
No.4 semi-anechoic chamber	12.0 x 8.5 x 5.9	6.8 x 5.75	No.4 Preparation room	3 m
No.4 shielded room	4.0 x 6.0 x 2.7	N/A	-	-
No.5 semi-anechoic chamber	6.0 x 6.0 x 3.9	6.0 x 6.0	-	-
No.5 measurement room	6.4 x 6.4 x 3.0	6.4 x 6.4	-	-
No.6 shielded room	4.0 x 4.5 x 2.7	4.0 x 4.5	-	-
No.6 measurement room	4.75 x 5.4 x 3.0	4.75 x 4.15	-	-
No.7 shielded room	4.7 x 7.5 x 2.7	4.7 x 7.5	-	-
No.8 measurement room	3.1 x 5.0 x 2.7	3.1 x 5.0	-	-
No.9 measurement room	8.8 x 4.6 x 2.8	2.4 x 2.4	-	-
No.11 measurement room	6.2 x 4.7 x 3.0	4.8 x 4.6	-	-

* Size of vertical conducting plane (for Conducted Emission test) : 2.0 x 2.0 m for No.1, No.2, No.3, and No.4 semi-anechoic chambers and No.3 and No.4 shielded rooms.

3.6 Test data, Test instruments, and Test set up

Refer to APPENDIX.

SECTION 4: Operation of EUT during testing

4.1 Operating Mode(s)

Test Item	Mode
Automatically Deactivate	Normal use mode, 312.10 MHz *1) Normal use mode, 314.35 MHz *1)
Electric Field Strength of Fundamental Emission Electric Field Strength of Spurious Emission -20dB & 99% Occupied Bandwidth	Transmitting mode (Tx), 312.10 MHz *2) Transmitting mode (Tx), 314.35 MHz *2)
<p>* The system was configured in typical fashion (as a customer would normally use it) for testing.</p> <p>*1) The EUT transmits only when it receives 134.2 kHz radio signal. End users cannot change the settings of the output power of the product.</p> <p>*2) The software of this mode is the same as one of normal product, except that EUT continues to transmit when transmitter button is being pressed. This button was attached just for testing (for making continuous transmission).</p> <p>* EUT was set by the software as follows; Software: Product program Version00001103 (Date: 2020/08/07, Storage location: EUT memory)</p> <p>*This setting of software is the worst case. Any conditions under the normal use do not exceed the condition of setting. In addition, end users cannot change the settings of the output power of the product.</p>	

4.2 Configuration and peripherals

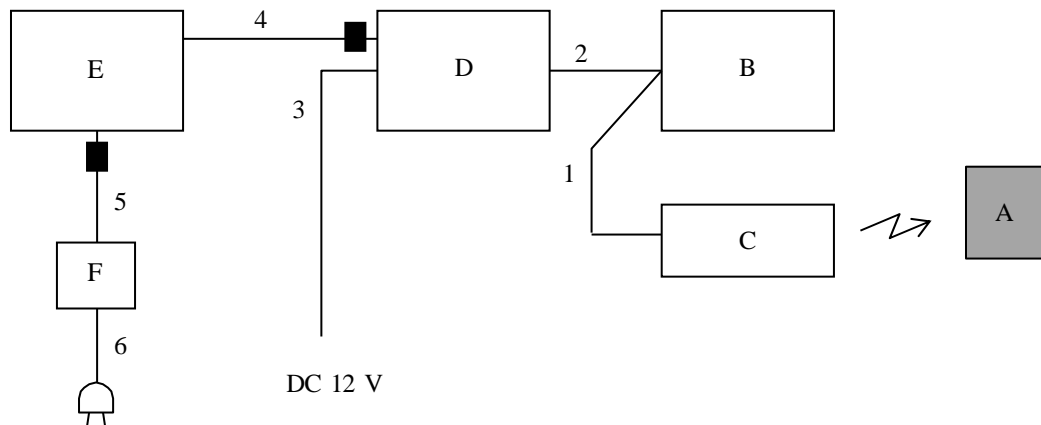

AC 100 V / 60 Hz

■ : Standard Ferrite Core

* Cabling and setup(s) were taken into consideration and test data was taken under worse case conditions.

Description of EUT and Support equipment

No.	Item	Model number	Serial number	Manufacturer	Remarks
A	Smart Card Key	14CBP	No.2 *1) No.1 *2)	DENSO CORPORATION	EUT
B	Oscillator	-	-	-	*1)
C	LF Antenna	-	-	-	*1)
D	Check Bench	-	-	DENSO CORPORATION	*1)
E	Laptop PC	CF-LX4EDHCS	5GKSA17377	Panasonic	*1)
F	AC Adapter	CF-AA62J2C	64B2CM114703755B	Panasonic	*1)

*1) Used for Normal use mode

*2) Used for Transmitting mode

List of cables used

No.	Name	Length (m)	Shield		Remarks
			Cable	Connector	
1	Signal Cable	0.3	Unshielded	Unshielded	*1)
2	DC and Signal Cable	0.1	Unshielded	Unshielded	*1)
3	DC Cable	1.1	Unshielded	Unshielded	*1)
4	USB Cable	1.5	Shielded	Shielded	*1)
5	DC Cable	0.9	Unshielded	Unshielded	*1)
6	AC Cable	0.8	Unshielded	Unshielded	*1)

*1) Used for Normal use mode

UL Japan, Inc.

Ise EMC Lab.

4383-326 Asama-cho, Ise-shi, Mie-ken 516-0021 JAPAN

Telephone : +81 596 24 8999

Facsimile : +81 596 24 8124

SECTION 5: Radiated emission (Electric Field Strength of Fundamental and Spurious Emission)

Test Procedure and conditions

[For below 30 MHz]

The noise level was checked by moving a search-coil (Loop Antenna) close to the EUT.

[For 30 MHz to 1 GHz]

EUT was placed on a urethane platform of nominal size, 0.5 m by 1.0 m, raised 0.8 m above the conducting ground plane. The Radiated Electric Field Strength has been measured in a Semi Anechoic Chamber with a ground plane.

[For above 1 GHz]

EUT was placed on a urethane platform of nominal size, 0.5 m by 0.5 m, raised 1.5 m above the conducting ground plane. The Radiated Electric Field Strength has been measured in a Semi Anechoic Chamber with absorbent materials lined on a ground plane.

The measuring antenna height was varied between 1 and 4 m and EUT was rotated a full revolution in order to obtain the maximum value of the electric field strength.

Test antenna was aimed at the EUT for receiving the maximum signal and always kept within the illumination area of the 3 dB beamwidth of the antenna.

The measurements were performed for both vertical and horizontal antenna polarization.

The radiated emission measurements were made with the following detector function of the test receiver / spectrum analyzer.

Test Antennas are used as below;

Frequency	Below 30 MHz	30 MHz to 200 MHz	200 MHz to 1 GHz	Above 1 GHz
Antenna Type	Loop	Biconical	Logperiodic	Horn

	From 9 kHz to 90 kHz and From 110 kHz to 150 kHz	From 90 kHz to 110 kHz	From 150 kHz to 490 kHz	From 490 kHz to 30 MHz	From 30 MHz to 1 GHz	Above 1 GHz
Detector Type	Peak	Peak	Peak	Peak	Peak and Peak with Duty factor	Peak and Peak with Duty factor
IF Bandwidth	200 Hz	200 Hz	9.1 kHz	9.1 kHz	120 kHz	PK: S/A: RBW 1 MHz, VBW: 3 MHz

[Test Setup]
Below 1 GHz

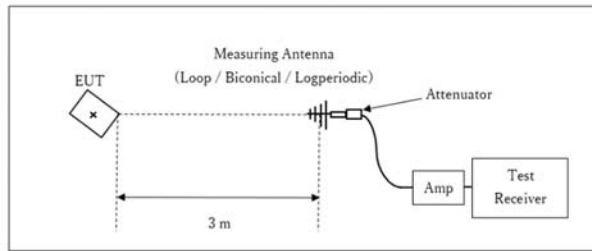

× : Center of turn table

Test Distance: 3 m

1 GHz - 10 GHz

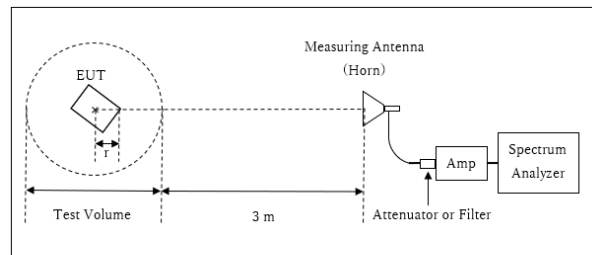

r : Radius of an outer periphery of EUT
× : Center of turn table

Distance Factor: $20 \times \log(4.00 \text{ m}^*/3.0 \text{ m}) = 2.50 \text{ dB}$
 * Test Distance: $(3 + \text{SVSWR Volume} / 2) - r = 4.00 \text{ m}$

SVSWR Volume: 2.0 m
 (SVSWR Volume has been calibrated based on CISPR 16-1-4.)
 r = 0.0 m

* The test was performed with $r = 0.0 \text{ m}$ since EUT is small and it was the rather conservative condition.

- The carrier level (or, noise levels) was (or were) measured at each position of all three axes X, Y and Z, and the position that has the maximum noise was determined.
 Noise levels of all the frequencies were measured at the position.

This EUT has two modes which mechanical key is inserted or not. The worst case was confirmed with and without mechanical key, as a result, the test with mechanical key was the worst case. Therefore, the test with mechanical key was performed only.

*The result is rounded off to the second decimal place, so some differences might be observed.

Measurement range : 9 kHz - 3.2 GHz
Test data : APPENDIX
Test result : Pass

SECTION 6: Automatically deactivate

Test Procedure

The measurement was performed with Electric field strength using a spectrum analyzer.

Test data : APPENDIX
Test result : Pass

SECTION 7: -20 dB and 99 % Occupied Bandwidth

Test Procedure

The test was measured with a spectrum analyzer using a test fixture.

Test	Span	RBW	VBW	Sweep	Detector	Trace	Instrument used
20 dB Bandwidth	150 kHz	1.5 kHz	5.1 kHz	Auto	Peak	Max Hold	Spectrum Analyzer
99 % Occupied Bandwidth	Enough width to display emission skirts	1 to 5 % of OBW	Three times of RBW	Auto	Peak	Max Hold	Spectrum Analyzer

Peak hold was applied as Worst-case measurement.

Test data : APPENDIX
Test result : Pass

APPENDIX 1: Test data

Automatically deactivate

Report No.	13523439H
Test place	Ise EMC Lab.
Semi Anechoic Chamber	No.2
Date	October 22, 2020
Temperature / Humidity	23 deg. C / 57 % RH
Engineer	Akihiko Maeda
Mode	Normal use mode

Tx Freq	Time of Transmitting [sec]	Limit [sec]	Result
312.10 MHz	0.1360	5.00	Pass
314.35 MHz	0.1360	5.00	Pass

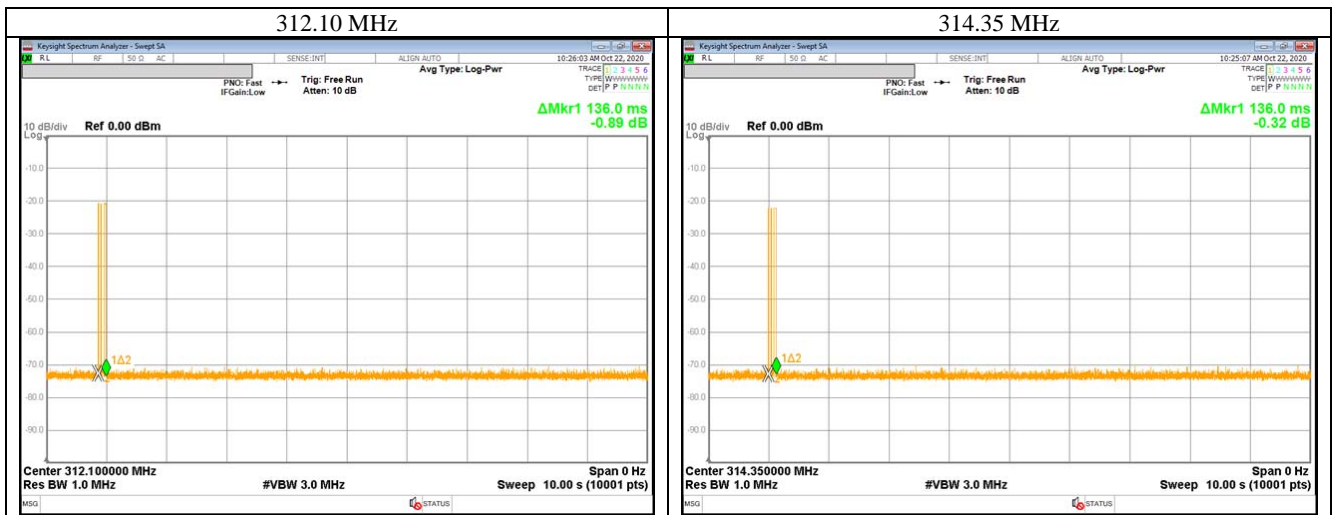

UL Japan, Inc.

Ise EMC Lab.

4383-326 Asama-cho, Ise-shi, Mie-ken 516-0021 JAPAN

Telephone : +81 596 24 8999

Facsimile : +81 596 24 8124

Radiated Emission (Electric Field Strength of Fundamental and Spurious Emission)

Report No. 13523439H
Test place Ise EMC Lab.
Semi Anechoic Chamber No.4
Date October 14, 2020
Temperature / Humidity 21 deg. C / 55 % RH
Engineer Shinya Watanabe
Mode Transmitting mode, 312.10 MHz

QP or PK

Frequency [MHz]	Detector	Reading [dBuV]		Ant Factor [dB/m]	Loss [dB]	Gain [dB]	Duty Factor [dB]	Result [dBuV/m]		Limit [dBuV/m]	Margin [dB]		Remark Inside or Outside of Restricted Bands
		Hor	Ver					Hor	Ver		Hor	Ver	
312.100	PK	73.5	68.9	13.8	9.8	31.8	-	65.4	60.7	95.4	30.1	34.7	Carrier
624.200	PK	40.0	39.7	19.4	11.6	32.0	-	39.0	38.7	75.4	36.4	36.7	Outside
936.300	PK	27.1	27.1	21.9	13.0	30.9	-	31.1	31.0	75.4	44.3	44.4	Outside
1248.400	PK	43.6	44.6	25.2	4.2	34.0	-	39.0	40.0	75.4	36.5	35.4	Outside
1560.500	PK	46.8	46.9	25.0	4.4	33.2	-	43.0	43.1	73.9	30.9	30.8	Inside
1872.600	PK	43.3	44.6	25.4	4.6	32.4	-	40.9	42.2	75.4	34.5	33.2	Outside
2184.700	PK	NS	NS	-	-	-	-	-	-	75.4	-	-	Outside
2496.800	PK	NS	NS	-	-	-	-	-	-	73.9	-	-	Inside
2808.900	PK	NS	NS	-	-	-	-	-	-	73.9	-	-	Inside
3121.000	PK	NS	NS	-	-	-	-	-	-	75.4	-	-	Outside

PK with Duty factor

Frequency [MHz]	Detector	Reading [dBuV]		Ant Factor [dB/m]	Loss [dB]	Gain [dB]	Duty Factor [dB]	Result [dBuV/m]		Limit [dBuV/m]	Margin [dB]		Remark
		Hor	Ver					Hor	Ver		Hor	Ver	
312.100	PK	73.5	68.9	13.8	9.8	31.8	0.0	65.4	60.7	75.4	10.1	14.7	Carrier
624.200	PK	40.0	39.7	19.4	11.6	32.0	0.0	39.0	38.7	55.4	16.4	16.7	Outside
936.300	PK	27.1	27.1	21.9	13.0	30.9	0.0	31.1	31.0	55.4	24.3	24.4	Outside
1248.400	PK	43.6	44.6	25.2	4.2	34.0	0.0	39.0	40.0	55.4	16.5	15.4	Outside
1560.500	PK	46.8	46.9	25.0	4.4	33.2	0.0	43.0	43.1	53.9	10.9	10.8	Inside
1872.600	PK	43.3	44.6	25.4	4.6	32.4	0.0	40.9	42.2	55.4	14.5	13.2	Outside
2184.700	PK	NS	NS	-	-	-	0.0	-	-	55.4	-	-	Outside
2496.800	PK	NS	NS	-	-	-	0.0	-	-	53.9	-	-	Inside
2808.900	PK	NS	NS	-	-	-	0.0	-	-	53.9	-	-	Inside
3121.000	PK	NS	NS	-	-	-	0.0	-	-	55.4	-	-	Outside

Sample calculation:

Result of PK = Reading + Ant Factor + Loss {Cable + Attenuator + Filter (above 1GHz) +Distance factor (above 1 GHz)} - Gain (Amplifier)

Result of PK with Duty factor = Reading + Ant Factor + Loss {Cable + Attenuator + Filter (above 1 GHz) +Distance factor (above 1 GHz)} - Gain (Amplifier) + Duty factor

For above 1GHz : Distance Factor: $20 \times \log(4.0 \text{ m}/3.0 \text{ m}) = 2.50 \text{ dB}$

*Other frequency noises omitted in this report were not seen or had enough margin (more than 20 dB).

Since the peak emission result satisfied the average limit, duty factor was omitted.

Although Duty of this product was 100% or less, the result of AV (PK with Duty factor) was calculated by applying Duty 100% as worst.

UL Japan, Inc.

Ise EMC Lab.

4383-326 Asama-cho, Ise-shi, Mie-ken 516-0021 JAPAN

Telephone : +81 596 24 8999

Facsimile : +81 596 24 8124

Radiated Emission (Electric Field Strength of Fundamental and Spurious Emission)

Report No. 13523439H
Test place Ise EMC Lab.
Semi Anechoic Chamber No.4
Date October 14, 2020
Temperature / Humidity 21 deg. C / 55 % RH
Engineer Shinya Watanabe
Mode Transmitting mode, 314.35 MHz

QP or PK

Frequency [MHz]	Detector	Reading [dBuV]		Ant Factor [dB/m]	Loss [dB]	Gain [dB]	Duty Factor [dB]	Result [dBuV/m]		Limit [dBuV/m]	Margin [dB]		Remark Inside or Outside of Restricted Bands
		Hor	Ver					Hor	Ver		Hor	Ver	
314.350	PK	72.7	69.0	13.9	9.8	31.8	-	64.7	60.9	95.5	30.8	34.6	Carrier
628.700	PK	41.9	41.0	19.4	11.6	32.0	-	40.9	40.1	75.5	34.6	35.4	Outside
943.050	PK	27.1	27.1	21.8	13.0	30.9	-	31.1	31.1	75.5	44.4	44.4	Outside
1257.400	PK	45.0	45.1	25.2	4.2	34.0	-	40.4	40.5	75.5	35.1	35.0	Outside
1571.750	PK	47.3	47.6	25.0	4.4	33.2	-	43.5	43.8	73.9	30.4	30.1	Inside
1886.100	PK	43.5	43.8	25.4	4.6	32.3	-	41.2	41.5	75.5	34.3	34.0	Outside
2200.450	PK	NS	NS	-	-	-	-	-	-	73.9	-	-	Inside
2514.800	PK	NS	NS	-	-	-	-	-	-	75.5	-	-	Outside
2829.150	PK	NS	NS	-	-	-	-	-	-	73.9	-	-	Inside
3143.500	PK	NS	NS	-	-	-	-	-	-	75.5	-	-	Outside

PK with Duty factor

Frequency [MHz]	Detector	Reading [dBuV]		Ant Factor [dB/m]	Loss [dB]	Gain [dB]	Duty Factor [dB]	Result [dBuV/m]		Limit [dBuV/m]	Margin [dB]		Remark
		Hor	Ver					Hor	Ver		Hor	Ver	
314.350	PK	72.7	69.0	13.9	9.8	31.8	0.0	64.7	60.9	75.5	10.8	14.6	Carrier
628.700	PK	41.9	41.0	19.4	11.6	32.0	0.0	40.9	40.1	55.5	14.6	15.4	Outside
943.050	PK	27.1	27.1	21.8	13.0	30.9	0.0	31.1	31.1	55.5	24.4	24.4	Outside
1257.400	PK	45.0	45.1	25.2	4.2	34.0	0.0	40.4	40.5	55.5	15.1	15.0	Outside
1571.750	PK	47.3	47.6	25.0	4.4	33.2	0.0	43.5	43.8	53.9	10.4	10.1	Inside
1886.100	PK	43.5	43.8	25.4	4.6	32.3	0.0	41.2	41.5	55.5	14.3	14.0	Outside
2200.450	PK	NS	NS	-	-	-	0.0	-	-	53.9	-	-	Inside
2514.800	PK	NS	NS	-	-	-	0.0	-	-	55.5	-	-	Outside
2829.150	PK	NS	NS	-	-	-	0.0	-	-	53.9	-	-	Inside
3143.500	PK	NS	NS	-	-	-	0.0	-	-	55.5	-	-	Outside

Sample calculation:

Result of PK = Reading + Ant Factor + Loss {Cable + Attenuator + Filter (above 1GHz) +Distance factor (above 1 GHz)} - Gain (Amplifier)

Result of PK with Duty factor = Reading + Ant Factor + Loss {Cable + Attenuator + Filter (above 1 GHz) +Distance factor (above 1 GHz)} - Gain (Amplifier) + Duty factor

For above 1GHz : Distance Factor: 20 x log (4.0 m/3.0 m) = 2.50 dB

*Other frequency noises omitted in this report were not seen or had enough margin (more than 20 dB).

Since the peak emission result satisfied the average limit, duty factor was omitted.

Although Duty of this product was 100% or less, the result of AV (PK with Duty factor) was calculated by applying Duty 100% as worst.

Radiated Spurious Emission
(Plot data, Worst case)

Report No. 13523439H
Test place Ise EMC Lab.
Semi Anechoic Chamber No.4
Date October 14, 2020
Temperature / Humidity 21 deg. C / 55 % RH
Engineer Shinya Watanabe
Mode Transmitting mode, 312.10 MHz

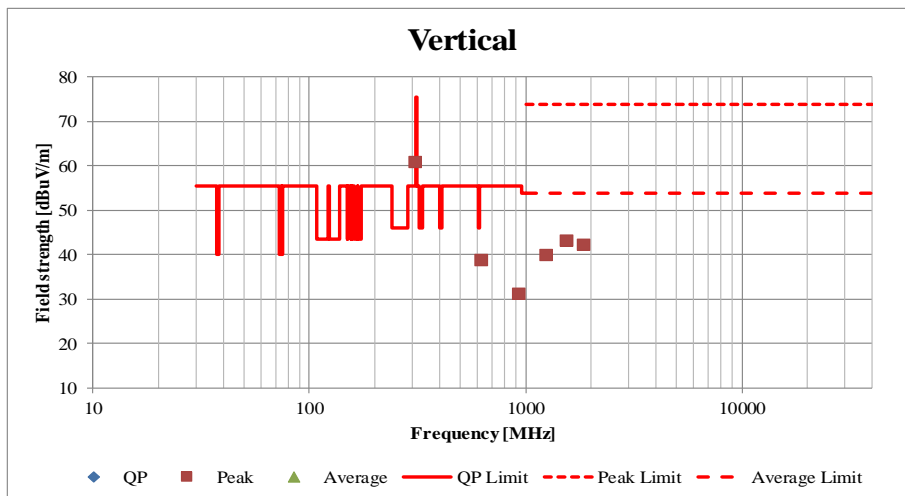
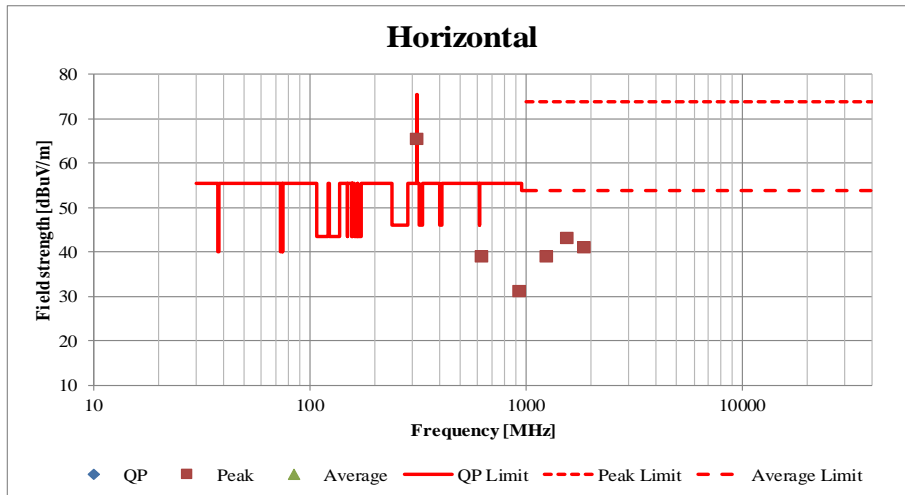

*These plots data contains sufficient number to show the trend of characteristic features for EUT.

-20 dB and 99 % Occupied Bandwidth
312.10 MHz / 314.35 MHz

Report No. 13523439H
Test place Ise EMC Lab.
Semi Anechoic Chamber No.4
Date October 14, 2020
Temperature / Humidity 21 deg. C / 55 % RH
Engineer Shinya Watanabe
Mode Transmitting mode, 312.10 MHz / 314.35 MHz

Bandwidth Limit : Fundamental Frequency **312.10** MHz x 0.25% = 780.25 kHz

* The above limit was calculated from more stringent nominal frequency.

* Method of KDB 926416 for systems employing non sweeping frequencies was referred.

312.10 MHz

-20dB Bandwidth [kHz]
38.267

314.35 MHz

-20dB Bandwidth [kHz]
38.204

-20dB Bandwidth [kHz]	Bandwidth Limit [kHz]	Result
76.471	780.25	Pass

Bandwidth Limit : Fundamental Frequency **312.10** MHz x 0.25% = 780.25 kHz

99% Occupied Bandwidth [kHz]	Bandwidth Limit [kHz]	Result
38.4536	780.25	Pass

Bandwidth Limit : Fundamental Frequency **314.35** MHz x 0.25% = 785.88 kHz

99% Occupied Bandwidth [kHz]	Bandwidth Limit [kHz]	Result
38.4522	785.88	Pass

-20 dB and 99 % Occupied Bandwidth
312.10 MHz / 314.35 MHz

Report No. 13523439H
 Test place Ise EMC Lab.
 Semi Anechoic Chamber No.4
 Date October 14, 2020
 Temperature / Humidity 21 deg. C / 55 % RH
 Engineer Shinya Watanabe
 Mode Transmitting mode, 312.10 MHz / 314.35 MHz

[312.10 MHz]

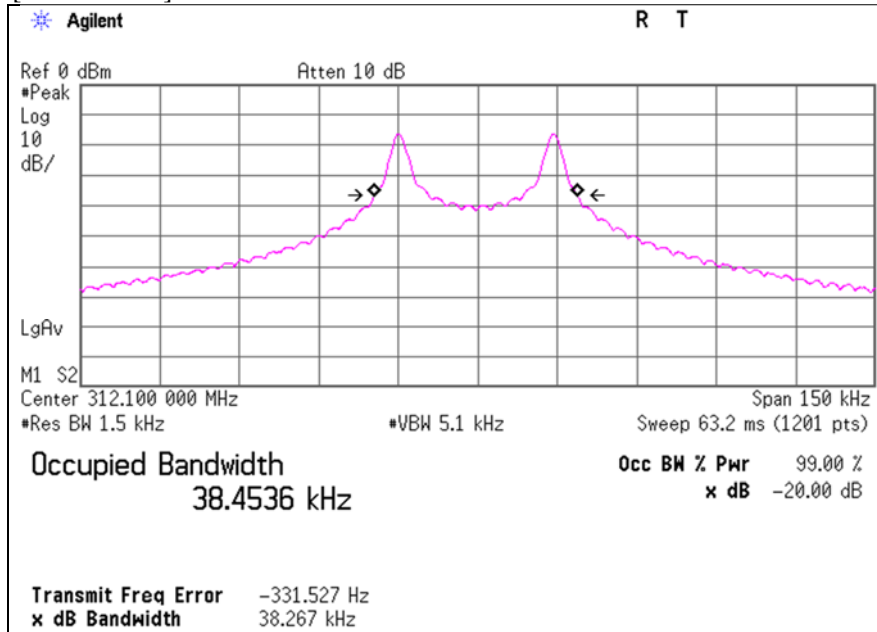

[314.35 MHz]

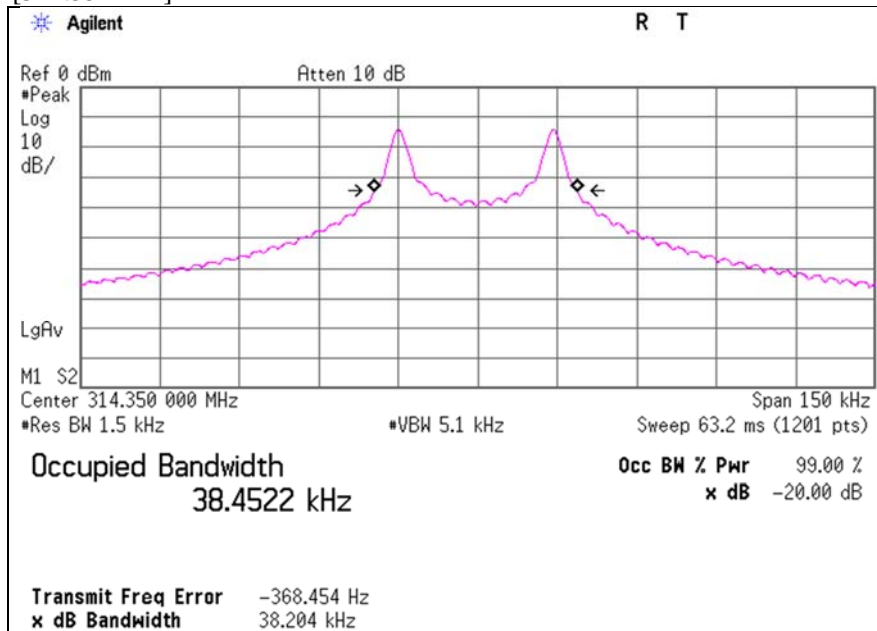

APPENDIX 2: Test instruments

Test equipment

Test Item	Local ID	LIMS ID	Description	Manufacturer	Model	Serial	Last Calibration Date	Cal Int
RE	MAEC-04	142011	AC4_Semi Anechoic Chamber(NSA)	TDK	Semi Anechoic Chamber 3m	DA-10005	05/25/2020	24
RE	MOS-15	141562	Thermo-Hygrometer	CUSTOM. Inc	CTH-201	0010	01/07/2020	12
RE	MBA-05	141425	Biconical Antenna	Schwarzbeck Mess - Elektronik	VHA9103+BBA9106	VHA 91031302	08/31/2020	12
RE	MLA-23	141267	Logperiodic Antenna (200-1000MHz)	Schwarzbeck Mess - Elektronik	VUSLP9111B	9111B-192	09/02/2020	12
RE	MAT-34	141331	Attenuator(6dB)	TME	UFA-01	-	02/05/2020	12
RE	MCC-50	141397	Coaxial Cable	UL Japan	-	-	03/24/2020	12
RE	MPA-14	141583	Pre Amplifier	SONOMA INSTRUMENT	310	260833	02/18/2020	12
RE	MSA-15	141902	Spectrum Analyzer	Keysight Technologies Inc	E4440A	MY46187105	10/15/2020	12
RE	MTR-03	141942	Test Receiver	Rohde & Schwarz	ESCI	100300	08/18/2020	12
RE	MAEC-04-SVSWR	142017	AC4_Semi Anechoic Chamber(SVSWR)	TDK	Semi Anechoic Chamber 3m	DA-10005	04/04/2019	24
RE	MHA-21	141508	Horn Antenna 1-18GHz	Schwarzbeck Mess - Elektronik	BBHA9120D	557	05/22/2020	12
RE	MCC-246	199563	Microwave Cable	HUBER+SUNER	SF126E/11PC35/11PC35/1000M,5000M	537061/126E / 537072/126E	06/11/2020	12
RE	MPA-12	141581	MicroWave System Amplifier	Keysight Technologies Inc	83017A	00650	10/19/2020	12
RE	COTS-ME MI-02	178648	EMI measurement program	TSJ (Techno Science Japan)	TEPTO-DV	-	-	-
RE	MAEC-02	142004	AC2_Semi Anechoic Chamber(NSA)	TDK	Semi Anechoic Chamber 3m	DA-06902	05/26/2020	24
RE	MOS-41	192300	Thermo-Hygrometer	CUSTOM. Inc	CTH-201	0013	12/19/2019	12
RE	MMM-01	141542	Digital Tester	Fluke Corporation	FLUKE 26-3	78030611	08/18/2020	12
RE	MJM-27	142228	Measure	KOMELON	KMC-36	-	-	-
RE	MLPA-07	142645	Loop Antenna	UL Japan	-	-	-	-
RE	MRENT-1 46	185691	Spectrum Analyzer	Keysight Technologies Inc	N9020A	MY55400351	09/23/2020	12
RE	MLPA-07	142645	Loop Antenna	UL Japan	-	-	-	-

*Hyphens for Last Calibration Date and Cal Int (month) are instruments that Calibration is not required (e.g. software), or instruments checked in advance before use.

The expiration date of the calibration is the end of the expired month.

As for some calibrations performed after the tested dates, those test equipment have been controlled by means of an unbroken chains of calibrations.

All equipment is calibrated with valid calibrations. Each measurement data is traceable to the national or international standards.

Test item:

RE: Radiated emission, 99 % Occupied Bandwidth, -20 dB bandwidth and Automatically deactivate tests

UL Japan, Inc.

Ise EMC Lab.

4383-326 Asama-cho, Ise-shi, Mie-ken 516-0021 JAPAN

Telephone : +81 596 24 8999

Facsimile : +81 596 24 8124