



RADIO TEST REPORT

Test Report No. : 11796055H

Applicant : **DENSO CORPORATION**
Type of Equipment : **Smart Card Key**
Model No. : **14CBH**
Test regulation : **FCC Part 15 Subpart C: 2017**
FCC ID : **HYQ14CBH**
Test Result : **Complied**

1. This test report shall not be reproduced in full or partial, without the written approval of UL Japan, Inc.
2. The results in this report apply only to the sample tested.
3. This sample tested is in compliance with above regulation.
4. The test results in this report are traceable to the national or international standards.
5. This test report must not be used by the customer to claim product certification, approval, or endorsement by NVLAP, NIST, or any agency of the Federal Government.
6. This test report covers Radio technical requirements. It does not cover administrative issues such as Manual or non-Radio test related Requirements. (if applicable)

Date of test: June 12, 2017

Representative test engineer: 

Shuichi Ohyama
Engineer
Consumer Technology Division

Approved by: 

Motoya Imura
Engineer
Consumer Technology Division

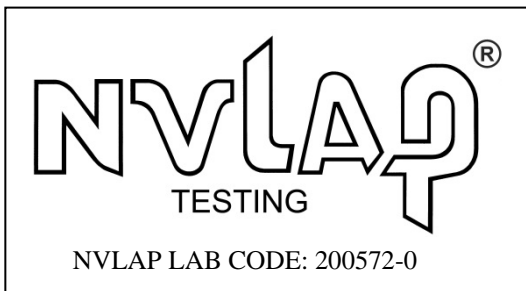

This laboratory is accredited by the NVLAP LAB CODE 200572-0, U.S.A. The tests reported herein have been performed in accordance with its terms of accreditation.
*As for the range of Accreditation in NVLAP, you may refer to the WEB address,
http://japan.ul.com/resources/emc_accredited/

CONTENTS	PAGE
SECTION 1: Customer information	4
SECTION 2: Equipment under test (E.U.T.)	4
SECTION 3: Test specification, procedures & results	5
SECTION 4: Operation of E.U.T. during testing	8
SECTION 5: Radiated emission (Electric Field Strength of Fundamental and Spurious Emission)	10
SECTION 6: Automatically deactivate	11
SECTION 7: -20 dB and 99 % Occupied Bandwidth	11
APPENDIX 1: Test data	12
Automatically deactivate.....	12
Radiated Emission (Electric Field Strength of Fundamental and Spurious Emission).....	13
-20dB and 99% Occupied Bandwidth.....	16
APPENDIX 2: Test Instruments	18
APPENDIX 3: Photographs of test setup	19
Radiated emission	19
Worst case position	20

SECTION 1: Customer information

Company Name : DENSO CORPORATION
Address : 1-1 Showa-cho, Kariya-shi, Aichi-ken, 448-8661 Japan
Telephone Number : +81-566-20-3955
Facsimile Number : +81-566-25-4837
Contact Person : TAKAYUKI HATTORI

SECTION 2: Equipment under test (E.U.T.)

2.1 Identification of E.U.T.

Type of Equipment : Smart Card Key
Model No. : 14CBH
Serial No. : Refer to Clause 4.2
Rating : DC 3.0 V
Receipt Date of Sample : June 1, 2017
Country of Mass-production : Japan
Condition of EUT : Engineering prototype
(Not for Sale: This sample is equivalent to mass-produced items.)
Modification of EUT : No Modification by the test lab

2.2 Product Description

Model No: 14CBH (referred to as the EUT in this report) is the Smart Card Key.

Radio Type : Transceiver
Frequency of Operation : 314.35 MHz / 312.10 MHz*
*These two different frequencies are not emitted simultaneously.
Clock frequency(ies) in the system : 8 MHz (IC Clock)
18.370 MHz Crystal (RF)
Modulation : FSK (F1D)
Power Supply (radio part input) : DC 3.0 V
Type of Battery : One lithium battery
Antenna type : Built-in type (Fixed)
Receiving frequency of Operation : 134.2 kHz *1)

*1) The test of receiver part was performed separately from this test report, and the conformability is confirmed.

UL Japan, Inc.

Ise EMC Lab.

4383-326 Asama-cho, Ise-shi, Mie-ken 516-0021 JAPAN

Telephone : +81 596 24 8999

Facsimile : +81 596 24 8124

SECTION 3: Test specification, procedures & results

3.1 Test Specification

Test Specification : FCC Part 15 Subpart C
FCC Part 15 final revised on June 14, 2017 and effective July 14, 2017

Title : FCC 47CFR Part15 Radio Frequency Device Subpart C Intentional Radiators
Section 15.231 Periodic operation in the band 40.66 - 40.70MHz
and above 70MHz

* The revision on June 14, 2017, does not affect the test specification applied to the EUT.

3.2 Procedures and results

Item	Test Procedure	Specification	Worst margin	Results	Remarks
Conducted emission	FCC: ANSI C63.10:2013 6 Standard test methods	FCC: Section 15.207	N/A	N/A*1)	-
	IC: RSS-Gen 8.8	IC: RSS-Gen 8.8			
Automatically Deactivate	FCC: ANSI C63.10:2013 6 Standard test methods	FCC: Section 15.231(a)(1)	N/A	Complied	Radiated
	IC: -	IC: RSS-210 A1.1			
Electric Field Strength of Fundamental Emission	FCC: ANSI C63.10:2013 6 Standard test methods	FCC: Section 15.231(b)	11.9 dB Horizontal PK with Duty factor (Tx 312.10 MHz)	Complied	Radiated
	IC: RSS-Gen 6.12	IC: RSS-210 A1.2			
Electric Field Strength of Spurious Emission	FCC: ANSI C63.10:2013 6 Standard test methods	FCC: Section 15.205 Section 15.209 Section 15.231(b)	7.6 dB 2829.150 MHz Horizontal PK with Duty factor (Tx 314.35 MHz)	Complied	Radiated
	IC: RSS-Gen 6.13	IC: RSS-210 A1.2, 4.4 RSS-Gen 8.9			
-20dB Bandwidth	FCC: ANSI C63.10:2013 6 Standard test methods	FCC: Section 15.231(c)	N/A	Complied	Radiated
	IC: -	IC: Reference data			

Note: UL Japan, Inc.'s EMI Work Procedures No. 13-EM-W0420 and 13-EM-W0422.
*1) The test is not applicable since the EUT does not have AC Mains.

FCC 15.31 (e)

This test was performed with the New Battery (DC 3.0 V) during the tests. Therefore, the EUT complies with the requirement.

FCC Part 15.203 Antenna requirement

It is impossible for end users to replace the antenna, because the antenna is mounted inside of the EUT. Therefore, the equipment complies with the antenna requirement of Section 15.203.

UL Japan, Inc.

Ise EMC Lab.

4383-326 Asama-cho, Ise-shi, Mie-ken 516-0021 JAPAN

Telephone : +81 596 24 8999

Facsimile : +81 596 24 8124

3.3 Addition to standard

Item	Test Procedure	Specification	Worst margin	Results	Remarks
99 % Occupied Bandwidth	IC: RSS-Gen 6.6	IC: RSS-210 A1.1.3	N/A	Complied	Radiated

Other than above, no addition, exclusion nor deviation has been made from the standard.

3.4 Uncertainty

EMI

The following uncertainties have been calculated to provide a confidence level of 95 % using a coverage factor $k = 2$.

Polarity	Radiated emission (Below 1 GHz)			
	(3 m*)(+/-)		(10 m*)(+/-)	
	30 MHz - 200 MHz	200 MHz - 1000 MHz	30 MHz - 200 MHz	200 MHz - 1000 MHz
Horizontal	5.0 dB	5.3 dB	5.0 dB	5.0 dB
Vertical	4.7 dB	5.9 dB	5.0 dB	5.1 dB

Radiated emission (Above 1 GHz)				
(3 m*)(+/-)		(1 m*)(+/-)		(10 m*)(+/-)
1 GHz - 6 GHz	6 GHz - 18 GHz	10 GHz - 26.5 GHz	26.5 GHz - 40 GHz	1 GHz -18 GHz
5.2 dB	5.4 dB	5.5 dB	5.5 dB	5.4 dB

* Measurement distance

Radiated emission test(3 m)

The data listed in this test report has enough margin, more than the site margin.

UL Japan, Inc.

Ise EMC Lab.

4383-326 Asama-cho, Ise-shi, Mie-ken 516-0021 JAPAN

Telephone : +81 596 24 8999

Facsimile : +81 596 24 8124

3.5 Test Location

UL Japan, Inc. Ise EMC Lab. *NVLAP Lab. code: 200572-0
4383-326 Asama-cho, Ise-shi, Mie-ken 516-0021 JAPAN
Telephone : +81 596 24 8999 Facsimile : +81 596 24 8124

	IC Registration Number	Width x Depth x Height (m)	Size of reference ground plane (m) / horizontal conducting plane	Other rooms
No.1 semi-anechoic chamber	2973C-1	19.2 x 11.2 x 7.7m	7.0 x 6.0m	No.1 Power source room
No.2 semi-anechoic chamber	2973C-2	7.5 x 5.8 x 5.2m	4.0 x 4.0m	-
No.3 semi-anechoic chamber	2973C-3	12.0 x 8.5 x 5.9m	6.8 x 5.75m	No.3 Preparation room
No.3 shielded room	-	4.0 x 6.0 x 2.7m	N/A	-
No.4 semi-anechoic chamber	2973C-4	12.0 x 8.5 x 5.9m	6.8 x 5.75m	No.4 Preparation room
No.4 shielded room	-	4.0 x 6.0 x 2.7m	N/A	-
No.5 semi-anechoic chamber	-	6.0 x 6.0 x 3.9m	6.0 x 6.0m	-
No.6 shielded room	-	4.0 x 4.5 x 2.7m	4.0 x 4.5 m	-
No.6 measurement room	-	4.75 x 5.4 x 3.0m	4.75 x 4.15 m	-
No.7 shielded room	-	4.7 x 7.5 x 2.7m	4.7 x 7.5m	-
No.8 measurement room	-	3.1 x 5.0 x 2.7m	N/A	-
No.9 measurement room	-	8.0 x 4.6 x 2.8m	2.4 x 2.4m	-
No.11 measurement room	-	6.2 x 4.7 x 3.0m	4.8 x 4.6m	-

* Size of vertical conducting plane (for Conducted Emission test): 2.0 x 2.0m for No.1, No.2, No.3, and No.4 semi-anechoic chambers and No.3 and No.4 shielded rooms.

3.6 Test data, Test instruments, and Test set up.

Refer to APPENDIX.

SECTION 4: Operation of E.U.T. during testing

4.1 Operating Modes

Test Item	Mode
Automatically Deactivate	Normal use mode, 314.35 MHz *1) Normal use mode, 312.10 MHz *1)
Electric Field Strength of Fundamental Emission Electric Field Strength of Spurious Emission -20dB & 99% Occupied Bandwidth	Transmitting mode (Tx), 314.35 MHz *2) Transmitting mode (Tx), 312.10 MHz *2)
* The system was configured in typical fashion (as a customer would normally use it) for testing. *1) The EUT transmits only when it receives 134.2kHz radio signal. End users cannot change the settings of the output power of the product. *2) The software of this mode is the same as one of normal product, except that EUT continues to transmit when transmitter button is being pressed. This button was attached just for testing.(for making continuous transmission)	

UL Japan, Inc.

Ise EMC Lab.

4383-326 Asama-cho, Ise-shi, Mie-ken 516-0021 JAPAN

Telephone : +81 596 24 8999

Facsimile : +81 596 24 8124

4.2 Configuration and peripherals

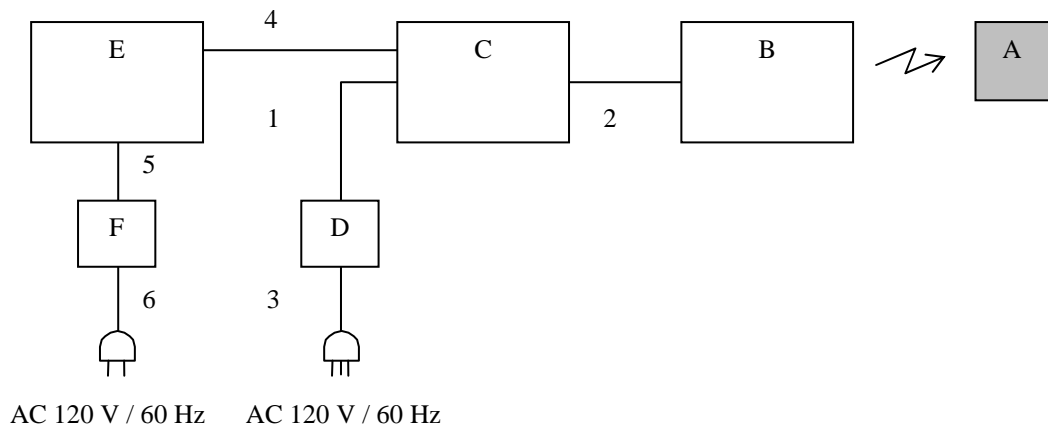

* Cabling and setup(s) were taken into consideration and test data was taken under worse case conditions.

Description of EUT and Support equipment

No.	Item	Model number	Serial number	Manufacturer	Remarks
A	Smart Card Key	14CBH	002 *1) 001 *2)	DENSO CORPORATION	EUT
B	Door handle unit	-	-	DENSO CORPORATION	*1)
C	Test bench	-	-	DENSO CORPORATION	*1)
D	AC Adapter	-	-	DENSO CORPORATION	*1)
E	Laptop PC	PB453JNA125AA71	8E053638H	TOSHIBA	*1)
F	AC Adapter	PA3917U-1ACA	T0214100015699A	TOSHIBA	*1)

*1) Used for Normal use mode only.

*2) Used for Transmitting mode only.

List of cables used

No.	Name	Length (m)	Shield		Remark
			Cable	Connector	
1	DC Cable	1.5	Unshielded	Unshielded	*1)
2	DC and Signal Cable	0.8	Unshielded	Unshielded	*1)
3	AC Cable	2.0	Unshielded	Unshielded	*1)
4	USB Cable	1.8	Shielded	Shielded	*1)
5	DC Cable	1.7	Unshielded	Unshielded	*1)
6	AC Cable	0.9	Unshielded	Unshielded	*1)

*1) Used for Normal use mode only.

UL Japan, Inc.

Ise EMC Lab.

4383-326 Asama-cho, Ise-shi, Mie-ken 516-0021 JAPAN

Telephone : +81 596 24 8999

Facsimile : +81 596 24 8124

SECTION 5: Radiated emission (Electric Field Strength of Fundamental and Spurious Emission)

Test Procedure and conditions

[For below 1GHz]

EUT was placed on a urethane platform of nominal size, 0.5 m by 1.0 m, raised 0.8 m above the conducting ground plane. The Radiated Electric Field Strength has been measured in a Semi Anechoic Chamber with a ground plane.

[For above 1GHz]

EUT was placed on a urethane platform of nominal size, 0.5 m by 0.5 m, raised 1.5 m above the conducting ground plane. The Radiated Electric Field Strength has been measured in a Semi Anechoic Chamber with absorbent materials lined on a ground plane.

Test was made with the antenna positioned in both the horizontal and vertical planes of polarization. The measurement antenna was varied in height above the conducting ground plane to obtain the maximum signal strength. Photographs of the set up are shown in Appendix 3.

**[Transmitting mode]
(Below 30 MHz)**

The noise level was checked by moving a search-coil (Loop Antenna) close to the EUT.

(Above 30 MHz)

The Radiated Electric Field Strength has been measured on Semi anechoic chamber with a ground plane and at a distance of 3 m.

The measuring antenna height was varied between 1 and 4 m and EUT was rotated a full revolution in order to obtain the maximum value of the electric field strength.

The measurements were performed for both vertical and horizontal antenna polarization.

The radiated emission measurements were made with the following detector function of the test receiver / spectrum analyzer.

Test Antennas are used as below;

Frequency	Below 30 MHz	30 MHz to 200 MHz	200 MHz to 1 GHz	Above 1 GHz
Antenna Type	Loop	Biconical	Logperiodic	Horn

	From 9 kHz to 90 kHz and From 110 kHz to 150 kHz	From 90 kHz to 110 kHz	From 150 kHz to 490 kHz	From 490 kHz to 30 MHz	From 30 MHz to 1 GHz	Above 1 GHz
Detector Type	Peak	Peak	Peak	Peak	Peak and Peak with Duty factor	Peak and Peak with Duty factor
IF Bandwidth	200 Hz	200 Hz	9.1 kHz	9.1 kHz	120 kHz	PK: S/A: RBW 1 MHz, VBW: 3 MHz

- The carrier level (or, noise levels) was (or were) measured at each position of all three axes X, Y and Z, and the position that has the maximum noise was determined.

Noise levels of all the frequencies were measured at the position.

This EUT has two modes which mechanical key is inserted or not. The worst case was confirmed with and without mechanical key, as a result, the test with mechanical key was the worst case. Therefore the test with mechanical key was performed only.

*The result is rounded off to the second decimal place, so some differences might be observed.

UL Japan, Inc.

Ise EMC Lab.

4383-326 Asama-cho, Ise-shi, Mie-ken 516-0021 JAPAN

Telephone : +81 596 24 8999

Facsimile : +81 596 24 8124

Measurement range : 9 kHz - 3.2 GHz
Test data : APPENDIX
Test result : Pass

SECTION 6: Automatically deactivate

Test Procedure

The measurement was performed with Electric field strength using a spectrum analyzer.

Test data : APPENDIX
Test result : Pass

SECTION 7: -20 dB and 99 % Occupied Bandwidth

Test Procedure

The test was measured with a spectrum analyzer using a test fixture.

Test	Span	RBW	VBW	Sweep	Detector	Trace	Instrument used
20 dB Bandwidth	150 kHz	1.5 kHz	5.1 kHz	Auto	Peak	Max Hold	Spectrum Analyzer
99 % Occupied Bandwidth	Enough width to display emission skirts	1 to 5 % of OBW	Three times of RBW	Auto	Peak	Max Hold	Spectrum Analyzer

Peak hold was applied as Worst-case measurement.

Test data : APPENDIX
Test result : Pass

APPENDIX 1: Test data

Automatically deactivate

Test place	Ise EMC Lab. No.3 Measurement Room
Report No.	11796055H
Date	06/12/2017
Temperature/ Humidity	25 deg. C / 37% RH
Engineer	Shuichi Ohyama
Mode	Normal use mode

Tx Freq	Time of Transmitting [sec]	Limit [sec]	Result
314.35 MHz	0.1526	5.00	Pass
312.10 MHz	0.1515	5.00	Pass

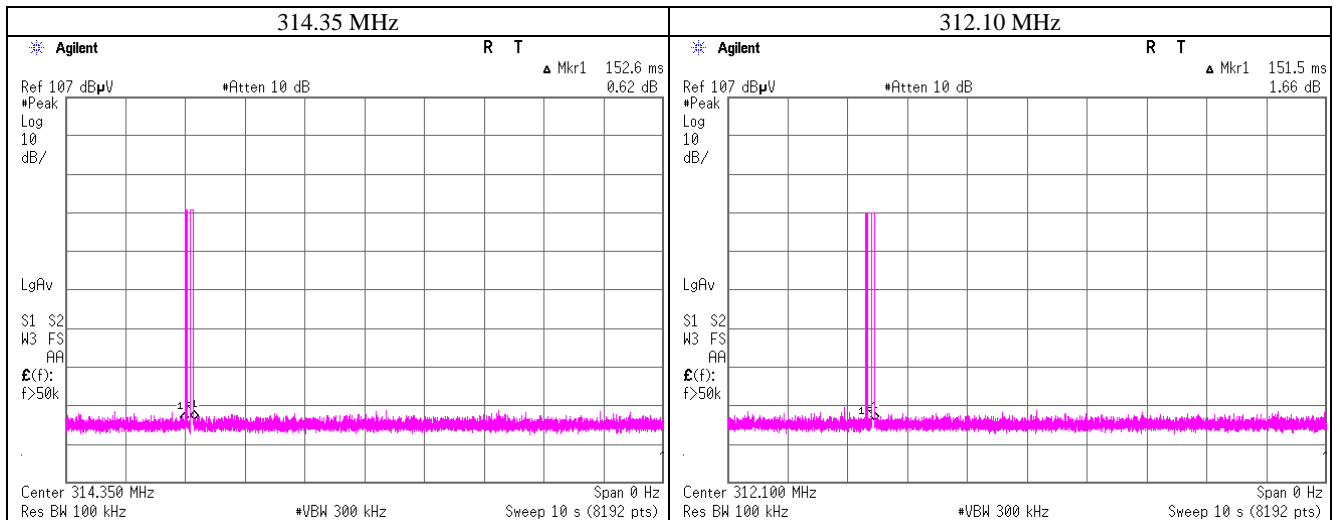

Radiated Emission (Electric Field Strength of Fundamental and Spurious Emission)

Test place Ise EMC Lab. No.3 Semi Anechoic Chamber
Report No. 11796055H
Date 06/12/2017 06/12/2017
Temperature/ Humidity 25 deg. C / 37% RH 24 deg. C / 40 % RH
Engineer Shuichi Ohyama Takafumi Noguchi
(Below 1GHz) (Above 1GHz)
Mode Transmitting mode 314.35 MHz

PK

Frequency [MHz]	Detector	Reading [dBuV]		Ant Factor [dB/m]	Loss [dB]	Gain [dB]	Duty Factor [dB]	Result [dBuV/m]		Limit dBuV/m	Margin [dB]		Remark Inside or Outside of Restricted Bands
		Hor	Ver					Hor	Ver		Hor	Ver	
314.350	PK	71.3	66.8	13.8	10.1	32.0	-	63.2	58.7	95.5	32.3	36.8	Carrier
628.700	PK	37.6	38.0	19.2	12.1	32.1	-	36.8	37.2	75.5	38.7	38.3	Outside
943.050	PK	30.1	29.7	22.2	13.6	30.8	-	35.1	34.7	75.5	40.4	40.8	Outside
1257.400	PK	44.5	44.7	24.9	5.3	34.2	-	40.5	40.7	75.5	35.0	34.8	Outside
1571.750	PK	42.5	42.4	25.7	5.5	33.3	-	40.4	40.3	73.9	33.5	33.6	Inside
1886.100	PK	45.3	44.6	27.0	5.7	32.5	-	45.5	44.8	75.5	30.0	30.7	Outside
2200.450	PK	44.6	41.4	27.7	5.9	32.2	-	46.0	42.8	73.9	27.9	31.1	Inside
2514.800	PK	43.1	43.1	28.1	6.1	32.1	-	45.2	45.2	75.5	30.3	30.3	Outside
2829.150	PK	43.9	43.1	28.2	6.2	32.0	-	46.3	45.5	73.9	27.6	28.4	Inside
3143.500	PK	41.0	40.8	28.4	6.4	31.8	-	44.0	43.8	75.5	31.5	31.7	Outside

Result = Reading + Ant Factor + Loss (Cable+Attenuator+Filter) - Gain(Amplifier)

PK with Duty factor

Frequency [MHz]	Detector	Reading [dBuV]		Ant Factor [dB/m]	Loss [dB]	Gain [dB]	Duty Factor [dB]	Result [dBuV/m]		Limit dBuV/m	Margin [dB]		Remark
		Hor	Ver					Hor	Ver		Hor	Ver	
314.350	PK	71.3	66.8	13.8	10.1	32.0	0.0	63.2	58.7	75.5	12.3	16.8	Carrier
628.700	PK	37.6	38.0	19.2	12.1	32.1	0.0	36.8	37.2	55.5	18.7	18.3	Outside
943.050	PK	30.1	29.7	22.2	13.6	30.8	0.0	35.1	34.7	55.5	20.4	20.8	Outside
1257.400	PK	44.5	44.7	24.9	5.3	34.2	0.0	40.5	40.7	55.5	15.0	14.8	Outside
1571.750	PK	42.5	42.4	25.7	5.5	33.3	0.0	40.4	40.3	53.9	13.5	13.6	Inside
1886.100	PK	45.3	44.6	27.0	5.7	32.5	0.0	45.5	44.8	55.5	10.0	10.7	Outside
2200.450	PK	44.6	41.4	27.7	5.9	32.2	0.0	46.0	42.8	53.9	7.9	11.1	Inside
2514.800	PK	43.1	43.1	28.1	6.1	32.1	0.0	45.2	45.2	55.5	10.3	10.3	Outside
2829.150	PK	43.9	43.1	28.2	6.2	32.0	0.0	46.3	45.5	53.9	7.6	8.4	Inside
3143.500	PK	41.0	40.8	28.4	6.4	31.8	0.0	44.0	43.8	55.5	11.5	11.7	Outside

Result = Reading + Ant Factor + Loss (Cable+Attenuator+Filter) - Gain(Amplifier) + Duty factor

*Other frequency noises omitted in this report were not seen or had enough margin (more than 20dB).

Sample calculation:

Result of PK = Reading + Ant Factor + Loss (Cable + Attenuator + Filter) - Gain (Amplifier)

Result of PK with Duty factor = Reading + Ant Factor + Loss (Cable + Attenuator + Filter) - Gain (Amplifier) + Duty factor

For above 1GHz : Distance Factor: 20 x log (4.5 m/3.0 m) = 3.52 dB

*Other frequency noises omitted in this report were not seen or had enough margin (more than 20dB).

Since the peak emission result satisfied the average limit, duty factor was omitted.

The result of AV (PK with Duty factor) was calculated by applying Duty 100%.

UL Japan, Inc.

Ise EMC Lab.

4383-326 Asama-cho, Ise-shi, Mie-ken 516-0021 JAPAN

Telephone : +81 596 24 8999

Facsimile : +81 596 24 8124

Radiated Emission (Electric Field Strength of Fundamental and Spurious Emission)

Test place : Ise EMC Lab. No.3 Semi Anechoic Chamber
Report No. : 11796055H
Date : 06/12/2017
Temperature/ Humidity : 25 deg. C / 37% RH
Engineer : Shuichi Ohyama (Below 1GHz)
: Takafumi Noguchi (Above 1GHz)
Mode : Transmitting mode 312.10 MHz

PK

Frequency [MHz]	Detector	Reading [dBuV]		Ant Factor [dB/m]	Loss [dB]	Gain [dB]	Duty Factor [dB]	Result [dBuV/m]		Limit dBuV/m	Margin [dB]		Remark Inside or Outside of Restricted Bands
		Hor	Ver					Hor	Ver		Hor	Ver	
312.100	PK	71.7	66.9	13.7	10.1	32.0	-	63.5	58.7	95.4	31.9	36.7	Carrier
624.200	PK	34.3	36.5	19.2	12.0	32.1	-	33.4	35.6	75.4	42.0	39.8	Outside
936.300	PK	29.4	29.1	22.2	13.6	30.8	-	34.4	34.1	75.4	41.0	41.3	Outside
1248.400	PK	44.5	44.1	25.2	7.2	34.3	-	42.6	42.2	75.4	32.8	33.2	Outside
1560.500	PK	42.2	42.2	25.8	6.8	33.5	-	41.3	41.3	73.9	32.6	32.6	Inside
1872.600	PK	44.7	43.3	26.6	6.7	32.9	-	45.1	43.7	75.4	30.3	31.7	Outside
2184.700	PK	43.5	41.4	27.3	6.8	32.5	-	45.1	43.0	75.4	30.3	32.4	Outside
2496.800	PK	41.3	41.5	27.8	6.9	32.4	-	43.6	43.8	73.9	30.3	30.1	Inside
2808.900	PK	41.5	41.8	28.6	7.0	32.2	-	44.9	45.2	73.9	29.0	28.7	Inside
3121.000	PK	41.2	41.2	29.2	7.1	32.1	-	45.4	45.4	75.4	30.0	30.0	Outside

Result = Reading + Ant Factor + Loss (Cable+Attenuator+Filter) - Gain(Amplifier)

PK with Duty factor

Frequency [MHz]	Detector	Reading [dBuV]		Ant Factor [dB/m]	Loss [dB]	Gain [dB]	Duty Factor [dB]	Result [dBuV/m]		Limit dBuV/m	Margin [dB]		Remark
		Hor	Ver					Hor	Ver		Hor	Ver	
312.100	PK	71.7	66.9	13.7	10.1	32.0	0.0	63.5	58.7	75.4	11.9	16.7	Carrier
624.200	PK	34.3	36.5	19.2	12.0	32.1	0.0	33.4	35.6	55.4	22.0	19.8	Outside
936.300	PK	29.4	29.1	22.2	13.6	30.8	0.0	34.4	34.1	55.4	21.0	21.3	Outside
1248.400	PK	44.5	44.1	25.2	7.2	34.3	0.0	42.6	42.2	55.4	12.8	13.2	Outside
1560.500	PK	42.2	42.2	25.8	6.8	33.5	0.0	41.3	41.3	53.9	12.6	12.6	Inside
1872.600	PK	44.7	43.3	26.6	6.7	32.9	0.0	45.1	43.7	55.4	10.3	11.7	Outside
2184.700	PK	43.5	41.4	27.3	6.8	32.5	0.0	45.1	43.0	55.4	10.3	12.4	Outside
2496.800	PK	41.3	41.5	27.8	6.9	32.4	0.0	43.6	43.8	53.9	10.3	10.1	Inside
2808.900	PK	41.5	41.8	28.6	7.0	32.2	0.0	44.9	45.2	53.9	9.0	8.7	Inside
3121.000	PK	41.2	41.2	29.2	7.1	32.1	0.0	45.4	45.4	55.4	10.0	10.0	Outside

Result = Reading + Ant Factor + Loss (Cable+Attenuator+Filter) - Gain(Amplifier) + Duty factor

*Other frequency noises omitted in this report were not seen or had enough margin (more than 20dB).

Sample calculation:

Result of PK = Reading + Ant Factor + Loss (Cable + Attenuator + Filter) - Gain (Amplifier)

Result of PK with Duty factor = Reading + Ant Factor + Loss (Cable + Attenuator + Filter) - Gain (Amplifier) + Duty factor

For above 1GHz : Distance Factor: $20 \times \log(4.5 \text{ m}/3.0 \text{ m}) = 3.52 \text{ dB}$

*Other frequency noises omitted in this report were not seen or had enough margin (more than 20dB).

Since the peak emission result satisfied the average limit, duty factor was omitted.

The result of AV (PK with Duty factor) was calculated by applying Duty 100%.

UL Japan, Inc.

Ise EMC Lab.

4383-326 Asama-cho, Ise-shi, Mie-ken 516-0021 JAPAN

Telephone : +81 596 24 8999

Facsimile : +81 596 24 8124

Radiated Spurious Emission

Test place	Ise EMC Lab. No.3 Semi Anechoic Chamber	
Report No.	11796055H	
Date	06/12/2017	06/12/2017
Temperature/ Humidity	25 deg. C / 37% RH	24 deg. C / 40 % RH
Engineer	Shuichi Ohyama (Below 1GHz)	Takafumi Noguchi (Above 1GHz)
Mode	Transmitting mode 312.10 MHz	

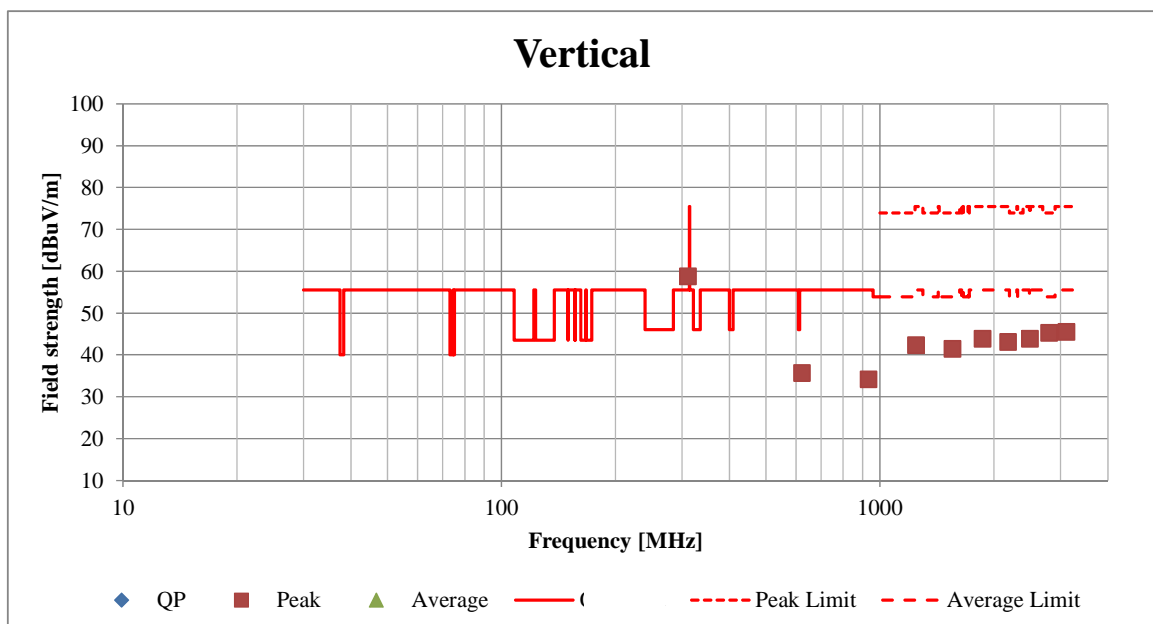
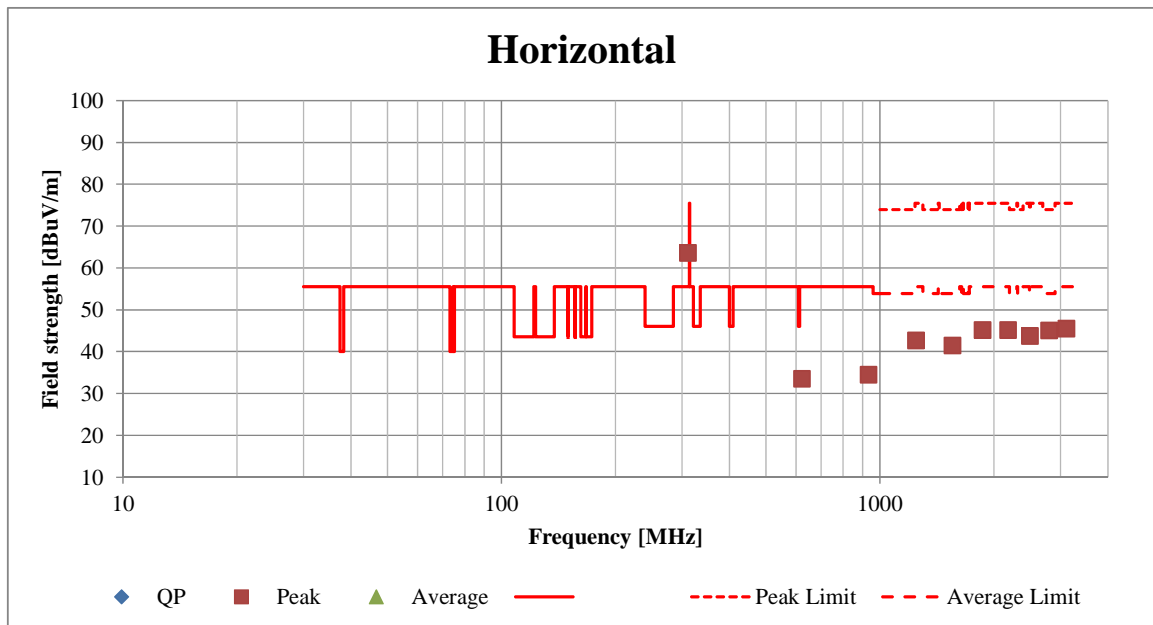

*These plots data contains sufficient number to show the trend of characteristic features for EUT.

-20dB and 99% Occupied Bandwidth

Test place Ise EMC Lab. No.3 Measurement Room
Report No. 11796055H
Date 06/12/2017
Temperature/ Humidity 25 deg. C / 37% RH
Engineer Shuichi Ohyama
Mode Transmitting mode 314.35 MHz / 312.10 MHz

Bandwidth Limit : Fundamental Frequency **312.10** MHz x 0.25% = 780.25 kHz

* The above limit was calculated from more stringent nominal frequency.

* Method of KDB 926416 for systems employing non sweeping frequencies was referred.

314.35 MHz

-20dB Bandwidth [kHz]
37.35

312.10MHz

-20dB Bandwidth [kHz]
37.34

-20dB Bandwidth [kHz]	Bandwidth Limit [kHz]	Result
37.35 + 37.34 = 74.69	780.25	Pass

Bandwidth Limit : Fundamental Frequency **314.35** MHz x 0.25% = 785.88 kHz

99% Occupied Bandwidth [kHz]	Bandwidth Limit [kHz]	Result
37.38	785.88	Pass

Bandwidth Limit : Fundamental Frequency **312.10** MHz x 0.25% = 780.25 kHz

99% Occupied Bandwidth [kHz]	Bandwidth Limit [kHz]	Result
37.38	780.25	Pass

-20dB and 99% Occupied Bandwidth

Test place Ise EMC Lab. No.3 Measurement Room
 Report No. 11796055H
 Date 06/12/2017
 Temperature/ Humidity 25 deg. C / 37% RH
 Engineer Shuichi Ohyama
 Mode Transmitting mode 314.35 MHz / 312.10 MHz

[314.35 MHz]

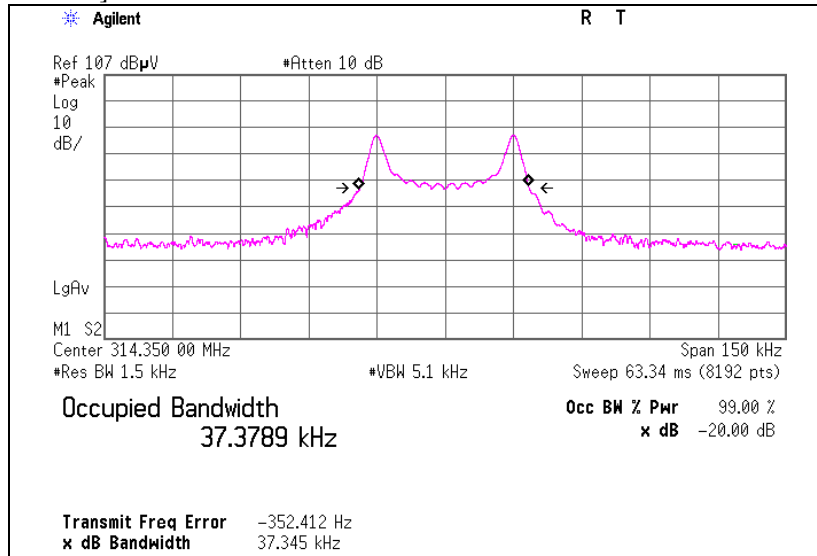

[312.10 MHz]

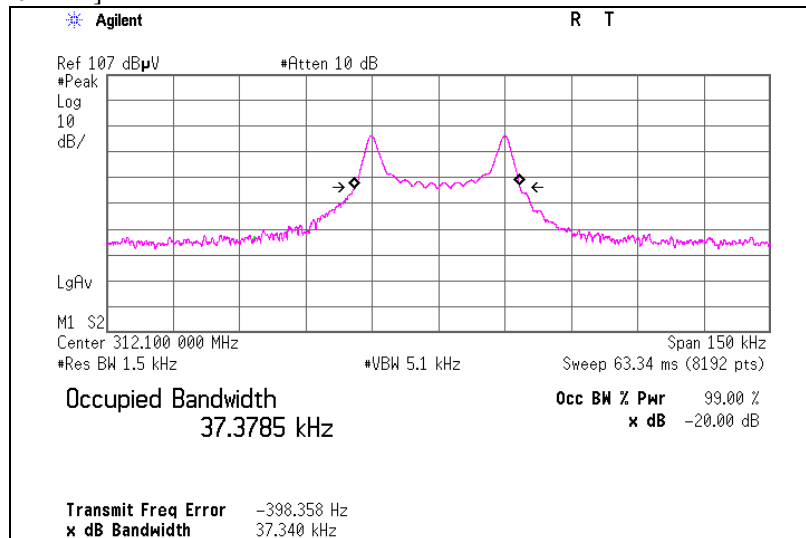

APPENDIX 2: Test Instruments

EMI test equipment

Control No.	Instrument	Manufacturer	Model No	Serial No	Test Item	Calibration Date * Interval(month)
MAEC-03	Semi Anechoic Chamber(NSA)	TDK	Semi Anechoic Chamber 3m	DA-10005	RE	2016/10/20 * 12
MOS-13	Thermo-Hygrometer	Custom	CTH-180	1301	RE	2017/01/20 * 12
MJM-16	Measure	KOMELON	KMC-36	-	RE	-
COTS-MEMI	EMI measurement program	TSJ	TEPTO-DV	-	RE	-
MSA-04	Spectrum Analyzer	Agilent	E4448A	US44300523	RE	2016/11/10 * 12
MTR-08	Test Receiver	Rohde & Schwarz	ESCI	100767	RE	2016/09/15 * 12
MBA-03	Biconical Antenna	Schwarzbeck	BBA9106	1915	RE	2016/10/15 * 12
MLA-22	Logperiodic Antenna(200-1000MHz)	Schwarzbeck	VUSLP9111B	911B-191	RE	2017/01/26 * 12
MCC-51	Coaxial cable	UL Japan	-	-	RE	2016/07/26 * 12
MAT-98	Attenuator	KEYSIGHT	8491A	MY52462349	RE	2016/12/05 * 12
MPA-13	Pre Amplifier	SONOMA INSTRUMENT	310	260834	RE	2017/03/27 * 12
MLPA-03	Loop Antenna	UL Japan	-	-	RE	Pre Check
MHA-20	Horn Antenna 1-18GHz	Schwarzbeck	BBHA9120D	258	RE	2017/05/22 * 12
MCC-167	Microwave Cable	Junkosha	MWX221	1404S374(1m) / 1405S074(5m)	RE	2017/05/29 * 12
MPA-11	MicroWave System Amplifier	Agilent	83017A	MY39500779	RE	2017/03/21 * 12
MHF-27	High Pass Filter(1.1-10GHz)	TOKYO KEIKI	TF219CD1	1001	RE	2017/01/16 * 12
MLPA-07	Loop Antenna	UL Japan	-	-	RE	Pre Check

The expiration date of the calibration is the end of the expired month.

All equipment is calibrated with valid calibrations. Each measurement data is traceable to the national or international standards.

As for some calibrations performed after the tested dates, those test equipment have been controlled by means of an unbroken chains of calibrations.

Test Item:

RE: Radiated emission, 99% Occupied Bandwidth, -20dB bandwidth, and Automatically deactivate tests

UL Japan, Inc.

Ise EMC Lab.

4383-326 Asama-cho, Ise-shi, Mie-ken 516-0021 JAPAN

Telephone : +81 596 24 8999

Facsimile : +81 596 24 8124