

(02-10)  
 U1 14 +5V  
 U1 7 GND

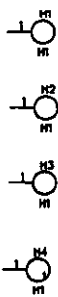

137

COMPANY:	MISTER CO.
TITLE:	ASZ-400 CCD BOARD (UPD3797C-1)
DATE:	1988/07/01
SIZE:	
ENGINEER:	
SHEET:	2 OF 3

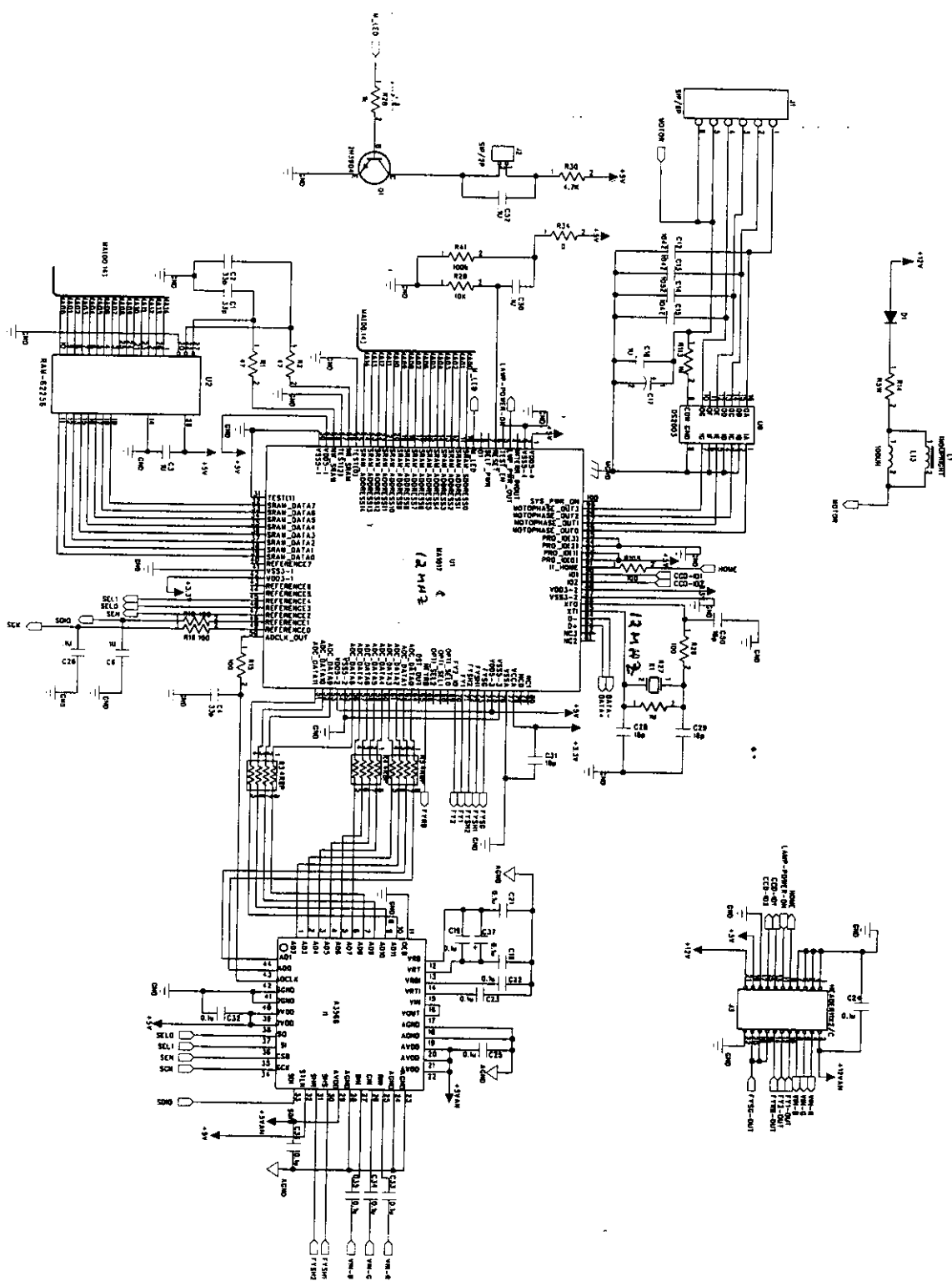

COMPANY : MUSTEK SYSTEMS INC.	
TITLE : C6U12	
SIZE : C	DATE : /20/99
ENGINEER : Kevin	REV : X1
SHEET : 1 OF 2	

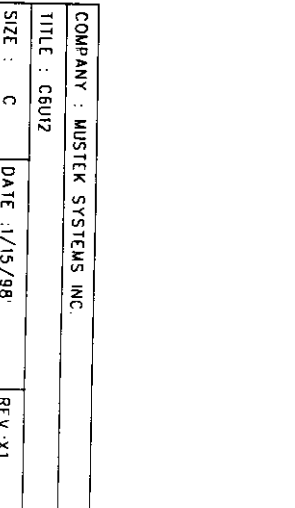
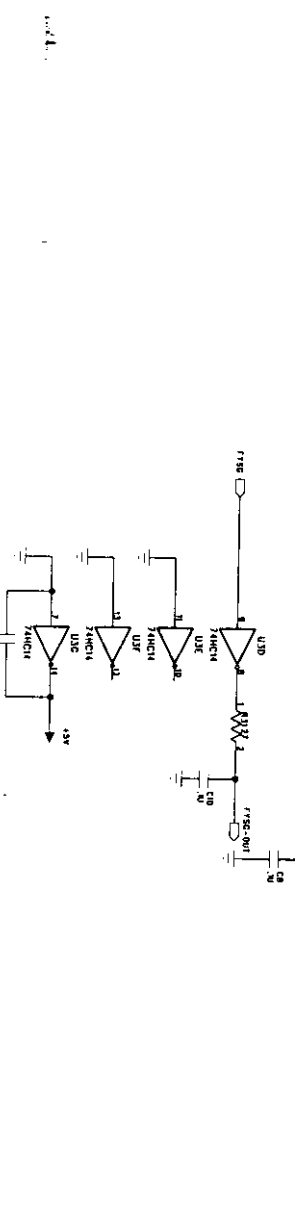
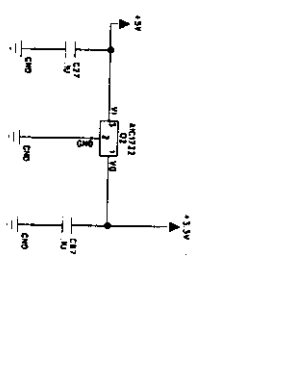
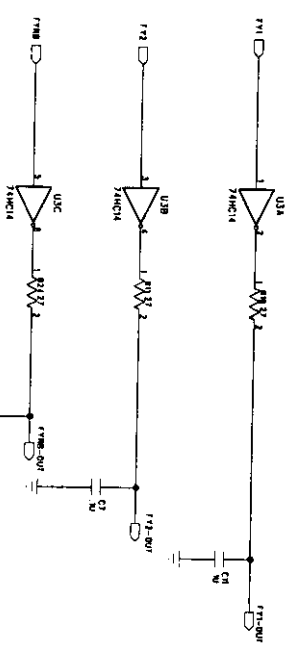
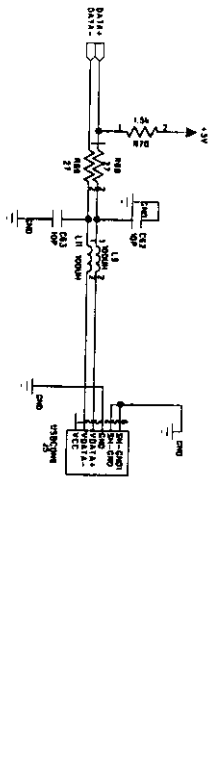
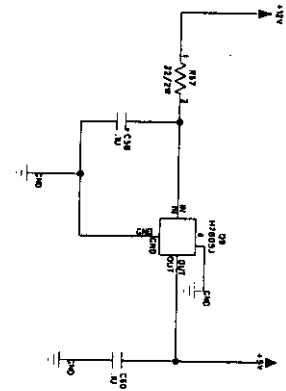
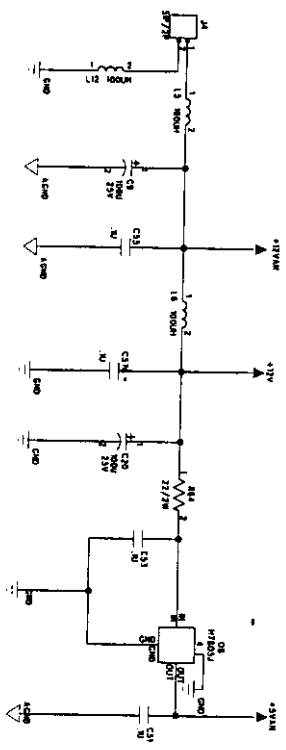
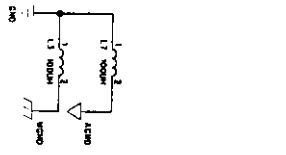

COMPANY : MUSTEK SYSTEMS INC

TITLE : CGU12

SIZE : C DATE : 1/15/98 REV : X1

ENGINEER : Kevin SHEET : 2 OF 2

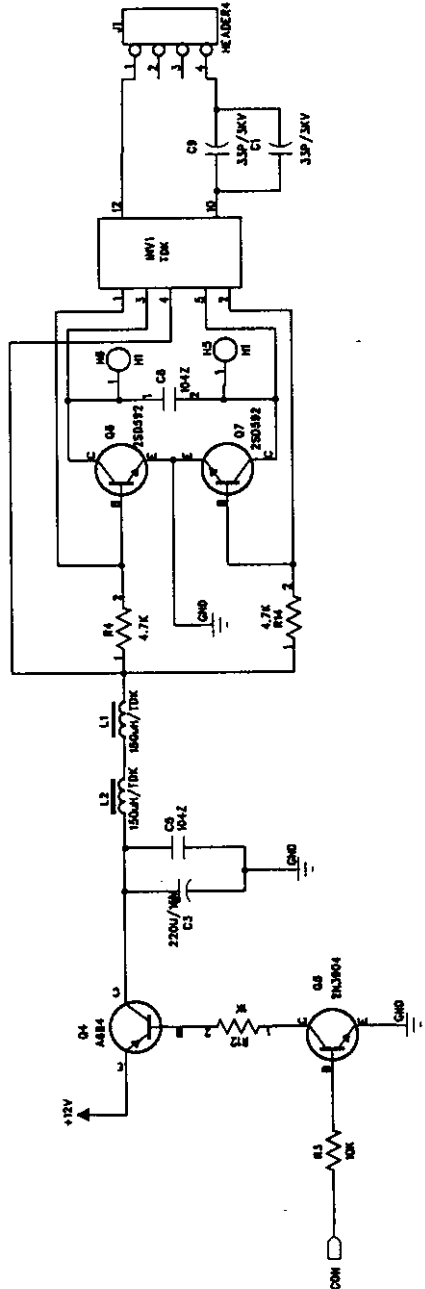

COMPANY: MUSTEK CO.		
TITLE: A45600 CCD BOARD & INVERTER CIRCUIT		
SIZE: A4	DATE: 1998/07/01	REV: X1
ENGINEER: ROGER	SHEET:	3 OF 3