

EMC TEST REPORT*for***WACOM Co., Ltd.**

2-510-1 Toyonodai, Otone-machi, Kitasaitama-gun, Saitama 349-1148, Japan

Equipment Under Test: Digitizer
Model Name: PTZ-631W
Category: FCC Part 15 Sub.part B Class B Digital Device
FCC Part 15 Sub.part C
FCC ID: HV4PTZ
Tokin Report No.: T6M058111
Date of Issue: September 9, 2005

Approved by



Mickey Fukuda
Manager, Tsukuba Testing Lab.
Tokin EMC Engineering Co., Ltd.

-- ATTENTION --

The test results in this report relate only to the following EUTs, and this report shall not be reproduced except in full, without the written approval of the laboratory. This test report must not be used by the client to claim product endorsement by NVLAP or any agency of the U.S. Government.

NVLAP[®]

NVLAP Lab. Code: 200221-0

Contents

	<i>Page</i>
1 DESCRIPTION OF DEVICE	3 ~ 4
2 TEST FACILITY	5
3 SUMMARY OF RESULTS	
3.1 Electromagnetic Emission	5
3.2 Modification to The EUT.....	5
4 TESTED SYSTEM DETAILS	
4.1 Peripherals and Others	6
4.2 Type of Used Cables	6
Figure 4-1 System Configuration Diagram	7
5 TECHNICAL COUNTERMEASURE	7
6 TEST RESULTS	
6.1 RFI Voltage Measurement	
6.1.1 Measurement Instrumentation Used	8
6.1.2 Measurement Procedure.....	8
6.1.3 Deviation from the specification	8
6.1.4 Measurement Uncertainty	8
6.1.5 Test Data	9 ~ 11
6.2 RFI Field Strength Measurement	
6.2.1 Measurement Instrumentation Used	12
6.2.2 Measurement Procedure.....	13
6.2.3 Deviation from the specification	13
6.2.4 Measurement Uncertainty	13
6.2.5 Test Data	14 ~ 17
6.3 Minimum Margin	18
6.4 Sample Calculation	18
7 MEASUREMENT PHOTOS	
Photo 7.1 Setup with the Maximized RFI Voltage Emission Level.....	19
Photo 7.2 Setup with the Maximized RFI Field Strength Emission Level	20

1 DESCRIPTION OF DEVICE

- A) Kind of Equipment : Digitizer
 B) FCC ID : HV4PTZ
 C) Model Name : PTZ-631W

* The differences between last time and this time are as follows.

	Last time			This time
Test Report No.	T6E0461113			T6M058111
Model Name	PTZ-430	PTZ-630	PTZ-930	PTZ-631W
Size (mm)	238.5*217*13	345*261.5*13	439.5*340*14	471.6*262.0*14
Active area (mm)	127.0*101.6	203.2*152.4	304.8*228.6	271.0*158.8
Weight (g)	600	1000	1800	1400
Number of Touch Pad	1	2	2	2

The Touch Pads of these 4 models are using the same parts completely and the number to be using by the model is different.

- D) Serial No. : None
 E) Type of Sample Tested : Pre-production
 F) Dimension: Width 471.6 mm × Depth 262.0 mm × Height 14.0 mm
 G) High Frequency Used : 667kHz (Communication between a device and a tablet)
 12MHz (CPU clock)
 16MHz (Gatearray clock)
 8MHz (Touch Pad)
 H) Rating Power Supply : DC5V, 300mA
 I) Tested Power Supply : DC5V (EUT)
 1phase AC120V, 60Hz (PC)
 J) Date of Manufacture : July 2005
 K) Manufacturer : WACOM Co., Ltd.
 2-510-1 Toyonodai, Otone-machi, Kitasaitama-gun,
 Saitama 349-1148, Japan

Report processed by

Tested by



Hiroko Nakamura
09/Sep./2005



Jiro Murata, Engineer

L) Options :

Using Devices: ZP-130 (Ink Pen)
ZP-300E (Classic Pen)
ZP-400E (Airbrush)
ZP-501E (Grip Pen)
ZP-600 (Maker Pen)
ZC-100 (2D Mouse)

- Digitizer has an USB I/F cable and is connected by PC and USB.
- As a device which can be used on digitizer, there are Grip-pen, Ink pen, Classic pen, Airbrush, Maker pen and 2D mouse.
- The device of these cannot be simultaneously used on two or more and the same digitizer.

M) Description of Operating :

Device detection state

Test system (EUT + option):

1. PTZ-631W + ZP-130
2. PTZ-631W + ZP-300E
3. PTZ-631W + ZP-400E
4. PTZ-631W + ZP-501E
5. PTZ-631W + ZP-600
6. PTZ-631W + ZC-100

** It was tested each test system (EUT + option) separately, and the results of worst case were obtained. The test systems of worst results that issued data on this test report are as follows.*

RFI Voltage Measurement: PTZ-631W + ZP-501E

RFI Field Strength Measurement: PTZ-631W + ZP-600

N) Date of Sample Received :

August 8, 2005

O) Tested Engineer :

Jiro Murata

Report processed by



Hiroko Nakamura
09/Sep./2005

Tested by



Jiro Murata, Engineer

2 TEST FACILITY

The open field test site and conducted measurement facility are used for these testing, where are located following address. This site's FCC Test firm registration number: 91021. This laboratory is accredited by NVLAP for NVLAP Lab. Code: 200221-0.

Tokin EMC Engineering Co., Ltd.

Tsukuba Testing Laboratory, Open Field Test Site No.6 and Shielded Room No.2

Address ; 28-1, Kitahara, Hanashimashinden, Tsukuba-city, Ibaraki 305-0875, Japan

3 SUMMARY OF RESULTS

3.1 Electromagnetic Emission

RFI Voltage Measurement **PASS**

RFI Field Strength Measurement **PASS**

Although the measured emissions indicate that the EUT complies with the required limits, some measurements are close to these limits. When the uncertainty of measurement is considered, there is some possibility that the EUT may not be compliant.

Test results are traceable to JQA and NML/CSIRO.

3.2 Modifications to The EUT

This EUT was taken countermeasures.

Report processed by



Hiroko Nakamura
09/Sep./2005

Tested by



Jiro Murata, Engineer

4 TESTED SYSTEM DETAILS

4.1 Peripherals and Others :

Description	Model Name	Serial No.	Manufacturer	FCC ID
PC	Presario SR1000	CNN5250F4B	COMPAQ	DoC
Monitor	570STFT	CN15H1ER81369 0A	SAMSUNG	DoC
AC Adapter for Monitor	PSCV360104A	C010801969	SAMSUNG	---
Modem	1414	970024524	ACEEX	IFAXDM1414
AC Adapter for Modem	SCP41-91000A	---	ACEEX	---
Printer	EPSON STYLUS C60	DR3K019970	EPSON	DoC
Keyboard	SK-8100	---	DELL	DoC
Mouse	IntelliMouse 1.3A	---	DELL	DoC

4.2 Type of Used Cables :

Description	Length	Type of shield	Model name	Manufacturer
PC AC Cable	1.8m	Non-shielded	---	---
Monitor AC Cable	2.0m	Non-shielded	---	---
Modem DC Cable	1.8m	Non-shielded	---	---
Printer AC Cable	1.8m	Non-shielded	---	---
Monitor I/F Cable (PC ~ Monitor)	1.8m	Shielded	---	---
Serial Cable (PC ~ Modem)	1.8m	Shielded	---	---
Parallel Cable (PC ~ Printer)	1.8m	Shielded	---	---
Keyboard Cable (PC ~ Keyboard)	1.8m	Non-shielded	---	---
Mouse Cable (PC ~ Mouse)	1.8m	Non-shielded	---	---
USB Cable (EUT ~ PC)	2.5m	Shielded	---	TOP CHARGER ENTERPRISE CO., LTD.

Report processed by



Hiroko Nakamura
09/Sep./2005

Tested by



Jiro Murata, Engineer

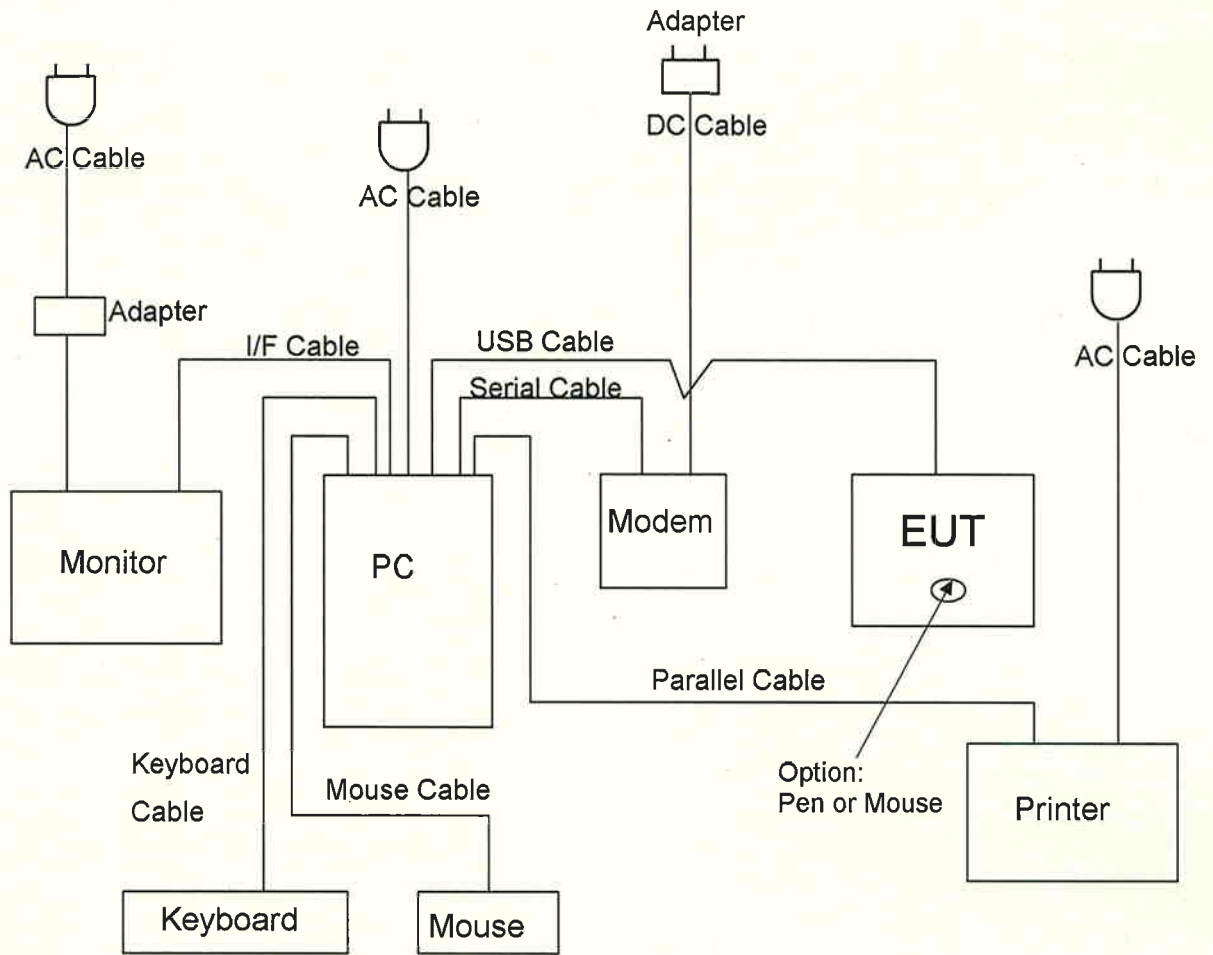

Figure 4-1 System Configuration Diagram

5 TECHNICAL COUNTERMEASURE

5-1 Inserted a ferrite core (Model: F6RH6.4×10×3.2, Manufacturer: Ferrico Electronics (Pan Yu) Co., Ltd.) for I/F cable (USB).

Report processed by

Hiroko Nakamura
Hiroko Nakamura
09/Sep./2005

Tested by

Jiro Murata
Jiro Murata, Engineer

6 TEST RESULTS**6.1 RFI Voltage Measurement****6.1.1 Measurement Instrumentation Used***(model/serial no./manufacturer/Tokin control no./last calibration/next calibration)*

Field strength meter (FCKL1528/1528124/Schwarzbeck/RE039/01 Jul.'05/Jun.'06)

L.I.S.N. (KNW-407/8-515-20/Kyoritsu/LI010/29 Oct.'04/Oct.'05)

2nd L.I.S.N. (PN-T22/9406/Tokin/LI046/29 Oct.'04/Oct.'05)

Spectrum analyzer (E4401B/MY41440237/Agilent technologies/SP051/30 Jun.'05/Jun.'06)

Coaxial cable (RG-55U/---/---/DK194/27 May'05/May'06)

Software (Software Data Calculation Software TEPTO 2.00/---/AES/---/---/---)

Shielded room (Tsukuba No.2-S/---/Tokin/SA017/---/---)

The measurement instrumentation used, are calibrated according to Quality Manual.

6.1.2 Measurement Procedure

The power line conducted interference measurements were performed according to ANSI C63.4-2001 in a shielded enclosure No.2 with peripherals placed on a table, 0.8m high over a metal floor. It was located distance 0.4m away from the shielded enclosure wall. There are no deviations from the standard. The standard limit was adopted CISPR Pub.22:1997 Class B.

The EUT was plugged into the LISN and the frequency range of interest scanned.

Reported are maximized emission levels.

These tests were performed at 9kHz of 6dB bandwidth.

Test results had obtained from following equation.

$$\text{Result (dB}\mu\text{V)} = \text{Level (dB}\mu\text{V)} + \text{Total Factor (dB)}$$

<Decision to Pass or Fail>

To judge pass or fail of the test result, it was added "uncertainty" to the obtained data and then subtracted it from the limit value. If all the values are +(plus), it will be passed, and if there is -(minus), it will be failed.

6.1.3 Deviation from the specification: None

6.1.4 Measurement Uncertainty

Measurement uncertainty is $\pm 1.94\text{dB}(k=2)$ and it had estimated for decision to PASS or FAIL.

Report processed by

Tested by



Hiroko Nakamura
09/Sep./2005



Jiro Murata, Engineer

6.1.5 Test Data

Table 6.1-1a RFI Voltage Measurement Results (Q-Peak Measurement)

Model Name: PTZ-631W + ZP-501E
Operating mode: Device detection state
Test procedure: ANSI C63.4-2001
Test condition: Power input 1phase AC120V
 DC5V

Date of measurement: August 9, 2005
Temperature: 26 degree C
Humidity: 52 %

	Frequency (MHz)	Level (dBμV)	Total Factor(dB)	Result (dBμV)	Limit (dBμV)	Margin (dB)
N-E	0.246	31.0	0.0	31.0	61.9	30.9
	0.492	32.0	0.0	32.0	56.1	24.1
	1.290	32.5	0.1	32.6	56.0	23.4
	4.669	33.0	0.3	33.3	56.0	22.7
	10.000	37.5	0.4	37.9	60.0	22.1
	18.000	36.0	0.6	36.6	60.0	23.4

L1-E	0.246	26.0	0.0	26.0	61.9	35.9
	0.491	32.5	0.1	32.6	56.2	23.6
	2.272	32.0	0.3	32.3	56.0	23.7
	8.290	33.0	0.5	33.5	60.0	26.5
	10.000	36.5	0.6	37.1	60.0	22.9
	18.000	37.0	0.8	37.8	60.0	22.2

Report processed by

 Hiroko Nakamura
 09/Sep./2005

Tested by

 Jiro Murata, Engineer

Table 6.1-1b RFI Voltage Measurement Results (Average Measurement)

Model Name: PTZ-631W + ZP-501E

Operating mode: Device detection state

Date of measurement: August 9, 2005

Test procedure: ANSI C63.4-2001

Temperature: 26 degree C

Test condition: Power input 1phase AC120V
DC5V

Humidity: 52 %

	Frequency (MHz)	Level (dB μ V)	Total Factor(dB)	Result (dB μ V)	Limit (dB μ V)	Margin (dB)
N-E	0.246	30.5	0.0	30.5	51.9	21.4
	0.492	31.0	0.0	31.0	46.1	15.1
	1.290	32.0	0.1	32.1	46.0	13.9
	4.669	28.0	0.3	28.3	46.0	17.7
	10.000	32.0	0.4	32.4	50.0	17.6
	18.000	31.0	0.6	31.6	50.0	18.4
L1-E	0.246	25.0	0.0	25.0	51.9	26.9
	0.491	32.0	0.1	32.1	46.2	14.1
	2.272	28.0	0.3	28.3	46.0	17.7
	8.290	32.0	0.5	32.5	50.0	17.5
	10.000	31.0	0.6	31.6	50.0	18.4
	18.000	32.0	0.8	32.8	50.0	17.2

Report processed by



Hiroko Nakamura
09/Sep./2005

Tested by



Jiro Murata, Engineer

CISPR Pub.22: 1997 Class B Limit

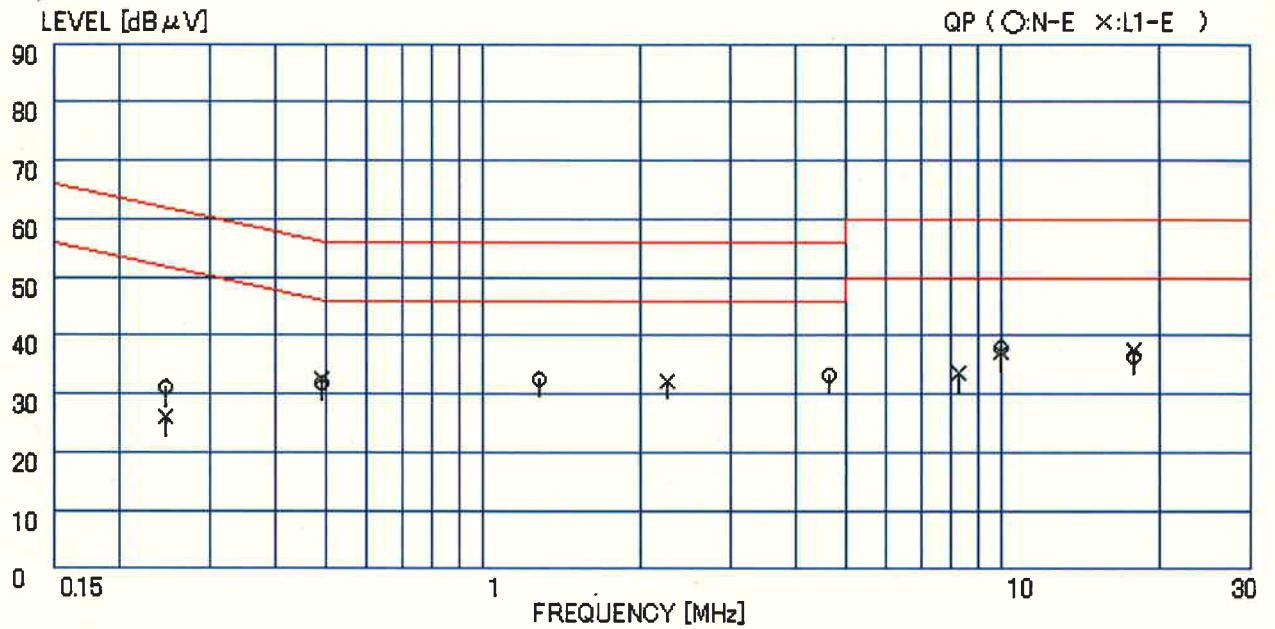

<Q-Peak Measurement>

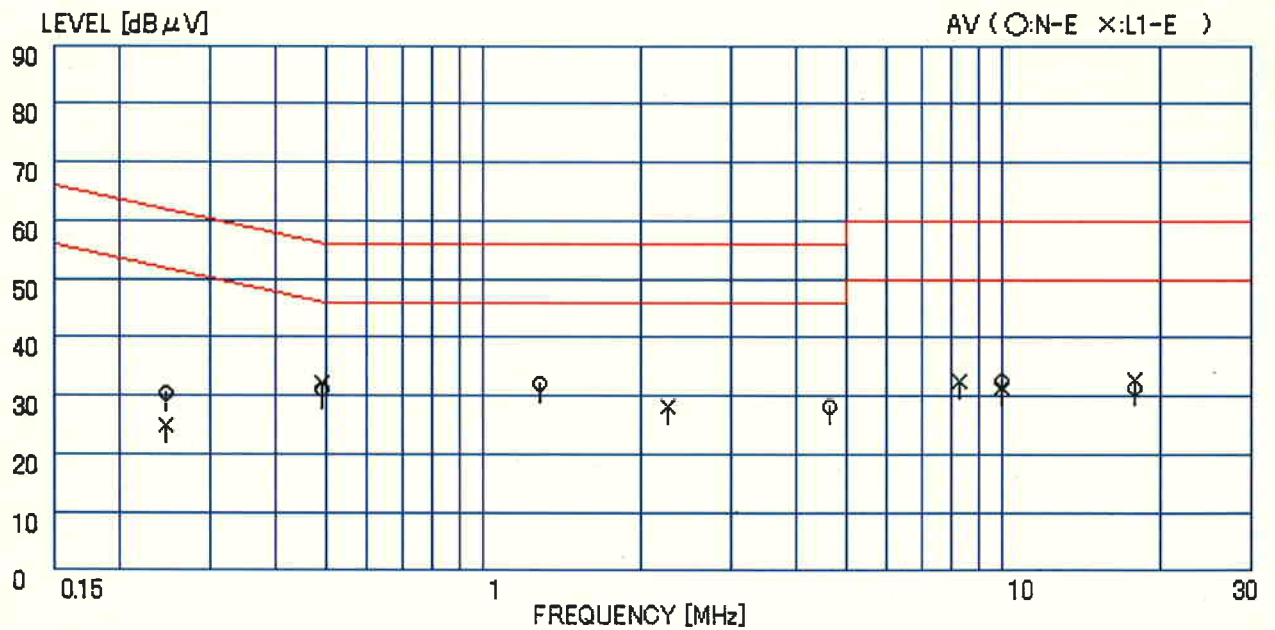

<Average Measurement>

Figure 6.1-1 RFI Voltage Measurement Results

Report processed by

Hiroko Nakamura
09/Sep./2005

Tested by

Jiro Murata, Engineer

6.2 RFI Field Strength Measurement

6.2.1 Measurement Instrumentation Used

(model/serial no./manufacturer/Tokin control no./last calibration/next calibration)

< 0.009MHz to 30MHz >

Loop antenna(HFH2-Z2/FNR879650-22/Rohde&Schwarz/AN005/21 Jan.'05/Jan.'06)
Field strength meter(FCKL1528/1528124/Schwarzbeck/RE039/01 Jul.'05/Jun.'06)
L.I.S.N.(KNW-407/8-515-20/Kyoritsu/LI010/29 Oct.'04/Oct.'05)
Spectrum analyzer(E4401B/MY41440237/Agilent technologies/SP051/30 Jun.'05/Jun.'06)
Coaxial cable(RG-55U/---/---/DK194/27 May'05/May'06)
Software.....(Software Data Calculation Software TEPTO 1.06/---/AES/---/---/---)
Open Field Test Site.....(Tsukuba No.6/---/Tokin/SA006/31 Jan.'05/Jan.'06)

<30MHz to 1000MHz>

Field strength meter.....(FCVU1534/131/Schwarzbeck/RE046/23 May'05/May'06)
Biconical antenna(BBA9106/2099/Schwarzbeck/TB024/10 Sep.'04/Sep.'05)
Logperiodic antenna.....(UHALP9108-A/0115/Schwarzbeck/TL021/10 Sep.'04/Sep.'05)
Pre-amplifier.....(8447D/2727A05431/Hewlett Packard/AM006/01 Feb.'05/Jan.'06)
Spectrum analyzer(R3261A/81720103/Advantest/SP006/03 Jun.'05/Jun.'06)
Coaxial switch unit.....(MP59B/6100226498/Anritsu/ME267/01 Feb.'05/Jan.'06)
Attenuator.....(8493B/3308A21823/Hewlett Packard/ME273/09 Nov.'04/Nov.'05)
Site establishment cable...(---/---/Tokin/DKT07/01 Feb.'05/Jan.'06)
Software(Software Data Calculation Software TEPTO 2.00/---/AES/---/---/---)
Open Field Test Site.....(Tsukuba No.6/---/Tokin/SA006/31 Jan.'05/Jan.'06)

The measurement instrumentation used, are calibrated according to Quality Manual.

Report processed by

Hiroko Nakamura
09/Sep./2005

Tested by

Jiro Murata, Engineer

6.2.2 Measurement Procedure

Final test was performed according to ANSI C63.4-2001 at the open field test site No.6. There were no deviations from the standard.

The EUT was placed on a 0.8m high table along with the peripherals. The turntable was separated from the antenna distance 3meters. Cables were placed in a position to produce maximum emissions as determined by experimentation, and operation mode was selected for maximum.

The frequencies and amplitudes of maximum emission were measured at varying azimuths, antenna heights and antenna polarities. Reported are maximized emission levels.

These tests were performed at 120kHz of 6dB bandwidth.

Test results were obtained from following equation.

$$\text{Result (dB}\mu\text{V/m)} = \text{Level (dB}\mu\text{V)} + \text{Ant. Factor (dB/m)} + \text{Cable Loss (dB)} - \text{Amp. Gain (dB)}$$

<Decision to Pass or Fail>

To judge pass or fail of the test result, it was added "Uncertainty" to the obtained data and then subtracted it from the limit value. If all the values are +(plus), it will be passed and if there is -(minus), it will be failed.

6.2.3 Deviation from the specification: None

6.2.4 Measurement Uncertainty

Measurement uncertainty of 0.009MHz to 30MHz is $\pm 1.94\text{dB}(k=2)$, 30MHz to 300MHz is $\pm 3.64\text{dB}(k=2)$, 300MHz to 1000MHz is $\pm 3.60\text{dB}(k=2)$ and it had estimated for decision to PASS or FAIL.

Report processed by



Hiroko Nakamura
09/Sep./2005

Tested by



Jiro Murata, Engineer

6.2.5 Test Data

Table 6.2-1 RFI Field Strength Measurement Results (Q-Peak Measurement)
<0.009MHz to 30MHz>

Model Name: PTZ-631W + ZP-600
 Operating mode: Device detection state
 Test procedure: ANSI C63.4-2001
 Test condition: Power input 1phase AC120V
 DC5V
 Test distance: 3 meters*

Date of measurement: August 8, 2005
 Temperature: 27 degree C
 Humidity: 64 %

Frequency (MHz)	Level		Cable Loss (dB)	Amp. Gain (dB)	Ant. Factor (dB/m)	Result		30 Meter Limit (μV/m)	Margin	
	Ver. (dBμV)	Hor.				Ver. (dBμV/m)	Hor.		Ver. (dB)	Hor.
0.67	24.0		0.3	0.0	19.2	43.5	31.1	31.1	-12.3 *	
2.00	-1.0		0.4	0.0	19.1	18.5	18.5	29.5	11.0	

Limit

Frequency (MHz)	dBμV/m	μV/m	Distance(m)
0.009 ~ 0.490	48.5 ~ 13.8	2400/F(kHz)	300
0.490 ~ 1.705	33.8 ~ 23.0	24000/F(kHz)	30
1.705 ~ 30	29.5	30	30

* The test result obtained at 3meters from the EUT is complied with the limit of 300meters and 30meters from FCC requirement.
 Therefore, the EUT had complied with FCC Part 15 Sub.part C requirement.

Report processed by

 Hiroko Nakamura
 09/Sep./2005

Tested by

 Jiro Murata, Engineer

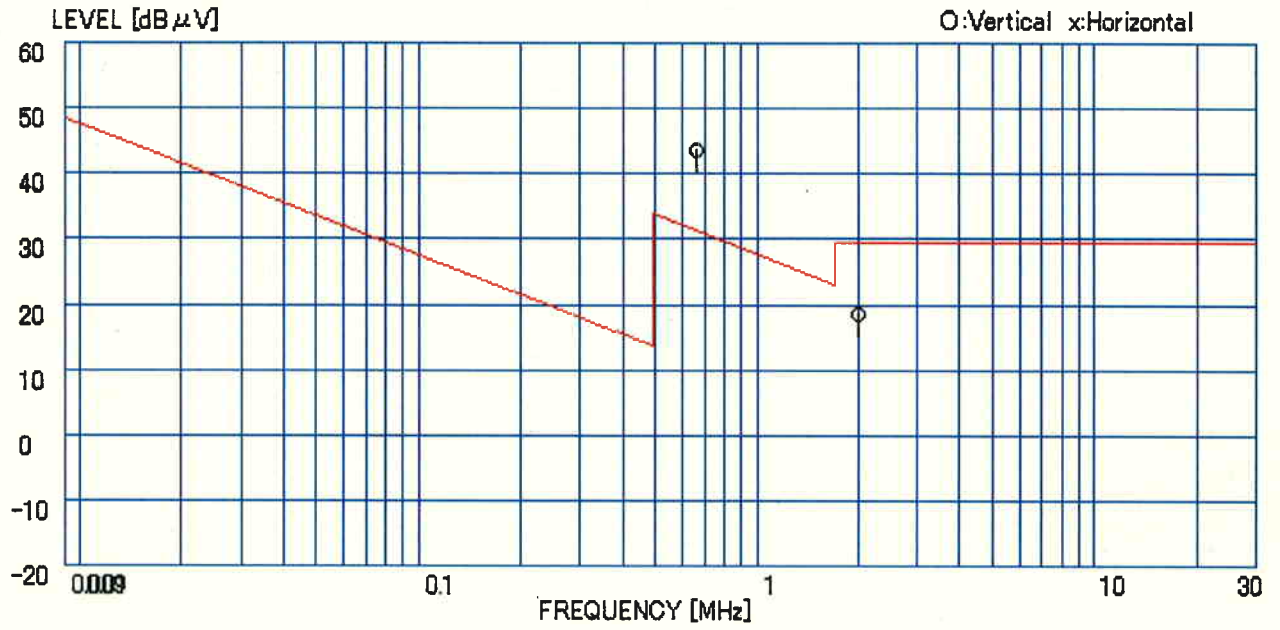

Figure 6.2-1 RFI Field Strength Measurement Results

Report processed by

Hiroko Nakamura
09/Sep./2005

Tested by

Jiro Murata, Engineer

Table 6.2-2 RFI Field Strength Measurement Results (Q-Peak Measurement)
<30MHz to 1000MHz>

Model Name: PTZ-631W + ZP-600
 Operating mode: Device detection state
 Test procedure: ANSI C63.4-2001
 Test condition: Power input 1phase AC120V
 DC5V

Date of measurement: August 8, 2005
 Temperature: 27 degree C
 Humidity: 64 %

Frequency (MHz)	Level		Cable Loss (dB)	Amp. Gain (dB)	Ant. Factor (dB/m)	Result		Result Ver. (μ V/m)	Result Hor. (μ V/m)	3 Meter Limit (μ V/m)	Margin	
	Ver. (dB μ V)	Hor.				Ver.	Hor.				Ver.	Hor.
36.00	39.0	33.0	1.3	-27.1	16.1	29.3	23.3	29.17	14.62	100	10.7	16.7
48.00	41.0	32.5	1.6	-27.0	10.7	26.3	17.8	20.65	7.76	100	13.7	22.2
60.00	48.5	41.0	1.8	-27.0	7.4	30.7	23.2	34.28	14.45	100	9.4	16.9
96.00	43.5		2.4	-27.0	9.9	28.7		27.23		150	14.8	
120.00	40.5	34.0	2.6	-26.8	13.1	29.4	22.9	29.51	13.96	150	14.1	20.6
240.00	38.0	32.0	3.8	-26.2	17.8	33.3	27.3	46.24	23.17	200	12.7	18.7
383.99	39.0	25.0	4.9	-27.2	18.4	35.1	21.1	56.89	11.35	200	10.9	24.9
432.07		33.0	5.3	-27.6	18.5		29.1		28.51	200		16.9
480.00	25.0		5.5	-28.0	17.9	20.4		10.47		200	25.6	
496.05		33.0	5.6	-28.0	18.3		28.9		27.86	200		17.1
576.07	31.0	28.0	6.2	-28.2	20.2	29.3	26.3	29.17	20.65	200	16.7	19.7
624.09		28.5	6.4	-28.2	19.3		26.0		19.95	200		20.0
705.05		25.0	6.9	-28.2	22.9		26.5		21.13	200		19.5
751.76	28.0		7.1	-28.0	21.2	28.3		26.00		200	17.7	

Class B limit

Radiated Emission – 3 meter distance

Frequency (MHz)	dB μ V/m	μ V/m
30 - 88	40.0	100
88 - 216	43.5	150
216 - 960	46.0	200
> 960	54.0	500

Report processed by

Tested by

 Hiroko Nakamura
 09/Sep./2005

 Jiro Murata, Engineer

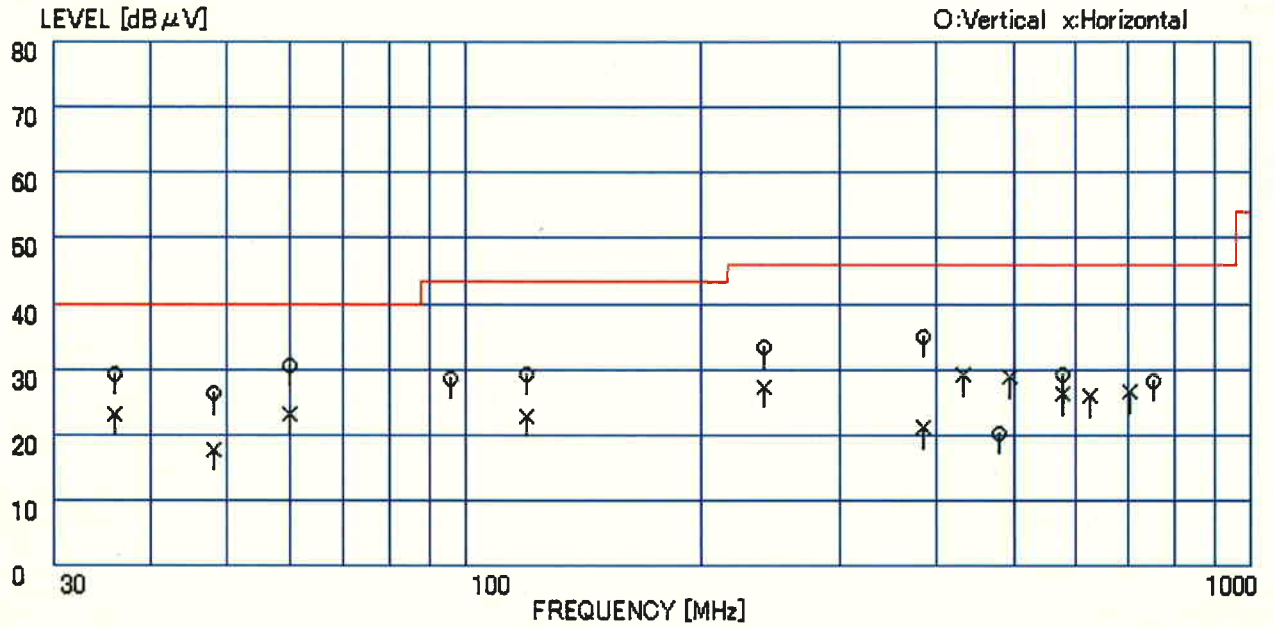

Figure 6.2-2 RFI Field Strength Measurement Results

Report processed by

Hiroko Nakamura

Hiroko Nakamura
09/Sep./2005

Tested by

J. Murata

Jiro Murata, Engineer

6.3 Minimum Margin

Table 6.3-1 Minimum Margin

<u>Conducted emission</u>			
Device detection	operation mode	1.29 MHz,	13.9 dB
<u>Radiated emission</u>			
Device detection	operation mode	60.0 MHz,	9.4 dB

6.4 Sample Calculation

Table 6.4-1 Sample Calculation

The maximum radiating emission can be obtained at the frequency of 60.0 MHz,
Vertical polarization on Device detection operation mode.

Each value at frequency is as follows;

- R : Field strength meter reading = 48.5 (dBμV)
- A : Antenna factor = 9.4 (dB/m)
- C : Cable loss = 1.8 (dB)
- G : Amplifier gain = 29.0 (dB)

Then radiated emission E(dBμV/m) is ;

$$E = R + A + C - G$$

Therefore, the maximum radiated emission is ;

$$30.7 \text{ (dB}\mu\text{V/m)}$$

Report processed by



Hiroko Nakamura
09/Sep./2005

Tested by



Jiro Murata, Engineer

7 MEASUREMENT PHOTOS

Photo 7.1 Setup with the Maximized RFI Voltage Emission Level

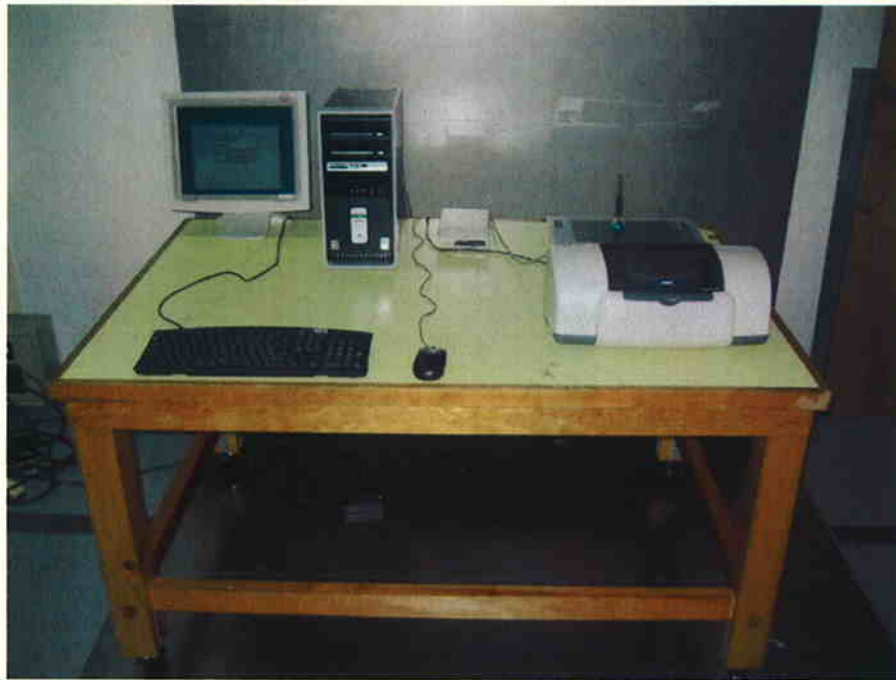

Photo 7.2 Setup with the Maximized RFI Field Strength Emission Level

