



Cintiq[™] 18SX

INTERACTIVE PEN DISPLAY

INTERACTIVE PEN DISPLAY

**INSTALLATION GUIDE
AND USER'S MANUAL**

Introduction and Overview

The Wacom® Cintiq™ 18SX Interactive Pen Display combines an LCD display with a Wacom tablet. This gives you a direct point-and-draw-on-screen interface that can be used with a Personal Computer (PC), Macintosh® computer, or SGI™ or Sun® workstation. Cintiq's basic components include a Wacom tablet internally mounted behind an 18.1" diagonal TFT color LCD display, and Wacom's Grip Pen.

Your Cintiq Interactive Pen Display offers a number of significant advantages over a standard display:

- Integrated input and display
- Pressure-sensitive drawing directly on the display screen
- Reduced power consumption and heat generation
- Requires less work space
- Flicker free and easier on the eyes.

Cintiq comes with a modular display stand, which allows you to easily rotate the Interactive Pen Display unit to any orientation, and to adjust the incline of the working surface to any angle between 13 and 70 degrees. You can also lock Cintiq in either a landscape or portrait orientation. If you prefer to use Cintiq on your lap, simply lift the display unit out of the stand. Please refer to *Working with Cintiq* on page 32 for more information.

The workspace, and how you interact with it, was an important consideration in the design and development of Cintiq. Regardless of how you prefer to work with the Interactive Pen Display, you will find that Cintiq is ideally suited to a variety of diverse professional fields and applications. Cintiq is especially useful in the fields of animation, graphics design, 3D modeling, and video and film post-production. Some additional areas of use include architectural design, AV presentations, industrial design, medical imaging, textile design, and any others where direct manipulation of the screen image is useful.

This manual describes how to install the Cintiq hardware and software. It also describes how to use Cintiq, the Grip Pen, and the modular display stand.

The Interactive Pen Display and the Cintiq stand are packed separately. Refer to *Unpacking Cintiq* on page 12 before removing Cintiq or the stand from the box. **Please follow all instructions carefully.**

Note that the computer treats the two parts of Cintiq (the LCD display and the Wacom tablet) as separate pieces of hardware. Therefore, the installation process is completed in two stages:

- First, you will install the LCD display portion of Cintiq.
- In the second stage you will install Cintiq's tablet functionality.

Both stages require hardware and software installations. **Please follow all instructions carefully.**

You can find information on using the Wacom Tablet Control Panel for customizing your tablet and pen settings in the online Help, located under the **Help** menu in the Wacom Tablet Control Panel. See *Learning More About Cintiq* on page 37.

The following are not included with this product:

- Information about your specific computer hardware
- Information about your operating system
- Information about application software.

Please refer also to your computer hardware, operating system, or software application manuals. To use the pressure-sensitivity of the Grip Pen with your favorite drawing application, refer to instructions in that application's manuals.

Precautions on Use and Handling

Be sure to follow all instructions, cautions, and warnings found within this manual. Failure to do so could void your warranty, in which case Wacom shall have no responsibility to repair or replace the product.

PHYSICAL LOCATION

- WARNING** ■ **Do not use the Cintiq Interactive Pen Display in a facility control system that requires extremely high reliability;** it may cause other electronic devices to malfunction, or other devices may cause the Interactive Pen Display to malfunction. Where use is prohibited, power off Cintiq to prevent the possibility of it causing other electronic devices to malfunction. Wacom does not accept any liability for direct or consequential damages. For details, please refer to your Warranty, located at the end of this manual.

ENVIRONMENT

■ Temperature and Humidity

- Operating temperature and humidity 5° to 35°C, 20 to 80% RH
- Storage temperature and humidity -10° to 60°C, 20 to 90% RH

- CAUTION** ■ **Do not use or store Cintiq where** temperature changes are severe or exceed specifications (e.g., outdoors or inside a vehicle). **Do not use or store Cintiq where** the Interactive Pen Display, the Grip Pen, and the Cintiq stand are exposed to direct sunlight or heat from an appliance, or are exposed to water or any other kind of liquid.

- CAUTION** ■ **Do not use Cintiq in a dusty environment;** this may damage the unit.

USAGE

- WARNING** ■ **Only use the power supply that came with Cintiq.** If a different type of power supply is used, Cintiq will not work properly or may be damaged. **Using a different type of power supply also has the potential to result in fire.** Use of a different power supply will void your warranty.

- CAUTION** ■ **Be sure to use a grounded power source when applying power to Cintiq.**











- CAUTION** ■ **Do not connect or disconnect the video or power cables while Cintiq or your computer are turned on;** this may damage the LCD display or computer video card. In this case, Wacom shall have no responsibility to repair or replace the product.

- CAUTION** ■ **This product is for use with a DVI or VGA video card;** using an inappropriate video card may damage Cintiq.

- CAUTION** ■ **Do not block the rear panel ventilation holes;** this may overheat and damage the unit.

- **When not using Cintiq for long periods of time, unplug the power supply cable from the AC outlet.**

HANDLING

- WARNING** ■ **High Voltage. Do not open or disassemble the Cintiq Interactive Pen Display.**  **There is a risk of electrical shock when the casing is open.** This will also void your warranty and Wacom shall have no responsibility to repair or replace the product.
- WARNING** ■ **Do not operate the display stand incline adjustment levers when Cintiq is not mounted on the stand, and do not lift the stand by the adjustment levers;** the stand is spring-loaded and may cause injury or damage if released without the weight of Cintiq on the stand. Improper operation may lead to physical injury or damage to the stand. 
- WARNING** ■ **When moving Cintiq to a different location, either remove the display unit from the stand and then move both items separately, use the lock brackets to fix Cintiq to the stand (see page 53 for details), or otherwise make sure that the stand does not separate from the display unit when moving them both together.**  If the display unit is in landscape orientation, use one hand to grasp the bottom of the display stand. With your other hand grasp the top of the display unit. Be sure you are holding onto both the stand and display unit with your bottom hand before moving Cintiq.
If Cintiq is in a portrait orientation or has been locked to the stand, the stand will not separate from the display unit and Cintiq can be safely lifted by grasping the display unit with both hands. Always follow the instructions on page 29 to remove the display unit from the stand.
- WARNING** ■ **If the LCD screen has been damaged, DO NOT touch any liquid that may be leaking from it;** this liquid is an irritant. In case of contact with skin, eyes, or mouth, rinse immediately with running water for at least 15 minutes or more. If contact is made with the eyes or mouth, also consult a physician. 
- WARNING** ■ **Do not disassemble the Cintiq stand.** Improper disassembly could result in physical injury or damage to the stand. In this case, Wacom shall have no responsibility to repair or replace the product. 
- WARNING** ■ **Prevent children from swallowing the pen tip or side switch.** The pen tip or side switch may accidentally be pulled out if children are biting on them. 
- CAUTION** ■ **Do not disassemble the Grip Pen.** This may cause the device to malfunction. In this case, Wacom shall have no responsibility to repair or replace the product. 
- CAUTION** ■ **Do not scratch the display screen.** Avoid placing sharp objects on the display screen surface. 
- CAUTION** ■ **Avoid intensive shock or vibration to Cintiq, the Cintiq stand, or the Grip Pen.** Hitting or dropping Cintiq may damage the display screen or other components. 
- CAUTION** ■ **Do not put heavy articles on the Interactive Pen Display or push against it with a strong force;** this may damage the display screen or break the Cintiq stand locking mechanism. 

- CAUTION** ■ **Do not place heavy articles on the Cintiq cabling, repeatedly bend the cables sharply, or apply heavy stress to the cable connectors;** this may damage the unit or cabling.
- CAUTION** ■ **Do not store the Interactive Pen Display unit on a flat surface that would excessively bend or crimp the cable;** always store the Interactive Pen Display in the Cintiq stand when not in use.
- CAUTION** ■ **If the pen tip becomes sharp or angular, it may damage the coating on the display screen.** Please replace the pen tip if necessary.
- CAUTION** ■ **Do not use any organic solvent (e.g., alcohol) or even mild detergent to clean the display screen. Use of these cleaners can damage the coating on the screen. Please note that damage of this kind is not covered by the manufacturer's warranty.**
- To clean the display screen, use an anti-static cloth or a slightly damp cloth. When cleaning, apply only a light amount of pressure to the display screen and do not make the surface wet.
 - To clean the Cintiq casing, Cintiq stand, or Grip Pen, use a soft cloth with mild detergent (such as dish washing liquid) diluted with water.
- CAUTION** ■ **Do not expose Cintiq to high voltage electrostatic discharges or to a build-up of an electrostatic charge on the LCD screen.** This may result in a temporary discoloration and blotching of the LCD display. If discolorations occur, leave the Cintiq display on and the discolorations should disappear within a few hours.

Radio and Television Interference (U.S.A.)

The equipment described in this manual generates, uses, and can radiate radio-frequency energy. If it is not installed and used properly—that is, in strict accordance with Wacom instructions—it may cause interference with radio and television reception.

FEDERAL COMMUNICATIONS COMMISSION (FCC) NOTICE

This equipment has been tested and found to comply with the limits for Class B digital devices, pursuant to Part 15 of FCC Rules. These limits are designed to provide reasonable protection against harmful interference in a residential installation.

This equipment generates, uses and can radiate radio frequency energy and, if not installed and used in accordance with the instructions, may cause harmful interference to radio communications. However, there is no guarantee that interference will not occur in a particular installation.

You can determine whether the Interactive Pen Display is causing interference by powering it off. If the interference stops, it was probably caused by the Interactive Pen Display.

If your Interactive Pen Display does cause interference to radio or television reception, you may be able to correct the interference by using one or more of the following measures:

- Rotate the television or radio antenna until the interference stops.
- Move the Interactive Pen Display farther away from the television or radio.
- Plug the Interactive Pen Display and computer into an outlet that is on a different circuit from the television or radio.

If necessary, consult your Wacom dealer or an experienced radio/television technician for help.

Changes or modifications to this product not authorized by Wacom could void the FCC Certification and negate your authority to operate the product.

CE Declaration (Europe)

The equipment described in this manual generates, uses, and can radiate radio-frequency energy. If it is not installed and used properly—that is, in strict accordance with Wacom instructions—it may cause interference with radio and television reception.

RADIO AND TELEVISION INTERFERENCE

The Cintiq 18SX Interactive Pen Display has been tested and found to comply to the following harmonized European Norms:

- EN 55024 (electromagnetic immunity)
- EN 55022 Class B (electromagnetic emissions)
- EN 61000-3-2 (limits for harmonic current emissions)
- EN 61000-3-3 (limitation of voltage fluctuations and flicker)

The Wacom power adaptors have been tested by their manufacturers and found to comply to the following harmonized European Norms:

- EN 55022, EN 50082-1, EN 61000-3-2, or EN 61000-3-3 (electromagnetic emissions)
- EN 60950 (safety of low voltage devices)

Based on the results of these tests, Wacom declares that the above mentioned device conforms to the European Council Directives 89/336/EEC and 73/23/EEC, and their amendment Directive 93/68/EEC and indicates this conformity by the CE-sign on each device.

The device must be installed and operated always in strict accordance to the instructions given in this manual. Any changes or modifications to this product that were not specifically authorized by Wacom will invalidate this declaration.

WACOM Co., Ltd
2-510-1 Toyonodai,
Otone-machi,
Kitasaitama-gun
Saitama, 349-1148
Japan

Table of Contents

UNPACKING CINTIQ	12
■ Package Contents	
■ Unpacking the Cintiq Stand	
■ Unpacking and Mounting the Interactive Pen Display	
■ Interactive Pen Display Components	
INSTALLATION	18
■ System Requirements	
■ Step 1: LCD Display Installation	
■ Step 2: Tablet Installation	
USING CINTIQ	28
■ Adjusting the Cintiq Stand	
USING THE GRIP PEN	30
■ Working with the Grip Pen (UP-911E)	
■ Using a Pen	
WORKING WITH CINTIQ	32
■ Tablet Mode	
■ Display Mode	
■ Lap Mode	
CUSTOMIZING CINTIQ	35
■ Customizing the Grip Pen	
■ Adjusting the LCD Display	
CARING FOR CINTIQ	43
■ Cleaning	
■ Replacing the Pen Tip	
■ Maintaining the Cintiq Stand	
TROUBLESHOOTING	45
■ Testing Cintiq	
■ Testing the Tablet and Grip Pen	
■ Display Troubleshooting	
■ Obtaining Technical Support	

-
- DuoSwitch Removal and Installation
 - Optional Display Configurations
 - Specifications
 - License and Warranty

Unpacking Cintiq

PACKAGE CONTENTS

The Cintiq 18SX Interactive Pen Display and the Cintiq stand are each packed separately. You will find the other product components packed together in the accessories box. **To avoid damaging your product, please review the instructions on the following pages before unpacking Cintiq or the stand.** Your product came with the following items:

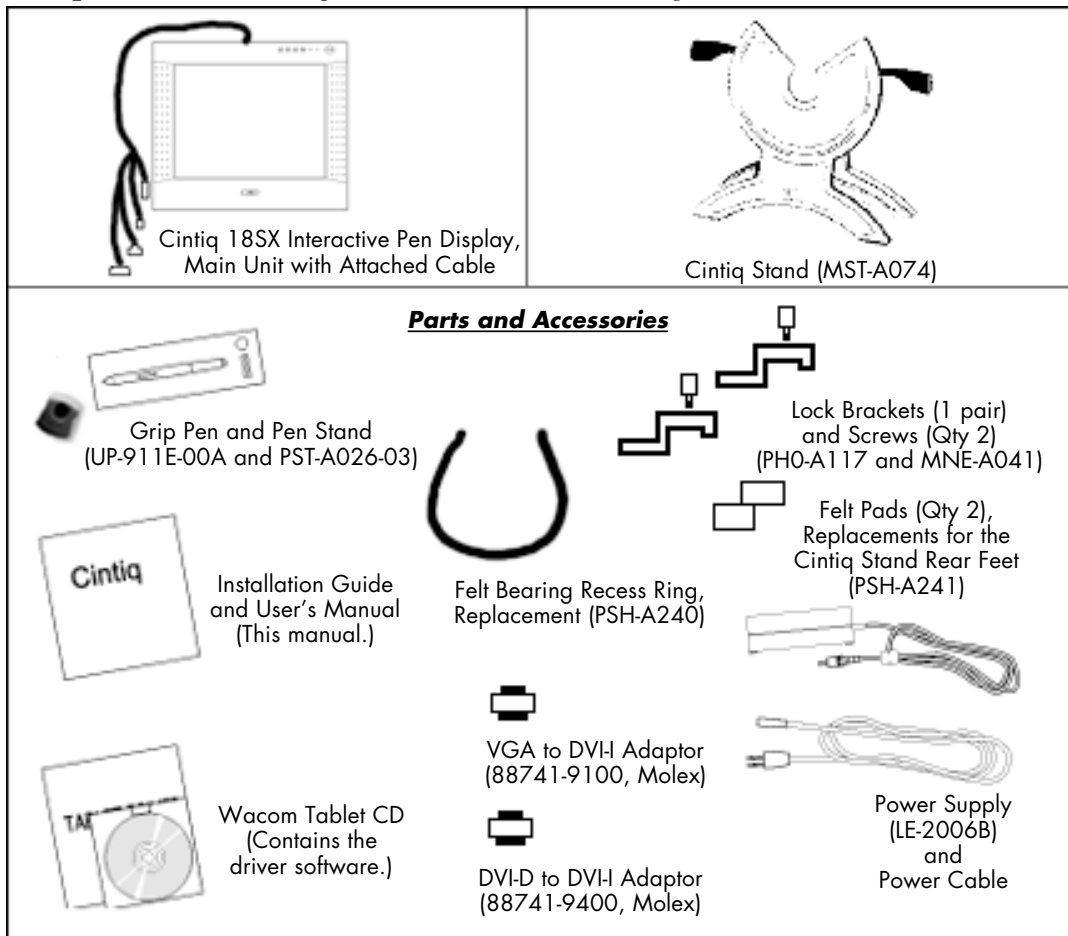

Notes:

Images are not shown to scale. Some package configurations include an additional CD containing bundled software applications. To install these applications, insert the CD into your computer's CD-ROM drive. If the software installation menu does not automatically display, double-click on the **Install** icon located on the CD and follow the prompts. Retain the package box for use when storing or shipping Cintiq.

UNPACKING THE CINTIQ STAND

When unpacking Cintiq, first unpack the modular display stand. Place the stand on your desktop or work surface, making sure the stand is stable and will not tip or fall when the Interactive Pen Display is mounted on it. Then familiarize yourself with the stand components.

CAUTION Do not operate the incline adjustment levers when Cintiq is not mounted on the stand, and do not lift the stand by the adjustment levers; the stand is spring-loaded and may cause injury or damage if released without the weight of Cintiq on the stand. Improper operation may lead to physical injury or damage to the stand. Be careful to avoid catching your finger in the gap of the movable portion of the stand.

Incline Adjustment Levers

When Cintiq is mounted on the stand, use these levers to adjust the display incline, as described in *Adjusting the Cintiq Stand* on page 28.

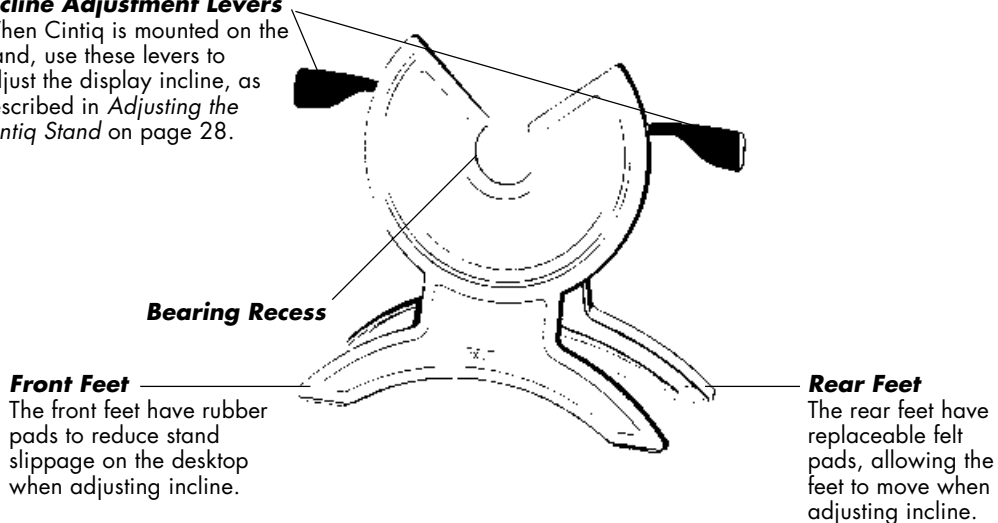

The Cintiq stand supports the Interactive Pen Display unit. The stand can be used to adjust the incline angle of the display unit from a low position (13 degrees from horizontal) to a high position (70 degrees from horizontal). And, you can rotate Cintiq from landscape to portrait orientation, or to any angle between +180 and -180 degrees. The stand also allows easy removal of Cintiq for use in a semi-supported lap position.

Note: Whenever you are not using Cintiq in your lap, Cintiq must be stored in the stand to avoid damage to the display screen or cabling.

Please refer to *Working with Cintiq* on page 32 for more information.

Next Step: *Unpack the Interactive Pen Display and mount it onto the Cintiq stand. See page 14*

UNPACKING AND MOUNTING THE INTERACTIVE PEN DISPLAY

When unpacking the Cintiq 18SX Interactive Pen Display, place the display unit face down on a flat, soft surface (such as on a cloth spread across a desktop) and remove any packing materials that may protect the display unit cabling.

To mount Cintiq on the stand:

- Make sure the stand is stable on your desktop or other work surface and will not tip or fall when Cintiq is mounted on it. Securely grasp Cintiq with both hands so that the display faces toward you, with the power switch and LEDs at the top right corner.

Align Cintiq parallel to the front of the stand so that the bearing hub is located between the V-shaped upper edges of the stand's bearing recess. See **(A)** (The V-shaped edges of the stand will serve as a guide for positioning the bearing hub.)

- With the back of Cintiq resting against the stand, lower Cintiq until the bearing hub rests securely in the bearing recess of the stand. See **(B)** The display unit will be held in place by gravity; there will be no audible 'snap' that indicates a mechanical lock.

Note: To lock Cintiq in a landscape or portrait orientation, or to learn about other mounting options, see *Optional Display Configurations*, on page 53.

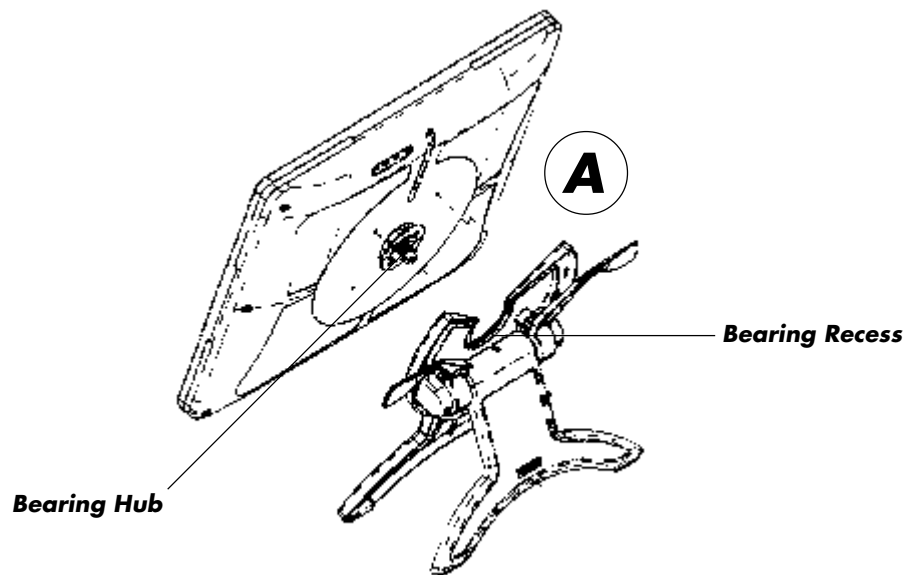



WARNING  When operating the incline adjustment levers, Cintiq must be mounted on the stand with the stand feet resting on a stable, flat surface. The stand is spring-loaded and can snap back quickly, causing injury or damage if not operated properly.

WARNING  When moving Cintiq to a different location, use the lock brackets to fix Cintiq to the stand (see page 53 for details), or otherwise make sure that the stand does not separate from the display unit. If the display unit is in landscape orientation, use one hand to grasp the bottom of the display and stand. With your other hand grasp the top of the display unit. Be sure you are holding onto both the stand and display unit with your bottom hand before moving Cintiq. If Cintiq is in portrait orientation or has been locked to the stand, the stand will not separate from the display unit and Cintiq can be safely lifted by grasping the display unit with both hands.

Next Step: Familiarize yourself with the Interactive Pen Display. See page 16

INTERACTIVE PEN DISPLAY COMPONENTS

Front View

Once the Cintiq Interactive Pen Display is safely mounted on the Cintiq stand, take some time to familiarize yourself with its features and components.

The LCD display and tablet sensor function as an integrated input and output device. The LCD display supports resolutions up to 1280 x 1024 pixels at 16,777,216 colors. The tablet sensor reports pen coordinates, pressure, switch, and eraser information.

Status LED

Lights green when the pen tip or a side switch is pressed, or when the eraser enters proximity of the LCD screen.

Power LED

Lights green when power has been supplied to both Cintiq and the computer and a video signal is present.

Glows orange when no video signal is received by Cintiq. (e.g., Your computer is turned off, starting up, or has entered a power management mode in which video signals are not sent.)

Power Switch

Turns power to the unit on or off.

LCD Display Screen

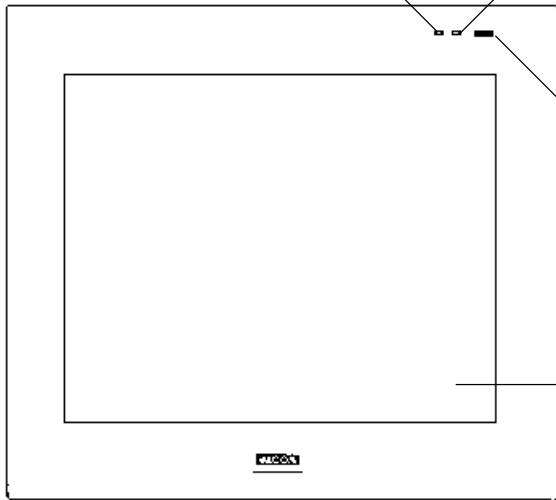

Rear View

Digital/Analog (DVI/VGA) Switch

Use this switch to correctly set Cintiq for the video connection you will be using.

On Screen Display (OSD) Controls

These controls enable you to adjust a variety of display settings. See *Adjusting the LCD Display* on page 38 for more information.

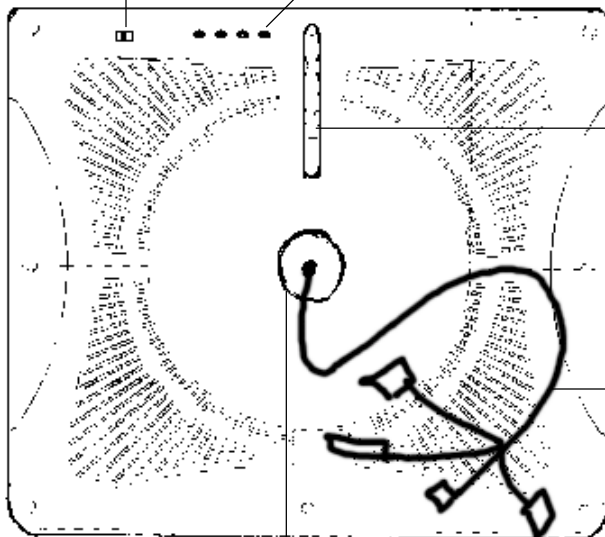

Cable Guide

Tuck the main cable into this guide when working with Cintiq in a semi-supported lap position. Remove the cable from the guide when mounting Cintiq on the display stand. See *Working with Cintiq* on page 32.

Cabling and Connectors

The connectors on the integral cable are for DVI-I video connection, USB or serial data, and power connection.

Bearing Hub

Fits into the bearing recess on the Cintiq stand. Allows rotation of Cintiq, and easy mounting and removal from the stand.

Important: Always store the Interactive Pen Display on the Cintiq display stand or in its original packing carton when not in use. Do not store the display unit on a flat surface that would excessively bend or crimp the cable.

Next Step: *Installation.* See page 18

Installation

SYSTEM REQUIREMENTS

Before installing Cintiq, make sure your computer meets the following system requirements:

- **Macintosh.** OS 9 or 10.1 and higher. DVI or VGA video connector, available USB port, and CD-ROM drive. ADC connectors require an ADC to DVI-D adaptor (not included).
- **PC.** Windows 98, Me, 2000, or XP. DVI or VGA video connector, available USB or serial port, and CD-ROM drive.
- **SGI and Sun workstations.** Additional purchase of Wacom UNIX kit. IRIX 6.5 or later for SGI. Solaris 2.6 or later for Sun. DVI or VGA video connector, available serial port, and CD-ROM drive.

Cintiq supports both digital (DVI) and analog (VGA) video signals. By using the VGA to DVI-I adaptor, you can connect Cintiq to a VGA video card. However, connecting Cintiq to a DVI video card generally results in optimum performance because a digital video signal will display a better image and exhibit less cursor lag on the screen.

If you plan to install a video card with digital output, complete the video card hardware and software installation before connecting Cintiq. If you have another display that is compatible with your video card, you can connect that display to the card in order to verify that the video card is operating correctly. For information on digital video cards that have been tested with Cintiq, refer to Wacom's Web site at <http://www.wacom.com/cintiq>

There are two primary steps to the installation process:

- **Step 1: LCD Display Installation**
- **Step 2: Tablet Installation**

Be sure to follow ALL installation instructions carefully. Failure to do so may cause damage to Cintiq or to the video card in your computer.

STEP 1: LCD DISPLAY INSTALLATION

Cintiq can be used alone or with another display, such as a CRT monitor or LCD projector. To use Cintiq with another display, you will need two video cards or a video card with dual output. Depending on the capabilities of your video card and operating system, you may be able to set up Cintiq as a mirrored, extended, or independent display. Refer to your video card documentation for more information on its capabilities.

In the first stage of the installation process you will install Cintiq as a display on your system. As you work through this stage, please refer to the *LCD Display Cabling Diagram* on the following page when making cable connections.

Important: Do not connect the USB or serial data cable until instructed to do so.

■ Turn off your computer.

Caution: Never connect or disconnect the video or power cables while your computer or Cintiq are powered on—this can damage the LCD display or video card.

- If your computer has only one video connector, you will need to unplug your previous display. Determine if your computer has a digital (DVI-I, DVI-D, or ADC) or analog (VGA) connector, and set the **Digital/Analog** (DVI/VGA) switch located on the back of Cintiq for the video connection you are using. Move the switch to the right toward the OSD buttons for **Digital** (DVI-I, DVI-D, or ADC), and move it to the left toward the tablet edge for **Analog** (VGA). See (A)

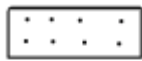

DVI-I Connector

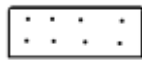

DVI-D Connector

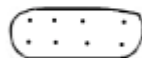

Apple ADC Connector

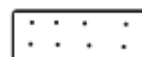

VGA Connector

- **If you are connecting to a DVI-I connector**, plug the DVI-I video cable into the DVI-I connector of your video card.

If you are connecting to a DVI-D connector, plug the DVI-I video cable into the DVI-I to DVI-D adaptor supplied with Cintiq. Then plug the adaptor into the DVI-D connector on your video card.

If you are connecting to an ADC connector, you will need to obtain an ADC to DVI-D adaptor. Plug the video cable into the DVI-D to DVI-I adaptor supplied with Cintiq. Next, plug this adaptor into the ADC to DVI-D adaptor. Then plug the ADC adaptor end into the ADC connector on your video card.

If you are connecting to a VGA connector, plug the DVI-I video cable into the VGA to DVI-I adaptor (supplied with Cintiq) and then into the VGA connector on your video card.

Be sure to tighten the thumbscrews on the connectors. See (B)

- Connect the power supply to Cintiq. See (C) Then connect the supply's power cable and plug the supply into an AC outlet. See (D)

LCD Display Cabling Diagram

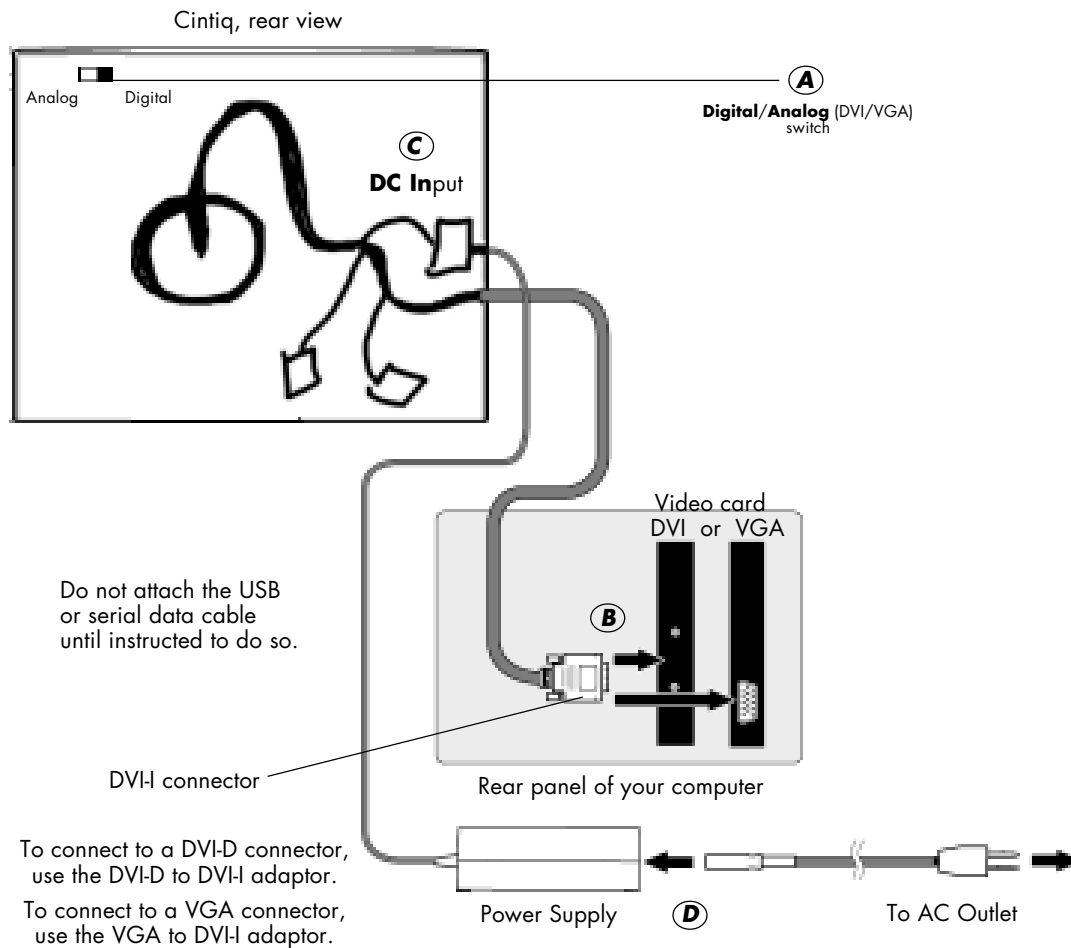

CAUTION  **Make sure that you correctly set the Cintiq Digital/Analog (DVI/VGA) switch for the video card you are using.**

Do not connect or disconnect the video or power cables while Cintiq or your computer are turned on – this can damage the LCD display or computer video card.

Do not exceed a display refresh rate of 75 Hz—this can overheat the LCD display and cause permanent damage.

- Turn on Cintiq. The power LED will light.
- Next, turn on your computer. (For Windows, if the **New Hardware Wizard** displays, follow the prompts while making sure to select the default options.)

Note: For Windows, a Cintiq color profile will be added to your computer's color management system during this installation. If you are prompted for the location of Cintiq monitor files, insert the Wacom Tablet CD into your computer's CD-ROM drive and follow the prompts to install any display software. To activate this color profile for use with Cintiq, you may need to select the CTQ18D65 profile in the system's Display Properties control panel. For more details, refer to the color management information in your operating system and application documentation.

- The maximum resolution of Cintiq is 1280 x 1024, True Color (24 bit). As necessary, configure the display control panel settings for the proper size and color resolution. The number of colors is constrained by the capabilities of your video card. Refer to the video card manufacturer's documentation for details.

If you are using analog (VGA) mode, you may want to fine-tune the display. Please refer to *Adjusting the LCD Display* on page 38 for more information.

For Windows, if you are using Cintiq as a secondary display, you may first need to enable Cintiq in your Display Properties control panel.

- After the display portion of Cintiq is working to your satisfaction, move on to the next section (*Step 2: Tablet Installation*) to install the Wacom tablet portion of Cintiq.

Note: For troubleshooting tips, please refer to page 45.

Each Cintiq 18SX LCD panel is produced under very stringent quality standards. Production techniques cannot guarantee an absolutely perfect TFT display, and some panels may exhibit a certain number of pixels that show an incorrect color. Refer to the specifications on pages 55 and 56 for more information.

If an image area has fine striping (such as screen stripes), it may flicker or display a moiré pattern.

Do not apply excessive pressure on the display surface; it may cause the appearance of a moiré or pooling pattern. If you notice this action, use less pressure on the display screen when working with the pen.

When a still image is displayed for a long period of time without refreshing the screen, an after-image may remain for a short period of time. To prevent this, Wacom recommends using a screen saver or other power management feature.

STEP 2: TABLET INSTALLATION

After you have completed the LCD display installation and configured the display settings, you will need to connect the Cintiq tablet cabling and install the Wacom tablet driver software. When installing the tablet portion of Cintiq, refer to the *Tablet Cabling Diagram* on the following page.

- First, shut down and power off your computer and Cintiq. If a USB port is available, Wacom recommends installing Cintiq as a USB device.

- **For USB installation:** Choose the Cintiq USB connector 

Plug the connector into an available USB port on your computer. See **(E)** in the connection diagram on page 23.

- **For Serial installation:** Choose the Cintiq serial connector 

Plug the connector into an available serial port on your computer. See **(F)** in the connection diagram on page 23. For UNIX workstations, you may need to use an appropriate adaptor from the Wacom UNIX kit to connect the serial cable.

Important: If the connection is difficult to make, do not force the plug into the connector. Instead, verify that there are no bent pins and that you have the correct cable and location. Do not plug in or unplug the serial connector when your computer is running—this may damage your serial card.

- Next, depending on your operating system and the tablet interface that you will be using (USB or serial), refer to the appropriate section for software installation instructions:

Tablet Software Install for Macintosh See page 24

Tablet Software Install for Windows with USB Connection See page 25

Tablet Software Install for Windows with Serial Connection See page 26

Tablet Software Install for SGI or Sun See page 27

Tablet Cabling Diagram

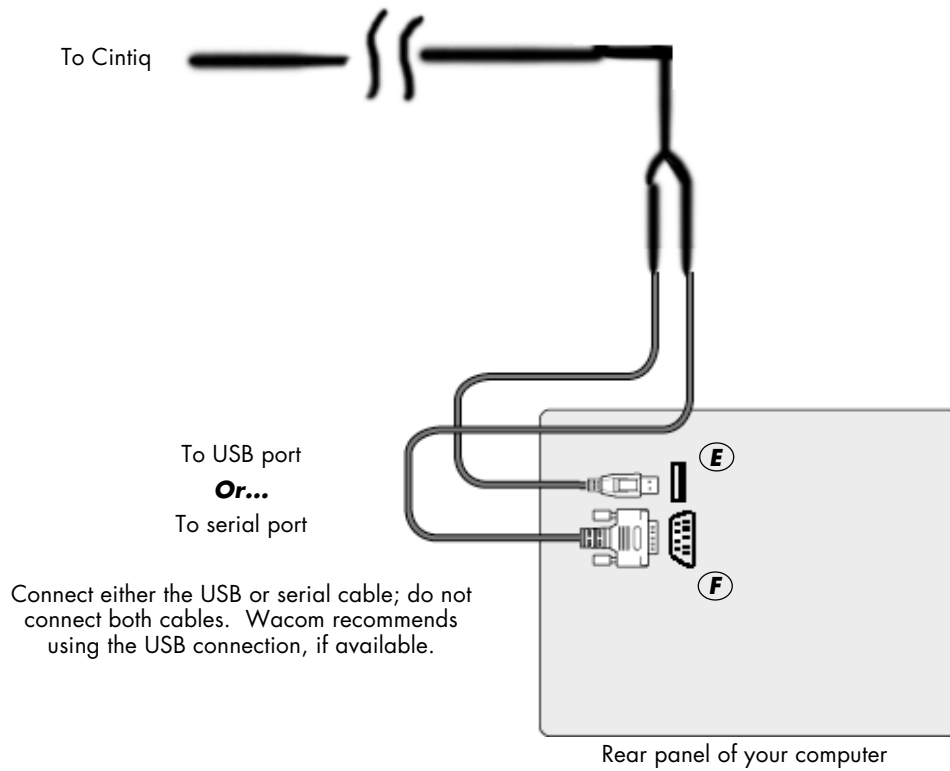

CAUTION  **Do not connect or disconnect the video or power cables while Cintiq or your computer are turned on**—this can damage the LCD display or computer video card.

Tablet Software Install for Macintosh

To install the tablet software:

- First turn on Cintiq, then turn on your computer and allow the operating system to fully load. Cintiq will automatically register as a USB device.
- Disable any virus protection programs and close all open applications before installing the software.
- Insert the Wacom Tablet CD into your computer's CD-ROM drive. The Cintiq menu should automatically display. If the menu does not display (or if you are running OS X), double-click on the **Install** icon located on the CD. Click on the **Install Cintiq** button and follow the prompts to install the driver software.
- Register your tablet when prompted.
- If you are running OS X, reboot your system for full tablet functionality.

Note: During installation, a Cintiq color profile will be added to your computer's color management system. To activate this color profile for use with Cintiq, you may need to select the Cintiq 18SX profile in the system's ColorSync control panel. For more details, refer to the color management information in your operating system and application documentation.

Be sure to check the Read Me file for late-breaking news. If you have trouble with the installation, refer to the troubleshooting section in this manual and in the online Help.

Next Steps:

To learn more about using Cintiq, proceed to Using Cintiq. See page 28

Be sure to adjust the tablet calibration to precisely align the screen cursor position with the location of the pen tip. Refer to Calibrating Cintiq. See page 36

Tablet Software Install for Windows with USB Connection

To install the tablet software:

- First turn on Cintiq, then turn on your computer and login, allowing the operating system to fully load. Cintiq will automatically register as a USB device.

Windows 98 users: The **Add New Hardware Wizard** will display. Follow the prompts, selecting the default options. If prompted to install drivers for the USB Human Interface Device, insert the Windows 98 CD, click **OK**, and enter the location of the Windows CAB files (e.g., **d:\win98**). Note that the files may be located on your hard disk in the **c:\windows\options\cabs** folder.

- Insert the Wacom Tablet CD into the CD-ROM drive. The Cintiq menu should automatically display. If the menu does not display, double-click on the **Install** icon (located on the CD). Click on the **Install Cintiq** button and follow the prompts to install the driver software.
- Register your tablet when prompted.

Be sure to check the Read Me file for late-breaking news. If you have trouble with the installation, refer to the troubleshooting section in this manual and in the online Help.

Next Steps:

To learn more about using Cintiq, proceed to Using Cintiq. See page 28

Be sure to adjust the tablet calibration to precisely align the screen cursor position with the location of the pen tip. Refer to Calibrating Cintiq. See page 36

Tablet Software Install for Windows with Serial Connection

To install the tablet software:

- First turn on Cintiq, then turn on your computer and login, allowing the operating system to fully load.
- **Plug and Play Installation.** If the **New Hardware Wizard** displays, follow the prompts selecting the default options. When prompted for the driver files, insert the Wacom Tablet CD into your computer's CD-ROM drive. If you are asked for the location of the driver files, select the **CD-ROM drive** option. After completing the **New Hardware Wizard**, click **Finish**, then continue with the *Wacom Driver Software Installation*, below.
- **Manual Installation.** If the **New Hardware Wizard** does not display, insert the Wacom Tablet CD into your computer's CD-ROM drive and continue with the *Wacom Driver Software Installation*, below.
- **Wacom Driver Software Installation.** The Wacom installation menu should automatically display. If the menu does not display, double-click on the **Install** icon (located on the CD). Select **Cintiq** as your tablet and the **Other** button for the interface type. The Cintiq menu will display. Click on the **Install Cintiq** button and the **Continue** button to begin the software installation. Follow the prompts to complete the driver software installation.
- Register your tablet when prompted.
- After the driver installation is complete, make sure you can use your pen on the display screen to move the screen cursor.

Be sure to check the Read Me file for late-breaking news. If you have trouble with the installation, refer to the troubleshooting section in this manual and in the online Help.

Next Steps:

To learn more about using Cintiq, proceed to Using Cintiq. See page 28

Be sure to adjust the tablet calibration to precisely align the screen cursor position with the location of the pen tip. Refer to Calibrating Cintiq. See page 36

Tablet Software Install for SGI or Sun

To install the tablet portion of Cintiq, install the Wacom tablet driver software. Refer to the Quick Start Guide that came with your Wacom UNIX kit for instructions on installing the tablet driver software.

Be sure to check the README file for late-breaking news. If you have trouble with the installation, refer to the troubleshooting section in this manual and in the online Help.

Note: For information on Linux® support, please refer to Wacom's web site at www.wacom.com/productsupport

Next Steps:

To learn more about using Cintiq, proceed to Using Cintiq. See page 28

Be sure to adjust the tablet calibration to precisely align the screen cursor position with the location of the pen tip. Refer to Calibrating Cintiq. See page 36

Using Cintiq

ADJUSTING THE CINTIQ STAND

The stand allows Cintiq's incline to be adjusted to any angle between 13 and 70 degrees. You can also rotate Cintiq from landscape to portrait orientation, or to any angle between +180 and -180 degrees.

Adjusting the Display Incline

To adjust the incline, from the front of Cintiq grasp the Interactive Pen Display on the left and right side at approximately the same height as the Cintiq stand adjustment levers. Use your fingertips to gently pull the incline adjustment levers toward the display unit; this will release the stand's clutch mechanism. Tilt the display to adjust the incline setting.

- To lower Cintiq, pull the left incline adjustment lever toward Cintiq and gently lower Cintiq to the desired incline angle. Release the lever to lock the stand in place.
- To raise Cintiq, pull the right incline adjustment lever toward Cintiq and gently raise Cintiq to the desired incline angle. Release the lever to lock the stand in place.

Note: The stand adjustment levers may exhibit some natural play before the clutch mechanism engages. For the most accurate incline adjustment, first raise the incline slightly higher than you plan to work with, then lower the display to the desired position.

Adjusting Rotation

The Interactive Pen Display can be rotated on the display stand when the incline is less than or equal to 32 degrees.

To adjust rotation, grasp Cintiq by the main body casing and rotate the unit to the desired position; it will move on the bearing hub. You can only rotate the display unit 180 degrees in either direction. Note that the lock brackets can be used to lock Cintiq in either a landscape or portrait orientation. See *Optional Display Configurations* on page 53 for more information.

Removing Cintiq from the Display Stand

To remove Cintiq from the display stand:

- If the lock brackets are attached, remove them from the back of Cintiq.
- Position the display to landscape orientation before removing Cintiq from the display stand. The stand will not release unless Cintiq is in landscape orientation.
- Next, raise the stand incline to the highest position. See *Adjusting the Cintiq Stand* on page 28 for instructions.
- Firmly grasp the Interactive Pen Display on both the left and right sides of the body casing, and lift the unit out of the display stand bearing recess.

Important: When removing Cintiq from the display stand, always lift Cintiq in a direction parallel to the front of the stand.

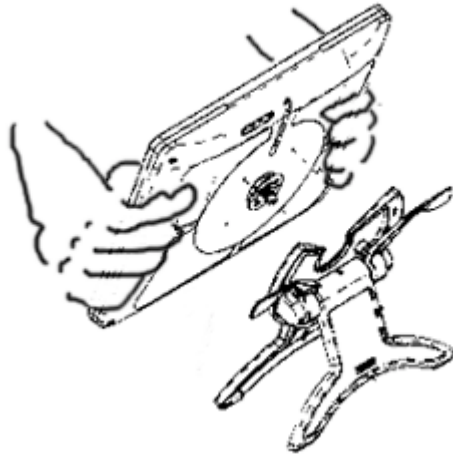

Note: When packing Cintiq for transport, always pack the Interactive Pen Display and Cintiq stand in their original containers and protective cushions. Never pack the two items with the display unit mounted on the stand; this may damage the display unit or stand during transportation.

Using the Grip Pen

WORKING WITH THE GRIP PEN (UP-911E)

As you work with Cintiq, you can rest your hand on the display screen, just as if it were a drawing board or sheet of paper. Hold the Grip Pen as you would a pencil. Make sure the side switch is in a convenient location where you can press it with your thumb or forefinger, but won't accidentally press it while drawing.

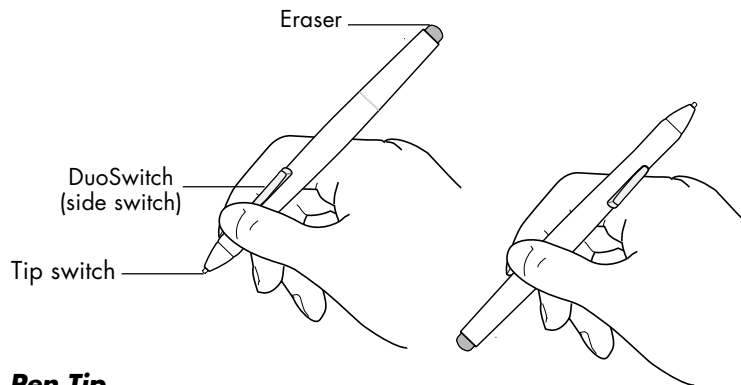

Note: The Grip Pen should never be stored in a container where it will rest on its tip or eraser. When the pen is not in use, place your pen in the pen stand or lay it flat on your desk.

Pen Tip

The pen is activated as soon as it enters proximity, about 5 mm (0.2 in), above the Interactive Pen Display screen. This allows you to position the screen cursor or use the DuoSwitch without touching the pen tip to the display screen.

When pressure is applied to the pen tip, the tip switch is turned *on* and the pen simulates a mouse button click. The tip click pressure can be adjusted in the Wacom Tablet Control Panel. Please refer to the online Help for details.

Eraser

To use the eraser, hold the Grip Pen upside down. When the eraser is within proximity of the active area, the tablet reports the pen coordinates and the pressure applied to the eraser.

The eraser can be used as an eraser or assigned to another function, depending on the application. The tablet distinguishes the tip switch from the eraser switch. Refer to the online Help for the pen settings.

DuoSwitch

The DuoSwitch is programmable, and can be used to perform the same click and double-click functions as the tip switch. Toggle the DuoSwitch in either direction to activate the upper or lower button functions. Please refer to the online Help for more information on switch settings.

Note: If you do not care to use the side switch, you can remove it by following the directions in *DuoSwitch Removal and Installation*, on page 51.

USING A PEN

Pointing and Selecting

Move the Grip Pen above the Cintiq display screen to position the screen cursor. The cursor jumps to the location where you place the pen (absolute positioning). Press the pen tip on the display screen to make a selection.

Note: If the screen cursor does not closely follow the pen tip, you will need to calibrate the Interactive Pen Display. (See *Calibrating Cintiq* on page 36.) If the screen cursor does not jump to a position close to the pen tip when you place the pen on the display screen, then the tablet driver did not load yet. In this case, refer to the online Help for troubleshooting tips. (See *Learning More About Cintiq* on page 37 for information on accessing the online Help.)

Clicking

Tap the display screen once with the pen tip, or touch the pen to the display screen with enough pressure to generate a mouse click.

Double-Clicking

Press the upper side switch (Windows) or lower side switch (Macintosh), or quickly tap the display screen twice in the same place with the pen tip. Double-clicking is easier when the pen is perpendicular to the tablet screen.

Tip: You can make navigating with the pen easier by configuring Windows to select when the pen is over an icon and to launch the icon with a single click. To turn on this feature:

Windows Me, 2000, or XP. Open a folder, select the **Tools** pull-down menu, and **Folder Options...** From the **General** tab select the option **Single-click to open an item (point to select)**.

Windows 98. Open a folder, select the **View** pull-down menu, and **Folder Options...** From the **General** tab select the **Web style** option.

Dragging

Select an object, then slide the pen tip across the display screen to move the object.

Erasing

In supporting applications, the pen's eraser works like the eraser on a pencil. In text applications, use the eraser to select text, then lift the eraser from the tablet to delete the text.

Working with Cintiq

The Cintiq 18SX Interactive Pen Display and stand were designed to provide you with the widest possible range of flexibility and ergonomic work approach. The design allows for fast, easy transitions between three basic modes of use, enabling you to quickly adjust Cintiq to a different position whenever the need arises. You may want to evaluate each mode to determine which best fits your particular working style and tasks.

As you work with Cintiq, you can rest your hand lightly on the display screen, just as if it were a drawing board or sheet of paper.



TABLET MODE

At inclines of less than 32 degrees, the display unit can be freely rotated on the display stand without touching the desktop. In this position, Cintiq emulates a traditional animator's table and gives you the freedom to rotate the display unit to any angle for the greatest comfort and accuracy of stroke while drawing or editing images.



DISPLAY MODE

This is a common position when using Cintiq as a primary display, and when your work requires a large amount of keyboard input. Display mode is also useful when presenting your work to co-workers or clients.

Hints:

- If the rotation lock brackets are attached to the back of Cintiq, they must be removed before Cintiq can be rotated.
- Before rotating the display unit, be sure the cable has been untucked from the cable guide and is freely rotating behind the unit.
- Because the Cintiq drawing surface will be a little higher than your desk, consider adjusting the height of your desk or chair to assure comfortable use of the device.



LAP MODE

When working in lap mode, you can freely position Cintiq without the use of the stand. If you are not familiar with how to remove Cintiq from the display stand, refer to page 29 for details.

Hints:

- Set the display stand to the upright position so that you can use it as a tablet stand whenever Cintiq is not in use. You can also use the stand as a cable guide—this makes it easier to remove the display unit from the stand and to return it back to the stand.
 - The rear side of the display unit has a flat upper surface for resting the unit securely against a straight desk edge.
- Important:** Do not place the display unit on the desk or any other surface by itself—this may bend, crimp, or otherwise damage the cable.
- Insert the main cable into the cable guide located at the back of Cintiq—this will reduce the possibility of placing undue stress on the cable when working with Cintiq.
 - Make sure that you comfortably support the body of the display unit in your lap, and that the unit is not resting on the cable. If the unit rests on the cable, the cable will excessively bend or crimp and be damaged.
 - Maintain a good posture at all times, and change your position if you feel any discomfort due to your work position or the weight of Cintiq.
 - Do not pull the cable out of its computer connections by accidentally moving the Interactive Pen Display too far from the computer.

To minimize fatigue, organize your work area so you can work comfortably. Position Cintiq, the Grip Pen, and your keyboard so they are easily accessible without unnecessary reaching. The Interactive Pen Display should be positioned so you can view it comfortably with a minimum of eyestrain.

Here are some other points to keep in mind:

- Take short breaks between tasks to stretch and relax your muscles.
- Use a gentle grip when working with the pen.
- Alternate tasks throughout the day.
- Minimize awkward postures and repetitive movements that cause discomfort.
- Alternate between different modes of use.

Next Step: *If you have not already done so, learn about the basics of customizing the Grip Pen. See page 35*

Customizing Cintiq

CUSTOMIZING THE GRIP PEN

The Basics

The Wacom Tablet Control Panel makes it easy to customize Cintiq and the Grip Pen. Be sure to see the online Help for detailed information on working with the Wacom Tablet Control Panel and customizing Cintiq. To open the control panel:

Windows systems: Click on the Windows **Start** button and choose **Programs**. From the **Wacom Tablet** group, choose the **Wacom Tablet** option.

Macintosh systems: For OS X, in the **Finder**, select the **Go** menu and choose **Applications**. Open the **Wacom** folder and double-click on the tablet icon. (For earlier Macintosh operating systems, from the **Apple** menu choose **Control Panels** and then **Wacom Tablet**.)

SGI workstations: Use your Grip Pen to bring up the **Icon Catalog**. Select the **WacomTablet** page, then double-click on the **WacomTablet** icon.

Sun workstations: At the command prompt, enter `</usr/sbin/wacomcpl>`

When you open the control panel, an icon for the Grip Pen is displayed in the Tool List and the appropriate tabs are displayed. To customize the pen, make your changes to the tab controls. For Windows systems, and for SGI and Sun workstations, click **Apply** or **OK** to save your changes.

Note: Application-specific settings are for advanced users. Application-specific settings are not available for SGI and Sun workstations.

The screenshot shows the 'Wacom Tablet Properties' window. Annotations include:

- Applications with Customized Tool Settings:** A pull-down menu that accesses a variety of control panel features.
- Tool List:** Displays applications with customized settings. The icon shows that tool settings apply to all applications. It also displays an icon for the Grip Pen.
- Tabs:** Display settings for the Grip Pen and selected application. Current selections are highlighted, and wedges emphasize the relationship between tab settings and the selected tool and application.
- Buttons:**
 - Add Application to List...** and **Add Tool to List...**: For creating application-specific settings. See the online Help for details.
 - OK**, **Cancel**, **Apply**, and **Help...**: For saving changes and accessing help.
 - Reset Tab to Defaults**: Resets the selected tab to its factory default values.
 - Revert Tab**: Returns a tab to its previously saved or last applied settings.
 - Copy Settings To...**: Copies settings from one tool or application to another.

For Windows, SGI, & Sun. **OK** saves changes and closes the control panel. **Cancel** closes the control panel without saving changes. Use **Apply** to save changes without closing the control panel. **Help** displays online Help for the control panel.

Windows control panel shown.

Calibrating Cintiq

You may want to calibrate Cintiq and the Grip Pen in order to align the screen cursor position with the position of the Grip Pen on the display screen. This may be required to adjust for parallax caused by the display screen overlay. After setting Cintiq in its working position, follow the procedure below to calibrate the tablet and pen.

- In the Wacom Tablet Control Panel, select the **Calibration** tab.
- If you are working with multiple displays, be sure the display corresponding to Cintiq is selected in the **Monitor** menu. (The description may vary depending on the platform you are working with. For example, on a Macintosh system the option is Cintiq 18SX.)
- Click on the **Calibrate...** button to display the calibration screen.
- Hold the pen as you normally do, and use the pen tip to click on the cross-hairs in the upper-left corner.
- Then click on the cross-hairs that are displayed in the lower-right corner.

(For Windows systems, or SGI or Sun workstations, you will need to click **Apply** or **OK** for the changes to take effect.)

Note: The calibration setting applies to all applications.



Cross-hairs



Windows screen captures shown.

Adjustment pattern for phase and pitch (VGA only). See page 41 for details.

Learning More About Cintiq

Refer to the online Help for information on using and customizing Cintiq.

Windows systems: To view Help, click on the Windows **Start** button and choose **Programs**. From the **Wacom Tablet** group, choose the **Wacom Tablet** option. Then in the Wacom Tablet Control Panel, click on the **Help...** button.

Macintosh systems: To view Help for OS X, in the **Finder** select the **Go** menu and choose **Applications**. Open the **Wacom** folder and double-click on the tablet icon. (For earlier Macintosh operating systems, from the Apple menu choose **Control Panels** and then **Wacom Tablet**.) Then in the Wacom Tablet Control Panel, click on the **?** button.

SGI workstations: To view Help, use your Grip Pen to bring up the **Icon Catalog**. Select the **WacomTablet** page, then double-click on the **WacomTablet** icon. In the Wacom Tablet Control Panel, click on the **Help...** button.

Sun workstations: To view Help, at the command prompt enter `</usr/sbin/wacomcpl&>` In the Wacom Tablet Control Panel, click on the **Help...** button.

To read the Help before installing Cintiq, first insert the Wacom Tablet CD into your computer's CD-ROM drive.

Windows and Macintosh systems: When the software menu appears, click on the **Explore CD** button. Locate and open the appropriate language folder. Then double-click on the **Cintiq Help** icon.

SGI workstations: Issue the command `<acoread /CDROM/SGI/opt/pl_help.pdf>`

Sun workstations: Issue the command `<acoread /cdrom/cdrom0/Sun/pl_help.pdf>`

You will need Acrobat Reader V3.0 or greater to view the Help file.

ADJUSTING THE LCD DISPLAY

Factory Presets, Multi-Sync, and User Settings

Factory Presets: To display images with the best quality (based on the incoming signal), Cintiq comes with a number of factory default standard display modes. Refer to pages 55 and 56 for input signal specifications.

Multi-Sync: When connected as a VGA display, Cintiq attempts to automatically synchronize to the incoming signal. If Cintiq does not automatically synchronize with the incoming signal, you can use the OSD **Reset Auto Adjust** option to initiate display synchronization. If necessary, further screen display adjustments can be manually made using the On Screen Display (OSD) controls.

User Settings: When you manually set the display using the OSD function, the settings are stored within Cintiq for use the next time the unit receives a similar signal. This is applicable to all display modes.

Working with On Screen Display Settings

Cintiq is equipped with an On Screen Display function. The OSD function enables you to adjust and optimize a variety of display settings at the touch of a button. To avoid accidental activation when the Interactive Pen Display is rotated, the OSD controls are located on the back of the unit. Simply reach over the top of the display unit to locate the buttons with your fingers.

Note: The + and – selection buttons are embossed with braille-style dots so that you can easily identify them by touch.

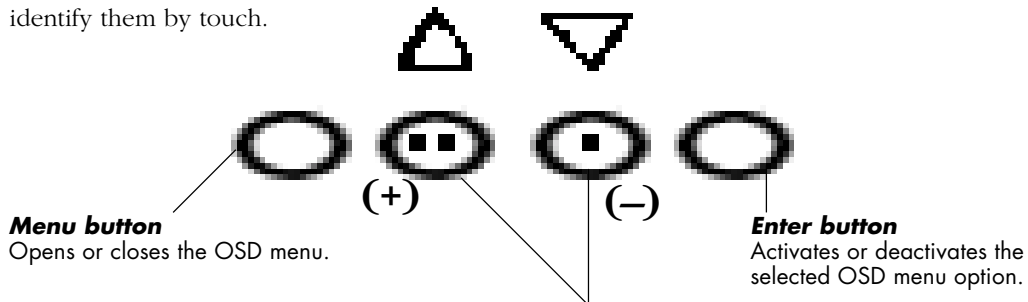

The basic process for working with the OSD is as follows:

- Press the **Menu** button to open the OSD main menu.
- Use the + or – buttons to select an option. When the option you want to adjust is highlighted, press the **Enter** button. The current settings and adjustment sub-menu for that option will appear.
- Use the + or – buttons to adjust the option settings.
- When you have made your changes, press the **Enter** button to save. To exit, press the **Menu** button.

Notes: All settings are automatically saved when the OSD menu closes. If you make changes to the display appearance and cannot return to the original settings, use the **Reset Recall** option to return Cintiq to its original factory defaults.

When you open the On Screen Display (OSD), the following menu options are displayed as icons:

 **Contrast** Select to increase or decrease image contrast.

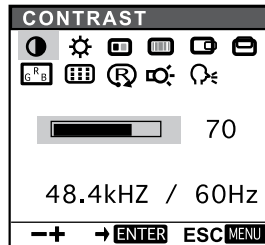

 **Brightness** Select to increase or decrease image brightness.

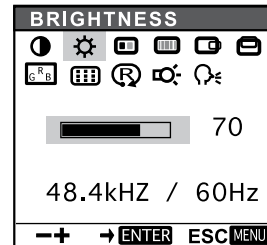

 **Phase** (VGA only) Select to reduce or eliminate horizontal distortion lines. To automatically adjust, use the **Reset** option.

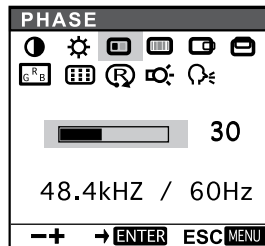

 **Pitch** (VGA only) Select to reduce or eliminate vertical distortion lines. To automatically adjust, use the **Reset** option.

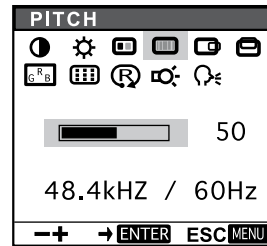



Horizontal Center
(VGA only) Select to move the screen image left or right. To automatically adjust, use the **Reset** option.

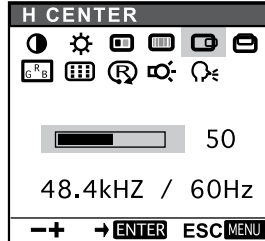

Vertical Center
(VGA only) Select to move the screen image up or down. To automatically adjust, use the **Reset** option.

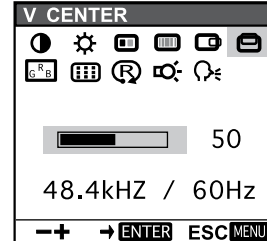

Menu Position
Select to move the OSD menu around the display screen.

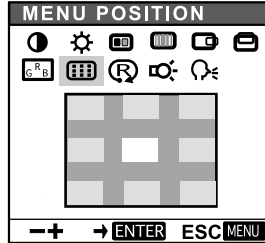

Reset Provides two options: Use **Auto Adjust** to reset only the image parameters.

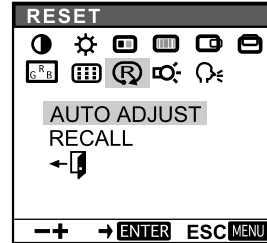

Use **Recall** to reset all screen options to the factory default.

Selecting the exit icon exits the **Reset** window without resetting anything.



Color Provides settings for 9300°, 6500°, and 5000° Kelvin. Also provides a **User** option that enables you to adjust Red, Green, and Blue independently.

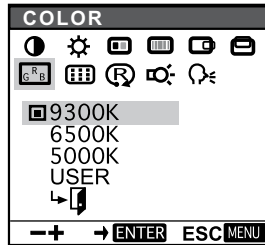

Choose a setting to work with and press **Enter** to activate your selection. Change the **User** setting by selecting the icon:

In the **User Adjustment** window, change Red, Green, or Blue to calibrate color. To exit, select the icon:

Note: Manual changes to the color settings will invalidate the CintiQ color profile.

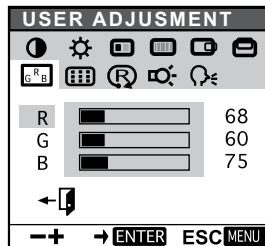

Backlight Select to increase or decrease the backlight brightness level.

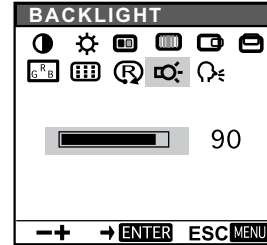

Language Select to choose a language option for the OSD: **English, Deutsch, Français, Español, Italiano, or Japanese.**

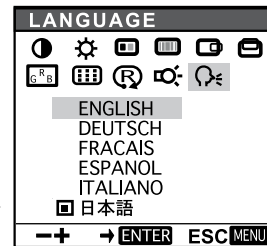

Adjusting Pitch and Phase (VGA Only)

Some computers and video cards may not allow the multi-sync function to fully work when Cintiq is first connected. If some portion of the text appears blurred, adjust the pitch and phase by following the procedure below. For crisp images, set the Cintiq resolution of your video card to 1280 x 1024.

- In the Wacom Tablet Control Panel, select the **Calibration** tab.
- If you are working with multiple displays, be sure the display corresponding to Cintiq is selected in the **Monitor** menu. (The description may vary depending on the platform you are working with. For example, on a Macintosh system the option is Cintiq 18SX.)
- Click on the **Calibrate...** button to display the calibration screen.
- Using the OSD controls, open the OSD Menu and select the Pitch icon. Then adjust the pitch level so that the pattern of fine vertical stripes displays evenly.
- In the OSD Menu, select the Phase icon and adjust the phase level so that the adjustment pattern shows clearly.
- After completing these adjustments, press the **Enter** and **Menu** buttons to exit the OSD Menu.
- **For Macintosh**, click on the **Cancel** button to exit from the monitor calibration screen.
- **For Windows**, click on the **Cancel** button or press the spacebar to exit the screen.

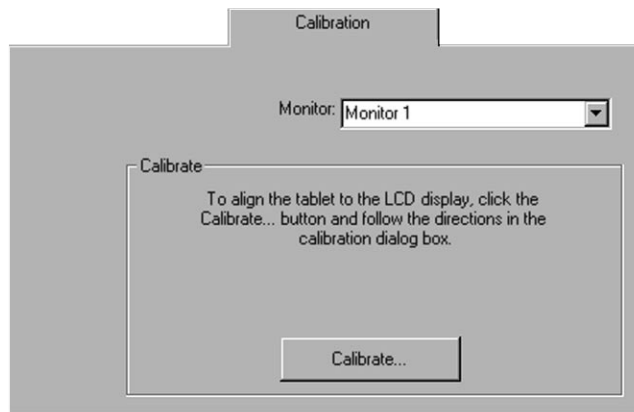

Adjustment pattern for phase and pitch (VGA only).

Windows screen captures shown.

Power Saving

Cintiq conforms to VESA and Energy Star power savings guidelines. When using Cintiq with a VESA Display Power Management Signaling (DPMS) compliant computer or video card, the display will automatically comply with the power saving parameters below.

Power Saving Mode	H-sync	V-sync	Video	Power Consumption	Power Lamp
Power On	Yes	Yes	Active	45 W, max.	Green
Standby mode	No	Yes	Blanked	5 W, max.	Orange/Green
Suspend mode	Yes	No	Blanked	5 W, max.	Orange/Green
OFF mode	No	No	Blanked	5 W, max.	Orange

Caring for Cintiq

Keep the Grip Pen and the Cintiq LCD screen surface clean. Dust and dirt particles can stick to the pen and cause wear to the display screen surface. Regular cleaning will help prolong the life of your LCD screen surface and pen. Keep Cintiq, the Cintiq stand, and the Grip Pen in a clean, dry place and avoid extremes in temperature. Room temperature is best. Cintiq, the Cintiq stand, and the Grip Pen are not made to come apart (except where specifically indicated for removal and replacement of the pen's DuoSwitch). Taking apart the product will void your warranty.

CLEANING

To clean the Cintiq casing, the Cintiq display stand, or the Grip Pen, use a soft cloth and mild detergent (such as dishwashing liquid) diluted with water. Do not use paint thinner, benzene, alcohol, or other solvents to clean the unit casing, display stand, or pen.

To clean the display screen, use an anti-static cloth or a slightly damp cloth. When cleaning, apply only a light amount of pressure to the display screen and do not make the surface wet. Do not use detergent to clean the display screen; this may damage the coating on the screen. Please note that damage of this kind is not covered by the manufacturer's warranty.

REPLACING THE PEN TIP

The pen tip will wear with normal use. When the pen tip gets too short, you can replace it with one of the extra tips that came with the pen.



To remove the old tip:

Clasp it with a pair of tweezers, needle-nosed plier, or similar instrument and pull the old tip straight out of the pen.

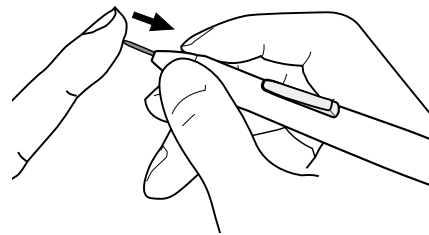

To insert a new tip:

Slide it straight into the barrel of the pen. Firmly push the tip until it stops. The new tip will slide into the correct position.

If the pen tip wears and becomes angular, it may damage the coating on the Cintiq display screen. To avoid this, periodic tip replacement is recommended.

WARNING  **Prevent children from swallowing the pen tip or side switch.** The pen tip or side switch may accidentally be pulled out if children are biting on them.

MAINTAINING THE CINTIQ STAND

If the stand's felt ring or the rear foot pads become worn, you may want to replace them to prevent damage to the back of the Interactive Pen Display or to your work surface.

To replace the felt bearing mount ring, carefully remove the worn ring and replace it with the spare ring that came with Cintiq.

To replace the rear display stand foot pads, carefully remove the worn pads and replace them with the spare foot pads that came with Cintiq.

Troubleshooting

If the Wacom tablet driver failed to load properly, first perform any recommended action in the error message on your screen.

If the Cintiq hardware does not function properly, refer to the troubleshooting section below.

If necessary, refer to the online Help for additional troubleshooting information.

Answers to frequently asked questions and information on known issues can be found on the Wacom web site. See pages 49 and 50 to locate the Internet address for your region.

TESTING CINTIQ

If Cintiq does not power up, check the following:

- Verify that the cabling between Cintiq and your computer is correct. Be sure the power supply is plugged into an active AC outlet and that it is connected to Cintiq. Verify that any other display connection(s) to your video card are correct.
- Verify that Cintiq is powered on.
- The Cintiq power LED should light whenever the cabling is properly connected and the Cintiq power switch is on. When the computer is turned on and a video signal is received, the Cintiq display will activate and the power LED will glow green. If there is no display, verify that your video card has been properly installed and is functional. If you have another display that is compatible with your video card, you can connect that display to the card in order to verify that the video card is operating correctly.

TESTING THE TABLET AND GRIP PEN

If you cannot make a selection on the display screen with the Grip Pen:

- Test the pen by pressing the pen tip against the surface of the tablet. The status LED should light green.
- Now, without applying pressure to the pen tip (but keeping the pen within proximity of the tablet surface), press the side switch. The status LED should again light green.
- Next, bring the pen's eraser within proximity of the tablet surface and press it against the tablet. The status LED should light green.

If the status LED does not light green for these tests, be sure you are using the correct pen that came with Cintiq. If you are still having problems, you may have a defective pen or tablet.

DISPLAY TROUBLESHOOTING

If you encounter problems with the Cintiq display, refer to the following table. Your problem may be described here, and you can try the solution offered. For additional information about color issues, refer to the documentation that came with your operating system or applications.

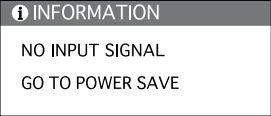
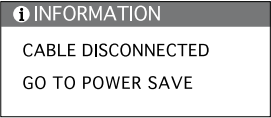
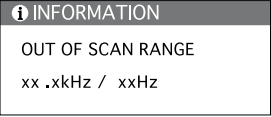
General Problems	Solutions
No display. The power LED is off.	<ul style="list-style-type: none">■ Verify that the AC power cable is connected, and that the Cintiq power switch is turned on.■ Verify that the Digital/Analog (DVI/VGA) switch is properly set. Restart your computer after changing the position of the switch.
No display. The power LED is lit green.	<ul style="list-style-type: none">■ Check the contrast, brightness, and backlight controls. Adjust as necessary, or open the OSD menu, go to the Reset menu and select the Recall option.
The LED is lit orange, or the following message appears briefly on your display screen: 	<ul style="list-style-type: none">■ Your computer may be in a power management mode. Touch the pen tip to the display screen, move the mouse, or depress any key on your keyboard.■ Verify that the video card is properly installed.■ Check the video cable for bent or broken connector pins. Then properly connect the video cable.
The following message appears briefly on your display screen: 	<ul style="list-style-type: none">■ Check that your computer is turned on.■ Check that the Cintiq video cable is fully connected.■ Check the video connector and any video adaptors for bent or broken connector pins. Then properly connect the video cable and necessary adaptors.
The following message appears briefly on your display screen: 	<ul style="list-style-type: none">■ The input signal frequency is incorrectly set or not compatible with Cintiq. Connect a different display and set the refresh rate (vertical frequency) to some value between 50 and 75 Hz. If your video card driver supports adjustment of the horizontal frequency, make sure it is set to some value between 30 and 80 kHz.■ The resolution is set too high (1280 x 1024, maximum).■ The refresh rate is set too high (75 Hz, maximum).■ Set the display properties to detect plug and play monitors.

General Problems (cont.)**Solutions**

-
- | | |
|---|---|
| The image appears multiple times on the display. | ■ Do not extend the video cable. Do not use an input selector switch box. |
| When a still image is displayed for a long period of time without refreshing the screen, an after-image remains for a short period of time. | ■ Use a screen saver or other power management feature. |
| The color white does not display as white. | ■ Be sure the Cintiq color profile has been installed and is selected as the profile for use with your operating system and applications. Verify also that the display is operating at the factory default settings. If that is not sufficient, then adjust color as necessary. For details on color management, refer to your operating system and application documentation.
■ Verify that the video cable and connectors are fully connected. |

VGA Problems**Solutions**

-
- | | |
|--|--|
| The display ripples or flickers. | ■ Open the OSD menu, go to the Reset menu, and select the Auto Adjust option. Then, if necessary, manually adjust pitch and phase.
■ Verify that the display adaptor or video card matches the specifications for Cintiq.
■ Adjust the refresh rate in the Display Properties control panel. |
| The display is not clear. | ■ As necessary, adjust contrast or brightness, pitch and phase.
■ Set the display resolution of your video card to 1280 x 1024. |
| The display and LCD panel are not lined up. The display size is not correct. | ■ Open the OSD menu, go to the Reset menu, and select the Recall option.
■ As necessary, adjust pitch and phase, and horizontal and vertical position. Note that some video cards may not show the display in proper sizing. |
| The display ripples or shows a moiré pattern. The display color is not even. | ■ Open the OSD menu, go to the Reset menu, and select the Recall option.
■ As necessary, adjust pitch and phase. |

OBTAINING TECHNICAL SUPPORT

If you have a problem with Cintiq, first check the appropriate setup section in this guide to make sure the unit is installed correctly. Then review the Troubleshooting section within this guide and in the online Help; your problem may be described there and you can try the solution(s) offered. If you cannot find the answer in this guide or in the online Help, you may find updated information about your problem in the appropriate Read Me file for your platform (located on the Wacom Tablet CD). You can also check the product FAQs (Frequently Asked Questions) on the Wacom web site. (See next page for support listings).

Pre-Call Checklist

If you cannot solve the problem, contact Wacom Technical Support. You may want to make extra copies of the form on this page. When you call, you should be at your computer with the following information available:

- The Wacom *Cintiq 18SX Installation Guide and User's Manual* _____
- Cintiq 18SX serial number
(Look at the label on the back of the display unit. You may have to rotate the unit in order to see the serial number label.) _____
- Driver version number
(Look on the Wacom Tablet CD or in the Wacom Tablet Control Panel.) _____
- The make and model of your computer or workstation _____
- The make, model, and connection (DVI or VGA) of your video card _____
- Operating system version _____
- The tablet data connection (USB or serial) on your computer _____
- A list of the peripheral devices attached to your computer _____
- The software application and version you were using when the problem occurred _____
- The exact wording of any error message that appeared on your screen _____
- What happened and what you were doing when the problem occurred _____
- How you tried to solve the problem _____

Support Staff

If you think your Cintiq 18SX Interactive Pen Display is not working properly, contact the Wacom support staff in your area.

USA, Canada, Central and South America

Contact your local distributor, or:

Worldwide Web:	http://www.wacom.com/productsupport	24-hour Technical Support information: FAQs—Frequently Asked Questions and answers. (English) Software updates. (English) Email support. (English) Software updates. Technical Support. (English) (7:30 am to 5:00 pm Monday – Thursday, 8:30 am to 5:00 pm Friday, Pacific Time) Technical Support. (English)
Anonymous FTP Site: Phone:	ftp.wacom.com/pub/drivers ++1-360-896-9833	
FAX:	++1-360-896-9724	

Europe, Middle East and Africa

Contact your local distributor, or:

Worldwide Web:	http://www.wacom-europe.com	Software updates. Online support database.
Anonymous FTP Site:	ftp://ftp.wacom-europe.com/pub/	Software updates.
Phone (Austria):	++43-(0)1-790 825 550	Technical Support.
Phone (Belgium):	++32-(0)2-275 0691	Technical Support.
Phone (France):	++33-(0)1-7020 0070	Technical Support.
Phone (Germany):	++49-(0)69-6630 8200	Technical Support.
Phone (Italy):	++39-(0)2-4528 7050	Technical Support.
Phone (Netherlands):	++31-(0)20-517 4705	Technical Support.
Phone (Switzerland):	++41-(0)1-212 2818	Technical Support.
Phone (United Kingdom):	++44-(0)207-744 0831	Technical Support.
Phone (other countries):	++49-(0)180-500 4397	Technical Support.
FAX:	++49-(0)180-500 4398	Technical Support.
Internet Email:	support@wacom-europe.com	Technical Support.

Japan

Contact your local distributor, or:

Worldwide Web:	http://tablet.wacom.co.jp	Software updates and information. (Japanese)
FAX:	++81-(0)47-380-8711	Technical Support. (Japanese)
Internet Email:	tablet@wacom.co.jp	Technical Support and sales. (Japanese)

Asia Pacific (English)

Contact your local distributor, or:

Worldwide Web:	http://ap.wacom.co.jp	Software updates and information. (English)
Phone:	++81-(0)3-3371-1595	Technical Support. (English)
FAX:	++81-(0)3-3371-1468	Technical Support. (English)
Inquiry Form:	http://ap.wacom.co.jp/faq/tablet/inquiry_form.html	Technical Support. (English)

To purchase parts and accessories, call toll-free: 1-888-884-1870 (USA and Canada only) or visit Wacom's web site at <http://www.wacom.com/wacomdirect/> (USA only). Outside of the USA and Canada, please contact your local dealer or distributor, or contact Technical Support.

Appendices

DUOSWITCH REMOVAL AND INSTALLATION

Some users prefer to remove the DuoSwitch when working with the Grip Pen. For example, you may want to remove the switch in order to focus on a drawing and eliminate any accidental clicks that would occur if you unintentionally pressed on the switch. Note, however, that removing the DuoSwitch also removes the button functionality it offers. For most users it is unnecessary to remove the DuoSwitch.

To remove the DuoSwitch:

1. Firmly clasp the DuoSwitch in the middle and pull out. (Press in on the rubberized grip in order to better grasp the switch.)

Important: Do not remove the switch by prying it from either end as this may damage your Pen. NEVER adjust the trimmer capacitor that will be visible when the switch is removed. When using the pen without the DuoSwitch, always replace the original rubberized grip with the optional grip in order to protect the trimmer capacitor.

2. Remove the pen tip cone by turning it counterclockwise. Then pull the grip forward over the pen tip.
3. Install the optional grip by aligning the pen case rails with the grooves inside the grip and pushing the grip over the pen tip. Then replace the pen tip cone by turning it clockwise onto the pen.

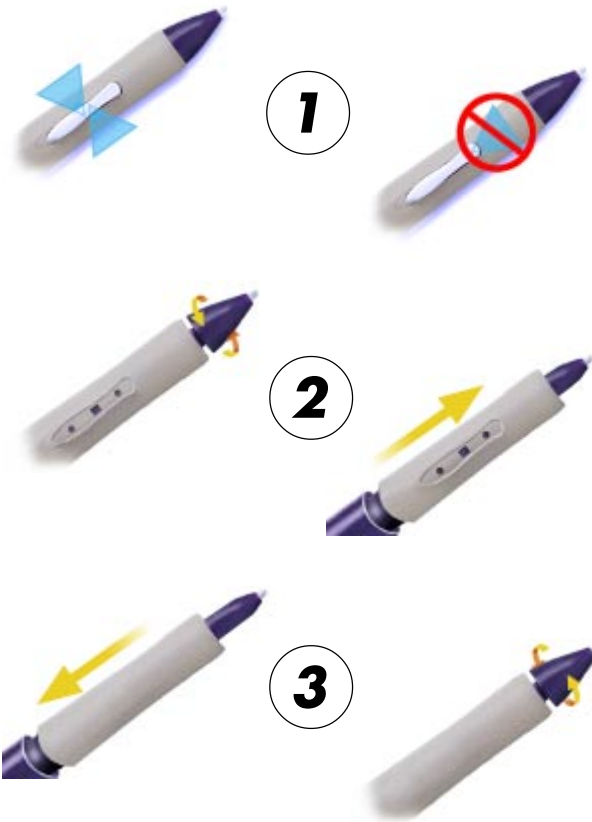

To Install the DuoSwitch:

1. Remove the pen tip cone by turning it counterclockwise. Then pull the grip forward over the pen tip.
2. Install the original grip (the one with the DuoSwitch access slot) by aligning the pen case rails with the grooves inside the grip and pushing the grip over the pen tip. When properly positioned, the DuoSwitch access hole will reveal the trimmer capacitor. Then install the pen tip cone by turning it clockwise onto the pen.
3. Align the DuoSwitch into place, making sure to match the switch position to the grip molding. Then gently press in on the DuoSwitch until it snaps into place.

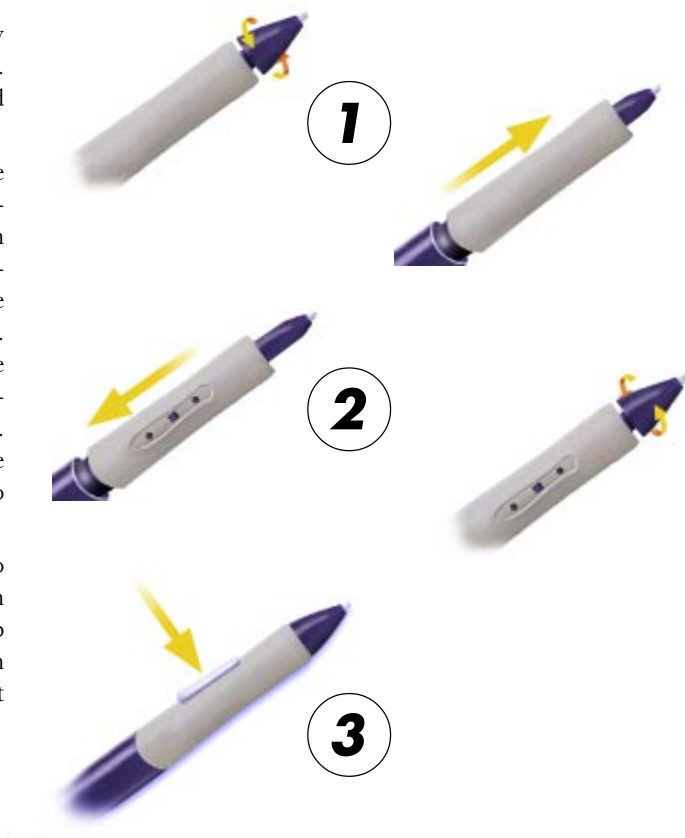

OPTIONAL DISPLAY CONFIGURATIONS

Using the lock brackets, you can lock the Interactive Pen Display in either a landscape or portrait orientation when mounted on the Cintiq stand.

Locking the Display to the Stand

To lock Cintiq to the display stand:

- Rotate the Interactive Pen Display to either a landscape or portrait position.
- Two VESA mount screw holes should be visible on the back side of Cintiq, just above the display stand cutout.
- Locate the left and right lock brackets; they mirror one another and must be installed on the correct sides for a proper fit. Make sure the groove in each lock bracket follows the contour of the stand ridge, and that the arrows on the brackets point toward each other. Place each bracket, with the bracket hook over the stand ridge, and insert the lock screws through the bracket and into the VESA screw holes.
- Hand tighten the lock screws until each lock bracket is firmly attached.

Cintiq should now be firmly attached to the stand.

Note: To change the image displayed by Cintiq to portrait orientation, you need to purchase and install Pivot® software by Portrait Displays® (www.portrait.com). With Cintiq in portrait orientation, select the portrait option in the Pivot software. The Interactive Pen Display and Grip Pen orientation will adjust to portrait mode.

Important: The tablet driver only supports a 90 degree clockwise rotation to portrait orientation.

CAUTION  Avoid placing excess physical pressure on the Cintiq stand; doing so can damage the stand.

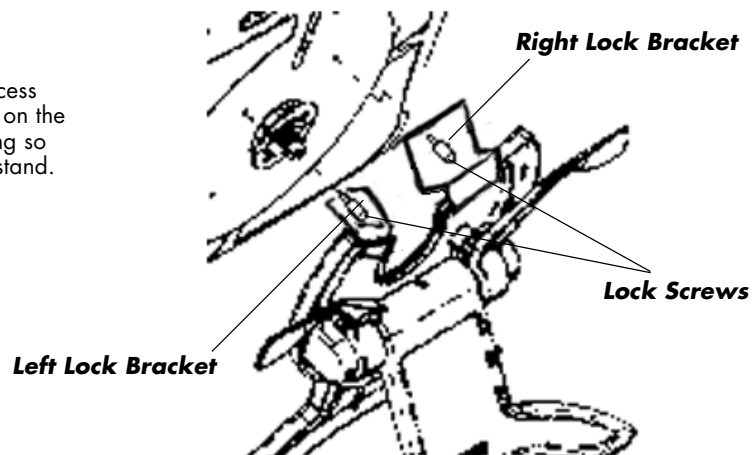

Using an Alternate Mount or Stand

If you plan to use Cintiq in an installation that requires the use of an alternate mounting platform, you can mount the Interactive Pen Display onto a VESA conforming mount arm or stand. A VESA mounting platform will require mount screws that are 4 mm wide with a 0.7 mm pitch (M4 Regular), and a maximum screw clearance depth of 10 mm. Exceeding the clearance depth of 10 mm will damage Cintiq internal components. The hole pattern should be a 100 x 100 mm square. The VESA mounting platform will also require an aperture of sufficient clearance to accommodate the Cintiq cable and bearing hub (70 mm diameter).

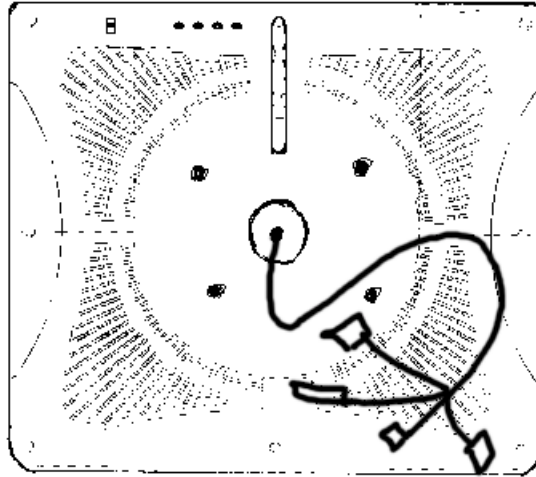

To attach Cintiq to a different mounting platform:

1. Turn off your computer and power off Cintiq. Then disconnect all cables from between the unit and your computer.
2. If Cintiq is mounted, remove it from the display stand.
3. Protect the display screen surface by spreading a soft cloth onto a flat table and placing Cintiq face down on the cloth.
4. Using the appropriate screws for your mounting platform, firmly attach Cintiq to the alternate mounting platform. Be sure the integral cable and bearing mount pass through the mount aperture without binding or excess pressure.
5. Refer to the appropriate installation instructions, beginning on page 18, and reattach the cabling.

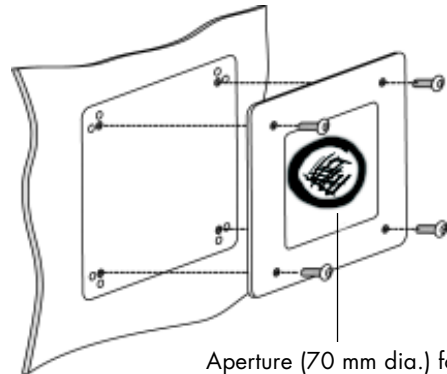

Aperture (70 mm dia.) for cable and bearing hub.

CAUTION  When attaching Cintiq onto an alternate mounting platform, be sure to follow all instructions in the documentation supplied by the platform manufacturer. If improperly installed, the unit could fall, resulting in damage to the unit or physical injury.

SPECIFICATIONS

General Specifications

Physical dimensions (W x D x H):	468 x 407 x 70 mm (18.4 x 16.0 x 2.8 in), excluding stand
Weight:	7.7 kg (17.0 lb), excluding stand 9.7 kg (21.4 lb), including stand
Input voltage:	18 VDC
Power consumption:	60 W or less, (18 VDC)
Operating temperature and humidity:	5°C to 35°C, 20 to 80% RH (noncondensing)
Storage temperature and humidity:	-10 to 60°C, 20 to 90% RH (noncondensing) (maximum storage humidity is 38% at a temperature of 60°C, and maximum storage temperature is 42°C at a humidity of 90%)

LCD Display

Display:	a-Si TFT active matrix LCD
Screen size:	18.1 in (14.1 x 11.3 in)
Signal inputs:	VGA (Analog RGB) DVI (Digital)
Resolution:	1280 x 1024 pixels (SXGA), 1024 x 768 pixels (XGA), 800 x 600 pixels (SGA), 640 x 480 pixels (VGA) 720 x 400 (VGA), others
Refresh rate:	50 to 75 Hz (vertical) All scan modes are non-interlaced.
Pixel pitch:	0.2805 x 0.2805 mm (0.011 x 0.011 in)
Color depth:	16,777,216 colors (24 bit)
Pixels:	1,310,720
Brightness:	210 cd/sq. m (typical)
Contrast ratio:	300:1
Plug and Play:	DDC2B, EDID

LCD Display (cont.)

LCD quality:

Each Cintiq 18SX LCD panel is produced under very stringent quality standards. Production techniques cannot guarantee an absolutely perfect TFT display, and some panels may exhibit a certain number of pixels that show an incorrect color.

Wacom quality standards are based on internationally accepted standards for LCD displays. Wacom requires more than 99.9999% of the 1,310,720 pixels on each Cintiq 18SX to function perfectly, and does not allow any pixel to be always white or always black. A small number of pixels (10 or less) are allowed to show a wrong color for some parts of the color spectrum.

Tablet

Reading technology:	Electromagnetic give and receive method
Active area:	359.0 x 287.2 mm (14.13 x 11.31 in)
Resolution:	20 lpmm (0.05 mm) (508 lpi (0.002 in)) max
Accuracy:	±0.5 mm (±0.02 in), average
Maximum reading height:	5 mm (0.2 in)
Maximum report rate:	205 points/sec., max
Pressure levels:	512 levels
Communication interface:	USB or RS-232C serial

Display Stand

Physical dimensions (W x D x H):	329 x 299 x 165 mm (13.0 x 11.8 x 6.5 in)
Weight:	2.0 kg (4.4 lb)
Rotation:	±180°
Incline:	13° to 70° from horizontal
Primary orientation:	Landscape, lockable

Power Supply

Input voltage: 100 to 240 VAC, 50/60 Hz
Output voltage: 18 VDC, 4.0 A

Grip Pen (Model UP-911E)

Pressure levels: 512
Pen tip travel: 0.1 mm (0.004 in) or less
Eraser tip travel: 2 mm (0.08 in), approximately
Physical dimensions: 159.0 x 14.0 mm (6.26 x 0.55 in)
Weight: 16 g (0.56 oz)
Side switch type: Rocker switch

Display Adaptors

VGA to DVI-I adaptor:



Part number 88741-9100, Molex
Video card connection: VGA (RGB analog, male)
Display connection: DVI-I, female
Note: Use of this adaptor requires setting the Cintiq DVI/VGA switch to the VGA position.

DVI-D to DVI-I adaptor:



Part number 88741-9400, Molex
Video card connection: DVI-D, male
Display connection: DVI-I, female
Notes: Use of this adaptor requires setting the Cintiq Digital/Analog (DVI/VGA) switch to the DVI position. Using a 3rd party ADC to DVI-D adaptor requires the use of this adaptor as a secondary adaptor for the Cintiq 18SX Interactive Pen Display.

Accessories

Extra pen tip: PSI-A007
Pen stand: PST-A026-03

LICENSE AND WARRANTY

Limited Warranty for Products Purchased and Used in U.S. and Canada

WACOM warrants the product, except for the Software, to be free from defects in materials and workmanship under normal use and service as long as the product remains in possession of the original owner, for a period of two (2) years, as evidenced by a copy of the receipt and a registration card that has been returned to WACOM within 30 days of purchase.

The Software is licensed “as is.” WACOM makes no warranty with respect to its quality or performance. WACOM cannot guarantee you uninterrupted service or the correction of any errors.

Upon discovery of a defect in the product, except in the Software, within the Warranty Period, you should notify WACOM Technical Support via telephone, email, or fax to obtain an RMA (Return Merchandise Authorization) number and instructions for shipping the product to a service location designated by WACOM. You should send the product, shipping charges prepaid, to the designated service location, accompanied by the return authorization number, your name, address and telephone number, proof of purchase date, and a description of the defect. WACOM will pay for return shipping by United Parcel Service or by an equivalent service as chosen by WACOM.

WACOM's sole obligation and entire liability under this warranty shall be, at WACOM's option, either the repair or replacement of the defective product or parts thereof of which WACOM is notified during the Warranty Period; provided, however, that you are responsible for (i) the cost of transportation of the product to the designated service location and (ii) any loss or damage to the product resulting from such transportation.

WACOM shall have no responsibility to repair or replace the product if the failure of the product has resulted from accident, abuse, misuse, negligence, or unauthorized modification or repair, or if it has been handled or stored other than in accordance with WACOM's storage instructions.

Any descriptions, drawings, specifications, samples, models, bulletins, or similar material, used in connection with the sale of the product, shall not be construed as an express warranty that the product will conform or comply with your requirements.

EXCEPT FOR THE LIMITED WARRANTY DESCRIBED ABOVE, THERE ARE NO OTHER WARRANTIES MADE BY WACOM ON THIS PRODUCT. NO ORAL OR WRITTEN INFORMATION OR ADVICE GIVEN BY WACOM, ITS DEALERS, DISTRIBUTORS, AGENTS, OR EMPLOYEES SHALL CREATE A WARRANTY OR IN ANY WAY INCREASE THE SCOPE OF THIS WARRANTY, AND YOU MAY NOT RELY ON ANY SUCH INFORMATION OR ADVICE. THIS WARRANTY GIVES YOU SPECIFIC LEGAL RIGHTS, WHICH VARY FROM STATE TO STATE.

WACOM LIMITS THE DURATION OF ANY LEGALLY IMPLIED WARRANTIES INCLUDING IMPLIED WARRANTIES OF MERCHANTABILITY OR FITNESS FOR A PARTICULAR PURPOSE, TO THE DURATION OF WACOM'S EXPRESS WARRANTY. SOME STATES DO NOT ALLOW LIMITATIONS ON HOW LONG AN IMPLIED WARRANTY LASTS. SO THE ABOVE LIMITATION MAY NOT APPLY TO YOU.

NEITHER WACOM NOR ANYONE ELSE WHO HAS BEEN INVOLVED IN THE CREATION, PRODUCTION, OR DELIVERY OF THIS PRODUCT SHALL BE LIABLE FOR ANY DIRECT, CONSEQUENTIAL, OR INCIDENTAL DAMAGES (INCLUDING DAMAGES FOR LOSS OF BUSINESS PROFITS, BUSINESS INTERRUPTION, LOSS OF BUSINESS INFORMATION AND THE LIKE) ARISING OUT OF THE USE OF OR INABILITY TO USE SUCH PRODUCT, EVEN IF WACOM HAS BEEN ADVISED OF THE POSSIBILITY OF SUCH DAMAGES. BECAUSE SOME STATES DO NOT ALLOW THE EXCLUSION OR LIMITATION OF LIABILITY FOR CONSEQUENTIAL DAMAGES, THE ABOVE LIMITATION MAY NOT APPLY TO YOU.

In the event that any of the above limitations are held unenforceable, WACOM's liability for any damages to you or any party shall not exceed the purchase price you paid, regardless of the form of any claim.

This Limited Warranty is governed by the laws of the United States of America and the state of Washington.

This Limited Warranty is valid for and only applies to products purchased and used inside the United States (and its territories or possessions) and Canada.

Warranty on Sales Outside of U.S. and Canada (Except Europe)

For products purchased or used outside of the United States and Canada, upon discovery of a defect in the product, except in the Software, within the Warranty Period you should notify your local dealer or distributor. In all other respects the terms of the warranty as set forth above apply to such sales.

Should you have any questions about this Agreement, or if you desire to contact WACOM for any reason, please contact in writing:

In North and South America contact:

WACOM TECHNOLOGY CORPORATION
1311 SE CARDINAL COURT,
VANCOUVER, WA 98683
U.S.A.

In Asia Pacific contact:

WACOM CO., LTD.
2-510-1 TOYONODAI
OTONE-MACHI, KITASAITAMA-GUN
SAITAMA, 349-1148
JAPAN

