

# TEST REPORT

Report number: Z071C-11031

Issue Date: May 24, 2011

The device, as described herewith, was tested pursuant to applicable test procedure indicated below and complies with the requirements of;

## FCC Part15 Subpart C / IC RSS-210

The test results are traceable to the international or national standards.

Applicant	:	Wacom Co., Ltd.
Equipment under test (EUT)	:	Wireless Receiver
Model Number	:	INF-A069
Serial Number	:	N/A
FCC ID	:	HV4INFA069
IC Certification Number	:	6888A-INFA069

Test procedure	:	ANSI C63.4-2003
Date of test	:	May 13, 18-20, 2011
Test place	:	ZACTA Technology Corporation Yonezawa Testing Center 4149-7 Hachimanpara 5-chome Yonezawa-shi Yamagata 992-1128 Japan Phone: +81-238-28-2880 Fax: +81-238-28-2888
Test results	:	Complied

Zacta Technology Corporation certifies that no party to the application is subject to a denial of federal benefits that include FCC benefits, pursuant to Section 5301 of the Anti-Drug Abuse Act of 1988, 21 U.S.C. 853(a).

The results in this report are applicable only to the samples tested.  
This report shall not be re-produced except in full without the written approval of ZACTA Technology Corporation.

This test report must not be used by client to claim product certification, approval, or endorsement by NVLAP, NIST, or any agency of the federal government.

Tested by: Taiki Watanabe  
Taiki Watanabe

Authorized by: Jun Shimanuki  
Jun Shimanuki  
General Manager of Technical Division



## ***Table of contents***

---

	Page
1. Summary of Test.....	4
1.1 Purpose of test.....	4
1.2 Standards.....	4
1.3 Summary of test results.....	4
1.4 Deviation from the standard.....	4
1.5 Modification to the EUT by laboratory.....	4
2. Equipment description.....	5
2.1 General Description of equipment.....	5
2.2 EUT information.....	5
2.3 Operating channels and frequencies.....	6
2.4 Description of Test modes.....	7
2.5 Operating mode.....	7
3. Configuration information.....	8
3.1 Peripheral(s) used.....	8
3.2 Cable(s) information.....	8
3.3 System configuration.....	9
4. Test Type and Results.....	10
4.1 20dB Bandwidth / Occupied Bandwidth.....	10
4.1.1 Test Procedure [ RSS-Gen 4.6.1 ].....	10
4.1.2 Measurement Setup.....	10
4.1.3 Limit of Bandwidth at 20 dB below.....	10
4.1.4 Measurement Result.....	10
4.1.5 Trace Data.....	10
4.2 Restricted Band of Operation.....	12
4.2.1 Test Procedure [ FCC 15.205, 15.209, 15.249(c),(d), IC RSS-210 A2.9(b) ].....	12
4.2.2 Measurement Setup.....	12
4.2.3 Limit of Restricted Band of Operation.....	12
4.2.4 Measurement Result.....	12
4.2.5 Trace Data.....	13
4.3 Spurious Emissions - Radiated - (9kHz - 25GHz).....	18
4.3.1 Test Procedure [ FCC 15.205/209/249(a), (b), (c), (d), (e), 15.35(b), IC RSS-210 A2.9(a), (b), RSS-Gen 4.9, 4.10 ].....	18
4.3.2 Measurement Setup.....	18
4.3.3 Limit of Spurious Emission Measurement.....	19
4.3.4 Measurement Results.....	19
4.3.5 Duty Cycle.....	24
4.4 AC power line Conducted Emissions.....	25

4.4.1 Test Procedure [ FCC 15.207, IC RSS-Gen 7.2.2 ] .....25  
4.4.2 Measurement Setup .....25  
4.4.3 Limit of AC power line Conducted Emissions Measurement .....26  
4.4.4 Calculation method .....26  
4.4.5 Measurement Result .....27  
4.5 Antenna requirement ..... 29  
5. Uncertainty of measurement ..... 30  
6. Laboratory description..... 31  
    1. Location: ..... 31  
Appendix A: Test equipment..... 32

## ***1. Summary of Test***

---

### ***1.1 Purpose of test***

It is the original test in order to verify conformance to standards listed in section 1.2.

### ***1.2 Standards***

CFR47 FCC Part 15 Subpart C, RSS-210

### ***1.3 Summary of test results***

Table-A presents the list of the measurement items for intentional radiators operated 2.4GHz band devices under FCC Part 15 Subpart C and Industry Canada RSS-210 Issue 8.

Table-A: List of the measurements

<b>Test Items Section</b>	<b>Test Items</b>	<b>Condition</b>	<b>Result</b>
RSS-Gen 4.6.1	Occupied Bandwidth (20dB Bandwidth)	Conducted	<b>Pass</b>
15.249(c), (d) RSS-210 A2.9(b)	Restricted Bands of Operation	Radiated	<b>Pass</b>
15.249(a), (b), (c), (d), (e) RSS-210 A2.9(a), (b) RSS-Gen 4.9, 4.10	Spurious Emissions (Field Strength of Fundamental and Harmonics)	Radiated	<b>Pass</b>
15.207 RSS-Gen 7.2.4	AC Power Line Conducted Emissions 150kHz – 30MHz	Conducted	<b>Pass</b>

### ***1.4 Deviation from the standard***

None

### ***1.5 Modification to the EUT by laboratory***

None

## ***2. Equipment description***

---

### ***2.1 General Description of equipment***

This device is a wireless receiver which operates in 2.4GHz band.

### ***2.2 EUT information***

Applicant : Wacom Co., Ltd.  
2-510-1, Toyonodai, Kazo-shi, Saitama 349-1148, Japan  
Phone: +81-480-78-1211 Fax: +81-480-78-1404

Equipment under test (EUT) : Wireless Receiver

Trade name : Wacom

Model number : INF-A069

Serial number : N/A

EUT condition : Pre-production

Max. frequency : 16MHz

Power ratings : DC 5.0V

Size : (W) 15 x (L) 20 x (H) 6 mm

Environment : Indoor and Outdoor use

Thermal limitation : 0°C to 60°C

Operating mode : Tx mode, Rx mode

Variation of model(s) : N/A

#### [RF Specification]

Frequency Range : 2404MHz - 2480MHz

Number of FR Channels : 39 Channels

Modulation Method/Data rate : GFSK (2Mbps)

Channel Separation : 2MHz

Antenna (Rx and Tx) : PCB antenna

Antenna gain : -0.55dBi

RF type : Transceiver

Intended use : Data transmission

RF emission type designator : 2M80F1D

### 2.3 Operating channels and frequencies

Channel	Frequency [MHz]	Channel	Frequency [MHz]
0	2404	21	2446
1	2406	22	2448
2	2408	23	2450
3	2410	24	2452
4	2412	25	2454
5	2414	26	2456
6	2416	27	2458
7	2418	28	2460
8	2420	29	2462
9	2422	30	2464
10	2424	31	2466
11	2426	32	2468
12	2428	33	2470
13	2430	34	2472
14	2432	35	2474
15	2434	36	2476
16	2436	37	2478
17	2438	38	2480
18	2440		
19	2442		
20	2444		

## 2.4 Description of Test modes

The EUT had been tested under operating condition.

There are three channels have been tested as following:

Tested Channel	Frequency (MHz)
Low	2404
Middle	2442
High	2480

The pre-test has been conducted to determine the worst-case mode from all possible combinations between available modulations, data rates.

Following channel(s) was (were) selected for the final test as listed below.

Tested Channel	Modulation Type	Data Rate
Low, Middle, High	GFSK	2Mbps

The field strength of spurious emission was measured at each position of all three axis X, Y and Z to compare the level, and the maximum noise.

The worst emission was found in X axis and the worst case recorded.

## 2.5 Operating mode

Software : IWMon\_RFtest v00

### 【Tx mode】

- i) RF test program set up
- ii) Select a test mode

Operating frequency: Channel Low: 2404MHz, Channel Middle: 2442MHz, Channel High: 2480MHz

- iii) Start test mode

### 【Rx mode】

- i) RF test program set up
- ii) Select a Test mode

Operating frequency: Channel Low: 2404MHz, Channel Middle: 2442MHz, Channel High: 2480MHz

- iii) Start test mode

### 3. Configuration information

#### 3.1 Peripheral(s) used

No.	Equipment	Company	Model No.	Serial No.	FCC ID/DoC	Comment
1	Wireless Receiver	Wacom	INF-A069	N/A	FCC ID:HV4INFA069 IC:6888A-INFA069	EUT
2	Personal Computer	HP	Compaq nx6320	CNU7071D2W	DoC	-
3	AC adapter for PC	HP	PA-1650-02HC	7118525901	-	-
4	Printer	Canon	BJF780	N/A	DoC	*
5	Modem	US.Robotics	Sport_Ster 33.6kbps	000839032BK6 YV4J	DoC	*
6	AC adapter for Modem	US.Robotics	N/A	N/A	-	*

\*: Conducted emission only.

#### 3.2 Cable(s) information

No.	Cable	Length [m]	Shield	Connector	Comment
a	DC cable for PC AC adapter	1.8	No	Plastic	-
b	AC Power cord for PC AC adapter	1.8	No	Plastic	-
c	Parallel cable	1.6	Yes	Metal	*
d	AC Power cord for Printer	2.0	No	Plastic	*
e	Serial cable	1.5	Yes	Metal	*
f	DC cable for Modem AC adapter	2.1	Yes	Metal	*

\*: Conducted emission only.



### 3.3 System configuration

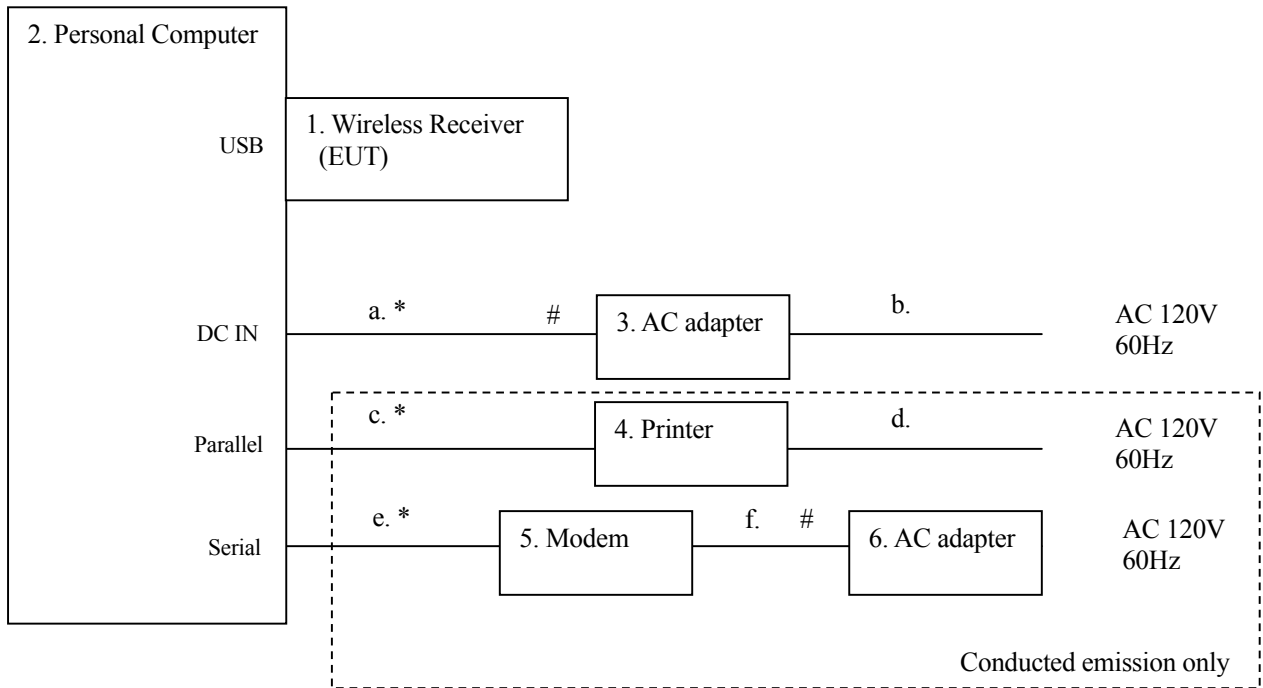

\*: Bundled excess cable  
#: Un-detachable cable

Note 1: Numbers assigned to equipment or cables on this diagram are corresponded to the list in “3.1 EUT and Peripheral(s) used”, “3.2 Cable(s) information”.

## 4. Test Type and Results

### 4.1 20dB Bandwidth / Occupied Bandwidth

#### 4.1.1 Test Procedure [ RSS-Gen 4.6.1 ]

The bandwidth at 20 dB down from the highest inband spectral density is measured with a spectrum analyzer connected to the antenna terminal, while EUT is operating in transmission mode at the appropriate center frequency. The RBW is set to 1% to 3% of the 99% bandwidth. The VBW is set to 3 times the RBW.

The spectrum analyzer is set to:

- RBW=100kHz, VBW=300kHz, Span=10MHz, Sweep=auto

The EUT was set to operate with following conditions.

- Channel Low: 2404MHz, Channel Middle: 2442MHz, Channel High: 2480MHz

The test mode of EUT is as follows.

- Tx mode

#### 4.1.2 Measurement Setup

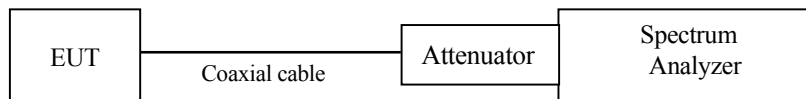

#### 4.1.3 Limit of Bandwidth at 20 dB below

None

#### 4.1.4 Measurement Result

Channel	Center Frequency [MHz]	20dB Bandwidth [MHz]	Occupied Bandwidth [MHz]
Low	2404.0	2.027	1.836
Middle	2442.0	2.144	1.972
High	2480.0	2.931	2.796

#### 4.1.5 Trace Data

##### Test Personnel:

Tested by: Taiki Watanabe

Date : May 19, 2011  
 Temperature : 20.0 [°C]  
 Humidity : 47.0 [%]  
 Test place : Shielded room

**20dB Bandwidth/Occupied Bandwidth**

**Channel Low: 2404.0MHz**

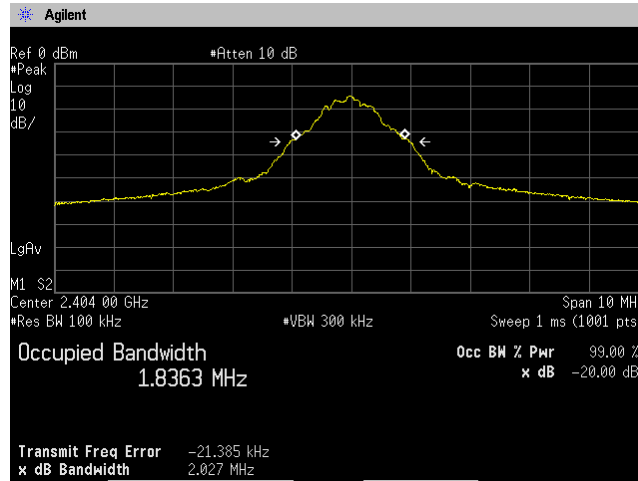

**Channel Middle: 2442.0MHz**

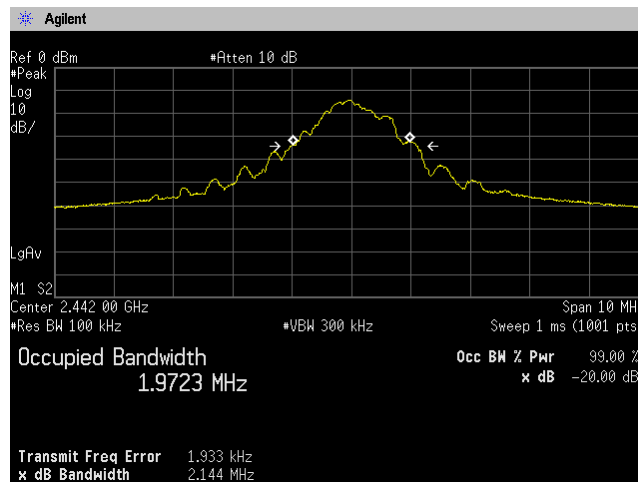

**Channel High: 2480.0MHz**

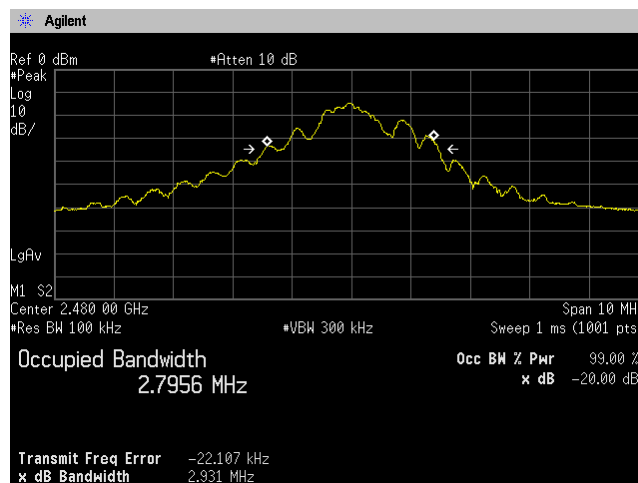

## 4.2 Restricted Band of Operation

### 4.2.1 Test Procedure [ FCC 15.205, 15.209, 15.249(c),(d), IC RSS-210 A2.9(b) ]

The peak power is measured with a spectrum analyzer connected to the antenna terminal, while EUT is operating in transmission mode at the appropriate center frequency.

The spectrum analyzer is set to:

- Peak: RBW=1MHz, VBW=1MHz, Span=5MHz, Sweep=auto
- Marker Delta: RBW=300kHz, VBW=300kHz, Span=40MHz, Sweep=auto
- Average: RBW=1MHz, VBW=10Hz, Span=40MHz, Sweep=auto

The EUT was set to operate with following conditions.

- Channel Low: 2404MHz, Channel High: 2480MHz

The test mode of EUT is as follows.

- Tx mode

### 4.2.2 Measurement Setup

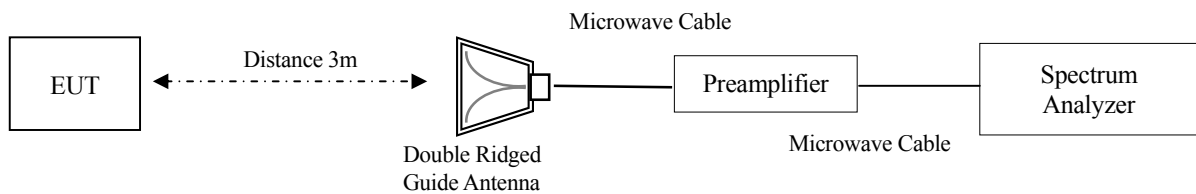

### 4.2.3 Limit of Restricted Band of Operation

Emission at the boundary of the restricted band provided by 15.205 shall be lower than 15.209 limit.

### 4.2.4 Measurement Result

#### Peak Field Strength

(P)	Frequency [MHz]	Reading [dBuV/m]	c.f [dB(1/m)]	Marker Delta [dB]	Result [dBuV/m]	Limit [dBuV/m]	Margin [dB]
H	2390.0	104.2	-3.2	46.5	54.5	74.0	19.5
V	2390.0	104.0	-3.2	47.3	53.5	74.0	20.5
H	2483.5	103.6	-3.1	34.5	66.0	74.0	8.0
V	2483.5	101.4	-3.1	34.3	64.0	74.0	10.0

**Average Field Strength**

(P)	Frequency [MHz]	Reading [dBuV/m]	c.f [dB(1/m)]	Result [dBuV/m]	Limit [dBuV/m]	Margin [dB]
H	2390.0	41.0	-3.2	37.8	54.0	16.2
V	2390.0	40.3	-3.2	37.1	54.0	16.9
H	2483.5	41.4	-3.1	38.3	54.0	15.7
V	2483.5	40.2	-3.1	37.1	54.0	16.9

Note:

1. Peak Field Strength: Emission Level (Margin) = Limit - [Reading + Factor (Antenna + Cable - Amp) – Marker Delta ]
2. Average Field Strength: Emission Level (Margin) = Limit - [Reading + Factor (Antenna + Cable - Amp) ]

**4.2.5 Trace Data**

**Test Personnel:**

Tested by:                     Taiki Watanabe                    

Date : May 13, 2011  
Temperature : 19.3 [°C]  
Humidity : 58.6 [%]  
Test place : 3m Semi-anechoic chamber

**Restricted Band of Operation**

**Channel Low: 2404.0MHz -Horizontal-  
Peak**

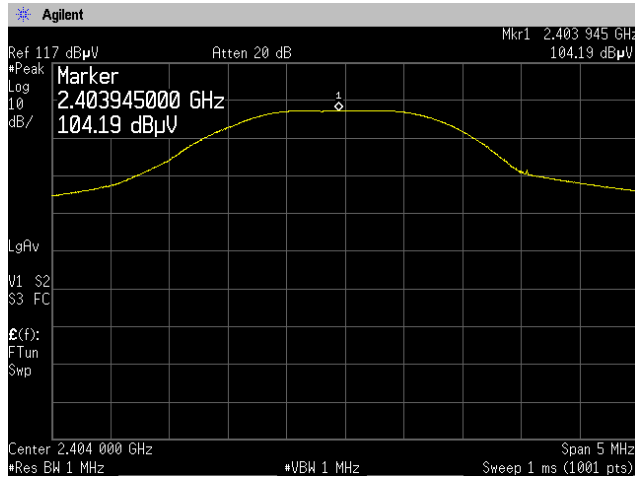

**Marker Delta**

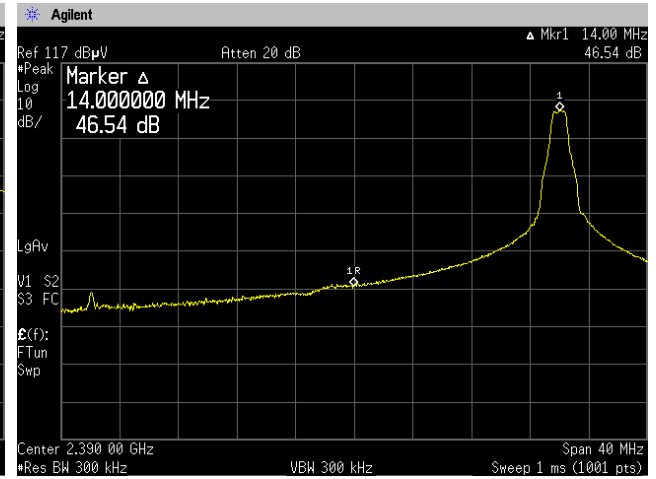

**Average**

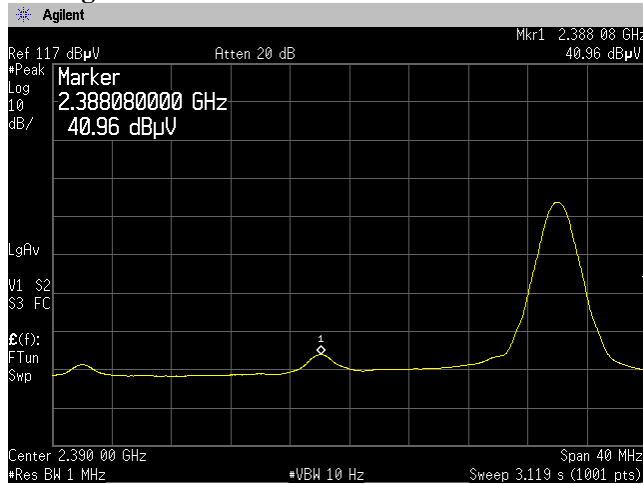

**Channel Low: 2404.0MHz -Vertical-  
Peak**

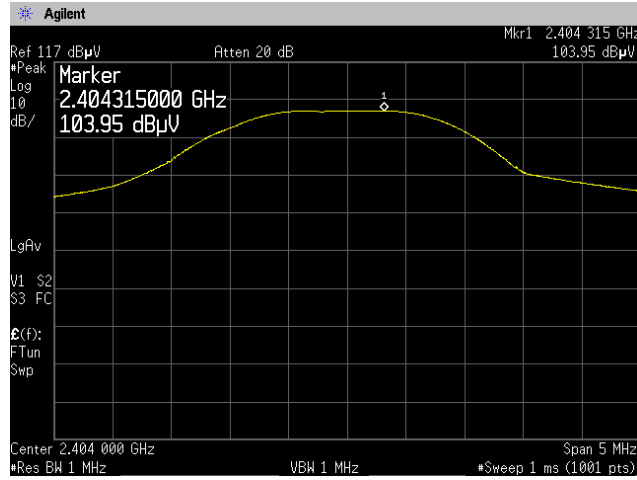

**Marker Delta**

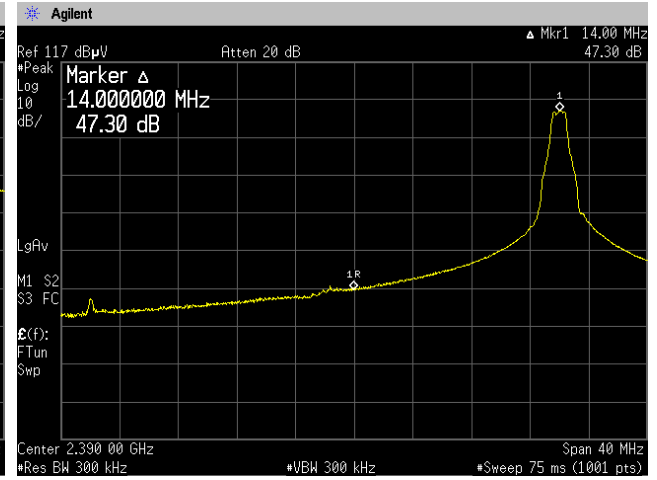

**Average**

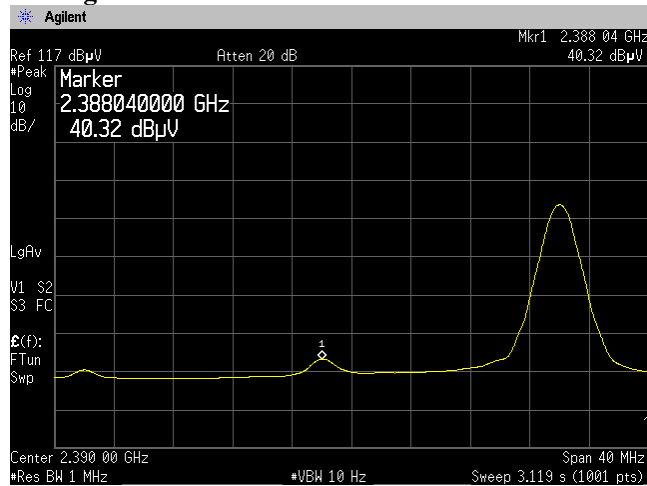

**Restricted Band of Operation**

**Channel High: 2480.0MHz -Horizontal-  
Peak**

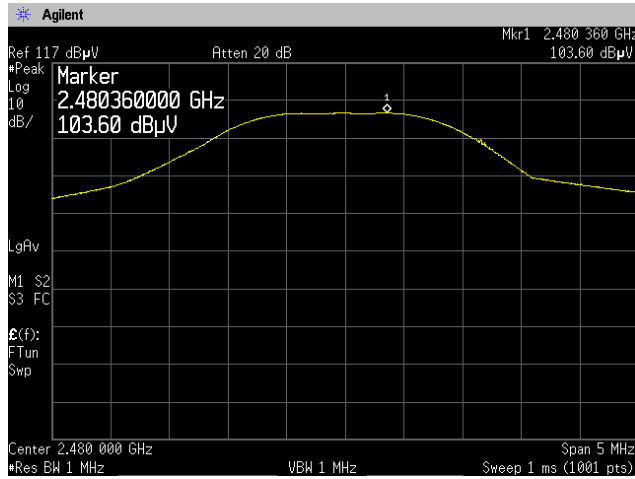

**Marker Delta**

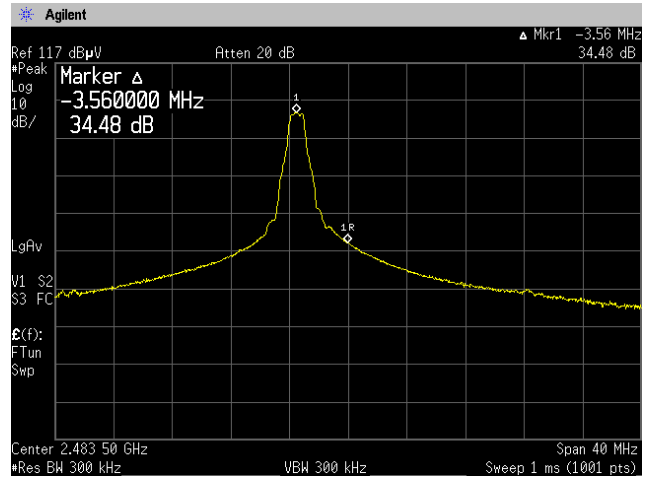

**Average**

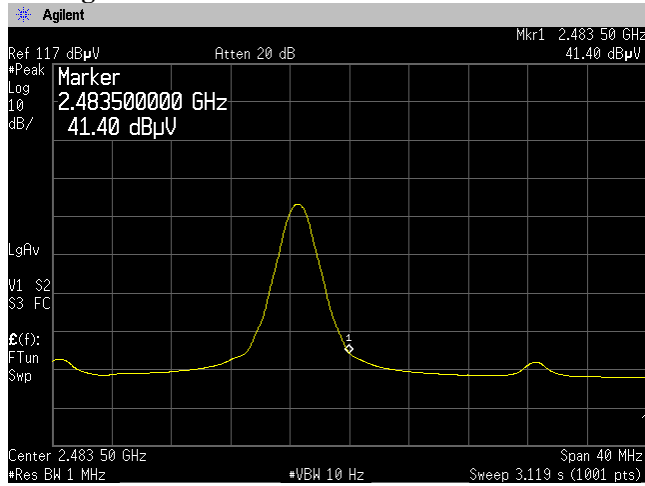



**Channel High: 2480.0MHz -Vertical-  
Peak**

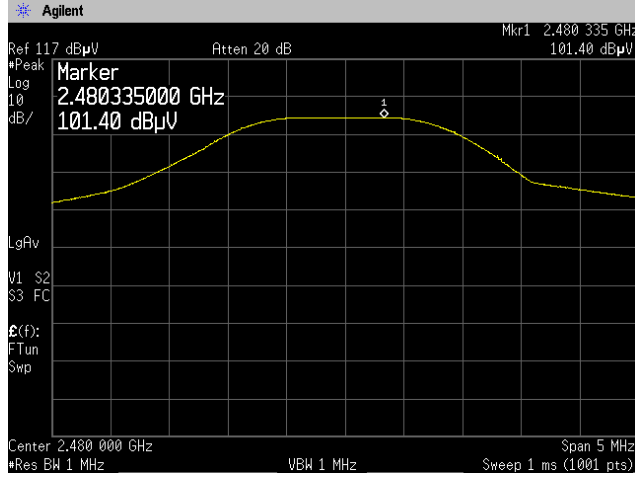

**Marker Delta**

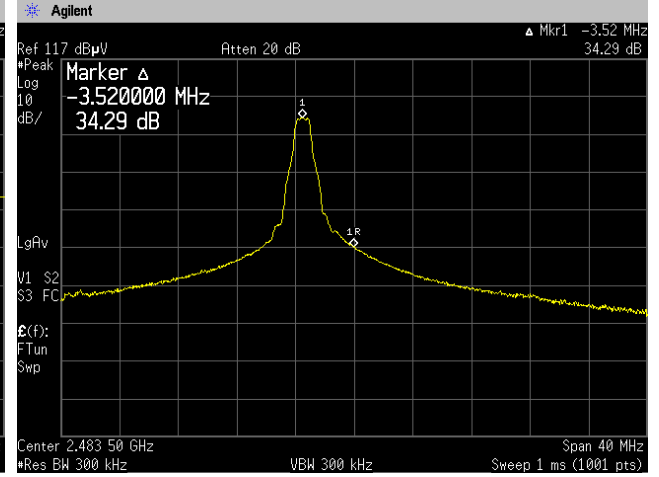

**Average**

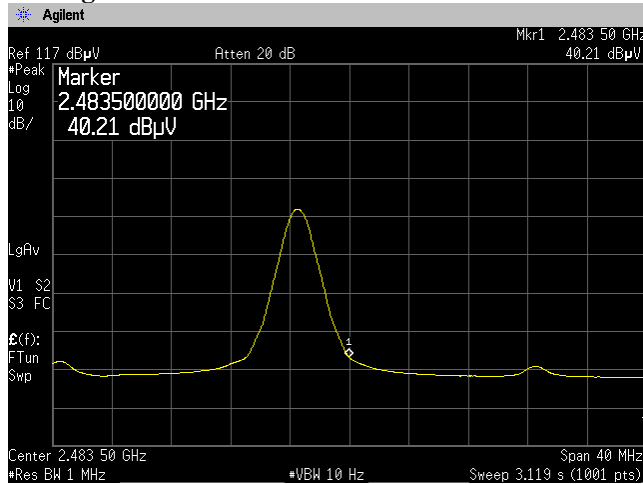

### 4.3 Spurious Emissions - Radiated - (9kHz - 25GHz)

#### 4.3.1 Test Procedure [ FCC 15.205/209/249(a), (b), (c), (d), (e), 15.35(b), IC RSS-210 A2.9(a), (b), RSS-Gen 4.9, 4.10 ]

Radiated emission measurements are performed at 3m distance with the broadband antenna (Loop antenna, TRILOG antenna, and double-ridged guide antenna). The antenna is positioned both the horizontal and vertical planes of polarization and height is varied 1 to 4 meters and stopped at height producing the maximum emission. As for the Loop antenna, it is positioned with its plane vertical, and the center of the Loop is 1.0meter above the ground plane. Frequency Range: 9kHz –1GHz is scanned and investigated with the test receiver, and above 1GHz, with the spectrum analyzer. The detector function of the test receiver is set to CISPR Quasi-peak mode and the bandwidth is set to 120kHz. Peak and average detectors are used for measurements above 1GHz. The bandwidth of the spectrum analyzer is set to 1MHz.

The EUT and support equipment are placed on a 1meter x 2meter surface, 0.8meter height FRP table. The turntable is rotated by 360 degrees and stopped at azimuth of producing the maximum emission.

Interconnecting cables, which hanging closer than 40cm to the horizontal metal ground plane are bundled its excess in center. The highest fundamental frequency generated in the EUT is 2404-2480MHz, therefore the frequency was investigated up to 25GHz, as specified in CFR section 15.33, and at least six highest emissions are reported. The test results represent the worst-case emission for each emission with manipulating the EUT, support equipment, interconnecting cables and varying the mode of operation.

Sufficient time for the EUT, support equipment, and test equipment are allowed in order for them to warm up to their normal operating condition.

The spectrum analyzer is set to:

- Peak: RBW=1MHz, VBW=1MHz, Span=0Hz, Sweep=auto
- Average: RBW=1MHz, VBW=10Hz, Span=0Hz, Sweep=auto

The EUT was set to operate with following conditions.

- Channel Low: 2404MHz, Channel Middle: 2442MHz, Channel High: 2480MHz

The test mode of EUT is as follows.

- Tx mode, Rx mode

#### 4.3.2 Measurement Setup

##### Test configuration for Spurious Emissions

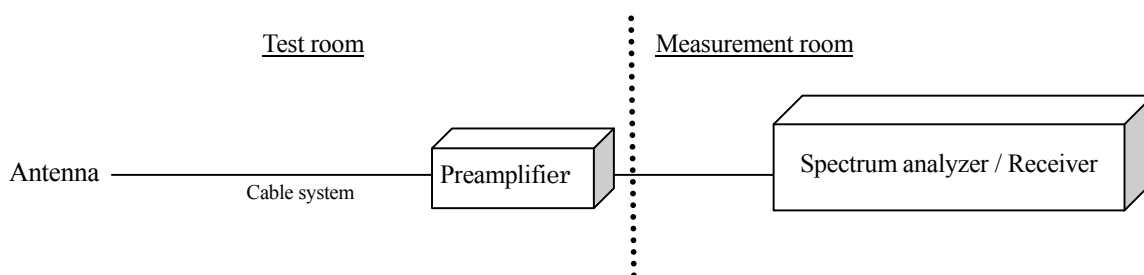

### 4.3.3 Limit of Spurious Emission Measurement

#### Field Strength of Fundamental and Harmonics

Fundamental Frequency [MHz]	Field Strength of Fundamental		Field Strength of Harmonics	
	[mV/m]	[dBuV/m]	[uV/m]	[dBuV/m]
902 – 928	50	94.0	500	54.0
2400 – 2483.5	50	94.0	500	54.0
5725 – 5875	50	94.0	500	54.0
24000 - 24250	250	108.0	2500	68.0

#### Spurious Emissions

Frequency [MHz]	Field Strength	
	[uV/m]	[dBuV/m]
0.009 – 0.490	2400 / F [kHz]	20logE [uV/m]
0.490 – 1.705	24000 / F [kHz]	20logE [uV/m]
1.705-30	30	29.5
30 – 88	100	40.0
88 – 216	150	43.5
216 – 960	200	46.0
Above 960	500	54.0

NOTE:

1. The lower limit shall apply at the transition frequencies.
2. Emission level [dBuV/m] = 20 log Emission [uV/m]
3. As shown in 15.35(b), for frequencies above 1000MHz, the field strength limits are based on average detector, however, the peak field strength of any emission shall not exceed the maximum permitted average limits, specified above by more than 20dB under any condition of modulation.

### 4.3.4 Measurement Results

**Test Personnel:**

Tested by: Taiki Watanabe

Date : May 13, 2011  
 Temperature : 19.3 [°C]  
 Humidity : 58.6 [%]  
 Test place : 3m Semi-anechoic chamber

**Test Personnel:**

Tested by: Taiki Watanabe

Date : May. 18, 2011  
 Temperature : 17.0 [°C]  
 Humidity : 42.0 [%]  
 Test place : 3m Semi-anechoic chamber

**Spurious Emissions - Radiated -  
Below 1GHz**

**Tx Channel Low: 2404.0MHz**

No.	Frequency [MHz]	(P)	Reading QP [dB( $\mu$ V)]	c. f [dB(1/m)]	Result QP [dB( $\mu$ V/m)]	Limit [dB( $\mu$ V/m)]	Margin QP [dB]	Height [cm]	Angle [ $^{\circ}$ ]
1	30.651	V	36.6	-11.0	25.6	40.0	14.4	100.0	196.0
2	96.142	H	42.7	-13.6	29.1	43.5	14.4	179.0	279.0
3	161.420	H	29.8	-8.3	21.5	43.5	22.0	233.0	283.0
4	329.335	H	38.1	-6.8	31.3	46.0	14.7	100.0	245.0
5	400.014	H	35.9	-5.1	30.8	46.0	15.2	100.0	25.0
6	796.185	V	33.1	2.3	35.4	46.0	10.6	100.0	60.0

**Tx Channel Middle: 2442.0MHz**

No.	Frequency [MHz]	(P)	Reading QP [dB( $\mu$ V)]	c. f [dB(1/m)]	Result QP [dB( $\mu$ V/m)]	Limit [dB( $\mu$ V/m)]	Margin QP [dB]	Height [cm]	Angle [ $^{\circ}$ ]
1	30.447	V	36.4	-10.9	25.5	40.0	14.5	100.0	208.0
2	96.140	H	42.2	-13.6	28.6	43.5	14.9	188.0	269.0
3	160.817	H	29.6	-8.3	21.3	43.5	22.2	233.0	277.0
4	329.330	H	38.6	-6.8	31.8	46.0	14.2	100.0	225.0
5	400.013	H	34.8	-5.1	29.7	46.0	16.3	100.0	65.0
6	796.212	V	33.7	2.3	36.0	46.0	10.0	100.0	54.0

**Tx Channel High: 2480.0MHz**

No.	Frequency [MHz]	(P)	Reading QP [dB( $\mu$ V)]	c. f [dB(1/m)]	Result QP [dB( $\mu$ V/m)]	Limit [dB( $\mu$ V/m)]	Margin QP [dB]	Height [cm]	Angle [ $^{\circ}$ ]
1	30.480	V	36.8	-10.9	25.9	40.0	14.1	100.0	224.0
2	96.132	H	42.7	-13.7	29.0	43.5	14.5	188.0	270.0
3	156.435	H	29.4	-8.5	20.9	43.5	22.6	225.0	280.0
4	329.341	H	38.7	-6.8	31.9	46.0	14.1	100.0	238.0
5	400.012	H	35.7	-5.1	30.6	46.0	15.4	100.0	39.0
6	799.800	V	33.6	2.3	35.9	46.0	10.1	100.0	49.0

**Rx Channel Low: 2404MHz**

No.	Frequency [MHz]	(P)	Reading QP [dB( $\mu$ V)]	c. f [dB(1/m)]	Result QP [dB( $\mu$ V/m)]	Limit [dB( $\mu$ V/m)]	Margin QP [dB]	Height [cm]	Angle [ $^{\circ}$ ]
1	30.692	V	36.8	-11.0	25.8	40.0	14.2	100.0	211.0
2	96.136	H	42.0	-13.6	28.4	43.5	15.1	191.0	271.0
3	156.578	H	30.4	-8.5	21.9	43.5	21.6	214.0	280.0
4	336.473	H	38.6	-6.7	31.9	46.0	14.1	100.0	252.0
5	472.508	H	33.7	-3.4	30.3	46.0	15.7	197.0	176.0
6	796.180	H	32.5	2.3	34.8	46.0	11.2	100.0	175.0

**Rx Channel Low: 2442MHz**

No.	Frequency [MHz]	(P)	Reading QP [dB( $\mu$ V)]	c. f [dB(1/m)]	Result QP [dB( $\mu$ V/m)]	Limit [dB( $\mu$ V/m)]	Margin QP [dB]	Height [cm]	Angle [ $^{\circ}$ ]
1	30.282	V	35.9	-10.9	25.0	40.0	15.0	100.0	239.0
2	96.142	H	42.4	-13.6	28.8	43.5	14.7	189.0	261.0
3	151.462	H	29.4	-8.8	20.6	43.5	22.9	208.0	279.0
4	336.492	H	38.2	-6.7	31.5	46.0	14.5	100.0	264.0
5	472.506	H	35.2	-3.4	31.8	46.0	14.2	174.0	291.0
6	799.808	H	33.0	2.3	35.3	46.0	10.7	113.0	173.0

**Rx Channel Low: 2480MHz**

No.	Frequency [MHz]	(P)	Reading QP [dB( $\mu$ V)]	c. f [dB(1/m)]	Result QP [dB( $\mu$ V/m)]	Limit [dB( $\mu$ V/m)]	Margin QP [dB]	Height [cm]	Angle [ $^{\circ}$ ]
1	30.662	V	36.7	-11.0	25.7	40.0	14.3	100.0	214.0
2	96.140	H	42.0	-13.6	28.4	43.5	15.1	198.0	278.0
3	151.398	H	30.6	-8.8	21.8	43.5	21.7	184.0	283.0
4	336.483	H	39.8	-6.7	33.1	46.0	12.9	100.0	241.0
5	472.511	H	34.7	-3.4	31.3	46.0	14.7	186.0	284.0
6	799.807	H	32.3	2.3	34.6	46.0	11.4	100.0	172.0

Note:

1. Emission Level (Margin) = Limit – [Reading + Factor (Antenna + Cable - Amp)]
2. No emissions were detected in frequency range 9KHz to 30MHz at the 3 meters distance.

**Above 1GHz**

**Tx Channel Low: 2404.0MHz**

**Peak Field Strength**

(P)	Frequency [MHz]	Reading [dBuV/m]	c.f [dB(1/m)]	Result [dBuV/m]	Limit [dBuV/m]	Margin [dB]
H	2404.31	101.0	-3.2	97.8	114.0	16.2
V	2404.32	103.9	-3.2	100.7	114.0	13.3
H	4807.89	50.7	4.7	55.4	74.0	18.6
V	4807.16	49.2	4.7	53.9	74.0	20.1

**Average Field Strength**

(P)	Frequency [MHz]	Peak Result [dBuV/m]	Duty cycle factor [dB(1/m)]	Result [dBuV/m]	Limit [dBuV/m]	Margin [dB]
H	2404.31	97.8	20.0	77.8	94.0	16.2
V	2404.32	100.7	20.0	80.7	94.0	13.3
H	4807.89	55.4	20.0	35.4	54.0	18.6
V	4807.16	53.9	20.0	33.9	54.0	20.1

**Tx Channel Middle: 2442.0MHz**

**Peak Field Strength**

(P)	Frequency [MHz]	Reading [dBuV/m]	c.f [dB(1/m)]	Result [dBuV/m]	Limit [dBuV/m]	Margin [dB]
H	2442.32	100.9	-3.2	97.7	114.0	16.3
V	2442.34	103.0	-3.2	99.8	114.0	14.2
H	4884.67	50.6	5.0	55.6	74.0	18.4
V	4884.77	49.3	5.0	54.3	74.0	19.7

**Average Field Strength**

(P)	Frequency [MHz]	Peak Result [dBuV/m]	Duty cycle factor [dB(1/m)]	Result [dBuV/m]	Limit [dBuV/m]	Margin [dB]
H	2442.32	97.7	20.0	77.7	94.0	16.3
V	2442.34	99.8	20.0	79.8	94.0	14.2
H	4884.67	55.6	20.0	35.6	54.0	18.4
V	4884.77	54.3	20.0	34.3	54.0	19.7

**Tx Channel High: 2480.0MHz**

**Peak Field Strength**

(P)	Frequency [MHz]	Reading [dBuV/m]	c.f [dB(1/m)]	Result [dBuV/m]	Limit [dBuV/m]	Margin [dB]
H	2480.33	103.1	-3.1	100.0	114.0	14.0
V	2480.36	101.6	-3.1	98.5	114.0	15.5
H	4960.60	51.1	5.1	56.2	74.0	17.8
V	4960.63	49.7	5.1	54.8	74.0	19.2

**Average Field Strength**

(P)	Frequency [MHz]	Peak Result [dBuV/m]	Duty cycle factor [dB(1/m)]	Result [dBuV/m]	Limit [dBuV/m]	Margin [dB]
H	2480.33	100.0	20.0	80.0	94.0	14.0
V	2480.36	98.5	20.0	78.5	94.0	15.5
H	4960.60	56.2	20.0	36.2	54.0	17.8
V	4960.63	54.8	20.0	34.8	54.0	19.2

Note:

1. Peak Field Strength: Emission Level (Margin) = Limit - [Reading + Factor (Antenna + Cable - Amp)]
2. Average Field Strength: Emission Level (Margin) = Limit - [Peak Result - Duty Cycle Factor ]
3. No emissions were detected in Rx mode at the 3 meters distance.

### 4.3.5 Duty Cycle

#### Duty Cycle Factor Calculation

RF duty cycle factor: Calculation according to RF burst Para 15.35 (c)

Pulse width is 209.56us

There are 43 pulses in 100mSec window

$209.56\mu\text{s} \times 43 = 9.01\text{ms}$

It is 9.01ms in 100ms

Duty cycle:  $9/100 = 0.09$

Duty cycle factor:  $20\log(0.09) = -20.9\text{dB}$

Maximum duty cycle according to Para 15.35 (b): 20dB

This value is used when measuring average field strength above 1GHz with Peak Detector function employed on spectrum analyzer.

#### Pulse width

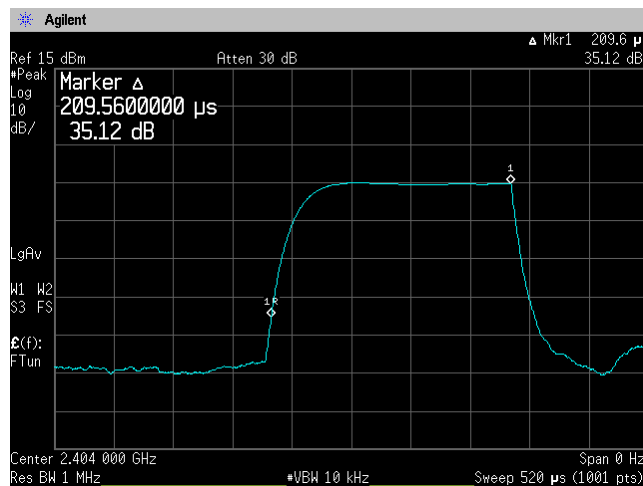

#### 100ms window

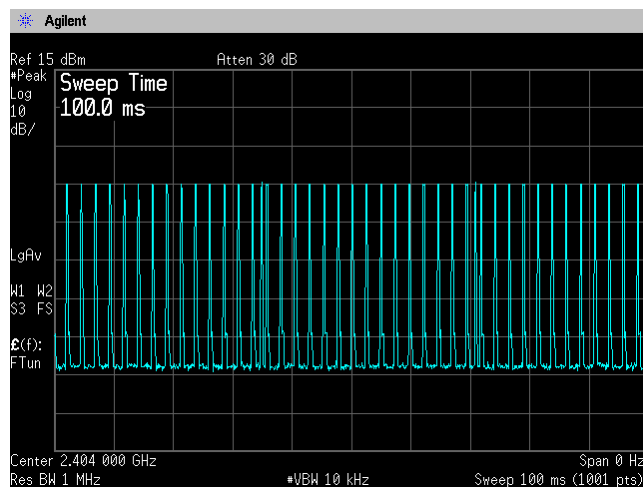



#### 4.4 AC power line Conducted Emissions

##### 4.4.1 Test Procedure [ FCC 15.207, IC RSS-Gen 7.2.4 ]

Conducted emissions at AC mains port measurements are performed at open area test site according to ANSI C63.4 section 7.

EUT and support equipment are placed on FRP table of 2.0m(W) × 1.0m(D) × 0.8m(H) in size. EUT is connected to 50Ω/50μH Line Impedance Stabilization Network (LISN) which is placed on reference ground plane, and was placed 80cm away from EUT. Excess of AC power cable is bundled in center. Vertical Metal Reference Plane 2.0m (W) × 2.0m (H) in size is placed 0.4m away from EUT. LISN for peripheral is terminated in 50Ω.

EUT operating mode is selected to emit the maximum noise. Overall frequency range is investigated with spectrum analyzer using peak detector. Maximum emission configuration is determined by manipulating the EUT, support equipment, interconnecting cables. Then, emission measurements are performed with test receiver in above setting to each current-carrying conductor of the mains port. Sufficient time for EUT, support equipment and test equipment are provided in order for them to warm up to their normal operating condition.

Frequency range:

- 0.15MHz to 30MHz

The Test receiver is set to:

- Detector: Quasi-peak, Average
- Bandwidth: 9kHz

The test mode of EUT is as follows.

- Tx mode, Rx mode

##### 4.4.2 Measurement Setup

###### Test configuration for AC power line Conducted Emissions

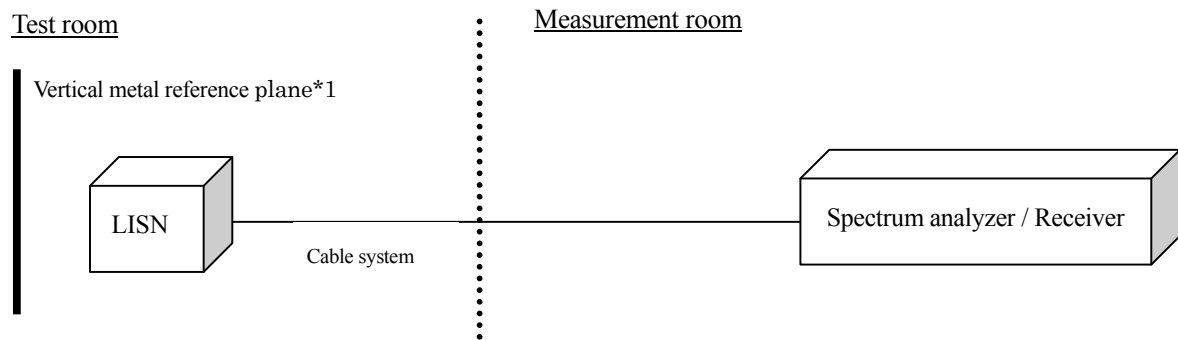

\*1: Used it for Table-top only

#### ***4.4.3 Limit of AC power line Conducted Emissions Measurement***

Frequency	Limit	
	QP(dB $\mu$ V)	AV(dB $\mu$ V)
0.15MHz to 0.5MHz	66 to 56*	56 to 46*
0.5MHz to 5MHz	56	46
5MHz to 30MHz	60	50

\*: The limit decreases linearly with the logarithm of the frequency in the range 0.15MHz to 0.5MHz.

#### ***4.4.4 Calculation method***

Emission level = Reading + (LISN. Factor + Cable system loss)

Margin = Limit – Emission level

### 4.4.5 Measurement Result

\*\*\*\*\* CONDUCTED EMISSION at MAINS PORT \*\*\*\*\*  
<< 3m Semi-anechoic chamber >>

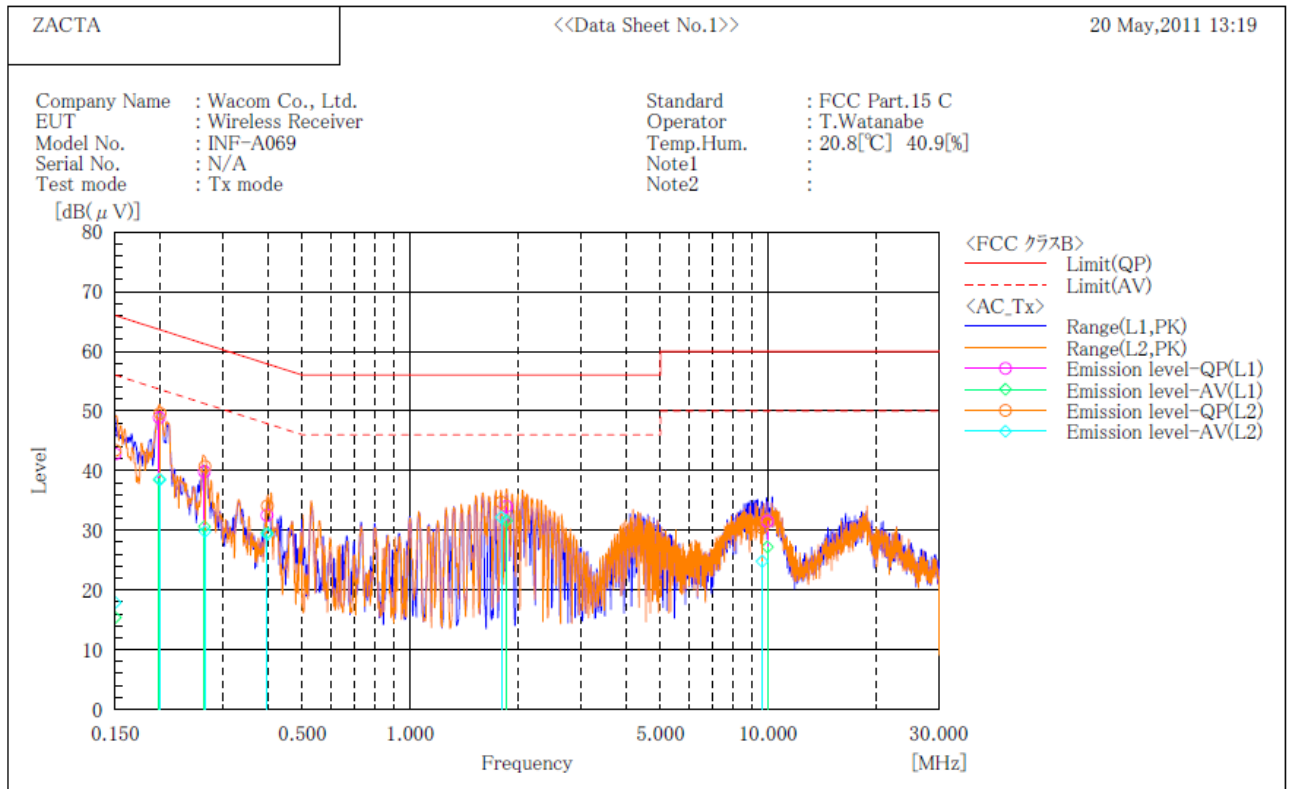

#### Final Result

--- L1 Phase ---

No.	Frequency [MHz]	Reading QP [dB(μV)]	Reading AV [dB(μV)]	c. f [dB]	Result QP [dB(μV)]	Result AV [dB(μV)]	Limit QP [dB(μV)]	Limit AV [dB(μV)]	Margin QP [dB]	Margin AV [dB]
1	0.150	32.6	5.2	10.2	42.8	15.4	66.0	56.0	23.2	40.6
2	0.199	38.8	28.4	10.1	48.9	38.5	63.7	53.7	14.8	15.2
3	0.266	29.8	20.6	10.0	39.8	30.6	61.2	51.2	21.4	20.6
4	0.398	22.5	19.6	10.0	32.5	29.6	57.9	47.9	25.4	18.3
5	1.858	23.9	21.5	10.1	34.0	31.6	56.0	46.0	22.0	14.4
6	9.949	21.1	16.8	10.4	31.5	27.2	60.0	50.0	28.5	22.8

--- L2 Phase ---

No.	Frequency [MHz]	Reading QP [dB(μV)]	Reading AV [dB(μV)]	c. f [dB]	Result QP [dB(μV)]	Result AV [dB(μV)]	Limit QP [dB(μV)]	Limit AV [dB(μV)]	Margin QP [dB]	Margin AV [dB]
1	0.150	33.2	7.7	10.2	43.4	17.9	66.0	56.0	22.6	38.1
2	0.200	39.5	28.4	10.1	49.6	38.5	63.6	53.6	14.0	15.1
3	0.267	30.7	19.8	10.0	40.7	29.8	61.2	51.2	20.5	21.4
4	0.399	24.1	19.3	10.0	34.1	29.3	57.9	47.9	23.8	18.6
5	1.796	24.6	22.1	10.1	34.7	32.2	56.0	46.0	21.3	13.8
6	9.620	20.0	14.4	10.4	30.4	24.8	60.0	50.0	29.6	25.2

\*\*\*\*\* CONDUCTED EMISSION at MAINS PORT \*\*\*\*\*  
 << 3m Semi-anechoic chamber >>

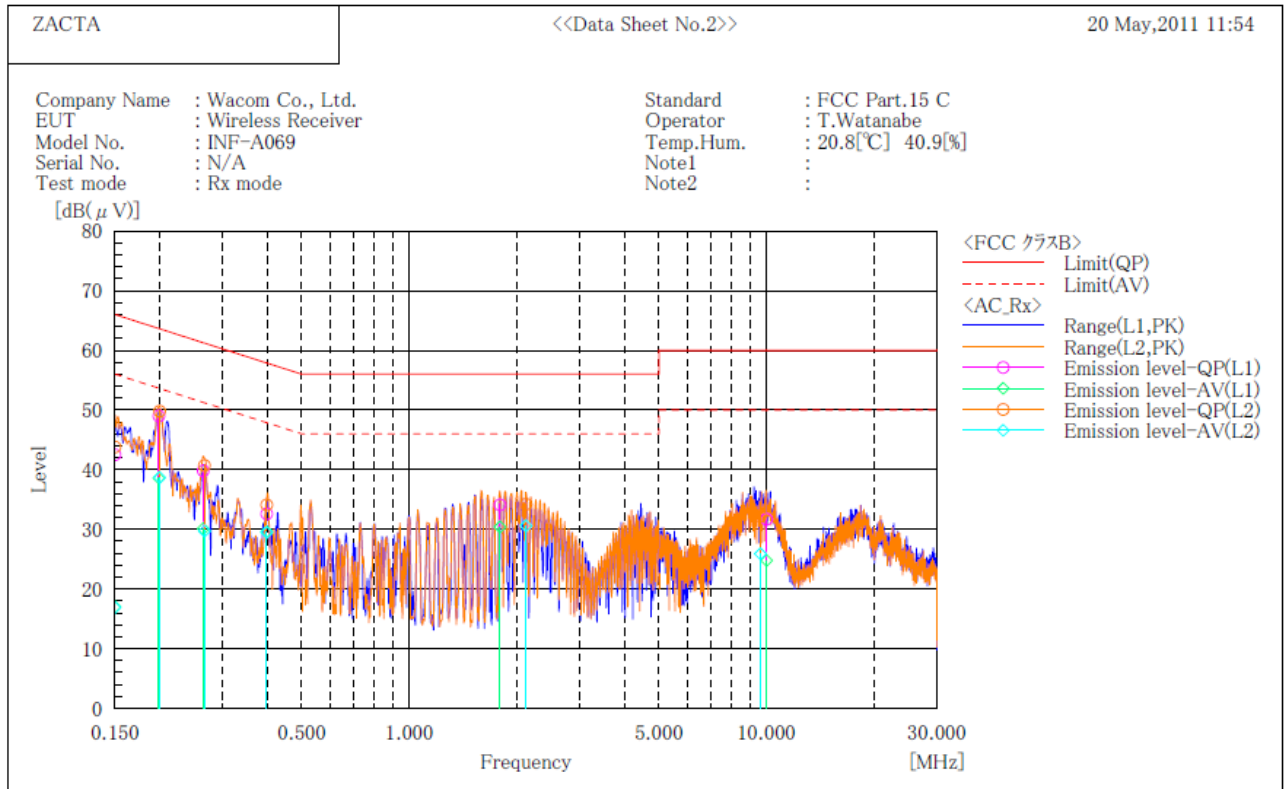

Final Result

--- L1 Phase ---

No.	Frequency [MHz]	Reading QP [dB(μV)]	Reading AV [dB(μV)]	c. f [dB]	Result QP [dB(μV)]	Result AV [dB(μV)]	Limit QP [dB(μV)]	Limit AV [dB(μV)]	Margin QP [dB]	Margin AV [dB]
1	0.150	32.3	6.8	10.2	42.5	17.0	66.0	56.0	23.5	39.0
2	0.199	38.9	28.5	10.1	49.0	38.6	63.7	53.7	14.7	15.1
3	0.265	29.8	20.1	10.0	39.8	30.1	61.3	51.3	21.5	21.2
4	0.399	22.6	19.6	10.0	32.6	29.6	57.9	47.9	25.3	18.3
5	1.794	24.0	20.3	10.1	34.1	30.4	56.0	46.0	21.9	15.6
6	10.011	21.3	14.4	10.4	31.7	24.8	60.0	50.0	28.3	25.2

--- L2 Phase ---

No.	Frequency [MHz]	Reading QP [dB(μV)]	Reading AV [dB(μV)]	c. f [dB]	Result QP [dB(μV)]	Result AV [dB(μV)]	Limit QP [dB(μV)]	Limit AV [dB(μV)]	Margin QP [dB]	Margin AV [dB]
1	0.150	33.6	6.7	10.2	43.8	16.9	66.0	56.0	22.2	39.1
2	0.200	39.7	28.6	10.1	49.8	38.7	63.6	53.6	13.8	14.9
3	0.267	30.7	19.7	10.0	40.7	29.7	61.2	51.2	20.5	21.5
4	0.399	24.1	19.5	10.0	34.1	29.5	57.9	47.9	23.8	18.4
5	2.121	24.1	20.5	10.1	34.2	30.6	56.0	46.0	21.8	15.4
6	9.619	21.8	15.5	10.4	32.2	25.9	60.0	50.0	27.8	24.1

#### ***4.5 Antenna requirement***

According to FCC section 15.203., an intentional radiator shall be designed to ensure that no antenna other than that furnished by the responsible party shall be used with the device.

The antenna is a PCB antenna mounted inside of the EUT. Therefore, the EUT complies with the antenna requirement of FCC section 15.203.

## ***5. Uncertainty of measurement***

---

Expanded uncertainties stated were calculated with a coverage Factor  $k=2$ .

Please note that these results are not taken into account when determining compliance or non-compliance with test result.

<b>Test item</b>	<b>Measurement uncertainty</b>
Conducted emission at mains port (150kHz - 30MHz)	$\pm 2.9\text{dB}$
Radiated emission (9kHz - 30MHz)	$\pm 4.4\text{dB}$
Radiated emission (30MHz – 1000MHz)	$\pm 4.5\text{dB}$
Radiated emission (1000MHz – 26GHz)	$\pm 3.9\text{dB}$

## 6. Laboratory description

**1. Location:** ZACTA Technology Corporation Yonezawa Testing Center  
4149-7 Hachimanpara 5-chome Yonezawa-shi Yamagata 992-1128 Japan  
Phone: +81-238-28-2880 Fax: +81-238-28-2888

**2. Facility filing information:**

1) NVLAP accreditation: NVLAP Lab. code: 200306-0

2) FCC filing:

Site name	Registration Number	Expiry Date
Site 2, Site3	91065	November 16, 2011
3m Semi-anechoic chamber 10m Semi-anechoic chamber	540072	February 17, 2013

3) Industry Canada Oats site filing:

Site name	Sites on file: Oats 3m/10m	Expiry Date
Site 2	4224A-2	February 16, 2012
Site 3	4224A-3	February 16, 2012
3m Semi-anechoic chamber	4224A-4	February 16, 2012
10m Semi-anechoic chamber	4224A-5	February 16, 2012

4) VCCI site filing:

Site name	Radiated emission	Conducted Emission for mains port	Expiry Date	Conducted emission for telecom port	Expiry Date
Site 2	R-137	C-133	Nov. 16, 2011	T-1477	Oct. 8, 2011
Site 3	R-138	C-134	Nov. 16, 2011	T-1478	Oct. 8, 2011
10m Semi-anechoic chamber	R-2480	C-2722	Jul. 3, 2011	T-1474	Oct. 8, 2011
3m Semi-anechoic chamber	R-2481	C-2723	Jul. 3, 2011	T-1475	Oct. 8, 2011
Shielded room No.1	R-137	C-2724	Jul. 3, 2011	T-1476	Oct. 8, 2011

5) ETL SEMKO authorization:

Authorized as an EMC test laboratory.

6) TUV Rheinland authorization:

Authorized as an EMC test laboratory.

7) BUREAU VERITAS certification:

Certified as an EMC test laboratory.

## Appendix A: Test equipment

### Antenna port Conducted Test

Equipment	Company	Model No.	Serial No.	Cal. due	Cal. date
Spectrum Analyzer	Agilent Technologies	E4447A	MY46180188	Feb. 2012	Feb. 23, 2011
Microwave cable	SUHNER	SUCOFLEX104	199511/4	Nov. 2011	Nov. 12, 2010
Attenuator	Weinschel	56-10	J4180	Nov. 2011	Nov. 12, 2010

\*The calibrations of the above equipment are traceable to NIST or equivalent standards of the reference organizations.

### Radiated Emission

Equipment	Company	Model No.	Serial No.	Cal. due	Cal. date
Spectrum Analyzer	Agilent Technologies	E4447A	MY46180188	Feb. 2012	Feb. 23, 2011
Preamplifier	ANRITSU	MH648A	M96057	Jun. 2011	Jun. 12, 2010
Preamplifier	Agilent Technologies	8449B	3008A01008	Dec. 2011	Dec. 10, 2010
Preamplifier	TSJ	MLA-1840-B03-35	1040332	Apr. 2013	Apr. 20, 2010
EMI Receiver	ROHDE&SCHWARZ	ESCI	100765	Jun. 2011	Jun. 9, 2010
Loop antenna	ROHDE&SCHWARZ	HFH2-Z2	891847/17	Feb.2012	Feb. 21, 2011
TRILOG Antenna	Schwarzbeck	VULB9160	9160-3220	Apr. 2012	Apr. 5, 2011
Attenuator(6dB)	TME	CFA-01NPJ-6	N/A (S274)	Jun. 2011	Jun. 12, 2010
Double Ridged Guide Antenna	EMCO	3115	00058532	Aug. 2011	Aug. 18, 2010
Broad-Band Horn Antenna	Schwarzbeck	BBHA9170	BBHA9170189	Apr. 2013	Apr. 20, 2010
Microwave cable	SUHNER	SUCOFLEX104/9m	322083/4	Oct. 2011	Oct. 6, 2010
		SUCOFLEX104/1m	322084/4	Oct. 2011	Oct. 6, 2010
		SUCOFLEX104/1.5m	317226/4	Oct. 2011	Oct. 6, 2010
		SUCOFLEX106/7m	41625/6	Oct. 2011	Oct. 6, 2010
PC	DELL	DIMENSION E521	75465BX	N/A	N/A
Software	TOYO Corporation	EP5/RE-AJ	0611193/V3.4	N/A	N/A
3m Semi-anechoic chamber	TOKIN	N/A	N/A (9002-NSA)	May 2011	May. 18, 2010

\*The calibrations of the above equipment are traceable to NIST or equivalent standards of the reference organizations.



**Conducted Emission**

Equipment	Company	Model No.	Serial No.	Cal. due	Cal. date
EMI Receiver	ROHDE&SCHWARZ	ESCI	100765	Jun. 2011	Jun. 9, 2010
Coaxial cable	FUJIKURA	5D-2W/4m	N/A (S192)	Feb. 2012	Feb. 4, 2011
	FUJIKURA	5D-2W/1m	N/A (S193)	Feb. 2012	Feb. 4, 2011
	SUHNER	RG223/U/0.6m	N/A (S324)	Feb. 2012	Feb. 4, 2011
Line impedance Stabilization network for EUT	Kyoritsu Electrical Works, Ltd.	KNW-407F	8-2003-1	Mar. 2012	Mar. 10, 2011
Line impedance Stabilization network for peripheral	Kyoritsu Electrical Works, Ltd.	KNW-242F	8-1973-1	May 2011	May 28, 2010
Attenuator	TYC	BA-PJ-10	N/A (S346)	Apr. 2012	Apr. 26, 2011
50Ω terminator	HRS	UG-88/U	N/A (S062)	Mar. 2012	Mar. 3, 2011
PC	DELL	DIMENSION E521	75465BX	N/A	N/A
Software	TOYO Corporation	EP5/CE-AJ	0611193/V3.3	N/A	N/A

\*The calibrations of the above equipment are traceable to NIST or equivalent standards of the reference organizations.