

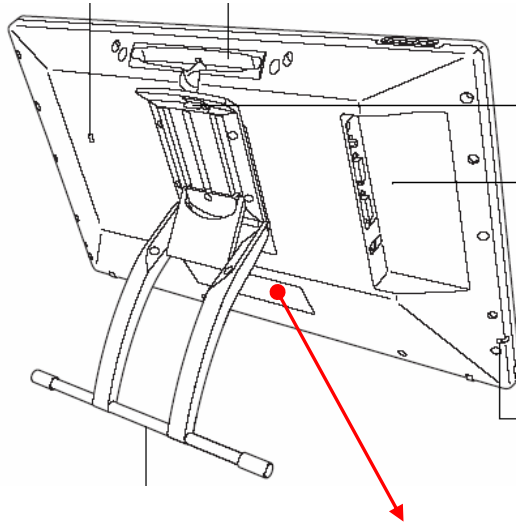













FCC ID Label Location

- Label Placement Location



FCC Label Placement Location

- FCC Label Format

	LCD TABLET 液晶数位板 液晶数位板 Wacom Co., Ltd. MODEL 型号/型號: DTU-1631 直流电流 DC:12V  3.5A 直流電流 United States Patents ; 5466896 5763839 5793360 5206785 5717435 5576502	DTU-1631A/G MANUFACTURED : JAN. 2010  0AAQS00001
	This device complies with Part 15 of FCC Rules. Operation is subject to the following two conditions: this device may not cause harmful interference, and this device must accept any interference received, including interference that may cause undesired operation.	
        	     	
<p>CAUTION: Risk of electric shock. Do not open. 警告: 高压注意 サービスマン以外の方は裏ぶたを開けないでください。 内部には高電圧部分があり、万一さわると危険です。 警告: 高压注意 请勿自行拆卸 注意: 本機に長時間、体の同じ部分が触れたまましていると、低温やけどを起こす場合があります。</p>		
中国制造 中國製造 MADE IN CHINA		
SLA-A292		