

## FCC Test Report

**Report No.:** RF190110C19-2 R1

**FCC ID:** HV4DTHW1621

**Test Model:** DTH-W1621

**Series Model:** DTHW1621\*\*\*\*\*; DTH-W1621\*\*\*\*\* (The "\*" Can be 0-9, A-Z or blank)  
(refer to item 3.1 for more details)

**Received Date:** Jan. 10, 2019

**Test Date:** Jan. 17, 2019 ~ Apr. 16, 2019

**Issued Date:** Apr. 17, 2019

**Applicant:** Wacom Co., Ltd.

**Address:** 2-510-1, Toyonodai, Kazo-Shi, Saitama, 349-1148 Japan

**Issued By:** Bureau Veritas Consumer Products Services (H.K.) Ltd., Taoyuan Branch

**Lab Address:** No. 47-2, 14th Ling, Chia Pau Vil., Lin Kou Dist., New Taipei City, Taiwan  
( R.O.C )

**Test Location (1):** No.19, Hwa Ya 2nd Rd., Wen Hwa Vil., Kwei Shan Dist., Taoyuan City  
33383, Taiwan, R.O.C.

**Test Location (2):** B2F., No.215, Sec. 3, Beixin Rd., Xindian Dist., New Taipei City 231,  
Taiwan, R.O.C

**FCC Registration /  
Designation Number:** 427177 / TW0011



This report is for your exclusive use. Any copying or replication of this report to or for any other person or entity, or use of our name or trademark, is permitted only with our prior written permission. This report sets forth our findings solely with respect to the test samples identified herein. The results set forth in this report are not indicative or representative of the quality or characteristics of the lot from which a test sample was taken or any similar or identical product unless specifically and expressly noted. Our report includes all of the tests requested by you and the results thereof based upon the information that you provided to us. You have 60 days from date of issuance of this report to notify us of any material error or omission caused by our negligence, provided, however, that such notice shall be in writing and shall specifically address the issue you wish to raise. A failure to raise such issue within the prescribed time shall constitute your unqualified acceptance of the completeness of this report, the tests conducted and the correctness of the report contents. Unless specific mention, the uncertainty of measurement has been explicitly taken into account to declare the compliance or non-compliance to the specification. The report must not be used by the client to claim product certification, approval, or endorsement by TAF or any government agencies.

## Table of Contents

<b>Release Control Record</b> .....	<b>4</b>
<b>1 Certificate of Conformity</b> .....	<b>5</b>
<b>2 Summary of Test Results</b> .....	<b>6</b>
2.1 Measurement Uncertainty .....	6
2.2 Modification Record .....	6
<b>3 General Information</b> .....	<b>7</b>
3.1 General Description of EUT .....	7
3.2 Description of Test Modes .....	8
3.2.1 Test Mode Applicability and Tested Channel Detail .....	9
3.3 Duty Cycle of Test Signal .....	11
3.4 Description of Support Units .....	12
3.4.1 Configuration of System under Test .....	12
3.5 General Description of Applied Standards .....	12
<b>4 Test Types and Results</b> .....	<b>13</b>
4.1 Radiated Emission and Bandedge Measurement .....	13
4.1.1 Limits of Radiated Emission and Bandedge Measurement .....	13
4.1.2 Test Instruments .....	14
4.1.3 Test Procedures .....	15
4.1.4 Deviation from Test Standard .....	16
4.1.5 Test Set Up .....	16
4.1.6 EUT Operating Conditions .....	17
4.1.7 Test Results .....	18
4.2 Conducted Emission Measurement .....	32
4.2.1 Limits of Conducted Emission Measurement .....	32
4.2.2 Test Instruments .....	32
4.2.3 Test Procedures .....	33
4.2.4 Deviation from Test Standard .....	33
4.2.5 Test Setup .....	33
4.2.6 EUT Operating Conditions .....	33
4.2.7 Test Results .....	34
4.3 6 dB Bandwidth Measurement .....	36
4.3.1 Limits of 6 dB Bandwidth Measurement .....	36
4.3.2 Test Setup .....	36
4.3.3 Test Instruments .....	36
4.3.4 Test Procedure .....	36
4.3.5 Deviation from Test Standard .....	36
4.3.6 EUT Operating Conditions .....	36
4.3.7 Test Results .....	37
4.4 Occupied Bandwidth Measurement .....	39
4.4.1 Test Setup .....	39
4.4.2 Test Instruments .....	39
4.4.3 Test Procedure .....	39
4.4.4 Deviation from Test Standard .....	39
4.4.5 EUT Operating Conditions .....	39
4.4.6 Test Results .....	40
4.5 Conducted Output Power Measurement .....	42
4.5.1 Limits of Conducted Output Power Measurement .....	42
4.5.2 Test Setup .....	42
4.5.3 Test Instruments .....	42
4.5.4 Test Procedures .....	42
4.5.5 Deviation from Test Standard .....	42
4.5.6 EUT Operating Conditions .....	42
4.5.7 Test Results .....	43

4.6	Power Spectral Density Measurement .....	44
4.6.1	Limits of Power Spectral Density Measurement.....	44
4.6.2	Test Setup.....	44
4.6.3	Test Instruments .....	44
4.6.4	Test Procedure .....	44
4.6.5	Deviation from Test Standard .....	44
4.6.6	EUT Operating Condition .....	44
4.6.7	Test Results .....	45
4.7	Conducted Out of Band Emission Measurement .....	47
4.7.1	Limits of Conducted Out of Band Emission Measurement.....	47
4.7.2	Test Setup.....	47
4.7.3	Test Instruments .....	47
4.7.4	Test Procedure .....	47
4.7.5	Deviation from Test Standard .....	47
4.7.6	EUT Operating Condition .....	47
4.7.7	Test Results .....	48
<b>5</b>	<b>Pictures of Test Arrangements.....</b>	<b>55</b>
	<b>Appendix – Information of the Testing Laboratories .....</b>	<b>56</b>

### Release Control Record

Issue No.	Description	Date Issued
RF190110C19-2	Original Release	Feb. 13, 2019
RF190110C19-2 R1	Revised model No.	Apr. 17, 2019

## 1 Certificate of Conformity

**Product:** GRAPHICS TABLET COMPUTER

**Brand:** Wacom

**Test Model:** DTH-W1621

**Series Model:** DTHW1621\*\*\*\*\*; DTH-W1621\*\*\*\*\* (The "\*" Can be 0-9, A-Z or blank)  
(refer to item 3.1 for more details)

**Sample Status:** Engineering Sample

**Applicant:** Wacom Co., Ltd.

**Test Date:** Jan. 17, 2019 ~ Apr. 16, 2019

**Standards:** 47 CFR FCC Part 15, Subpart C (Section 15.247)  
ANSI C63.10:2013

The above equipment has been tested by **Bureau Veritas Consumer Products Services (H.K.) Ltd., Taoyuan Branch**, and found compliance with the requirement of the above standards. The test record, data evaluation & Equipment Under Test (EUT) configurations represented herein are true and accurate accounts of the measurements of the sample's RF characteristics under the conditions specified in this report.

**Prepared by :** , **Date:** Apr. 17, 2019  
Gina Liu / Specialist

**Approved by :** , **Date:** Apr. 17, 2019  
Dylan Chiou / Project Engineer

## 2 Summary of Test Results

47 CFR FCC Part 15, Subpart C (Section 15.247)			
FCC Clause	Test Item	Result	Remarks
15.207	AC Power Conducted Emission	Pass	Meet the requirement of limit. Minimum passing margin is -22.80 dB at 0.17346 MHz.
15.205 / 15.209 / 15.247(d)	Radiated Emissions and Band Edge Measurement	Pass	Meet the requirement of limit. Minimum passing margin is -2.15 dB at 2386.23 MHz.
15.247(d)	Antenna Port Emission	Pass	Meet the requirement of limit.
15.247(a)(2)	6 dB Bandwidth	Pass	Meet the requirement of limit.
---	Occupied Bandwidth Measurement	Pass	Reference only
15.247(b)	Conducted power	Pass	Meet the requirement of limit.
15.247(e)	Power Spectral Density	Pass	Meet the requirement of limit.
15.203	Antenna Requirement	Pass	No antenna connector is used.

Note: Determining compliance based on the results of the compliance measurement, not taking into account measurement instrumentation uncertainty.

### 2.1 Measurement Uncertainty

Where relevant, the following measurement uncertainty levels have been estimated for tests performed on the EUT as specified in CISPR 16-4-2:

Measurement	Frequency	Expanded Uncertainty (k=2) (±)
Conducted Emissions at mains ports	150 kHz ~ 30 MHz	2.44 dB
Radiated Emissions up to 1 GHz	9 kHz ~ 30 MHz	3.04 dB
	30 MHz ~ 200 MHz	2.0153 dB
	200 MHz ~ 1000 MHz	2.0224 dB
Radiated Emissions above 1 GHz	1 GHz ~ 18 GHz	1.0121 dB
	18 GHz ~ 40 GHz	1.1508 dB

### 2.2 Modification Record

There were no modifications required for compliance.

### 3 General Information

#### 3.1 General Description of EUT

<b>Product</b>	GRAPHICS TABLET COMPUTER
<b>Brand</b>	Wacom
<b>Test Model</b>	DTH-W1621
<b>Series Model</b>	DTHW1621*****; DTH-W1621***** (The "*" Can be 0-9, A-Z or blank)
<b>Status of EUT</b>	Engineering Sample
<b>Power Supply Rating</b>	5.0 or 20 Vdc (adapter)
<b>Modulation Type</b>	CCK, DQPSK, DBPSK for DSSS 64QAM, 16QAM, QPSK, BPSK for OFDM
<b>Modulation Technology</b>	DSSS, OFDM
<b>Transfer Rate</b>	802.11b: 11.0 / 5.5 / 2.0 / 1.0 Mbps 802.11g: 54.0 / 48.0 / 36.0 / 24.0 / 18.0 / 12.0 / 9.0 / 6.0 Mbps 802.11n: up to 300.0 Mbps
<b>Operating Frequency</b>	2412 ~ 2462 MHz
<b>Number of Channel</b>	11 for 802.11b, 802.11g, 802.11n (HT20) 7 for 802.11n (HT40)
<b>Output Power</b>	280.396 mW
<b>Antenna Type</b>	PIFA antenna with 0.38 dBi gain
<b>Antenna Connector</b>	N/A
<b>Accessory Device</b>	Refer to Note as below
<b>Data Cable Supplied</b>	Refer to Note as below

Note:

- The EUT incorporates a MIMO function. Physically, the EUT provides two completed transmitters and two receivers.

Modulation Mode	Tx Function
802.11b	1TX
802.11g	1TX
802.11n (HT20)	2TX
802.11n (HT40)	2TX

- All models are listed as below.

Brand	Model	Difference
Wacom	DTH-W1621	Main test
	DTHW1621*****	The "*" Can be 0-9, A-Z or blank for the new marketing
	DTH-W1621*****	

- The EUT contains following accessory devices.

Product	Brand	Model	Description
Adapter	WACOM	ADP-100PB B	I/P: 100-240 Vac, 50-60 Hz, 1.5 A O/P: 5 Vdc, 3 A or 20 Vdc, 5 A 1.8m / 1 core
WLAN Module	Intel	9260NGW	--

- The above EUT information is declared by manufacturer and for more detailed features description, please refers to the manufacturer's specifications or user's manual.

### 3.2 Description of Test Modes

11 channels are provided for 802.11b, 802.11g and 802.11n (HT20):

Channel	Frequency (MHz)	Channel	Frequency (MHz)
1	2412	7	2442
2	2417	8	2447
3	2422	9	2452
4	2427	10	2457
5	2432	11	2462
6	2437		

7 channels are provided for 802.11n (HT40):

Channel	Frequency (MHz)	Channel	Frequency (MHz)
3	2422	7	2442
4	2427	8	2447
5	2432	9	2452
6	2437		



### 3.2.1 Test Mode Applicability and Tested Channel Detail

EUT Configure Mode	Applicable To				Description
	RE $\geq$ 1G	RE<1G	PLC	APCM	
-	√	√	√	√	-

Where **RE $\geq$ 1G**: Radiated Emission above 1 GHz      **RE<1G**: Radiated Emission below 1 GHz  
**PLC**: Power Line Conducted Emission      **APCM**: Antenna Port Conducted Measurement

**NOTE:** The EUT had been pre-tested on the positioned of each 3 axis. The worst case was found when positioned on **Z-plane**.  
**NOTE:** “-” means no effect.

#### **Radiated Emission Test (Above 1 GHz):**

- Pre-Scan has been conducted to determine the worst-case mode from all possible combinations between available modulations, data rates and antenna ports (if EUT with antenna diversity architecture).
- Following channel(s) was (were) selected for the final test as listed below.

EUT Configure Mode	Mode	Available Channel	Tested Channel	Modulation Technology	Modulation Type	Data Rate (Mbps)
-	802.11b	1 to 11	1, 6, 11	DSSS	DBPSK	1.0
-	802.11g	1 to 11	1, 6, 11	OFDM	BPSK	6.0
-	802.11n (HT20)	1 to 11	1, 6, 11	OFDM	BPSK	6.5
-	802.11n (HT40)	3 to 9	3, 6, 9	OFDM	BPSK	13.5

#### **Radiated Emission Test (Below 1 GHz):**

- Pre-Scan has been conducted to determine the worst-case mode from all possible combinations between available modulations, data rates and antenna ports (if EUT with antenna diversity architecture).
- Following channel(s) was (were) selected for the final test as listed below.

EUT Configure Mode	Mode	Available Channel	Tested Channel	Modulation Technology	Modulation Type	Data Rate (Mbps)
-	802.11b	1 to 11	1	DSSS	DBPSK	1.0

#### **Power Line Conducted Emission Test:**

- Pre-Scan has been conducted to determine the worst-case mode from all possible combinations between available modulations, data rates and antenna ports (if EUT with antenna diversity architecture).
- Following channel(s) was (were) selected for the final test as listed below.

EUT Configure Mode	Mode	Available Channel	Tested Channel	Modulation Technology	Modulation Type	Data Rate (Mbps)
-	802.11b	1 to 11	1	DSSS	DBPSK	1.0

**Bandedge Measurement:**

- Pre-Scan has been conducted to determine the worst-case mode from all possible combinations between available modulations, data rates and antenna ports (if EUT with antenna diversity architecture).
- Following channel(s) was (were) selected for the final test as listed below.

EUT Configure Mode	Mode	Available Channel	Tested Channel	Modulation Technology	Modulation Type	Data Rate (Mbps)
-	802.11b	1 to 11	1, 11	DSSS	DBPSK	1.0
-	802.11g	1 to 11	1, 11	OFDM	BPSK	6.0
-	802.11n (HT20)	1 to 11	1, 11	OFDM	BPSK	6.5
-	802.11n (HT40)	3 to 9	3, 9	OFDM	BPSK	13.5

**Antenna Port Conducted Measurement:**

- This item includes all test value of each mode, but only includes spectrum plot of worst value of each mode.
- Pre-Scan has been conducted to determine the worst-case mode from all possible combinations between available modulations, data rates and antenna ports (if EUT with antenna diversity architecture).
- Following channel(s) was (were) selected for the final test as listed below.

EUT Configure Mode	Mode	Available Channel	Tested Channel	Modulation Technology	Modulation Type	Data Rate (Mbps)
-	802.11b	1 to 11	1, 6, 11	DSSS	DBPSK	1.0
-	802.11g	1 to 11	1, 6, 11	OFDM	BPSK	6.0
-	802.11n (HT20)	1 to 11	1, 6, 11	OFDM	BPSK	6.5
-	802.11n (HT40)	3 to 9	3, 6, 9	OFDM	BPSK	13.5

**Test Condition:**

Applicable To	Environmental Conditions	Input Power	Tested by
RE≥1G	25 deg. C, 65 % RH	120 Vac, 60 Hz	Karl Lee, Harry Hsueh
RE<1G	25 deg. C, 65 % RH	120 Vac, 60 Hz	Karl Lee
PLC	25 deg. C, 65 % RH	120 Vac, 60 Hz	Jisyong Wang
APCM	25 deg. C, 65 % RH	120 Vac, 60 Hz	Gavin Wu

### 3.3 Duty Cycle of Test Signal

**802.11b:** Duty cycle =  $12.311/12.723 = 0.968$ , Duty factor =  $10 * \log(1/0.968) = 0.14$

**802.11g:** Duty cycle =  $2.04/2.42 = 0.843$ , Duty factor =  $10 * \log(1/0.843) = 0.74$

**802.11n (HT20):** Duty cycle =  $0.973/1.164 = 0.836$ , Duty factor =  $10 * \log(1/0.836) = 0.78$

**802.11n (HT40):** Duty cycle =  $0.491/0.588 = 0.835$ , Duty factor =  $10 * \log(1/0.835) = 0.78$

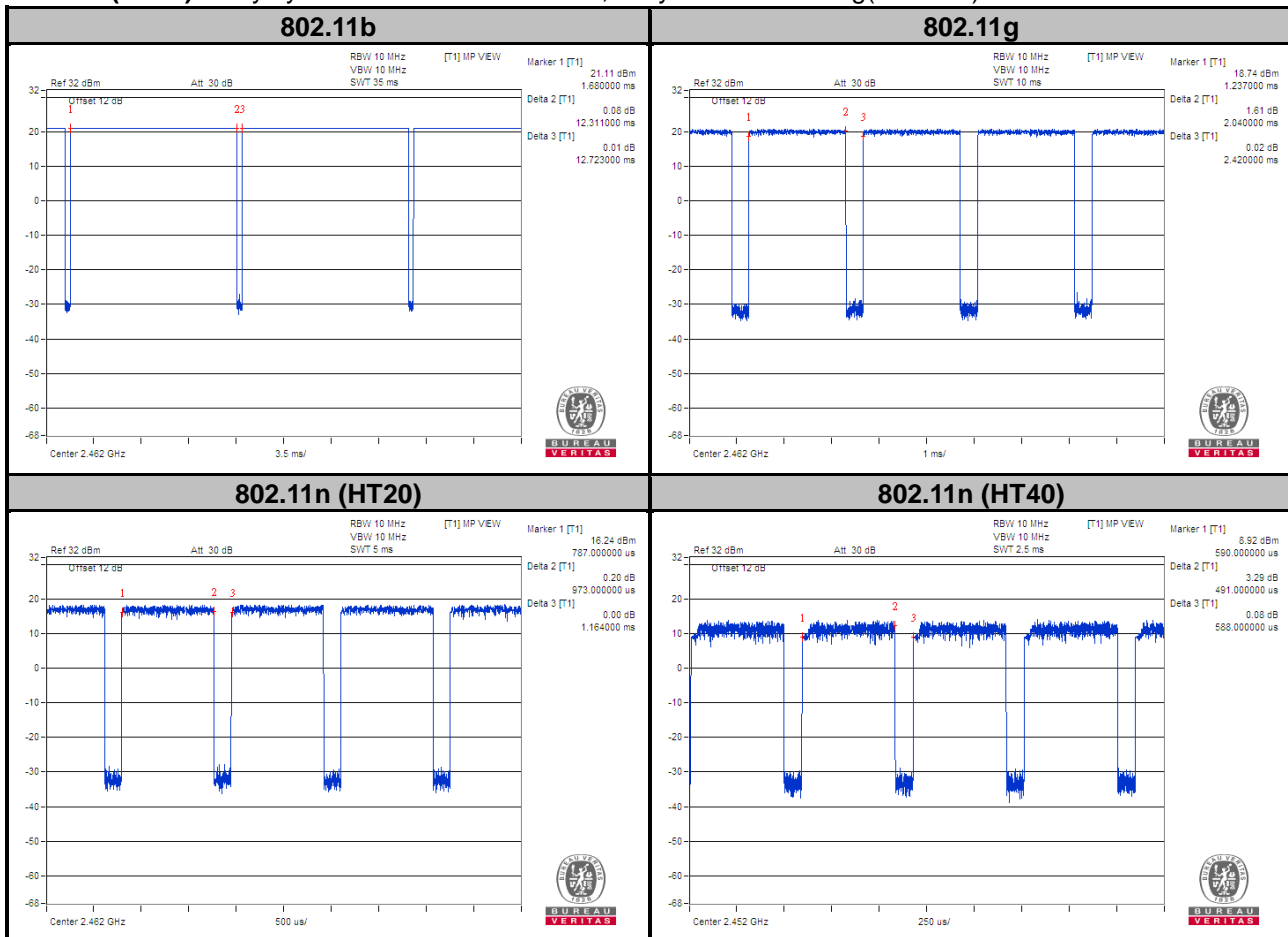

### 3.4 Description of Support Units

The EUT has been tested as an independent unit together with other necessary accessories or support units.

#### 3.4.1 Configuration of System under Test

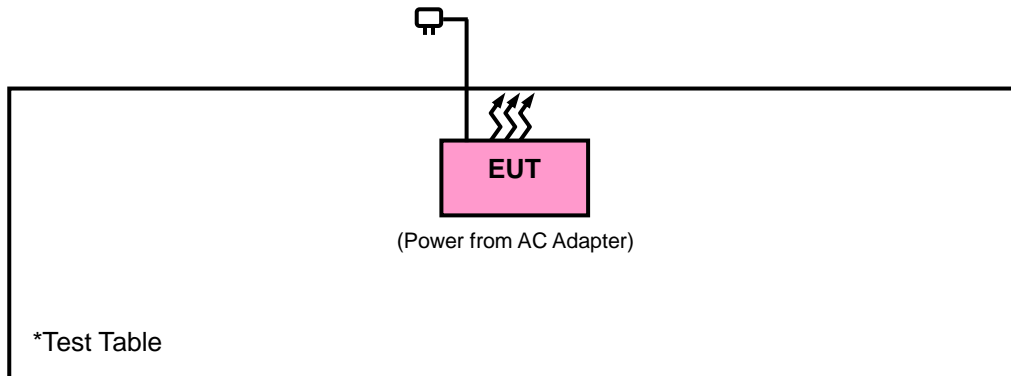

### 3.5 General Description of Applied Standards

The EUT is a RF Product. According to the specifications of the manufacturer, it must comply with the requirements of the following standards:

**FCC Part 15, Subpart C (15.247)**

**KDB 558074 D01 15.247 Meas Guidance v05r02**

**KDB 662911 D01 Multiple Transmitter Output v02r01**

**ANSI C63.10-2013**

All test items have been performed and recorded as per the above standards.

## 4 Test Types and Results

### 4.1 Radiated Emission and Bandedge Measurement

#### 4.1.1 Limits of Radiated Emission and Bandedge Measurement

Radiated emissions which fall in the restricted bands must comply with the radiated emission limits specified as below table. Other emissions shall be at least 20 dB below the highest level of the desired power:

Frequencies (MHz)	Field Strength (microvolts/meter)	Measurement Distance (meters)
0.009 ~ 0.490	2400/F (kHz)	300
0.490 ~ 1.705	24000/F (kHz)	30
1.705 ~ 30.0	30	30
30 ~ 88	100	3
88 ~ 216	150	3
216 ~ 960	200	3
Above 960	500	3

**NOTE:**

1. The lower limit shall apply at the transition frequencies.
2. Emission level (dBuV/m) = 20 log Emission level (uV/m).
3. For frequencies above 1000 MHz, the field strength limits are based on average detector, however, the peak field strength of any emission shall not exceed the maximum permitted average limits, specified above by more than 20 dB under any condition of modulation.

#### 4.1.2 Test Instruments

Description & Manufacturer	Model No.	Serial No.	Date of Calibration	Due Date of Calibration
Test Receiver Agilent Technologies	N9038A	MY51210203	Mar. 16, 2018	Mar. 15, 2019
			Mar. 18, 2019	Mar. 17, 2020
Spectrum Analyzer ROHDE & SCHWARZ	FSU43	100115	Jan. 21, 2019	Jan. 20, 2020
HORN Antenna ETS-Lindgren	3117	00143293	Nov. 25, 2018	Nov. 24, 2019
BILOG Antenna SCHWARZBECK	VULB9168	9168-616	Nov. 27, 2018	Nov. 26, 2019
HORN Antenna SCHWARZBECK	BBHA 9170	9170-480	Nov. 25, 2018	Nov. 24, 2019
Fixed Attenuator Mini-Circuits	MDCS18N-10	MDCS18N-10-01	Apr. 16, 2018	Apr. 15, 2019
			Apr. 15, 2019	Apr. 14, 2020
Loop Antenna	EM-6879	269	Sep. 07, 2018	Sep. 06, 2019
Preamplifier Agilent	310N	187226	Jun. 19, 2018	Jun. 18, 2019
Preamplifier Agilent	83017A	MY39501357	Jun. 19, 2018	Jun. 18, 2019
Power Meter Anritsu	ML2495A	1012010	Sep. 05, 2018	Sep. 04, 2019
Power Sensor Anritsu	MA2411B	1315050	Sep. 04, 2018	Sep. 03, 2019
RF signal cable ETS-LINDGREN	5D-FB	Cable-CH1-01(RFC -SMS-100-SMS-12 0+RFC-SMS-100-S MS-400)	Jun. 19, 2018	Jun. 18, 2019
RF signal cable ETS-LINDGREN	8D-FB	Cable-CH1-02(RFC -SMS-100-SMS-24)	Jun. 19, 2018	Jun. 18, 2019
Boresight Antenna Fixture	FBA-01	FBA-SIP01	NA	NA
Software BV ADT	E3 8.130425b	NA	NA	NA
Antenna Tower MF	NA	NA	NA	NA
Turn Table MF	NA	NA	NA	NA
Antenna Tower & Turn Table Controller MF	MF-7802	NA	NA	NA

- Note: 1. The calibration interval of the above test instruments is 12 months and the calibrations are traceable to NML/ROC and NIST/USA.
2. The test was performed in HsinTien Chamber 1.
3. The horn antenna and preamplifier (model: 83017A) are used only for the measurement of emission frequency above 1 GHz if tested.
4. The IC Site Registration No. is 7450I-1.

#### 4.1.3 Test Procedures

##### **For Radiated Emission below 30 MHz**

- a. The EUT was placed on the top of a rotating table 0.8 meters above the ground at a 3 meter chamber room. The table was rotated 360 degrees to determine the position of the highest radiation.
- b. The EUT was set 3 meters away from the interference-receiving antenna, which was mounted on the top of a variable-height antenna tower.
- c. Parallel, perpendicular, and ground-parallel orientations of the antenna are set to make the measurement.
- d. For each suspected emission, the EUT was arranged to its worst case and the rotatable table was turned from 0 degrees to 360 degrees to find the maximum reading.
- e. The test-receiver system was set to Quasi-Peak Detect Function and Specified Bandwidth with Maximum Hold Mode.

##### **Note:**

1. The resolution bandwidth and video bandwidth of test receiver/spectrum analyzer is 9 kHz at frequency below 30 MHz.

##### **For Radiated Emission above 30 MHz**

- a. The EUT was placed on the top of a rotating table 0.8 meters (for 30 MHz ~ 1 GHz) / 1.5 meters (for above 1 GHz) above the ground at 3 meter chamber room for test. The table was rotated 360 degrees to determine the position of the highest radiation.
- b. The EUT was set 3 meters away from the interference-receiving antenna, which was mounted on the top of a variable-height antenna tower.
- c. The height of antenna is varied from one meter to four meters above the ground to determine the maximum value of the field strength. Both horizontal and vertical polarizations of the antenna are set to make the measurement.
- d. For each suspected emission, the EUT was arranged to its worst case and then the antenna was tuned to heights from 1 meter to 4 meters and the rotatable table was turned from 0 degrees to 360 degrees to find the maximum reading.
- e. The test-receiver system was set to quasi-peak detect function and specified bandwidth with maximum hold mode when the test frequency is below 1 GHz.
- f. The test-receiver system was set to peak and average detected function and specified bandwidth with maximum hold mode when the test frequency is above 1 GHz. If the peak reading value also meets average limit, measurement with the average detector is unnecessary.

##### **Note:**

1. The resolution bandwidth and video bandwidth of test receiver/spectrum analyzer is 120 kHz for Quasi-peak detection (QP) or Peak detection (PK) at frequency below 1 GHz.
2. The resolution bandwidth of test receiver/spectrum analyzer is 1 MHz and the video bandwidth is 3 MHz for Peak detection (PK) at frequency above 1 GHz.
3. The resolution bandwidth of test receiver/spectrum analyzer is 1 MHz and the video bandwidth is  $\geq 1/T$  (Duty cycle < 98 %) or 10 Hz (Duty cycle  $\geq 98$  %) for Average detection (AV) at frequency above 1 GHz.  
(11b: RBW = 1 MHz, VBW = 100 Hz ; 11g: RBW = 1 MHz, VBW = 1 kHz ;  
11n (HT20): RBW = 1 MHz, VBW = 3 kHz ; 11n (HT40): RBW = 1 MHz, VBW = 3 kHz)
4. All modes of operation were investigated and the worst-case emissions are reported.

4.1.4 Deviation from Test Standard

No deviation.

4.1.5 Test Set Up

<Radiated Emission below 30 MHz>

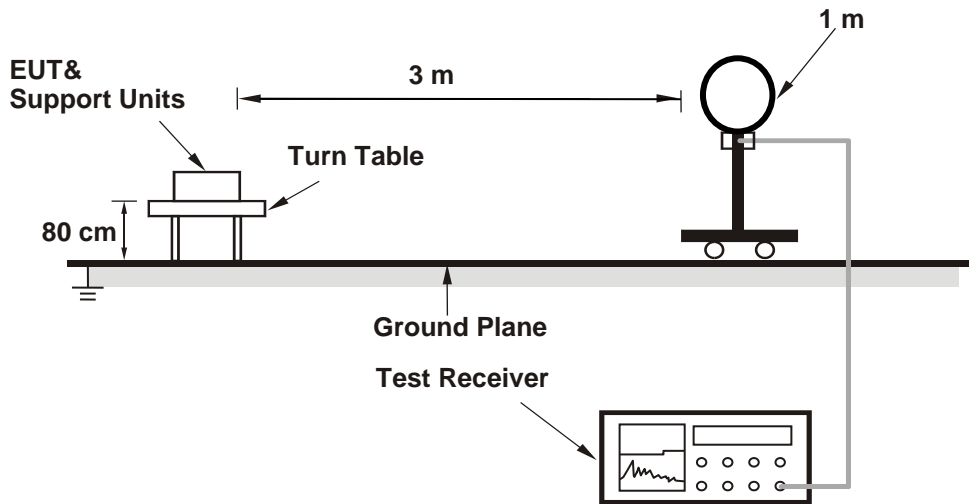

<Radiated Emission 30 MHz to 1 GHz>

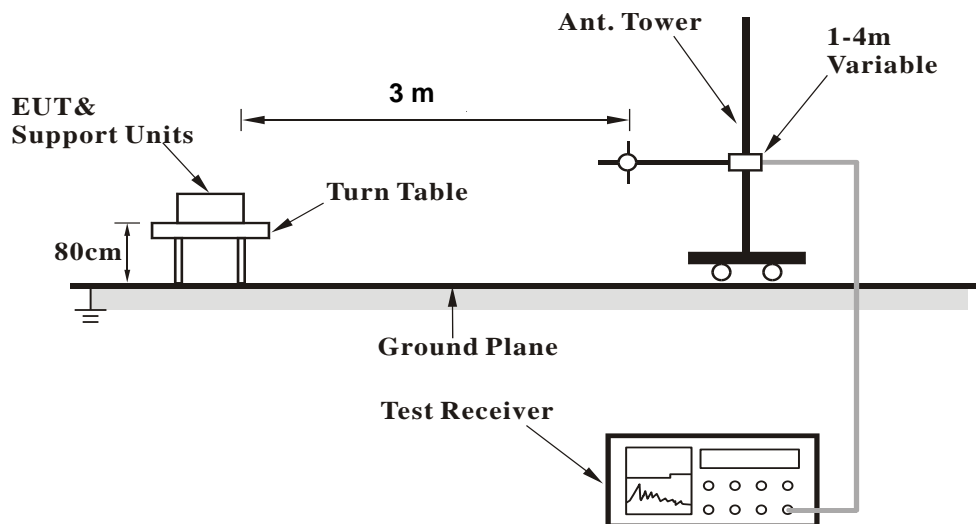



**<Radiated Emission above 1 GHz>**

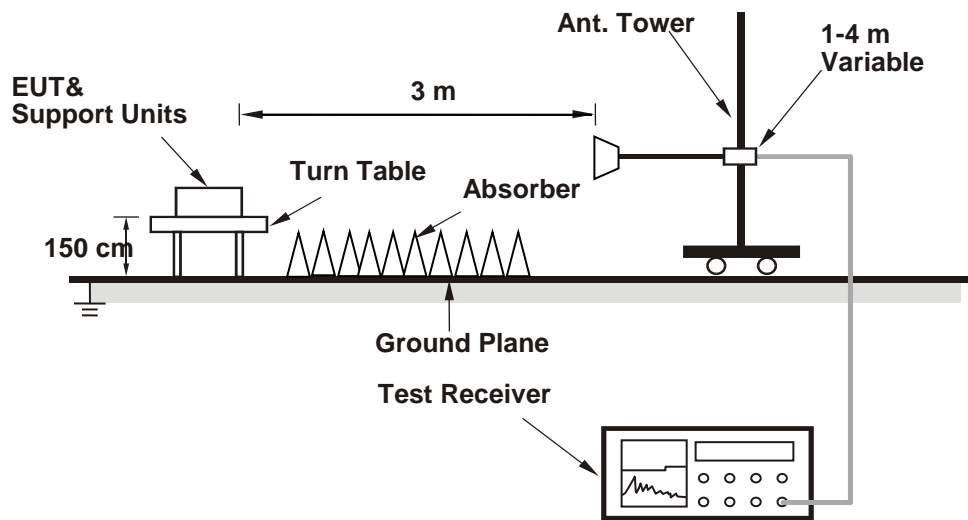

For the actual test configuration, please refer to the attached file (Test Setup Photo).

**4.1.6 EUT Operating Conditions**

- a. Placed the EUT on a testing table.
- b. Use the software to control the EUT under transmission condition continuously at specific channel frequency.

4.1.7 Test Results

Above 1 GHz Data :  
802.11b

EUT Test Condition		Measurement Detail	
Channel	Channel 1	Frequency Range	1 GHz ~ 25 GHz
Input Power	120 Vac, 60 Hz	Detector Function	Peak (PK) Average (AV)
Environmental Conditions	25 deg. C, 65 % RH	Tested By	Karl Lee

Antennal Polarity & Test Distance: Horizontal at 3 m										
Frequency (MHz)	Emission Level (dBuV/m)	Read Level (dBuV)	Limit (dBuV/m)	Margin (dB)	Antenna Factor (dB/m)	Cable Loss (dB)	Preamp Factor (dB)	Antenna Height (cm)	Table Angle (Degree)	Remark
2386.32	43.27	36.83	54	-10.73	31.8	5.4	30.76	101	306	Average
2386.32	52.42	45.98	74	-21.58	31.8	5.4	30.76	101	306	Peak
2412	86.77	80.26			31.81	5.43	30.73	101	306	Average
2412	91.05	84.54			31.81	5.43	30.73	101	306	Peak
4824	41.98	33.85	54	-12.02	33.97	8.26	34.1	135	226	Average
4824	47.48	39.35	74	-26.52	33.97	8.26	34.1	135	226	Peak

Antennal Polarity & Test Distance: Vertical at 3 m										
Frequency (MHz)	Emission Level (dBuV/m)	Read Level (dBuV)	Limit (dBuV/m)	Margin (dB)	Antenna Factor (dB/m)	Cable Loss (dB)	Preamp Factor (dB)	Antenna Height (cm)	Table Angle (Degree)	Remark
2386.23	51.85	45.41	54	-2.15	31.8	5.4	30.76	141	232	Average
2386.23	62.27	55.83	74	-11.73	31.8	5.4	30.76	141	232	Peak
2412	97.1	90.59			31.81	5.43	30.73	141	232	Average
2412	101.93	95.42			31.81	5.43	30.73	141	232	Peak
4824	41.38	33.25	54	-12.62	33.97	8.26	34.1	124	44	Average
4824	46.49	38.36	74	-27.51	33.97	8.26	34.1	124	44	Peak

Remarks:

- Emission Level = Read Level + Antenna Factor + Cable Loss - Preamp Factor  
Margin value = Emission level – Limit value
- 2412 MHz: Fundamental frequency.
- The emission levels of other frequencies were very low against the limit.

EUT Test Condition		Measurement Detail	
Channel	Channel 6	Frequency Range	1 GHz ~ 25 GHz
Input Power	120 Vac, 60 Hz	Detector Function	Peak (PK) Average (AV)
Environmental Conditions	25 deg. C, 65 % RH	Tested By	Karl Lee

Antennal Polarity & Test Distance: Horizontal at 3 m										
Frequency (MHz)	Emission Level (dBuV/m)	Read Level (dBuV)	Limit (dBuV/m)	Margin (dB)	Antenna Factor (dB/m)	Cable Loss (dB)	Preamp Factor (dB)	Antenna Height (cm)	Table Angle (Degree)	Remark
2389.29	40.82	34.38	54	-13.18	31.8	5.4	30.76	141	232	Average
2389.29	51.68	45.24	74	-22.32	31.8	5.4	30.76	141	232	Peak
2437	98.99	92.37			31.85	5.46	30.69	141	232	Average
2437	102.84	96.22			31.85	5.46	30.69	141	232	Peak
2488.16	41.07	34.26	54	-12.93	31.9	5.53	30.62	141	232	Average
2488.16	52.17	45.36	74	-21.83	31.9	5.53	30.62	141	232	Peak
4874	40.6	32.41	54	-13.4	33.98	8.27	34.06	157	4	Average
4874	46.65	38.46	74	-27.35	33.98	8.27	34.06	157	4	Peak
Antennal Polarity & Test Distance: Vertical at 3 m										
Frequency (MHz)	Emission Level (dBuV/m)	Read Level (dBuV)	Limit (dBuV/m)	Margin (dB)	Antenna Factor (dB/m)	Cable Loss (dB)	Preamp Factor (dB)	Antenna Height (cm)	Table Angle (Degree)	Remark
2388.84	41.75	35.31	54	-12.25	31.8	5.4	30.76	101	306	Average
2388.84	51.91	45.47	74	-22.09	31.8	5.4	30.76	101	306	Peak
2437	87.59	80.97			31.85	5.46	30.69	101	306	Average
2437	92	85.38			31.85	5.46	30.69	101	306	Peak
2487	40.78	33.99	54	-13.22	31.88	5.53	30.62	101	306	Average
2487	51.86	45.07	74	-22.14	31.88	5.53	30.62	101	306	Peak
4874	40.79	32.6	54	-13.21	33.98	8.27	34.06	101	111	Average
4874	47.2	39.01	74	-26.8	33.98	8.27	34.06	101	111	Peak

Remarks:

- Emission Level = Read Level + Antenna Factor + Cable Loss - Preamp Factor  
Margin value = Emission level – Limit value
- 2437 MHz: Fundamental frequency.
- The emission levels of other frequencies were very low against the limit.

EUT Test Condition		Measurement Detail	
Channel	Channel 11	Frequency Range	1 GHz ~ 25 GHz
Input Power	120 Vac, 60 Hz	Detector Function	Peak (PK) Average (AV)
Environmental Conditions	25 deg. C, 65 % RH	Tested By	Karl Lee

Antennal Polarity & Test Distance: Horizontal at 3 m										
Frequency (MHz)	Emission Level (dBuV/m)	Read Level (dBuV)	Limit (dBuV/m)	Margin (dB)	Antenna Factor (dB/m)	Cable Loss (dB)	Preamp Factor (dB)	Antenna Height (cm)	Table Angle (Degree)	Remark
2462	99.66	92.94			31.87	5.5	30.65	126	232	Average
2462	102.72	96			31.87	5.5	30.65	126	232	Peak
2483.52	43.7	36.94	54	-10.3	31.88	5.5	30.62	126	232	Average
2483.52	61.76	55	74	-12.24	31.88	5.5	30.62	126	232	Peak
4924	40.41	32.16	54	-13.59	33.99	8.28	34.02	125	275	Average
4924	47.52	39.27	74	-26.48	33.99	8.28	34.02	125	275	Peak
Antennal Polarity & Test Distance: Vertical at 3 m										
Frequency (MHz)	Emission Level (dBuV/m)	Read Level (dBuV)	Limit (dBuV/m)	Margin (dB)	Antenna Factor (dB/m)	Cable Loss (dB)	Preamp Factor (dB)	Antenna Height (cm)	Table Angle (Degree)	Remark
2462	88.27	81.55			31.87	5.5	30.65	101	306	Average
2462	92.18	85.46			31.87	5.5	30.65	101	306	Peak
2488.32	41.15	34.34	54	-12.85	31.9	5.53	30.62	101	306	Average
2488.32	52.98	46.17	74	-21.02	31.9	5.53	30.62	101	306	Peak
4924	40.84	32.59	54	-13.16	33.99	8.28	34.02	133	325	Average
4924	47.21	38.96	74	-26.79	33.99	8.28	34.02	133	325	Peak

Remarks:

- Emission Level = Read Level + Antenna Factor + Cable Loss - Preamp Factor  
Margin value = Emission level – Limit value
- 2462 MHz: Fundamental frequency.
- The emission levels of other frequencies were very low against the limit.

802.11g

EUT Test Condition		Measurement Detail	
Channel	Channel 1	Frequency Range	1 GHz ~ 25 GHz
Input Power	120 Vac, 60 Hz	Detector Function	Peak (PK) Average (AV)
Environmental Conditions	25 deg. C, 65 % RH	Tested By	Harry Hsueh

Antennal Polarity & Test Distance: Horizontal at 3 m										
Frequency (MHz)	Emission Level (dBuV/m)	Read Level (dBuV)	Limit (dBuV/m)	Margin (dB)	Antenna Factor (dB/m)	Cable Loss (dB)	Preamp Factor (dB)	Antenna Height (cm)	Table Angle (Degree)	Remark
2389.92	46.61	40.14	54	-7.39	31.8	5.4	30.73	141	232	Average
2389.92	59.19	52.72	74	-14.81	31.8	5.4	30.73	141	232	Peak
2412	94.77	88.26			31.81	5.43	30.73	141	232	Average
2412	101.77	95.26			31.81	5.43	30.73	141	232	Peak
4824	38.7	30.57	54	-15.3	33.97	8.26	34.1	185	5	Average
4824	46.28	38.15	74	-27.72	33.97	8.26	34.1	185	5	Peak
Antennal Polarity & Test Distance: Vertical at 3 m										
Frequency (MHz)	Emission Level (dBuV/m)	Read Level (dBuV)	Limit (dBuV/m)	Margin (dB)	Antenna Factor (dB/m)	Cable Loss (dB)	Preamp Factor (dB)	Antenna Height (cm)	Table Angle (Degree)	Remark
2389.74	40.86	34.42	54	-13.14	31.8	5.4	30.76	101	306	Average
2389.74	51.71	45.27	74	-22.29	31.8	5.4	30.76	101	306	Peak
2412	84.83	78.32			31.81	5.43	30.73	101	306	Average
2412	91.43	84.92			31.81	5.43	30.73	101	306	Peak
4824	38.76	30.63	54	-15.24	33.97	8.26	34.1	145	168	Average
4824	46.52	38.39	74	-27.48	33.97	8.26	34.1	145	168	Peak

Remarks:

- Emission Level = Read Level + Antenna Factor + Cable Loss - Preamp Factor  
Margin value = Emission level – Limit value
- 2412 MHz: Fundamental frequency.
- The emission levels of other frequencies were very low against the limit.

EUT Test Condition		Measurement Detail	
Channel	Channel 6	Frequency Range	1 GHz ~ 25 GHz
Input Power	120 Vac, 60 Hz	Detector Function	Peak (PK) Average (AV)
Environmental Conditions	25 deg. C, 65 % RH	Tested By	Harry Hsueh

Antennal Polarity & Test Distance: Horizontal at 3 m										
Frequency (MHz)	Emission Level (dBuV/m)	Read Level (dBuV)	Limit (dBuV/m)	Margin (dB)	Antenna Factor (dB/m)	Cable Loss (dB)	Preamp Factor (dB)	Antenna Height (cm)	Table Angle (Degree)	Remark
2389.92	48.78	42.31	54	-5.22	31.8	5.4	30.73	141	232	Average
2389.92	63.03	56.56	74	-10.97	31.8	5.4	30.73	141	232	Peak
2437	99.84	93.22			31.85	5.46	30.69	141	232	Average
2437	107.64	101.02			31.85	5.46	30.69	141	232	Peak
2483.8	49.87	43.11	54	-4.13	31.88	5.5	30.62	141	232	Average
2483.8	64.58	57.82	74	-9.42	31.88	5.5	30.62	141	232	Peak
4874	38.39	30.2	54	-15.61	33.98	8.27	34.06	115	28	Average
4874	46.51	38.32	74	-27.49	33.98	8.27	34.06	115	28	Peak
Antennal Polarity & Test Distance: Vertical at 3 m										
Frequency (MHz)	Emission Level (dBuV/m)	Read Level (dBuV)	Limit (dBuV/m)	Margin (dB)	Antenna Factor (dB/m)	Cable Loss (dB)	Preamp Factor (dB)	Antenna Height (cm)	Table Angle (Degree)	Remark
2389.83	41.52	35.05	54	-12.48	31.8	5.4	30.73	101	306	Average
2389.83	53.62	47.15	74	-20.38	31.8	5.4	30.73	101	306	Peak
2437	88.57	81.95			31.85	5.46	30.69	101	306	Average
2437	96.08	89.46			31.85	5.46	30.69	101	306	Peak
2483.56	42.31	35.55	54	-11.69	31.88	5.5	30.62	101	306	Average
2483.56	55.58	48.82	74	-18.42	31.88	5.5	30.62	101	306	Peak
4874	38.46	30.27	54	-15.54	33.98	8.27	34.06	146	326	Average
4874	46.04	37.85	74	-27.96	33.98	8.27	34.06	146	326	Peak

Remarks:

- Emission Level = Read Level + Antenna Factor + Cable Loss - Preamp Factor  
Margin value = Emission level – Limit value
- 2437 MHz: Fundamental frequency.
- The emission levels of other frequencies were very low against the limit.

EUT Test Condition		Measurement Detail	
Channel	Channel 11	Frequency Range	1 GHz ~ 25 GHz
Input Power	120 Vac, 60 Hz	Detector Function	Peak (PK) Average (AV)
Environmental Conditions	25 deg. C, 65 % RH	Tested By	Harry Hsueh

Antennal Polarity & Test Distance: Horizontal at 3 m										
Frequency (MHz)	Emission Level (dBuV/m)	Read Level (dBuV)	Limit (dBuV/m)	Margin (dB)	Antenna Factor (dB/m)	Cable Loss (dB)	Preamp Factor (dB)	Antenna Height (cm)	Table Angle (Degree)	Remark
2462	94.19	87.47			31.87	5.5	30.65	126	232	Average
2462	102.76	96.04			31.87	5.5	30.65	126	232	Peak
2483.52	48.41	41.65	54	-5.59	31.88	5.5	30.62	126	232	Average
2483.52	65.14	58.38	74	-8.86	31.88	5.5	30.62	126	232	Peak
4924	38.36	30.11	54	-15.64	33.99	8.28	34.02	122	2	Average
4924	47.36	39.11	74	-26.64	33.99	8.28	34.02	122	2	Peak
Antennal Polarity & Test Distance: Vertical at 3 m										
Frequency (MHz)	Emission Level (dBuV/m)	Read Level (dBuV)	Limit (dBuV/m)	Margin (dB)	Antenna Factor (dB/m)	Cable Loss (dB)	Preamp Factor (dB)	Antenna Height (cm)	Table Angle (Degree)	Remark
2462	82.82	76.1			31.87	5.5	30.65	101	306	Average
2462	91.52	84.8			31.87	5.5	30.65	101	306	Peak
2483.6	42.29	35.53	54	-11.71	31.88	5.5	30.62	101	306	Average
2483.6	54.37	47.61	74	-19.63	31.88	5.5	30.62	101	306	Peak
4924	38.59	30.34	54	-15.41	33.99	8.28	34.02	122	320	Average
4924	46.92	38.67	74	-27.08	33.99	8.28	34.02	122	320	Peak

Remarks:

- Emission Level = Read Level + Antenna Factor + Cable Loss - Preamp Factor  
Margin value = Emission level – Limit value
- 2462 MHz: Fundamental frequency.
- The emission levels of other frequencies were very low against the limit.

802.11n (HT20)

EUT Test Condition		Measurement Detail	
Channel	Channel 1	Frequency Range	1 GHz ~ 25 GHz
Input Power	120 Vac, 60 Hz	Detector Function	Peak (PK) Average (AV)
Environmental Conditions	25 deg. C, 65 % RH	Tested By	Karl Lee

**Antennal Polarity & Test Distance: Horizontal at 3 m**

Frequency (MHz)	Emission Level (dBuV/m)	Read Level (dBuV)	Limit (dBuV/m)	Margin (dB)	Antenna Factor (dB/m)	Cable Loss (dB)	Preamp Factor (dB)	Antenna Height (cm)	Table Angle (Degree)	Remark
2389.92	45.56	39.09	54	-8.44	31.8	5.4	30.73	199	187	Average
2389.92	55.05	48.58	74	-18.95	31.8	5.4	30.73	199	187	Peak
2412	96.26	89.75			31.81	5.43	30.73	162	186	Average
2412	104.19	97.68			31.81	5.43	30.73	162	186	Peak
4824	38.75	30.62	54	-15.25	33.97	8.26	34.1	100	200	Average
4824	46.2	38.07	74	-27.8	33.97	8.26	34.1	100	200	Peak

**Antennal Polarity & Test Distance: Vertical at 3 m**

Frequency (MHz)	Emission Level (dBuV/m)	Read Level (dBuV)	Limit (dBuV/m)	Margin (dB)	Antenna Factor (dB/m)	Cable Loss (dB)	Preamp Factor (dB)	Antenna Height (cm)	Table Angle (Degree)	Remark
2389.83	40.56	34.09	54	-13.44	31.8	5.4	30.73	162	117	Average
2389.83	51.41	44.94	74	-22.59	31.8	5.4	30.73	162	117	Peak
2412	88.72	82.21			31.81	5.43	30.73	145	103	Average
2412	96.76	90.25			31.81	5.43	30.73	145	103	Peak
4824	38.71	30.58	54	-15.29	33.97	8.26	34.1	105	255	Average
4824	46.82	38.69	74	-27.18	33.97	8.26	34.1	105	255	Peak

Remarks:

- Emission Level = Read Level + Antenna Factor + Cable Loss - Preamp Factor  
Margin value = Emission level – Limit value
- 2412 MHz: Fundamental frequency.
- The emission levels of other frequencies were very low against the limit.



EUT Test Condition		Measurement Detail	
Channel	Channel 6	Frequency Range	1 GHz ~ 25 GHz
Input Power	120 Vac, 60 Hz	Detector Function	Peak (PK) Average (AV)
Environmental Conditions	25 deg. C, 65 % RH	Tested By	Karl Lee

Antennal Polarity & Test Distance: Horizontal at 3 m										
Frequency (MHz)	Emission Level (dBuV/m)	Read Level (dBuV)	Limit (dBuV/m)	Margin (dB)	Antenna Factor (dB/m)	Cable Loss (dB)	Preamp Factor (dB)	Antenna Height (cm)	Table Angle (Degree)	Remark
2389.11	41.97	35.53	54	-12.03	31.8	5.4	30.76	154	186	Average
2389.11	52.79	46.35	74	-21.21	31.8	5.4	30.76	154	186	Peak
2437	101.48	94.86			31.85	5.46	30.69	154	186	Average
2437	109.51	102.89			31.85	5.46	30.69	154	186	Peak
2490	41.63	34.82	54	-12.37	31.9	5.53	30.62	154	186	Average
2490	52.53	45.72	74	-21.47	31.9	5.53	30.62	154	186	Peak
4874	38.39	30.2	54	-15.61	33.98	8.27	34.06	124	298	Average
4874	45.85	37.66	74	-28.15	33.98	8.27	34.06	124	298	Peak
Antennal Polarity & Test Distance: Vertical at 3 m										
Frequency (MHz)	Emission Level (dBuV/m)	Read Level (dBuV)	Limit (dBuV/m)	Margin (dB)	Antenna Factor (dB/m)	Cable Loss (dB)	Preamp Factor (dB)	Antenna Height (cm)	Table Angle (Degree)	Remark
2385.06	40.35	33.93	54	-13.65	31.78	5.4	30.76	145	103	Average
2385.06	51.28	44.86	74	-22.72	31.78	5.4	30.76	145	103	Peak
2437	95.19	88.57			31.85	5.46	30.69	145	103	Average
2437	102.16	95.54			31.85	5.46	30.69	145	103	Peak
2489.76	40.94	34.13	54	-13.06	31.9	5.53	30.62	145	103	Average
2489.76	52.12	45.31	74	-21.88	31.9	5.53	30.62	145	103	Peak
4874	39.74	31.55	54	-14.26	33.98	8.27	34.06	133	326	Average
4874	45.91	37.72	74	-28.09	33.98	8.27	34.06	133	326	Peak

Remarks:

- Emission Level = Read Level + Antenna Factor + Cable Loss - Preamp Factor  
Margin value = Emission level – Limit value
- 2437 MHz: Fundamental frequency.
- The emission levels of other frequencies were very low against the limit.

EUT Test Condition		Measurement Detail	
Channel	Channel 11	Frequency Range	1 GHz ~ 25 GHz
Input Power	120 Vac, 60 Hz	Detector Function	Peak (PK) Average (AV)
Environmental Conditions	25 deg. C, 65 % RH	Tested By	Karl Lee

Antennal Polarity & Test Distance: Horizontal at 3 m										
Frequency (MHz)	Emission Level (dBuV/m)	Read Level (dBuV)	Limit (dBuV/m)	Margin (dB)	Antenna Factor (dB/m)	Cable Loss (dB)	Preamp Factor (dB)	Antenna Height (cm)	Table Angle (Degree)	Remark
2462	97.47	90.75			31.87	5.5	30.65	162	186	Average
2462	104	97.28			31.87	5.5	30.65	162	186	Peak
2483.6	50.69	43.93	54	-3.31	31.88	5.5	30.62	142	160	Average
2483.6	62.43	55.67	74	-11.57	31.88	5.5	30.62	142	160	Peak
4924	38.44	30.19	54	-15.56	33.99	8.28	34.02	125	117	Average
4924	46.13	37.88	74	-27.87	33.99	8.28	34.02	125	117	Peak
Antennal Polarity & Test Distance: Vertical at 3 m										
Frequency (MHz)	Emission Level (dBuV/m)	Read Level (dBuV)	Limit (dBuV/m)	Margin (dB)	Antenna Factor (dB/m)	Cable Loss (dB)	Preamp Factor (dB)	Antenna Height (cm)	Table Angle (Degree)	Remark
2462	89.88	83.16			31.87	5.5	30.65	145	103	Average
2462	96.05	89.33			31.87	5.5	30.65	145	103	Peak
2483.52	42.91	36.15	54	-11.09	31.88	5.5	30.62	145	103	Average
2483.52	54.84	48.08	74	-19.16	31.88	5.5	30.62	145	103	Peak
4924	38.61	30.36	54	-15.39	33.99	8.28	34.02	124	266	Average
4924	46.08	37.83	74	-27.92	33.99	8.28	34.02	124	266	Peak

Remarks:

- Emission Level = Read Level + Antenna Factor + Cable Loss - Preamp Factor  
Margin value = Emission level – Limit value
- 2462 MHz: Fundamental frequency.
- The emission levels of other frequencies were very low against the limit.

802.11n (HT40)

EUT Test Condition		Measurement Detail	
Channel	Channel 3	Frequency Range	1 GHz ~ 25 GHz
Input Power	120 Vac, 60 Hz	Detector Function	Peak (PK) Average (AV)
Environmental Conditions	25 deg. C, 65 % RH	Tested By	Karl Lee

**Antennal Polarity & Test Distance: Horizontal at 3 m**

Frequency (MHz)	Emission Level (dBuV/m)	Read Level (dBuV)	Limit (dBuV/m)	Margin (dB)	Antenna Factor (dB/m)	Cable Loss (dB)	Preamp Factor (dB)	Antenna Height (cm)	Table Angle (Degree)	Remark
2389.65	42.48	36.04	54	-11.52	31.8	5.4	30.76	147	186	Average
2389.65	52.29	45.85	74	-21.71	31.8	5.4	30.76	147	186	Peak
2422	90.75	84.18			31.83	5.43	30.69	162	186	Average
2422	98.53	91.96			31.83	5.43	30.69	162	186	Peak
2493.76	41.52	34.67	54	-12.48	31.9	5.53	30.58	162	186	Average
2493.76	51.9	45.05	74	-22.1	31.9	5.53	30.58	162	186	Peak
4844	39.13	30.98	54	-14.87	33.97	8.26	34.08	151	188	Average
4844	46.19	38.04	74	-27.81	33.97	8.26	34.08	151	188	Peak

**Antennal Polarity & Test Distance: Vertical at 3 m**

Frequency (MHz)	Emission Level (dBuV/m)	Read Level (dBuV)	Limit (dBuV/m)	Margin (dB)	Antenna Factor (dB/m)	Cable Loss (dB)	Preamp Factor (dB)	Antenna Height (cm)	Table Angle (Degree)	Remark
2388.93	40.88	34.44	54	-13.12	31.8	5.4	30.76	145	103	Average
2388.93	52.73	46.29	74	-21.27	31.8	5.4	30.76	145	103	Peak
2422	82.9	76.33			31.83	5.43	30.69	145	103	Average
2422	91.72	85.15			31.83	5.43	30.69	145	103	Peak
2491.2	41.33	34.52	54	-12.67	31.9	5.53	30.62	145	103	Average
2491.2	51.8	44.99	74	-22.2	31.9	5.53	30.62	145	103	Peak
4844	39.38	31.23	54	-14.62	33.97	8.26	34.08	104	307	Average
4844	46.89	38.74	74	-27.11	33.97	8.26	34.08	104	307	Peak

Remarks:

- Emission Level = Read Level + Antenna Factor + Cable Loss - Preamp Factor  
Margin value = Emission level – Limit value
- 2422 MHz: Fundamental frequency.
- The emission levels of other frequencies were very low against the limit.

EUT Test Condition		Measurement Detail	
Channel	Channel 6	Frequency Range	1 GHz ~ 25 GHz
Input Power	120 Vac, 60 Hz	Detector Function	Peak (PK) Average (AV)
Environmental Conditions	25 deg. C, 65 % RH	Tested By	Karl Lee

Antennal Polarity & Test Distance: Horizontal at 3 m										
Frequency (MHz)	Emission Level (dBuV/m)	Read Level (dBuV)	Limit (dBuV/m)	Margin (dB)	Antenna Factor (dB/m)	Cable Loss (dB)	Preamp Factor (dB)	Antenna Height (cm)	Table Angle (Degree)	Remark
2389.2	44.85	38.41	54	-9.15	31.8	5.4	30.76	142	186	Average
2389.2	54.44	48	74	-19.56	31.8	5.4	30.76	142	186	Peak
2437	94.25	87.63			31.85	5.46	30.69	154	186	Average
2437	101.61	94.99			31.85	5.46	30.69	154	186	Peak
2484.4	43.77	36.98	54	-10.23	31.88	5.53	30.62	154	186	Average
2484.4	54.26	47.47	74	-19.74	31.88	5.53	30.62	154	186	Peak
4874	38.45	30.26	54	-15.55	33.98	8.27	34.06	175	144	Average
4874	45.95	37.76	74	-28.05	33.98	8.27	34.06	175	144	Peak
Antennal Polarity & Test Distance: Vertical at 3 m										
Frequency (MHz)	Emission Level (dBuV/m)	Read Level (dBuV)	Limit (dBuV/m)	Margin (dB)	Antenna Factor (dB/m)	Cable Loss (dB)	Preamp Factor (dB)	Antenna Height (cm)	Table Angle (Degree)	Remark
2389.47	40.86	34.42	54	-13.14	31.8	5.4	30.76	145	103	Average
2389.47	51.4	44.96	74	-22.6	31.8	5.4	30.76	145	103	Peak
2437	86.74	80.12			31.85	5.46	30.69	145	103	Average
2437	94.2	87.58			31.85	5.46	30.69	145	103	Peak
2487.24	41.47	34.68	54	-12.53	31.88	5.53	30.62	145	103	Average
2487.24	51.91	45.12	74	-22.09	31.88	5.53	30.62	145	103	Peak
4874	38.45	30.26	54	-15.55	33.98	8.27	34.06	105	355	Average
4874	46.09	37.9	74	-27.91	33.98	8.27	34.06	105	355	Peak

Remarks:

1. Emission Level = Read Level + Antenna Factor + Cable Loss - Preamp Factor  
Margin value = Emission level – Limit value
2. 2437 MHz: Fundamental frequency.
3. The emission levels of other frequencies were very low against the limit.

EUT Test Condition		Measurement Detail	
Channel	Channel 9	Frequency Range	1 GHz ~ 25 GHz
Input Power	120 Vac, 60 Hz	Detector Function	Peak (PK) Average (AV)
Environmental Conditions	25 deg. C, 65 % RH	Tested By	Karl Lee

Antennal Polarity & Test Distance: Horizontal at 3 m										
Frequency (MHz)	Emission Level (dBuV/m)	Read Level (dBuV)	Limit (dBuV/m)	Margin (dB)	Antenna Factor (dB/m)	Cable Loss (dB)	Preamp Factor (dB)	Antenna Height (cm)	Table Angle (Degree)	Remark
2388.66	41.48	35.04	54	-12.52	31.8	5.4	30.76	154	186	Average
2388.66	51.95	45.51	74	-22.05	31.8	5.4	30.76	154	186	Peak
2452	93.65	86.99			31.85	5.46	30.65	154	186	Average
2452	100.29	93.63			31.85	5.46	30.65	154	186	Peak
2484.48	47.19	40.4	54	-6.81	31.88	5.53	30.62	154	186	Average
2484.48	59.1	52.31	74	-14.9	31.88	5.53	30.62	154	186	Peak
4904	40.1	31.88	54	-13.9	33.98	8.28	34.04	142	5	Average
4904	46.08	37.86	74	-27.92	33.98	8.28	34.04	142	5	Peak

Antennal Polarity & Test Distance: Vertical at 3 m										
Frequency (MHz)	Emission Level (dBuV/m)	Read Level (dBuV)	Limit (dBuV/m)	Margin (dB)	Antenna Factor (dB/m)	Cable Loss (dB)	Preamp Factor (dB)	Antenna Height (cm)	Table Angle (Degree)	Remark
2385.51	40.94	34.5	54	-13.06	31.8	5.4	30.76	145	103	Average
2385.51	51.4	44.96	74	-22.6	31.8	5.4	30.76	145	103	Peak
2452	85.58	78.92			31.85	5.46	30.65	145	103	Average
2452	92.08	85.42			31.85	5.46	30.65	145	103	Peak
2484.64	42.63	35.84	54	-11.37	31.88	5.53	30.62	145	103	Average
2484.64	52.79	46	74	-21.21	31.88	5.53	30.62	145	103	Peak
4904	39.58	31.36	54	-14.42	33.98	8.28	34.04	125	174	Average
4904	46.65	38.43	74	-27.35	33.98	8.28	34.04	125	174	Peak

Remarks:

- Emission Level = Read Level + Antenna Factor + Cable Loss - Preamp Factor  
Margin value = Emission level – Limit value
- 2452 MHz: Fundamental frequency.
- The emission levels of other frequencies were very low against the limit.

**9 kHz ~ 30 MHz Data:**

The amplitude of spurious emissions attenuated more than 20 dB below the permissible value is not required to be report.

**30 MHz ~ 1 GHz Worst-Case Data:**

**802.11b**

EUT Test Condition		Measurement Detail	
Channel	Channel 1	Frequency Range	30 MHz ~ 1 GHz
Input Power	120 Vac, 60 Hz	Detector Function	Peak (PK) Quasi-peak (QP)
Environmental Conditions	25 deg. C, 65 % RH	Tested By	Karl Lee

**Horizontal**

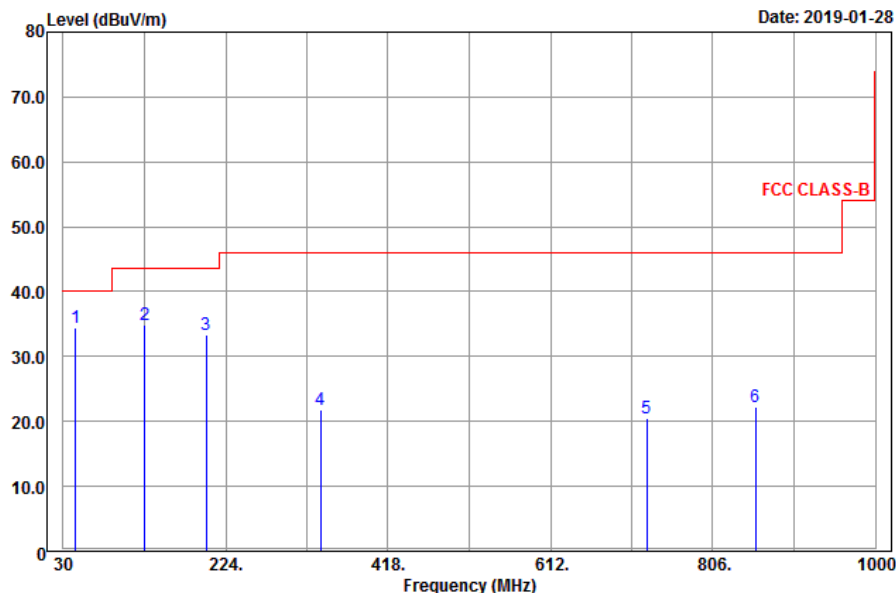

**Vertical**

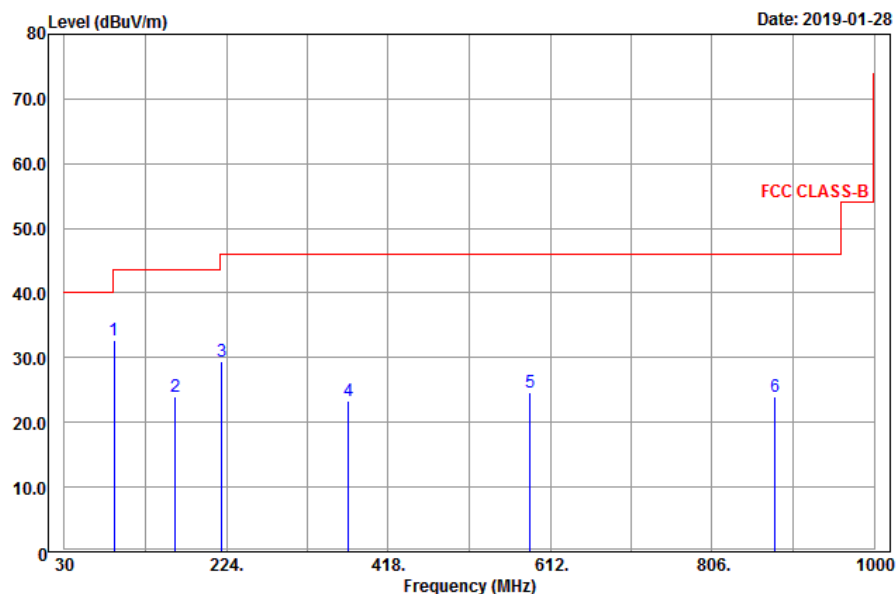

Antennal Polarity & Test Distance: Horizontal at 3 m										
Frequency (MHz)	Emission Level (dBuV/m)	Read Level (dBuV)	Limit (dBuV/m)	Margin (dB)	Antenna Factor (dB/m)	Cable Loss (dB)	Preamp Factor (dB)	Antenna Height (cm)	Table Angle (Degree)	Remark
44.58	34.48	51.51	40	-5.52	14.29	0.9	32.22	197	121	Peak
127.74	34.83	56.48	43.5	-8.67	9.2	1.38	32.23	165	219	Peak
200.91	33.32	52.87	43.5	-10.18	11.09	1.65	32.29	178	154	Peak
337.1	21.7	37.59	46	-24.3	14	2.19	32.08	149	136	Peak
727	20.45	29.82	46	-25.55	19.59	3.16	32.12	133	251	Peak
857.2	22.3	29.49	46	-23.7	21.12	3.44	31.75	159	246	Peak
Antennal Polarity & Test Distance: Vertical at 3 m										
Frequency (MHz)	Emission Level (dBuV/m)	Read Level (dBuV)	Limit (dBuV/m)	Margin (dB)	Antenna Factor (dB/m)	Cable Loss (dB)	Preamp Factor (dB)	Antenna Height (cm)	Table Angle (Degree)	Remark
89.4	32.65	53.09	43.5	-10.85	10.21	1.11	31.76	196	154	Peak
162.84	23.91	45.8	43.5	-19.59	8.85	1.52	32.26	174	124	Peak
218.73	29.43	48.68	46	-16.57	11.32	1.65	32.22	150	166	Peak
370.7	23.38	38.77	46	-22.62	14.48	2.26	32.13	100	112	Peak
587.7	24.68	36.3	46	-21.32	17.75	2.82	32.19	160	324	Peak
881.7	24.08	30.85	46	-21.92	21.34	3.49	31.6	184	127	Peak

Remarks:

- Emission Level = Read Level + Antenna Factor + Cable Loss - Preamp Factor  
Margin value = Emission level – Limit value.
- The emission levels of other frequencies were very low against the limit.

## 4.2 Conducted Emission Measurement

### 4.2.1 Limits of Conducted Emission Measurement

Frequency (MHz)	Conducted Limit (dBuV)	
	Quasi-Peak	Average
0.15 - 0.5	66 - 56	56 - 46
0.50 - 5.0	56	46
5.0 - 30.0	60	50

- Note: 1. The lower limit shall apply at the transition frequencies.  
 2. The limit decreases in line with the logarithm of the frequency in the range of 0.15 to 0.50 MHz.

### 4.2.2 Test Instruments

Description & Manufacturer	Model No.	Serial No.	Date of Calibration	Due Date of Calibration
Test Receiver ROHDE & SCHWARZ	ESCS 30	100288	Jan. 03, 2019	Jan. 02, 2020
RF signal cable Woken	5D-FB	Cable-cond1-01	Sep. 05, 2018	Sep. 04, 2019
LISN ROHDE & SCHWARZ (EUT)	ENV216	101826	Feb. 21, 2019	Feb. 20, 2020
LISN ROHDE & SCHWARZ (Peripheral)	ESH3-Z5	100311	Aug. 19, 2018	Aug. 18, 2019
Software ADT	BV ADT_Cond_ V7.3.7.4	NA	NA	NA

- Note: 1. The calibration interval of the above test instruments is 12 months and the calibrations are traceable to NML/ROC and NIST/USA.  
 2. The test was performed in HwaYa Shielded Room 1.  
 3. The VCCI Site Registration No. is C-12040.



#### 4.2.3 Test Procedures

- a. The EUT was placed 0.4 meters from the conducting wall of the shielded room with EUT being connected to the power mains through a line impedance stabilization network (LISN). Other support units were connected to the power mains through another LISN. The two LISNs provide 50 ohm/50 uH of coupling impedance for the measuring instrument.
- b. Both lines of the power mains connected to the EUT were checked for maximum conducted interference.
- c. The frequency range from 150 kHz to 30 MHz was searched. Emission levels under (Limit – 20 dB) was not recorded.

**Note:** The resolution bandwidth and video bandwidth of test receiver is 9 kHz for quasi-peak detection (QP) and average detection (AV) at frequency 0.15 MHz – 30 MHz.

#### 4.2.4 Deviation from Test Standard

No deviation.

#### 4.2.5 Test Setup

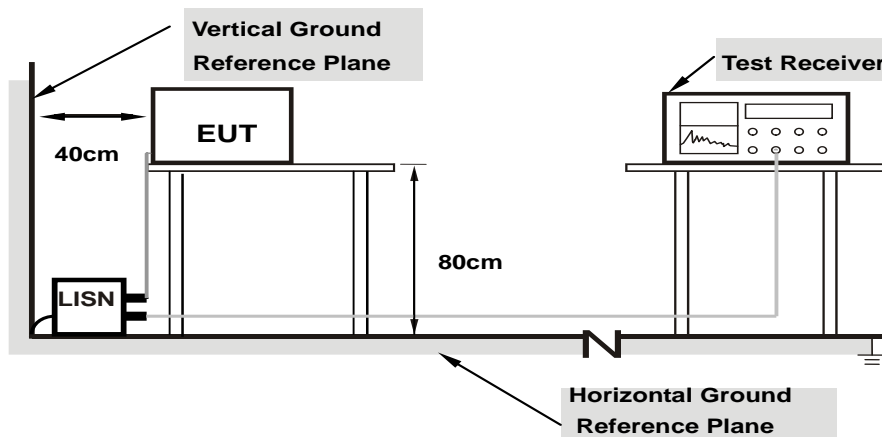

**Note:** 1.Support units were connected to second LISN.

For the actual test configuration, please refer to the attached file (Test Setup Photo).

#### 4.2.6 EUT Operating Conditions

- a. Placed the EUT on a testing table.
- b. Use the software to control the EUT under transmission condition continuously at specific channel frequency.

#### 4.2.7 Test Results

Frequency Range	150kHz ~ 30MHz	Detector Function & Resolution Bandwidth	Quasi-Peak (QP) / Average (AV), 9kHz
Input Power	120Vac, 60Hz	Environmental Conditions	25°C, 65%RH
Tested by	Jisyong Wang	Test Date	2019/4/16

Phase Of Power : Line (L)										
No	Frequency (MHz)	Correction Factor (dB)	Reading Value (dBuV)		Emission Level (dBuV)		Limit (dBuV)		Margin (dB)	
			Q.P.	AV.	Q.P.	AV.	Q.P.	AV.	Q.P.	AV.
1	0.16139	0.10	30.29	10.79	30.39	10.89	65.39	55.39	-35.00	-44.50
2	0.18519	0.10	27.38	5.36	27.48	5.46	64.25	54.25	-36.77	-48.79
3	0.23216	0.10	34.61	5.94	34.71	6.04	62.37	52.37	-27.66	-46.33
4	1.30736	0.13	19.62	5.99	19.75	6.12	56.00	46.00	-36.25	-39.88
5	11.24658	0.66	19.06	5.99	19.72	6.65	60.00	50.00	-40.28	-43.35
6	22.12029	1.18	23.57	5.98	24.75	7.16	60.00	50.00	-35.25	-42.84

Remarks:

1. Q.P. and AV. are abbreviations of quasi-peak and average individually.
2. The emission levels of other frequencies were very low against the limit.
3. Margin value = Emission level – Limit value
4. Correction factor = Insertion loss + Cable loss
5. Emission Level = Correction Factor + Reading Value

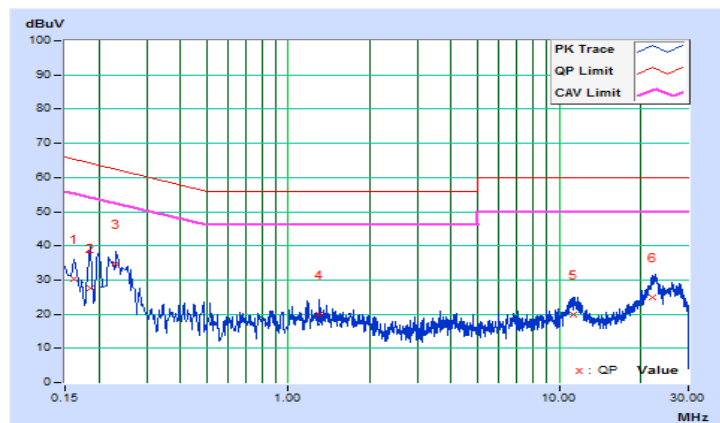

Frequency Range	150kHz ~ 30MHz	Detector Function & Resolution Bandwidth	Quasi-Peak (QP) / Average (AV), 9kHz
Input Power	120Vac, 60Hz	Environmental Conditions	25°C, 65%RH
Tested by	Jisyong Wang	Test Date	2019/4/16

Phase Of Power : Neutral (N)										
No	Frequency (MHz)	Correction Factor (dB)	Reading Value (dBuV)		Emission Level (dBuV)		Limit (dBuV)		Margin (dB)	
			Q.P.	AV.	Q.P.	AV.	Q.P.	AV.	Q.P.	AV.
1	0.17346	0.09	41.90	5.32	41.99	5.41	64.79	54.79	-22.80	-49.38
2	0.21256	0.09	34.93	5.05	35.02	5.14	63.10	53.10	-28.08	-47.96
3	0.25166	0.09	33.17	18.07	33.26	18.16	61.70	51.70	-28.44	-33.54
4	0.70522	0.09	19.24	5.39	19.33	5.48	56.00	46.00	-36.67	-40.52
5	1.85476	0.13	19.38	4.66	19.51	4.79	56.00	46.00	-36.49	-41.21
6	10.92596	0.52	19.90	5.23	20.42	5.75	60.00	50.00	-39.58	-44.25

Remarks:

1. Q.P. and AV. are abbreviations of quasi-peak and average individually.
2. The emission levels of other frequencies were very low against the limit.
3. Margin value = Emission level – Limit value
4. Correction factor = Insertion loss + Cable loss
5. Emission Level = Correction Factor + Reading Value

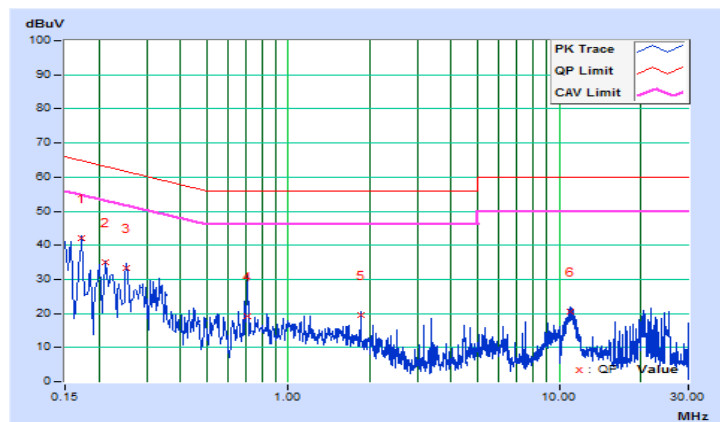

### 4.3 6 dB Bandwidth Measurement

#### 4.3.1 Limits of 6 dB Bandwidth Measurement

The minimum of 6 dB Bandwidth Measurement is 0.5 MHz.

#### 4.3.2 Test Setup

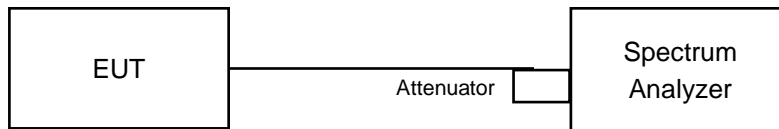

#### 4.3.3 Test Instruments

Refer to section 4.1.2 to get information of above instrument.

#### 4.3.4 Test Procedure

- Set resolution bandwidth (RBW) = 100 kHz
- Set the video bandwidth (VBW)  $\geq 3 \times$  RBW, Detector = Peak.
- Trace mode = max hold.
- Sweep = auto couple.
- Measure the maximum width of the emission that is constrained by the frequencies associated with the two amplitude points (upper and lower) that are attenuated by 6 dB relative to the maximum level measured in the fundamental emission

#### 4.3.5 Deviation from Test Standard

No deviation.

#### 4.3.6 EUT Operating Conditions

The software provided by client to enable the EUT under transmission condition continuously at lowest, middle and highest channel frequencies individually.

#### 4.3.7 Test Results

##### 802.11b

Channel	Frequency (MHz)	6 dB Bandwidth (MHz)	Minimum Limit (MHz)	Pass / Fail
1	2412	10.09	0.5	Pass
6	2437	10.09	0.5	Pass
11	2462	9.57	0.5	Pass

##### 802.11g

Channel	Frequency (MHz)	6 dB Bandwidth (MHz)	Minimum Limit (MHz)	Pass / Fail
1	2412	16.36	0.5	Pass
6	2437	16.37	0.5	Pass
11	2462	16.36	0.5	Pass

##### 802.11n (HT20)

Channel	Frequency (MHz)	6 dB Bandwidth (MHz)		Minimum Limit (MHz)	Pass / Fail
		Chain 0	Chain 1		
1	2412	17.59	17.66	0.5	Pass
6	2437	17.61	17.64	0.5	Pass
11	2462	17.60	17.63	0.5	Pass

##### 802.11n (HT40)

Channel	Frequency (MHz)	6 dB Bandwidth (MHz)		Minimum Limit (MHz)	Pass / Fail
		Chain 0	Chain 1		
3	2422	36.34	36.49	0.5	Pass
6	2437	36.38	36.48	0.5	Pass
9	2452	36.38	36.49	0.5	Pass

### Spectrum Plot of Worst Value

#### 802.11b

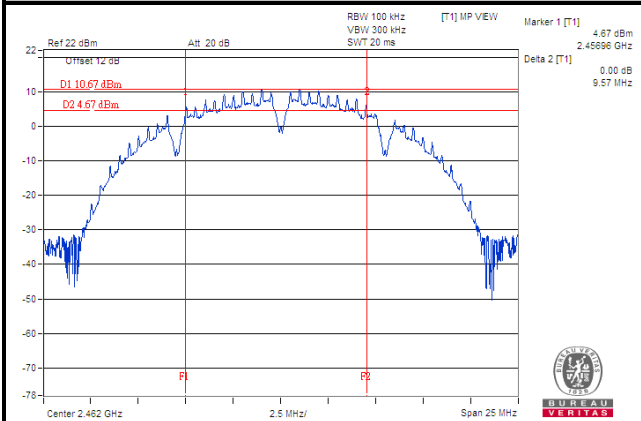

#### 802.11g

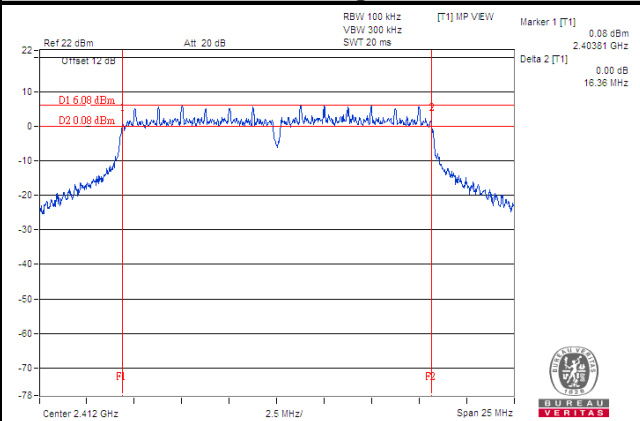

#### 802.11n (HT20)

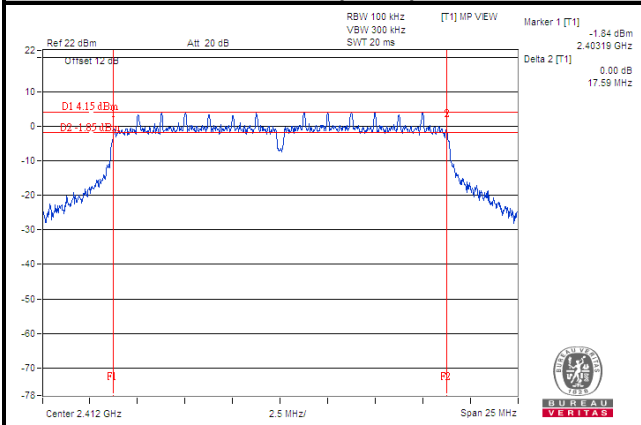

#### 802.11n (HT40)

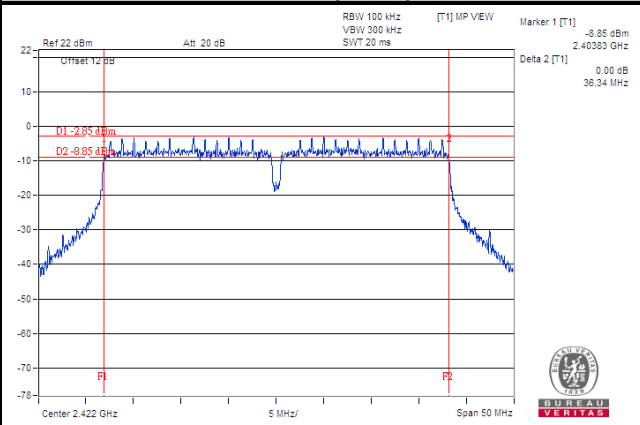

## 4.4 Occupied Bandwidth Measurement

### 4.4.1 Test Setup

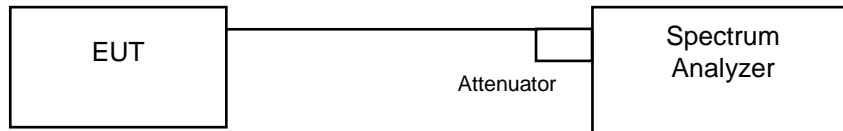

### 4.4.2 Test Instruments

Refer to section 4.1.2 to get information of above instrument.

### 4.4.3 Test Procedure

The transmitter output was connected to the spectrum analyzer through an attenuator. The bandwidth of the fundamental frequency was measured by spectrum analyzer with resolution bandwidth in the range of 1 % to 5 % of the anticipated emission bandwidth, and a video bandwidth at least 3x the resolution bandwidth and set the detector to PEAK. The width of a frequency band such that, below the lower and above the upper frequency limits, the mean powers emitted are each equal to a specified percentage 0.5 % of the total mean power of a given emission.

### 4.4.4 Deviation from Test Standard

No deviation.

### 4.4.5 EUT Operating Conditions

The software provided by client to enable the EUT under transmission condition continuously at lowest, middle and highest channel frequencies individually.

#### 4.4.6 Test Results

##### 802.11b

Channel	Frequency (MHz)	Occupied Bandwidth (MHz)	Pass / Fail
1	2412	15.18	Pass
6	2437	15.42	Pass
11	2462	15.06	Pass

##### 802.11g

Channel	Frequency (MHz)	Occupied Bandwidth (MHz)	Pass / Fail
1	2412	17.04	Pass
6	2437	20.04	Pass
11	2462	17.10	Pass

##### 802.11n (HT20)

Channel	Frequency (MHz)	Occupied Bandwidth (MHz)		Pass / Fail
		Chain 0	Chain 1	
1	2412	18.06	18.00	Pass
6	2437	18.18	18.12	Pass
11	2462	18.06	18.00	Pass

##### 802.11n (HT40)

Channel	Frequency (MHz)	Occupied Bandwidth (MHz)		Pass / Fail
		Chain 0	Chain 1	
3	2422	36.78	36.72	Pass
6	2437	36.72	36.84	Pass
9	2452	36.78	36.84	Pass





BUREAU VERITAS

### Spectrum Plot of Worst Value

#### 802.11b

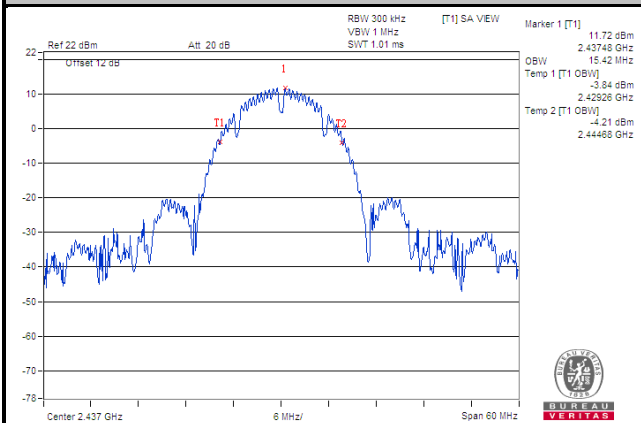

#### 802.11g

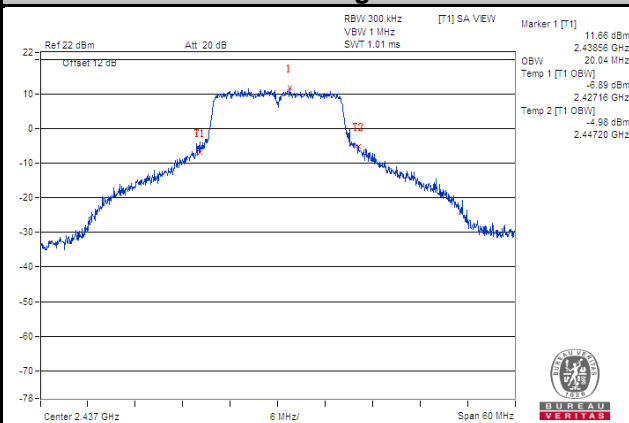

#### 802.11n (HT20)

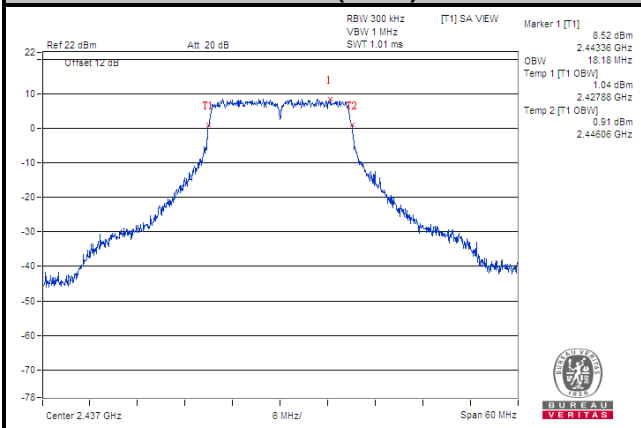

#### 802.11n (HT40)

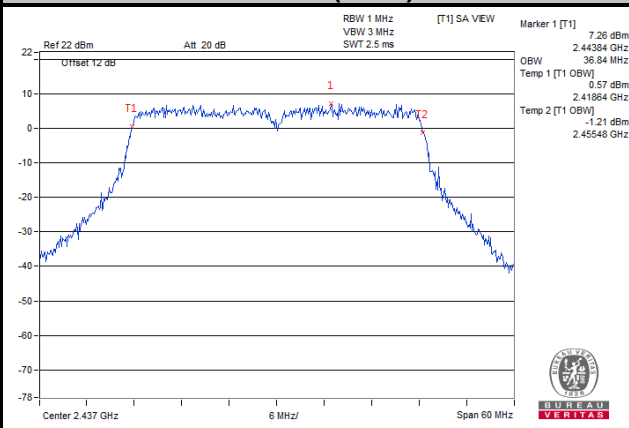

## 4.5 Conducted Output Power Measurement

### 4.5.1 Limits of Conducted Output Power Measurement

For systems using digital modulation in the 2400–2483.5 MHz bands: 1 Watt (30 dBm)

Per KDB 662911 D01 Multiple Transmitter Output Method of conducted output power measurement on IEEE 802.11 devices,

Array Gain = 0 dB (i.e., no array gain) for NANT  $\leq$  4;

Array Gain = 0 dB (i.e., no array gain) for channel widths  $\geq$  40 MHz for any NANT;

Array Gain =  $5 \log(\text{NANT}/\text{NSS})$  dB or 3 dB, whichever is less for 20 MHz channel widths with NANT  $\geq$  5.

For power measurements on all other devices: Array Gain =  $10 \log(\text{NANT}/\text{NSS})$  dB.

### 4.5.2 Test Setup

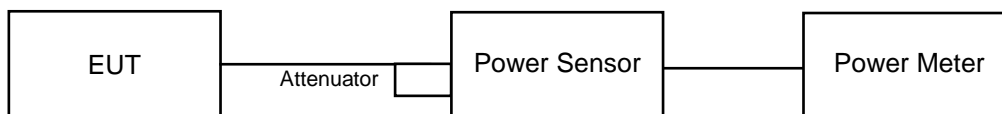

### 4.5.3 Test Instruments

Refer to section 4.1.2 to get information of above instrument.

### 4.5.4 Test Procedures

A peak power sensor was used on the output port of the EUT. A power meter was used to read the response of the peak power sensor. Record the power level.

### 4.5.5 Deviation from Test Standard

No deviation.

### 4.5.6 EUT Operating Conditions

The software provided by client to enable the EUT under transmission condition continuously at lowest, middle and highest channel frequencies individually.

#### 4.5.7 Test Results

##### 802.11b

Channel	Frequency (MHz)	Peak Power (mW)	Peak Power (dBm)	Limit (dBm)	Pass / Fail
1	2412	90.782	19.58	30	Pass
6	2437	160.694	22.06	30	Pass
11	2462	100.925	20.04	30	Pass

##### 802.11g

Channel	Frequency (MHz)	Peak Power (mW)	Peak Power (dBm)	Limit (dBm)	Pass / Fail
1	2412	125.314	20.98	30	Pass
6	2437	212.814	23.28	30	Pass
11	2462	126.765	21.03	30	Pass

##### 802.11n (HT20)

Channel	Frequency (MHz)	Peak Power (dBm)		Total Power (mW)	Total Power (dBm)	Limit (dBm)	Pass / Fail
		Chain 0	Chain 1				
1	2412	19.38	18.71	160.998	22.07	30	Pass
6	2437	21.32	21.61	280.396	24.48	30	Pass
11	2462	18.78	18.88	152.777	21.84	30	Pass

##### 802.11n (HT40)

Channel	Frequency (MHz)	Peak Power (dBm)		Total Power (mW)	Total Power (dBm)	Limit (dBm)	Pass / Fail
		Chain 0	Chain 1				
3	2422	16.11	16.50	85.500	19.32	30	Pass
6	2437	19.17	18.96	161.309	22.08	30	Pass
9	2452	19.28	18.85	161.459	22.08	30	Pass

## 4.6 Power Spectral Density Measurement

### 4.6.1 Limits of Power Spectral Density Measurement

The Maximum of Power Spectral Density Measurement is 8 dBm.

### 4.6.2 Test Setup

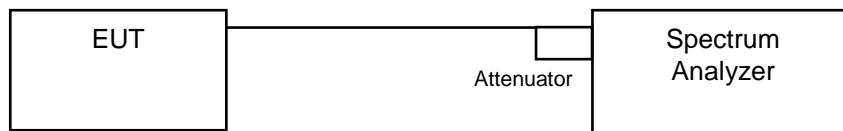

### 4.6.3 Test Instruments

Refer to section 4.1.2 to get information of above instrument.

### 4.6.4 Test Procedure

- a. Set analyzer center frequency to DTS channel center frequency.
- b. Set the span to 1.5 times the DTS bandwidth.
- c. Set the RBW to:  $3 \text{ kHz} \leq \text{RBW} \leq 100 \text{ kHz}$ .
- d. Set the VBW  $\geq 3 \times \text{RBW}$ .
- e. Detector = peak.
- f. Sweep time = auto couple.
- g. Trace mode = max hold.
- h. Allow trace to fully stabilize.
- i. Use the peak marker function to determine the maximum amplitude level within the RBW.

### 4.6.5 Deviation from Test Standard

No deviation.

### 4.6.6 EUT Operating Condition

The software provided by client to enable the EUT under transmission condition continuously at lowest, middle and highest channel frequencies individually.

#### 4.6.7 Test Results

##### 802.11b

Channel	Frequency (MHz)	PSD (dBm/3 kHz)	Limit (dBm/3 kHz)	Pass / Fail
1	2412	-3.70	8	Pass
6	2437	-2.06	8	Pass
11	2462	-2.88	8	Pass

##### 802.11g

Channel	Frequency (MHz)	PSD (dBm/3 kHz)	Limit (dBm/3 kHz)	Pass / Fail
1	2412	-8.04	8	Pass
6	2437	-4.71	8	Pass
11	2462	-7.26	8	Pass

##### 802.11n (HT20)

TX Chain	Channel	Freq. (MHz)	PSD (dBm/3 kHz)	10 log (N=2) dB	Total PSD (dBm/3 kHz)	Limit (dBm/3 kHz)	Pass / Fail
0	1	2412	-11.75	3.01	-8.74	8	Pass
	6	2437	-9.85	3.01	-6.84	8	Pass
	11	2462	-12.35	3.01	-9.34	8	Pass
1	1	2412	-12.01	3.01	-9.00	8	Pass
	6	2437	-9.44	3.01	-6.43	8	Pass
	11	2462	-12.45	3.01	-9.44	8	Pass

#### NOTE:

1. Directional gain =  $10\log[(10^{G1/20} + 10^{G2/20} + \dots + 10^{GN/20})^2 / N_{ANT}] = 2.28 \text{ dBi} < 6 \text{ dBi}$ , so the limit no need to reduced.
2. Method E) 2) c) of power density measurement of KDB 662911 is using for calculating total power density.

### 802.11n (HT40)

TX Chain	Channel	Freq. (MHz)	PSD (dBm/3 kHz)	10 log (N=2) dB	Total PSD (dBm/3 kHz)	Limit (dBm/3 kHz)	Pass / Fail
0	3	2422	-17.25	3.01	-14.24	8	Pass
	6	2437	-14.28	3.01	-11.27	8	Pass
	9	2452	-15.36	3.01	-12.35	8	Pass
1	3	2422	-17.21	3.01	-14.20	8	Pass
	6	2437	-14.59	3.01	-11.58	8	Pass
	9	2452	-16.22	3.01	-13.21	8	Pass

**NOTE:**

1. Directional gain =  $10\log[(10^{G1/20} + 10^{G2/20} + \dots + 10^{GN/20})^2 / N_{ANT}] = 2.28 \text{ dBi} < 6 \text{ dBi}$ , so the limit no need to reduced.
2. Method E) 2) c) of power density measurement of KDB 662911 is using for calculating total power density.

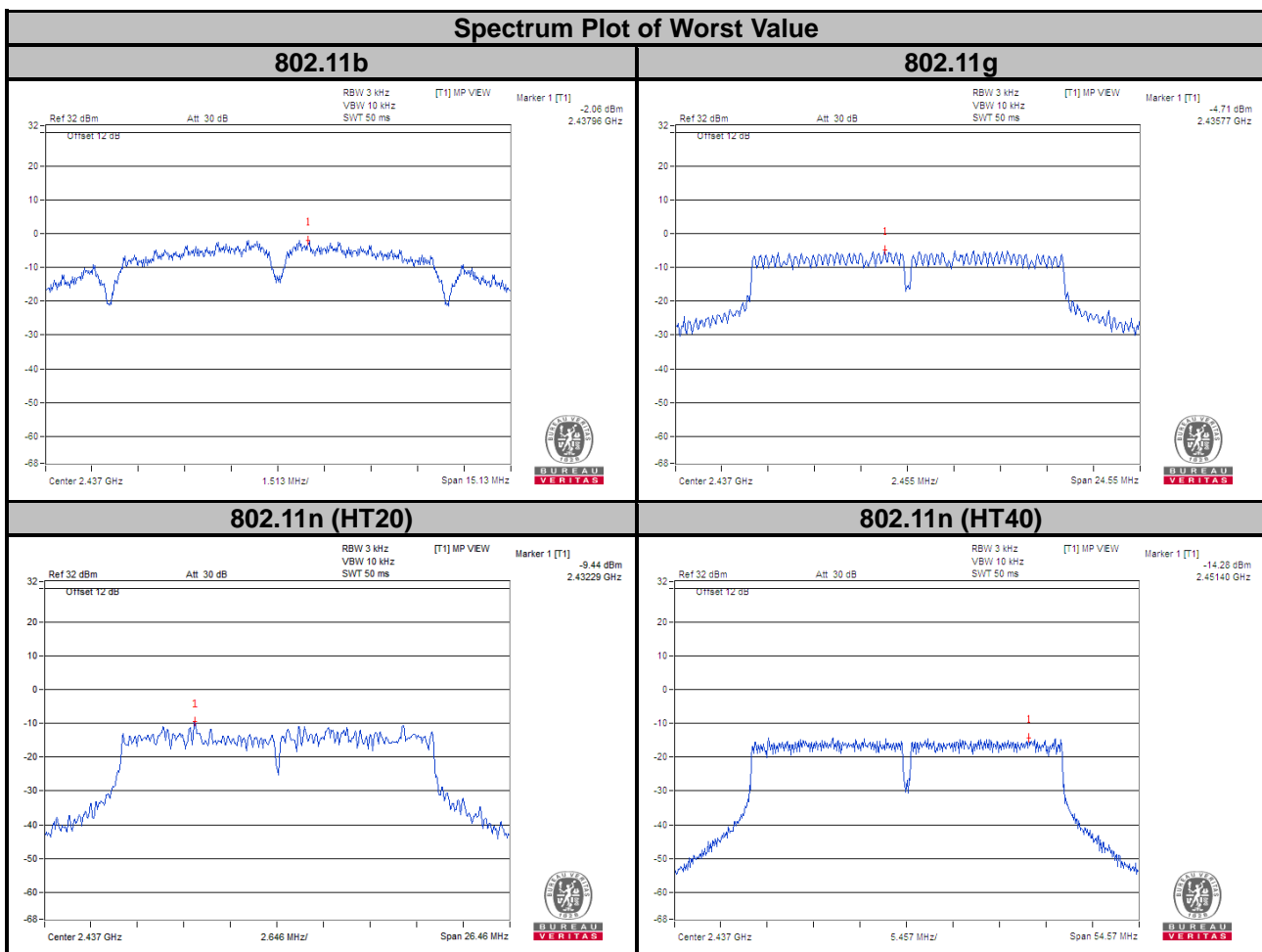

## 4.7 Conducted Out of Band Emission Measurement

### 4.7.1 Limits of Conducted Out of Band Emission Measurement

Below -20 dB of the highest emission level of operating band (in 100 kHz Resolution Bandwidth).

### 4.7.2 Test Setup

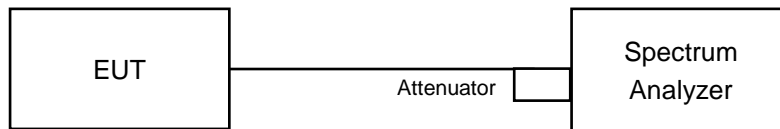

### 4.7.3 Test Instruments

Refer to section 4.1.2 to get information of above instrument.

### 4.7.4 Test Procedure

#### MEASUREMENT PROCEDURE REF

1. Set the RBW = 100 kHz.
2. Set the VBW  $\geq$  300 kHz.
3. Detector = peak.
4. Sweep time = auto couple.
5. Trace mode = max hold.
6. Allow trace to fully stabilize.
7. Use the peak marker function to determine the maximum power level in any 100 kHz band segment within the fundamental EBW.

#### MEASUREMENT PROCEDURE OOB

1. Set RBW = 100 kHz.
2. Set VBW  $\geq$  300 kHz.
3. Detector = peak.
4. Sweep = auto couple.
5. Trace Mode = max hold.
6. Allow trace to fully stabilize.
7. Use the peak marker function to determine the maximum amplitude level.

### 4.7.5 Deviation from Test Standard

No deviation.

### 4.7.6 EUT Operating Condition

The software provided by client to enable the EUT under transmission condition continuously at lowest, middle and highest channel frequencies individually.

#### 4.7.7 Test Results

The conducted emission test is performed on each TX port of operating mode without summing or adding  $10\log(N)$  since the limit is relative emission limit.

The spectrum plots are attached on the following images. D1 line indicates the highest level, and D2 line indicates the 20 dB offset below D1. It shows compliance with the requirement.



# 802.11b

## Ch 1

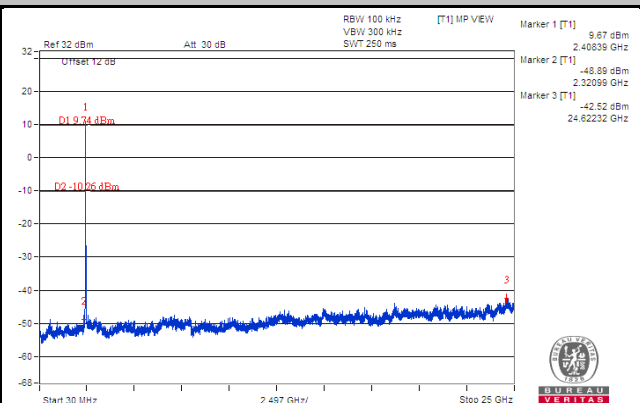
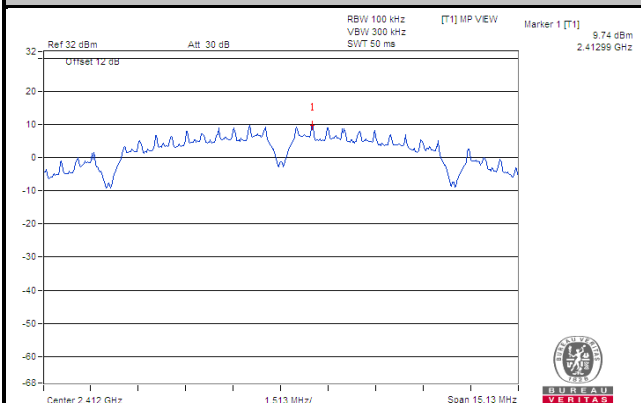

## Ch 6

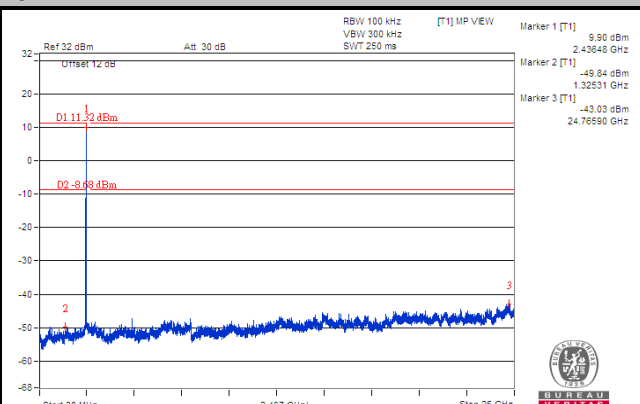
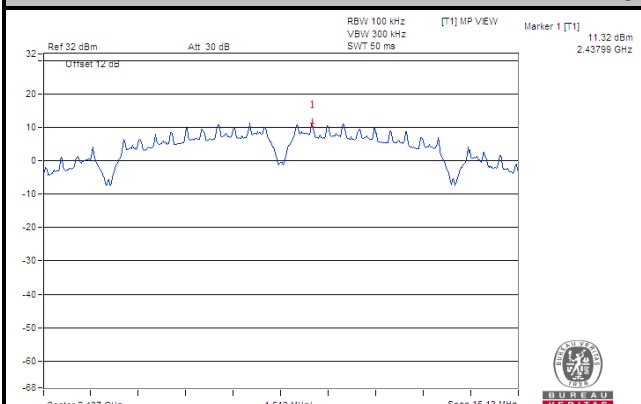

## Ch 11

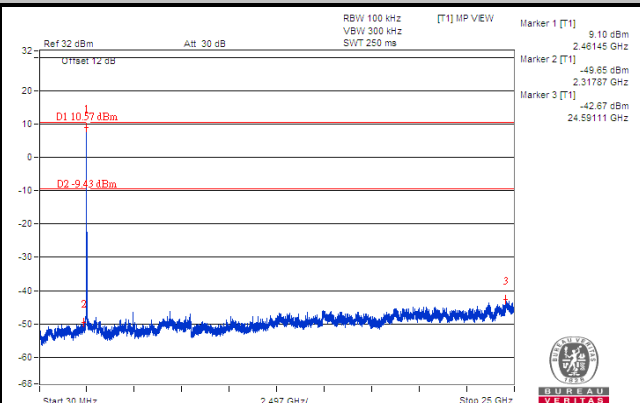
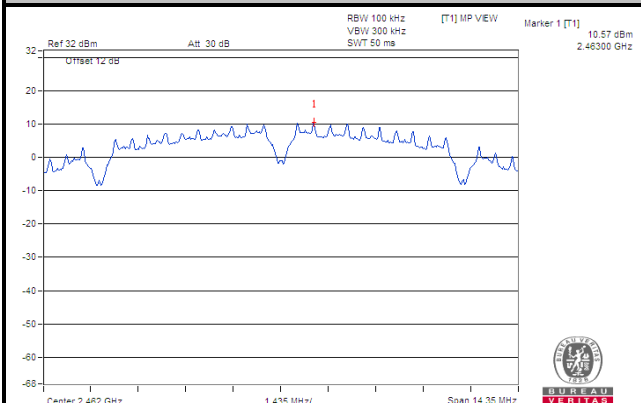

## Ch 1 Band Edge

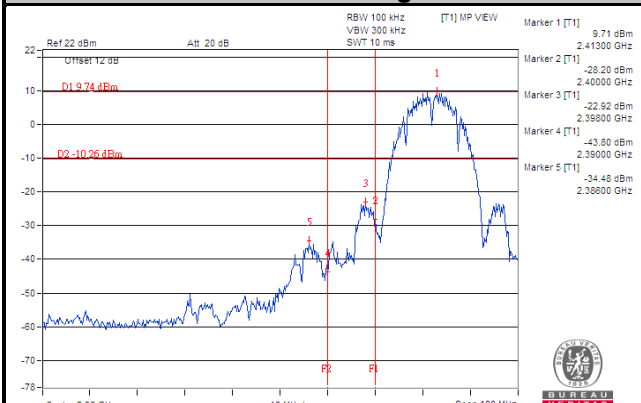

## Ch 11 Band Edge

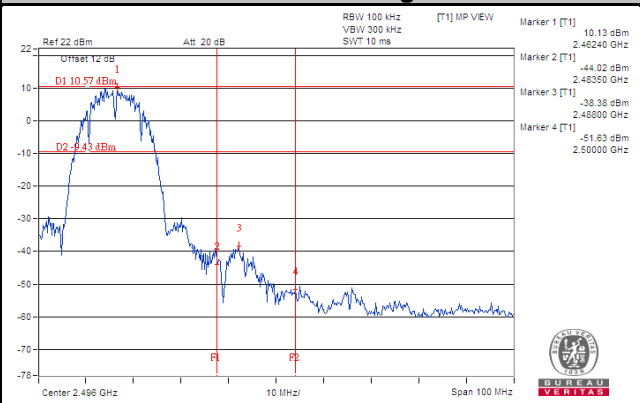

802.11g

Ch 1

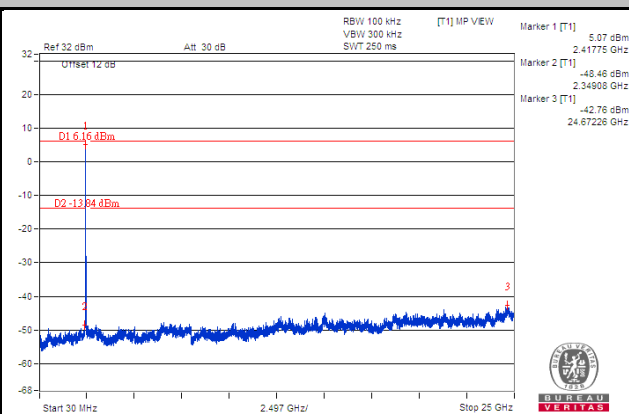
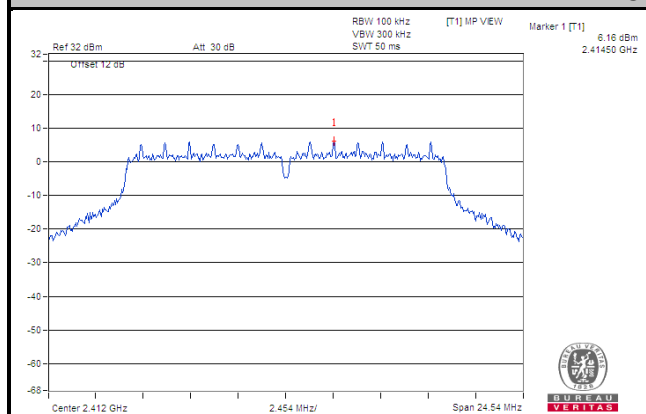

Ch 6

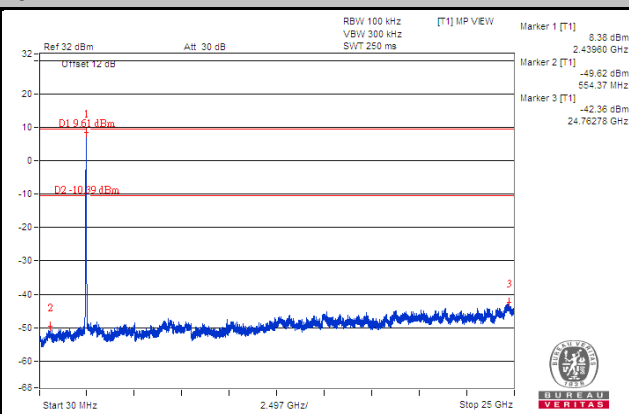
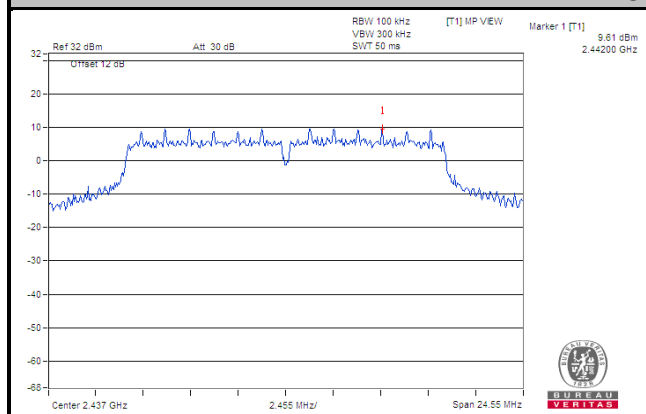

Ch 11

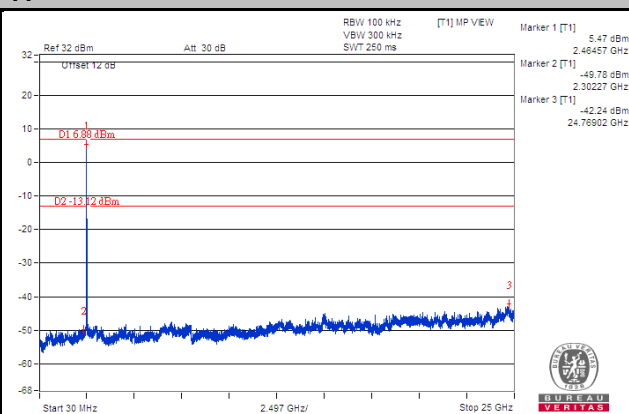
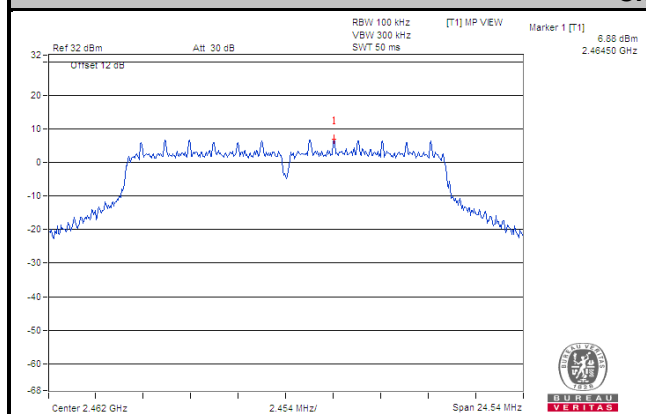

Ch 1 Band Edge

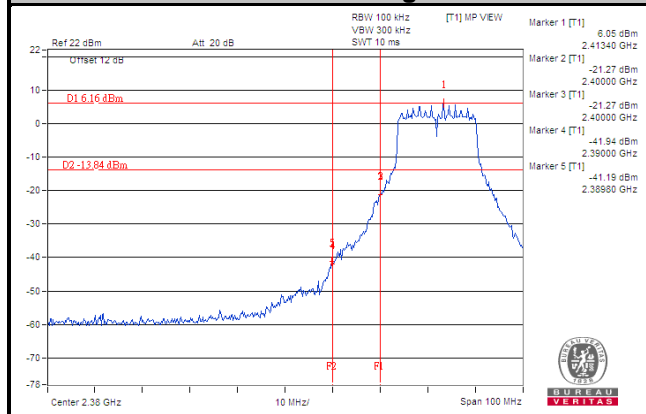

Ch 11 Band Edge

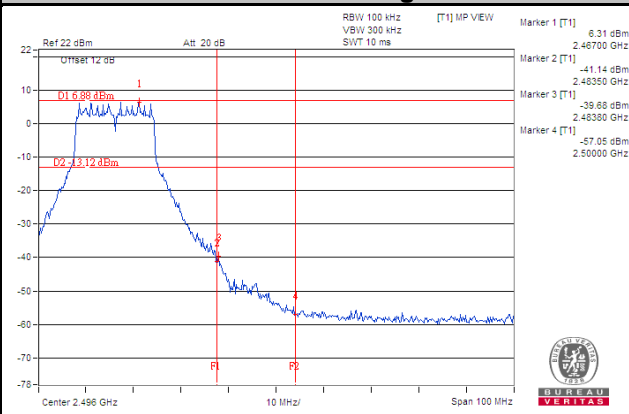

**802.11n (HT20)**  
**CHAIN 0**

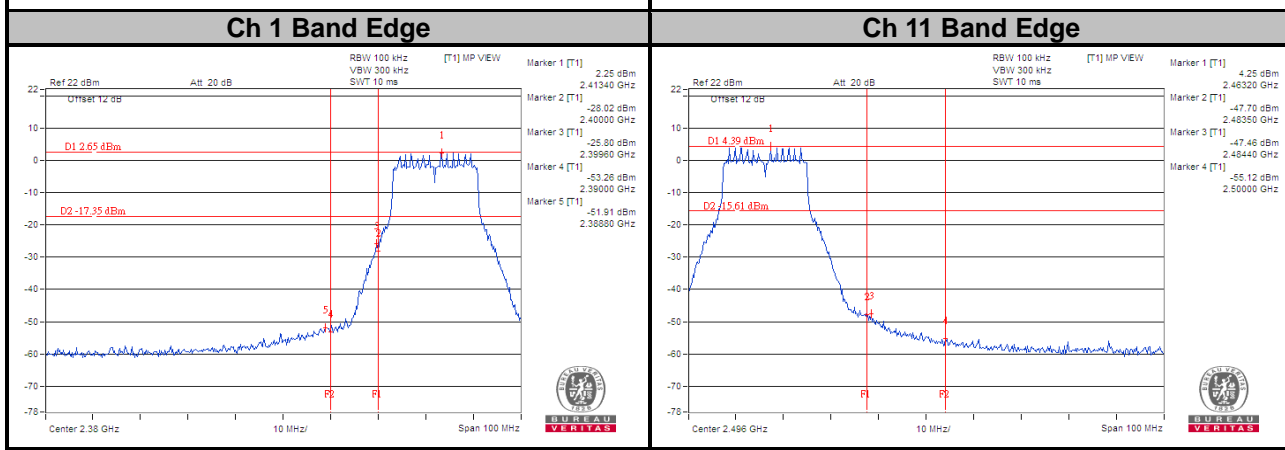
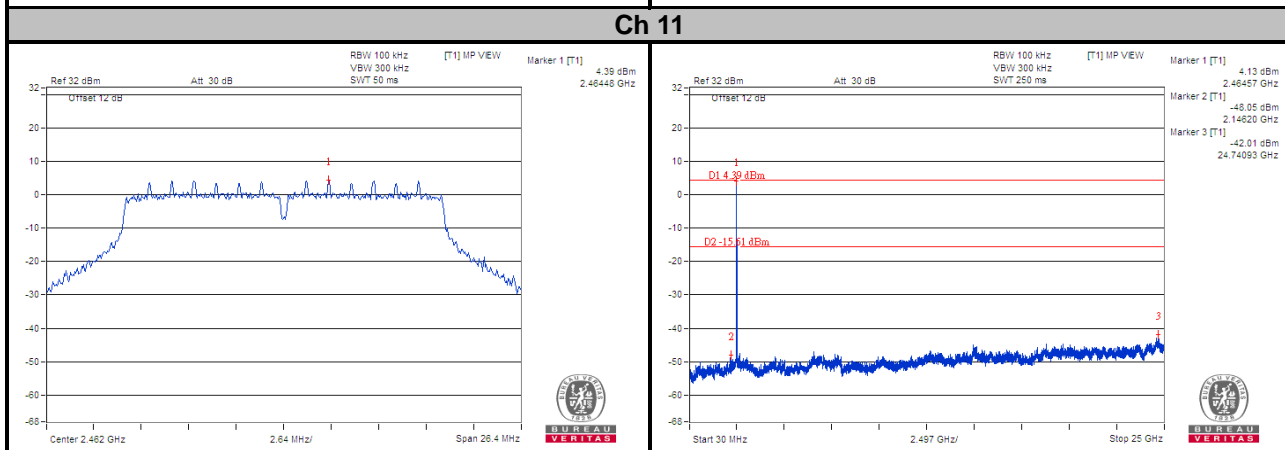
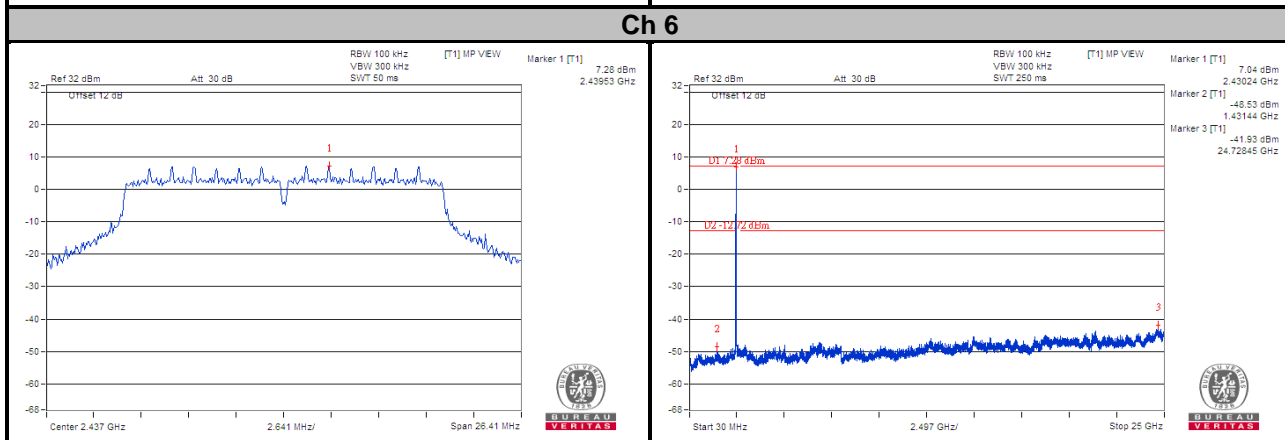
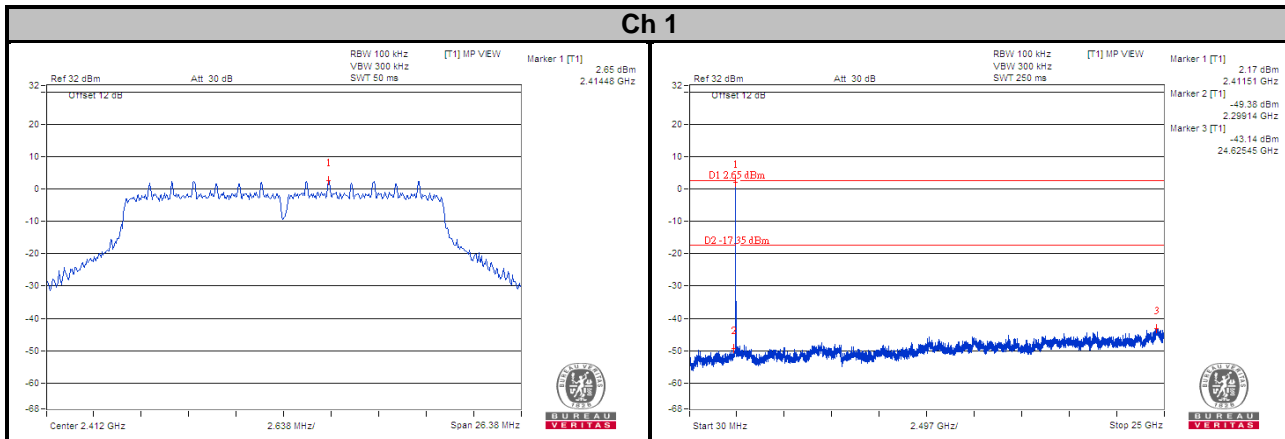

# CHAIN 1

## Ch 1

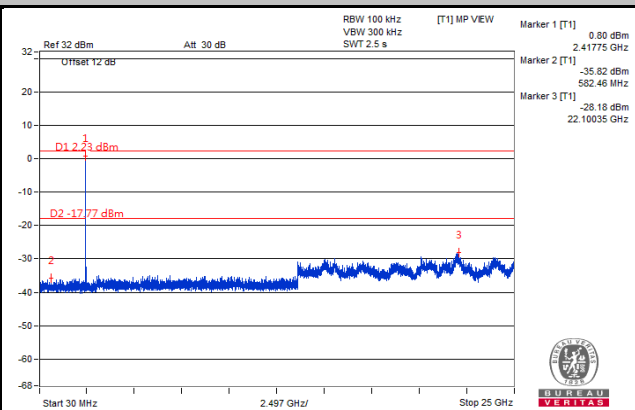
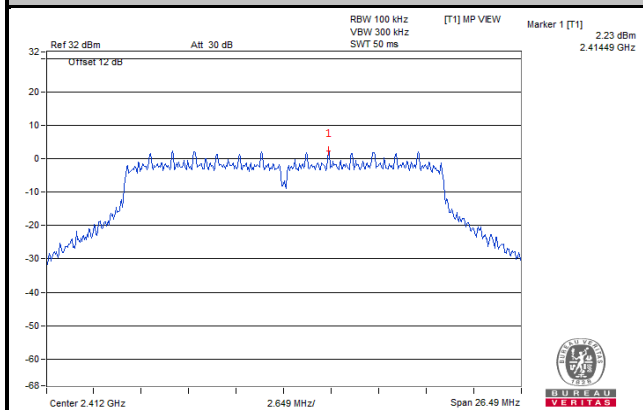

## Ch 6

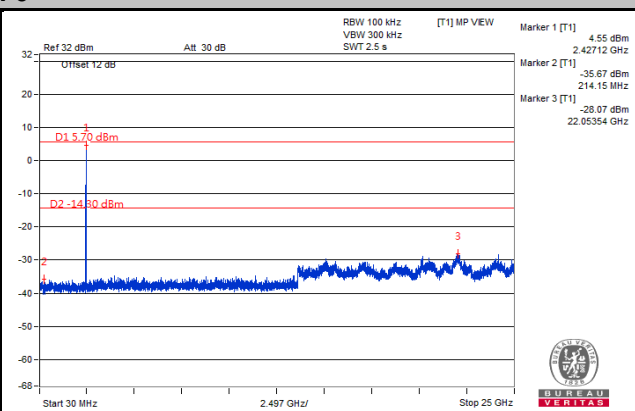
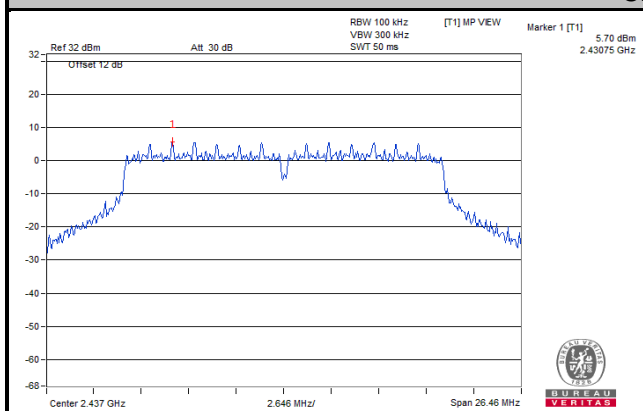

## Ch 11

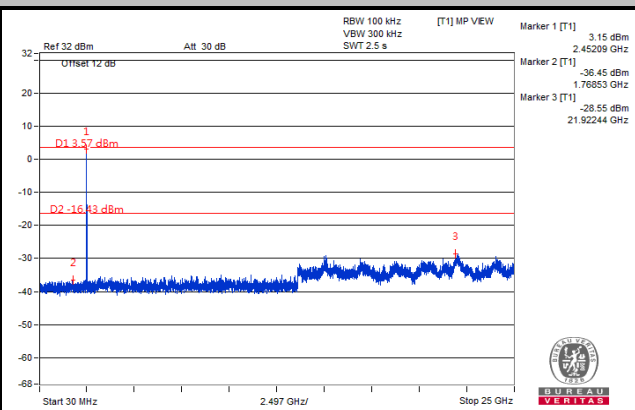
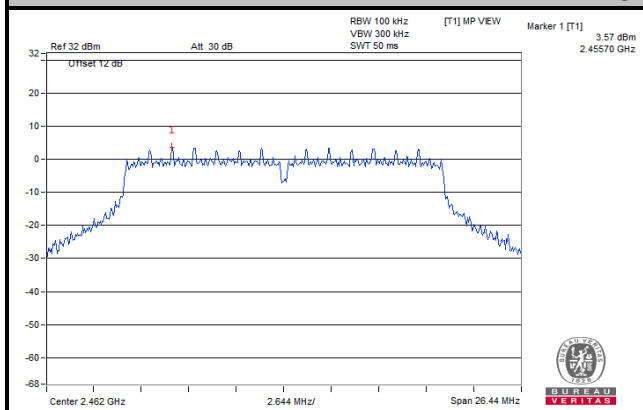

## Ch 1 Band Edge

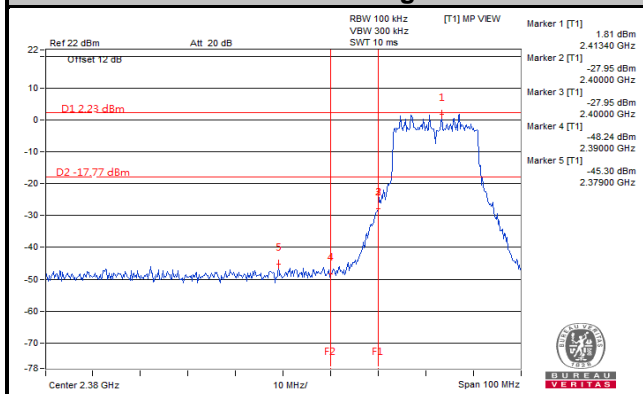

## Ch 11 Band Edge

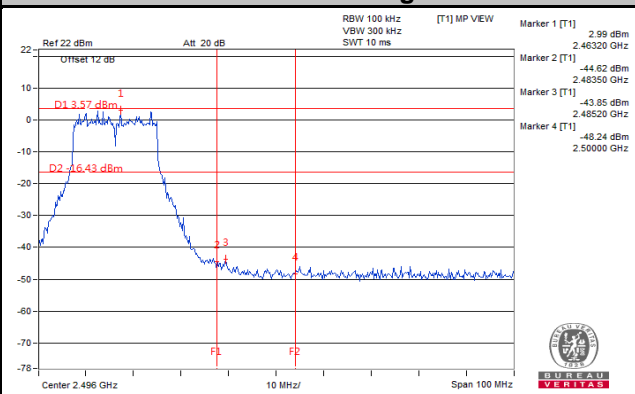

**802.11n (HT40)**  
**CHAIN 0**

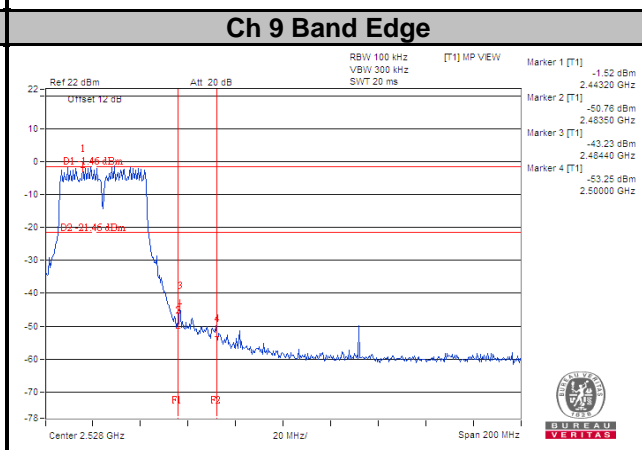
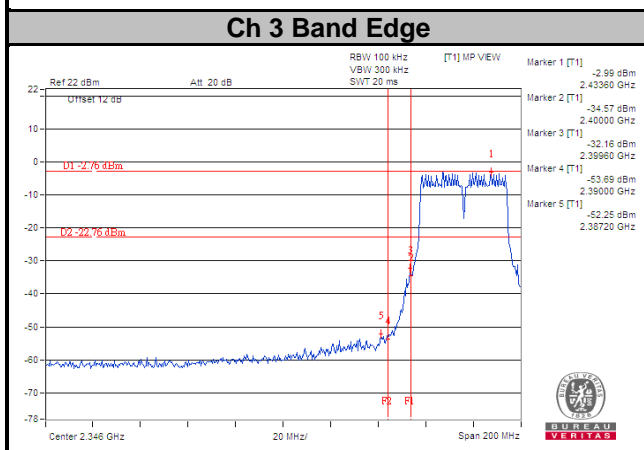
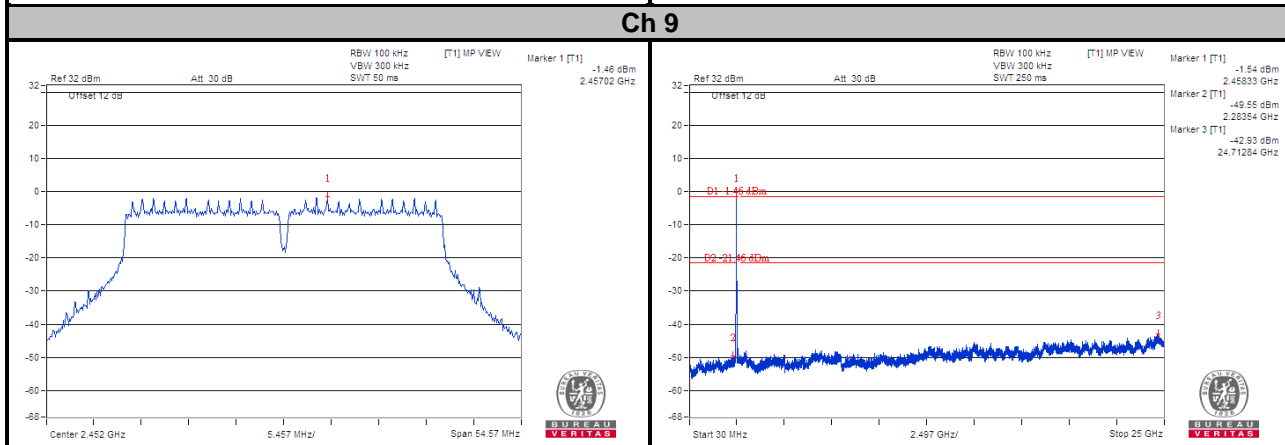
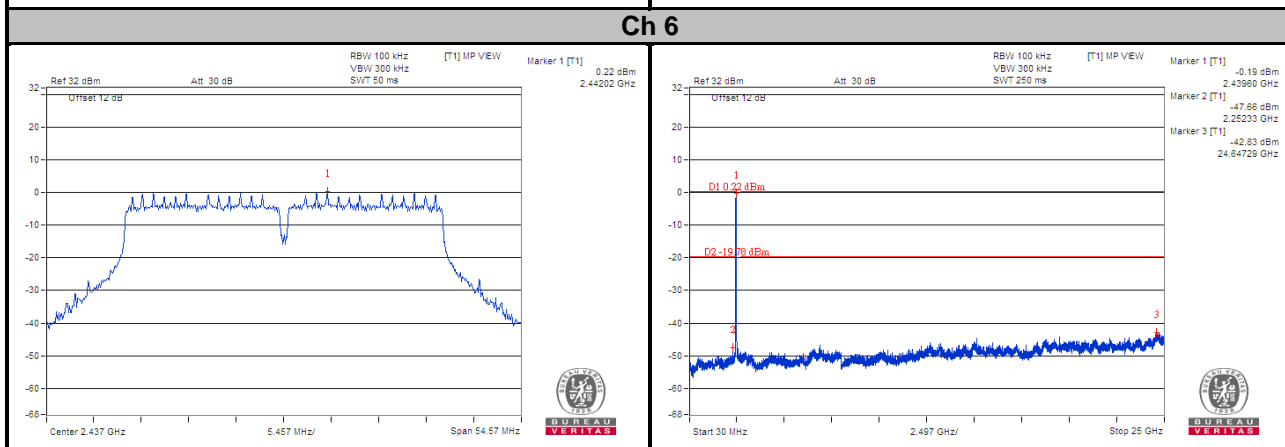
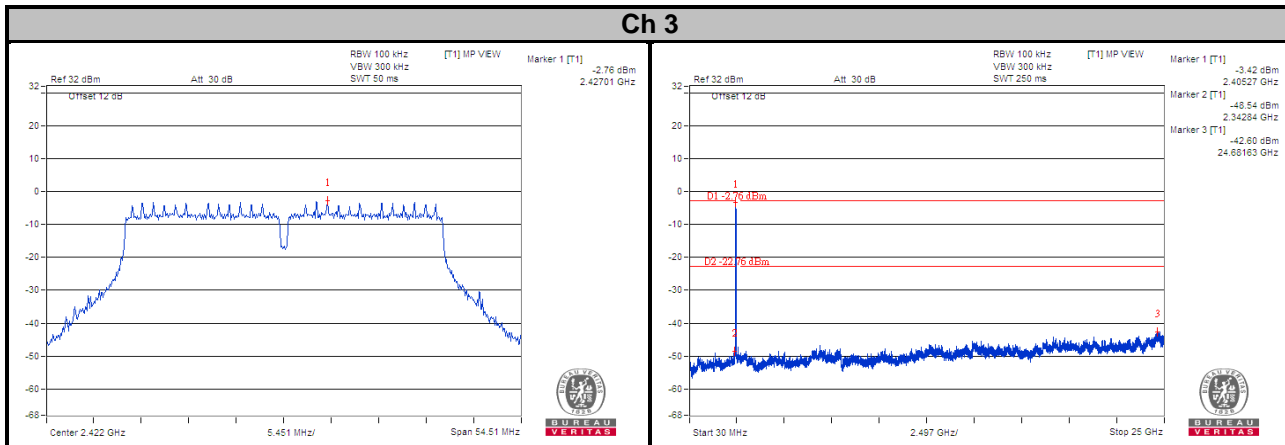

### CHAIN 1

#### Ch 3

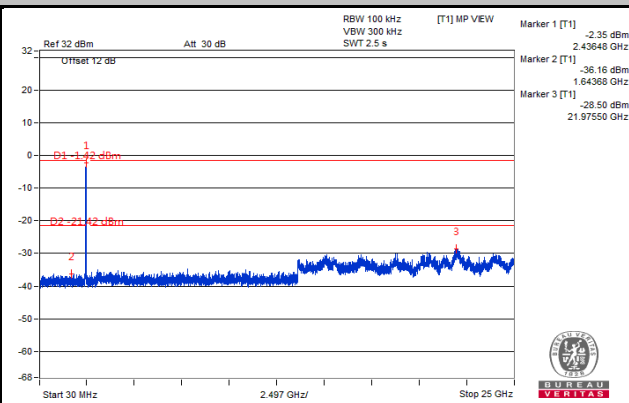
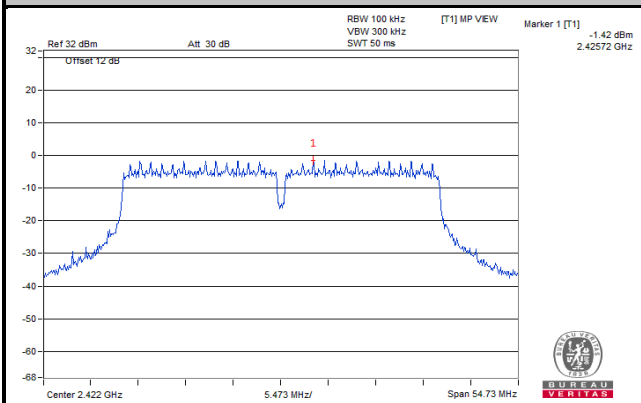

#### Ch 6

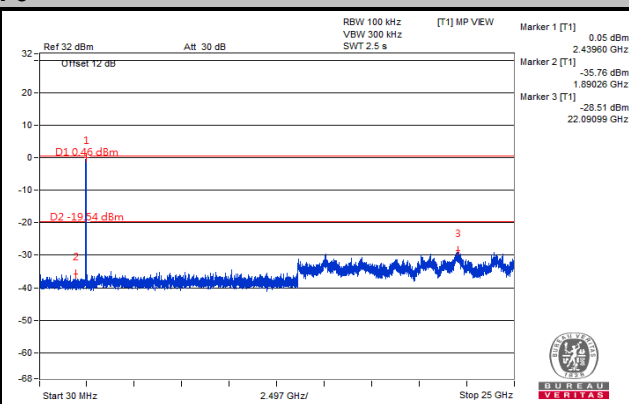
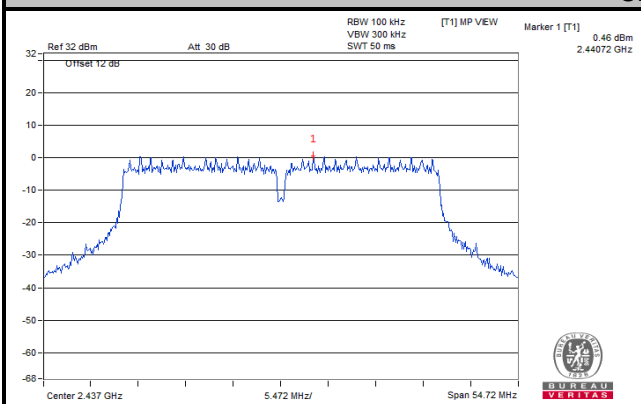

#### Ch 9

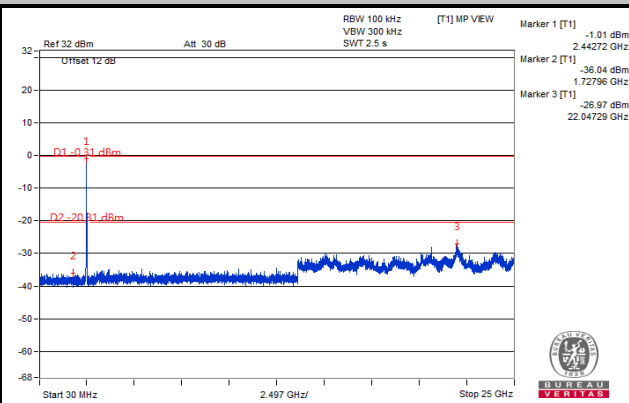
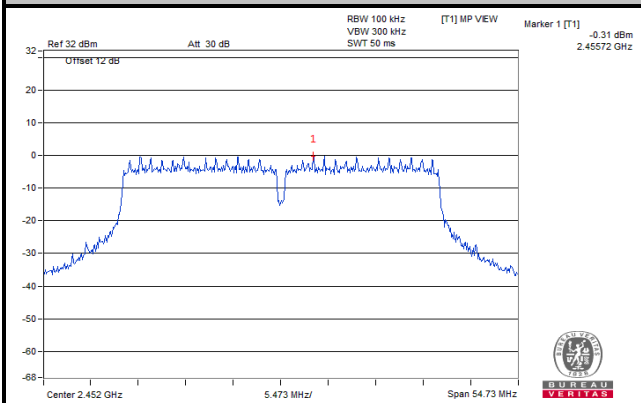

#### Ch 3 Band Edge

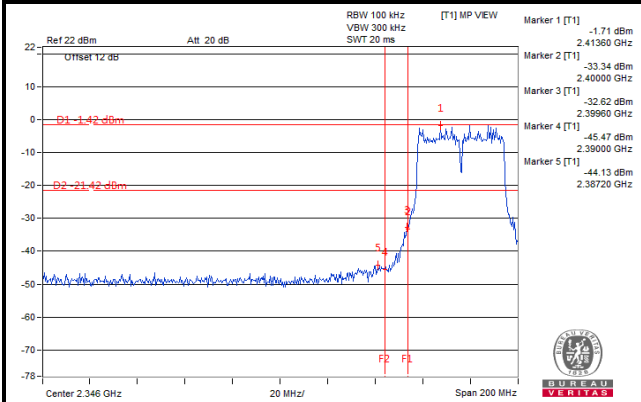

#### Ch 9 Band Edge

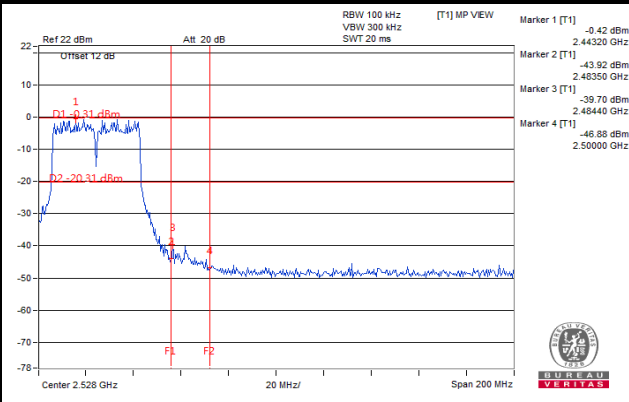

## 5 Pictures of Test Arrangements

Please refer to the attached file (Test Setup Photo).

## Appendix – Information of the Testing Laboratories

We, Bureau Veritas Consumer Products Services (H.K.) Ltd., Taoyuan Branch, were founded in 1988 to provide our best service in EMC, Radio, Telecom and Safety consultation. Our laboratories are FCC recognized accredited test firms and accredited according to ISO/IEC 17025.

If you have any comments, please feel free to contact us at the following:

### **Lin Kou EMC/RF Lab**

Tel: 886-2-26052180

Fax: 886-2-26051924

### **Hsin Chu EMC/RF/Telecom Lab**

Tel: 886-3-6668565

Fax: 886-3-6668323

### **Hwa Ya EMC/RF/Safety Lab**

Tel: 886-3-3183232

Fax: 886-3-3270892

**Email:** [service.adt@tw.bureauveritas.com](mailto:service.adt@tw.bureauveritas.com)

**Web Site:** [www.bureauveritas-adt.com](http://www.bureauveritas-adt.com)

The address and road map of all our labs can be found in our web site also.

--- END ---