

FCC Test Report

Report No.: RF190110C19-1 R1

FCC ID: HV4DTHW1621

Test Model: DTH-W1621

Series Model: DTHW1621*****; DTH-W1621***** (The "*" Can be 0-9, A-Z or blank)
(refer to item 3.1 for more details)

Received Date: Jan. 10, 2019

Test Date: Jan. 17, 2019 ~ Apr. 16, 2019

Issued Date: Apr. 17, 2019

Applicant: Wacom Co., Ltd.

Address: 2-510-1, Toyonodai, Kazo-Shi, Saitama, 349-1148 Japan

Issued By: Bureau Veritas Consumer Products Services (H.K.) Ltd., Taoyuan Branch

Lab Address: No. 47-2, 14th Ling, Chia Pau Vil., Lin Kou Dist., New Taipei City, Taiwan
(R.O.C)

Test Location (1): No.19, Hwa Ya 2nd Rd., Wen Hwa Vil., Kwei Shan Dist., Taoyuan City
33383, Taiwan, R.O.C.

Test Location (2): B2F., No.215, Sec. 3, Beixin Rd., Xindian Dist., New Taipei City 231,
Taiwan, R.O.C

**FCC Registration /
Designation Number:** 427177 / TW0011



This report is for your exclusive use. Any copying or replication of this report to or for any other person or entity, or use of our name or trademark, is permitted only with our prior written permission. This report sets forth our findings solely with respect to the test samples identified herein. The results set forth in this report are not indicative or representative of the quality or characteristics of the lot from which a test sample was taken or any similar or identical product unless specifically and expressly noted. Our report includes all of the tests requested by you and the results thereof based upon the information that you provided to us. You have 60 days from date of issuance of this report to notify us of any material error or omission caused by our negligence, provided, however, that such notice shall be in writing and shall specifically address the issue you wish to raise. A failure to raise such issue within the prescribed time shall constitute your unqualified acceptance of the completeness of this report, the tests conducted and the correctness of the report contents. Unless specific mention, the uncertainty of measurement has been explicitly taken into account to declare the compliance or non-compliance to the specification. The report must not be used by the client to claim product certification, approval, or endorsement by TAF or any government agencies.

Table of Contents

Release Control Record	4
1 Certificate of Conformity	5
2 Summary of Test Results	6
2.1 Measurement Uncertainty	6
2.2 Modification Record	6
3 General Information	7
3.1 General Description of EUT	7
3.2 Description of Test Modes	8
3.2.1 Test Mode Applicability and Tested Channel Detail	9
3.3 Duty Cycle of Test Signal	11
3.4 Description of Support Units	12
3.4.1 Configuration of System under Test	12
3.5 General Description of Applied Standards	12
4 Test Types and Results	13
4.1 Radiated Emission and Bandedge Measurement	13
4.1.1 Limits of Radiated Emission and Bandedge Measurement	13
4.1.2 Test Instruments	14
4.1.3 Test Procedures	15
4.1.4 Deviation from Test Standard	15
4.1.5 Test Set Up	16
4.1.6 EUT Operating Conditions	17
4.1.7 Test Results	18
4.2 Conducted Emission Measurement	28
4.2.1 Limits of Conducted Emission Measurement	28
4.2.2 Test Instruments	28
4.2.3 Test Procedures	28
4.2.4 Deviation from Test Standard	29
4.2.5 Test Setup	29
4.2.6 EUT Operating Conditions	29
4.2.7 Test Results	30
4.3 6 dB Bandwidth Measurement	32
4.3.1 Limits of 6 dB Bandwidth Measurement	32
4.3.2 Test Setup	32
4.3.3 Test Instruments	32
4.3.4 Test Procedure	32
4.3.5 Deviation from Test Standard	32
4.3.6 EUT Operating Conditions	32
4.3.7 Test Results	33
4.4 Occupied Bandwidth Measurement	35
4.4.1 Test Setup	35
4.4.2 Test Instruments	35
4.4.3 Test Procedure	35
4.4.4 Deviation from Test Standard	35
4.4.5 EUT Operating Conditions	35
4.4.6 Test Results	36
4.5 Conducted Output Power Measurement	38
4.5.1 Limits of Conducted Output Power Measurement	38
4.5.2 Test Setup	38
4.5.3 Test Instruments	38
4.5.4 Test Procedures	38
4.5.5 Deviation from Test Standard	38
4.5.6 EUT Operating Conditions	38
4.5.7 Test Results	39

4.6	Power Spectral Density Measurement	40
4.6.1	Limits of Power Spectral Density Measurement.....	40
4.6.2	Test Setup.....	40
4.6.3	Test Instruments	40
4.6.4	Test Procedure	40
4.6.5	Deviation from Test Standard	40
4.6.6	EUT Operating Condition	40
4.6.7	Test Results	41
4.7	Conducted Out of Band Emission Measurement	43
4.7.1	Limits of Conducted Out of Band Emission Measurement.....	43
4.7.2	Test Setup.....	43
4.7.3	Test Instruments	43
4.7.4	Test Procedure	43
4.7.5	Deviation from Test Standard	43
4.7.6	EUT Operating Condition	43
4.7.7	Test Results	44
5	Pictures of Test Arrangements.....	46
	Appendix – Information of the Testing Laboratories	47

Release Control Record

Issue No.	Description	Date Issued
RF190110C19-1	Original Release	Feb. 13, 2019
RF190110C19-1 R1	Revised model No.	Apr. 17, 2019

1 Certificate of Conformity

Product: GRAPHICS TABLET COMPUTER

Brand: Wacom

Test Model: DTH-W1621

Series Model: DTHW1621*****; DTH-W1621***** (The "*" Can be 0-9, A-Z or blank)
(refer to item 3.1 for more details)

Sample Status: Engineering Sample

Applicant: Wacom Co., Ltd.

Test Date: Jan. 17, 2019 ~ Apr. 16, 2019

Standards: 47 CFR FCC Part 15, Subpart C (Section 15.247)
ANSI C63.10:2013

The above equipment has been tested by **Bureau Veritas Consumer Products Services (H.K.) Ltd., Taoyuan Branch**, and found compliance with the requirement of the above standards. The test record, data evaluation & Equipment Under Test (EUT) configurations represented herein are true and accurate accounts of the measurements of the sample's RF characteristics under the conditions specified in this report.

Prepared by : , **Date:** Apr. 17, 2019
Gina Liu / Specialist

Approved by : , **Date:** Apr. 17, 2019
Dylan Chiou / Project Engineer

2 Summary of Test Results

47 CFR FCC Part 15, Subpart C (Section 15.247)			
FCC Clause	Test Item	Result	Remarks
15.207	AC Power Conducted Emission	Pass	Meet the requirement of limit. Minimum passing margin is -30.52 dB at 0.25557 MHz.
15.205 & 209	Radiated Emissions	Pass	Meet the requirement of limit. Minimum passing margin is -8.07 dB at 2483.52 MHz.
15.247(d)	Band Edge Measurement	Pass	Meet the requirement of limit.
15.247(d)	Antenna Port Emission	Pass	Meet the requirement of limit.
15.247(a)(2)	6 dB Bandwidth	Pass	Meet the requirement of limit.
---	Occupied Bandwidth Measurement	Pass	Reference only
15.247(b)	Conducted Power	Pass	Meet the requirement of limit.
15.247(e)	Power Spectral Density	Pass	Meet the requirement of limit.
15.203	Antenna Requirement	Pass	No antenna connector is used.

Note: Determining compliance based on the results of the compliance measurement, not taking into account measurement instrumentation uncertainty.

2.1 Measurement Uncertainty

Where relevant, the following measurement uncertainty levels have been estimated for tests performed on the EUT as specified in CISPR 16-4-2:

Measurement	Frequency	Expanded Uncertainty (k=2) (±)
Conducted Emissions at mains ports	150 kHz ~ 30 MHz	2.44 dB
Radiated Emissions up to 1 GHz	9 kHz ~ 30 MHz	3.04 dB
	30 MHz ~ 200 MHz	2.0153 dB
	200 MHz ~ 1000 MHz	2.0224 dB
Radiated Emissions above 1 GHz	1 GHz ~ 18 GHz	1.0121 dB
	18 GHz ~ 40 GHz	1.1508 dB

2.2 Modification Record

There were no modifications required for compliance.

3 General Information

3.1 General Description of EUT

Product	GRAPHICS TABLET COMPUTER
Brand	Wacom
Test Model	DTH-W1621
Series Model	DTHW1621*****; DTH-W1621***** (The"*" Can be 0-9, A-Z or blank)
Status of EUT	Engineering Sample
Power Supply Rating	5.0 or 20 Vdc (adapter)
Modulation Type	GFSK
Transfer Rate	LE 4.0: 1 Mbps LE 5.0: 2 Mbps
Operating Frequency	2402 ~ 2480 MHz
Number of Channel	40
Output Power	LE 4.0: 4.875 mW LE 5.0: 5.395 mW
Antenna Type	PIFA antenna with 0.38 dBi gain
Antenna Connector	N/A
Accessory Device	Refer to Note as below
Data Cable Supplied	Refer to Note as below

Note:

- All models are listed as below.

Brand	Model	Difference
Wacom	DTH-W1621	Main test
	DTHW1621*****	The"*" Can be 0-9, A-Z or blank for the new marketing
	DTH-W1621*****	

- The EUT contains following accessory devices.

Product	Brand	Model	Description
Adapter	WACOM	ADP-100PB B	I/P: 100-240 Vac, 50-60 Hz, 1.5 A O/P: 5 Vdc, 3 A or 20 Vdc, 5 A 1.8m / 1 core
WLAN Module	Intel	9260NGW	--

- The above EUT information is declared by manufacturer and for more detailed features description, please refers to the manufacturer's specifications or User's Manual.

3.2 Description of Test Modes

40 channels are provided to this EUT:

Channel	Freq. (MHz)	Channel	Freq. (MHz)	Channel	Freq. (MHz)	Channel	Freq. (MHz)
0	2402	10	2422	20	2442	30	2462
1	2404	11	2424	21	2444	31	2464
2	2406	12	2426	22	2446	32	2466
3	2408	13	2428	23	2448	33	2468
4	2410	14	2430	24	2450	34	2470
5	2412	15	2432	25	2452	35	2472
6	2414	16	2434	26	2454	36	2474
7	2416	17	2436	27	2456	37	2476
8	2418	18	2438	28	2458	38	2478
9	2420	19	2440	29	2460	39	2480

3.2.1 Test Mode Applicability and Tested Channel Detail

<LE 4.0>

EUT Configure Mode	Applicable To				Description
	RE≥1G	RE<1G	PLC	APCM	
-	√	√	√	√	-

Where **RE≥1G**: Radiated Emission above 1 GHz **RE<1G**: Radiated Emission below 1 GHz
PLC: Power Line Conducted Emission **APCM**: Antenna Port Conducted Measurement

Note: The EUT had been pre-tested on the positioned of each 3 axis. The worst case was found when positioned on **Z-plane**.
Note: “-” means no effect.

Radiated Emission Test (Above 1 GHz):

- Pre-Scan has been conducted to determine the worst-case mode from all possible combinations between available modulations, data rates and antenna ports (if EUT with antenna diversity architecture).
- Following channel(s) was (were) selected for the final test as listed below.

EUT Configure Mode	Available Channel	Tested Channel	Modulation Type	Data Rate (Mbps)
-	0 to 39	0, 19, 39	GFSK	1

Radiated Emission Test (Below 1 GHz):

- Pre-Scan has been conducted to determine the worst-case mode from all possible combinations between available modulations, data rates and antenna ports (if EUT with antenna diversity architecture).
- Following channel(s) was (were) selected for the final test as listed below.

EUT Configure Mode	Available Channel	Tested Channel	Modulation Type	Data Rate (Mbps)
-	0 to 39	39	GFSK	1

Power Line Conducted Emission Test:

- Pre-Scan has been conducted to determine the worst-case mode from all possible combinations between available modulations, data rates and antenna ports (if EUT with antenna diversity architecture).
- Following channel(s) was (were) selected for the final test as listed below.

EUT Configure Mode	Available Channel	Tested Channel	Modulation Type	Data Rate (Mbps)
-	0 to 39	39	GFSK	1

Antenna Port Conducted Measurement:

- This item includes all test value of each mode, but only includes spectrum plot of worst value of each mode.
- Pre-Scan has been conducted to determine the worst-case mode from all possible combinations between available modulations, data rates and antenna ports (if EUT with antenna diversity architecture).
- Following channel(s) was (were) selected for the final test as listed below.

EUT Configure Mode	Available Channel	Tested Channel	Modulation Type	Data Rate (Mbps)
-	0 to 39	0, 19, 39	GFSK	1

<LE 5.0>

EUT Configure Mode	Applicable To				Description
	RE≥1G	RE<1G	PLC	APCM	
-	√	√	√	√	-

Where **RE≥1G**: Radiated Emission above 1 GHz **RE<1G**: Radiated Emission below 1 GHz
PLC: Power Line Conducted Emission **APCM**: Antenna Port Conducted Measurement

Note: The EUT had been pre-tested on the positioned of each 3 axis. The worst case was found when positioned on **Z-plane**.
Note: “-” means no effect.

Radiated Emission Test (Above 1 GHz):

- Pre-Scan has been conducted to determine the worst-case mode from all possible combinations between available modulations, data rates and antenna ports (if EUT with antenna diversity architecture).
- Following channel(s) was (were) selected for the final test as listed below.

EUT Configure Mode	Available Channel	Tested Channel	Modulation Type	Data Rate (Mbps)
-	0 to 39	0, 19, 39	GFSK	2

Radiated Emission Test (Below 1 GHz):

- Pre-Scan has been conducted to determine the worst-case mode from all possible combinations between available modulations, data rates and antenna ports (if EUT with antenna diversity architecture).
- Following channel(s) was (were) selected for the final test as listed below.

EUT Configure Mode	Available Channel	Tested Channel	Modulation Type	Data Rate (Mbps)
-	0 to 39	39	GFSK	2

Power Line Conducted Emission Test:

- Pre-Scan has been conducted to determine the worst-case mode from all possible combinations between available modulations, data rates and antenna ports (if EUT with antenna diversity architecture).
- Following channel(s) was (were) selected for the final test as listed below.

EUT Configure Mode	Available Channel	Tested Channel	Modulation Type	Data Rate (Mbps)
-	0 to 39	39	GFSK	2

Antenna Port Conducted Measurement:

- This item includes all test value of each mode, but only includes spectrum plot of worst value of each mode.
- Pre-Scan has been conducted to determine the worst-case mode from all possible combinations between available modulations, data rates and antenna ports (if EUT with antenna diversity architecture).
- Following channel(s) was (were) selected for the final test as listed below.

EUT Configure Mode	Available Channel	Tested Channel	Modulation Type	Data Rate (Mbps)
-	0 to 39	0, 19, 39	GFSK	2

Test Condition:

Applicable To	Environmental Conditions	Input Power	Tested by
RE≥1G	25 deg. C, 65 % RH	120 Vac, 60 Hz	Charles Hsiao
RE<1G	25 deg. C, 65 % RH	120 Vac, 60 Hz	Karl Lee
PLC	25 deg. C, 65 % RH	120 Vac, 60 Hz	Jisyong Wang
APCM	25 deg. C, 65 % RH	120 Vac, 60 Hz	Gavin Wu

3.3 Duty Cycle of Test Signal

<LE 4.0>

Duty cycle = $0.385/0.627 = 0.614$, Duty factor = $10 * \log(1/0.614) = 2.12$

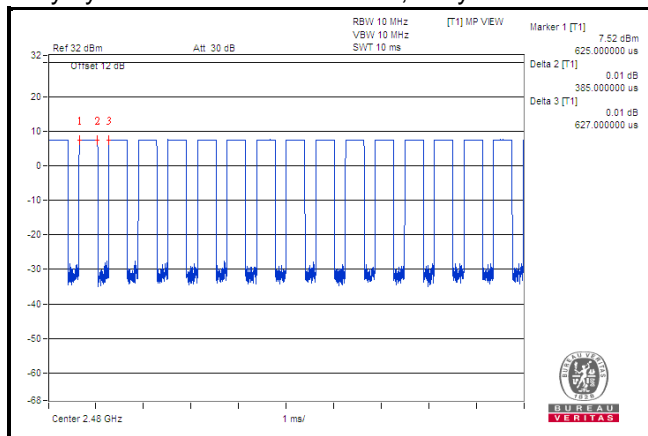

<LE 5.0>

Duty cycle = $0.204/0.626 = 0.326$, Duty factor = $10 * \log(1/0.326) = 4.87$

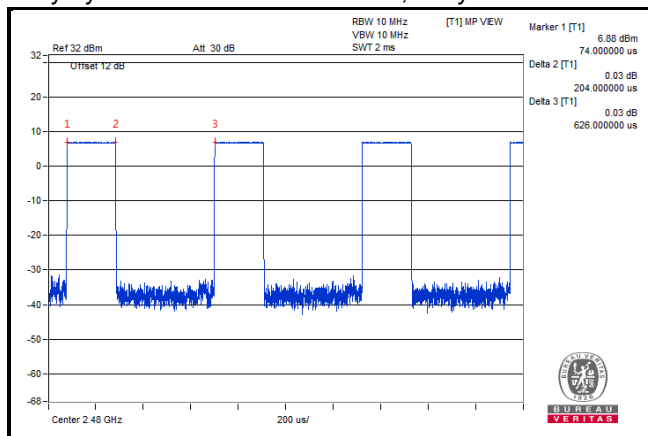

3.4 Description of Support Units

The EUT has been tested as an independent unit together with other necessary accessories or support units.

3.4.1 Configuration of System under Test

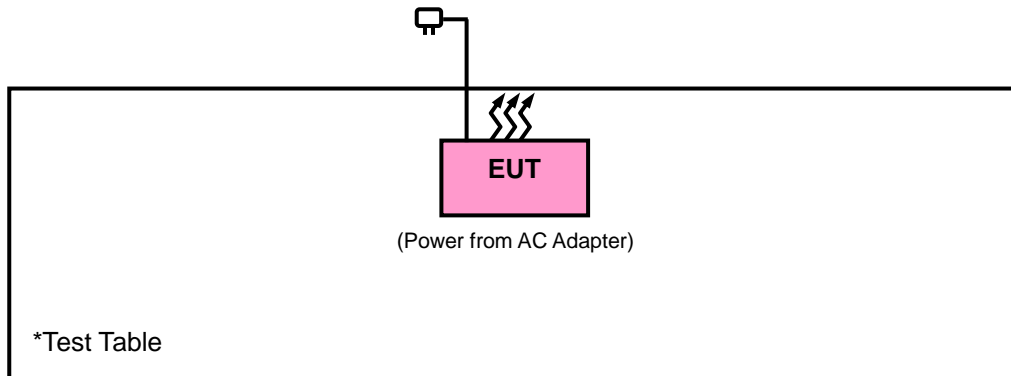

3.5 General Description of Applied Standards

The EUT is a RF Product. According to the specifications of the manufacturer, it must comply with the requirements of the following standards:

FCC Part 15, Subpart C (15.247)

KDB 558074 D01 15.247 Meas Guidance v05r02

ANSI C63.10-2013

All test items have been performed and recorded as per the above standards.

4 Test Types and Results

4.1 Radiated Emission and Bandedge Measurement

4.1.1 Limits of Radiated Emission and Bandedge Measurement

Radiated emissions which fall in the restricted bands must comply with the radiated emission limits specified as below table. Other emissions shall be at least 20 dB below the highest level of the desired power:

Frequencies (MHz)	Field Strength (microvolts/meter)	Measurement Distance (meters)
0.009 ~ 0.490	2400/F (kHz)	300
0.490 ~ 1.705	24000/F (kHz)	30
1.705 ~ 30.0	30	30
30 ~ 88	100	3
88 ~ 216	150	3
216 ~ 960	200	3
Above 960	500	3

Note:

1. The lower limit shall apply at the transition frequencies.
2. Emission level (dBuV/m) = 20 log Emission level (uV/m).
3. For frequencies above 1000 MHz, the field strength limits are based on average detector, however, the peak field strength of any emission shall not exceed the maximum permitted average limits, specified above by more than 20 dB under any condition of modulation.

4.1.2 Test Instruments

Description & Manufacturer	Model No.	Serial No.	Date of Calibration	Due Date of Calibration
Test Receiver Agilent Technologies	N9038A	MY51210203	Mar. 16, 2018	Mar. 15, 2019
			Mar. 18, 2019	Mar. 17, 2020
Spectrum Analyzer ROHDE & SCHWARZ	FSU43	100115	Jan. 21, 2019	Jan. 20, 2020
HORN Antenna ETS-Lindgren	3117	00143293	Nov. 25, 2018	Nov. 24, 2019
BILOG Antenna SCHWARZBECK	VULB9168	9168-616	Nov. 27, 2018	Nov. 26, 2019
HORN Antenna SCHWARZBECK	BBHA 9170	9170-480	Nov. 25, 2018	Nov. 24, 2019
Fixed Attenuator Mini-Circuits	MDCS18N-10	MDCS18N-10-01	Apr. 16, 2018	Apr. 15, 2019
			Apr. 15, 2019	Apr. 14, 2020
Loop Antenna	EM-6879	269	Sep. 07, 2018	Sep. 06, 2019
Preamplifier Agilent	310N	187226	Jun. 19, 2018	Jun. 18, 2019
Preamplifier Agilent	83017A	MY39501357	Jun. 19, 2018	Jun. 18, 2019
Power Meter Anritsu	ML2495A	1012010	Sep. 05, 2018	Sep. 04, 2019
Power Sensor Anritsu	MA2411B	1315050	Sep. 04, 2018	Sep. 03, 2019
RF signal cable ETS-LINDGREN	5D-FB	Cable-CH1-01(RFC -SMS-100-SMS-12 0+RFC-SMS-100-S MS-400)	Jun. 19, 2018	Jun. 18, 2019
RF signal cable ETS-LINDGREN	8D-FB	Cable-CH1-02(RFC -SMS-100-SMS-24)	Jun. 19, 2018	Jun. 18, 2019
Boresight Antenna Fixture	FBA-01	FBA-SIP01	NA	NA
Software BV ADT	E3 8.130425b	NA	NA	NA
Antenna Tower MF	NA	NA	NA	NA
Turn Table MF	NA	NA	NA	NA
Antenna Tower & Turn Table Controller MF	MF-7802	NA	NA	NA

- Note: 1. The calibration interval of the above test instruments is 12 months and the calibrations are traceable to NML/ROC and NIST/USA.
2. The test was performed in HsinTien Chamber 1.
3. The horn antenna and preamplifier (model: 83017A) are used only for the measurement of emission frequency above 1 GHz if tested.
4. The IC Site Registration No. is 7450I-1.

4.1.3 Test Procedures

For Radiated Emission below 30 MHz

- a. The EUT was placed on the top of a rotating table 0.8 meters above the ground at a 3 meter chamber room. The table was rotated 360 degrees to determine the position of the highest radiation.
- b. The EUT was set 3 meters away from the interference-receiving antenna, which was mounted on the top of a variable-height antenna tower.
- c. Parallel, perpendicular, and ground-parallel orientations of the antenna are set to make the measurement.
- d. For each suspected emission, the EUT was arranged to its worst case and the rotatable table was turned from 0 degrees to 360 degrees to find the maximum reading.
- e. The test-receiver system was set to Quasi-Peak Detect Function and Specified Bandwidth with Maximum Hold Mode.

Note:

1. The resolution bandwidth and video bandwidth of test receiver/spectrum analyzer is 9 kHz at frequency below 30 MHz.

For Radiated Emission above 30 MHz

- a. The EUT was placed on the top of a rotating table 0.8 meters (for 30 MHz ~ 1 GHz) / 1.5 meters (for above 1 GHz) above the ground at 3 meter chamber room for test. The table was rotated 360 degrees to determine the position of the highest radiation.
- b. The EUT was set 3 meters away from the interference-receiving antenna, which was mounted on the top of a variable-height antenna tower.
- c. The height of antenna is varied from one meter to four meters above the ground to determine the maximum value of the field strength. Both horizontal and vertical polarizations of the antenna are set to make the measurement.
- d. For each suspected emission, the EUT was arranged to its worst case and then the antenna was tuned to heights from 1 meter to 4 meters and the rotatable table was turned from 0 degrees to 360 degrees to find the maximum reading.
- e. The test-receiver system was set to quasi-peak detect function and specified bandwidth with maximum hold mode when the test frequency is below 1 GHz.
- f. The test-receiver system was set to peak and average detected function and specified bandwidth with maximum hold mode when the test frequency is above 1 GHz. If the peak reading value also meets average limit, measurement with the average detector is unnecessary.

Note:

1. The resolution bandwidth and video bandwidth of test receiver/spectrum analyzer is 120 kHz for Quasi-peak detection (QP) or Peak detection (PK) at frequency below 1 GHz.
2. The resolution bandwidth of test receiver/spectrum analyzer is 1 MHz and the video bandwidth is 3 MHz for Peak detection (PK) at frequency above 1 GHz.
3. The resolution bandwidth of test receiver/spectrum analyzer is 1 MHz and the video bandwidth is $\geq 1/T$ (Duty cycle < 98 %) or 10 Hz (Duty cycle ≥ 98 %) for Average detection (AV) at frequency above 1 GHz. (For BT4.0 RBW = 1 MHz, VBW = 3 kHz, For BT5.0 RBW = 1 MHz, VBW = 10 kHz)
4. All modes of operation were investigated and the worst-case emissions are reported.

4.1.4 Deviation from Test Standard

No deviation.

4.1.5 Test Set Up

<Radiated Emission below 30 MHz>

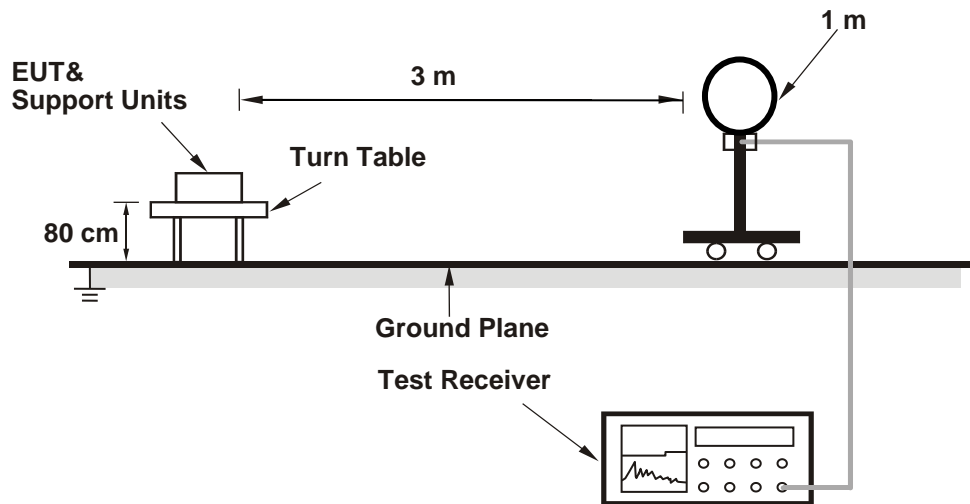

<Radiated Emission 30 MHz to 1 GHz>

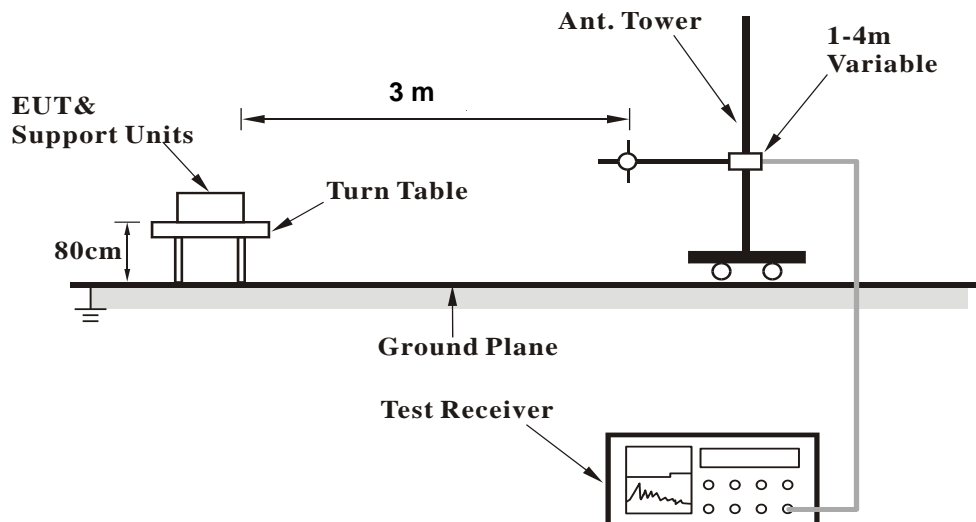

<Radiated Emission above 1 GHz>

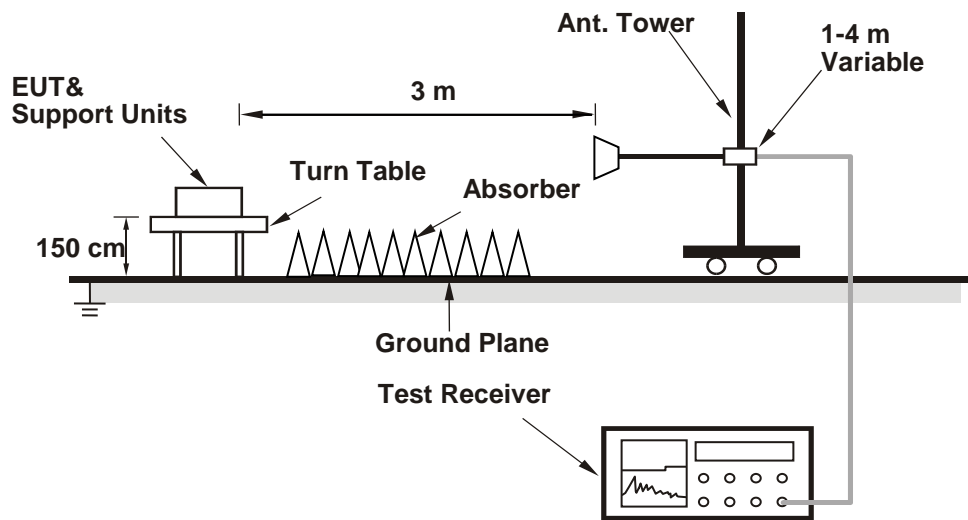

For the actual test configuration, please refer to the attached file (Test Setup Photo).

4.1.6 EUT Operating Conditions

- a. Placed the EUT on the testing table.
- b. Set the EUT under transmission condition continuously at specific channel frequency.

4.1.7 Test Results

<LE 4.0>

Above 1 GHz Data:

EUT Test Condition		Measurement Detail	
Channel	Channel 0	Frequency Range	1 GHz ~ 25 GHz
Input Power	120 Vac, 60 Hz	Detector Function	Peak (PK) Average (AV)
Environmental Conditions	25 deg. C, 65 % RH	Tested By	Charles Hsiao

Antennal Polarity & Test Distance: Horizontal at 3 m										
Frequency (MHz)	Emission Level (dBuV/m)	Read Level (dBuV)	Limit (dBuV/m)	Margin (dB)	Antenna Factor (dB/m)	Cable Loss (dB)	Preamp Factor (dB)	Antenna Height (cm)	Table Angle (Degree)	Remark
2365.53	40.86	34.49	54	-13.14	31.76	5.37	30.76	188	66	Average
2365.53	52.29	45.92	74	-21.71	31.76	5.37	30.76	188	66	Peak
2402	96.58	90.11			31.8	5.4	30.73	188	66	Average
2402	97.12	90.65			31.8	5.4	30.73	188	66	Peak
4804	38.46	30.37	54	-15.54	33.96	8.25	34.12	105	55	Average
4804	46.96	38.87	74	-27.04	33.96	8.25	34.12	105	55	Peak

Antennal Polarity & Test Distance: Vertical at 3 m										
Frequency (MHz)	Emission Level (dBuV/m)	Read Level (dBuV)	Limit (dBuV/m)	Margin (dB)	Antenna Factor (dB/m)	Cable Loss (dB)	Preamp Factor (dB)	Antenna Height (cm)	Table Angle (Degree)	Remark
2380.83	40.76	34.34	54	-13.24	31.78	5.4	30.76	100	123	Average
2380.83	51.66	45.24	74	-22.34	31.78	5.4	30.76	100	123	Peak
2402	89.65	83.18			31.8	5.4	30.73	100	123	Average
2402	90.04	83.57			31.8	5.4	30.73	100	123	Peak
4804	38.36	30.27	54	-15.64	33.96	8.25	34.12	105	216	Average
4804	46.2	38.11	74	-27.8	33.96	8.25	34.12	105	216	Peak

Remarks:

- Emission Level = Read Level + Antenna Factor + Cable Loss - Preamp Factor
Margin value = Emission level – Limit value
- 2402 MHz: Fundamental frequency.
- The emission levels of other frequencies were very low against the limit.

EUT Test Condition		Measurement Detail	
Channel	Channel 19	Frequency Range	1 GHz ~ 25 GHz
Input Power	120 Vac, 60 Hz	Detector Function	Peak (PK) Average (AV)
Environmental Conditions	25 deg. C, 65 % RH	Tested By	Charles Hsiao

Antennal Polarity & Test Distance: Horizontal at 3 m										
Frequency (MHz)	Emission Level (dBuV/m)	Read Level (dBuV)	Limit (dBuV/m)	Margin (dB)	Antenna Factor (dB/m)	Cable Loss (dB)	Preamp Factor (dB)	Antenna Height (cm)	Table Angle (Degree)	Remark
2363.1	40.89	34.56	54	-13.11	31.76	5.37	30.8	188	66	Average
2363.1	52.33	46	74	-21.67	31.76	5.37	30.8	188	66	Peak
2440	96.66	90.04			31.85	5.46	30.69	188	66	Average
2440	97.26	90.64			31.85	5.46	30.69	188	66	Peak
2498.36	41.5	34.65	54	-12.5	31.9	5.53	30.58	188	66	Average
2498.36	53.06	46.21	74	-20.94	31.9	5.53	30.58	188	66	Peak
4880	38.21	30.02	54	-15.79	33.98	8.27	34.06	146	44	Average
4880	46.44	38.25	74	-27.56	33.98	8.27	34.06	146	44	Peak
Antennal Polarity & Test Distance: Vertical at 3 m										
Frequency (MHz)	Emission Level (dBuV/m)	Read Level (dBuV)	Limit (dBuV/m)	Margin (dB)	Antenna Factor (dB/m)	Cable Loss (dB)	Preamp Factor (dB)	Antenna Height (cm)	Table Angle (Degree)	Remark
2384.16	40.75	34.33	54	-13.25	31.78	5.4	30.76	100	123	Average
2384.16	52.25	45.83	74	-21.75	31.78	5.4	30.76	100	123	Peak
2440	89.58	82.96			31.85	5.46	30.69	100	123	Average
2440	90.45	83.83			31.85	5.46	30.69	100	123	Peak
2494.8	41.32	34.47	54	-12.68	31.9	5.53	30.58	100	123	Average
2494.8	52.21	45.36	74	-21.79	31.9	5.53	30.58	100	123	Peak
4880	38.44	30.25	54	-15.56	33.98	8.27	34.06	105	275	Average
4880	46.31	38.12	74	-27.69	33.98	8.27	34.06	105	275	Peak

Remarks:

- Emission Level = Read Level + Antenna Factor + Cable Loss - Preamp Factor
Margin value = Emission level – Limit value
- 2440 MHz: Fundamental frequency.
- The emission levels of other frequencies were very low against the limit.

EUT Test Condition		Measurement Detail	
Channel	Channel 39	Frequency Range	1 GHz ~ 25 GHz
Input Power	120 Vac, 60 Hz	Detector Function	Peak (PK) Average (AV)
Environmental Conditions	25 deg. C, 65 % RH	Tested By	Charles Hsiao

Antennal Polarity & Test Distance: Horizontal at 3 m										
Frequency (MHz)	Emission Level (dBuV/m)	Read Level (dBuV)	Limit (dBuV/m)	Margin (dB)	Antenna Factor (dB/m)	Cable Loss (dB)	Preamp Factor (dB)	Antenna Height (cm)	Table Angle (Degree)	Remark
2480	96.5	89.74			31.88	5.5	30.62	188	66	Average
2480	97.44	90.68			31.88	5.5	30.62	188	66	Peak
2483.52	45.93	39.17	54	-8.07	31.88	5.5	30.62	188	66	Average
2483.52	56.24	49.48	74	-17.76	31.88	5.5	30.62	188	66	Peak
4960	38.64	30.37	54	-15.36	33.99	8.29	34.01	105	326	Average
4960	46.94	38.67	74	-27.06	33.99	8.29	34.01	105	326	Peak

Antennal Polarity & Test Distance: Vertical at 3 m										
Frequency (MHz)	Emission Level (dBuV/m)	Read Level (dBuV)	Limit (dBuV/m)	Margin (dB)	Antenna Factor (dB/m)	Cable Loss (dB)	Preamp Factor (dB)	Antenna Height (cm)	Table Angle (Degree)	Remark
2480	89.65	82.89			31.88	5.5	30.62	100	123	Average
2480	90.79	84.03			31.88	5.5	30.62	100	123	Peak
2483.72	41.57	34.81	54	-12.43	31.88	5.5	30.62	100	123	Average
2483.72	52.08	45.32	74	-21.92	31.88	5.5	30.62	100	123	Peak
4960	38.28	30.01	54	-15.72	33.99	8.29	34.01	132	5	Average
4960	47.33	39.06	74	-26.67	33.99	8.29	34.01	132	5	Peak

Remarks:

- Emission Level = Read Level + Antenna Factor + Cable Loss - Preamp Factor
Margin value = Emission level – Limit value
- 2480 MHz: Fundamental frequency.
- The emission levels of other frequencies were very low against the limit.

<LE 5.0>

EUT Test Condition		Measurement Detail	
Channel	Channel 0	Frequency Range	1 GHz ~ 25 GHz
Input Power	120 Vac, 60 Hz	Detector Function	Peak (PK) Average (AV)
Environmental Conditions	25 deg. C, 65 % RH	Tested By	Charles Hsiao

Antennal Polarity & Test Distance: Horizontal at 3 m										
Frequency (MHz)	Emission Level (dBuV/m)	Read Level (dBuV)	Limit (dBuV/m)	Margin (dB)	Antenna Factor (dB/m)	Cable Loss (dB)	Preamp Factor (dB)	Antenna Height (cm)	Table Angle (Degree)	Remark
2358.64	40.71	34.38	54	-13.29	31.76	5.37	30.8	188	66	Average
2358.64	52.16	45.83	74	-21.84	31.76	5.37	30.8	188	66	Peak
2402	95.42	88.95			31.8	5.4	30.73	188	66	Average
2402	96.33	89.86			31.8	5.4	30.73	188	66	Peak
4804	38.36	30.27	54	-15.64	33.96	8.25	34.12	158	28	Average
4804	46.83	38.74	74	-27.17	33.96	8.25	34.12	158	28	Peak
Antennal Polarity & Test Distance: Vertical at 3 m										
Frequency (MHz)	Emission Level (dBuV/m)	Read Level (dBuV)	Limit (dBuV/m)	Margin (dB)	Antenna Factor (dB/m)	Cable Loss (dB)	Preamp Factor (dB)	Antenna Height (cm)	Table Angle (Degree)	Remark
2375.45	40.65	34.26	54	-13.35	31.78	5.37	30.76	100	123	Average
2375.45	51.53	45.14	74	-22.47	31.78	5.37	30.76	100	123	Peak
2402	88.53	82.06			31.8	5.4	30.73	100	123	Average
2402	89.44	82.97			31.8	5.4	30.73	100	123	Peak
4804	38.41	30.32	54	-15.59	33.96	8.25	34.12	105	216	Average
4804	46.36	38.27	74	-27.64	33.96	8.25	34.12	105	216	Peak

Remarks:

- Emission Level = Read Level + Antenna Factor + Cable Loss - Preamp Factor
Margin value = Emission level – Limit value
- 2402 MHz: Fundamental frequency.
- The emission levels of other frequencies were very low against the limit.

EUT Test Condition		Measurement Detail	
Channel	Channel 19	Frequency Range	1 GHz ~ 25 GHz
Input Power	120 Vac, 60 Hz	Detector Function	Peak (PK) Average (AV)
Environmental Conditions	25 deg. C, 65 % RH	Tested By	Charles Hsiao

Antennal Polarity & Test Distance: Horizontal at 3 m										
Frequency (MHz)	Emission Level (dBuV/m)	Read Level (dBuV)	Limit (dBuV/m)	Margin (dB)	Antenna Factor (dB/m)	Cable Loss (dB)	Preamp Factor (dB)	Antenna Height (cm)	Table Angle (Degree)	Remark
2346.95	40.68	34.41	54	-13.32	31.74	5.33	30.8	188	66	Average
2346.95	51.19	44.92	74	-22.81	31.74	5.33	30.8	188	66	Peak
2440	95.73	89.11			31.85	5.46	30.69	188	66	Average
2440	96.56	89.94			31.85	5.46	30.69	188	66	Peak
2493.26	41.36	34.51	54	-12.64	31.9	5.53	30.58	188	66	Average
2493.26	52.96	46.11	74	-21.04	31.9	5.53	30.58	188	66	Peak
4880	38.35	30.16	54	-15.65	33.98	8.27	34.06	125	109	Average
4880	46.27	38.08	74	-27.73	33.98	8.27	34.06	125	109	Peak

Antennal Polarity & Test Distance: Vertical at 3 m										
Frequency (MHz)	Emission Level (dBuV/m)	Read Level (dBuV)	Limit (dBuV/m)	Margin (dB)	Antenna Factor (dB/m)	Cable Loss (dB)	Preamp Factor (dB)	Antenna Height (cm)	Table Angle (Degree)	Remark
2372.63	40.65	34.26	54	-13.35	31.78	5.37	30.76	100	123	Average
2372.63	52.34	45.95	74	-21.66	31.78	5.37	30.76	100	123	Peak
2440	88.51	81.89			31.85	5.46	30.69	100	123	Average
2440	89.49	82.87			31.85	5.46	30.69	100	123	Peak
2486.21	41.16	34.37	54	-12.84	31.88	5.53	30.62	100	123	Average
2486.21	52.09	45.3	74	-21.91	31.88	5.53	30.62	100	123	Peak
4880	38.55	30.36	54	-15.45	33.98	8.27	34.06	147	243	Average
4880	46.38	38.19	74	-27.62	33.98	8.27	34.06	147	243	Peak

Remarks:

- Emission Level = Read Level + Antenna Factor + Cable Loss - Preamp Factor
Margin value = Emission level – Limit value
- 2440 MHz: Fundamental frequency.
- The emission levels of other frequencies were very low against the limit.

EUT Test Condition		Measurement Detail	
Channel	Channel 39	Frequency Range	1 GHz ~ 25 GHz
Input Power	120 Vac, 60 Hz	Detector Function	Peak (PK) Average (AV)
Environmental Conditions	25 deg. C, 65 % RH	Tested By	Charles Hsiao

Antennal Polarity & Test Distance: Horizontal at 3 m										
Frequency (MHz)	Emission Level (dBuV/m)	Read Level (dBuV)	Limit (dBuV/m)	Margin (dB)	Antenna Factor (dB/m)	Cable Loss (dB)	Preamp Factor (dB)	Antenna Height (cm)	Table Angle (Degree)	Remark
2480	95.56	88.8			31.88	5.5	30.62	188	66	Average
2480	96.51	89.75			31.88	5.5	30.62	188	66	Peak
2483.56	45.87	39.11	54	-8.13	31.88	5.5	30.62	188	66	Average
2483.56	55.87	49.11	74	-18.13	31.88	5.5	30.62	188	66	Peak
4960	38.54	30.27	54	-15.46	33.99	8.29	34.01	115	127	Average
4960	46.73	38.46	74	-27.27	33.99	8.29	34.01	115	127	Peak

Antennal Polarity & Test Distance: Vertical at 3 m										
Frequency (MHz)	Emission Level (dBuV/m)	Read Level (dBuV)	Limit (dBuV/m)	Margin (dB)	Antenna Factor (dB/m)	Cable Loss (dB)	Preamp Factor (dB)	Antenna Height (cm)	Table Angle (Degree)	Remark
2480	88.58	81.82			31.88	5.5	30.62	100	123	Average
2480	89.65	82.89			31.88	5.5	30.62	100	123	Peak
2483.65	41.37	34.61	54	-12.63	31.88	5.5	30.62	100	123	Average
2483.65	51.96	45.2	74	-22.04	31.88	5.5	30.62	100	123	Peak
4960	38.45	30.18	54	-15.55	33.99	8.29	34.01	129	264	Average
4960	47.36	39.09	74	-26.64	33.99	8.29	34.01	129	264	Peak

Remarks:

- Emission Level = Read Level + Antenna Factor + Cable Loss - Preamp Factor
Margin value = Emission level – Limit value
- 2480 MHz: Fundamental frequency.
- The emission levels of other frequencies were very low against the limit.

9 kHz ~ 30 MHz Data:

The amplitude of spurious emissions attenuated more than 20 dB below the permissible value is not required to be report.

30 MHz ~ 1 GHz Worst-Case Data:

<LE 4.0>

EUT Test Condition		Measurement Detail	
Channel	Channel 39	Frequency Range	30 MHz ~ 1 GHz
Input Power	120 Vac, 60 Hz	Detector Function	Peak (PK) Quasi-peak (QP)
Environmental Conditions	25 deg. C, 65 % RH	Tested By	Karl Lee

Horizontal

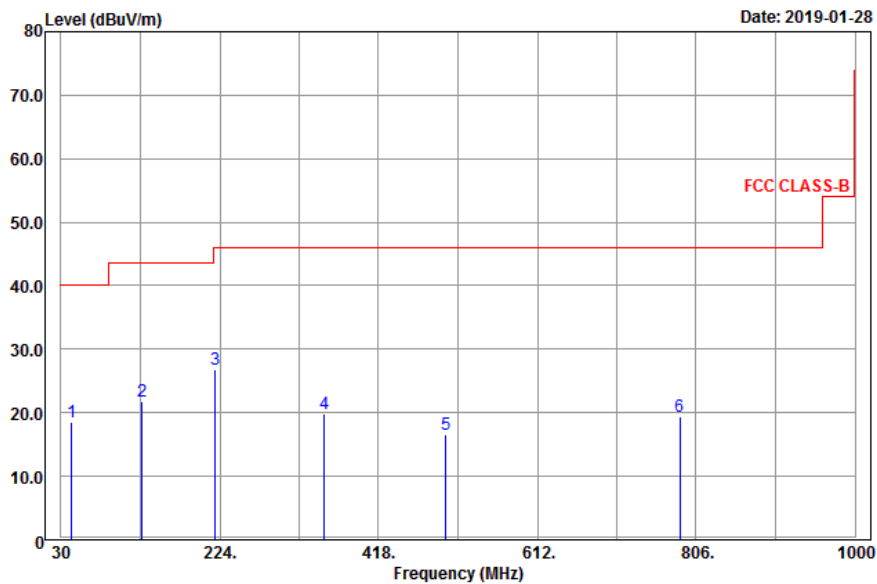

Vertical

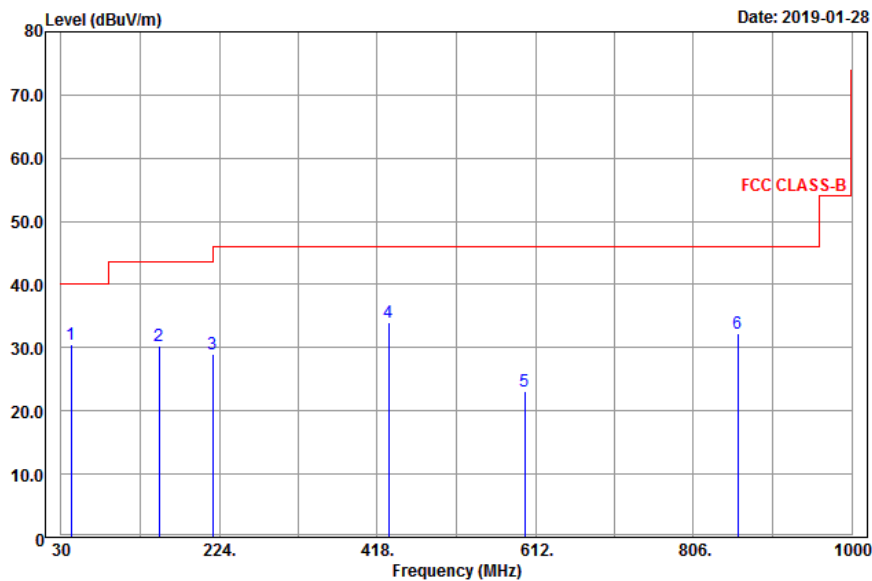

Antennal Polarity & Test Distance: Horizontal at 3 m										
Frequency (MHz)	Emission Level (dBuV/m)	Read Level (dBuV)	Limit (dBuV/m)	Margin (dB)	Antenna Factor (dB/m)	Cable Loss (dB)	Preamp Factor (dB)	Antenna Height (cm)	Table Angle (Degree)	Remark
42.96	18.44	35.94	40	-21.56	13.98	0.74	32.22	128	133	Peak
129.09	21.74	43.51	43.5	-21.76	9.08	1.38	32.23	195	127	Peak
218.73	26.84	46.09	46	-19.16	11.32	1.65	32.22	105	132	Peak
351.8	19.73	35.37	46	-26.27	14.24	2.19	32.07	185	3	Peak
500.2	16.6	29.71	46	-29.4	16.36	2.63	32.1	166	129	Peak
786.5	19.33	27.94	46	-26.67	20.2	3.27	32.08	104	155	Peak
Antennal Polarity & Test Distance: Vertical at 3 m										
Frequency (MHz)	Emission Level (dBuV/m)	Read Level (dBuV)	Limit (dBuV/m)	Margin (dB)	Antenna Factor (dB/m)	Cable Loss (dB)	Preamp Factor (dB)	Antenna Height (cm)	Table Angle (Degree)	Remark
42.15	30.43	47.93	40	-9.57	13.98	0.74	32.22	165	208	Peak
149.88	30.32	52.66	43.5	-13.18	8.41	1.52	32.27	177	149	Peak
216.3	29.05	48.36	46	-16.95	11.27	1.65	32.23	150	124	Peak
432.3	33.9	48.31	46	-12.1	15.35	2.41	32.17	156	174	Peak
598.9	23.17	34.59	46	-22.83	17.9	2.87	32.19	166	267	Peak
860	32.26	39.39	46	-13.74	21.16	3.44	31.73	130	48	Peak

Remarks:

- Emission Level = Read Level + Antenna Factor + Cable Loss - Preamp Factor
Margin value = Emission level – Limit value
- The emission levels of other frequencies were very low against the limit.

<LE 5.0>

EUT Test Condition		Measurement Detail	
Channel	Channel 39	Frequency Range	30 MHz ~ 1 GHz
Input Power	120 Vac, 60 Hz	Detector Function	Peak (PK) Quasi-peak (QP)
Environmental Conditions	25 deg. C, 65 % RH	Tested By	Charles Hsiao

Horizontal

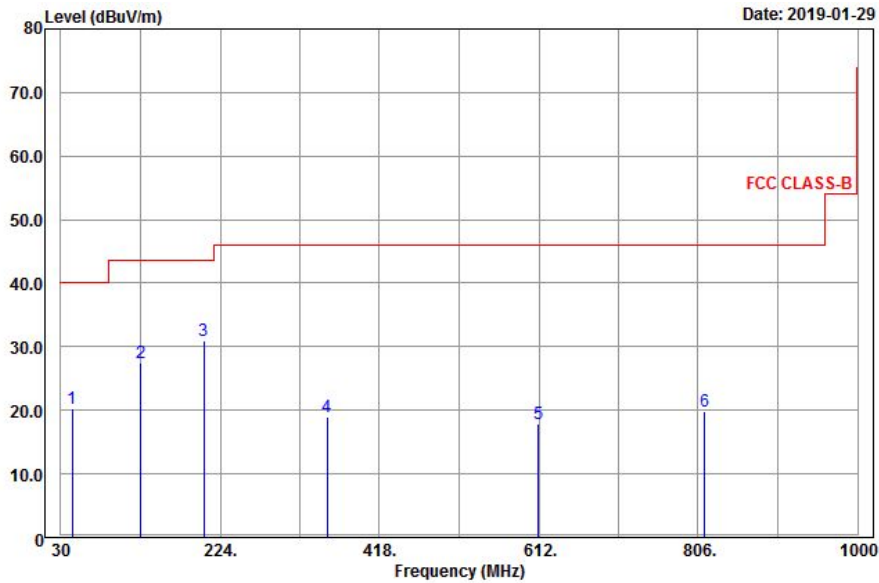

Vertical

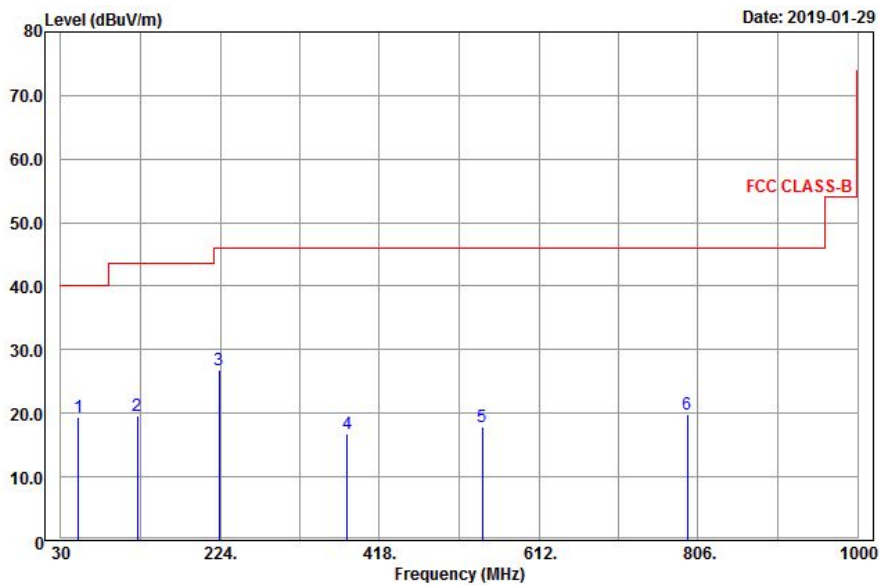

Antennal Polarity & Test Distance: Horizontal at 3 m

Frequency (MHz)	Emission Level (dBuV/m)	Read Level (dBuV)	Limit (dBuV/m)	Margin (dB)	Antenna Factor (dB/m)	Cable Loss (dB)	Preamp Factor (dB)	Antenna Height (cm)	Table Angle (Degree)	Remark
44.04	20.23	37.38	40	-19.77	14.17	0.9	32.22	135	216	Peak
127.47	27.49	49.04	43.5	-16.01	9.31	1.38	32.24	160	177	Peak
204.42	30.95	50.46	43.5	-12.55	11.12	1.65	32.28	105	264	Peak
353.9	19.07	34.69	46	-26.93	14.27	2.19	32.08	150	246	Peak
611.5	17.87	29.14	46	-28.13	18.04	2.87	32.18	188	149	Peak
813.8	19.85	27.97	46	-26.15	20.55	3.32	31.99	132	104	Peak

Antennal Polarity & Test Distance: Vertical at 3 m

Frequency (MHz)	Emission Level (dBuV/m)	Read Level (dBuV)	Limit (dBuV/m)	Margin (dB)	Antenna Factor (dB/m)	Cable Loss (dB)	Preamp Factor (dB)	Antenna Height (cm)	Table Angle (Degree)	Remark
51.87	19.48	36.43	40	-20.52	14.38	0.9	32.23	160	294	Peak
122.88	19.63	40.7	43.5	-23.87	9.79	1.38	32.24	155	34	Peak
222.78	26.86	45.94	46	-19.14	11.47	1.65	32.2	187	124	Peak
379.1	16.79	32.11	46	-29.21	14.58	2.26	32.16	124	57	Peak
542.9	17.78	30.27	46	-28.22	16.94	2.76	32.19	198	146	Peak
792.8	19.89	28.44	46	-26.11	20.25	3.27	32.07	168	235	Peak

Remarks:

- Emission Level = Read Level + Antenna Factor + Cable Loss - Preamp Factor
Margin value = Emission level – Limit value
- The emission levels of other frequencies were very low against the limit.

4.2 Conducted Emission Measurement

4.2.1 Limits of Conducted Emission Measurement

Frequency (MHz)	Conducted Limit (dBuV)	
	Quasi-Peak	Average
0.15 - 0.5	66 - 56	56 - 46
0.50 - 5.0	56	46
5.0 - 30.0	60	50

- Note: 1. The lower limit shall apply at the transition frequencies.
 2. The limit decreases in line with the logarithm of the frequency in the range of 0.15 to 0.50 MHz.

4.2.2 Test Instruments

Description & Manufacturer	Model No.	Serial No.	Date of Calibration	Due Date of Calibration
Test Receiver ROHDE & SCHWARZ	ESCS 30	100288	Jan. 03, 2019	Jan. 02, 2020
RF signal cable Woken	5D-FB	Cable-cond1-01	Sep. 05, 2018	Sep. 04, 2019
LISN ROHDE & SCHWARZ (EUT)	ENV216	101826	Feb. 21, 2019	Feb. 20, 2020
LISN ROHDE & SCHWARZ (Peripheral)	ESH3-Z5	100311	Aug. 19, 2018	Aug. 18, 2019
Software ADT	BV ADT_Cond_ V7.3.7.4	NA	NA	NA

- Note: 1. The calibration interval of the above test instruments is 12 months and the calibrations are traceable to NML/ROC and NIST/USA.
 2. The test was performed in HwaYa Shielded Room 1.
 3. The VCCI Site Registration No. is C-12040.

4.2.3 Test Procedures

- The EUT was placed 0.4 meters from the conducting wall of the shielded room with EUT being connected to the power mains through a line impedance stabilization network (LISN). Other support units were connected to the power mains through another LISN. The two LISNs provide 50 ohm/50 uH of coupling impedance for the measuring instrument.
- Both lines of the power mains connected to the EUT were checked for maximum conducted interference.
- The frequency range from 150 kHz to 30 MHz was searched. Emission levels under (Limit – 20 dB) was not recorded.

Note: The resolution bandwidth and video bandwidth of test receiver is 9 kHz for quasi-peak detection (QP) and average detection (AV) at frequency 0.15 MHz - 30 MHz.

4.2.4 Deviation from Test Standard

No deviation.

4.2.5 Test Setup

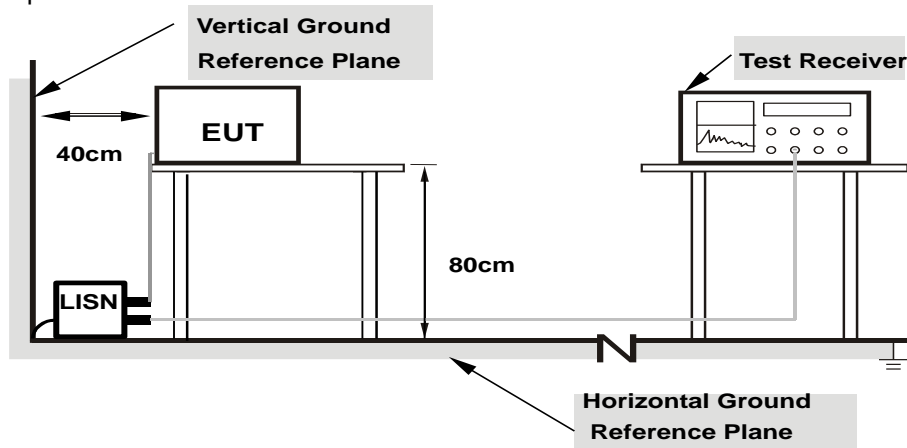

**Note: 1.Support units were connected to second LISN.
2.Both of LISNs (AMN) are 80 cm from EUT and at least 80 from other units and other metal planes**

4.2.6 EUT Operating Conditions

- a. Placed the EUT on the testing table.
- b. Set the EUT under transmission condition continuously at specific channel frequency.

4.2.7 Test Results

Frequency Range	150kHz ~ 30MHz	Detector Function & Resolution Bandwidth	Quasi-Peak (QP) / Average (AV), 9kHz
Input Power	120Vac, 60Hz	Environmental Conditions	25°C, 65%RH
Tested by	Jisyong Wang	Test Date	2019/4/16

Phase Of Power : Line (L)										
No	Frequency (MHz)	Correction Factor (dB)	Reading Value (dBuV)		Emission Level (dBuV)		Limit (dBuV)		Margin (dB)	
			Q.P.	AV.	Q.P.	AV.	Q.P.	AV.	Q.P.	AV.
1	0.15719	0.10	33.51	5.28	33.61	5.38	65.61	55.61	-32.00	-50.23
2	0.18128	0.10	28.64	8.68	28.74	8.78	64.43	54.43	-35.69	-45.65
3	0.25557	0.10	30.95	5.19	31.05	5.29	61.57	51.57	-30.52	-46.28
4	0.30640	0.11	26.81	4.04	26.92	4.15	60.07	50.07	-33.15	-45.92
5	0.41979	0.11	19.06	5.71	19.17	5.82	57.45	47.45	-38.28	-41.63
6	21.82313	1.18	23.50	5.85	24.68	7.03	60.00	50.00	-35.32	-42.97

Remarks:

1. Q.P. and AV. are abbreviations of quasi-peak and average individually.
2. The emission levels of other frequencies were very low against the limit.
3. Margin value = Emission level – Limit value
4. Correction factor = Insertion loss + Cable loss
5. Emission Level = Correction Factor + Reading Value

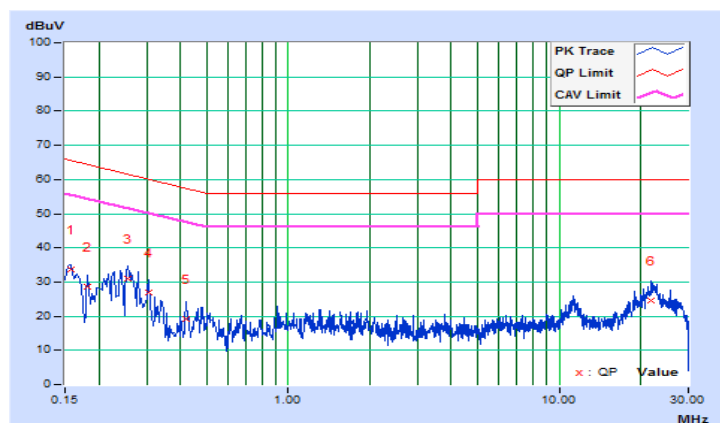

Frequency Range	150kHz ~ 30MHz	Detector Function & Resolution Bandwidth	Quasi-Peak (QP) / Average (AV), 9kHz
Input Power	120Vac, 60Hz	Environmental Conditions	25°C, 65%RH
Tested by	Jisyong Wang	Test Date	2019/4/16

Phase Of Power : Neutral (N)										
No	Frequency (MHz)	Correction Factor (dB)	Reading Value (dBuV)		Emission Level (dBuV)		Limit (dBuV)		Margin (dB)	
			Q.P.	AV.	Q.P.	AV.	Q.P.	AV.	Q.P.	AV.
1	0.15782	0.09	33.82	4.65	33.91	4.74	65.58	55.58	-31.67	-50.84
2	0.23993	0.09	30.22	9.92	30.31	10.01	62.10	52.10	-31.79	-42.09
3	0.27918	0.09	26.60	5.03	26.69	5.12	60.84	50.84	-34.15	-45.72
4	0.31813	0.10	26.51	4.65	26.61	4.75	59.76	49.76	-33.15	-45.01
5	2.28877	0.15	17.74	3.89	17.89	4.04	56.00	46.00	-38.11	-41.96
6	11.21530	0.53	19.63	5.65	20.16	6.18	60.00	50.00	-39.84	-43.82

Remarks:

1. Q.P. and AV. are abbreviations of quasi-peak and average individually.
2. The emission levels of other frequencies were very low against the limit.
3. Margin value = Emission level – Limit value
4. Correction factor = Insertion loss + Cable loss
5. Emission Level = Correction Factor + Reading Value

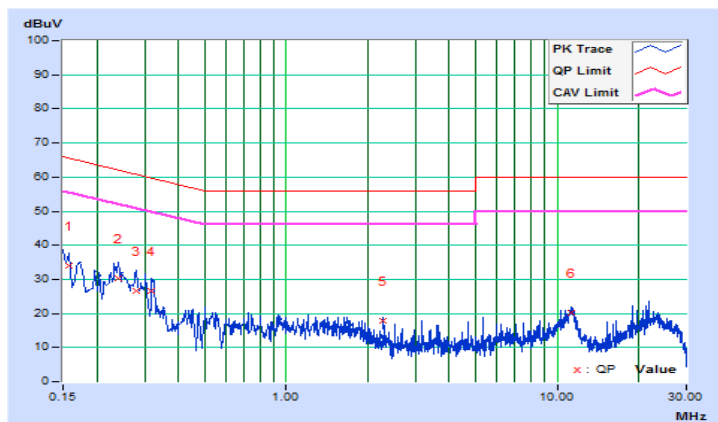

4.3 6 dB Bandwidth Measurement

4.3.1 Limits of 6 dB Bandwidth Measurement

The minimum of 6 dB Bandwidth Measurement is 0.5 MHz.

4.3.2 Test Setup

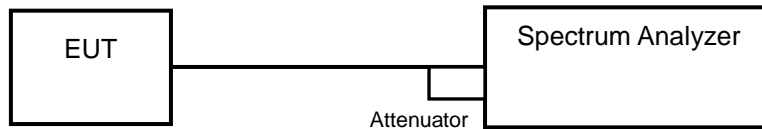

4.3.3 Test Instruments

Refer to section 4.1.2 to get information of above instrument.

4.3.4 Test Procedure

- Set resolution bandwidth (RBW) = 100 kHz
- Set the video bandwidth (VBW) $\geq 3 \times$ RBW, Detector = Peak.
- Trace mode = max hold.
- Sweep = auto couple.
- Measure the maximum width of the emission that is constrained by the frequencies associated with the two amplitude points (upper and lower) that are attenuated by 6 dB relative to the maximum level measured in the fundamental emission

4.3.5 Deviation from Test Standard

No deviation.

4.3.6 EUT Operating Conditions

The software provided by client to enable the EUT under transmission condition continuously at lowest, middle and highest channel frequencies individually.

4.3.7 Test Results

<LE 4.0>

Channel	Frequency (MHz)	6 dB Bandwidth (MHz)	Minimum Limit (MHz)	Pass / Fail
0	2402	0.64	0.5	Pass
19	2440	0.65	0.5	Pass
39	2480	0.66	0.5	Pass

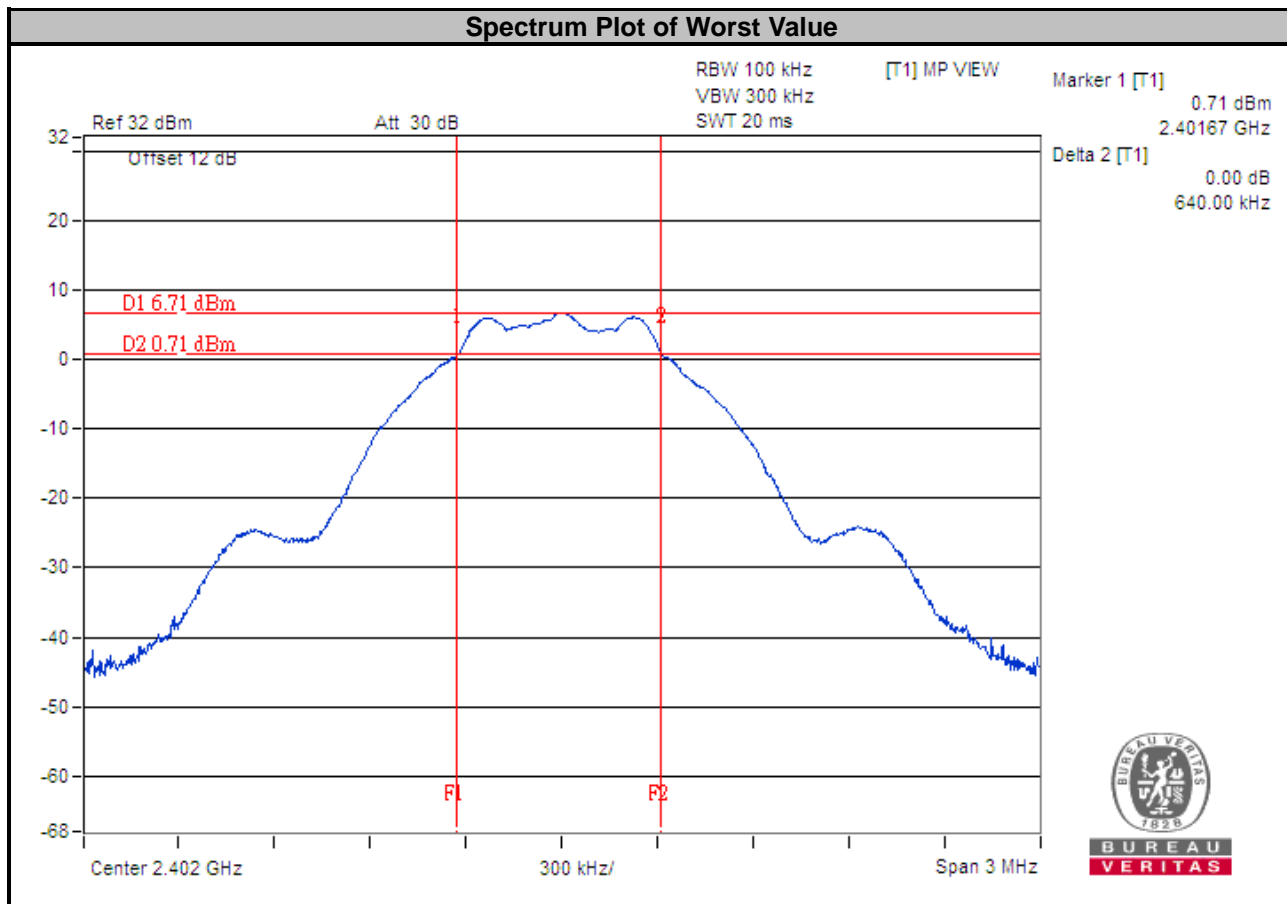

4.4 Occupied Bandwidth Measurement

4.4.1 Test Setup

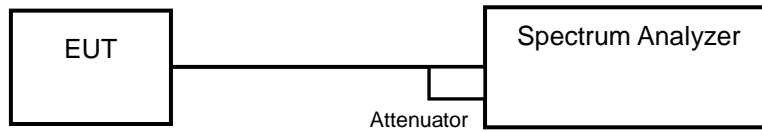

4.4.2 Test Instruments

Refer to section 4.1.2 to get information of above instrument.

4.4.3 Test Procedure

The transmitter output was connected to the spectrum analyzer through an attenuator. The bandwidth of the fundamental frequency was measured by spectrum analyzer with resolution bandwidth in the range of 1 % to 5 % of the anticipated emission bandwidth, and a video bandwidth at least 3x the resolution bandwidth and set the detector to PEAK. The width of a frequency band such that, below the lower and above the upper frequency limits, the mean powers emitted are each equal to a specified percentage 0.5 % of the total mean power of a given emission.

4.4.4 Deviation from Test Standard

No deviation.

4.4.5 EUT Operating Conditions

The software provided by client to enable the EUT under transmission condition continuously at lowest, middle and highest channel frequencies individually.

4.4.6 Test Results

<LE 4.0>

Channel	Frequency (MHz)	Occupied Bandwidth (MHz)	Pass / Fail
0	2402	1.03	Pass
19	2440	1.06	Pass
39	2480	1.04	Pass

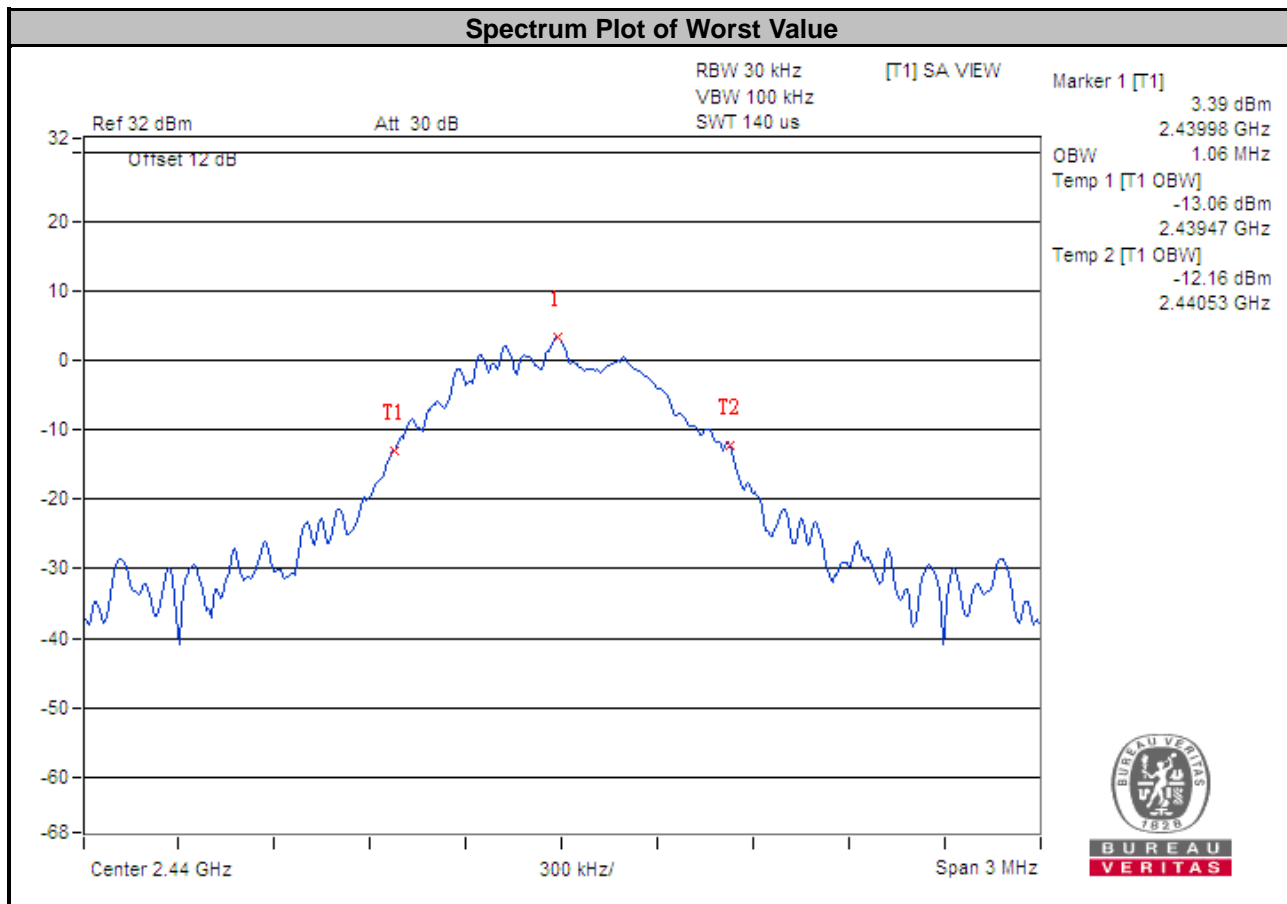

<LE 5.0>

Channel	Frequency (MHz)	Occupied Bandwidth (MHz)	Pass / Fail
0	2402	2.04	Pass
19	2440	2.03	Pass
39	2480	2.03	Pass

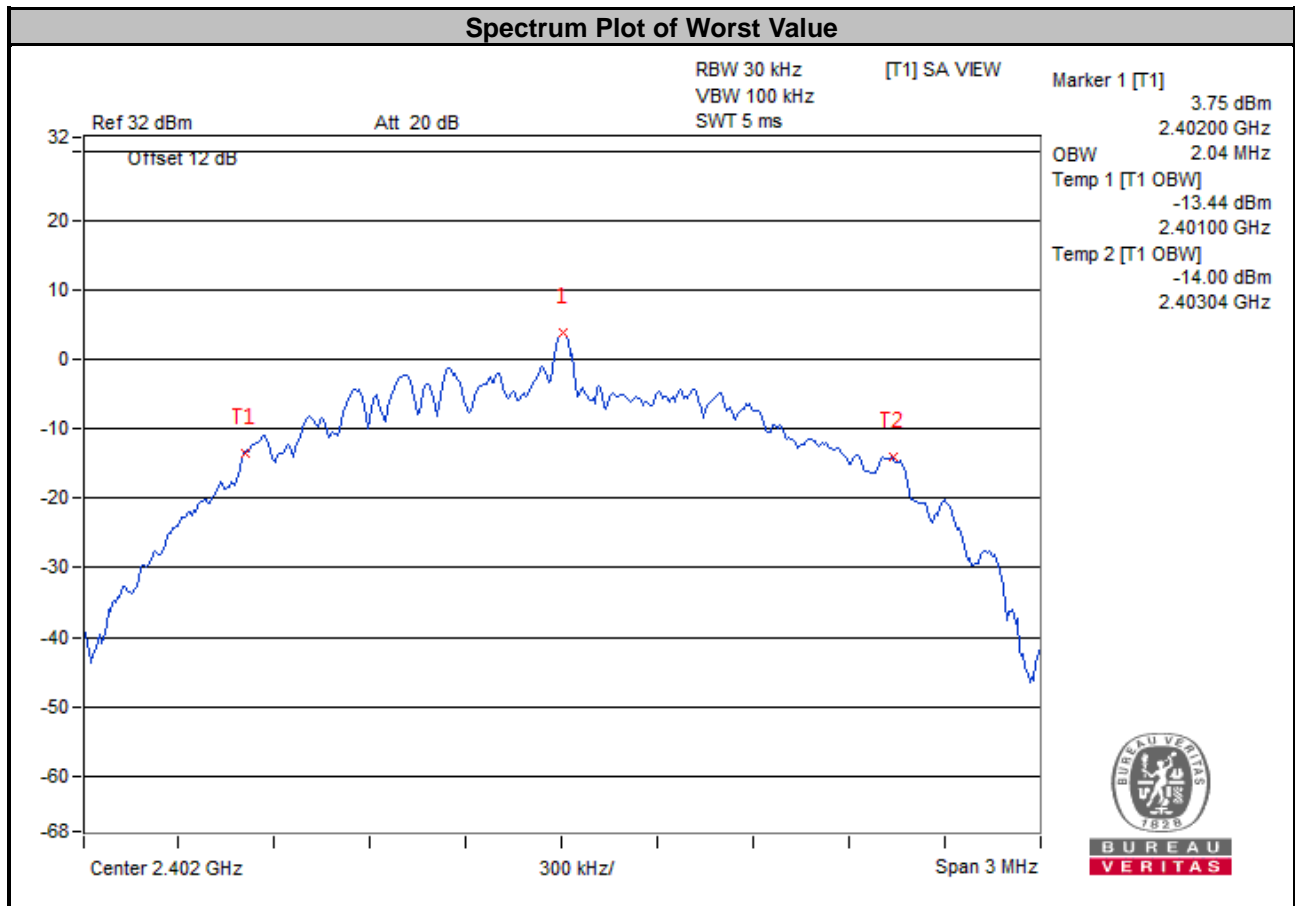

4.5 Conducted Output Power Measurement

4.5.1 Limits of Conducted Output Power Measurement

For systems using digital modulation in the 2400–2483.5 MHz bands: 1 Watt (30 dBm)

4.5.2 Test Setup

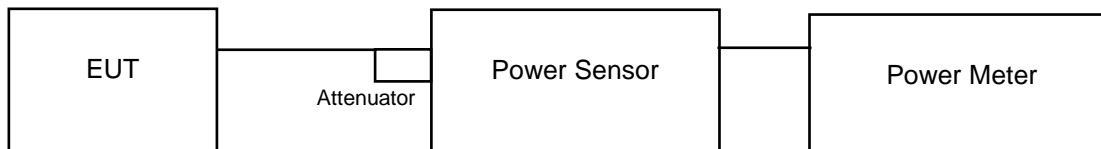

4.5.3 Test Instruments

Refer to section 4.1.2 to get information of above instrument.

4.5.4 Test Procedures

A peak power sensor was used on the output port of the EUT. A power meter was used to read the response of the peak power sensor. Record the power level.

4.5.5 Deviation from Test Standard

No deviation.

4.5.6 EUT Operating Conditions

The software provided by client to enable the EUT under transmission condition continuously at lowest, middle and highest channel frequencies individually.

4.5.7 Test Results

<LE 4.0>

Channel	Frequency (MHz)	Peak Power (mW)	Peak Power (dBm)	Limit (dBm)	Pass / Fail
0	2402	4.416	6.45	30	Pass
19	2440	4.550	6.58	30	Pass
39	2480	4.875	6.88	30	Pass

<LE 5.0>

Channel	Frequency (MHz)	Peak Power (mW)	Peak Power (dBm)	Limit (dBm)	Pass / Fail
0	2402	4.581	6.61	30	Pass
19	2440	4.864	6.87	30	Pass
39	2480	5.395	7.32	30	Pass

4.6 Power Spectral Density Measurement

4.6.1 Limits of Power Spectral Density Measurement

The Maximum of Power Spectral Density Measurement is 8 dBm.

4.6.2 Test Setup

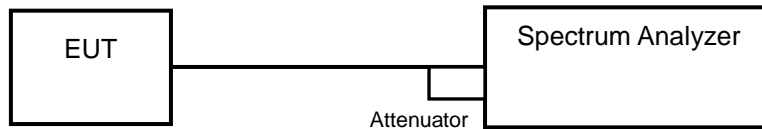

4.6.3 Test Instruments

Refer to section 4.1.2 to get information of above instrument.

4.6.4 Test Procedure

- a. Set analyzer center frequency to DTS channel center frequency.
- b. Set the span to 1.5 times the DTS bandwidth.
- c. Set the RBW to: $3 \text{ kHz} \leq \text{RBW} \leq 100 \text{ kHz}$.
- d. Set the VBW $\geq 3 \times \text{RBW}$.
- e. Detector = peak.
- f. Sweep time = auto couple.
- g. Trace mode = max hold.
- h. Allow trace to fully stabilize.
- i. Use the peak marker function to determine the maximum amplitude level within the RBW.

4.6.5 Deviation from Test Standard

No deviation.

4.6.6 EUT Operating Condition

The software provided by client to enable the EUT under transmission condition continuously at lowest, middle and highest channel frequencies individually.

4.6.7 Test Results

<LE 4.0>

Channel	Frequency (MHz)	PSD (dBm/3 kHz)	Limit (dBm/3 kHz)	Pass / Fail
0	2402	-8.26	8	Pass
19	2440	-7.87	8	Pass
39	2480	-7.59	8	Pass

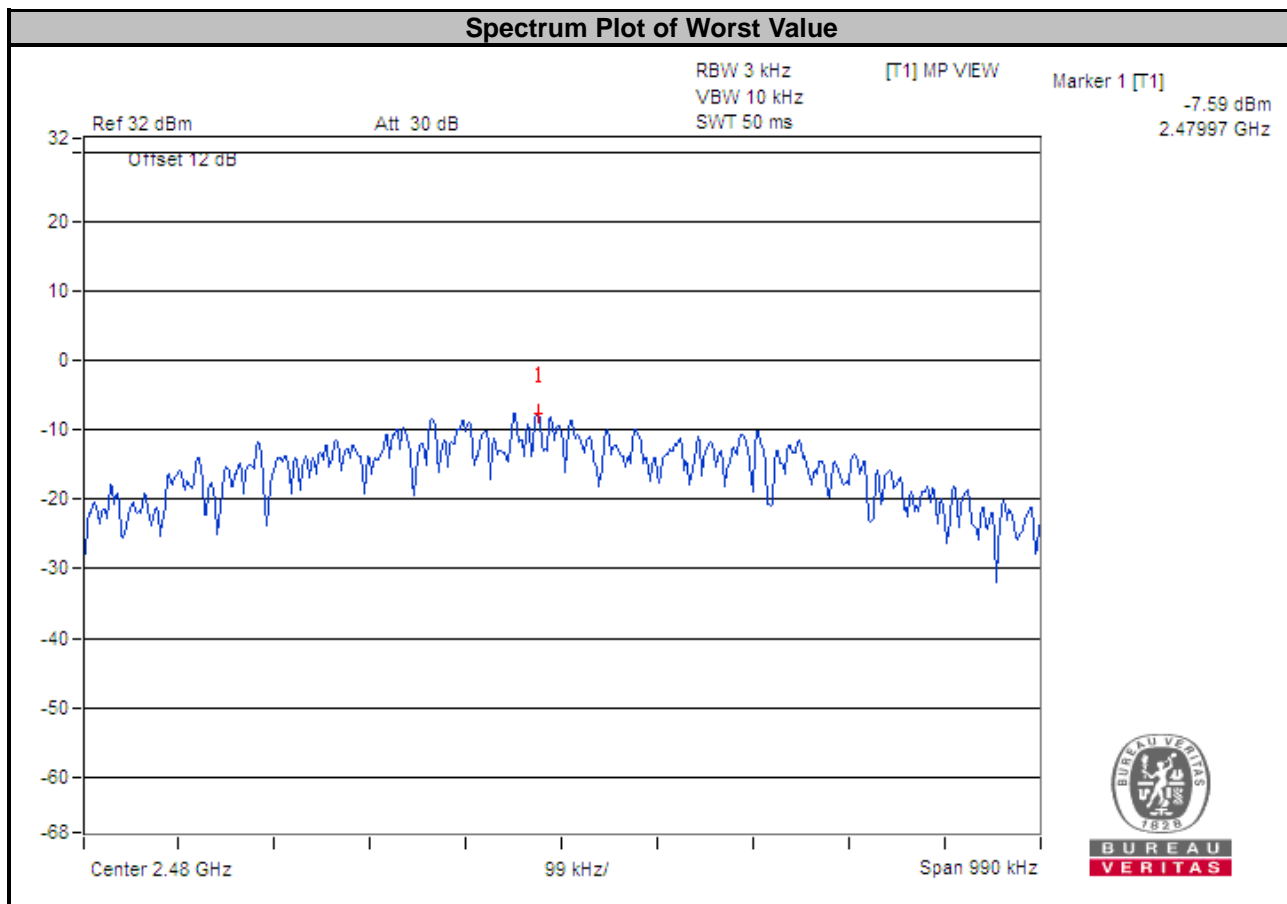

<LE 5.0>

Channel	Frequency (MHz)	PSD (dBm/3 kHz)	Limit (dBm/3 kHz)	Pass / Fail
0	2402	-11.30	8	Pass
19	2440	-11.81	8	Pass
39	2480	-11.09	8	Pass

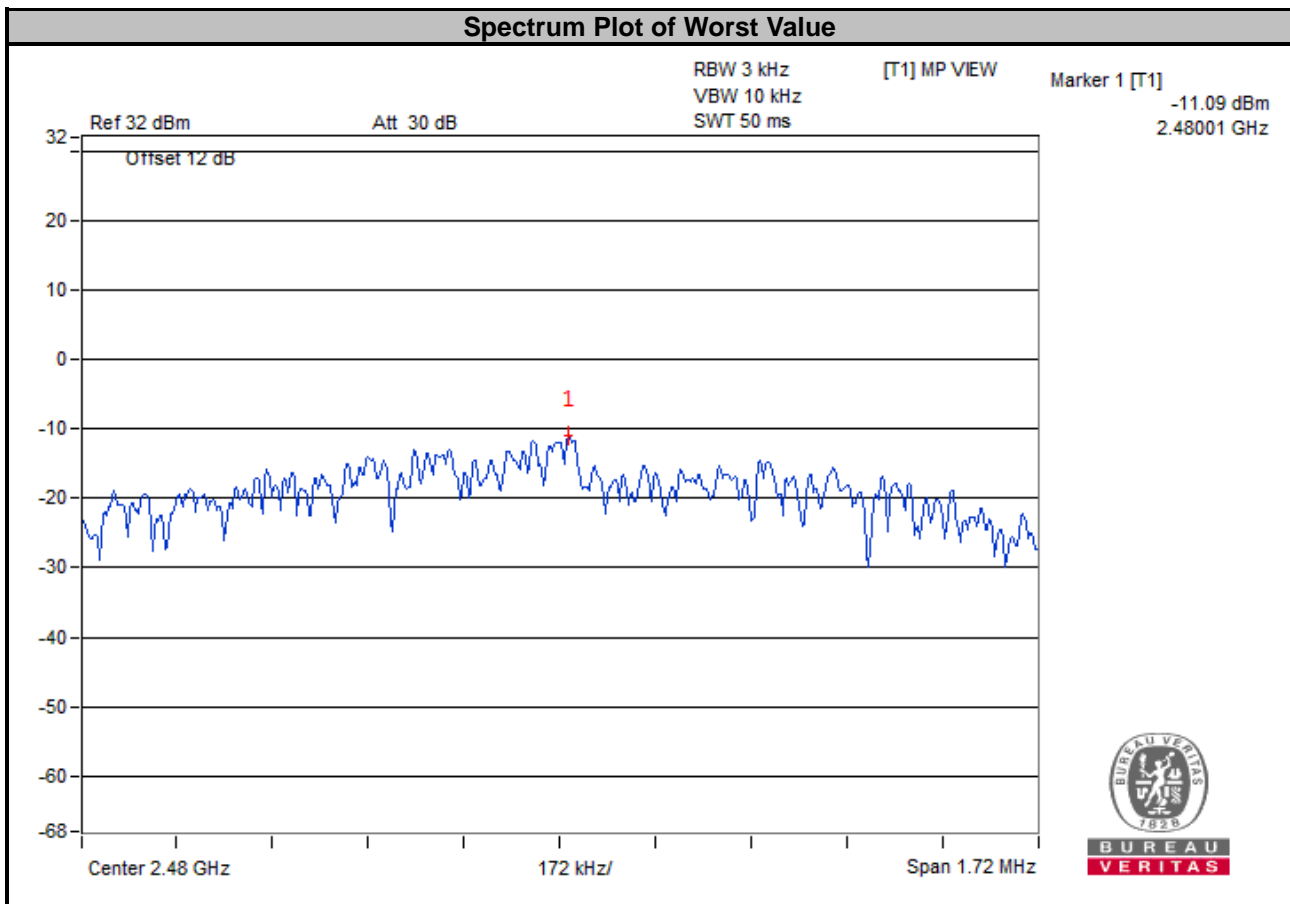

4.7 Conducted Out of Band Emission Measurement

4.7.1 Limits of Conducted Out of Band Emission Measurement

Below -20 dB of the highest emission level of operating band (in 100 kHz Resolution Bandwidth).

4.7.2 Test Setup



4.7.3 Test Instruments

Refer to section 4.1.2 to get information of above instrument.

4.7.4 Test Procedure

MEASUREMENT PROCEDURE REF

1. Set the RBW = 100 kHz.
2. Set the VBW \geq 300 kHz.
3. Detector = peak.
4. Sweep time = auto couple.
5. Trace mode = max hold.
6. Allow trace to fully stabilize.
7. Use the peak marker function to determine the maximum power level in any 100 kHz band segment within the fundamental EBW.

MEASUREMENT PROCEDURE OOB

1. Set RBW = 100 kHz.
2. Set VBW \geq 300 kHz.
3. Detector = peak.
4. Sweep = auto couple.
5. Trace Mode = max hold.
6. Allow trace to fully stabilize.
7. Use the peak marker function to determine the maximum amplitude level.

4.7.5 Deviation from Test Standard

No deviation.

4.7.6 EUT Operating Condition

The software provided by client to enable the EUT under transmission condition continuously at lowest, middle and highest channel frequencies individually.

4.7.7 Test Results

<LE 4.0>

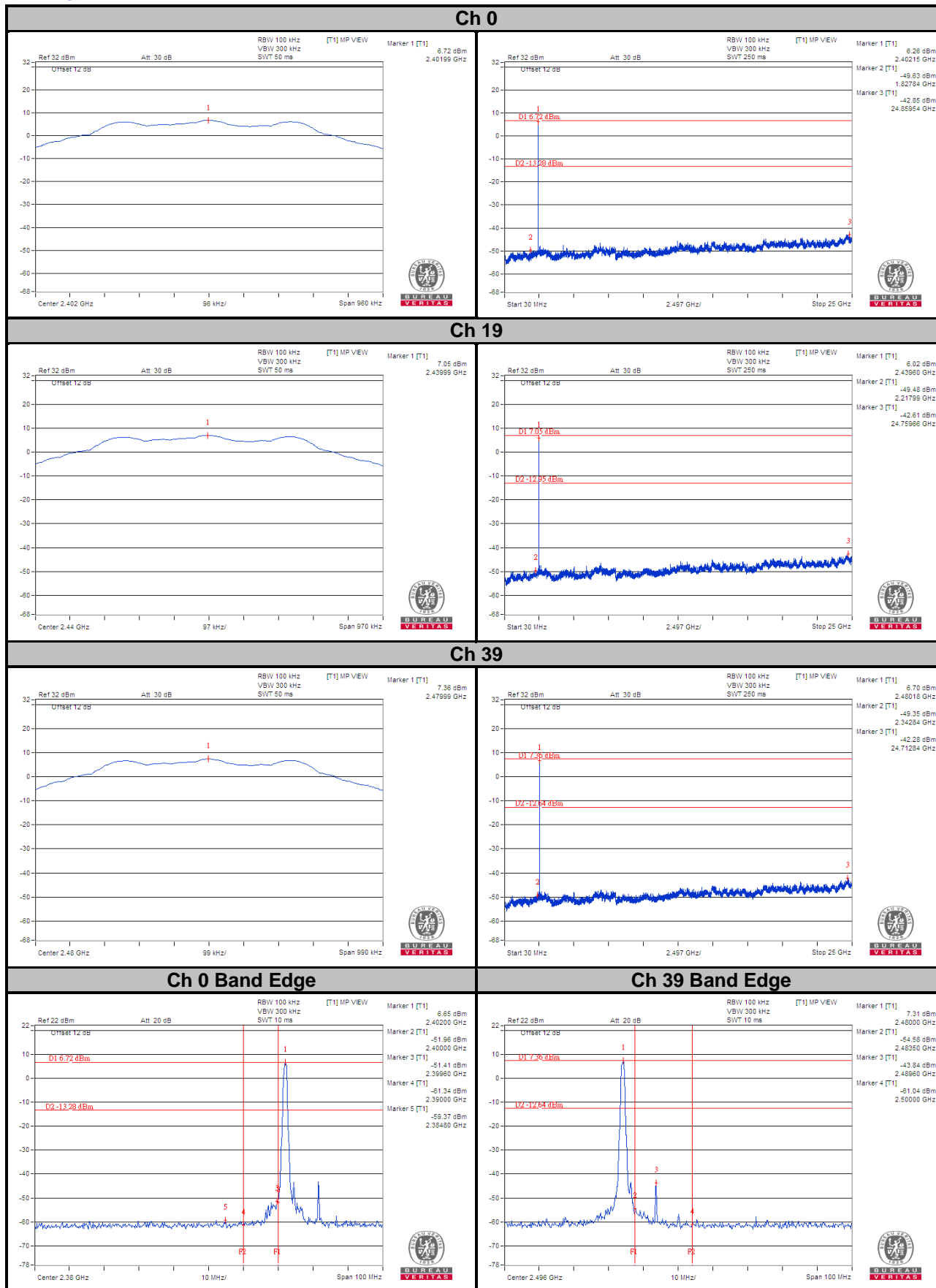

<LE 5.0>

Ch 0

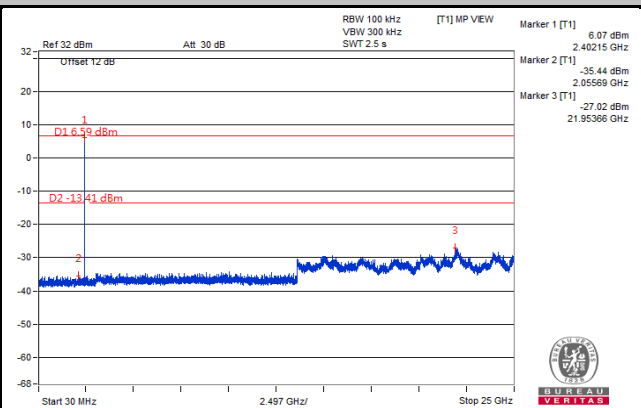
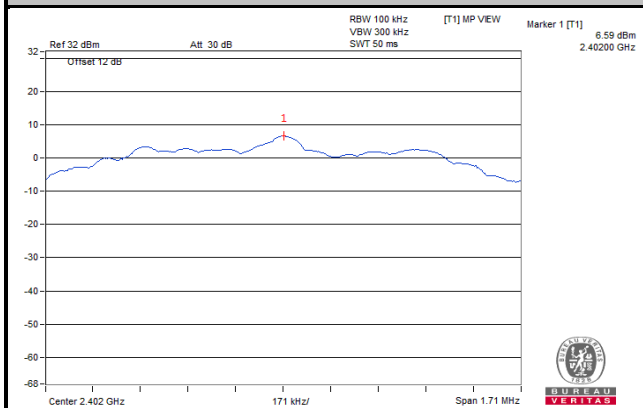

Ch 19

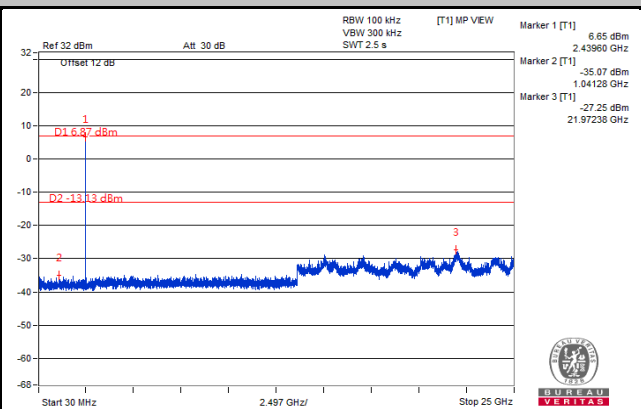
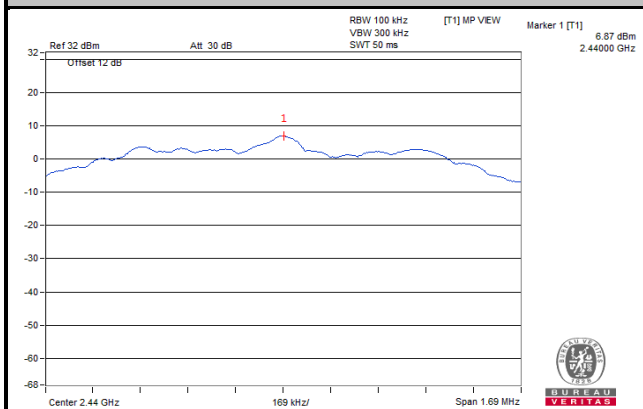

Ch 39

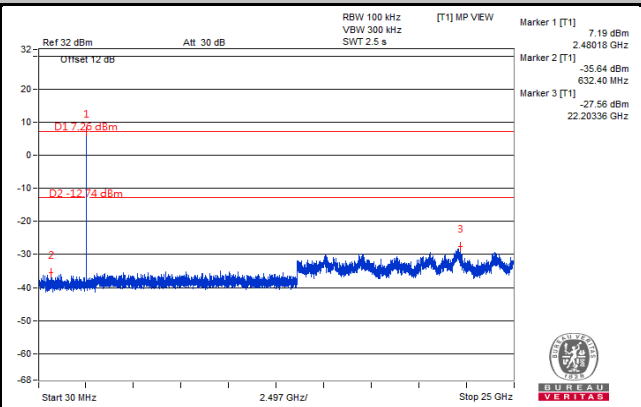
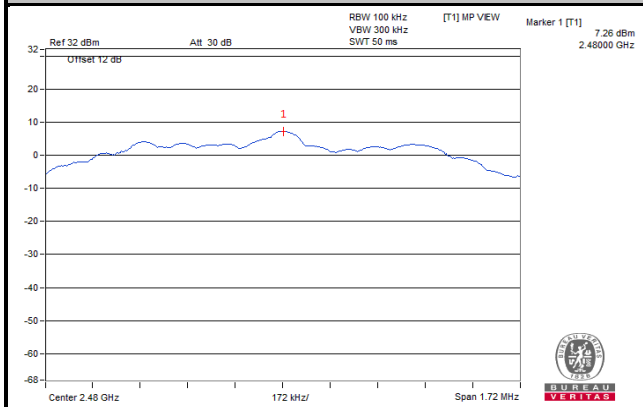

Ch 0 Band Edge

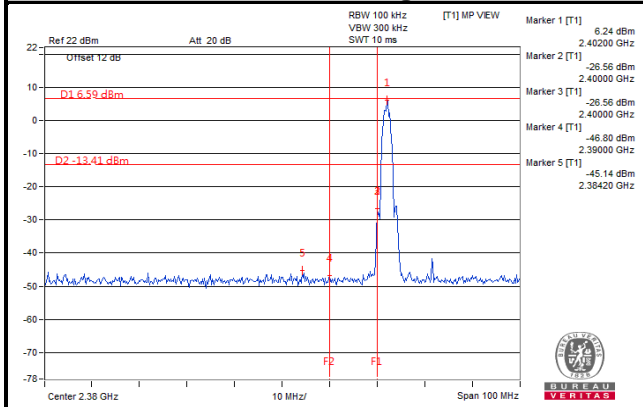

Ch 39 Band Edge

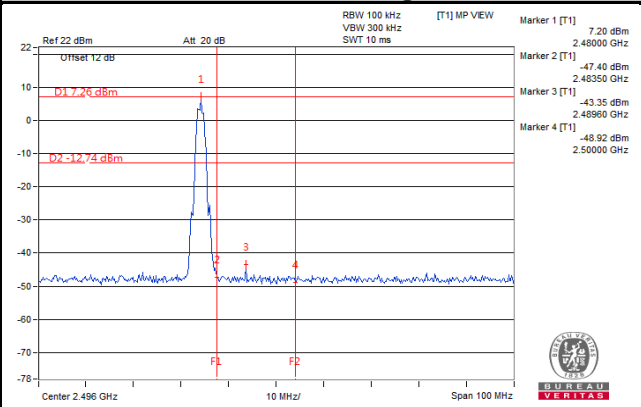

5 Pictures of Test Arrangements

Please refer to the attached file (Test Setup Photo).

Appendix – Information of the Testing Laboratories

We, Bureau Veritas Consumer Products Services (H.K.) Ltd., Taoyuan Branch, were founded in 1988 to provide our best service in EMC, Radio, Telecom and Safety consultation. Our laboratories are FCC recognized accredited test firms and accredited according to ISO/IEC 17025.

If you have any comments, please feel free to contact us at the following:

Lin Kou EMC/RF Lab

Tel: 886-2-26052180

Fax: 886-2-26051924

Hsin Chu EMC/RF/Telecom Lab

Tel: 886-3-6668565

Fax: 886-3-6668323

Hwa Ya EMC/RF/Safety

Tel: 886-3-3183232

Fax: 886-3-3270892

Email: service.adt@tw.bureauveritas.com

Web Site: www.bureauveritas-adt.com

The address and road map of all our labs can be found in our web site also.

--- END ---