

FCC Test Report

Equipment : LCD TABLET
Brand Name : Wacom
Model No. : DTH-2452
FCC ID : HV4DTH2452
Standard : 47 CFR FCC Part 15.209
Operating Band : 667kHz
FCC Classification : DCD
Applicant / Manufacturer : Wacom Co., Ltd.
2-510-1 Toyonodai, Kazo-shi, Saitama 349-1148 Japan

The product sample received on Oct. 19, 2017 and completely tested on Nov. 01, 2017. We, SPORTON, would like to declare that the tested sample has been evaluated in accordance with the procedures given in ANSI C63.10-2013 and shown compliance with the applicable technical standards.

The test results in this report apply exclusively to the tested model / sample. Without written approval of SPORTON INTERNATIONAL INC., the test report shall not be reproduced except in full.

Reviewed by:



Phoenix Chen / Assistant Manager





Table of Contents

1	GENERAL DESCRIPTION	5
1.1	Information.....	5
1.2	Testing Applied Standards	6
1.3	Testing Location Information	6
1.4	Measurement Uncertainty	7
2	TEST CONFIGURATION OF EUT	8
2.1	The Worst Case Modulation Configuration	8
2.2	Test Channel Frequencies Configuration.....	8
2.3	The Worst Case Measurement Configuration.....	8
2.4	Accessory and Support Equipment.....	9
2.5	Test Setup Diagram	10
3	TRANSMITTER TEST RESULT	12
3.1	AC Power-line Conducted Emissions	12
3.2	Transmitter Radiated Emissions	16
3.3	Emission Bandwidth	24
4	TEST EQUIPMENT AND CALIBRATION DATA	26

APPENDIX A. TEST PHOTOS
PHOTOGRAPHS OF EUT v01



Summary of Test Result

Conformance Test Specifications					
Report Clause	Ref. Std. Clause	Description	Measured	Limit	Result
1.1.2	15.203	Antenna Requirement	Antenna connector mechanism complied	FCC 15.203	Complied
3.1	15.207	AC Power-line Conducted Emissions	[dBuV]:0.40831MHz 39.33 (Margin 18.35dB) - QP 38.88 (Margin 8.80dB) - AV	FCC 15.207	Complied
3.2	15.209	Transmitter Radiated Emissions	[dBuV/m at 3m]:505.300MHz 43.17(Margin 2.83dB) - QP	FCC 15.209	Complied
3.3	15.215(c)	Emission Bandwidth	99% Bandwidth: 23.01 [kHz] 20dB Bandwidth: 17.37 [kHz]	N/A	Complied



Revision History

Report No.	Version	Description	Issued Date
FR7O1816AP	Rev. 01	Initial issue of report	Nov. 17, 2017



1 General Description

1.1 Information

1.1.1 RF General Information

RF General Information			
Modulation	Ch. Frequency (kHz)	Channel Number	Field Strength (dBuV/@1m)
ASK	667	1	70.78
Note 1: Field strength performed peak level at 1m.			

1.1.2 Antenna Information

Antenna Category	
<input checked="" type="checkbox"/>	Integral antenna (antenna permanently attached)
<input type="checkbox"/>	Temporary RF connector provided
<input checked="" type="checkbox"/>	No temporary RF connector provided Transmit chains bypass antenna and soldered temporary RF connector provided for connected measurement. In case of conducted measurements the transmitter shall be connected to the measuring equipment via a suitable attenuator and correct for all losses in the RF path.
<input type="checkbox"/>	External antenna (dedicated antennas)
<input type="checkbox"/>	Single power level with corresponding antenna(s).
<input type="checkbox"/>	Multiple power level and corresponding antenna(s).

No.	Ant. Cat.	Ant. Type
1	Integral	Array Coli Pointing



1.1.3 Type of EUT

Identify EUT	
Presentation of Equipment	<input checked="" type="checkbox"/> Production ; <input type="checkbox"/> Pre-Production ; <input type="checkbox"/> Prototype
Type of EUT	
<input checked="" type="checkbox"/> Stand-alone	
<input type="checkbox"/> Combined (EUT where the radio part is fully integrated within another device) Combined Equipment - Brand Name / Model No.: ...	
<input type="checkbox"/> Plug-in radio (EUT intended for a variety of host systems) Host System - Brand Name / Model No.: ...	
<input type="checkbox"/> Other:	

1.1.4 Test Signal Duty Cycle

Operated Mode for Worst Duty Cycle	
<input checked="" type="checkbox"/> Operated normal mode for worst duty cycle	
<input type="checkbox"/> Operated test mode for worst duty cycle	
Test Signal Duty Cycle (x)	
<input checked="" type="checkbox"/> 100.00%	

1.1.5 EUT Operational Condition

Supply Voltage	<input checked="" type="checkbox"/> AC mains	<input type="checkbox"/> DC	
Type of DC Source	<input type="checkbox"/> From Battery	<input checked="" type="checkbox"/> External AC adapter	<input type="checkbox"/> From System

1.2 Testing Applied Standards

According to the specifications of the manufacturer, the EUT must comply with the requirements of the following standards:

- 47 CFR FCC Part 15
- ANSI C63.10-2013

1.3 Testing Location Information

Testing Location				
<input checked="" type="checkbox"/>	HWA YA	ADD : No. 52, Hwa Ya 1st Rd., Hwa Ya Technology Park, Kwei-Shan District, Tao Yuan City, Taiwan, R.O.C. TEL : 886-3-327-3456 FAX : 886-3-327-0973		
Test site Designation No. TW1190 with FCC.				
Test Condition	Test Site No.	Test Engineer	Test Environment	Test Date
AC Conduction	CO04-HY	Lynus Tsai	23.3°C / 56%	01/Nov/2017
RF Conducted	TH01-HY	Tim Chen	26.2°C / 65.7%	01/Nov/2017
Radiated Emission	03CH02-HY	Lynus Tsai	23.3°C / 56%	23/Oct/2017



1.4 Measurement Uncertainty

ISO/IEC 17025 requires that an estimate of the measurement uncertainties associated with the emissions test results be included in the report. The measurement uncertainties given below are based on a 95% confidence level (based on a coverage factor (k=2))

Measurement Uncertainty		
Test Item		Uncertainty
AC power-line conducted emissions		±2.3 dB
Emission bandwidth, 6dB bandwidth		±0.6 %
RF output power, conducted		±0.1 dB
Power density, conducted		±0.6 dB
Unwanted emissions, conducted	9 – 150 kHz	±0.4 dB
	0.15 – 30 MHz	±0.4 dB
	30 – 1000 MHz	±0.6 dB
	1 – 18 GHz	±0.5 dB
	18 – 40 GHz	±0.5 dB
	40 – 200 GHz	N/A
All emissions, radiated	9 – 150 kHz	±2.5 dB
	0.15 – 30 MHz	±2.3 dB
	30 – 1000 MHz	±2.6 dB
	1 – 18 GHz	±3.6 dB
	18 – 40 GHz	±3.8 dB
	40 – 200 GHz	N/A
Temperature		±0.8 °C
Humidity		±5 %
DC and low frequency voltages		±0.9 %
Time		±1.4 %
Duty Cycle		±0.6 %

2 Test Configuration of EUT

2.1 The Worst Case Modulation Configuration



Transmitter Mode	Field Strength (dBuV/m@1m)	Field Strength (dBuV/m@3m)
Touch Panel	70.78	51.70

2.2 Test Channel Frequencies Configuration

Modulation	Test Channel Frequencies (kHz)
ASK	667

2.3 The Worst Case Measurement Configuration

The Worst Case Mode for Following Conformance Tests	
Tests Item	AC power-line conducted emissions
Condition	AC power-line conducted measurement for line and neutral Test Voltage: 120Vac / 60Hz
Operating Mode	Operating Mode Description
1	Adapter Mode

The Worst Case Mode for Following Conformance Tests		
Tests Item	Emission Bandwidth, Field Strength of Fundamental Emissions Transmitter Radiated Unwanted Emissions	
Test Condition	Radiated measurement	
Operating Mode	Operating Mode Description	
1	Adapter Mode	
Transmitter Mode	Touch Panel	
Orthogonal Planes of EUT	Y Plane	Z Plane
		
Worst Planes of EUT	V	

2.4 Accessory and Support Equipment

Accessories Information				
AC Adapter	Brand Name	DELTA	Model Name	DPS-65VB
	Power Rating	I/P: 100 - 240Vac, 2A, O/P: 12Vdc, 5.417A		
	Power Cord	DC output cable 1.14 meter, shielded cable, with ferrite core AC output cable 1.67 meter, Non-Shielded cable, w/o ferrite core		
Touch Pen	Brand Name	Wacom	Model Name	No-stroke pressure stylus with ink refill
USB Cable	Signal Line	1.99 meter, shielded cable, w/o ferrite core		
DVI Cable	Signal Line	1.96 meter, shield cable, with ferrite core		
DVI to D-SUB Cable	Signal Line	1.94 meter, shielded cable, with ferrite core		

Note: Regarding to more detail and other information, please refer to user manual.

Support Equipment – RF Conducted				
No.	Equipment	Brand Name	Model Name	FCC ID
1	Notebook	DELL	E5410	DoC
2	Adapter for Notebook	DELL	HA65NM130	DoC

Support Equipment – AC Line Conducted Emission				
No.	Equipment	Brand Name	Model Name	FCC ID
1	Notebook	DELL	E4300	DoC
2	Adapter for Notebook	DELL	LA90PS1-00	DoC

Support Equipment – Radiated Emission				
No.	Equipment	Brand Name	Model Name	FCC ID
1	Notebook	DELL	E4300	DoC
2	Adapter for Notebook	DELL	LA90PS1-00	DoC

2.5 Test Setup Diagram

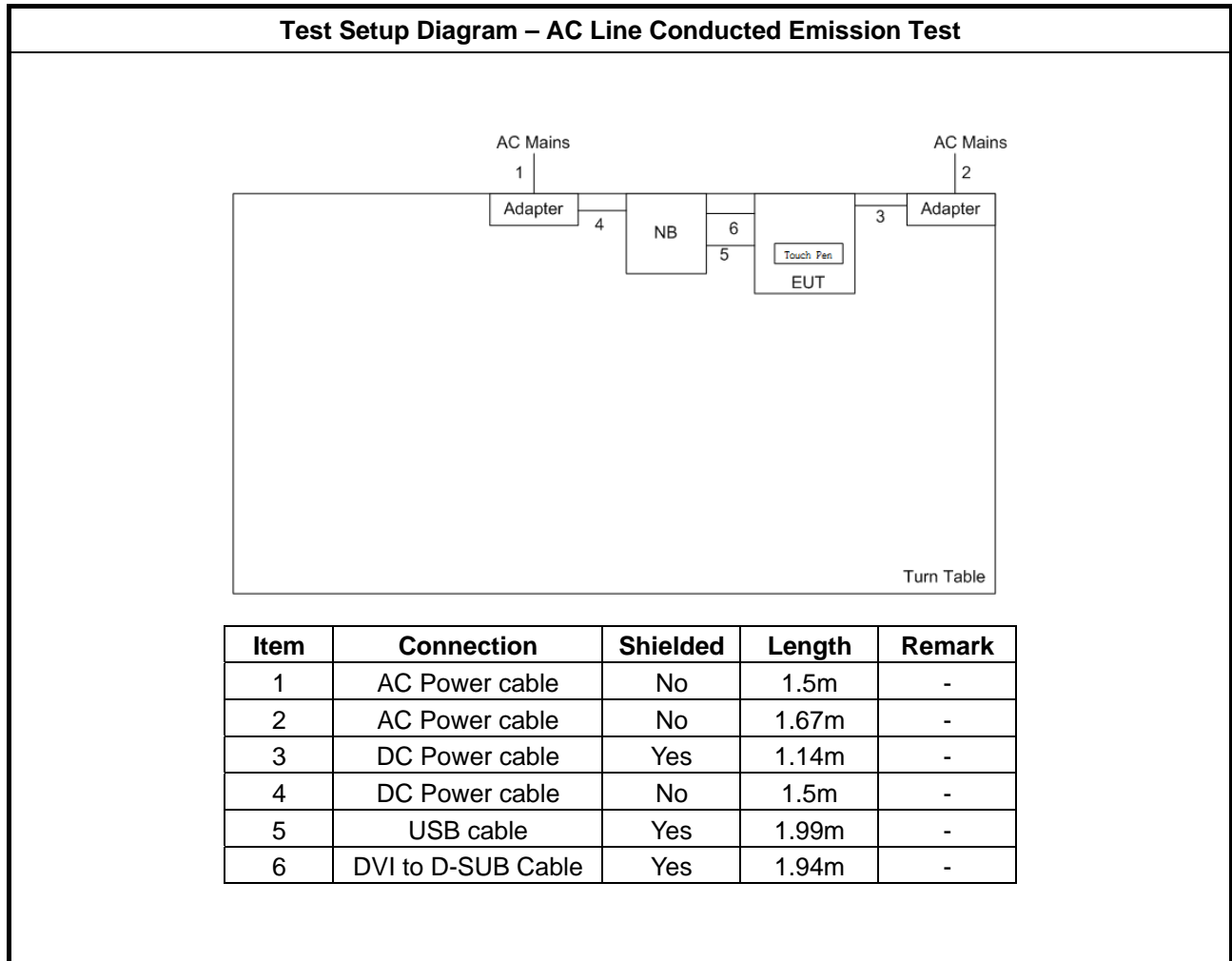

Test Setup Diagram – Radiated Test

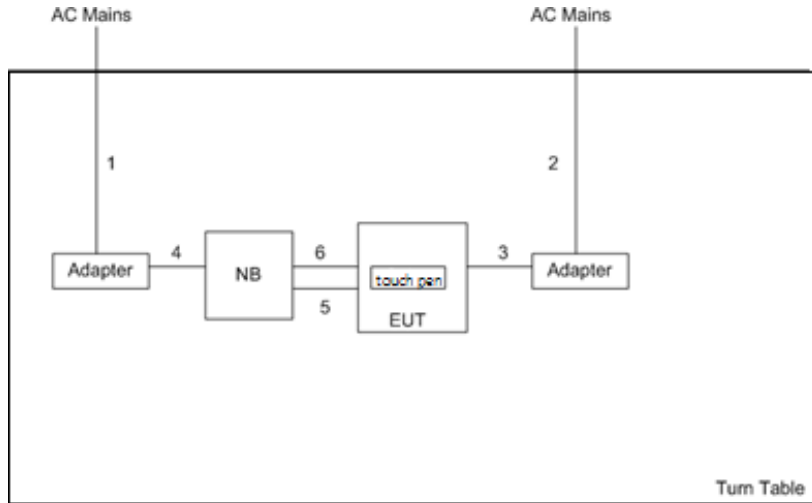

Item	Connection	Shielded	Length	Remark
1	AC Power cable	No	1.5m	-
2	AC Power cable	No	1.67m	-
3	DC Power cable	Yes	1.14m	-
4	DC Power cable	No	1.5m	-
5	USB cable	Yes	1.99m	-
6	DVI to D-SUB Cable	Yes	1.94m	-

3 Transmitter Test Result

3.1 AC Power-line Conducted Emissions

3.1.1 AC Power-line Conducted Emissions Limit

AC Power-line Conducted Emissions Limit		
Frequency Emission (MHz)	Quasi-Peak	Average
0.15-0.5	66 - 56 *	56 - 46 *
0.5-5	56	46
5-30	60	50

Note 1: * Decreases with the logarithm of the frequency.

3.1.2 Measuring Instruments

Refer a test equipment and calibration data table in this test report.

3.1.3 Test Procedures

Test Method	
<input checked="" type="checkbox"/>	Refer as ANSI C63.10-2013, clause 6.2 for AC power-line conducted emissions.
<input checked="" type="checkbox"/>	If AC conducted emissions fall in operating band, then following below test method confirm final result.
<input type="checkbox"/>	Accept measurements done with a suitable dummy load replacing the antenna under the following conditions: (1) Perform the AC line conducted tests with the antenna connected to determine compliance with FCC 15.207 limits outside the transmitter's fundamental emission band; (2) Retest with a dummy load to determine compliance with FCC 15.207 limits within the transmitter's fundamental emission band.
<input checked="" type="checkbox"/>	For a device with a permanent antenna operating at or below 30 MHz, accept measurements done with a suitable dummy load, in lieu of the permanent antenna under the following conditions: (1) Perform the AC line conducted tests with the permanent antenna to determine compliance with the FCC 15.207 limits outside the transmitter's fundamental emission band; (2) Retest with a dummy load in lieu of the permanent antenna to determine compliance with the FCC 15.207 limits within the transmitter's fundamental emission band.

3.1.4 Test Setup

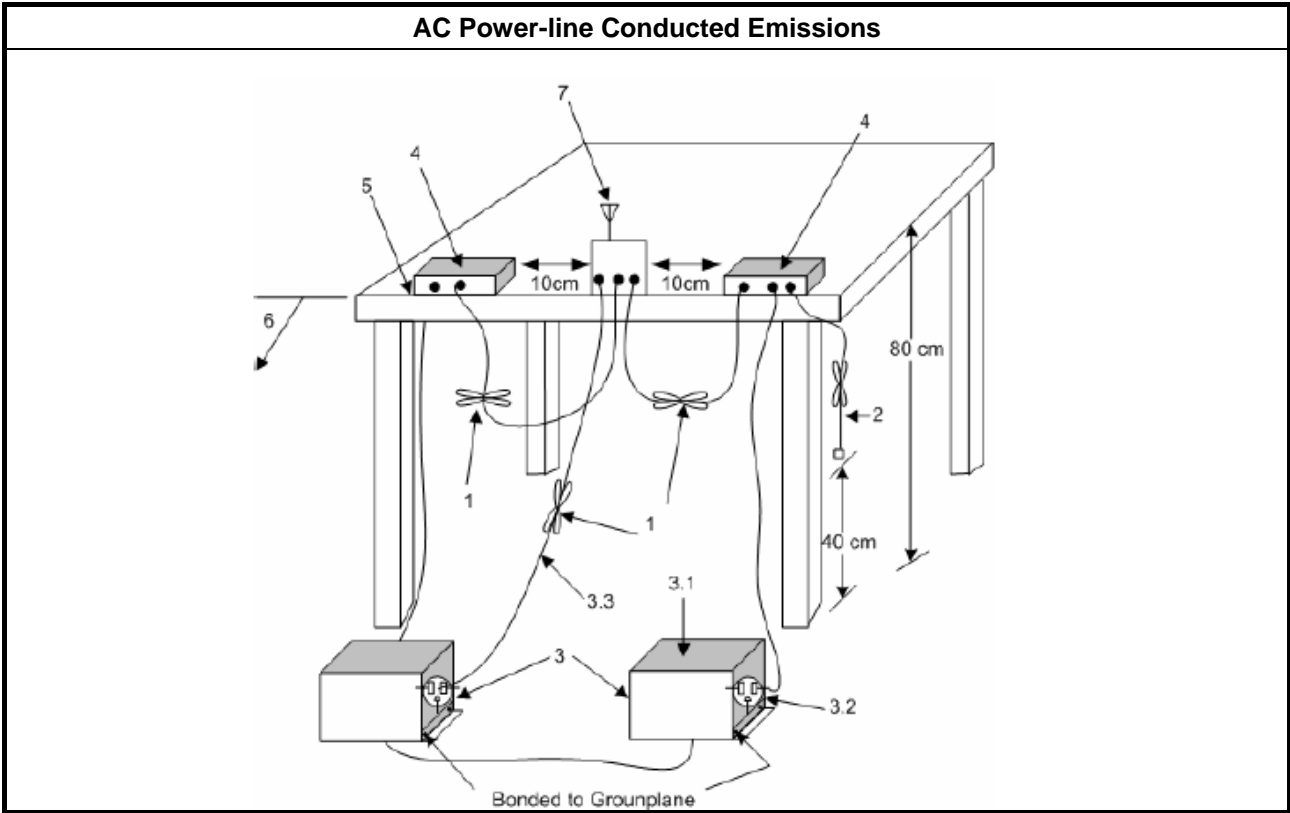



3.1.5 Test Result of AC Power-line Conducted Emissions

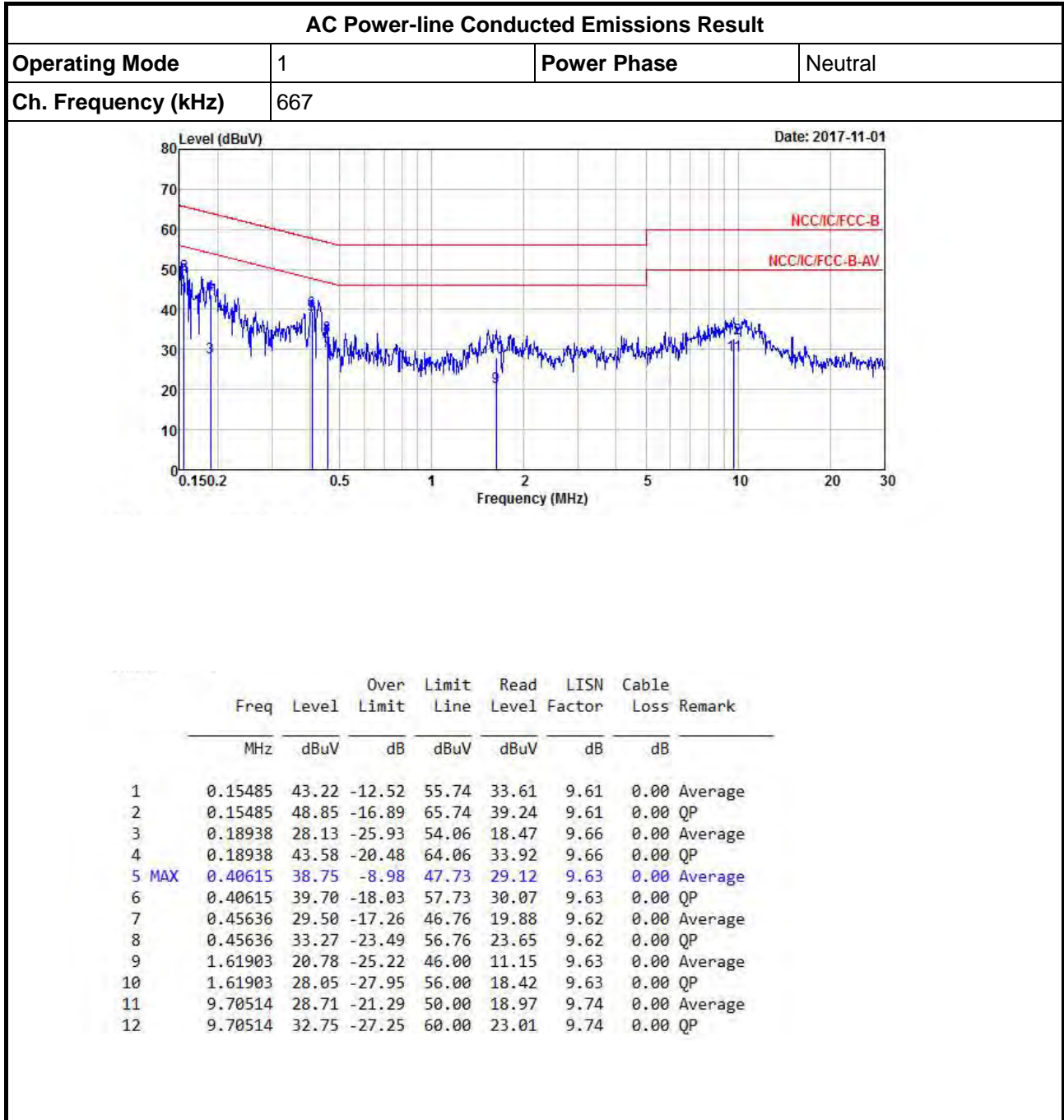

Note 1: ">20dB" means emission levels that exceed the level of 20 dB below the applicable limit.
 Note 2: "N/F" means Nothing Found emissions (No emissions were detected.)
 Note 3: When emissions are in operating band over limits, retest with a dummy load for final in-band results.



AC Power-line Conducted Emissions Result

Operating Mode	1	Power Phase	Line
Ch. Frequency (kHz)	667		

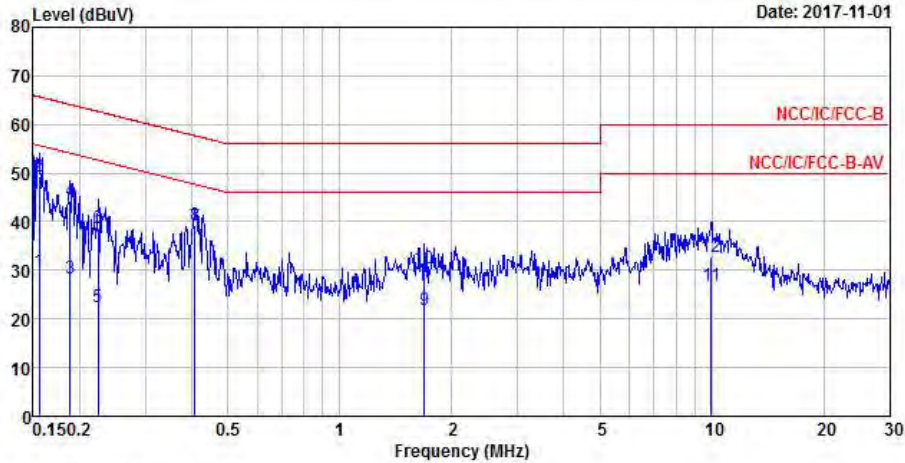

	Freq	Level	Over Limit	Limit Line	Read Level	LISN Factor	Cable Loss	Remark
	MHz	dBuV	dB	dBuV	dBuV	dB	dB	
1	0.15567	29.85	-25.84	55.69	20.19	9.66	0.00	Average
2	0.15567	49.35	-16.34	65.69	39.69	9.66	0.00	QP
3	0.18838	28.39	-25.72	54.11	18.74	9.65	0.00	Average
4	0.18838	44.29	-19.82	64.11	34.64	9.65	0.00	QP
5	0.22437	22.45	-30.21	52.66	12.80	9.65	0.00	Average
6	0.22437	38.64	-24.02	62.66	28.99	9.65	0.00	QP
7 MAX	0.40831	38.88	-8.80	47.68	29.20	9.68	0.00	Average
8	0.40831	39.33	-18.35	57.68	29.65	9.68	0.00	QP
9	1.68913	21.81	-24.19	46.00	12.06	9.75	0.00	Average
10	1.68913	30.30	-25.70	56.00	20.55	9.75	0.00	QP
11	9.96568	26.73	-23.27	50.00	16.99	9.74	0.00	Average
12	9.96568	32.76	-27.24	60.00	23.02	9.74	0.00	QP

Note 1: ">20dB" means emission levels that exceed the level of 20 dB below the applicable limit.
 Note 2: "N/F" means Nothing Found emissions (No emissions were detected.)
 Note 3: When emissions are in operating band over limits, retest with a dummy load for final in-band results.

3.2 Transmitter Radiated Emissions

3.2.1 Transmitter Radiated Emissions Limit

Transmitter Radiated Emissions Limit			
Frequency Range (MHz)	Field Strength (uV/m)	Field Strength (dBuV/m)	Measure Distance (m)
0.009~0.490	2400/F(kHz)	48.5 - 13.8	300
0.490~1.705	24000/F(kHz)	33.8 - 23	30
1.705~30.0	30	29	30
30~88	100	40	3
88~216	150	43.5	3
216~960	200	46	3
Above 960	500	54	3

Note 1: Test distance for frequencies at or above 30 MHz, measurements may be performed at a distance other than the limit distance provided they are not performed in the near field and the emissions to be measured can be detected by the measurement equipment. When performing measurements at a distance other than that specified, the results shall be extrapolated to the specified distance using an extrapolation factor of 20 dB/decade (inverse of linear distance for field-strength measurements, inverse of linear distance-squared for power-density measurements).

Note 2: Test distance for frequencies at below 30 MHz, measurements may be performed at a distance closer than the EUT limit distance; however, an attempt should be made to avoid making measurements in the near field. When performing measurements below 30 MHz at a closer distance than the limit distance, the results shall be extrapolated to the specified distance by either making measurements at a minimum of two or more distances on at least one radial to determine the proper extrapolation factor or by using the square of an inverse linear distance extrapolation factor (40 dB/decade). The test report shall specify the extrapolation method used to determine compliance of the EUT.

Note 3: the frequency bands 9-90 kHz, 110-490 kHz measurements employing an average detector and other below 1GHz measurements employing a CISPR quasi-peak detector.

3.2.2 Measuring Instruments

Refer a test equipment and calibration data table in this test report.



3.2.3 Test Procedures

Test Method	
<input checked="" type="checkbox"/>	Refer as ANSI C63.10, clause 6.5 for radiated emissions from 30 MHz to 1 GHz and test distance is 3m. Note : The test distance of radiated emissions from 617kHz to 717kHz is 1m.
<input checked="" type="checkbox"/>	Refer as ANSI C63.10, clause 6.4 for radiated emissions from below 30 MHz. The frequency bands 9-90 kHz, 110-490 kHz measurements employing an average detector and other below 30MHz measurements employing a CISPR quasi-peak detector. Test distance is 3m.
<input checked="" type="checkbox"/>	At frequencies below 30 MHz, measurements may be performed at a distance closer than that specified in the requirements; however, an attempt should be made to avoid making measurements in the near field. Pending the development of an appropriate measurement procedure for measurements performed below 30 MHz, when performing measurements at a closer distance than specified, the results shall be following below methods. Note: If fundamental emission level is smaller than noise at 3m , we will change distance to 1m.
<input type="checkbox"/>	The results shall be extrapolated to the specified distance by making measurements at a minimum of two distances on at least one radial to determine the proper extrapolation factor.
<input checked="" type="checkbox"/>	The results shall be by using the square of an inverse linear distance extrapolation factor (40 dB/decade).
<input checked="" type="checkbox"/>	For radiated measurement. Loop antenna was rotated about the horizontal and vertical axis and the equipment to be measured and the test antenna shall be oriented to obtain the maximum emitted field strength level.
<input checked="" type="checkbox"/>	The any unwanted emissions level shall not exceed the fundamental emission level.
<input checked="" type="checkbox"/>	All amplitude of spurious emissions that are attenuated by more than 20 dB below the permissible value has no need to be reported.

3.2.4 Test Setup

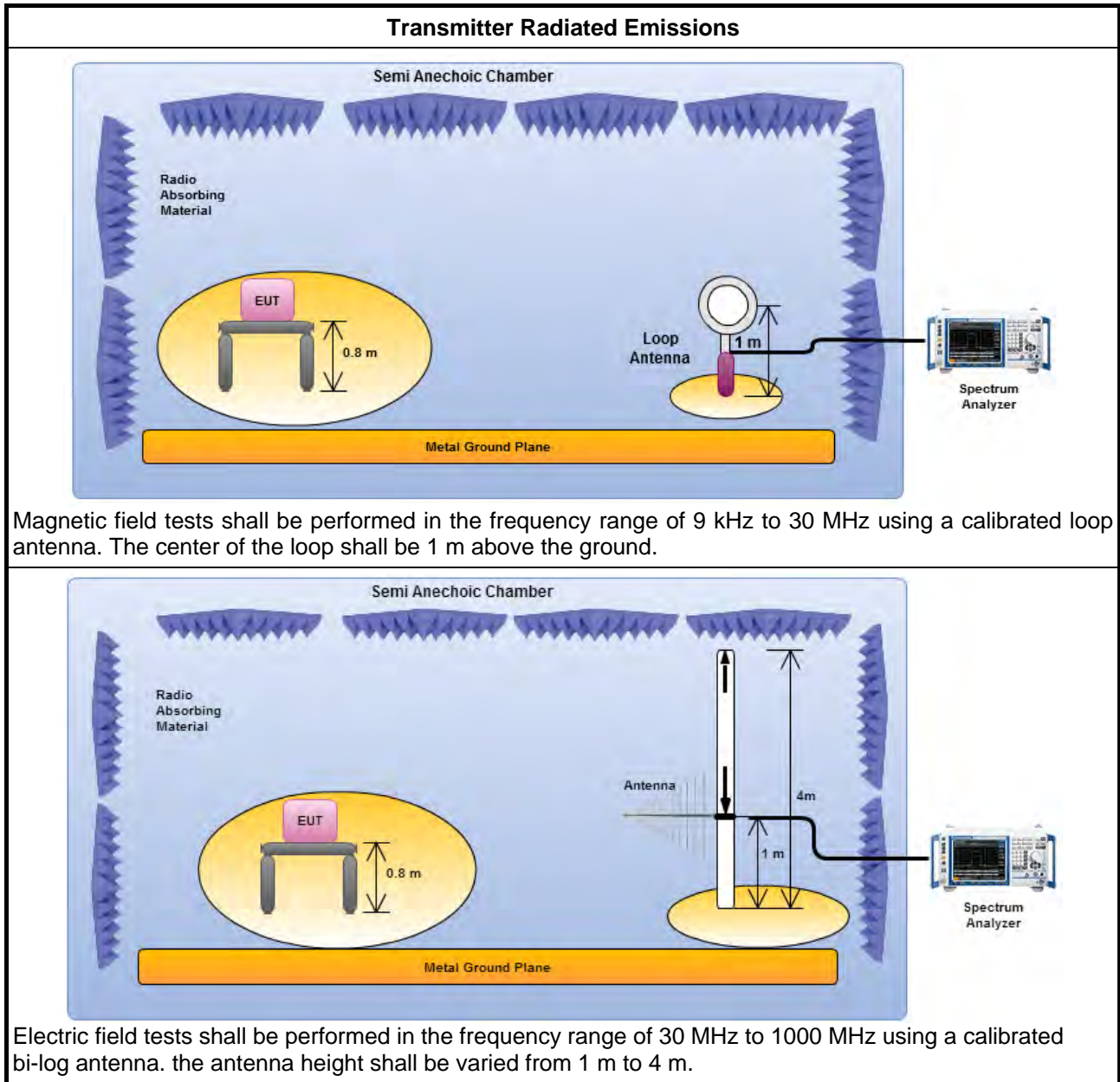



3.2.5 Transmitter Radiated Emissions (Below 30MHz)

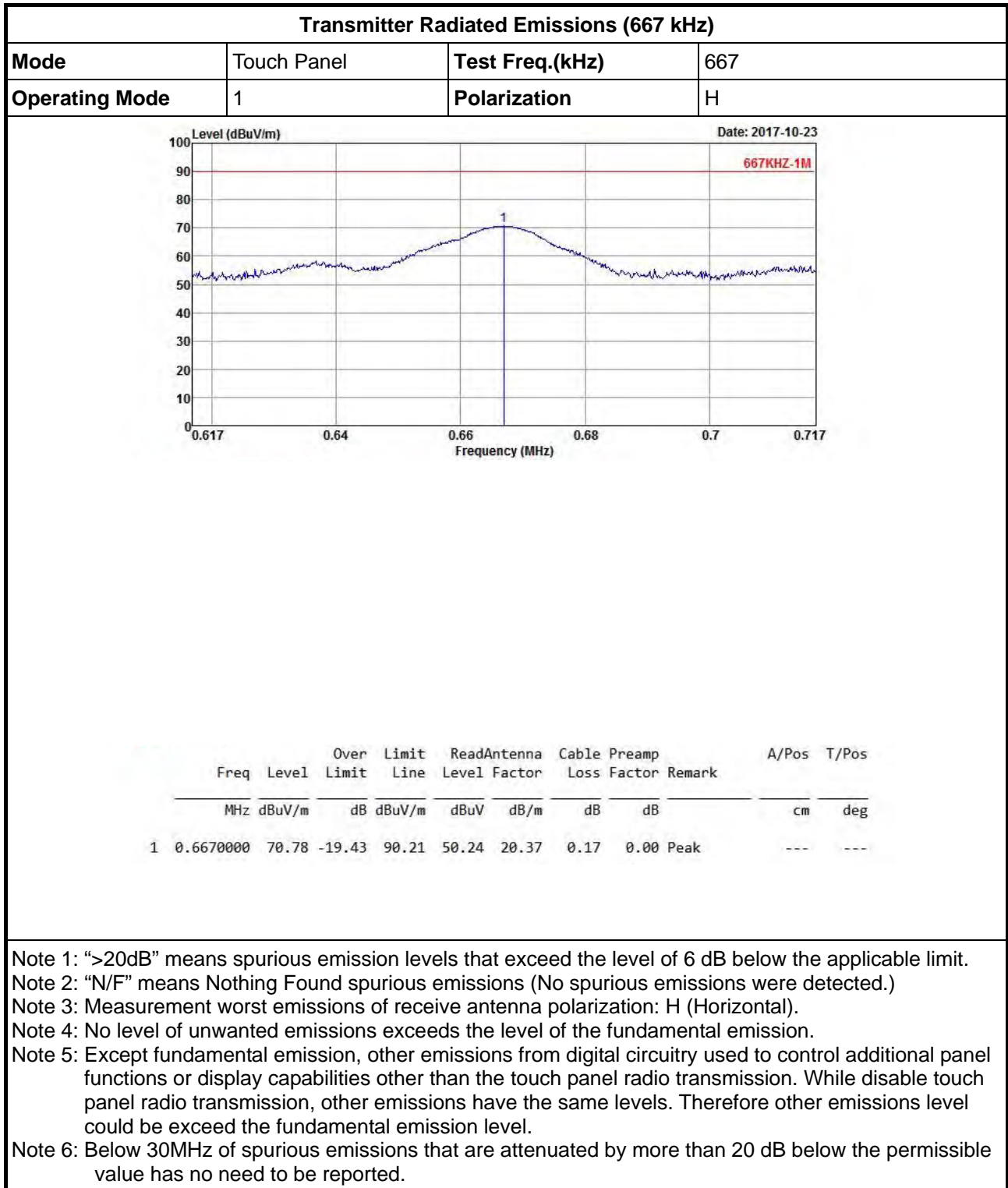



Transmitter Radiated Emissions (9kHz~150kHz)

Mode	Touch Panel	Test Freq.(kHz)	667
Operating Mode	1	Polarization	H

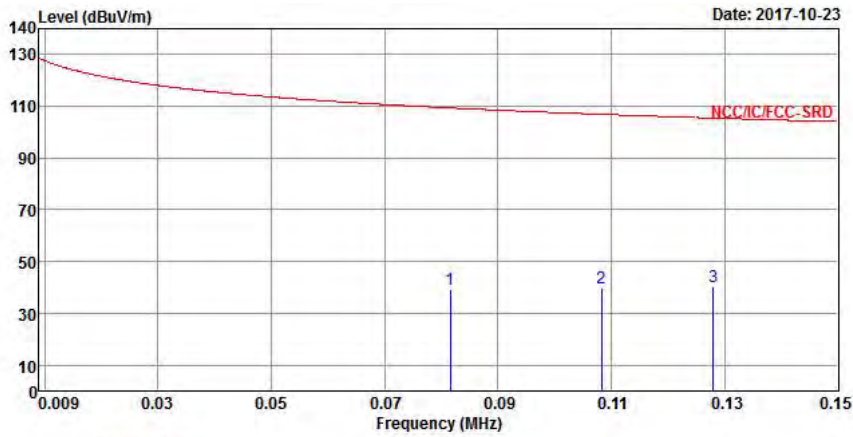

	Freq	Level	Over Limit	Limit Line	ReadAntenna Level	Antenna Factor	Cable Loss	Preamp Factor	Remark	A/Pos	T/Pos
	MHz	dBuV/m	dB	dBuV/m	dBuV	dB/m	dB	dB		cm	deg
1	0.0816150	39.12	-70.25	109.37	18.20	20.85	0.07	0.00	Peak	---	---
2	0.1082640	39.63	-67.29	106.92	18.87	20.69	0.07	0.00	Peak	---	---
3	0.1280040	40.06	-65.40	105.46	19.31	20.67	0.08	0.00	Peak	---	---

- Note 1: ">20dB" means spurious emission levels that exceed the level of 6 dB below the applicable limit.
- Note 2: "N/F" means Nothing Found spurious emissions (No spurious emissions were detected.)
- Note 3: Measurement worst emissions of receive antenna polarization: H (Horizontal).
- Note 4: No level of unwanted emissions exceeds the level of the fundamental emission.
- Note 5: Except fundamental emission, other emissions from digital circuitry used to control additional panel functions or display capabilities other than the touch panel radio transmission. While disable touch panel radio transmission, other emissions have the same levels. Therefore other emissions level could be exceed the fundamental emission level.
- Note 6: Below 30MHz of spurious emissions that are attenuated by more than 20 dB below the permissible value has no need to be reported.



Transmitter Radiated Emissions (150kHz~30MHz)			
Mode	Touch Panel	Test Freq.(kHz)	667
Operating Mode	1	Polarization	H

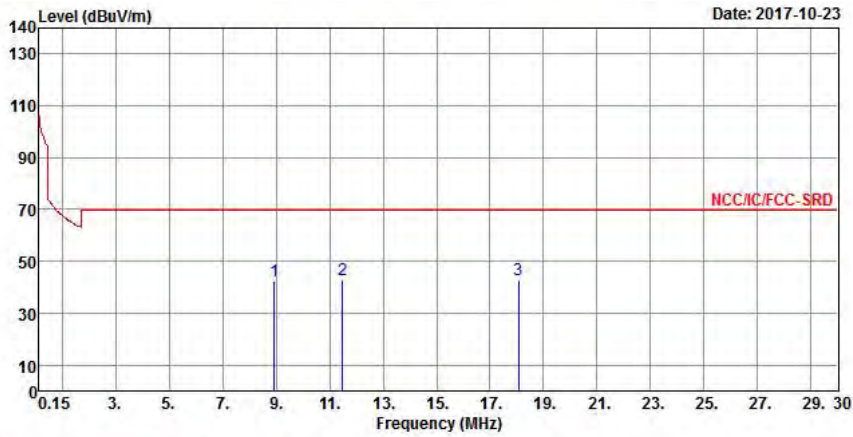

	Freq	Level	Over Limit	Limit Line	ReadAntenna Level	Antenna Factor	Cable Loss	Preamp Factor	Remark	A/Pos	T/Pos
	MHz	dBuV/m	dB	dBuV/m	dBuV	dB/m	dB	dB		cm	deg
1	8.9259000	42.15	-27.39	69.54	20.32	21.33	0.50	0.00	Peak	---	---
2	11.493000	43.05	-26.49	69.54	20.89	21.63	0.53	0.00	Peak	---	---
3	18.060000	43.04	-26.50	69.54	20.22	22.23	0.59	0.00	Peak	---	---

- Note 1: ">20dB" means spurious emission levels that exceed the level of 6 dB below the applicable limit.
- Note 2: "N/F" means Nothing Found spurious emissions (No spurious emissions were detected.)
- Note 3: Measurement worst emissions of receive antenna polarization: H (Horizontal).
- Note 4: No level of unwanted emissions exceeds the level of the fundamental emission.
- Note 5: Except fundamental emission, other emissions from digital circuitry used to control additional panel functions or display capabilities other than the touch panel radio transmission. While disable touch panel radio transmission, other emissions have the same levels. Therefore other emissions level could be exceed the fundamental emission level.
- Note 6: Below 30MHz of spurious emissions that are attenuated by more than 20 dB below the permissible value has no need to be reported.



3.2.6 Transmitter Radiated Emissions (Above 30MHz)

Transmitter Radiated Emissions (Above 30MHz)			
Mode	Touch Panel	Test Freq.(kHz)	667
Operating Mode	1	Polarization	V

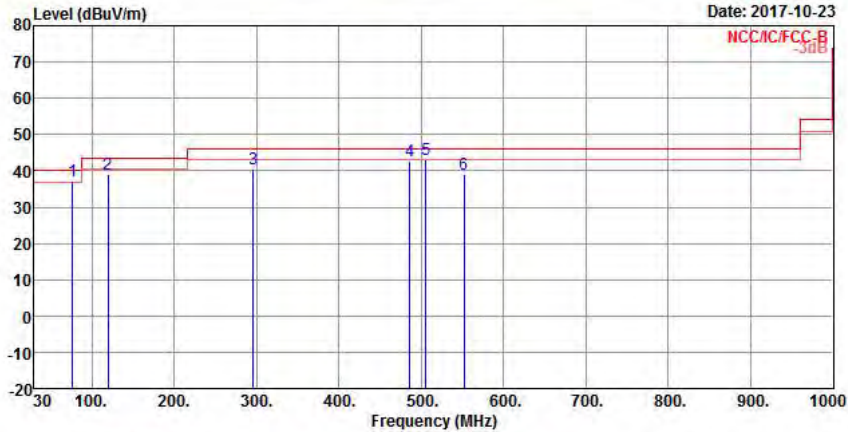

Freq	Level	Over Limit	Limit Line	ReadAntenna Level	Antenna Factor	Cable Loss	Preamp Factor	Remark	A/Pos	T/Pos
MHz	dBuV/m	dB	dBuV/m	dBuV	dB/m	dB	dB		cm	deg
1 176.560000	37.10	-2.90	40.00	51.90	11.61	1.28	27.69	QP	---	---
2 119.240000	39.21	-4.29	43.50	48.03	17.32	1.60	27.74	QP	---	---
3 295.780000	40.52	-5.48	46.00	46.81	18.36	2.56	27.21	Peak	---	---
4 485.900000	42.61	-3.39	46.00	44.84	22.80	3.39	28.42	QP	---	---
5 505.300000	43.17	-2.83	46.00	45.45	22.73	3.48	28.49	QP	---	---
6 551.860000	38.86	-7.14	46.00	39.66	24.08	3.65	28.53	Peak	---	---

Note 1: ">20dB" means spurious emission levels that exceed the level of 6 dB below the applicable limit.
 Note 2: "N/F" means Nothing Found spurious emissions (No spurious emissions were detected.)
 Note 3: Measurement receive antenna polarization: H (Horizontal), V (Vertical).
 Note 4: No level of unwanted emissions exceeds the level of the fundamental emission.
 Note 5: Except fundamental emission, other emissions from digital circuitry used to control additional panel functions or display capabilities other than the touch panel radio transmission. While disable touch panel radio transmission, other emissions have the same levels. Therefore other emissions level could be exceed the fundamental emission level.



Transmitter Radiated Emissions (Above 30MHz)			
Mode	Touch Panel	Test Freq.(kHz)	667
Operating Mode	1	Polarization	H

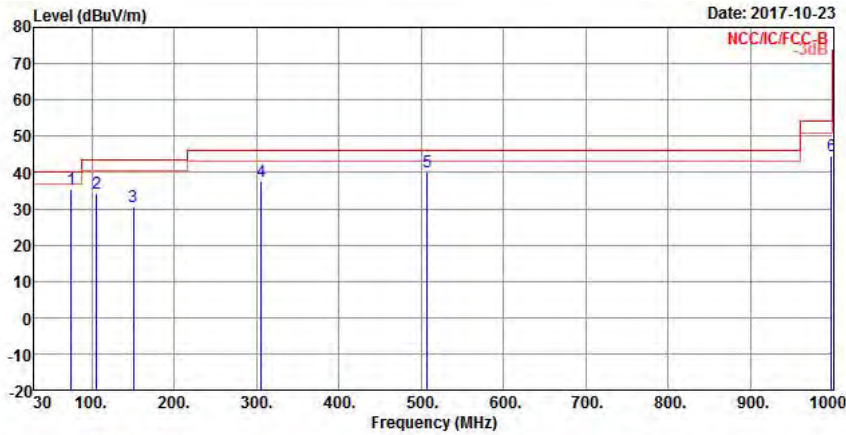

	Freq	Level	Over Limit	Limit Line	ReadAntenna Level	Antenna Factor	Cable Loss	Preamp Factor	Remark	A/Pos	T/Pos
	MHz	dBuV/m	dB	dBuV/m	dBuV	dB/m	dB	dB		cm	deg
1	74.620000	35.20	-4.80	40.00	50.18	11.44	1.26	27.68	Peak	---	---
2	105.660000	34.16	-9.34	43.50	43.68	16.80	1.47	27.79	Peak	---	---
3	150.280000	30.41	-13.09	43.50	40.75	15.50	1.78	27.62	Peak	---	---
4	305.480000	37.60	-8.40	46.00	43.61	18.62	2.61	27.24	Peak	---	---
5	507.240000	40.31	-5.69	46.00	42.59	22.73	3.49	28.50	Peak	---	---
6	998.06010	44.56	-9.44	54.00	40.28	26.63	4.90	27.25	Peak	---	---

Note 1: ">20dB" means spurious emission levels that exceed the level of 6 dB below the applicable limit.
 Note 2: "N/F" means Nothing Found spurious emissions (No spurious emissions were detected.)
 Note 3: Measurement receive antenna polarization: H (Horizontal), V (Vertical).
 Note 4: No level of unwanted emissions exceeds the level of the fundamental emission.
 Note 5: Except fundamental emission, other emissions from digital circuitry used to control additional panel functions or display capabilities other than the touch panel radio transmission. While disable touch panel radio transmission, other emissions have the same levels. Therefore other emissions level could be exceed the fundamental emission level.

3.3 Emission Bandwidth

3.3.1 Emission Bandwidth Limit

Emission Bandwidth Limit
N/A

3.3.2 Measuring Instruments

Refer a test equipment and calibration data table in this test report.

3.3.3 Test Procedures

Test Method
<input checked="" type="checkbox"/> For the emission bandwidth refer ANSI C63.10, clause 6.9.3 for occupied bandwidth testing.
<input checked="" type="checkbox"/> For radiated measurement. Loop antenna was rotated about the horizontal and vertical axis and the equipment to be measured and the test antenna shall be oriented to obtain the maximum emitted field strength level.

3.3.4 Test Setup

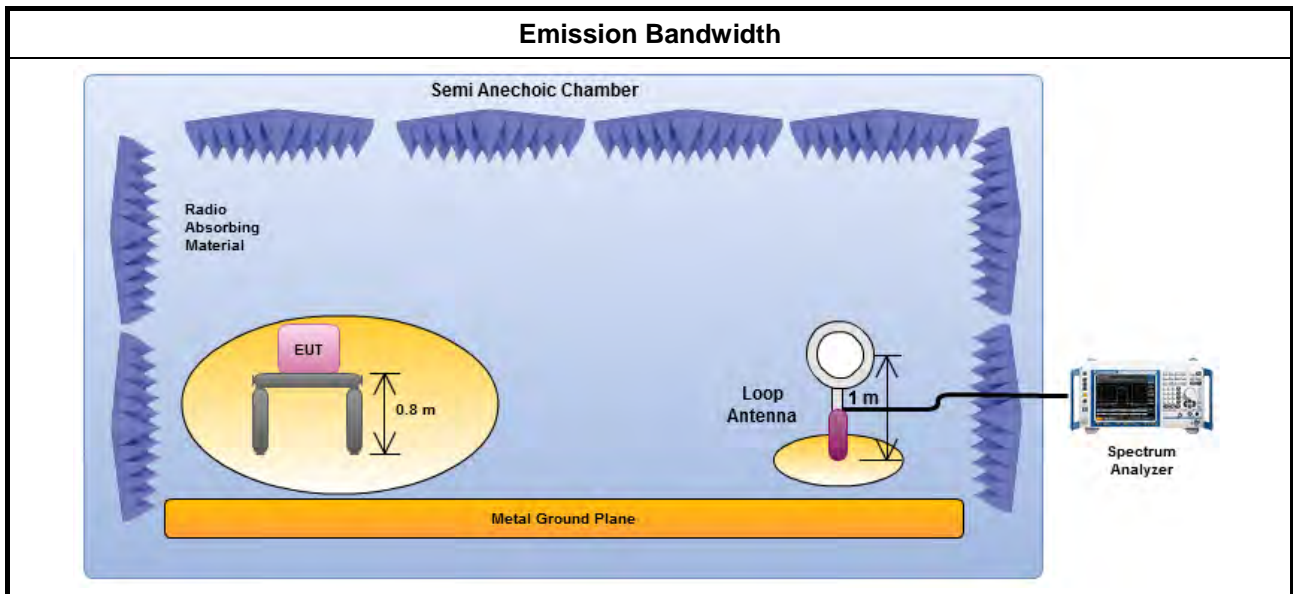

3.3.5 Test Result of Emission Bandwidth

Occupied Channel Bandwidth Result			
Transmitter Mode	Frequency (kHz)	99% Bandwidth (kHz)	20dB Bandwidth (kHz)
Touch Panel	667	23.01	17.37
Limit		N/A	
Result		Complied	

Emission Bandwidth Plot - 99% Bandwidth

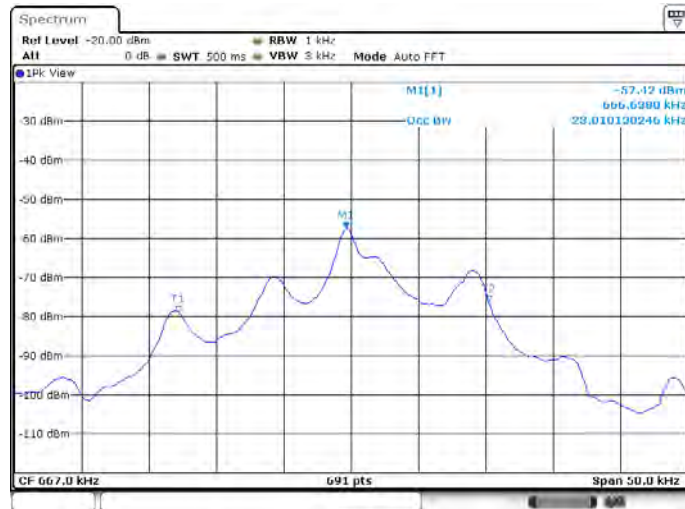

Emission Bandwidth Plot - 20dB Bandwidth

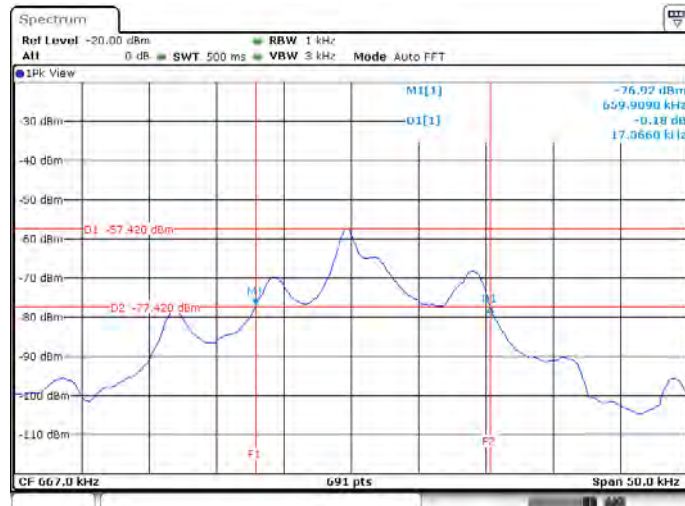

4 Test Equipment and Calibration Data

<AC Power-line Conducted Emissions>

Instrument	Manufacturer	Model No.	Serial No.	Characteristics	Calibration Date	Calibration Due Date
EMC Receiver	R&S	ESR3	102052	9kHz ~ 3.6GHz	29/Apr/2017	28/Apr/2018
LISN	R&S	ENV216	101295	9kHz ~ 30MHz	15/Nov/2016	14/Nov/2017
RF Cable-CON	HUBER+SUHNER	RG213/U	07611832020001	9kHz ~ 30MHz	06/Oct/2017	05/Oct/2018
LISN (Support Unit)	EMCO	3810/2	9703-1839	9kHz ~ 30MHz	NCR	NCR
LISN	SCHWARZBECK MESS-ELEKTRONIK	NSLK 8127	8127-477	9kHz ~ 30MHz	14/Feb/2017	13/Feb/2018
AC POWER	APC	AFC-11005G	F310050055	47Hz~63Hz 5~300V	NCR	NCR
Impuls Begrenzer Pulse Limiter	SCHWARZBECK	VTSD 9561-F	9561-F041	9 kHz ~ 30 MHz	05/Oct/2017	04/Oct/2018

NCR : Non-Calibration Require

<RF Conducted>

Instrument	Manufacturer	Model No.	Serial No.	Characteristics	Calibration Date	Calibration Due Date
Spectrum Analyzer	R&S	FSV 40	101500	9KHz~40GHz	06/Feb/2017	05/Feb/2018

<Radiated Emission>

Instrument	Manufacturer	Model No.	Serial No.	Characteristics	Calibration Date	Calibration Due Date
Spectrum Analyzer	R&S	FSP 40	100593	9kHz~40GHz	26/Oct/2016	25/Oct/2017
3m Semi Anechoic Chamber	SIDT FRANKONIA	SAC-3M	03CH02-HY	30MHz ~ 1GHz 3m	20/Oct/2017	19/Oct/2018
3m Semi Anechoic Chamber	SIDT FRANKONIA	SAC-3M	03CH02-HY	1GHz ~ 18GHz 3m	12/Dec/2016	11/Dec/2017
Amplifier	Agilent	8447D	2944A11149	100kHz ~ 1.3GHz	29/Jun/2017	28/Jun/2018
RF Cable-R03m	Jye Bao	RG142	CB017	9kHz ~ 1GHz	26/Jan/2017	25/Jan/2018
Bilog Antenna	SCHAFFNER	CBL 6112B	2723	30MHz ~ 1GHz	09/Sep/2017	8/Sep/2018
Receiver	R&S	ESU3	102052	9kHz ~ 3.6GHz	29/Apr/2017	28/Apr/2018
Loop Antenna	TESEQ	HLA 6120	24155	9 kHz~30 MHz	03/Feb/2017	02/Feb/2018