



FCC TEST REPORT

FCC ID : HV4DTH167
Equipment : LCD TABLET
Brand Name : Wacom
Model Name : DTH167, DTH167K0A
Applicant : Wacom Co., Ltd.
2-510-1, Toyonodai, Kazo-shi, Saitama 349-1148 Japan
Manufacturer : Wacom Co., Ltd.
2-510-1, Toyonodai, Kazo-shi, Saitama 349-1148 Japan
Standard : 47 CFR FCC Part 15.209

The product was received on Apr. 14, 2021, and testing was started from Apr. 20, 2021 and completed on May 03, 2021. We, SPORTON INTERNATIONAL INC. Hsinhua Laboratory, would like to declare that the tested sample has been evaluated in accordance with the procedures given in ANSI C63.10-2013 and shown compliance with the applicable technical standards.

The test results in this report apply exclusively to the tested model / sample. Without written approval of SPORTON INTERNATIONAL INC. Hsinhua Laboratory, the test report shall not be reproduced except in full.

Approved by: Allen Lin

SPORTON INTERNATIONAL INC. Hsinhua Laboratory

No.52, Huaya 1st Rd., Guishan Dist., Taoyuan City 333411, Taiwan (R.O.C.)



Table of Contents

- 1 GENERAL DESCRIPTION5**
- 1.1 Information.....5
- 1.2 Testing Applied Standards6
- 1.3 Testing Location Information6
- 1.4 Measurement Uncertainty6
- 2 TEST CONFIGURATION OF EUT.....7**
- 2.1 The Worst Case Configuration7
- 2.2 The Worst Case Measurement Configuration.....7
- 2.3 Accessory8
- 2.4 Support Equipment.....8
- 2.5 Test Setup Diagram9
- 3 TRANSMITTER TEST RESULT11**
- 3.1 AC Power-line Conducted Emissions11
- 3.2 Transmitter Radiated Emissions16
- 3.3 Emission Bandwidth26
- 4 TEST EQUIPMENT AND CALIBRATION DATA29**

APPENDIX A. TEST PHOTOS

PHOTOGRAPHS OF EUT v01



History of this test report

Report No.	Version	Description	Issued Date
FR140716AP	01	Initial issue of report	May 27, 2021



Summary of Test Result

Report Clause	Ref Std. Clause	Test Items	Result (PASS/FAIL)	Remark
1.1.2	15.203	Antenna Requirement	PASS	-
3.1	15.207	AC Power-line Conducted Emissions	PASS	-
3.2	15.209	Transmitter Radiated Emissions	PASS	-
3.3	15.215(c)	Emission Bandwidth	PASS	-

Declaration of Conformity:
The test results with all measurement uncertainty excluded are presented in accordance with the regulation limits or requirements declared by manufacturers.
Comments and Explanations:
None.

Reviewed by: Sam Tsai

Report Producer: Amber Chiu



1 General Description

1.1 Information

1.1.1 RF General Information

RF General Information			
Modulation	Ch. Frequency(kHz)	Channel Number	Field Strength (dBuV)
ASK	667	1	55.08
Note 1: Field strength performed peak level at 3m.			

1.1.2 Antenna Information

Ant.	Brand	Model Name	Antenna Type	Connector
1	-	-	Array Coil Pointing	NA

1.1.3 Type of EUT

Operational Condition	
EUT Power Type	From AC Adapter
Type of EUT	
<input checked="" type="checkbox"/>	Stand-alone
<input type="checkbox"/>	Combined (EUT where the radio part is fully integrated within another device) Combined Equipment - Brand Name / Model No.: ...
<input type="checkbox"/>	Plug-in radio (EUT intended for a variety of host systems) Host System - Brand Name / Model No.: ...
<input type="checkbox"/>	Other:

1.1.4 Test Signal Duty Cycle

Operated Mode for Worst Duty Cycle	
<input checked="" type="checkbox"/>	Operated normal mode for worst duty cycle
<input type="checkbox"/>	Operated test mode for worst duty cycle
Test Signal Duty Cycle (x)	
<input checked="" type="checkbox"/>	100.00%

1.1.5 Table for Multiple Listing

The model names in the following table are all refer to the identical product.

Brand Name	Model Name	Description
Wacom	DTH167, DTH167K0A	All the models are identical, the different models served as marketing strategy.

1.2 Testing Applied Standards

According to the specifications of the manufacturer, the EUT must comply with the requirements of the following standards:

- ◆ 47 CFR FCC Part 15
- ◆ ANSI C63.10-2013

The following reference test guidance is not within the scope of accreditation of TAF:

- ◆ KDB 414788 D01 v01r01

1.3 Testing Location Information

Test Lab. : Sporton International Inc. Hsinhua Laboratory				
<input checked="" type="checkbox"/>	Hsinhua (TAF: 3785)	ADD: No.52, Huaya 1st Rd., Guishan Dist., Taoyuan City 333411, Taiwan (R.O.C.)		
		TEL: 886-3-327-3456	FAX: 886-3-327-0973	
Test site Designation No. TW3785 with FCC.				
Test Condition	Test Site No.	Test Engineer	Test Environment	Test Date
RF Conducted	TH01-HY	Vivi Jiang	20.1~26.9°C / 50~60%	03/May/2021
AC Conduction	CO04-HY	Daniel Lin	21.4~23.4°C / 52~63%	22/Apr/2021
Radiated	03CH02-HY	Daniel Lin	20.7~26.1°C / 51~64%	21/Apr/2021
<input type="checkbox"/>	Wen 33rd.St. (TAF: 3785)	ADD: No.14-1, Ln. 19, Wen 33rd St., Guishan Dist., Taoyuan City 333010, Taiwan (R.O.C.)		
		TEL: 886-3-318-0787	FAX: 886-3-318-0287	
Test site Designation No. TW0008 with FCC.				

1.4 Measurement Uncertainty

ISO/IEC 17025 requires that an estimate of the measurement uncertainties associated with the emissions test results be included in the report. The measurement uncertainties given below are based on a 95% confidence level (based on a coverage factor (k=2))

Test Items	Uncertainty	Remark
Conducted Emission (150kHz ~ 30MHz)	0.9 dB	Confidence levels of 95%
Radiated Emission (9kHz ~ 30MHz)	2.4 dB	Confidence levels of 95%
Radiated Emission (30MHz ~ 1,000MHz)	3.7 dB	Confidence levels of 95%
Conducted Emission	1.0 dB	Confidence levels of 95%
Temperature	0.41 °C	Confidence levels of 95%
Humidity	3.4 %	Confidence levels of 95%



2 Test Configuration of EUT

2.1 The Worst Case Configuration

Mode	Test Channel Frequencies(kHz)	Field Strength (dBuV/m@3m)
Touch pen	667	55.08

2.2 The Worst Case Measurement Configuration

The Worst Case Mode for Following Conformance Tests	
Tests Item	AC power-line conducted emissions
Condition	AC power-line conducted measurement for line and neutral Test Voltage: 120Vac / 60Hz
Operating Mode	CTX
1	Adapter mode

The Worst Case Mode for Following Conformance Tests		
Tests Item	Emission Bandwidth, Field Strength of Fundamental Emissions Transmitter Radiated Unwanted Emissions	
Test Condition	Radiated measurement	
User Position	<input type="checkbox"/> EUT will be placed in fixed position.	
	<input type="checkbox"/> EUT will be placed in mobile position and operating multiple positions. EUT shall be performed three orthogonal planes.	
	<input checked="" type="checkbox"/> EUT will be a hand-held or body-worn battery-powered devices and operating multiple positions.	
Operating Mode	CTX	
1	Adapter Mode	
Orthogonal Planes of EUT	Y Plane	Z Plane
		
Worst Planes of EUT	V	



2.3 Accessory

Accessories				
AC Adapter	Brand Name	Delta	Model Name	DPS-65VB
	Power Rating	I/P: 100- 240Vac, 2A, O/P: 12Vdc, 5.417A		
Digital Pen	Brand Name	Wacom	Model Name	KP-504E-00
Pen Seat	Brand Name	Wacom	Model Name	-
USB Type-C to Type-A Cable	Brand Name	-	Model Name	JPA-W-J335-000
	Power Cord	1.8 meter, shielded cable, w/o ferrite core		
USB Type-C to Type-C Cable	Brand Name	-	Model Name	CBAUB-H39-100A
	Power Cord	1 meter, shielded cable, w/o ferrite core		
HDMI Cable	Brand Name	Wacom	Model Name	JPA-W-J163-000
	Power Cord	1.8 meter, shielded cable, w/o ferrite core		

Reminder: Regarding to more detail and other information, please refer to user manual.

2.4 Support Equipment

Support Equipment – AC Conduction					
No.	Equipment	Brand Name	Model Name	FCC ID	Remark
1	AC Power cable	Power sync	TPCMRN0018	-	-
2	Notebook	HP	5220m	-	-
3	AC Adapter (for NB)	HP	PPP012H-S	-	-

Support Equipment – Conducted					
No.	Equipment	Brand Name	Model Name	FCC ID	Remark
1	Notebook	DELL	E5410	-	-
2	Adapter for NB	DELL	HA65NM130	-	-

Support Equipment – Radiated					
No.	Equipment	Brand Name	Model Name	FCC ID	Remark
1	AC Power cable	Power sync	TPCMRN0018	-	-
2	Notebook	HP	5220m	-	-
3	AC Adapter (for NB)	HP	PPP012H-S	-	-

2.5 Test Setup Diagram

Test Setup Diagram – AC Line Conducted Emission Test

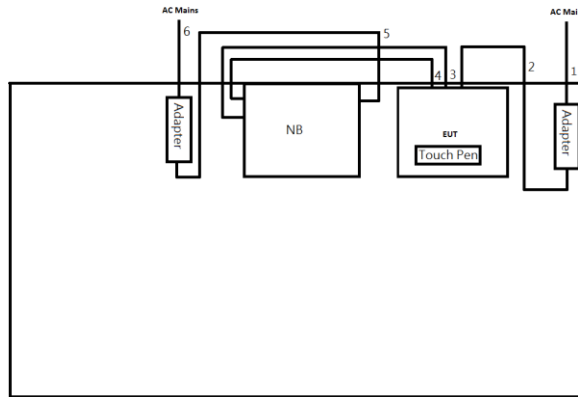

Item	Connection	Shielded	Length(m)	Remark
1	AC Power cable	No	1.0	-
2	DC Power cable	No	1.0	-
3	HDMI Cable	YES	1.8	-
4	USB Type-C to Type-A Cable	YES	1.8	-
5	DC Power cable	No	2.0	-
6	AC Power cable	No	1.8	-

Test Setup Diagram - Radiated Test

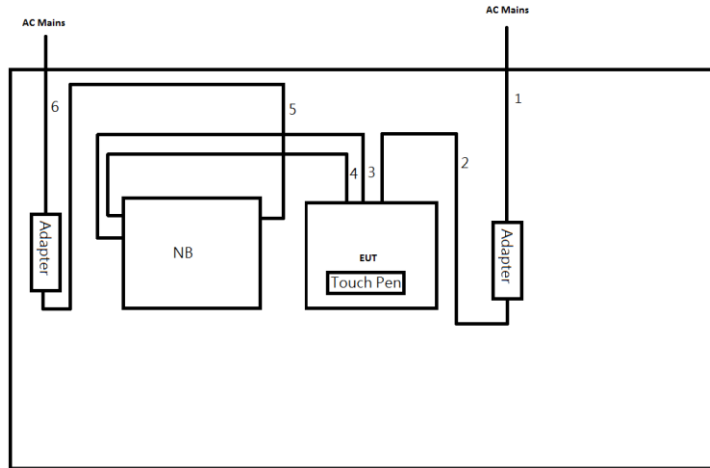

Item	Connection	Shielded	Length(m)	Remark
1	AC Power cable	No	1.0	-
2	DC Power cable	No	1.0	-
3	HDMI cable	YES	1.8	-
4	USB Type-C to Type-A cable	YES	1.8	-
5	DC Power cable	No	2.0	-
6	AC Power cable	No	1.8	-



3 Transmitter Test Result

3.1 AC Power-line Conducted Emissions

3.1.1 AC Power-line Conducted Emissions Limit

AC Power-line Conducted Emissions Limit		
Frequency Emission (MHz)	Quasi-Peak	Average
0.15-0.5	66 - 56 *	56 - 46 *
0.5-5	56	46
5-30	60	50

Note 1: * Decreases with the logarithm of the frequency.

3.1.2 Measuring Instruments

Refer a test equipment and calibration data table in this test report.

3.1.3 Test Procedures

Test Method	
<input checked="" type="checkbox"/>	Refer as ANSI C63.10-2013, clause 6.2 for AC power-line conducted emissions.
<input checked="" type="checkbox"/>	If AC conducted emissions fall in operating band, then following below test method confirm final result.
<input type="checkbox"/>	Accept measurements done with a suitable dummy load replacing the antenna under the following conditions: (1) Perform the AC line conducted tests with the antenna connected to determine compliance with FCC 15.207 limits outside the transmitter's fundamental emission band; (2) Retest with a dummy load to determine compliance with FCC 15.207 limits within the transmitter's fundamental emission band.
<input checked="" type="checkbox"/>	For a device with a permanent antenna operating at or below 30 MHz, accept measurements done with a suitable dummy load, in lieu of the permanent antenna under the following conditions: (1) Perform the AC line conducted tests with the permanent antenna to determine compliance with the FCC 15.207 limits outside the transmitter's fundamental emission band; (2) Retest with a dummy load in lieu of the permanent antenna to determine compliance with the FCC 15.207 limits within the transmitter's fundamental emission band.

3.1.4 Measurement Results Calculation

The measured Level is calculated using:

Corrected Reading: Raw(Read Level) + LISN(LISN Factor) + CL(Cable Loss) + AT(Attenuator).

3.1.5 Test Setup

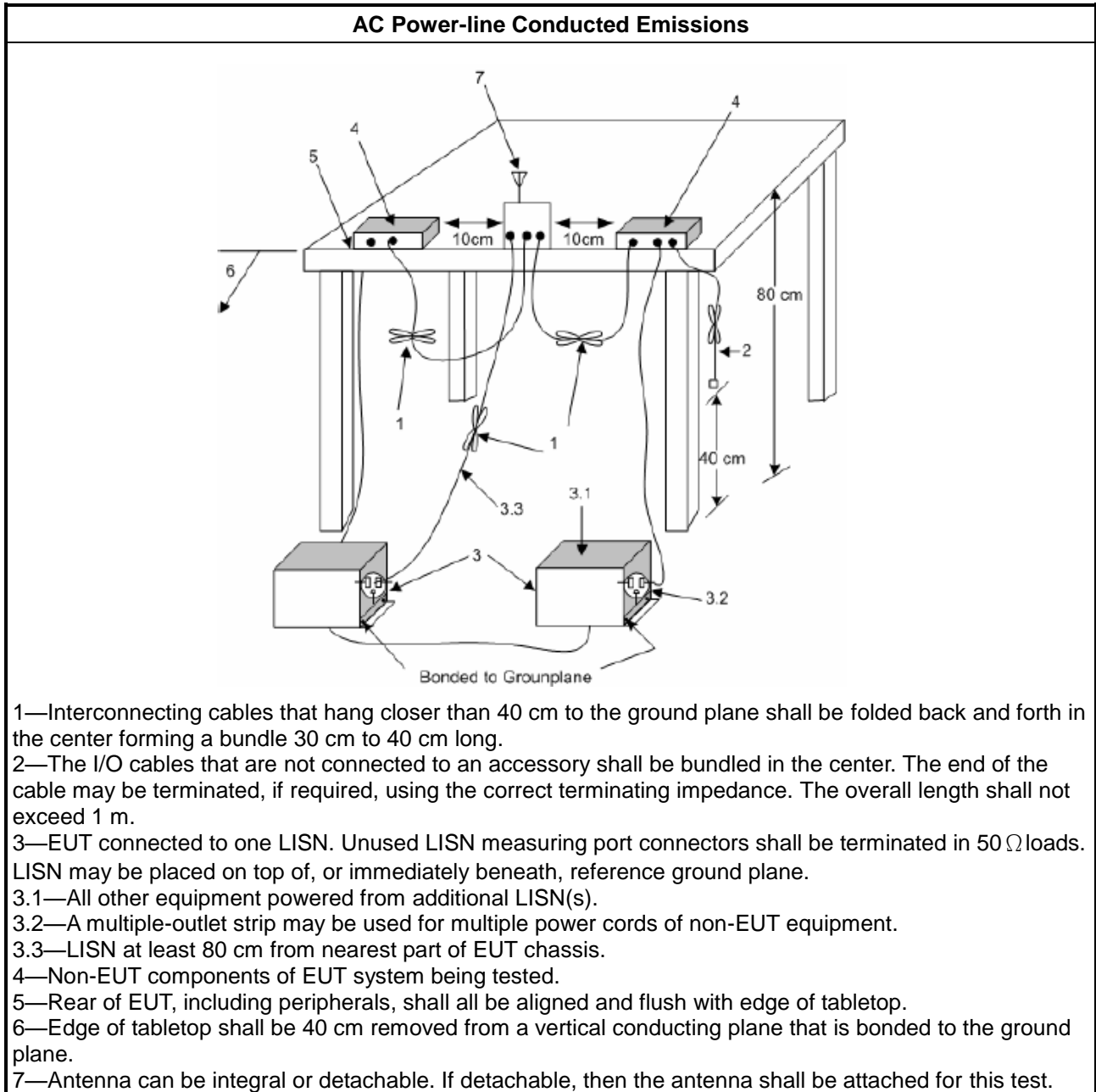



3.1.6 Test Result of AC Power-line Conducted Emissions

Summary

Mode	Result	Type	Freq (Hz)	Level (dBuV)	Limit (dBuV)	Margin (dB)	Condition
Mode 1	Pass	QP	169.76k	47.06	64.97	-17.91	Line

Result

Mode	Result	Type	Freq (Hz)	Level (dBuV)	Limit (dBuV)	Margin (dB)	Condition	Comments
Mode 1	Pass	QP	169.76k	47.06	64.97	-17.91	Line	-
Mode 1	Pass	AV	169.76k	30.96	54.97	-24.01	Line	-
Mode 1	Pass	QP	194.439k	43.42	63.84	-20.42	Line	-
Mode 1	Pass	AV	194.439k	27.91	53.84	-25.93	Line	-
Mode 1	Pass	QP	221.817k	37.57	62.75	-25.18	Line	-
Mode 1	Pass	AV	221.817k	23.60	52.75	-29.15	Line	-
Mode 1	Pass	QP	533.841k	29.10	56.00	-26.90	Line	-
Mode 1	Pass	AV	533.841k	24.82	46.00	-21.18	Line	-
Mode 1	Pass	QP	2.211M	24.39	56.00	-31.61	Line	-
Mode 1	Pass	AV	2.211M	19.33	46.00	-26.67	Line	-
Mode 1	Pass	QP	15.952M	24.79	60.00	-35.21	Line	-
Mode 1	Pass	AV	15.952M	18.74	50.00	-31.26	Line	-
Mode 1	Pass	QP	171.121k	46.78	64.91	-18.13	Neutral	-
Mode 1	Pass	AV	171.121k	30.50	54.91	-24.41	Neutral	-
Mode 1	Pass	QP	195.997k	42.78	63.78	-21.00	Neutral	-
Mode 1	Pass	AV	195.997k	27.53	53.78	-26.25	Neutral	-
Mode 1	Pass	QP	243.148k	36.15	61.98	-25.83	Neutral	-
Mode 1	Pass	AV	243.148k	22.97	51.98	-29.01	Neutral	-
Mode 1	Pass	QP	535.976k	27.98	56.00	-28.02	Neutral	-
Mode 1	Pass	AV	535.976k	23.51	46.00	-22.49	Neutral	-
Mode 1	Pass	QP	2.229M	21.34	56.00	-34.66	Neutral	-
Mode 1	Pass	AV	2.229M	17.13	46.00	-28.87	Neutral	-
Mode 1	Pass	QP	17.208M	25.67	60.00	-34.33	Neutral	-
Mode 1	Pass	AV	17.208M	19.65	50.00	-30.35	Neutral	-



Conducted Emissions at Powerline_Mode 1

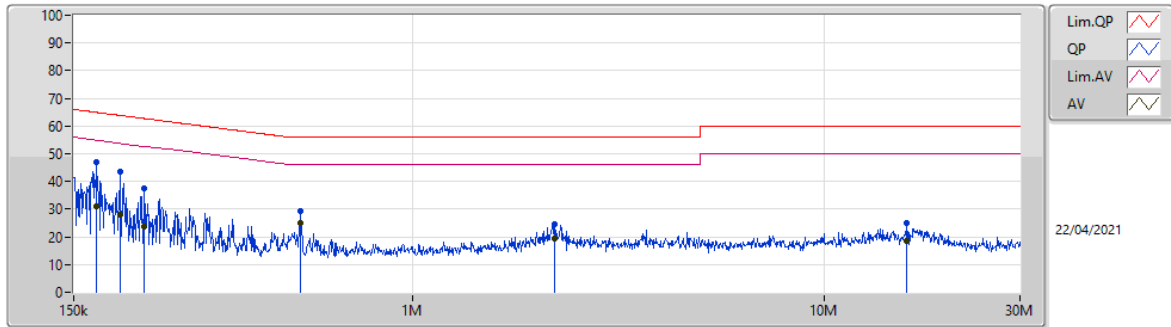

Type	Freq (Hz)	Level (dBuV)	Limit (dBuV)	Margin (dB)	Factor (dB)	Condition	Comment	Raw (dBuV)	LISN (dB)	CL (dB)	AT (dB)
QP	169.76k	47.06	64.97	-17.91	19.63	Line	-	27.43	9.69	0.04	9.90
AV	169.76k	30.96	54.97	-24.01	19.63	Line	-	11.33	9.69	0.04	9.90
QP	194.439k	43.42	63.84	-20.42	19.62	Line	-	23.80	9.68	0.04	9.90
AV	194.439k	27.91	53.84	-25.93	19.62	Line	-	8.29	9.68	0.04	9.90
QP	221.817k	37.57	62.75	-25.18	19.62	Line	-	17.95	9.68	0.04	9.90
AV	221.817k	23.60	52.75	-29.15	19.62	Line	-	3.98	9.68	0.04	9.90
QP	533.841k	29.10	56.00	-26.90	19.61	Line	-	9.49	9.67	0.07	9.87
AV	533.841k	24.82	46.00	-21.18	19.61	Line	-	5.21	9.67	0.07	9.87
QP	2.211M	24.39	56.00	-31.61	19.60	Line	-	4.79	9.68	0.11	9.81
AV	2.211M	19.33	46.00	-26.67	19.60	Line	-	-0.27	9.68	0.11	9.81
QP	15.952M	24.79	60.00	-35.21	19.85	Line	-	4.94	9.69	0.26	9.90
AV	15.952M	18.74	50.00	-31.26	19.85	Line	-	-1.11	9.69	0.26	9.90



Conducted Emissions at Powerline_Mode 1

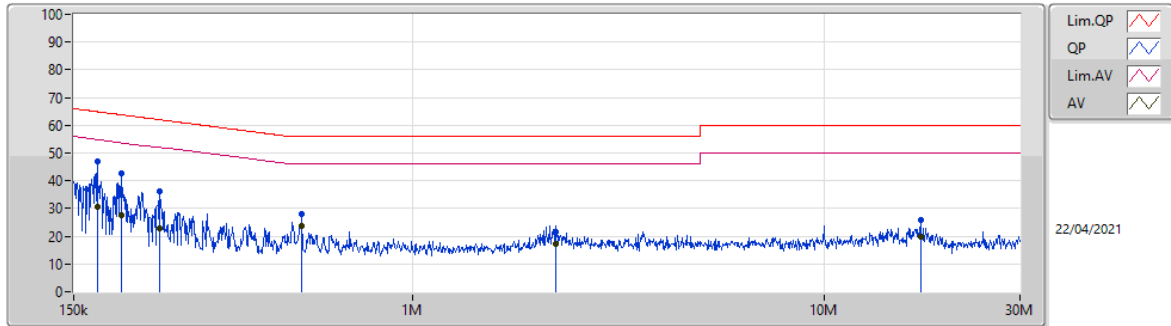

Lim.QP
 QP
 Lim.AV
 AV

22/04/2021

Type	Freq (Hz)	Level (dBuV)	Limit (dBuV)	Margin (dB)	Factor (dB)	Condition	Comment	Raw (dBuV)	LISN (dB)	CL (dB)	AT (dB)
QP	171.121k	46.78	64.91	-18.13	19.63	Neutral	-	27.15	9.69	0.04	9.90
AV	171.121k	30.50	54.91	-24.41	19.63	Neutral	-	10.87	9.69	0.04	9.90
QP	195.997k	42.78	63.78	-21.00	19.62	Neutral	-	23.16	9.68	0.04	9.90
AV	195.997k	27.53	53.78	-26.25	19.62	Neutral	-	7.91	9.68	0.04	9.90
QP	243.148k	36.15	61.98	-25.83	19.63	Neutral	-	16.52	9.68	0.05	9.90
AV	243.148k	22.97	51.98	-29.01	19.63	Neutral	-	3.34	9.68	0.05	9.90
QP	535.976k	27.98	56.00	-28.02	19.61	Neutral	-	8.37	9.67	0.07	9.87
AV	535.976k	23.51	46.00	-22.49	19.61	Neutral	-	3.90	9.67	0.07	9.87
QP	2.229M	21.34	56.00	-34.66	19.61	Neutral	-	1.73	9.68	0.11	9.82
AV	2.229M	17.13	46.00	-28.87	19.61	Neutral	-	-2.48	9.68	0.11	9.82
QP	17.208M	25.67	60.00	-34.33	19.92	Neutral	-	5.75	9.75	0.27	9.90
AV	17.208M	19.65	50.00	-30.35	19.92	Neutral	-	-0.27	9.75	0.27	9.90



3.2 Transmitter Radiated Emissions

3.2.1 Transmitter Radiated Emissions Limit

Transmitter Radiated Emissions Limit			
Frequency Range (MHz)	Field Strength (uV/m)	Field Strength (dBuV/m)	Measure Distance (m)
0.009~0.490	2400/F(kHz)	48.5 - 13.8	300
0.490~1.705	24000/F(kHz)	33.8 - 23	30
1.705~30.0	30	29	30
30~88	100	40	3
88~216	150	43.5	3
216~960	200	46	3
Above 960	500	54	3

Note 1: Test distance for frequencies at or above 30 MHz, measurements may be performed at a distance other than the limit distance provided they are not performed in the near field and the emissions to be measured can be detected by the measurement equipment. When performing measurements at a distance other than that specified, the results shall be extrapolated to the specified distance using an extrapolation factor of 20 dB/decade (inverse of linear distance for field-strength measurements, inverse of linear distance-squared for power-density measurements).

Note 2: Test distance for frequencies at below 30 MHz, measurements may be performed at a distance closer than the EUT limit distance; however, an attempt should be made to avoid making measurements in the near field. When performing measurements below 30 MHz at a closer distance than the limit distance, the results shall be extrapolated to the specified distance by either making measurements at a minimum of two or more distances on at least one radial to determine the proper extrapolation factor or by using the square of an inverse linear distance extrapolation factor (40 dB/decade). The test report shall specify the extrapolation method used to determine compliance of the EUT.

Note 3: the frequency bands 9-90 kHz, 110-490 kHz measurements employing an average detector and other below 1GHz measurements employing a CISPR quasi-peak detector.

3.2.2 Measuring Instruments

Refer a test equipment and calibration data table in this test report.



3.2.3 Test Procedures

Test Method	
<input checked="" type="checkbox"/>	Refer as ANSI C63.10, clause 6.5 for radiated emissions from 30 MHz to 1 GHz and test distance is 3m.
<input checked="" type="checkbox"/>	Refer as ANSI C63.10, clause 6.4 for radiated emissions from below 30 MHz. The frequency bands 9-90 kHz, 110-490 kHz measurements employing an average detector and other below 30MHz measurements employing a CISPR quasi-peak detector. Test distance is 3m.
<input checked="" type="checkbox"/>	At frequencies below 30 MHz, measurements may be performed at a distance closer than that specified in the requirements; however, an attempt should be made to avoid making measurements in the near field. Pending the development of an appropriate measurement procedure for measurements performed below 30 MHz, when performing measurements at a closer distance than specified, the results shall be following below methods. Note: If fundamental emission level is smaller than noise at 3m , we will change distance to 1m.
<input type="checkbox"/>	The results shall be extrapolated to the specified distance by making measurements at a minimum of two distances on at least one radial to determine the proper extrapolation factor.
<input checked="" type="checkbox"/>	The results shall be by using the square of an inverse linear distance extrapolation factor (40 dB/decade).
<input checked="" type="checkbox"/>	For radiated measurement. Loop antenna was rotated about the horizontal and vertical axis and the equipment to be measured and the test antenna shall be oriented to obtain the maximum emitted field strength level.
<input checked="" type="checkbox"/>	The any unwanted emissions level shall not exceed the fundamental emission level.
<input checked="" type="checkbox"/>	All amplitude of spurious emissions that are attenuated by more than 20 dB below the permissible value has no need to be reported.
<input checked="" type="checkbox"/>	KDB 414788 Open-Field Test Sites and Chamber Correlation Justification.
<input type="checkbox"/>	<ul style="list-style-type: none"> Based on FCC 15.31 (f) (2): measurements may be performed at a distance closer than that specified in regulations; however, an attempt should be made to avoid making measurements in the near field.
<input type="checkbox"/>	<ul style="list-style-type: none"> Open-field site and chamber correlation testing had been performed and chamber measured test result is the worst case test result.

3.2.4 Measurement Results Calculation

The measured Level is calculated using:

Corrected Reading: Raw(Read Level) + AF(Antenna Factor) + CL(Cable Loss) - PA(Preamplifier Factor)

3.2.5 Test Setup

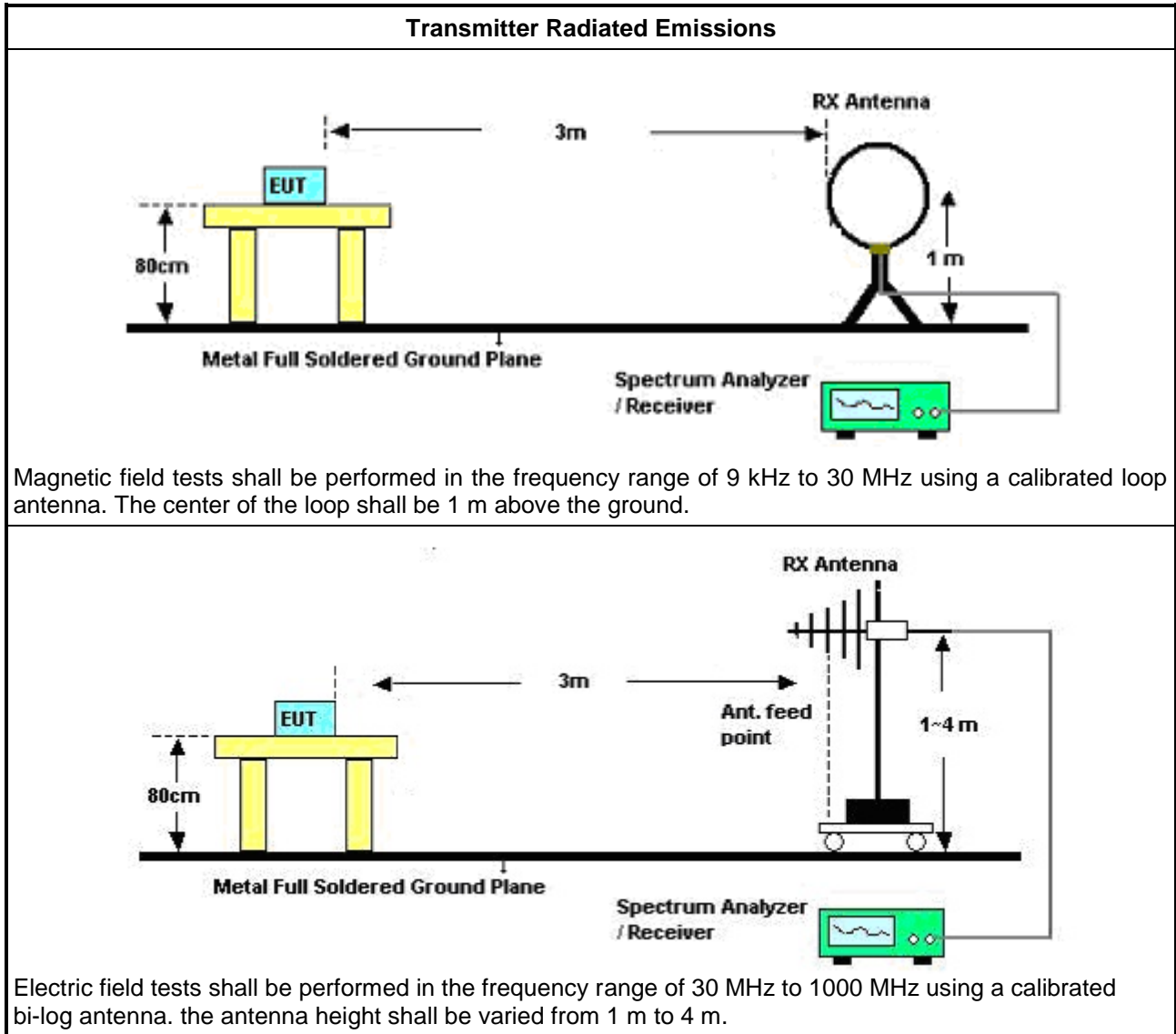



3.2.6 Transmitter Radiated Emissions (Below 30MHz)

Summary

Mode	Result	Type	Freq (Hz)	Level (dBuV/m)	Limit (dBuV/m)	Margin (dB)	Factor (dB)	Dist (m)	Condition	Azimuth (°)	Height (m)	Comments
667k	-	-	-	-	-	-	-	-	-	-	-	-
SRD	Pass	PK	2.18M	54.92	69.50	-14.58	20.40	3	Horizontal	360	1.00	-

Result

Mode	Result	Type	Freq (Hz)	Level (dBuV/m)	Limit (dBuV/m)	Margin (dB)	Factor (dB)	Dist (m)	Condition	Azimuth (°)	Height (m)	Comments
SRD	-	-	-	-	-	-	-	-	-	-	-	-
0.667MHz_TX	Pass	PK	669.4k	55.08	71.09	-16.01	20.52	3	Horizontal	5	1.00	-
0.667MHz_TX	Pass	PK	14.64k	53.92	124.26	-70.34	19.91	3	Horizontal	0	1.00	-
0.667MHz_TX	Pass	PK	42.84k	53.34	114.95	-61.61	21.14	3	Horizontal	0	1.00	-
0.667MHz_TX	Pass	PK	70.476k	52.22	110.63	-58.41	20.51	3	Horizontal	0	1.00	-
0.667MHz_TX	Pass	PK	448.5k	53.02	94.56	-41.54	20.52	3	Horizontal	360	1.00	-
0.667MHz_TX	Pass	PK	1.105M	49.11	66.77	-17.66	20.53	3	Horizontal	360	1.00	-
0.667MHz_TX	Pass	PK	2.18M	54.92	69.50	-14.58	20.40	3	Horizontal	360	1.00	-



SRD

21/04/2021

0.667MHz_TX

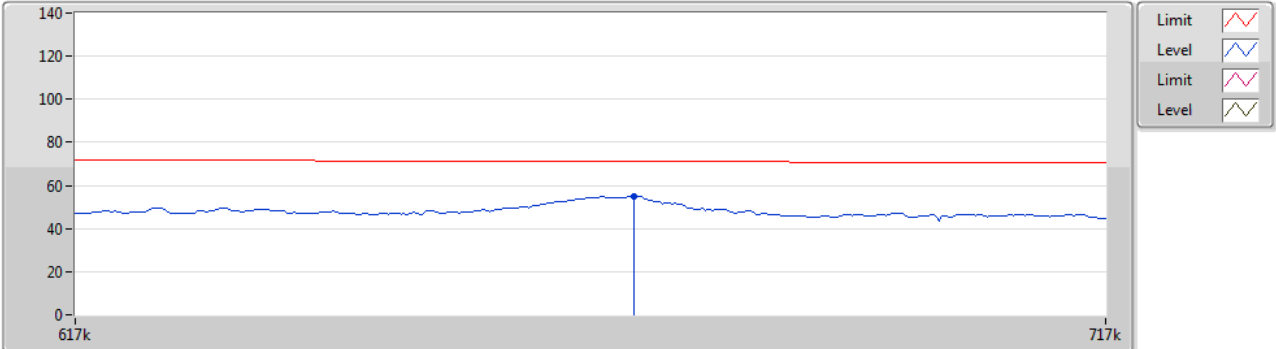

Type	Freq	Level	Limit	Margin	Factor	Dist	Condition	Azimuth	Height	Comment	Raw	AF	CL	PA
	(Hz)	(dBuV/m)	(dBuV/m)	(dB)	(dB)	(m)		(°)	(m)		(dBuV)	(dB)	(dB)	(dB)
PK	669.4k	55.08	71.09	-16.01	20.52	3	Horizontal	5	1.00	-	34.56	20.40	0.12	-



SRD

21/04/2021

0.667MHz_TX

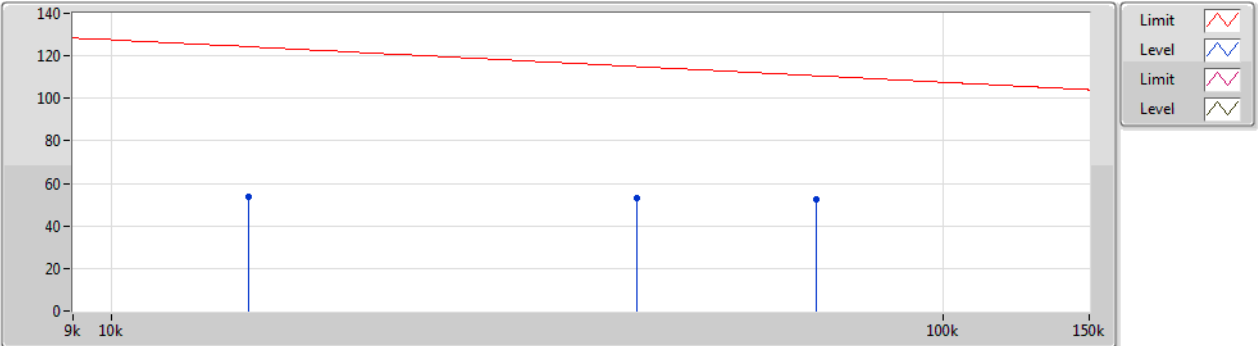

Type	Freq (Hz)	Level (dBuV/m)	Limit (dBuV/m)	Margin (dB)	Factor (dB)	Dist (m)	Condition	Azimuth (°)	Height (m)	Comment	Raw (dBuV)	AF (dB)	CL (dB)	PA (dB)
PK	14.64k	53.92	124.26	-70.34	19.91	3	Horizontal	0	1.00	-	34.01	19.87	0.04	-
PK	42.84k	53.34	114.95	-61.61	21.14	3	Horizontal	0	1.00	-	32.20	21.09	0.05	-
PK	70.476k	52.22	110.63	-58.41	20.51	3	Horizontal	0	1.00	-	31.71	20.46	0.05	-



SRD

21/04/2021

0.667MHz_TX

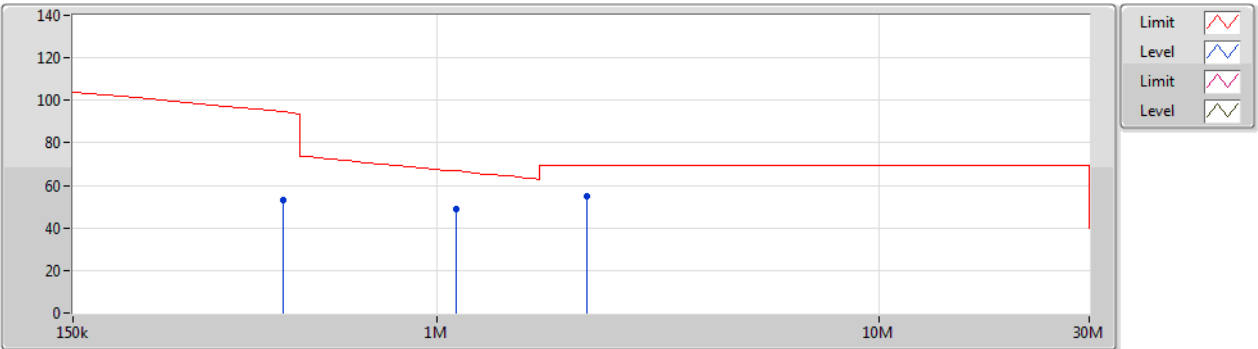

Type	Freq (Hz)	Level (dBuV/m)	Limit (dBuV/m)	Margin (dB)	Factor (dB)	Dist (m)	Condition	Azimuth (°)	Height (m)	Comment	Raw (dBuV)	AF (dB)	CL (dB)	PA (dB)
PK	448.5k	53.02	94.56	-41.54	20.52	3	Horizontal	360	1.00	-	32.50	20.42	0.10	-
PK	1.105M	49.11	66.77	-17.66	20.53	3	Horizontal	360	1.00	-	28.58	20.37	0.16	-
PK	2.18M	54.92	69.50	-14.58	20.40	3	Horizontal	360	1.00	-	34.52	20.19	0.21	-



3.2.7 Transmitter Radiated Emissions (Above 30MHz)

Summary

Mode	Result	Type	Freq (Hz)	Level (dBuV/m)	Limit (dBuV/m)	Margin (dB)	Factor (dB)	Dist (m)	Condition	Azimuth (°)	Height (m)	Comments
667k	-	-	-	-	-	-	-	-	-	-	-	-
SRD	Pass	PK	534.4M	41.71	46.00	-4.29	-1.52	3	Vertical	360	1.00	-

Result

Mode	Result	Type	Freq (Hz)	Level (dBuV/m)	Limit (dBuV/m)	Margin (dB)	Factor (dB)	Dist (m)	Condition	Azimuth (°)	Height (m)	Comments
SRD	-	-	-	-	-	-	-	-	-	-	-	-
0.667MHz_TX	Pass	PK	140.58M	32.39	43.50	-11.11	-9.56	3	Vertical	360	1.00	-
0.667MHz_TX	Pass	PK	173.56M	35.34	43.50	-8.16	-10.66	3	Vertical	360	1.00	-
0.667MHz_TX	Pass	PK	264.74M	31.47	46.00	-14.53	-5.83	3	Vertical	360	1.00	-
0.667MHz_TX	Pass	PK	534.4M	41.71	46.00	-4.29	-1.52	3	Vertical	360	1.00	-
0.667MHz_TX	Pass	PK	800.18M	38.57	46.00	-7.43	2.03	3	Vertical	360	1.00	-
0.667MHz_TX	Pass	QP	429.64M	40.41	46.00	-5.59	-2.71	3	Vertical	331	1.00	-
0.667MHz_TX	Pass	PK	148.34M	36.90	43.50	-6.60	-9.95	3	Horizontal	0	1.00	-
0.667MHz_TX	Pass	PK	179.38M	37.24	43.50	-6.26	-10.82	3	Horizontal	0	1.00	-
0.667MHz_TX	Pass	PK	264.74M	31.68	46.00	-14.32	-5.83	3	Horizontal	0	1.00	-
0.667MHz_TX	Pass	PK	532.46M	37.45	46.00	-8.55	-1.55	3	Horizontal	0	1.00	-
0.667MHz_TX	Pass	PK	743.92M	39.28	46.00	-6.72	1.41	3	Horizontal	0	1.00	-
0.667MHz_TX	Pass	QP	897.18M	41.52	46.00	-4.48	3.31	3	Horizontal	155	1.00	-



SRD

0.667MHz_TX

21/04/2021

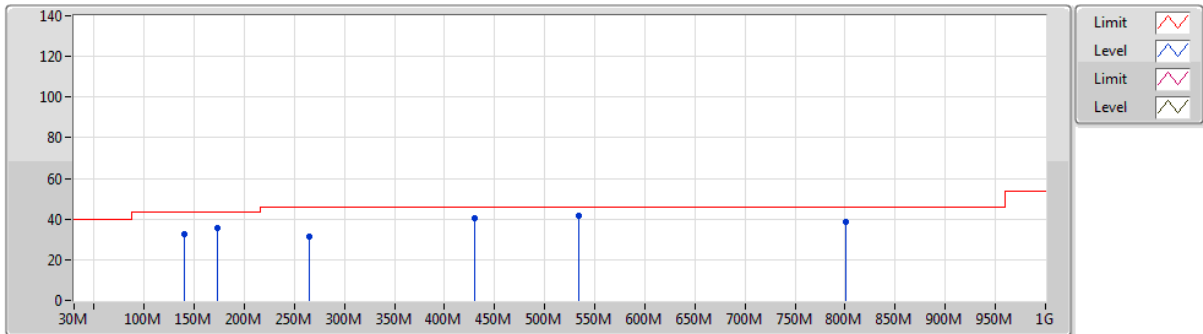

Type	Freq (Hz)	Level (dBuV/m)	Limit (dBuV/m)	Margin (dB)	Factor (dB)	Dist (m)	Condition	Azimuth (°)	Height (m)	Comment	Raw (dBuV)	AF (dB)	CL (dB)	PA (dB)
PK	140.58M	32.39	43.50	-11.11	-9.56	3	Vertical	360	1.00	-	41.95	16.20	1.86	27.62
PK	173.56M	35.34	43.50	-8.16	-10.66	3	Vertical	360	1.00	-	46.00	14.73	2.08	27.47
PK	264.74M	31.47	46.00	-14.53	-5.83	3	Vertical	360	1.00	-	37.30	18.59	2.63	27.05
PK	534.4M	41.71	46.00	-4.29	-1.52	3	Vertical	360	1.00	-	43.23	23.04	3.78	28.34
PK	800.18M	38.57	46.00	-7.43	2.03	3	Vertical	360	1.00	-	36.54	25.01	4.80	27.78
QP	429.64M	40.41	46.00	-5.59	-2.71	3	Vertical	331	1.00	-	43.12	21.85	3.37	27.93



SRD

21/04/2021

0.667MHz_TX

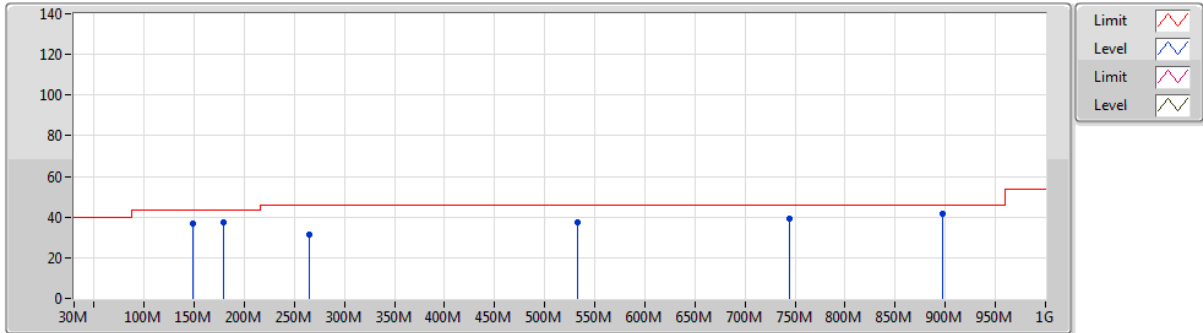

Type	Freq (Hz)	Level (dBuV/m)	Limit (dBuV/m)	Margin (dB)	Factor (dB)	Dist (m)	Condition	Azimuth (°)	Height (m)	Comment	Raw (dBuV)	AF (dB)	CL (dB)	PA (dB)
PK	148.34M	36.90	43.50	-6.60	-9.95	3	Horizontal	0	1.00	-	46.85	15.72	1.92	27.59
PK	179.38M	37.24	43.50	-6.26	-10.82	3	Horizontal	0	1.00	-	48.06	14.50	2.12	27.44
PK	264.74M	31.68	46.00	-14.32	-5.83	3	Horizontal	0	1.00	-	37.51	18.59	2.63	27.05
PK	532.46M	37.45	46.00	-8.55	-1.55	3	Horizontal	0	1.00	-	39.00	23.00	3.78	28.33
PK	743.92M	39.28	46.00	-6.72	1.41	3	Horizontal	0	1.00	-	37.87	24.89	4.53	28.01
QP	897.18M	41.52	46.00	-4.48	3.31	3	Horizontal	155	1.00	-	38.21	25.64	5.08	27.41

3.3 Emission Bandwidth

3.3.1 Emission Bandwidth Limit

Emission Bandwidth Limit
N/A

3.3.2 Measuring Instruments

Refer a test equipment and calibration data table in this test report.

3.3.3 Test Procedures

Test Method
<input checked="" type="checkbox"/> Because the measured signal is CW or CW-like adjusting the RBW per C63.10 would not be practical since measured bandwidth will always follow the RBW and the result will be approximately twice the RBW.
<input checked="" type="checkbox"/> For radiated measurement. Loop antenna was rotated about the horizontal and vertical axis and the equipment to be measured and the test antenna shall be oriented to obtain the maximum emitted field strength level.

3.3.4 Test Setup

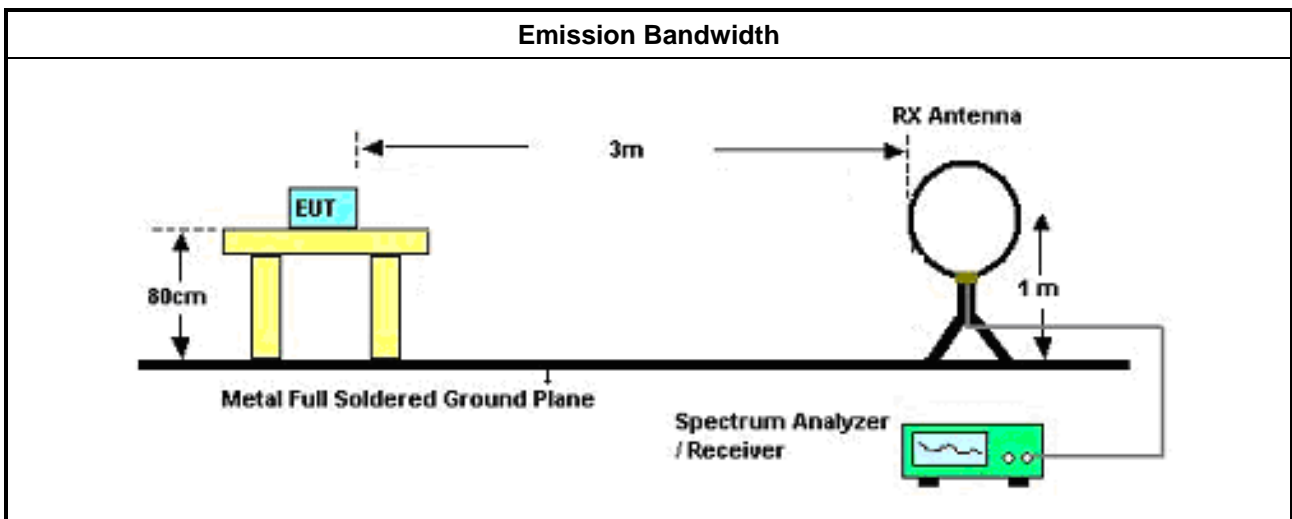



3.3.5 Test Result of Emission Bandwidth

Summary

Mode	20dB (Hz)	FI-20dB (Hz)	Fh-20dB (Hz)	OBW (Hz)	Limit (Range)
667k	-	-	-	-	-
SRD_Nss1_1TX	17.5k	658.25000k	675.75000k	17.22k	Inf

Result

Mode	Result	20dB (Hz)	FI-20dB (Hz)	Fh-20dB (Hz)	OBW (Hz)	FI-OBW (Hz)	Fh-OBW (Hz)	Limit (Range)
SRD_Nss1_1TX	-	-	-	-	-	-	-	-
0.667MHz_TnomVnom	Pass	17.5k	658.25000k	675.75000k	17.22k	658.35500k	675.57500k	Inf



SRD_Nss1_1TX

0.667MHz_TnomVnom

EBW

03/05/2021

Ch Freq
667kHz

Span
17.5kHz

RBW
1kHz

VBW
3kHz

Sweep Time
20ms

Detector Type
Peak

Port 1

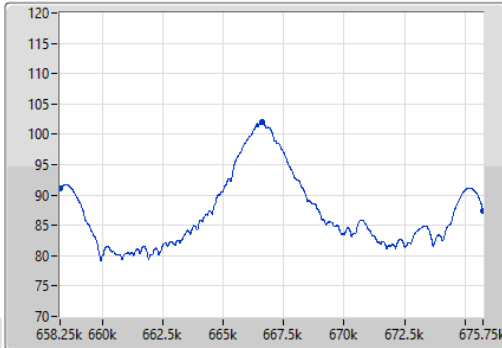

Ch Freq
667kHz

Span
17.5kHz

RBW
1kHz

VBW
3kHz

Sweep Time
20ms

Detector Type
Peak

Port 1

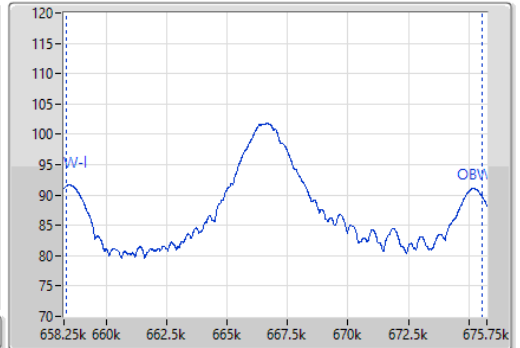

20dB(Hz)	Fl-20dB(Hz)	Fh-20dB(Hz)	OBW(Hz)	Fl-OBW(Hz)	Fh-OBW(Hz)	Limit(Range)
17.5k	658.25000k	675.75000k	17.22k	658.35500k	675.57500k	Inf

4 Test Equipment and Calibration Data

Instrument for AC Conduction

Instrument	Manufacturer / Brand	Model No.	Serial No.	Characteristics	Calibration Date	Calibration Due Date
EMI Test Receiver	R&S	ESR3	102051	9kHz ~ 3.6GHz	29/May/2020	28/May/2021
LISN	R&S	ENV216	101295	9kHz ~ 30MHz	11/Nov/2020	10/Nov/2021
LISN (Support Unit)	SCHWARZBECK MESS-ELEKTRONIK	NSLK 8127	8127477	9kHz ~ 30MHz	25/Feb/2021	24/Feb/2022
RF Cable 5m	TITAN	TITAN	CO04-cable-01	0.1MHz~200MHz	03/Mar/2021	02/Mar/2022
Impuls Begrenzer Pulse Limiter	SCHWARZBECK	VTSD 9561-F	9561-F041	9kHz ~ 30MHz	21/Sep/2020	20/Sep/2021

Instrument for Conducted Test

Instrument	Manufacturer / Brand	Model No.	Serial No.	Characteristics	Calibration Date	Calibration Due Date
Signal Analyzer	R&S	FSV 40	101013	10Hz~40GHz	30/Mar/2021	29/Mar/2022

Instrument for Radiated Test

Instrument	Manufacturer / Brand	Model No.	Serial No.	Characteristics	Calibration Date	Calibration Due Date
3m Semi Anechoic Chamber	SIDT FRANKONIA	SAC-3M	03CH02-HY	30MHz~1GHz 3m	04/Aug/2020	03/Aug/2021
Signal Analyzer	R&S	FSP40	100593	9kHz~40GHz	12/Mar/2021	11/Mar/2022
Amplifier	Agilent	8447D	2944A11149	100kHz~1.3GHz	30/Jun/2020	29/Jun/2021
Bilog Antenna & 5dB Attenuator	SCHAFFNER / MTJ	CBL 6112B / MTJ6102-05	2723 / 2	30MHz~1GHz	06/Sep/2020	05/Sep/2021
RF Cable-R03m	Jye Bao	RG142	CB017	9kHz~30MHz	20/Jun/2020	19/Jun/2021
RF Cable-R03m	Jye Bao	RG142	CB017	30MHz~1GHz	23/Mar/2021	22/Mar/2022
Loop Antenna	TESEQ	HLA 6120	31244	9kHz~30MHz	16/Mar/2021	15/Mar/2022
EMI Test Receiver	R&S	ESR3	102051	9kHz~3.6GHz	29/May/2020	28/May/2021