

FCC TEST REPORT

FCC ID : HV4DTH134
Equipment : Pen display with touch
Brand Name : Wacom
Model Name : DTH134 , DTH134W0A , DTH134W2A
Applicant : Wacom Co., Ltd.
2-510-1 Toyonodai Kazo-shi, Saitama 349-1148 Japan
Manufacturer : Wacom Co., Ltd.
2-510-1 Toyonodai Kazo-shi, Saitama 349-1148 Japan
Standard : 47 CFR FCC Part 15.209

The product was received on Mar. 30, 2022, and testing was started from May 04, 2022 and completed on May 20, 2022. We, SPORTON INTERNATIONAL INC. Hsinhua Laboratory, would like to declare that the tested sample has been evaluated in accordance with the procedures given in ANSI C63.10-2013 and shown compliance with the applicable technical standards.

The test results in this report apply exclusively to the tested model / sample. Without written approval of SPORTON INTERNATIONAL INC. Hsinhua Laboratory, the test report shall not be reproduced except in full.



Approved by: Jackson Tsai

SPORTON INTERNATIONAL INC. Hsinhua Laboratory

No.52, Huaya 1st Rd., Guishan Dist., Taoyuan City 333411, Taiwan (R.O.C.)



Table of Contents

1 GENERAL DESCRIPTION5

1.1 Information.....5

1.2 Testing Applied Standards6

1.3 Testing Location Information6

1.4 Measurement Uncertainty6

2 TEST CONFIGURATION OF EUT.....7

2.1 Test Condition7

2.2 The Worst Case Configuration7

2.3 The Worst Case Measurement Configuration7

2.4 Accessory8

2.5 Support Equipment.....8

2.6 Test Setup Diagram9

3 TRANSMITTER TEST RESULT10

3.1 AC Power-line Conducted Emissions10

3.2 Transmitter Radiated Emissions12

3.3 Emission Bandwidth15

4 TEST EQUIPMENT AND CALIBRATION DATA.....16

APPENDIX A. TEST RESULT OF AC POWER-LINE CONDUCTED EMISSIONS

APPENDIX B. TEST RESULT OF TRANSMITTER RADIATED EMISSIONS

APPENDIX C. TEST RESULT OF EMISSION BANDWIDTH

APPENDIX D. TEST PHOTOS

PHOTOGRAPHS OF EUT v02



Summary of Test Result

Report Clause	Ref Std. Clause	Test Items	Result (PASS/FAIL)	Remark
1.1.2	15.203	Antenna Requirement	PASS	-
3.1	15.207	AC Power-line Conducted Emissions	PASS	-
3.2	15.209	Transmitter Radiated Emissions	PASS	-
3.3	15.215(c)	Emission Bandwidth	PASS	-

Declaration of Conformity:
The test results with all measurement uncertainty excluded are presented in accordance with the regulation limits or requirements declared by manufacturers.
Comments and Explanations:
None.

Reviewed by: Ryan Hsiao

Report Producer: Ann Hou



1 General Description

1.1 Information

1.1.1 RF General Information

RF General Information				
Frequency Range (kHz)	Modulation	Ch. Frequency(kHz)	Channel Number	Field Strength (dBuV/m)
531.25/562.5/593.75/625	ASK	562.5	4	58.49
Note 1: Field strength performed peak level at 1m.				

1.1.2 Antenna Information

Ant.	Brand	Model Name	Antenna Type	Connector
1	-	-	Array Coil Pointing	NA

1.1.3 Type of EUT

Operational Condition	
EUT Power Type	From AC Adapter
Type of EUT	
<input checked="" type="checkbox"/>	Stand-alone
<input type="checkbox"/>	Combined (EUT where the radio part is fully integrated within another device) Combined Equipment - Brand Name / Model No.: ...
<input type="checkbox"/>	Plug-in radio (EUT intended for a variety of host systems) Host System - Brand Name / Model No.: ...
<input type="checkbox"/>	Other:

1.1.4 Test Signal Duty Cycle

Operated Mode for Worst Duty Cycle	
<input checked="" type="checkbox"/>	Operated normal mode for worst duty cycle
<input type="checkbox"/>	Operated test mode for worst duty cycle
Test Signal Duty Cycle (x)	
<input checked="" type="checkbox"/>	100.00%

1.1.5 Table for Multiple Listing

The model names in the following table are all refer to the identical product.

Model Name	Description
DTH134 , DTH134W0A , DTH134W2A	All the models are identical, the different model served as marketing strategy.



1.2 Testing Applied Standards

According to the specifications of the manufacturer, the EUT must comply with the requirements of the following standards:

- ♦ 47 CFR FCC Part 15
- ♦ ANSI C63.10-2013

The following reference test guidance is not within the scope of accreditation of TAF:

- ♦ KDB 414788 D01 v01r01

1.3 Testing Location Information

Test Lab. : Sporton International Inc. Hsinhua Laboratory				
<input checked="" type="checkbox"/>	Hsinhua (TAF: 3785)	ADD: No.52, Huaya 1st Rd., Guishan Dist., Taoyuan City 333411, Taiwan (R.O.C.)		
		TEL: 886-3-327-3456	FAX: 886-3-327-0973	
Test site Designation No. TW3785 with FCC.				
Test Condition	Test Site No.	Test Engineer	Test Environment	Test Date
AC Conduction	CO04-HY	Jack	21.3~22.5°C / 56~61%	18/May/2022
RF Conducted	TH07-HY	Alan	20.1~26.9°C / 50~60%	20/May/2022
Radiated	03CH03-HY	Daniel	20.3~25.7°C / 53~64%	04/May/2022
<input type="checkbox"/>	Wen 33rd.St. (TAF: 3785)	ADD: No.14-1, Ln. 19, Wen 33rd St., Guishan Dist., Taoyuan City 333010, Taiwan (R.O.C.)		
		TEL: 886-3-318-0787	FAX: 886-3-318-0287	
Test site Designation No. TW0008 with FCC.				

1.4 Measurement Uncertainty

ISO/IEC 17025 requires that an estimate of the measurement uncertainties associated with the emissions test results be included in the report. The measurement uncertainties given below are based on a 95% confidence level (based on a coverage factor (k=2))

Test Items	Uncertainty	Remark
Conducted Emission (150kHz ~ 30MHz)	0.9 dB	Confidence levels of 95%
Radiated Emission (9kHz ~ 30MHz)	2.4 dB	Confidence levels of 95%
Radiated Emission (30MHz ~ 1,000MHz)	3.7 dB	Confidence levels of 95%
Conducted Emission	1.0 dB	Confidence levels of 95%
Temperature	0.41 °C	Confidence levels of 95%
Humidity	3.4 %	Confidence levels of 95%

2 Test Configuration of EUT

2.1 Test Condition



Condition Item	Abbreviation/Remark	Remark
Tnom Vnom	Tnom	20°C
-	Vnom	120V

2.2 The Worst Case Configuration

Mode	Test Channel Frequencies(kHz)	Field Strength (dBuV/m@1m)	Field Strength (dBuV/m@3m)
SRD	562.5	58.49	39.41

2.3 The Worst Case Measurement Configuration

The Worst Case Mode for Following Conformance Tests	
Tests Item	AC power-line conducted emissions
Condition	AC power-line conducted measurement for line and neutral
Operating Mode	CTX
1	Adapter mode

The Worst Case Mode for Following Conformance Tests			
Tests Item	Emission Bandwidth, Field Strength of Fundamental Emissions Transmitter Radiated Unwanted Emissions		
Test Condition	Radiated measurement		
User Position	<input type="checkbox"/> EUT will be placed in fixed position.		
	<input type="checkbox"/> EUT will be placed in mobile position and operating multiple positions. EUT shall be performed three orthogonal planes.		
	<input checked="" type="checkbox"/> EUT will be a hand-held or body-worn battery-powered devices and operating multiple positions.		
Operating Mode	CTX		
1	Adapter mode		
Orthogonal Planes of EUT	X Plane	Y Plane	Z Plane
			
Worst Planes of EUT	V		



2.4 Accessory

Accessories Information				
USB 3 in 1 Cable	Brand Name	N/A	Model Name	JPA-W-J349-000
	Signal Line	2.2 meter, shielded cable, w/o ferrite core		
Digital Pen	Brand Name	Wacom	Model Name	CP-923-03B-2
AC Adapter	Brand Name	Jiangsu Leader Electronics Inc.	Model Name	IU25-2200125-U
	Power Rating	I/P: 100 - 240Vac, 50/60Hz, 45VA~50VA, 0.7A O/P: 5 Vdc, 3A, 15.0W O/P: 9 Vdc, 2.77A, 24.93W O/P: 15 Vdc, 1.68A, 24.9W O/P: 20 Vdc, 1.25A, 25.0W		
Type-C Cable*2	Brand Name	N/A	Model Name	JPA-W-J350-000
	Signal Line	1.8 meter, shielded cable, w/o ferrite core		

Reminder: Regarding to more detail and other information, please refer to user manual.

2.5 Support Equipment

Support Equipment – AC Conduction					
No.	Equipment	Brand Name	Model Name	FCC ID	Remark
1	Portable SSD(3.1)	TRANSCEND	TS240GESD240C	-	-

Support Equipment – Conducted					
No.	Equipment	Brand Name	Model Name	FCC ID	Remark
1	Notebook	DELL	E5410	-	-
2	Adapter for NB	DELL	HA65NM130	-	-

Support Equipment – Radiated					
No.	Equipment	Brand Name	Model Name	FCC ID	Remark
1	Portable SSD(3.1)	TRANSCEND	TS240GESD240C	-	-

2.6 Test Setup Diagram

Test Setup Diagram – AC Line Conducted Emission Test

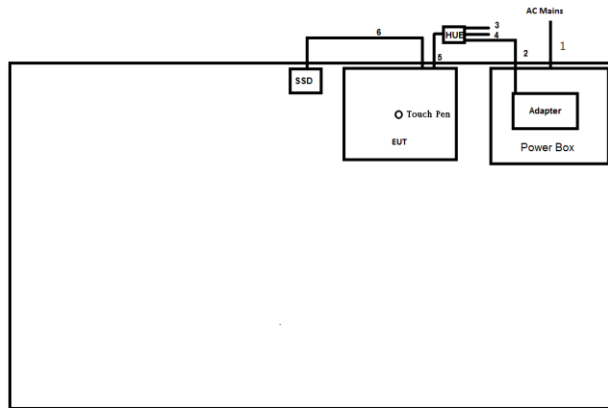

Item	Connection	Shielded	Length(m)
1	AC Power cable	No	1.8
2	Type C cable	YES	1.0
3	HDMI cable	YES	0.82
4	USB cable	YES	0.82
5	Type C cable	YES	1.3
6	Type C cable	YES	1.8

Test Setup Diagram - Radiated Test

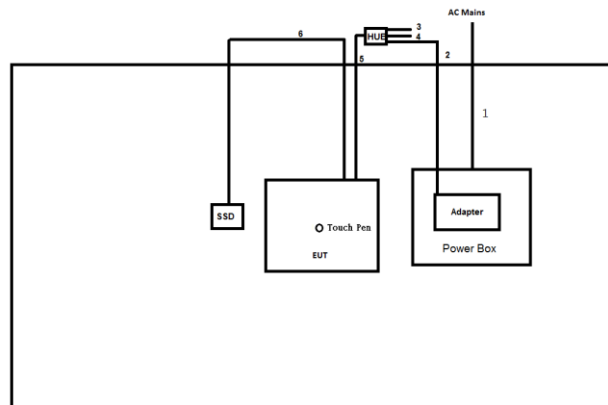

Item	Connection	Shielded	Length(m)
1	AC Power cable	No	1.8
2	Type C cable	YES	1.0
3	HDMI cable	YES	0.82
4	USB cable	YES	0.82
5	Type C cable	YES	1.3
6	Type C cable	YES	1.8



3 Transmitter Test Result

3.1 AC Power-line Conducted Emissions

3.1.1 AC Power-line Conducted Emissions Limit

AC Power-line Conducted Emissions Limit		
Frequency Emission (MHz)	Quasi-Peak	Average
0.15-0.5	66 - 56 *	56 - 46 *
0.5-5	56	46
5-30	60	50

Note 1: * Decreases with the logarithm of the frequency.

3.1.2 Measuring Instruments

Refer a test equipment and calibration data table in this test report.

3.1.3 Test Procedures

Test Method	
<input checked="" type="checkbox"/>	Refer as ANSI C63.10-2013, clause 6.2 for AC power-line conducted emissions.
<input checked="" type="checkbox"/>	If AC conducted emissions fall in operating band, then following below test method confirm final result.
<input type="checkbox"/>	Accept measurements done with a suitable dummy load replacing the antenna under the following conditions: (1) Perform the AC line conducted tests with the antenna connected to determine compliance with FCC 15.207 limits outside the transmitter's fundamental emission band; (2) Retest with a dummy load to determine compliance with FCC 15.207 limits within the transmitter's fundamental emission band.
<input checked="" type="checkbox"/>	For a device with a permanent antenna operating at or below 30 MHz, accept measurements done with a suitable dummy load, in lieu of the permanent antenna under the following conditions: (1) Perform the AC line conducted tests with the permanent antenna to determine compliance with the FCC 15.207 limits outside the transmitter's fundamental emission band; (2) Retest with a dummy load in lieu of the permanent antenna to determine compliance with the FCC 15.207 limits within the transmitter's fundamental emission band.

3.1.4 Measurement Results Calculation

The measured Level is calculated using:

Corrected Reading: Raw(Read Level) + LISN(LISN Factor) + CL(Cable Loss) + AT(Attenuator).

3.1.5 Test Setup

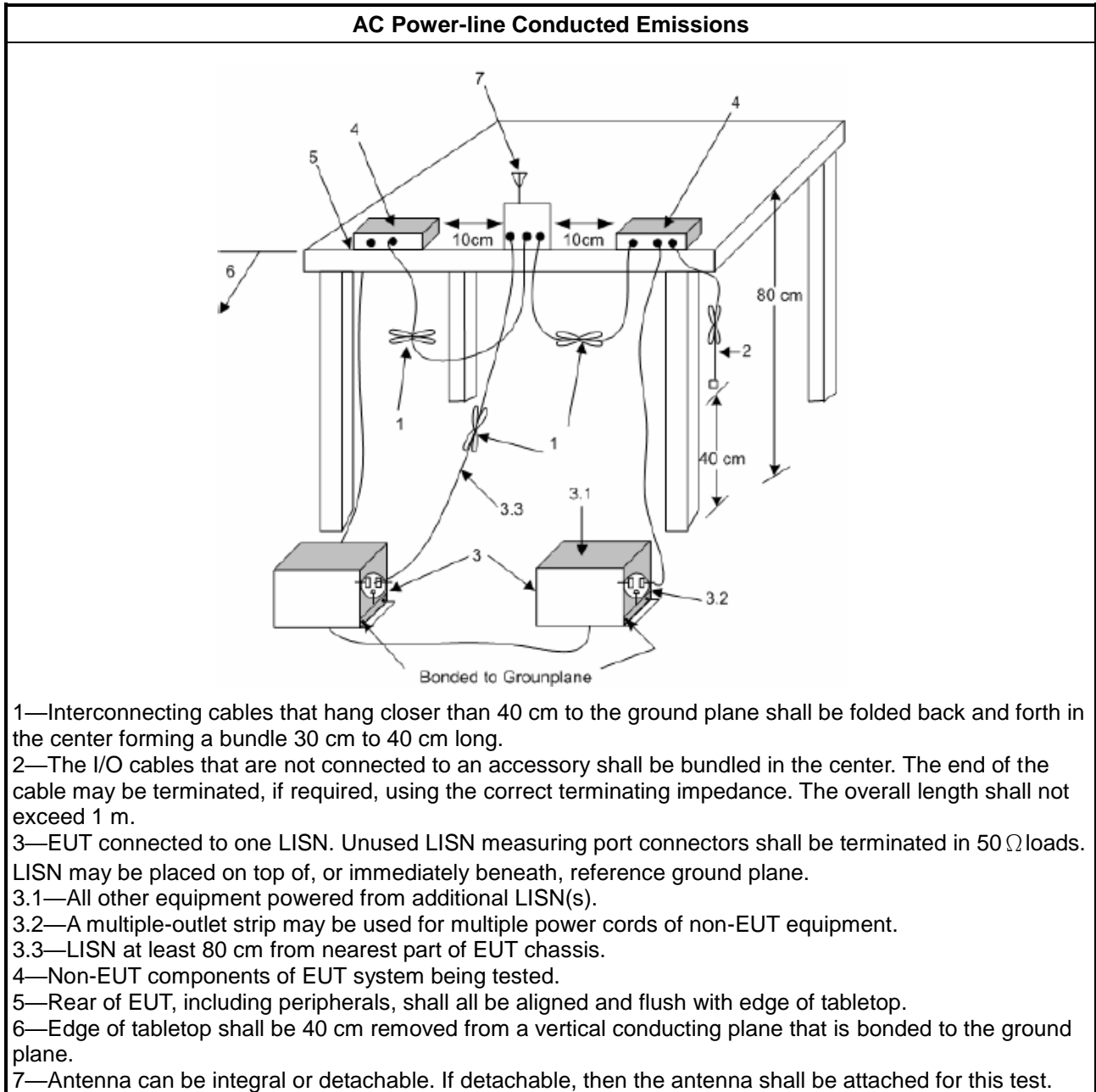

3.1.6 Test Result of AC Power-line Conducted Emissions

Refer as Appendix A



3.2 Transmitter Radiated Emissions

3.2.1 Transmitter Radiated Emissions Limit

Transmitter Radiated Emissions Limit			
Frequency Range (MHz)	Field Strength (uV/m)	Field Strength (dBuV/m)	Measure Distance (m)
0.009~0.490	2400/F(kHz)	48.5 - 13.8	300
0.490~1.705	24000/F(kHz)	33.8 - 23	30
1.705~30.0	30	29	30
30~88	100	40	3
88~216	150	43.5	3
216~960	200	46	3
Above 960	500	54	3

Note 1: Test distance for frequencies at or above 30 MHz, measurements may be performed at a distance other than the limit distance provided they are not performed in the near field and the emissions to be measured can be detected by the measurement equipment. When performing measurements at a distance other than that specified, the results shall be extrapolated to the specified distance using an extrapolation factor of 20 dB/decade (inverse of linear distance for field-strength measurements, inverse of linear distance-squared for power-density measurements).

Note 2: Test distance for frequencies at below 30 MHz, measurements may be performed at a distance closer than the EUT limit distance; however, an attempt should be made to avoid making measurements in the near field. When performing measurements below 30 MHz at a closer distance than the limit distance, the results shall be extrapolated to the specified distance by either making measurements at a minimum of two or more distances on at least one radial to determine the proper extrapolation factor or by using the square of an inverse linear distance extrapolation factor (40 dB/decade). The test report shall specify the extrapolation method used to determine compliance of the EUT.

Note 3: the frequency bands 9-90 kHz, 110-490 kHz measurements employing an average detector and other below 1GHz measurements employing a CISPR quasi-peak detector.

3.2.2 Measuring Instruments

Refer a test equipment and calibration data table in this test report.



3.2.3 Test Procedures

Test Method	
<input checked="" type="checkbox"/>	Refer as ANSI C63.10, clause 6.5 for radiated emissions from 30 MHz to 1 GHz and test distance is 3m.
<input checked="" type="checkbox"/>	Refer as ANSI C63.10, clause 6.4 for radiated emissions from below 30 MHz. The frequency bands 9-90 kHz, 110-490 kHz measurements employing an average detector and other below 30MHz measurements employing a CISPR quasi-peak detector. Test distance is 3m.
<input checked="" type="checkbox"/>	At frequencies below 30 MHz, measurements may be performed at a distance closer than that specified in the requirements; however, an attempt should be made to avoid making measurements in the near field. Pending the development of an appropriate measurement procedure for measurements performed below 30 MHz, when performing measurements at a closer distance than specified, the results shall be following below methods. Note: If fundamental emission level is smaller than noise at 3m , we will change distance to 1m.
<input type="checkbox"/>	The results shall be extrapolated to the specified distance by making measurements at a minimum of two distances on at least one radial to determine the proper extrapolation factor.
<input checked="" type="checkbox"/>	The results shall be by using the square of an inverse linear distance extrapolation factor (40 dB/decade).
<input checked="" type="checkbox"/>	For radiated measurement. Loop antenna was rotated about the horizontal and vertical axis and the equipment to be measured and the test antenna shall be oriented to obtain the maximum emitted field strength level.
<input checked="" type="checkbox"/>	The any unwanted emissions level shall not exceed the fundamental emission level.
<input checked="" type="checkbox"/>	All amplitude of spurious emissions that are attenuated by more than 20 dB below the permissible value has no need to be reported.
<input checked="" type="checkbox"/>	KDB 414788 Open-Field Test Sites and Chamber Correlation Justification.
<input type="checkbox"/>	<ul style="list-style-type: none"> Based on FCC 15.31 (f) (2): measurements may be performed at a distance closer than that specified in regulations; however, an attempt should be made to avoid making measurements in the near field.
<input type="checkbox"/>	<ul style="list-style-type: none"> Open-field site and chamber correlation testing had been performed and chamber measured test result is the worst case test result.

3.2.4 Measurement Results Calculation

The measured Level is calculated using:

Corrected Reading: Raw(Read Level) + AF(Antenna Factor) + CL(Cable Loss) - PA(Preamplifier Factor)

3.2.5 Test Setup

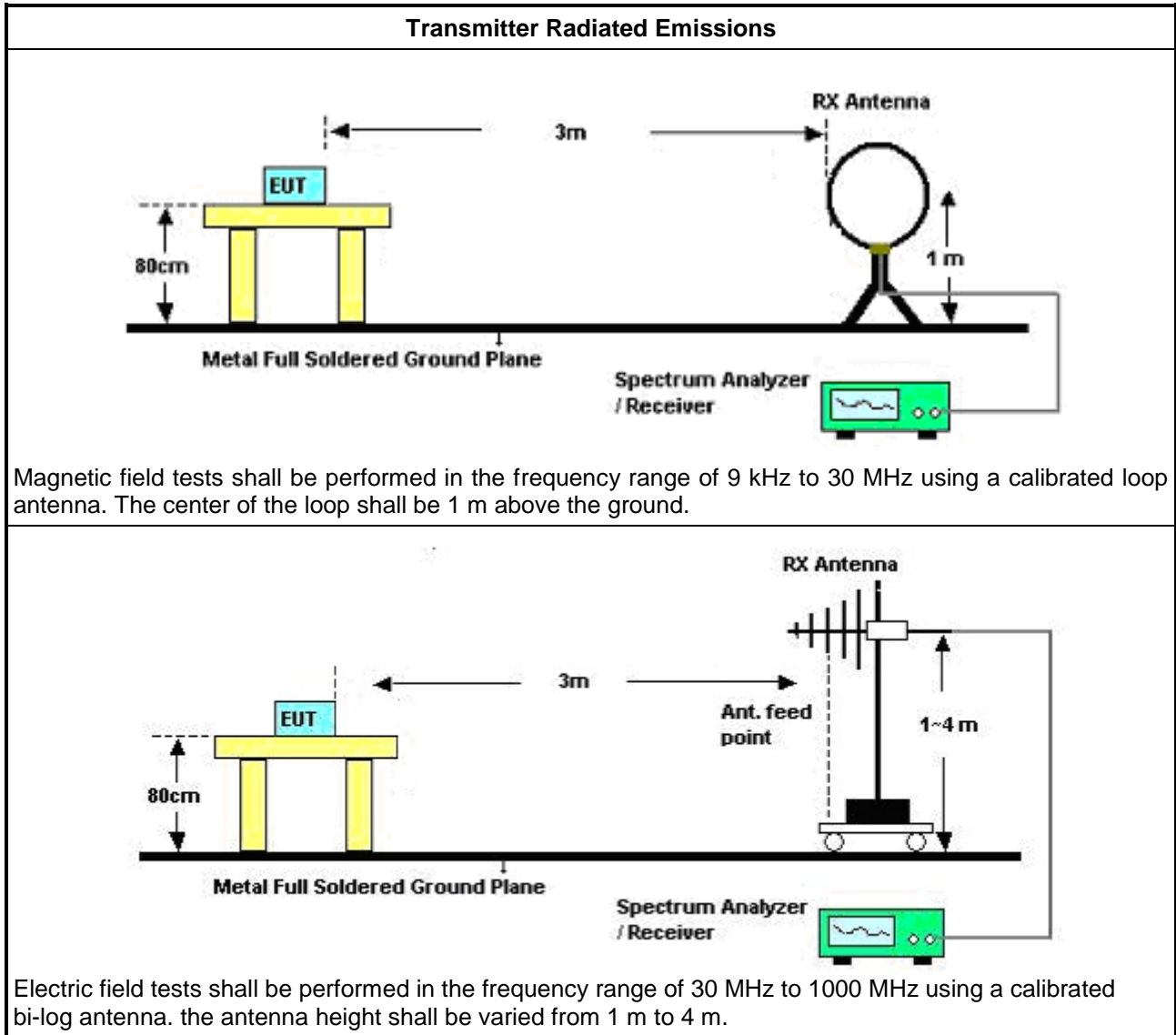

3.2.6 Test Result of Transmitter Radiated Emissions

Refer as Appendix B

3.3 Emission Bandwidth

3.3.1 Emission Bandwidth Limit

Emission Bandwidth Limit
N/A

3.3.2 Measuring Instruments

Refer a test equipment and calibration data table in this test report.

3.3.3 Test Procedures

Test Method
<input checked="" type="checkbox"/> Because the measured signal is CW or CW-like adjusting the RBW per C63.10 would not be practical since measured bandwidth will always follow the RBW and the result will be approximately twice the RBW.
<input checked="" type="checkbox"/> For radiated measurement. Loop antenna was rotated about the horizontal and vertical axis and the equipment to be measured and the test antenna shall be oriented to obtain the maximum emitted field strength level.

3.3.4 Test Setup

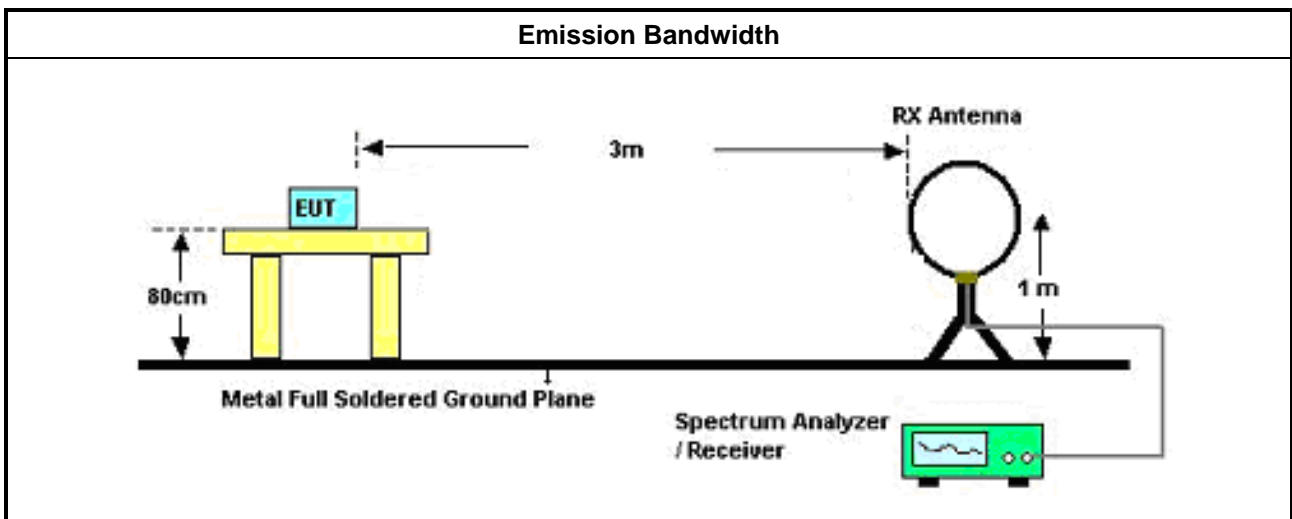

3.3.5 Test Result of Emission Bandwidth

Refer as Appendix C



4 Test Equipment and Calibration Data

Instrument for AC Conduction

Instrument	Manufacturer / Brand	Model No.	Serial No.	Characteristics	Calibration Date	Calibration Due Date
EMI Test Receiver	R&S	ESR3	102051	9kHz ~ 3.6GHz	21/May/2021	20/May/2022
Two-Line V-Network	R&S	ENV 216	100003	9kHz ~ 30MHz	18/Feb/2022	17/Feb/2023
RF Cable 5m	TITAN	TITAN	CO04-cable-01	9 kHz~200MHz	01/Mar/2022	28/Feb/2023
Impuls Begrenzer Pulse Limiter	SCHWARZBECK	VTSD 9561-F	9561-F041	9kHz ~ 30MHz	26/Oct/2021	25/Oct/2022
Software	Sporton	SENSE-EMI	V5.10.7	-	NCR	NCR

NCR: No Calibration Required

Instrument for Conducted Test

Instrument	Manufacturer / Brand	Model No.	Serial No.	Characteristics	Calibration Date	Calibration Due Date
Signal Analyzer	R&S	FSV 40	101515	10Hz~40GHz	14/Feb/2022	13/Feb/2023
SENSE-NFC	Sporton	V5.11.0	N/A	N/A	N/A	N/A

Instrument for Radiated Test

Instrument	Manufacturer / Brand	Model No.	Serial No.	Characteristics	Calibration Date	Calibration Due Date
3m Semi Anechoic Chamber	SIDT FRANKONIA	SAC-3M	03CH03-HY	30MHz~1GHz 3m	03/Aug/2021	02/Aug/2022
Signal Analyzer	R&S	FSV40	101500	10Hz~40GHz	12/Oct/2021	11/Oct/2022
Amplifier	HP	8447D	2944A08033	10kHz~1.3GHz	08/Apr/2022	07/Apr/2023
Bilog Antenna & 6dB Attenuator	SCHAFFNER / EMCI	CBL6112B / N-6-05	22237 / AT-N-0603	30MHz~1GHz	17/Oct/2021	16/Oct/2022
RF Cable-R03m	Jye Bao	RG142	CB021	9kHz~30MHz	16/Jun/2021	15/Jun/2022
RF Cable-R03m	Jye Bao	RG142	MY37335/4+CB021-1+CB021-2	30MHz~1GHz	22/Mar/2022	21/Mar/2023
Loop Antenna	TESEQ	HLA 6120	31244	9kHz~30MHz	18/Mar/2022	17/Mar/2023
EMI Test Receiver	R&S	ESR3	102052	9kHz~3.6GHz	02/Jun/2021	01/Jun/2022
SENSE-303417	Sporton	v5.10.4	NA	NA	NA	NA



Summary

Mode	Result	Type	Freq (Hz)	Level (dBuV)	Limit (dBuV)	Margin (dB)	Condition
Mode 1	Pass	QP	150.6k	50.59	65.96	-15.37	Neutral



Mode Configure

Mode	Result	Type	Freq (Hz)	Level (dBuV)	Limit (dBuV)	Margin (dB)	Condition	Comments
Mode 1	Pass	QP	153.024k	47.05	65.83	-18.78	Line	-
Mode 1	Pass	AV	153.024k	26.78	55.83	-29.05	Line	-
Mode 1	Pass	QP	192.892k	43.08	63.92	-20.84	Line	-
Mode 1	Pass	AV	192.892k	26.37	53.92	-27.55	Line	-
Mode 1	Pass	QP	335.971k	33.54	59.31	-25.77	Line	-
Mode 1	Pass	AV	335.971k	24.90	49.31	-24.41	Line	-
Mode 1	Pass	QP	517.062k	21.96	56.00	-34.04	Line	-
Mode 1	Pass	AV	517.062k	17.72	46.00	-28.28	Line	-
Mode 1	Pass	QP	4.721M	33.44	56.00	-22.56	Line	-
Mode 1	Pass	AV	4.721M	25.51	46.00	-20.49	Line	-
Mode 1	Pass	QP	12.705M	33.00	60.00	-27.00	Line	-
Mode 1	Pass	AV	12.705M	28.21	50.00	-21.79	Line	-
Mode 1	Pass	QP	150.6k	50.59	65.96	-15.37	Neutral	-
Mode 1	Pass	AV	150.6k	31.30	55.96	-24.66	Neutral	-
Mode 1	Pass	QP	203.98k	39.61	63.44	-23.83	Neutral	-
Mode 1	Pass	AV	203.98k	26.41	53.44	-27.03	Neutral	-
Mode 1	Pass	QP	335.971k	33.08	59.31	-26.23	Neutral	-
Mode 1	Pass	AV	335.971k	25.93	49.31	-23.38	Neutral	-
Mode 1	Pass	QP	656.999k	19.39	56.00	-36.61	Neutral	-
Mode 1	Pass	AV	656.999k	15.67	46.00	-30.33	Neutral	-
Mode 1	Pass	QP	3.898M	30.22	56.00	-25.78	Neutral	-
Mode 1	Pass	AV	3.898M	24.71	46.00	-21.29	Neutral	-
Mode 1	Pass	QP	25.549M	32.02	60.00	-27.98	Neutral	-
Mode 1	Pass	AV	25.549M	26.57	50.00	-23.43	Neutral	-

Conducted Emissions at Powerline_Mode 1

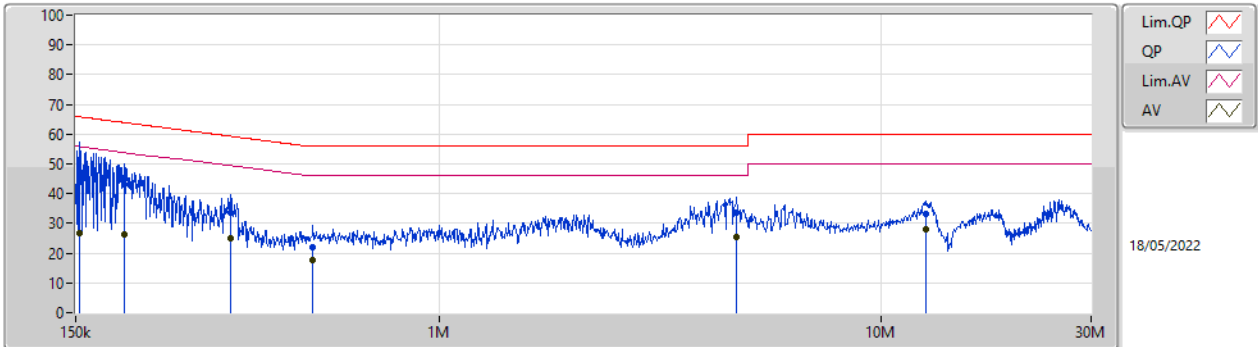

Type	Freq (Hz)	Level (dBuV)	Limit (dBuV)	Margin (dB)	Factor (dB)	Condition	Comment	Raw (dBuV)	LISN (dB)	CL (dB)	AT (dB)
QP	153.024k	47.05	65.83	-18.78	19.63	Line	-	27.42	9.69	0.03	9.91
AV	153.024k	26.78	55.83	-29.05	19.63	Line	-	7.15	9.69	0.03	9.91
QP	192.892k	43.08	63.92	-20.84	19.63	Line	-	23.45	9.69	0.03	9.91
AV	192.892k	26.37	53.92	-27.55	19.63	Line	-	6.74	9.69	0.03	9.91
QP	335.971k	33.54	59.31	-25.77	19.63	Line	-	13.91	9.68	0.04	9.91
AV	335.971k	24.90	49.31	-24.41	19.63	Line	-	5.27	9.68	0.04	9.91
QP	517.062k	21.96	56.00	-34.04	19.63	Line	-	2.33	9.68	0.04	9.91
AV	517.062k	17.72	46.00	-28.28	19.63	Line	-	-1.91	9.68	0.04	9.91
QP	4.721M	33.44	56.00	-22.56	19.79	Line	-	13.65	9.73	0.14	9.92
AV	4.721M	25.51	46.00	-20.49	19.79	Line	-	5.72	9.73	0.14	9.92
QP	12.705M	33.00	60.00	-27.00	19.95	Line	-	13.05	9.80	0.22	9.93
AV	12.705M	28.21	50.00	-21.79	19.95	Line	-	8.26	9.80	0.22	9.93

Conducted Emissions at Powerline_Mode 1

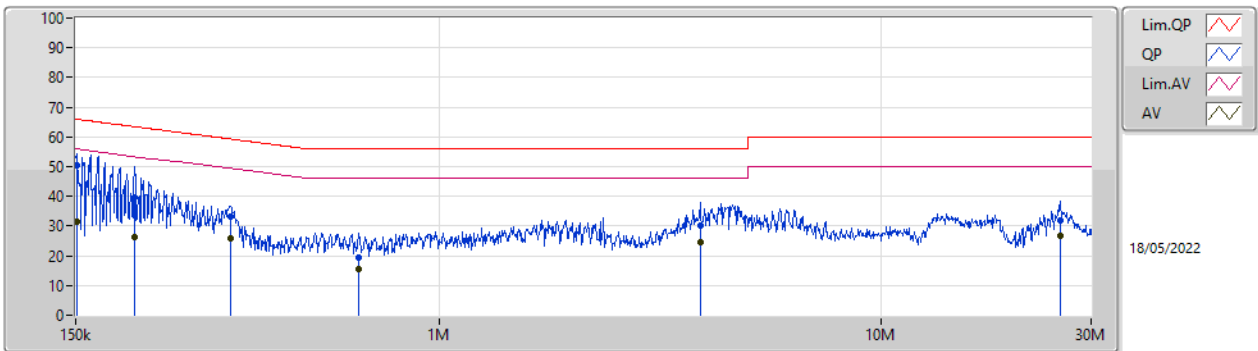

Type	Freq (Hz)	Level (dBuV)	Limit (dBuV)	Margin (dB)	Factor (dB)	Condition	Comment	Raw (dBuV)	LISN (dB)	CL (dB)	AT (dB)
QP	150.6k	50.59	65.96	-15.37	19.67	Neutral	-	30.92	9.73	0.03	9.91
AV	150.6k	31.30	55.96	-24.66	19.67	Neutral	-	11.63	9.73	0.03	9.91
QP	203.98k	39.61	63.44	-23.83	19.66	Neutral	-	19.95	9.72	0.03	9.91
AV	203.98k	26.41	53.44	-27.03	19.66	Neutral	-	6.75	9.72	0.03	9.91
QP	335.971k	33.08	59.31	-26.23	19.67	Neutral	-	13.41	9.72	0.04	9.91
AV	335.971k	25.93	49.31	-23.38	19.67	Neutral	-	6.26	9.72	0.04	9.91
QP	656.999k	19.39	56.00	-36.61	19.70	Neutral	-	-0.31	9.73	0.05	9.92
AV	656.999k	15.67	46.00	-30.33	19.70	Neutral	-	-4.03	9.73	0.05	9.92
QP	3.898M	30.22	56.00	-25.78	19.81	Neutral	-	10.41	9.76	0.13	9.92
AV	3.898M	24.71	46.00	-21.29	19.81	Neutral	-	4.90	9.76	0.13	9.92
QP	25.549M	32.02	60.00	-27.98	20.32	Neutral	-	11.70	10.08	0.31	9.93
AV	25.549M	26.57	50.00	-23.43	20.32	Neutral	-	6.25	10.08	0.31	9.93



Summary

Mode	Result	Type	Freq (Hz)	Level (dBuV/m)	Limit (dBuV/m)	Margin (dB)	Factor (dB)	Dist (m)	Condition	Azimuth (°)	Height (m)	Comments
SRD	Pass	PK	3.195M	48.92	69.50	-20.58	19.92	3	Horizontal	0	1.00	-



Result

Mode	Result	Type	Freq (Hz)	Level (dBuV/m)	Limit (dBuV/m)	Margin (dB)	Factor (dB)	Dist (m)	Condition	Azimuth (°)	Height (m)	Comments
SRD	-	-	-	-	-	-	-	-	-	-	-	-
0.5625MHz_TX	Pass	PK	563.5k	58.49	91.67	-33.18	20.52	1	Horizontal	0	1.00	-
0.5625MHz_TX	Pass	PK	10.41k	74.65	127.24	-52.59	19.03	3	Horizontal	360	1.00	-
0.5625MHz_TX	Pass	PK	40.866k	80.08	115.37	-35.29	21.15	3	Horizontal	360	1.00	-
0.5625MHz_TX	Pass	PK	84.576k	63.38	109.05	-45.67	20.02	3	Horizontal	360	1.00	-
0.5625MHz_TX	Pass	PK	388.8k	55.65	95.80	-40.15	20.30	3	Horizontal	0	1.00	-
0.5625MHz_TX	Pass	PK	687.3k	47.03	70.87	-23.84	20.38	3	Horizontal	0	1.00	-
0.5625MHz_TX	Pass	PK	3.195M	48.92	69.50	-20.58	19.92	3	Horizontal	0	1.00	-

SRD

04/05/2022

0.5625MHz_TX

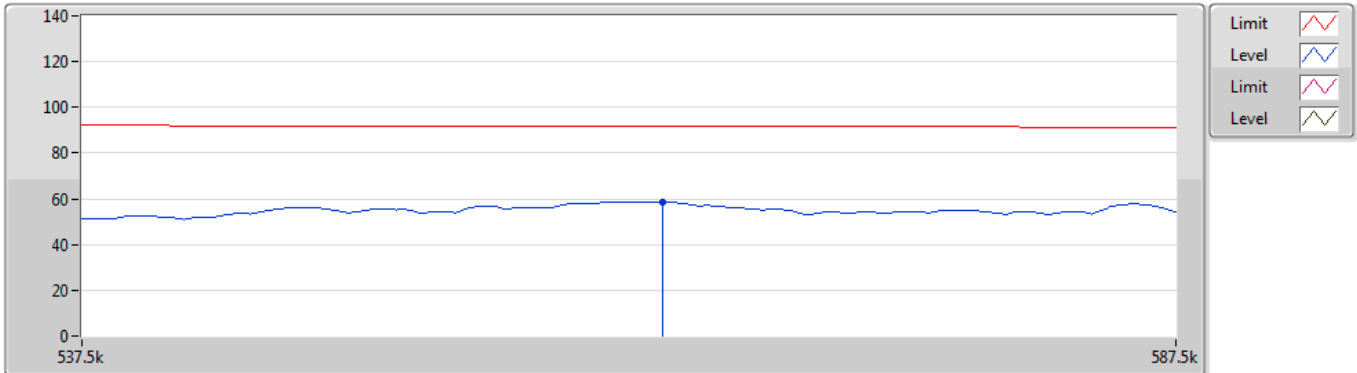

Type	Freq (Hz)	Level (dBuV/m)	Limit (dBuV/m)	Margin (dB)	Factor (dB)	Dist (m)	Condition	Azimuth (°)	Height (m)	Comment	Raw (dBuV)	AF (dB)	CL (dB)	PA (dB)
PK	563.5k	58.49	91.67	-33.18	20.52	1	Horizontal	0	1.00	-	37.97	20.40	0.12	-

SRD

04/05/2022

0.5625MHz_TX



Type	Freq (Hz)	Level (dBuV/m)	Limit (dBuV/m)	Margin (dB)	Factor (dB)	Dist (m)	Condition	Azimuth (°)	Height (m)	Comment	Raw (dBuV)	AF (dB)	CL (dB)	PA (dB)
PK	10.41k	74.65	127.24	-52.59	19.03	3	Horizontal	360	1.00	-	55.62	19.00	0.03	-
PK	40.866k	80.08	115.37	-35.29	21.15	3	Horizontal	360	1.00	-	58.93	21.12	0.03	-
PK	84.576k	63.38	109.05	-45.67	20.02	3	Horizontal	360	1.00	-	43.36	19.97	0.05	-

SRD

04/05/2022

0.5625MHz_TX

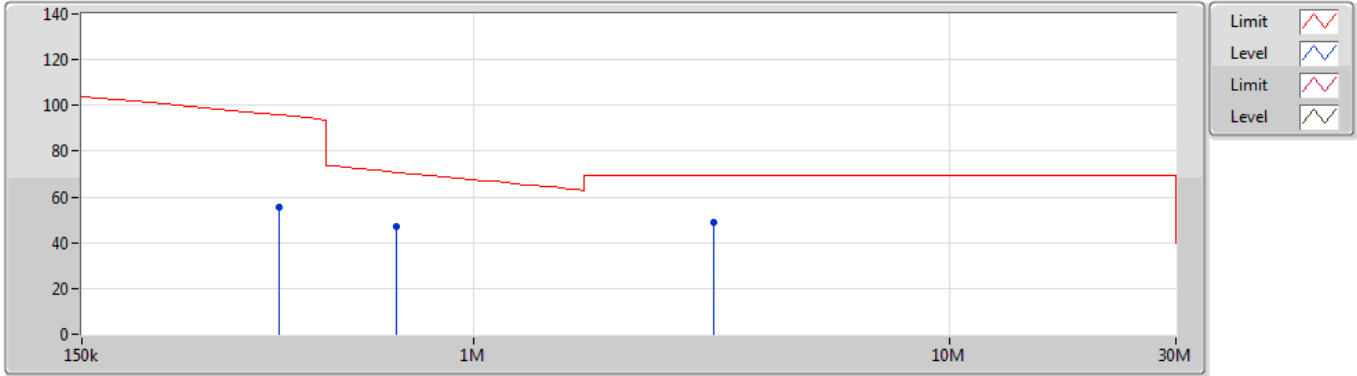

Type	Freq (Hz)	Level (dBuV/m)	Limit (dBuV/m)	Margin (dB)	Factor (dB)	Dist (m)	Condition	Azimuth (°)	Height (m)	Comment	Raw (dBuV)	AF (dB)	CL (dB)	PA (dB)
PK	388.8k	55.65	95.80	-40.15	20.30	3	Horizontal	0	1.00	-	35.35	20.20	0.10	-
PK	687.3k	47.03	70.87	-23.84	20.38	3	Horizontal	0	1.00	-	26.65	20.25	0.13	-
PK	3.195M	48.92	69.50	-20.58	19.92	3	Horizontal	0	1.00	-	29.00	19.68	0.24	-



Summary

Mode	Result	Type	Freq (Hz)	Level (dBuV/m)	Limit (dBuV/m)	Margin (dB)	Factor (dB)	Dist (m)	Condition	Azimuth (°)	Height (m)	Comments
SRD	Pass	PK	30M	33.39	40.00	-6.61	-2.94	3	Vertical	360	1.00	-



Result

Mode	Result	Type	Freq (Hz)	Level (dBuV/m)	Limit (dBuV/m)	Margin (dB)	Factor (dB)	Dist (m)	Condition	Azimuth (°)	Height (m)	Comments
SRD	-	-	-	-	-	-	-	-	-	-	-	-
0.5625MHz_TX	Pass	PK	30M	33.39	40.00	-6.61	-2.94	3	Vertical	360	1.00	-
0.5625MHz_TX	Pass	PK	194.9M	33.15	43.50	-10.35	-10.34	3	Vertical	360	1.00	-
0.5625MHz_TX	Pass	PK	255.04M	29.01	46.00	-16.99	-5.89	3	Vertical	360	1.00	-
0.5625MHz_TX	Pass	PK	342.34M	28.50	46.00	-17.50	-4.59	3	Vertical	360	1.00	-
0.5625MHz_TX	Pass	PK	538.28M	35.44	46.00	-10.56	0.03	3	Vertical	360	1.00	-
0.5625MHz_TX	Pass	PK	714.82M	36.92	46.00	-9.08	1.17	3	Vertical	360	1.00	-
0.5625MHz_TX	Pass	PK	74.62M	26.52	40.00	-13.48	-14.68	3	Horizontal	0	1.00	-
0.5625MHz_TX	Pass	PK	194.9M	33.24	43.50	-10.26	-10.34	3	Horizontal	0	1.00	-
0.5625MHz_TX	Pass	PK	280.26M	30.80	46.00	-15.20	-5.97	3	Horizontal	0	1.00	-
0.5625MHz_TX	Pass	PK	305.48M	30.92	46.00	-15.08	-5.24	3	Horizontal	0	1.00	-
0.5625MHz_TX	Pass	PK	476.2M	28.90	46.00	-17.10	-1.29	3	Horizontal	0	1.00	-
0.5625MHz_TX	Pass	PK	561.56M	34.34	46.00	-11.66	0.17	3	Horizontal	0	1.00	-

SRD

04/05/2022

0.5625MHz_TX

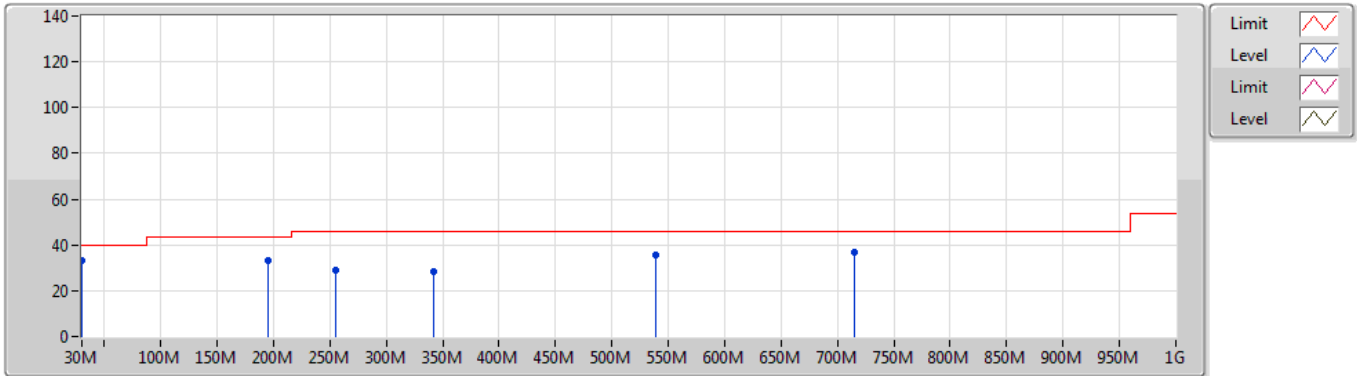

Type	Freq (Hz)	Level (dBuV/m)	Limit (dBuV/m)	Margin (dB)	Factor (dB)	Dist (m)	Condition	Azimuth (°)	Height (m)	Comment	Raw (dBuV)	AF (dB)	CL (dB)	PA (dB)
PK	30M	33.39	40.00	-6.61	-2.94	3	Vertical	360	1.00	-	36.33	23.76	0.88	27.58
PK	194.9M	33.15	43.50	-10.35	-10.34	3	Vertical	360	1.00	-	43.49	14.26	2.32	26.92
PK	255.04M	29.01	46.00	-16.99	-5.89	3	Vertical	360	1.00	-	34.90	18.12	2.66	26.67
PK	342.34M	28.50	46.00	-17.50	-4.59	3	Vertical	360	1.00	-	33.09	19.12	3.11	26.82
PK	538.28M	35.44	46.00	-10.56	0.03	3	Vertical	360	1.00	-	35.41	24.04	3.93	27.94
PK	714.82M	36.92	46.00	-9.08	1.17	3	Vertical	360	1.00	-	35.75	24.40	4.61	27.84

SRD

04/05/2022

0.5625MHz_TX

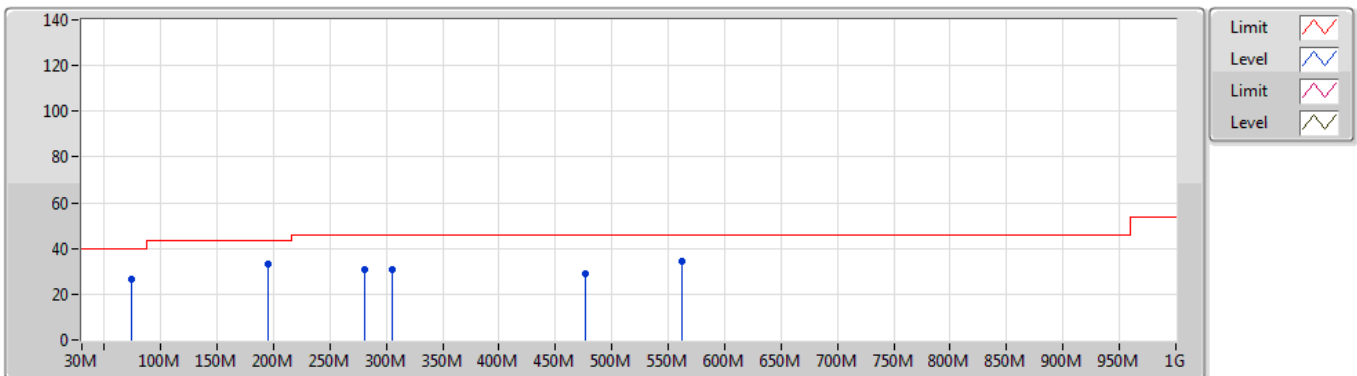

Type	Freq (Hz)	Level (dBuV/m)	Limit (dBuV/m)	Margin (dB)	Factor (dB)	Dist (m)	Condition	Azimuth (°)	Height (m)	Comment	Raw (dBuV)	AF (dB)	CL (dB)	PA (dB)
PK	74.62M	26.52	40.00	-13.48	-14.68	3	Horizontal	0	1.00	-	41.20	11.36	1.41	27.45
PK	194.9M	33.24	43.50	-10.26	-10.34	3	Horizontal	0	1.00	-	43.58	14.26	2.32	26.92
PK	280.26M	30.80	46.00	-15.20	-5.97	3	Horizontal	0	1.00	-	36.77	17.86	2.81	26.64
PK	305.48M	30.92	46.00	-15.08	-5.24	3	Horizontal	0	1.00	-	36.16	18.46	2.94	26.64
PK	476.2M	28.90	46.00	-17.10	-1.29	3	Horizontal	0	1.00	-	30.19	22.67	3.71	27.67
PK	561.56M	34.34	46.00	-11.66	0.17	3	Horizontal	0	1.00	-	34.17	24.12	4.03	27.98



Summary

Mode	15dB (Hz)	FI-15dB (Hz)	Fh-15dB (Hz)	OBW (Hz)	Limit (Range)
562.5k	-	-	-	-	-
SRD_Nss1_1TX	17.9k	546.00000k	563.90000k	108.346k	-

Result

Mode	Result	15dB (Hz)	FI-15dB (Hz)	Fh-15dB (Hz)	OBW (Hz)	FI-OBW (Hz)	Fh-OBW (Hz)	Limit (Range)
SRD_Nss1_1TX	-	-	-	-	-	-	-	-
0.5625MHz_TnomVnom	Pass	17.9k	546.00000k	563.90000k	108.346k	516.22314k	624.56897k	-

SRD_Nss1_1TX

EBW

0.5625MHz_TnomVnom

20/05/2022

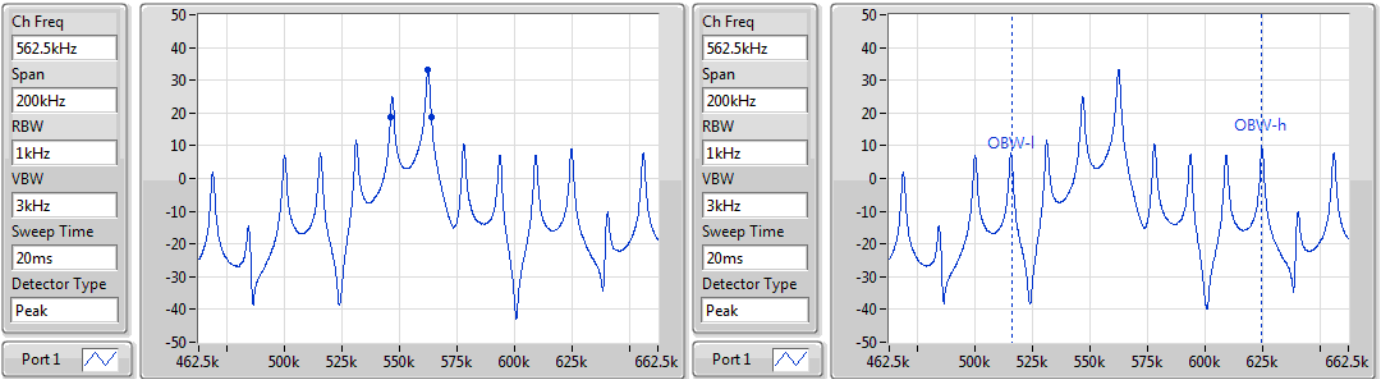

15dB(Hz)	Fl-15dB(Hz)	Fh-15dB(Hz)	OBW(Hz)	Fl-OBW(Hz)	Fh-OBW(Hz)	Limit(Range)
17.9k	546.00000k	563.90000k	108.346k	516.22314k	624.56897k	-