



TEST REPORT

according to

FCC Rules and Regulations Part 15 Subpart C /

RSS-210 Issue 8

Applicant	: Wacom Co., Ltd.
Address	: 2-510-1, Toyonodai, Kazo-shi, Saitama 349-1148 Japan
Equipment	: LCD TABLET
Model No.	: DTH-1300
FCC ID	: HV4DTH1300
IC	: 6888A-DTH1300

The test result refers exclusively to the test presented test model / sample.,

- Without written approval of **CerpPASS Technology (Suzhou) Co.,Ltd.** the test report shall not be reproduced except in full.
- The EUT is also considered as a kind of computer peripheral, because the connection to computer is necessary for typical use. It has been verified to comply with the requirements of FCC Rules and Regulations Part 15/RSS-210. The test report has been issued separately.
- The test report must not be used by the clients to claim product certification approval by **NVLAP** or any agency of the Government.



Contents

1. Report of Measurements and Examinations	5
1.1 List of Measurements and Examinations.....	5
2. Test Configuration of Equipment under Test	6
2.1 Feature of Equipment under Test.....	6
2.2 Test Manner	6
2.3 General Information of Test.....	6
2.4 Measurement Uncertainty.....	6
3. Test of Conducted Emission	6
3.1 Test Limit.....	6
3.2 Test Procedures	6
3.3 Typical Test Setup.....	6
3.4 Measurement equipment.....	6
3.5 Test Result and Data.....	6
4. Test of Radiated Emission	6
4.1 Test Limit.....	6
4.2 Test Procedures.....	6
4.3 Typical Test Setup	6
4.4 Measurement equipment.....	6
4.5 Test Result and Data.....	6
5. 99% BANDWIDTH MEASUREMENT	6
5.1 Test Limit.....	6
5.2 Test Procedures	6
5.3 Typical Test Setup	6
5.4 Measurement equipment.....	6
5.5 Test Result and Data.....	6



CERTIFICATE OF COMPLIANCE

according to

FCC Rules and Regulations Part 15 Subpart C /

RSS-210 Issue 8

Applicant	: Wacom Co., Ltd.
Address	: 2-510-1, Toyonodai, Kazo-shi, Saitama 349-1148 Japan
Equipment	: LCD TABLET
Model No.	: DTH-1300
FCC ID	: HV4DTH1300
IC	: 6888A-DTH1300

I HEREBY CERTIFY THAT :

The measurements shown in this test report were made in accordance with the procedures given in **ANSI C63.4** The equipment was **passed** the test performed according to **FCC Rules and Regulations Part 15 Subpart C (2012)/ RSS-210 Issue 8.**

The test was carried out on Dec 17,2014 at **Cerpass Technology (Suzhou) Co.,Ltd**

Signature

Miro Chueh/ Technical director



1. Report of Measurements and Examinations

1.1 List of Measurements and Examinations

Standards	Description of Test	Result
FCC 15.207 RSS-210, Issue 8	Conducted Emission	Pass
FCC 15.209 RSS-210, Issue 8	Radiated Emission	Pass
RSS-210, Issue 8	99% Bandwidth	Pass



2. Test Configuration of Equipment under Test

2.1 Feature of Equipment under Test

Product	LCD TABLET
Model No.	DTH-1300
Brand	Wacom
Touch Pen	KP-503E
Power Rating	DC 19V
Environment	Indoor use
Operating mode	Normal operating
Frequency Range	667.0kHz
Modulation Method	OOK(On-Off-Keying)



2.2 Test Manner

Test Manner	
a	During testing, the interface cables and equipment positions were varied according to 47 CFR, Part 2, Part 15
b	For all measurement, setup the EUT as the test configurations; turn on all the equipment, use the touch pen near to the EUT, let it operate normal activity.



2.3 General Information of Test

Test Site:	CerpPASS Technology (Suzhou) Co.,Ltd
Test Site Location :	No.66,Tangzhuang Road, Suzhou Industrial Park, Jiangsu 215006, China
NVLAP LAB Code :	200814-0
FCC Registration Number :	331395
IC Registration Number :	7290A-1, 7290A-2
VCCI Registration Number :	T-1945 for Telecommunication Test C-2919 for Conducted emission test R-2670 for Radiated emission test below 1GHz G-227 for Radiated emission test above 1GHz
Frequency Range Investigated:	Conducted: from 150kHz to 30MHz Radiation: from 30MHz to 25000MHz
Test Distance:	The test distance of radiated emission from antenna to EUT is 3 M.

2.4 Measurement Uncertainty

Measurement Item	Measurement Uncertainty
Conducted Emission	± 2.71 dB
Radiation test (10m) below 1GHz	Vertical : ± 3.89 dB
	Horizontal: ± 4.11 dB
Radiation test (3m) below 1GHz	Vertical : ± 4.11 dB
	Horizontal: ± 4.10 dB
Bandwidth	± 7500 Hz



3. Test of Conducted Emission

3.1 Test Limit

Conducted Emissions were measured from 150 kHz to 30 MHz with a bandwidth of 9 KHz on the 120V AC power and return leads of the EUT according to the methods defined in ANSI C63.4-2009 Section 3.1. The EUT was placed on a nonmetallic stand in a shielded room 0.8 meters above the ground plane as shown in section 3.3. The interface cables and equipment positioning were varied within limits of reasonable applications to determine the position produced maximum conducted emissions.

Frequency (MHz)	Quasi Peak (dB μ V)	Average (dB μ V)
0.15 – 0.5	66-56*	56-46*
0.5 – 5.0	56	46
5.0 – 30.0	60	50

*Decreases with the logarithm of the frequency.

3.2 Test Procedures

- a. The EUT was placed 0.4 meter from the conducting wall of the shielding room was kept at least 80 centimeters from any other grounded conducting surface.
- b. Connect EUT to the power mains through a line impedance stabilization network (LISN).
- c. All the support units are connecting to the other LISN.
- d. The LISN provides 50 ohm coupling impedance for the measuring instrument.
- e. The FCC states that a 50 ohm, 50 micro-Henry LISN should be used.
- f. Both sides of AC line were checked for maximum conducted interference.
- g. The frequency range from 150 kHz to 30 MHz was searched.
- h. Set the test-receiver system to Peak Detect Function and Specified Bandwidth with Maximum Hold Mode.



3.3 Typical Test Setup

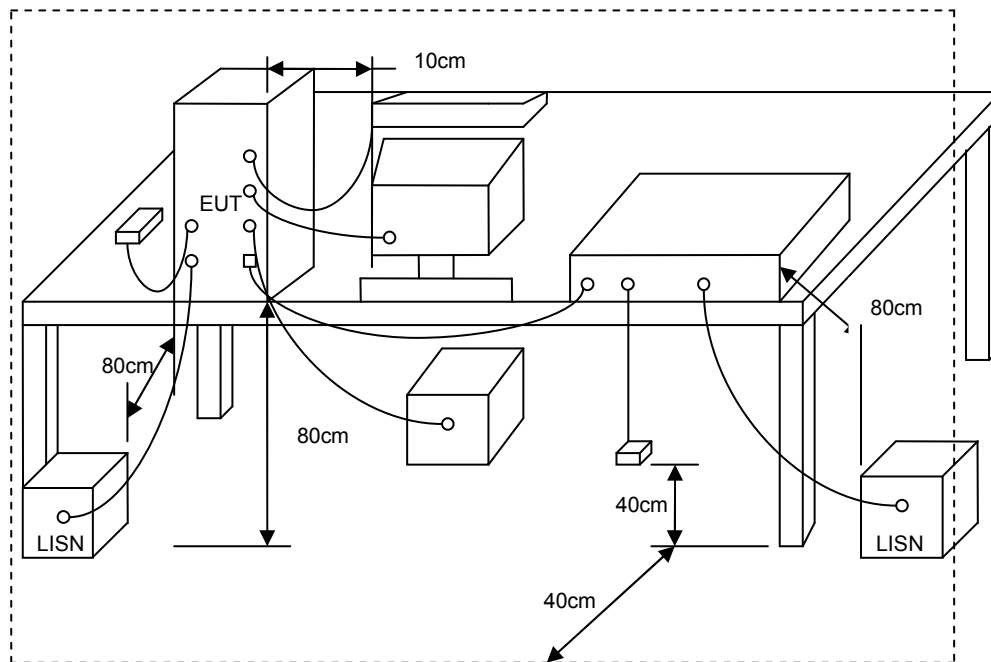

3.4 Measurement equipment

Instrument/Ancillary	Manufacturer	Model No.	Serial No.	Calibration Date	Valid Date.
Test Receiver	R&S	ESCI	100565	2014.03.24	2015.03.23
AMN	R&S	ESH2-Z5	100182	2014.09.04	2015.09.03
ISN	FCC	FCC-TLISN-T2-02	20379	2014.03.24	2015.03.23
ISN	FCC	FCC-TLISN-T4-02	20380	2014.03.24	2015.03.23
ISN	FCC	FCC-TLISN-T8-02	20381	2014.03.24	2015.03.23
ISN	TESEQ	ISN ST08	30175	2014.03.24	2015.03.23
Current Probe	R&S	EZ-17	100303	2014.04.04	2015.04.03
Passive Voltage Probe	R&S	ESH2-Z3	100026	2014.03.24	2015.03.23
Pulse Limiter	R&S	ESH3-Z2	100529	2014.03.24	2015.03.23
Temperature/ Humidity Meter	Zhicheng	ZC1-11	CEP-TH-004	2014.03.31	2015.03.30
EZ-EMC	Fala	Ver CT3A1	N/A	N/A	N/A



3.5 Test Result and Data

Test Mode :	Normal operation		
AC Power :	AC 120V/60Hz	Phase :	LINE
Temperature :	24°C	Humidity :	42%
Pressure(mbar) :	1002	Date :	2014/12/17

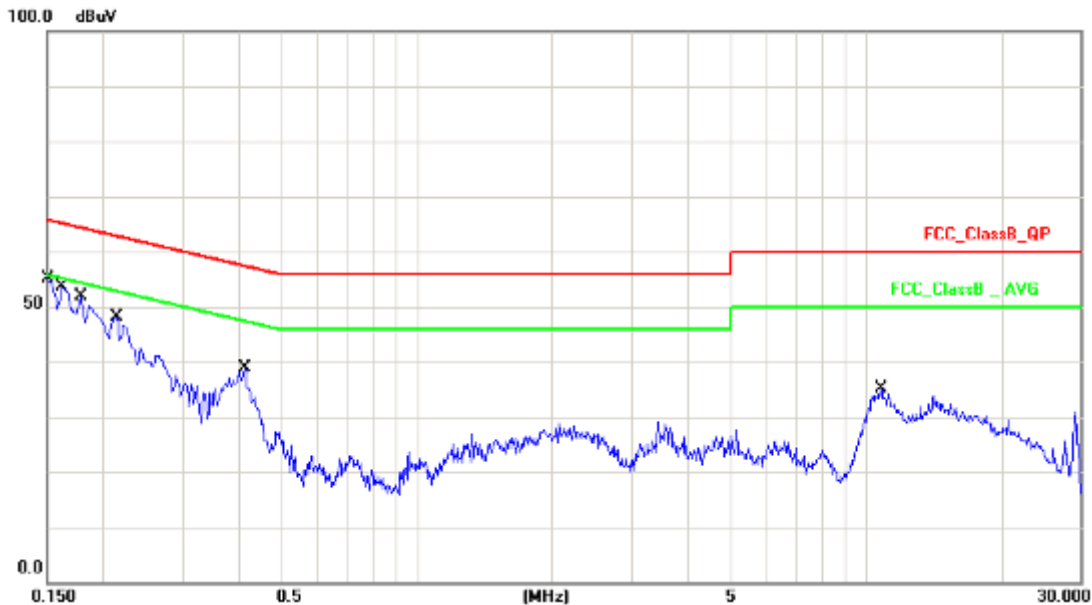

No.	Frequency (MHz)	Factor (dB)	Reading (dBuV)	Level (dBuV)	Limit (dBuV)	Margin (dB)	Detector
1	0.1500	10.13	40.63	50.76	65.99	-15.23	QP
2	0.1500	10.13	24.42	34.55	55.99	-21.44	AVG
3	0.1620	10.13	38.93	49.06	65.36	-16.30	QP
4	0.1620	10.13	22.41	32.54	55.36	-22.82	AVG
5	0.1780	10.12	35.08	45.20	64.57	-19.37	QP
6	0.1780	10.12	19.18	29.30	54.57	-25.27	AVG
7	0.2140	10.12	32.24	42.36	63.04	-20.68	QP
8	0.2140	10.12	14.47	24.59	53.04	-28.45	AVG
9	0.4140	10.15	22.75	32.90	57.57	-24.67	QP
10	0.4140	10.15	17.55	27.70	47.57	-19.87	AVG
11	10.8420	10.30	18.76	29.06	60.00	-30.94	QP
12	10.8420	10.30	13.18	23.48	50.00	-26.52	AVG

Note: Measurement Level = Reading Level + Correct Factor



Test Mode :	Normal operation		
AC Power :	AC 120V/60Hz	Phase :	NEUTRAL
Temperature :	24°C	Humidity :	42%
Pressure(mbar) :	1002	Date :	2014/12/17

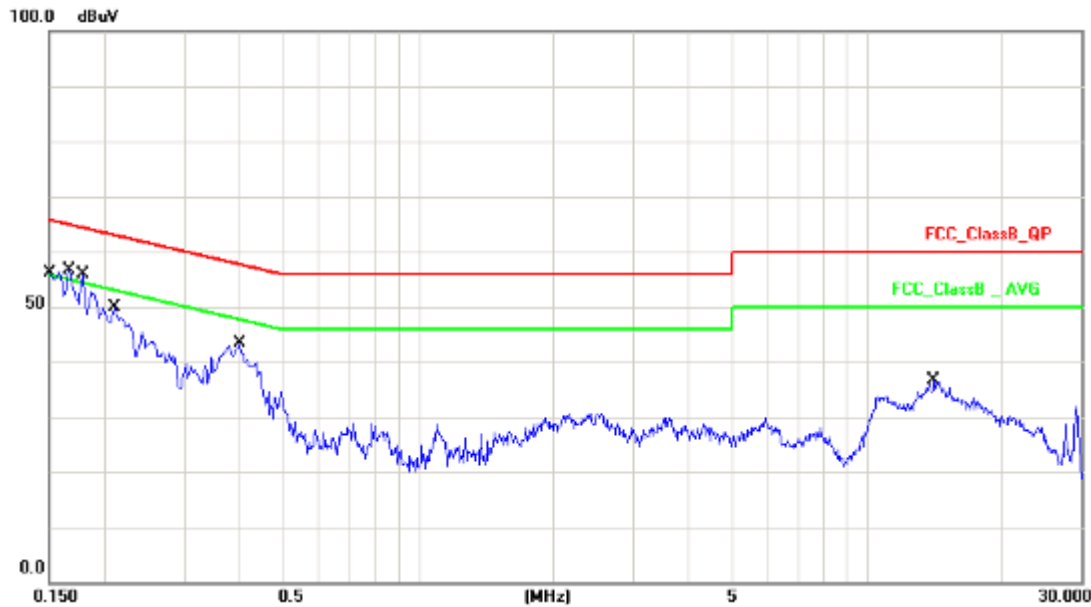

No.	Frequency (MHz)	Factor (dB)	Reading (dBuV)	Level (dBuV)	Limit (dBuV)	Margin (dB)	Detector
1	0.1500	10.13	43.54	53.67	65.99	-12.32	QP
2	0.1500	10.13	28.42	38.55	55.99	-17.44	AVG
3	0.1660	10.13	39.85	49.98	65.15	-15.17	QP
4	0.1660	10.13	26.09	36.22	55.15	-18.93	AVG
5	0.1780	10.13	37.54	47.67	64.57	-16.90	QP
6	0.1780	10.13	23.48	33.61	54.57	-20.96	AVG
7	0.2100	10.13	34.66	44.79	63.20	-18.41	QP
8	0.2100	10.13	19.26	29.39	53.20	-23.81	AVG
9	0.3980	10.15	29.84	39.99	57.89	-17.90	QP
10	0.3980	10.15	24.74	34.89	47.89	-13.00	AVG
11	14.0660	10.48	19.63	30.11	60.00	-29.89	QP
12	14.0660	10.48	13.74	24.22	50.00	-25.78	AVG

Note: Measurement Level = Reading Level + Correct Factor



4. Test of Radiated Emission

4.1 Test Limit

Radiated emissions from 30 MHz to 25 GHz were measured according to the methods defines in ANSI C63.4-2009. The EUT was placed, 0.8 meter above the ground plane. The interface cables and equipment positions were varied within limits of reasonable applications to determine the positions producing maximum radiated emissions.

According to § 15.209(a), the emissions from an intentional radiator shall not exceed the field strength levels specified in the following table:

FREQUENCIES(MHz)	FIELD STRENGTH(microvolts/meter)	MEASUREMENT DISTANCE(meters)
0.009~0.490	2400/F(kHz)	300
0.490~1.705	24000/F(kHz)	30
1.705~30.0	30	30
30~88	100	3
88~216	150	3
216~960	200	3
Above 960	500	3



4.2 Test Procedures

- a. The EUT was placed on a rotatable table top 0.8 meter above ground.
- b. The EUT was set 3 meters from the interference receiving antenna which was mounted on the top of a variable height antenna tower.
- c. The table was rotated 360 degrees to determine the position of the highest radiation.
- d. The antenna is a broadband antenna and its height is varied between one meter and four meters above ground to find the maximum value of the field strength both horizontal polarization and vertical polarization of the antenna are set to make the measurement.
- e. For each suspected emission the EUT was arranged to its worst case and then tune the antenna tower (from 1 M to 4 M) and turn table (from 0 degree to 360 degrees) to find the maximum reading.
- f. Set the test-receiver system to Peak or CISPR quasi-peak Detect Function and specified bandwidth with Maximum Hold Mode.
- g. If the emission level of the EUT in peak mode was 3 dB lower than the limit specified, then testing will be stopped and peak values of EUT will be reported, otherwise, the emissions which do not have 3 dB margin will be repeated one by one using the quasi-peak method and reported.
- h. For testing above 1GHz, the emission level of the EUT in peak mode was 20dB lower than average limit (that means the emission level in peak mode also complies with the limit in average mode), then testing will be stopped and peak values of EUT will be reported, otherwise, the emissions will be measured in average mode again and reported.

4.3 Typical Test Setup

9kHz~30MHz Test Setup

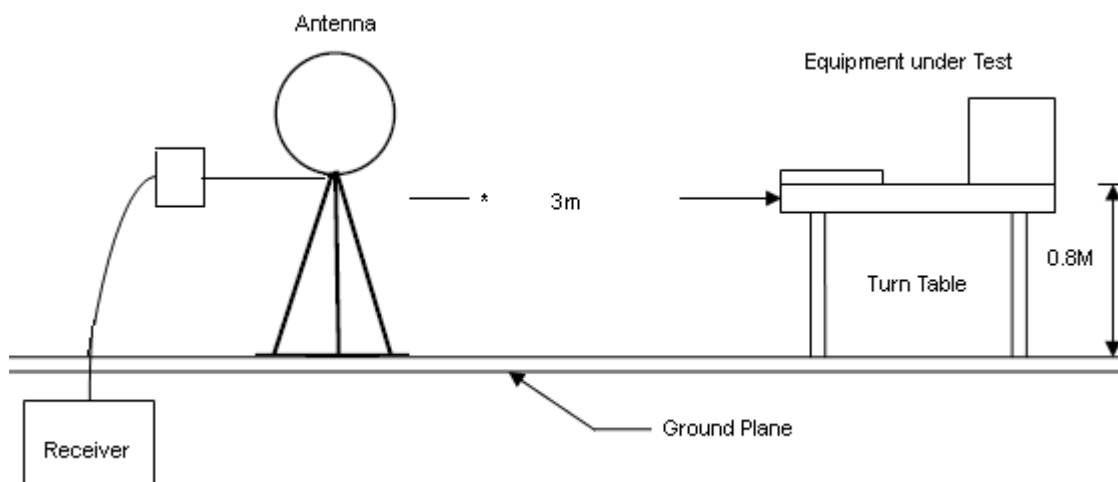



30MHz~1000MHz Test Setup

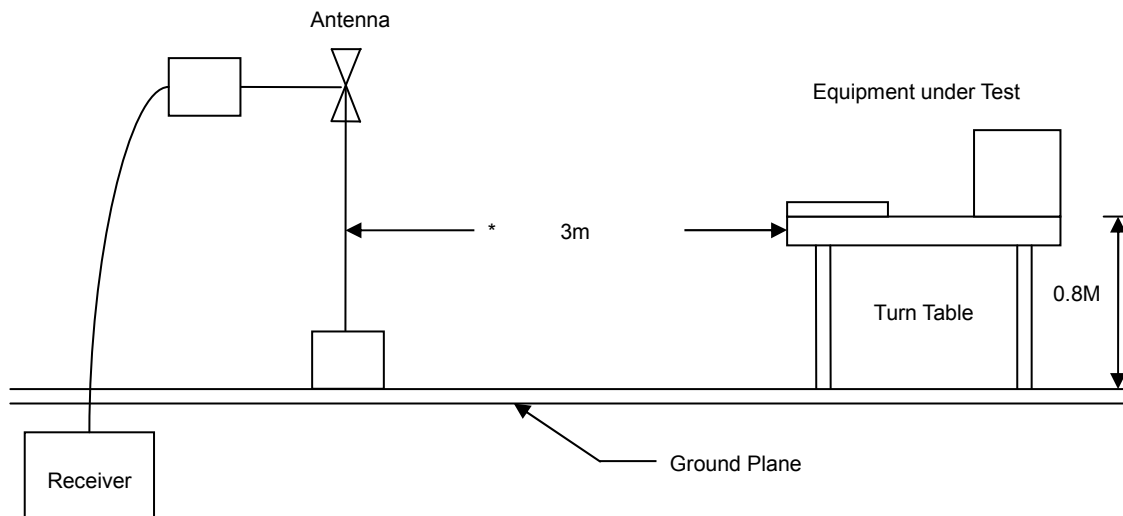

4.4 Measurement equipment

Instrument	Model No.	Manufacturer	Serial No.	Calibration Date	Valid Date.
EMI Test Receiver	R&S	ESCI	100563	2014.03.10	2015.03.09
H64 Preamplifier	HP	8447F	3113A05582	2014.03.10	2015.03.09
Preamplifier	Agilent	8449B	3008A02342	2014.03.10	2015.03.09
Ultra Broadband Antenna	R&S	HL562	100362	2014.05.03	2015.05.02
Loop Antenna	HFH2-Z2	R&S	100150	2014.08.30	2015.08.29
Spectrum Analyzer	Agilent	E4407B	MY44211883	2014.09.25	2015.09.25
Temperature/ Humidity Meter	Zhicheng	ZC1-11	CEP-TH-002	2014.03.10	2015.03.09



4.5 Test Result and Data

4.5.1 Test Result and Data for 9kHz-30MHz

Site : EMC Lab AC 102	Time : 2014-12-17
Limit : FCC_CLASS_B_03M_QP	Margin : 6
EUT : LCD TABLET	Probe : VERTICAL/ HORIZONTAL
Power : AC 120V/60Hz	Note : Transmit at 667kHz

Frequency (MHz)	AntPol. H/V	Result at 3m (dBuV/m)	Result at 30m (dBuV/m)	Limit at 30m (dBuV/m)	Safe Margin (dB)	Detector mode (PK/QP)
0.667	H	46.25	6.25	31.1	-24.85	QP
1.334	H	35.46	-4.54	25.1	-29.64	QP
2.001	H	37.10	-2.9	29.5	-32.4	QP
2.668	H	32.86	-7.14	29.5	-36.64	QP
0.667	V	47.08	7.08	31.1	-24.02	QP
1.334	V	34.13	-5.87	25.1	-30.97	QP
2.001	V	35.89	-4.11	29.5	-33.61	QP
2.668	V	33.25	-6.75	29.5	-36.25	QP

Note:

1. All Readings below 1GHz are Quasi-Peak, above are performed with peak and/or average measurements as necessary.
2. Measurements were corrected to 30m using $40\log(3/30)=-40.0\text{dB}$



4.5.2 Test Result and Data for 30MHz-1000MHz

Test Mode :	RF TX		
AC Power :	AC 120V/60Hz	Ant. Polarization:	Horizontal
Temp :	24°C	Humidity :	52%
Pressure(mbar) :	1002	Date :	2014.12.17

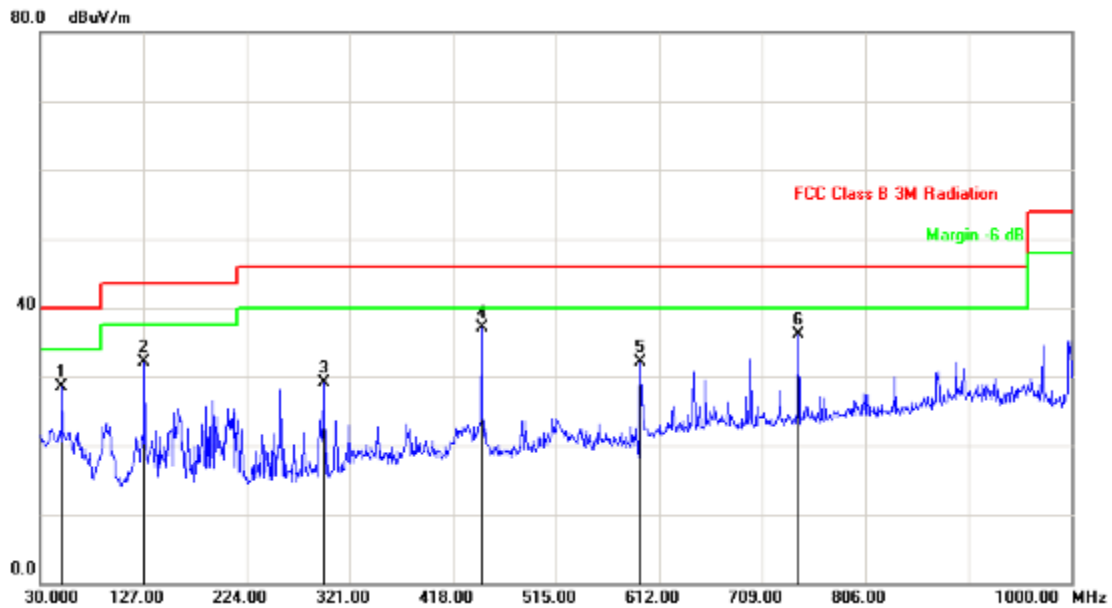

No.	Frequency (MHz)	Factor (dB/m)	Reading (dBuV)	Level (dBuV/m)	Limit (dBuV/m)	Margin (dB)	Det.	Height (cm)	Azimuth (deg)
1	50.3700	-18.65	47.24	28.59	40.00	-11.41	QP	173	0
2	127.9700	-16.90	49.04	32.14	43.50	-11.36	QP	200	0
3	296.7500	-16.72	45.84	29.12	46.00	-16.88	QP	200	351
4	445.1600	-13.53	50.64	37.11	46.00	-8.89	QP	100	138
5	594.5400	-11.31	43.37	32.06	46.00	-13.94	QP	100	333
6	742.9500	-11.04	47.11	36.07	46.00	-9.93	QP	100	232

Note: Measurement Level = Reading Level + Correct Factor



Test Mode :	Mode 4: Full System (LCD 1920*1080@60Hz) with DTH-1300+ Upright Mode		
AC Power :	AC 120V/60Hz	Ant. Polarization:	Vertical
Temp :	24°C	Humidity :	52%
Pressure(mbar) :	1002	Date :	2014.12.02

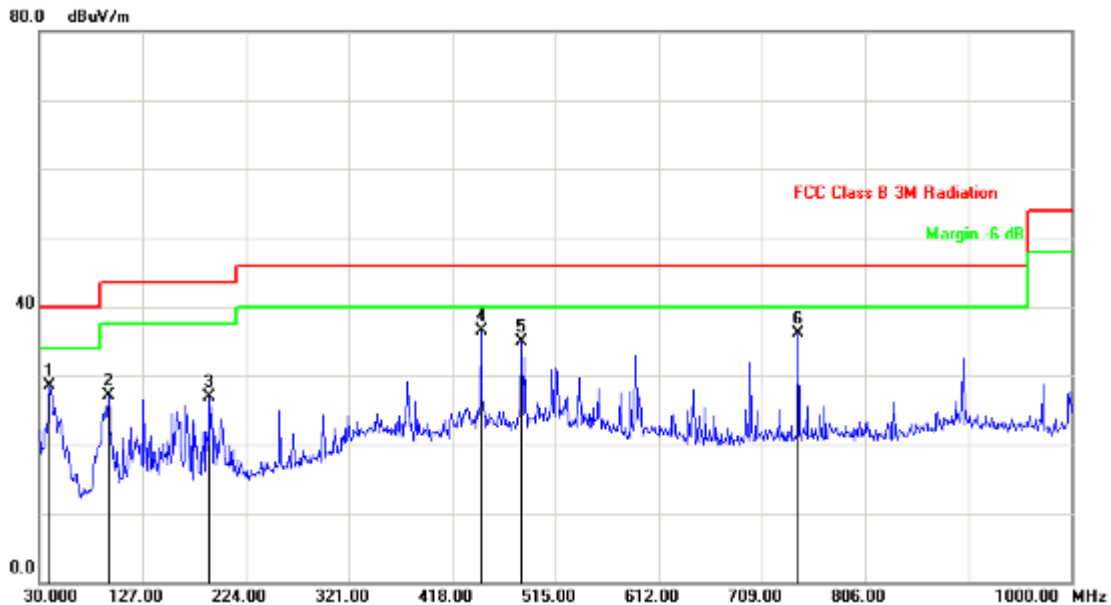

No.	Frequency (MHz)	Factor (dB/m)	Reading (dBuV)	Level (dBuV/m)	Limit (dBuV/m)	Margin (dB)	Det.	Height (cm)	Azimuth (deg)
1	39.7000	-15.10	43.57	28.47	40.00	-11.53	QP	100	304
2	94.9900	-22.39	49.40	27.01	43.50	-16.49	QP	100	186
3	190.0500	-17.93	44.90	26.97	43.50	-16.53	QP	100	163
4	445.1600	-13.40	49.98	36.58	46.00	-9.42	QP	100	339
5	482.9900	-12.81	47.81	35.00	46.00	-11.00	QP	100	274
6	742.9500	-9.23	45.24	36.01	46.00	-9.99	QP	144	0

Note: Measurement Level = Reading Level + Correct Factor



5. 99% BANDWIDTH MEASUREMENT

5.1 Test Limit

None.

5.2 Test Procedures

The transmitter output is connected to the spectrum analyzer. The RBW is set to 1% to 3% of the 99% bandwidth. The VBW is set to 3 times the RBW. The sweep time is coupled. The spectrum analyzer internal 99% bandwidth function is utilized.

The spectrum analyzer is set to:

-RBM=3kHz, VBW=10kHz, Span= 300kHz, Sweep= auto

The test mode of EUT is as follows.

-Normal Operation

5.3 Typical Test Setup

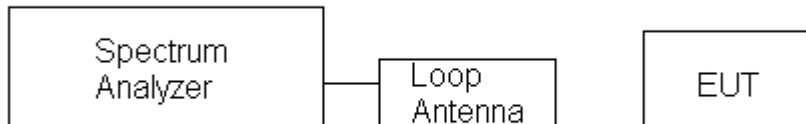

5.4 Measurement equipment

Instrument	Model No.	Manufacturer	Serial No.	Calibration Date	Valid Date.
Spectrum Analyzer	Agilent	E4407B	MY44211883	2014.09.25	2015.09.25
Loop Antenna	ETS	7405	902	N/A	N/A



5.5 Test Result and Data

Frequency (kHz)	Occupied Bandwidth (kHz)
667kHz	32.3970kHz

