

# Wacom® One

## Creative Pen Display

### DTC133

#### EN: REGULATORY STATEMENT FCC NOTICE

This device complies with Part 15 of the FCC Rules. Operation is subject to the following two conditions: (1) this device may not cause harmful interference, and (2) this device must accept any interference received, including interference that may cause undesired operation.

This equipment has been tested and found to comply with the limits for a Class B digital device, pursuant to Part 15 of FCC Rules. These limits are designed to provide reasonable protection against harmful interference in a residential installation.

This equipment generates, uses and can radiate radio frequency energy and, if not installed and used in accordance with the instructions, may cause harmful interference to radio communications. However, there is no guarantee that interference will not occur in a particular installation.

You can determine whether the equipment is causing interference by disconnecting it from your computer. If the interference stops, it was probably caused by the equipment.

If the equipment does cause interference to radio or television reception, you may be able to correct the interference by using one or more of the following measures:

- Reorient or relocate the receiving antenna.
- Increase the separation between the equipment and receiver.
- Connect the equipment into an outlet on a circuit different from that to which the receiver is connected.
- Consult the dealer or an experienced radio/TV technician for help.

Changes or modifications not expressly approved by the party responsible for compliance could void the user's authority to operate the equipment.

This transmitter must not be co-located or operated in conjunction with any other antenna or transmitter.

**FCC Radiation Exposure Statement:**  
This equipment complies with FCC radiation exposure limits set forth for an uncontrolled environment and meets the FCC radio frequency (RF) Exposure Guidelines. This equipment has very low levels of RF energy that are deemed to comply without testing of specific absorption ratio (SAR).

#### INDUSTRY CANADA CAN ICES-3 (B)/NMB-3(B)

**Canada, notice of Industry Canada (IC)**  
This device contains licence-exempt transmitter(s)/ receiver(s) that comply with Innovation, Science and Economic Development Canada's licence-exempt RSS(s). Operation is subject to the following two conditions:  
(1) This device may not cause interference;  
(2) This device must accept any interference, including interference that may cause undesired operation of the device.

**Radiation Exposure Statement:**  
The product complies with the Canada portable RF exposure limit set forth for an uncontrolled environment and are safe for intended operation as described in this manual. The further RF exposure reduction can be achieved if the product can be kept as far as possible from the user body or set the device to lower output power if such function is available.

**EU CONFORMITY INFORMATION**  
 Hereby, Wacom declares that this product is in compliance with RE Directive [2014/53/EU], ErP Directive [2009/125/EC] and RoHS Directive [2011/65/EU]. The full text of the EU declaration of conformity is available at the following internet address: [www.wacom.eu/certificates](http://www.wacom.eu/certificates)

Frequency Band: 562.5/531.25/593.75 kHz  
Maximum Radio-Frequency Power Transmitted: less than -15 dBµA/m

#### ENVIRONMENTAL COMPLIANCE

**E-Waste**  
Wacom Technology, as a manufacturer of electronic products, is subject to and fully compliant with eWaste legislation in various states. For more information on the collection sites and statewide eWaste recycling programs in the United States, please visit <http://www.wacom.com/eWaste> or call 1-800-922-6633.

#### Waste Electrical and Electronic Equipment (WEEE) Directive

 In the European Union, this label icon indicates that this product should not be disposed of with the household waste.

 Wacom products are subject to this directive and therefore you should always collect them separately and bring them to the appropriate electronic waste collection point in your community or region to enable recovery and recycling. Please refer to your community information on how to recycle electronic waste responsibly in your region.

#### For India



#### E-Waste

Wacom products are in conformity with the requirements of the reduction of hazardous substances of the E-waste Rule 2016. The content of hazardous substances with the exemption of the applications listed in SCHEDULE III of the E-waste Rules;

- Not over 0.1% by weight in homogenous materials for Lead, Mercury, Hexavalent Chromium, Polybrominated biphenyls, Polybrominated diphenyl ethers
- Not over 0.01% by weight in homogenous materials for Cadmium

For the proper recycling and disposal of this product after its end of life, please visit our website. Toll free number and e-mail address are also available on this website. <https://www.wacom.com/en-in/e-waste>

#### Do's:

- ✓ Always look for information on the catalogue with our product for end-of-life equipment handling.
- ✓ Ensure that only Authorized Recyclers/Dismantler repair and handle your electronic products.
- ✓ Always call Nearest Wacom collection Point to Dispose products that have reached end-of life.
- ✓ Always drop your used electronic products, batteries or any accessories when they reach the end of their life at your nearest Wacom collection Point.
- ✓ Wherever possible or as instructed, separate the packaging material according to responsible waste disposal options and sorting for recycling.
- ✓ Always ensure any glass surface is protected against breakage.

#### Don'ts:

- × Do not dismantle your electronic Products on your own.
- × Do not throw electronics in bins having "Do not Dispose" sign.
- × Do not give e-waste to informal and unorganized sectors like Local Scrap Dealer/Rag Pickers.
- × Do not dispose your product in garbage bins along with municipal waste that ultimately reaches landfills.

#### How to dispose a product

Carry your end of life product to the nearest collection Point listed on below website. <https://www.wacom.com/en-in/e-waste/e-waste-drop-locations>

#### DE: RECHTLICHE HINWEISE

#### EU-KONFORMITÄTSINFORMATION

 Wacom erklärt hiermit, dass dieses Produkt den Anforderungen der RE-Richtlinie [2014/53/EU], der ErP-Richtlinie [2009/125/EC] und der RoHS-Richtlinie [2011/65/EU] entspricht. Der vollständige Text der EU-Konformitätserklärung ist unter folgender Adresse verfügbar: [www.wacom.eu/certificates](http://www.wacom.eu/certificates)

Frequenzband: 562.5/531.25/593.75 kHz  
Maximale Sendeleistung: weniger als -15 dBµA/m

#### EINHALTUNG VON UMWELTSTANDARDS

#### EU-Richtlinie über Elektro- und Elektronik-Altgeräte (WEEE)

 In der Europäischen Union zeigt dieses Symbol an, dass dieses Produkt nicht mit dem Hausmüll entsorgt werden soll. Für Wacom-Produkte gilt diese Richtlinie. Daher sollten diese Produkte stets getrennt gesammelt werden und zu den entsprechenden elektronischen Abfallsammlungen in Ihrer Region oder Gemeinde zwecks Weiterverarbeitung und Recycling gebracht werden. Bitte wenden Sie sich zum Thema Recycling elektronischer Abfälle in Ihrer Region an Ihre Gemeinde.

#### NL:

#### WETTELIJKE VERKLARING

#### EU-CONFORMITEITSINFORMATIE

 Hierbij verklaart Wacom dat dit product voldoet aan de RE-Richtlijn [2014/53/EU], de ErP-Richtlijn [2009/125/EC] en de RoHS-Richtlijn [2011/65/EU]. De volledige tekst van de EU-conformiteitsverklaring is beschikbaar via het volgende internetadres: [www.wacom.eu/certificates](http://www.wacom.eu/certificates)

Frequentieband: 562.5/531.25/593.75 kHz  
Maximale zendkracht radiofrequentie: minder dan -15 dBµA/m

#### MILIEURICHTLIJN

#### Richtlijn Afval van Elektrische en Elektronische Apparatuur (AEEA)

 In de Europese Unie geeft dit label aan dat dit product niet met het huishoudelijk afval mag worden weggegooid. Wacom-producten vallen onder de bepalingen van deze richtlijn en dienen apart naar het desbetreffende verzamelpunt voor opslag en recycling van elektronisch afval bij u in de buurt te worden gebracht. Raadpleeg de informatie voor uw buurt over hoe u elektronisch afval in uw regio op een verantwoorde manier recycleert.

#### FR:

#### DÉCLARATIONS DE CONFORMITÉ

#### INDUSTRIE CANADA (CANADA UNIQUEMENT)

CAN ICES-3 (B)/NMB-3(B)

**Canada, avis d'Industrie Canada (IC)**  
L'émetteur/récepteur exempt de licence contenu dans le présent appareil est conforme aux CNR d'Innovation, Sciences et Développement économique Canada applicables aux appareils radio exempts de licence. L'exploitation est autorisée aux deux conditions suivantes:  
1) l'appareil ne doit pas produire de brouillage;  
2) l'utilisateur de l'appareil doit accepter tout brouillage radioélectrique subi, même si le brouillage est susceptible d'en compromettre le fonctionnement.

#### Déclaration d'exposition aux radiations:

Le produit est conforme aux limites d'exposition pour les appareils portables RF pour les Etats-Unis et le

Canada établies pour un environnement non contrôlé. Le produit est sûr pour un fonctionnement tel que décrit dans ce manuel. La réduction aux expositions RF peut être augmentée si l'appareil peut être conservé aussi loin que possible du corps de l'utilisateur ou que le dispositif est réglé sur la puissance de sortie la plus faible si une telle fonction est disponible.

#### INFORMATIONS DE CONFORMITÉ UE

 Par la présente, Wacom déclare que ce produit est conforme à la directive RE [2014/53/EU], à la directive ErP [2009/125/EC] et à la directive RoHS [2011/65/EU]. Le texte intégral de la déclaration de conformité UE est disponible à l'adresse suivante: [www.wacom.eu/certificates](http://www.wacom.eu/certificates)

Bande de fréquences : 562.5/531.25/593.75 kHz  
Puissance maximale transmise par radiofréquence : moins de -15 dBµA/m

#### CONFORMITÉ AVEC LES NORMES ENVIRONNEMENTALES

#### Directive sur les déchets d'équipements électriques et électroniques (DEEE)

 Au sein de l'Union européenne, cette étiquette indique que le produit ne doit pas être jeté avec les déchets ménagers. Les produits Wacom sont soumis à cette Directive et doivent donc être mis au rebut séparément, dans un point de collecte pour les appareils électroniques de votre région, afin d'être récupéré et recyclé. Reportez-vous à la réglementation locale de votre pays en matière de recyclage des déchets d'équipements électroniques.

#### IT:

#### DICHIARAZIONE DI LEGGE

#### INFORMAZIONI SULLA CONFORMITÀ UE

 Con la presente, Wacom dichiara che il presente prodotto è conforme alla direttiva RE [2014/53/EU], alla direttiva ErP [2009/125/EC] e alla direttiva RoHS [2011/65/EU]. Il testo completo della dichiarazione di conformità UE è disponibile al seguente indirizzo Internet: [www.wacom.eu/certificates](http://www.wacom.eu/certificates)

Banda di frequenza: 562.5/531.25/593.75 kHz  
Massima potenza di radiofrequenza trasmessa: inferiore a -15 dBµA/m

**INFORMAZIONI SULLO SMALTIMENTO E SUL RICICLAGGIO**

**Direttiva sui rifiuti di apparecchiature elettriche ed elettroniche (RAEE)**



Nell'Unione europea, questa icona con etichetta indica che tale prodotto non deve essere smaltito con i rifiuti domestici. I prodotti Wacom sono soggetti a questa direttiva, pertanto è necessario sempre raccogliarli separatamente e portarli in un centro di raccolta per rifiuti elettrici ed elettronici, presente nel comune o nella regione di appartenenza, in modo da consentirne il recupero o il riciclo. Fare riferimento alle informazioni della zona di appartenenza relative alle modalità di riciclo dei rifiuti elettrici ed elettronici in maniera responsabile nella propria regione.

**ES:**

**DECLARACIONES REGLAMENTARIAS INFORMACIÓN DE CONFORMIDAD UE**



Por la presente, Wacom declara que este producto cumple la Directiva RE [2014/53/EU], la Directiva ErP [2009/125/EC] y la Directiva RoHS [2011/65/EU]. El texto completo de la declaración de conformidad de la UE está disponible en la siguiente dirección de internet: [www.wacom.eu/certificates](http://www.wacom.eu/certificates)

Banda de frecuencia: 562,5/531,25/593,75 kHz  
Potencia de radiofrecuencia máxima transmitida: menos de -15 dBµA/m

**CONFORMIDAD MEDIOAMBIENTAL**

**Directiva sobre residuos de aparatos eléctricos y electrónicos (WEEE)**



En la Unión Europea, este icono de etiqueta indica que este producto no se debe desechar con los residuos domésticos. Los productos de Wacom están sujetos a esta directiva y, por tanto, deberá separarlos y llevarlos al punto de recogida adecuado de su localidad o provincia para permitir su recuperación y reciclaje. Consulte la información local sobre cómo reciclar residuos electrónicos de forma responsable en su provincia.

**PT:**

**DECLARAÇÕES DE CONFORMIDADE INFORMAÇÕES SOBRE CONFORMIDADE COM A UE**



A Wacom declara por meio deste que este produto está em conformidade com a Diretiva RE [2014/53/EU], a Diretiva ErP [2009/125/EC] e a Diretiva RoHS [2011/65/EU]. O texto completo da declaração de conformidade da UE está disponível no seguinte endereço na internet: [www.wacom.eu/certificates](http://www.wacom.eu/certificates)

Banda de frequência: 562,5/531,25/593,75 kHz  
Potência máxima de radiofrequência transmitida: menos de -15 dBµA/m

**Diretiva de descarte de equipamentos elétricos e eletrônicos (WEEE)**



Na União Europeia, esta etiqueta indica que este produto não deve ser descartado com o lixo comum. Os produtos da Wacom estão sujeitos à esta Diretiva e devem ser sempre coletados separadamente e levados ao ponto de coleta apropriado em sua comunidade ou região para recuperação e reciclagem. Consulte as informações de sua comunidade para obter informações sobre como reciclar resíduos eletrônicos com responsabilidade em sua região.

**JP:**

**規制文書**

**VCCI (EMC) 規制**



この装置は、クラスB情報技術装置です。この装置は、家庭環境で使用されていることを目的としています。この装置がラジオやテレビジョン受信機に近接して使用されると、受信障害を引き起こすことがあります。取扱説明書に従って正しい取り扱いをして下さい。 VCCI-B



資源有効利用促進法の施行により弊社製品の回収、リサイクル活動を行っています。回収方法については弊社ホームページをご参照ください。またはサポートセンターにご連絡ください。

**TC:**

台灣危害物質限制指令 (RoHS) 資訊  
各產品限用有害物質 (RoHS) 含有情況標示於官方網站  
請見 <http://www.wacom.com/zh-tw/support/certificates>

**警語：使用過度恐傷害視力  
注意：使用30分鐘請休息10分鐘  
未滿2歲幼兒不看螢幕，2歲以上  
每天看螢幕不要超過1小時**

製造廠商名稱：Qisda Optronics (Suzhou) Co., Ltd.  
進口商名稱：台灣和冠資訊科技(股)公司

Wacom Taiwan Information Co., Ltd.

產品購買與拆封前請確認商品規格與系統需求  
\*\*\*\*\* 請保留購買證明以確認保固期限 \*\*\*\*\*

進口商地址：104台北市中山區松江路237號9樓之一  
客服專線：0800-500-128  
全球網站：[www.wacom.com](http://www.wacom.com)

**PL:**

**DEKLARACJE WYMAGANE PRZEZ ORGAN NADZORU**

**INFORMACJE DOTYCZĄCE ZGODNOŚCI Z PRZEPISAMI UE**

Niniejszym Wacom oświadcza, że ten produkt jest zgodny z Dyrektywą RE [2014/53/EU], Dyrektywą ErP [2009/125/EC] oraz Dyrektywą RoHS [2011/65/EU]. Pełny tekst deklaracji zgodności UE dostępny jest pod następującym adresem internetowym: [www.wacom.eu/certificates](http://www.wacom.eu/certificates).

Pasma częstotliwości: 562,5/531,25/593,75 kHz  
Maksymalna przenoszona moc częstotliwości radiowej: poniżej -15 dBµA/m

**ZGODNOŚĆ ŚRODOWISKOWA**

**Dyrektywa dotycząca zużytego sprzętu elektrycznego i elektronicznego (WEEE)**



W Unii Europejskiej ta ikona na etykiecie oznacza, że zużyty produkt nie powinien być usuwany razem z odpadami gospodarczymi. Produkty firmy Wacom podlegają wymienionej dyrektywie, tak więc należy zawsze oddzielać je od innych odpadów i dostarczać do lokalnego punktu zbiórki produktów elektronicznych w celu odzyskania i recyklingu. Należy zapoznać się z lokalnymi przepisami dotyczącymi prawidłowego recyklingu odpadów elektronicznych obowiązującymi w danym regionie.

**TR:**

Türkiye Cumhuriyeti: AEEE Yönetmeliğine Uygundur

**VN:**

**Vietnamese RoHS**

Wacom products comply with Vietnam's legislation "THÔNG TƯ 30/2011/TT-BCT: Quy định tạm thời về giới hạn hàm lượng cho phép của một số hóa chất độc hại trong sản phẩm điện, điện tử" which came into effect on December 1, 2012.

**SC:**

**环境合规性**

**China RoHS**



**产品中有害物质的名称及含量**

部件名称	10 有害物质					
	铅 (Pb)	汞 (Hg)	镉 (Cd)	六价铬 (Cr(VI))	多溴联苯 (PBBs)	多溴二苯醚 (PBDEs)
电路板组件	×	○	○	○	○	○
外壳	○	○	○	○	○	○
金属件	○	○	○	○	○	○
连接线	○	○	○	○	○	○
保护玻璃	○	○	○	○	○	○
液晶面板	×	○	○	○	○	○
电源适配器	×	○	○	○	○	○
说明书	○	○	○	○	○	○
触控笔	○	○	○	○	○	○

本表格依据 SJ/T 11364 的规定编制。  
○：表示该有害物质在该部件所有均质材料中的含量均在 GB/T 26572 规定的限量要求以下。  
×：表示该有害物质至少在该部件的某一均质材料中的含量超出 GB/T 26572 规定的限量要求。



For warranty and support information, <http://support.wacom.com/>



**wacom**

Printed in China  
© 2020 Wacom Co., Ltd. All rights reserved. Wacom, Cintiq and their respective logos are trademarks and/or registered trademarks of Wacom Co., Ltd. All other company names and product names are trademarks and/or registered trademarks of their respective owners.

PRN-B222(A)

# wacom® One

Creative Pen Display

[wacom.com/start/wacomone](http://wacom.com/start/wacomone)

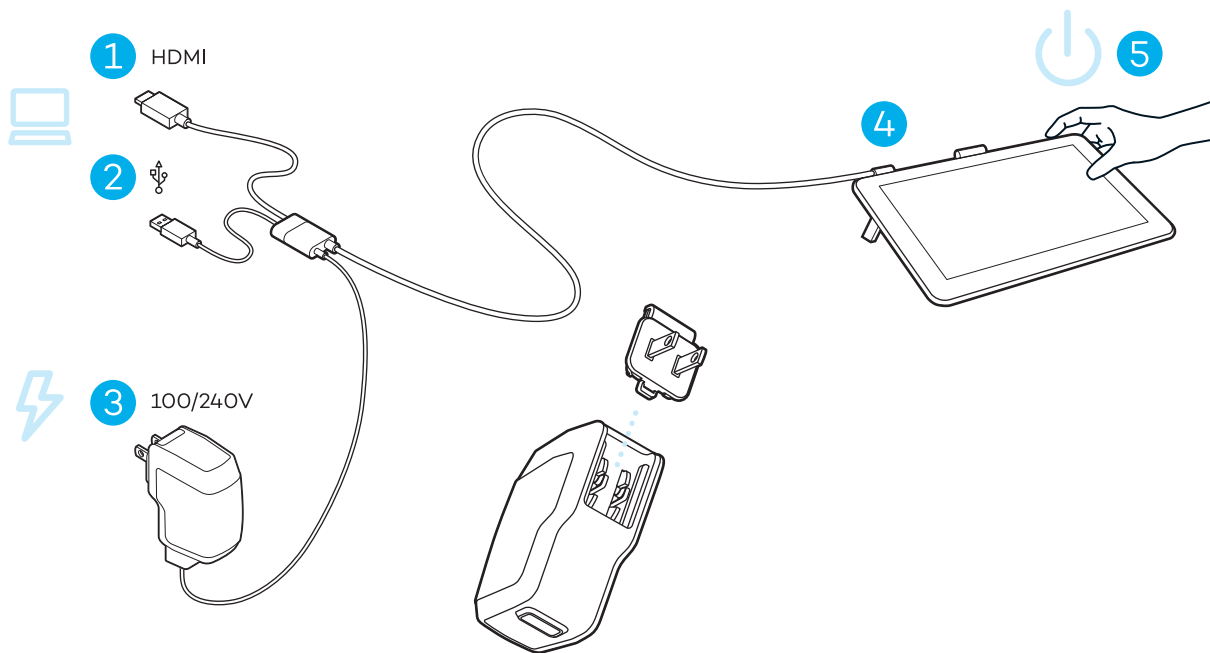

6 [wacom.com/download](http://wacom.com/download)



## You must install the driver

You must install the driver. Then register with us to redeem your software.

Il est nécessaire d'installer le pilote. Puis inscrivez-vous chez nous pour utiliser votre logiciel.

Es necesario instalar el controlador.

A continuación, regístrese para canjear el software.

É necessário instalar o driver. Então, registre-se conosco para resgatar seu software.

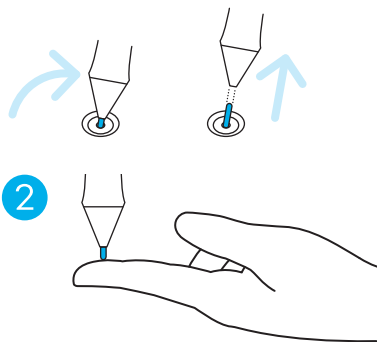
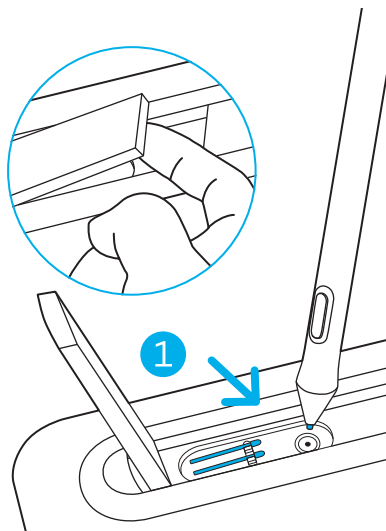

5

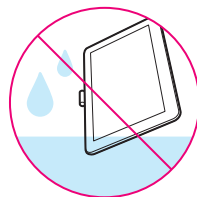
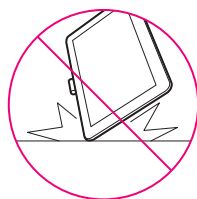
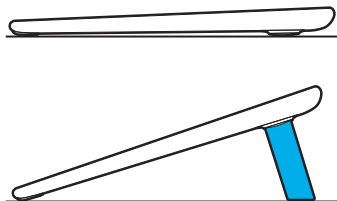

 [wacom.com/manuals](http://wacom.com/manuals)

 [wacom.com/support](http://wacom.com/support)

6

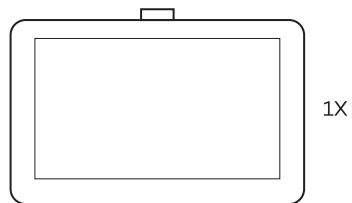

1X

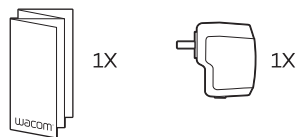
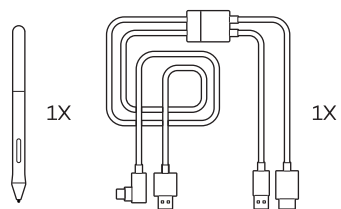

©2020 Wacom Co., Ltd. All rights reserved.  
Wacom and its logo are trademarks or  
registered trademarks of Wacom Co., Ltd.

©2020 Wacom Co., Ltd. Tous droits  
réservés. Wacom et ses logos correspon-  
dants sont des marques commerciales ou  
déposées de Wacom Co., Ltd.

Printed in China | PRN-B223(A)

7



**Wacom**® One  
Creative Pen Display