

FCC Test Report (BT-LE)

Report No.: RF150613E01

FCC ID: HV4CDS600

Model No.: CDS-600*****(* may be alphanumeric/symbol or blank)

Received Date: May 28, 2015

Test Date: June 12 to 18, 2015

Issued Date: July 08, 2015

Applicant: Wacom Co., Ltd.

Address: 2-510-1 Toyonodai, Kazo-shi, Saitama 349-1148 Japan

Issued By: Bureau Veritas Consumer Products Services (H.K.) Ltd., Taoyuan Branch
Hsin Chu Laboratory

Lab Address: No. 81-1, Lu Liao Keng, 9th Ling, Wu Lung Tsuen, Chiung Lin Hsiang, Hsin
Chu Hsien 307, Taiwan R.O.C.

Test Location (1): No. 81-1, Lu Liao Keng, 9th Ling, Wu Lung Tsuen, Chiung Lin Hsiang, Hsin
Chu Hsien 307, Taiwan R.O.C.

Test Location (2): No. 49, Ln. 206, Wende Rd., Shangshan Tsuen, Chiung Lin Hsiang, Hsin
Chu Hsien 307, Taiwan R.O.C.



This report is for your exclusive use. Any copying or replication of this report to or for any other person or entity, or use of our name or trademark, is permitted only with our prior written permission. This report sets forth our findings solely with respect to the test samples identified herein. The results set forth in this report are not indicative or representative of the quality or characteristics of the lot from which a test sample was taken or any similar or identical product unless specifically and expressly noted. Our report includes all of the tests requested by you and the results thereof based upon the information that you provided to us. You have 60 days from date of issuance of this report to notify us of any material error or omission caused by our negligence, provided, however, that such notice shall be in writing and shall specifically address the issue you wish to raise. A failure to raise such issue within the prescribed time shall constitute your unqualified acceptance of the completeness of this report, the tests conducted and the correctness of the report contents. Unless specific mention, the uncertainty of measurement has been explicitly taken into account to declare the compliance or non-compliance to the specification. The report must not be used by the client to claim product certification, approval, or endorsement by TAF or any government agencies.



Table of Contents

Release Control Record	4
1 Certificate of Conformity	5
2 Summary of Test Results	6
2.1 Measurement Uncertainty.....	6
2.2 Modification Record.....	6
3 General Information	7
3.1 General Description of EUT (BT-LE).....	7
3.2 Description of Test Modes.....	8
3.2.1 Test Mode Applicability and Tested Channel Detail.....	9
3.3 Duty Cycle of Test Signal.....	10
3.4 Description of Support Units.....	11
3.4.1 Configuration of System under Test.....	11
3.5 General Description of Applied Standards.....	12
4 Test Types and Results	13
4.1 Radiated Emission and Bandedge Measurement.....	13
4.1.1 Limits of Radiated Emission and Bandedge Measurement.....	13
4.1.2 Test Instruments.....	14
4.1.3 Test Procedures.....	16
4.1.4 Deviation from Test Standard.....	16
4.1.5 Test Setup.....	17
4.1.6 EUT Operating Conditions.....	17
4.1.7 Test Results.....	18
4.2 Conducted Emission Measurement.....	22
4.2.1 Limits of Conducted Emission Measurement.....	22
4.2.2 Test Instruments.....	22
4.2.3 Test Procedures.....	23
4.2.4 Deviation from Test Standard.....	23
4.2.5 Test Setup.....	23
4.2.6 EUT Operating Conditions.....	23
4.2.7 Test Results.....	24
4.3 6dB Bandwidth Measurement.....	26
4.3.1 Limits of 6dB Bandwidth Measurement.....	26
4.3.2 Test Setup.....	26
4.3.3 Test Instruments.....	26
4.3.4 Test Procedure.....	26
4.3.5 Deviation from Test Standard.....	26
4.3.6 EUT Operating Conditions.....	26
4.3.7 Test Result.....	27
4.4 Conducted Output Power Measurement.....	28
4.4.1 Limits of Conducted Output Power Measurement.....	28
4.4.2 Test Setup.....	28
4.4.3 Test Instruments.....	28
4.4.4 Test Procedures.....	28
4.4.5 Deviation from Test Standard.....	28
4.4.6 EUT Operating Conditions.....	28
4.4.7 Test Results.....	29
4.5 Power Spectral Density Measurement.....	30
4.5.1 Limits of Power Spectral Density Measurement.....	30
4.5.2 Test Setup.....	30
4.5.3 Test Instruments.....	30
4.5.4 Test Procedure.....	30
4.5.5 Deviation from Test Standard.....	30
4.5.6 EUT Operating Condition.....	30



4.5.7 Test Results	31
4.6 Conducted Out of Band Emission Measurement.....	32
4.6.1 Limits of Conducted Out of Band Emission Measurement	32
4.6.2 Test Setup.....	32
4.6.3 Test Instruments	32
4.6.4 Test Procedure	32
4.6.5 Deviation from Test Standard	32
4.6.6 EUT Operating Condition	32
4.6.7 Test Results	33
5 Pictures of Test Arrangements.....	34
Appendix – Information on the Testing Laboratories	35



Release Control Record

Issue No.	Description	Date Issued
RF150613E01	Original release.	July 08, 2015

2 Summary of Test Results

47 CFR FCC Part 15, Subpart C (SECTION 15.247)			
FCC Clause	Test Item	Result	Remarks
15.207	AC Power Conducted Emission	PASS	Meet the requirement of limit. Minimum passing margin is -27.01dB at 0.34141MHz.
15.205 15.209 15.247(d)	Radiated Emissions & Band Edge Measurement	Pass	Meet the requirement of limit. Minimum passing margin is -5.9dB at 7323.00MHz.
15.247(d)	Antenna Port Emission	PASS	Meet the requirement of limit.
15.247(a)(2)	6dB bandwidth	PASS	Meet the requirement of limit.
15.247(b)	Conducted power	PASS	Meet the requirement of limit.
15.247(e)	Power Spectral Density	PASS	Meet the requirement of limit.
15.203	Antenna Requirement	PASS	No antenna connector is used.

2.1 Measurement Uncertainty

Where relevant, the following measurement uncertainty levels have been estimated for tests performed on the EUT as specified in CISPR 16-4-2:

Measurement	Frequency	Expanded Uncertainty (k=2) (\pm)
Conducted Emissions at mains ports	150kHz ~ 30MHz	2.86 dB
Radiated Emissions up to 1 GHz	30MHz ~ 1GHz	5.43 dB
Radiated Emissions above 1 GHz	1GHz ~ 6GHz	3.65 dB
	6GHz ~ 18GHz	3.88 dB
	18GHz ~ 40GHz	4.11 dB

2.2 Modification Record

There were no modifications required for compliance.

3 General Information

3.1 General Description of EUT (BT-LE)

Product	Digital Notepad
Brand	Wacom
Model No.	CDS-600***** (* may be alphanumeric/symbol or blank)
Status of EUT	ENGINEERING SAMPLE
Power Supply Rating	DC 5V from USB interface DC 3.9V from Battery
Modulation Type	GFSK
Modulation Technology	DTS
Transfer Rate	Up to 1Mbps
Operating Frequency	2402MHz ~ 2480MHz
Number of Channel	40
Output Power	2.051mW
Antenna Type	Refer to Note
Antenna Connector	Refer to Note
Accessory Device	Pen x 1 (Brand: Wacom, Model: UP-3703) Notebook x 1
Data Cable Supplied	USB to Mini USB cable x 1 (unshielded, 1m)

Note:

1. The EUT has three types which are identical to each other in all aspects except for the following table:

Product Name	Brand	Model	Type	Difference
Digital Notepad	Wacom	CDS-600	Cover Type	1. With the same HW/SW 2. With different appearance.
			Pocket Type	
			Sleeve Type	

From the above types, type: **Cover Type** was selected as representative model for the test and its data was recorded in this report.

2. The antenna provided to the EUT, please refer to the following table:

Brand	Antenna Type	Antenna Gain (dBi)	Frequency range (GHz to GHz)	Connector Type
USI	Printed	3.7	2.4~2.4835	NA

3. The EUT was pre-tested under following test modes :

Pre-test Mode	Power
Mode A	Battery
Mode B	Power from USB interface

From the above modes, the worst spurious emission was found in **Mode B**. Therefore only the test data of the modes were recorded in this report.

3.2 Description of Test Modes

40 channels are provided to this EUT:

CHANNEL	FREQ. (MHz)	CHANNEL	FREQ. (MHz)	CHANNEL	FREQ. (MHz)	CHANNEL	FREQ. (MHz)
0	2402	10	2422	20	2442	30	2462
1	2404	11	2424	21	2444	31	2464
2	2406	12	2426	22	2446	32	2466
3	2408	13	2428	23	2448	33	2468
4	2410	14	2430	24	2450	34	2470
5	2412	15	2432	25	2452	35	2472
6	2414	16	2434	26	2454	36	2474
7	2416	17	2436	27	2456	37	2476
8	2418	18	2438	28	2458	38	2478
9	2420	19	2440	29	2460	39	2480

3.2.1 Test Mode Applicability and Tested Channel Detail

EUT CONFIGURE MODE	APPLICABLE TO				DESCRIPTION
	RE≥1G	RE<1G	PLC	APCM	
-	√	√	√	√	-

Where **RE≥1G**: Radiated Emission above 1GHz **RE<1G**: Radiated Emission below 1GHz
PLC: Power Line Conducted Emission **APCM**: Antenna Port Conducted Measurement

NOTE: The EUT had been pre-tested on the positioned of each 3 axis. The worst case was found when positioned on **X-plane**.

Radiated Emission Test (Above 1GHz):

- Pre-Scan has been conducted to determine the worst-case mode from all possible combinations between available modulations, data rates and antenna ports (if EUT with antenna diversity architecture).
- Following channel(s) was (were) selected for the final test as listed below.

AVAILABLE CHANNEL	TESTED CHANNEL	MODULATION TYPE	DATA RATE (Mbps)
0 to 39	0, 19, 39	GFSK	1

Radiated Emission Test (Below 1GHz):

- Pre-Scan has been conducted to determine the worst-case mode from all possible combinations between available modulations, data rates and antenna ports (if EUT with antenna diversity architecture).
- Following channel(s) was (were) selected for the final test as listed below.

AVAILABLE CHANNEL	TESTED CHANNEL	MODULATION TYPE	DATA RATE (Mbps)
0 to 39	0	GFSK	1

Power Line Conducted Emission Test:

- Pre-Scan has been conducted to determine the worst-case mode from all possible combinations between available modulations, data rates and antenna ports (if EUT with antenna diversity architecture).
- Following channel(s) was (were) selected for the final test as listed below.

AVAILABLE CHANNEL	TESTED CHANNEL	MODULATION TYPE	DATA RATE (Mbps)
0 to 39	0	GFSK	1

Antenna Port Conducted Measurement:

- This item includes all test value of each mode, but only includes spectrum plot of worst value of each mode.
- Pre-Scan has been conducted to determine the worst-case mode from all possible combinations between available modulations, data rates and antenna ports (if EUT with antenna diversity architecture).
- Following channel(s) was (were) selected for the final test as listed below.

AVAILABLE CHANNEL	TESTED CHANNEL	MODULATION TYPE	DATA RATE (Mbps)
0 to 39	0, 19, 39	GFSK	1

Test Condition:

APPLICABLE TO	ENVIRONMENTAL CONDITIONS	INPUT POWER	TESTED BY
RE≥1G	26deg. C, 69%RH	120Vac, 60Hz	Weiwei Lo
RE<1G	25deg. C, 70%RH	120Vac, 60Hz	Tim Ho
PLC	25deg. C, 64%RH	120Vac, 60Hz	JyunChun.Lin
APCM	25deg. C, 60%RH	120Vac, 60Hz	Robert Cheng

3.3 Duty Cycle of Test Signal

Duty cycle of test signal is < 98 %, duty factor shall be considered.

For BT_LE-GFSK:

Duty cycle = 0.415 ms/0.625 ms = 0.664, Duty factor = 10 * log(1/0.664) = 1.8

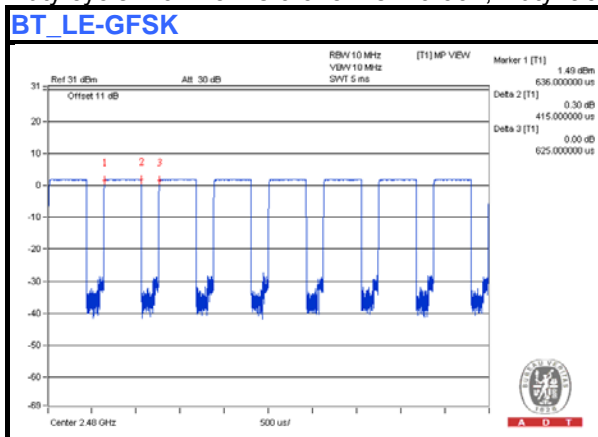

3.4 Description of Support Units

The EUT has been tested as an independent unit together with other necessary accessories or support units. The following support units or accessories were used to form a representative test configuration during the tests.

ID	Product	Brand	Model No.	Serial No.	FCC ID	Remarks
A.	USB Adapter	Nicelink	US-T12B(W)	NA	NA	Provided by Lab
B.	USB Test Tool	NA	NA	NA	NA	Supplied by client

Note:

1. All power cords of the above support units are non-shielded (1.8m).

ID	Descriptions	Qty.	Length (m)	Shielding (Yes/No)	Cores (Qty.)	Remarks
1.	USB to Mini USB cable	1	1	No	0	Accessory
2.	UART to USB connector	1	0.1	No	0	Supplied by client

3.4.1 Configuration of System under Test

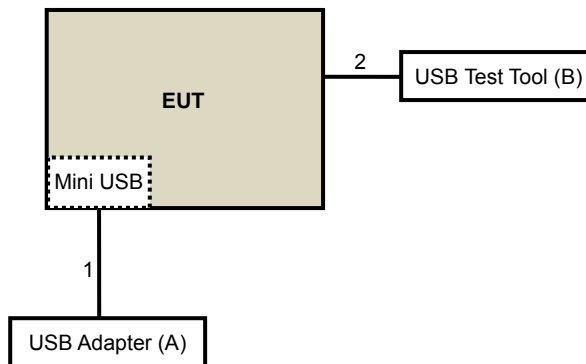

3.5 General Description of Applied Standards

The EUT is a RF Product. According to the specifications of the manufacturer, it must comply with the requirements of the following standards:

FCC Part 15, Subpart C (15.247)
558074 D01 DTS Meas Guidance v03r02

ANSI C63.10: 2009

All test items have been performed and recorded as per the above standards.

Note: The EUT has been verified to comply with the requirements of FCC Part 15, Subpart B, Class B (DoC). The test report has been issued separately.

4 Test Types and Results

4.1 Radiated Emission and Bandedge Measurement

4.1.1 Limits of Radiated Emission and Bandedge Measurement

Radiated emissions which fall in the restricted bands must comply with the radiated emission limits specified as below table. Other emissions shall be at least 20dB below the highest level of the desired power:

Frequencies (MHz)	Field Strength (microvolts/meter)	Measurement Distance (meters)
0.009 ~ 0.490	2400/F(kHz)	300
0.490 ~ 1.705	24000/F(kHz)	30
1.705 ~ 30.0	30	30
30 ~ 88	100	3
88 ~ 216	150	3
216 ~ 960	200	3
Above 960	500	3

NOTE:

1. The lower limit shall apply at the transition frequencies.
2. Emission level (dBuV/m) = 20 log Emission level (uV/m).
3. For frequencies above 1000MHz, the field strength limits are based on average detector, however, the peak field strength of any emission shall not exceed the maximum permitted average limits, specified above by more than 20dB under any condition of modulation.

4.1.2 Test Instruments

Below 1GHz test

DESCRIPTION & MANUFACTURER	MODEL NO.	SERIAL NO.	CALIBRATED DATE	CALIBRATED UNTIL
Test Receiver Agilent	N9038A	MY50010156	Aug. 11, 2014	Aug. 10, 2015
Pre-Amplifier Mini-Circuits	ZFL-1000VH2 B	AMP-ZFL-04	Nov. 12, 2014	Nov. 11, 2015
Trilog Broadband Antenna SCHWARZBECK	VULB 9168	9168-361	Feb. 09, 2015	Feb. 08, 2016
RF Cable	8D-FB	CHHCAB-001-1 CHHCAB-001-2	Oct. 05, 2014	Oct. 04, 2015
	RF-141	CHHCAB-004	Oct. 05, 2014	Oct. 04, 2015
Software	ADT_Radiated _V8.7.07	NA	NA	NA
Antenna Tower & Turn Table CT	NA	NA	NA	NA

Note:

1. The calibration interval of the above test instruments is 12 months and the calibrations are traceable to NML/ROC and NIST/USA.
2. The test was performed in 966 Chamber No. H.
3. The FCC Site Registration No. is 797305.
4. The CANADA Site Registration No. is IC 7450H-3.
5. Tested Date: June 12, 2015

Above 1GHz test

DESCRIPTION & MANUFACTURER	MODEL NO.	SERIAL NO.	CALIBRATED DATE	CALIBRATED UNTIL
Test Receiver Agilent	N9038A	MY51210105	July 21, 2014	July 20, 2015
Horn_Antenna AISI	AIH.8018	000032009111 0	Feb. 09, 2015	Feb. 08, 2016
Pre-Amplifier Agilent	8449B	3008A02578	June 24, 2014	June 23, 2015
RF Cable	NA	131205 131216 131217 SNMY23684/ 4	Jan. 16, 2015	Jan. 15, 2016
Spectrum Analyzer R&S	FSV40	100964	July 05, 2014	July 04, 2015
Pre-Amplifier SPACEK LABS	SLKKa-48-6	9K16	Dec. 12, 2014	Dec. 11, 2015
Horn_Antenna SCHWARZBECK	BBHA 9170	9170-424	Feb. 05, 2015	Feb. 04, 2016
RF Cable	NA	329751/4 RF104-204	Dec. 11, 2014	Dec. 10, 2015
Software	ADT_Radiated _V8.7.07	NA	NA	NA
Antenna Tower & Turn Table CT	NA	NA	NA	NA
Spectrum Analyzer R&S	FSP 40	100060	May 08, 2015	May 07, 2016
Power meter Anritsu	ML2495A	1014008	Apr. 28, 2015	Apr. 27, 2016
Power sensor Anritsu	MA2411B	0917122	Apr. 28, 2015	Apr. 27, 2016

Note:

1. The calibration interval of the above test instruments is 12 months and the calibrations are traceable to NML/ROC and NIST/USA.
2. The test was performed in 966 Chamber No. G.
3. The FCC Site Registration No. is 966073.
4. The VCCI Site Registration No. is G-137.
5. The CANADA Site Registration No. is IC 7450H-2.
6. Tested Date: June 18, 2015

4.1.3 Test Procedures

- a. The EUT was placed on the top of a rotating table 0.8 meters (for below 1GHz) / 1.5 meters (for above 1GHz) above the ground at 3 meter chamber room for test. The table was rotated 360 degrees to determine the position of the highest radiation.
- b. The EUT was set 3 meters away from the interference-receiving antenna, which was mounted on the top of a variable-height antenna tower.
- c. The height of antenna is varied from one meter to four meters above the ground to determine the maximum value of the field strength. Both horizontal and vertical polarizations of the antenna are set to make the measurement.
- d. For each suspected emission, the EUT was arranged to its worst case and then the antenna was tuned to heights from 1 meter to 4 meters and the rotatable table was turned from 0 degrees to 360 degrees to find the maximum reading.
- e. The test-receiver system was set to quasi-peak detect function and specified bandwidth with maximum hold mode when the test frequency is below 1 GHz.
- f. The test-receiver system was set to peak and average detect function and specified bandwidth with maximum hold mode when the test frequency is above 1 GHz. If the peak reading value also meets average limit, measurement with the average detector is unnecessary.

Note:

1. The resolution bandwidth and video bandwidth of test receiver/spectrum analyzer is 120kHz for Quasi-peak detection (QP) at frequency below 1GHz.
2. The resolution bandwidth of test receiver/spectrum analyzer is 1 MHz and the video bandwidth is 3 MHz for Peak detection (PK) at frequency above 1GHz.
3. The resolution bandwidth of test receiver/spectrum analyzer is 1MHz and the video bandwidth is 3MHz for RMS Average (Duty cycle < 98%) for Average detection (AV) at frequency above 1GHz, then the measurement results was added to a correction factor ($10 \log(1/\text{duty cycle})$).
4. The resolution bandwidth of test receiver/spectrum analyzer is 1MHz and the video bandwidth is 10Hz (Duty cycle $\geq 98\%$) for Average detection (AV) at frequency above 1GHz.
5. All modes of operation were investigated and the worst-case emissions are reported.

4.1.4 Deviation from Test Standard

No deviation.

4.1.5 Test Setup

<Frequency Range below 1GHz>

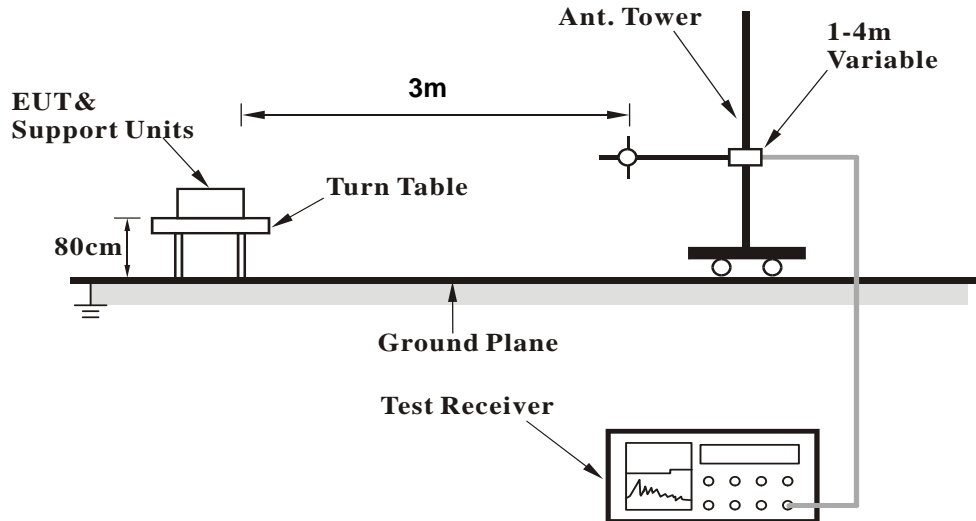

<Frequency Range above 1GHz>

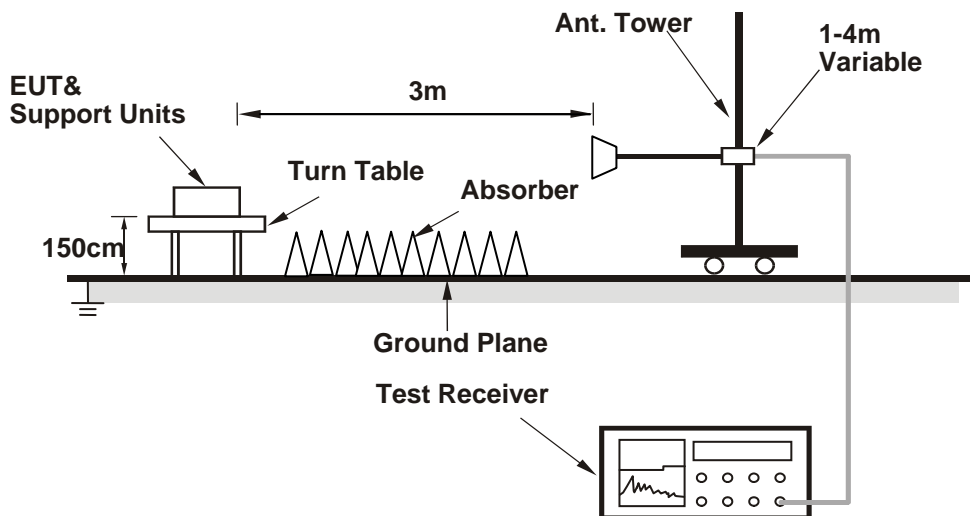

For the actual test configuration, please refer to the attached file (Test Setup Photo).

4.1.6 EUT Operating Conditions

1. Placed the EUT on testing table.
2. Controlling software (nRFGo Studio) has been activated to set the EUT under transmission/receiving condition continuously.

4.1.7 Test Results

Above 1GHz Data :

CHANNEL	TX Channel 0	DETECTOR FUNCTION	Peak (PK)
FREQUENCY RANGE	1GHz ~ 25GHz		Average (AV)

ANTENNA POLARITY & TEST DISTANCE: HORIZONTAL AT 3 M

NO.	FREQ. (MHz)	EMISSION LEVEL (dBuV/m)	LIMIT (dBuV/m)	MARGIN (dB)	ANTENNA HEIGHT (m)	TABLE ANGLE (Degree)	RAW VALUE (dBuV)	CORRECTION FACTOR (dB/m)
1	2390.00	55.6 PK	74.0	-18.4	1.08 H	194	57.03	-1.43
2	2390.00	39.7 AV	54.0	-14.3	1.08 H	194	41.13	-1.43
3	*2402.00	100.9 PK			1.08 H	202	102.30	-1.40
4	*2402.00	99.7 AV			1.08 H	202	101.10	-1.40
5	4804.00	49.7 PK	74.0	-24.3	1.79 H	206	42.69	7.01
6	4804.00	40.1 AV	54.0	-13.9	1.79 H	206	33.09	7.01

ANTENNA POLARITY & TEST DISTANCE: VERTICAL AT 3 M

NO.	FREQ. (MHz)	EMISSION LEVEL (dBuV/m)	LIMIT (dBuV/m)	MARGIN (dB)	ANTENNA HEIGHT (m)	TABLE ANGLE (Degree)	RAW VALUE (dBuV)	CORRECTION FACTOR (dB/m)
1	2390.00	50.7 PK	74.0	-23.3	2.38 V	247	52.13	-1.43
2	2390.00	37.9 AV	54.0	-16.1	2.38 V	247	39.33	-1.43
3	*2402.00	97.3 PK			2.38 V	247	98.70	-1.40
4	*2402.00	95.5 AV			2.38 V	247	96.90	-1.40
5	4804.00	48.7 PK	74.0	-25.3	1.01 V	222	41.69	7.01
6	4804.00	39.5 AV	54.0	-14.5	1.01 V	222	32.49	7.01

REMARKS:

1. Emission Level(dBuV/m) = Raw Value(dBuV) + Correction Factor(dB/m)
2. Correction Factor(dB/m) = Antenna Factor(dB/m) + Cable Factor(dB) – Pre-Amplifier Factor(dB)
3. The other emission levels were very low against the limit.
4. Margin value = Emission Level – Limit value
5. " * ": Fundamental frequency.

CHANNEL	TX Channel 19	DETECTOR FUNCTION	Peak (PK)
FREQUENCY RANGE	1GHz ~ 25GHz		Average (AV)

ANTENNA POLARITY & TEST DISTANCE: HORIZONTAL AT 3 M

NO.	FREQ. (MHz)	EMISSION LEVEL (dBuV/m)	LIMIT (dBuV/m)	MARGIN (dB)	ANTENNA HEIGHT (m)	TABLE ANGLE (Degree)	RAW VALUE (dBuV)	CORRECTION FACTOR (dB/m)
1	*2440.00	100.6 PK			1.06 H	222	101.92	-1.32
2	*2440.00	99.5 AV			1.06 H	222	100.82	-1.32
3	4842.00	49.5 PK	74.0	-24.5	1.85 H	222	42.36	7.14
4	4842.00	40.0 AV	54.0	-14.0	1.85 H	222	32.86	7.14
5	7263.00	57.4 PK	74.0	-16.6	1.85 H	222	42.82	14.58
6	7263.00	47.9 AV	54.0	-6.1	1.85 H	222	33.32	14.58

ANTENNA POLARITY & TEST DISTANCE: VERTICAL AT 3 M

NO.	FREQ. (MHz)	EMISSION LEVEL (dBuV/m)	LIMIT (dBuV/m)	MARGIN (dB)	ANTENNA HEIGHT (m)	TABLE ANGLE (Degree)	RAW VALUE (dBuV)	CORRECTION FACTOR (dB/m)
1	*2440.00	97.1 PK			2.30 V	250	98.42	-1.32
2	*2440.00	95.2 AV			2.30 V	250	96.52	-1.32
3	4842.00	49.2 PK	74.0	-24.8	1.00 V	220	42.06	7.14
4	4842.00	39.7 AV	54.0	-14.3	1.00 V	220	32.56	7.14
5	7263.00	57.9 PK	74.0	-16.1	1.00 V	220	43.32	14.58
6	7263.00	47.7 AV	54.0	-6.3	1.00 V	220	33.12	14.58

REMARKS:

1. Emission Level(dBuV/m) = Raw Value(dBuV) + Correction Factor(dB/m)
2. Correction Factor(dB/m) = Antenna Factor(dB/m) + Cable Factor(dB) – Pre-Amplifier Factor(dB)
3. The other emission levels were very low against the limit.
4. Margin value = Emission Level – Limit value
5. " * ": Fundamental frequency.

CHANNEL	TX Channel 39	DETECTOR FUNCTION	Peak (PK)
FREQUENCY RANGE	1GHz ~ 25GHz		Average (AV)

ANTENNA POLARITY & TEST DISTANCE: HORIZONTAL AT 3 M

NO.	FREQ. (MHz)	EMISSION LEVEL (dBuV/m)	LIMIT (dBuV/m)	MARGIN (dB)	ANTENNA HEIGHT (m)	TABLE ANGLE (Degree)	RAW VALUE (dBuV)	CORRECTION FACTOR (dB/m)
1	*2480.00	100.4 PK			1.10 H	210	101.61	-1.21
2	*2480.00	99.3 AV			1.10 H	210	100.51	-1.21
3	2483.50	55.2 PK	74.0	-18.8	1.10 H	210	56.41	-1.21
4	2483.50	39.5 AV	54.0	-14.5	1.10 H	210	40.71	-1.21
5	4882.00	49.5 PK	74.0	-24.5	1.81 H	215	42.23	7.27
6	4882.00	39.8 AV	54.0	-14.2	1.81 H	215	32.53	7.27
7	7323.00	57.8 PK	74.0	-16.2	1.81 H	224	43.32	14.48
8	7323.00	48.1 AV	54.0	-5.9	1.81 H	224	33.62	14.48

ANTENNA POLARITY & TEST DISTANCE: VERTICAL AT 3 M

NO.	FREQ. (MHz)	EMISSION LEVEL (dBuV/m)	LIMIT (dBuV/m)	MARGIN (dB)	ANTENNA HEIGHT (m)	TABLE ANGLE (Degree)	RAW VALUE (dBuV)	CORRECTION FACTOR (dB/m)
1	*2480.00	96.9 PK			2.33 V	211	98.11	-1.21
2	*2480.00	94.8 AV			2.33 V	211	96.01	-1.21
3	2483.50	49.7 PK	74.0	-24.3	2.33 V	211	50.91	-1.21
4	2483.50	37.6 AV	54.0	-16.4	2.33 V	211	38.81	-1.21
5	4882.00	49.0 PK	74.0	-25.0	1.04 V	225	41.73	7.27
6	4882.00	39.5 AV	54.0	-14.5	1.04 V	225	32.23	7.27
7	7323.00	57.5 PK	74.0	-16.5	1.00 V	212	43.02	14.48
8	7323.00	47.5 AV	54.0	-6.5	1.00 V	212	33.02	14.48

REMARKS:

1. Emission Level(dBuV/m) = Raw Value(dBuV) + Correction Factor(dB/m)
2. Correction Factor(dB/m) = Antenna Factor(dB/m) + Cable Factor(dB) – Pre-Amplifier Factor(dB)
3. The other emission levels were very low against the limit.
4. Margin value = Emission Level – Limit value
5. " * ": Fundamental frequency.

Below 1GHz Data:

CHANNEL	TX Channel 0	DETECTOR FUNCTION	Quasi-Peak (QP)
FREQUENCY RANGE	30MHz ~ 1GHz		

ANTENNA POLARITY & TEST DISTANCE: HORIZONTAL AT 3 M

NO.	FREQ. (MHz)	EMISSION LEVEL (dBuV/m)	LIMIT (dBuV/m)	MARGIN (dB)	ANTENNA HEIGHT (m)	TABLE ANGLE (Degree)	RAW VALUE (dBuV)	CORRECTION FACTOR (dB/m)
1	76.32	19.8 QP	40.0	-20.2	1.00 H	153	36.55	-16.74
2	128.02	17.9 QP	43.5	-25.6	1.00 H	296	32.16	-14.22
3	183.07	20.2 QP	43.5	-23.3	1.00 H	309	34.99	-14.82
4	486.77	20.3 QP	46.0	-25.7	1.00 H	104	27.74	-7.48
5	610.59	21.1 QP	46.0	-24.9	1.00 H	93	25.57	-4.43
6	932.78	25.9 QP	46.0	-20.1	1.00 H	289	24.93	0.94

ANTENNA POLARITY & TEST DISTANCE: VERTICAL AT 3 M

NO.	FREQ. (MHz)	EMISSION LEVEL (dBuV/m)	LIMIT (dBuV/m)	MARGIN (dB)	ANTENNA HEIGHT (m)	TABLE ANGLE (Degree)	RAW VALUE (dBuV)	CORRECTION FACTOR (dB/m)
1	31.12	24.3 QP	40.0	-15.7	1.50 V	1	39.15	-14.88
2	76.61	24.7 QP	40.0	-15.3	2.00 V	16	41.57	-16.87
3	120.02	22.7 QP	43.5	-20.8	1.00 V	18	37.86	-15.18
4	183.07	17.6 QP	43.5	-25.9	2.00 V	171	32.42	-14.82
5	257.71	15.6 QP	46.0	-30.4	1.50 V	1	29.34	-13.70
6	956.98	31.2 QP	46.0	-14.8	2.00 V	92	30.07	1.16

REMARKS:

1. Emission Level(dBuV/m) = Raw Value(dBuV) + Correction Factor(dB/m)
2. Correction Factor(dB/m) = Antenna Factor(dB/m) + Cable Factor(dB) – Pre-Amplifier Factor(dB)
3. The other emission levels were very low against the limit.
4. Margin value = Emission Level – Limit value

4.2 Conducted Emission Measurement

4.2.1 Limits of Conducted Emission Measurement

Frequency (MHz)	Conducted Limit (dBuV)	
	Quasi-peak	Average
0.15 - 0.5	66 - 56	56 - 46
0.50 - 5.0	56	46
5.0 - 30.0	60	50

Note: 1. The lower limit shall apply at the transition frequencies.

2. The limit decreases in line with the logarithm of the frequency in the range of 0.15 to 0.50MHz.

4.2.2 Test Instruments

DESCRIPTION & MANUFACTURER	MODEL NO.	SERIAL NO.	CALIBRATED DATE	CALIBRATED UNTIL
Test Receiver R&S	ESCS 30	100375	May 06, 2015	May 05, 2016
Line-Impedance Stabilization Network (for EUT) SCHWARZBECK	NSLK-8127	8127-522	Sep. 15, 2014	Sep. 14, 2015
Line-Impedance Stabilization Network (for Peripheral) R&S	ENV216	100071	Nov. 10, 2014	Nov. 09, 2015
RF Cable	5D-FB	COCCAB-001	Mar. 09, 2015	Mar. 08, 2016
50 ohms Terminator	N/A	EMC-03	Sep. 22, 2014	Sep. 21, 2015
50 ohms Terminator	N/A	EMC-02	Sep. 30, 2014	Sep. 29, 2015
Software BVADT	BVADT_Cond_ V7.3.7.3	NA	NA	NA

Note:

1. The calibration interval of the above test instruments are 12 months and the calibrations are traceable to NML/ROC and NIST/USA.
2. The test was performed in Shielded Room No. C.
3. The VCCI Con C Registration No. is C-3611.
4. Tested Date: June 15, 2015

4.2.3 Test Procedures

- a. The EUT was placed 0.4 meters from the conducting wall of the shielded room with EUT being connected to the power mains through a line impedance stabilization network (LISN). Other support units were connected to the power mains through another LISN. The two LISNs provide 50 ohm/ 50uH of coupling impedance for the measuring instrument.
- b. Both lines of the power mains connected to the EUT were checked for maximum conducted interference.
- c. The frequency range from 150kHz to 30MHz was searched. Emission levels under (Limit - 20dB) was not recorded.

NOTE: The resolution bandwidth and video bandwidth of test receiver is 9kHz for quasi-peak detection (QP) and average detection (AV) at frequency 0.15MHz-30MHz.

4.2.4 Deviation from Test Standard

No deviation.

4.2.5 Test Setup

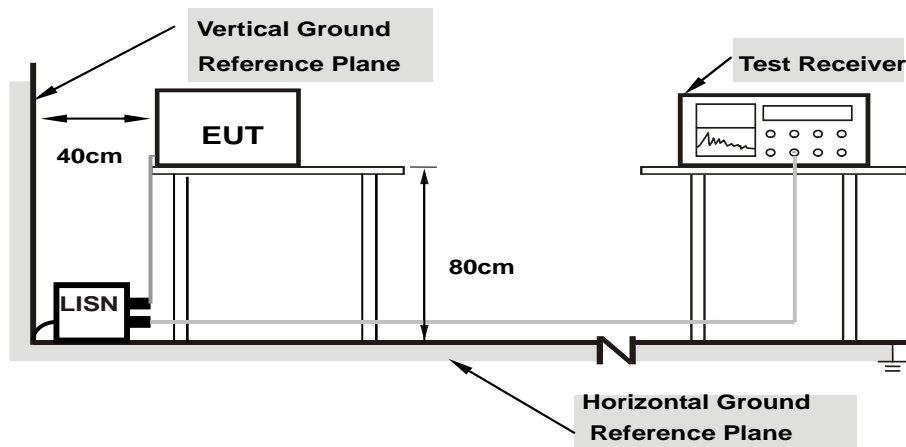

Note: 1.Support units were connected to second LISN.

For the actual test configuration, please refer to the attached file (Test Setup Photo).

4.2.6 EUT Operating Conditions

Same as 4.1.6.

4.2.7 Test Results

Phase	Line (L)	Detector Function	Quasi-Peak (QP) / Average (AV)
-------	----------	-------------------	--------------------------------

No	Freq. [MHz]	Corr.	Reading Value		Emission Level		Limit		Margin	
		Factor	[dB (uV)]		[dB (uV)]		[dB (uV)]		(dB)	
	(dB)	Q.P.	AV.	Q.P.	AV.	Q.P.	AV.	Q.P.	AV.	
1	0.15000	0.14	36.56	22.26	36.70	22.40	66.00	56.00	-29.30	-33.60
2	0.19687	0.15	30.95	19.79	31.10	19.94	63.74	53.74	-32.64	-33.80
3	0.34141	0.16	31.99	20.98	32.15	21.14	59.17	49.17	-27.01	-28.02
4	4.53516	0.41	18.78	10.97	19.19	11.38	56.00	46.00	-36.81	-34.62
5	12.68359	0.84	22.50	11.96	23.34	12.80	60.00	50.00	-36.66	-37.20
6	28.43359	1.42	21.59	11.93	23.01	13.35	60.00	50.00	-36.99	-36.65

REMARKS:

1. Q.P. and AV. are abbreviations of quasi-peak and average individually.
2. The emission levels of other frequencies were very low against the limit.
3. Margin value = Emission level - Limit value
4. Correction factor = Insertion loss + Cable loss
5. Emission Level = Correction Factor + Reading Value.

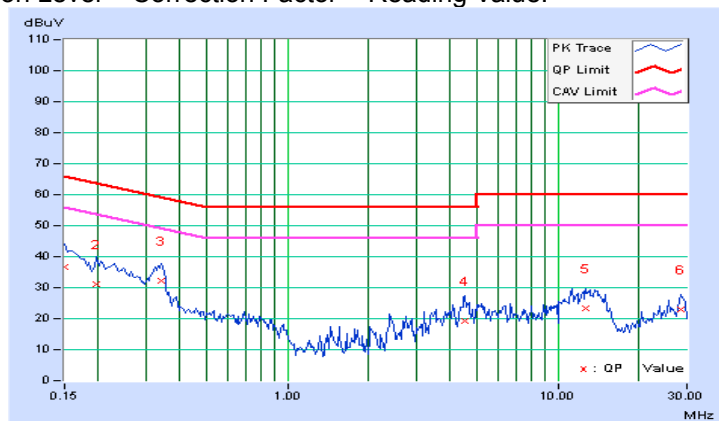

Phase	Neutral (N)	Detector Function	Quasi-Peak (QP) / Average (AV)
-------	-------------	-------------------	--------------------------------

No	Freq. [MHz]	Corr.	Reading Value		Emission Level		Limit		Margin	
		Factor	[dB (uV)]		[dB (uV)]		[dB (uV)]		(dB)	
	(dB)	Q.P.	AV.	Q.P.	AV.	Q.P.	AV.	Q.P.	AV.	
1	0.16172	0.14	33.39	14.55	33.53	14.69	65.38	55.38	-31.84	-40.68
2	0.21250	0.15	29.67	13.93	29.82	14.08	63.11	53.11	-33.28	-39.02
3	0.33750	0.18	31.06	19.26	31.24	19.44	59.26	49.26	-28.03	-29.83
4	0.79453	0.22	17.17	2.02	17.39	2.24	56.00	46.00	-38.61	-43.76
5	4.31641	0.44	19.31	2.54	19.75	2.98	56.00	46.00	-36.25	-43.02
6	13.24219	0.93	15.95	3.53	16.88	4.46	60.00	50.00	-43.12	-45.54

REMARKS:

1. Q.P. and AV. are abbreviations of quasi-peak and average individually.
2. The emission levels of other frequencies were very low against the limit.
3. Margin value = Emission level - Limit value
4. Correction factor = Insertion loss + Cable loss
5. Emission Level = Correction Factor + Reading Value.

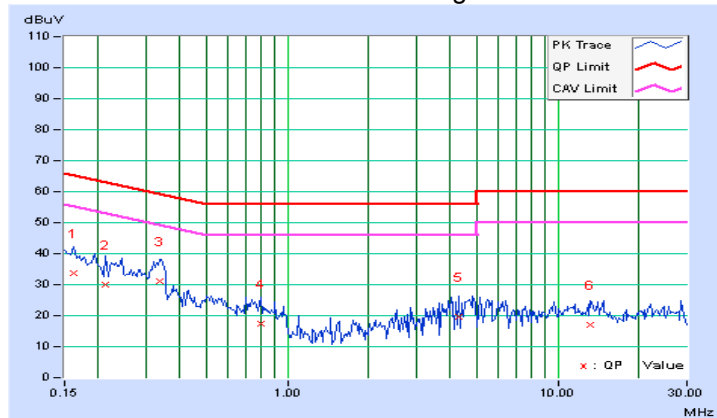

4.3 6dB Bandwidth Measurement

4.3.1 Limits of 6dB Bandwidth Measurement

The minimum of 6dB Bandwidth Measurement is 0.5 MHz.

4.3.2 Test Setup

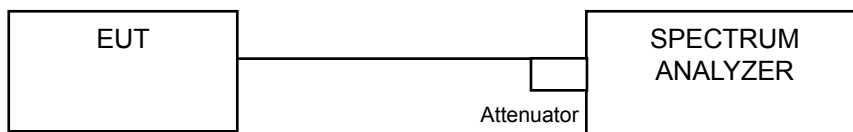

4.3.3 Test Instruments

Refer to section 4.1.2 to get information of above instrument.

4.3.4 Test Procedure

- a. Set resolution bandwidth (RBW) = 100kHz
- b. Set the video bandwidth (VBW) $\geq 3 \times$ RBW, Detector = Peak.
- c. Trace mode = max hold.
- d. Sweep = auto couple.
- e. Measure the maximum width of the emission that is constrained by the frequencies associated with the two amplitude points (upper and lower) that are attenuated by 6 dB relative to the maximum level measured in the fundamental emission

4.3.5 Deviation from Test Standard

No deviation.

4.3.6 EUT Operating Conditions

The software provided by client to enable the EUT under transmission condition continuously at lowest, middle and highest channel frequencies individually.

4.3.7 Test Result

CHANNEL	FREQUENCY (MHz)	6dB BANDWIDTH (MHz)	MINIMUM LIMIT (MHz)	PASS / FAIL
0	2402	0.69	0.5	PASS
19	2440	0.69	0.5	PASS
39	2480	0.69	0.5	PASS

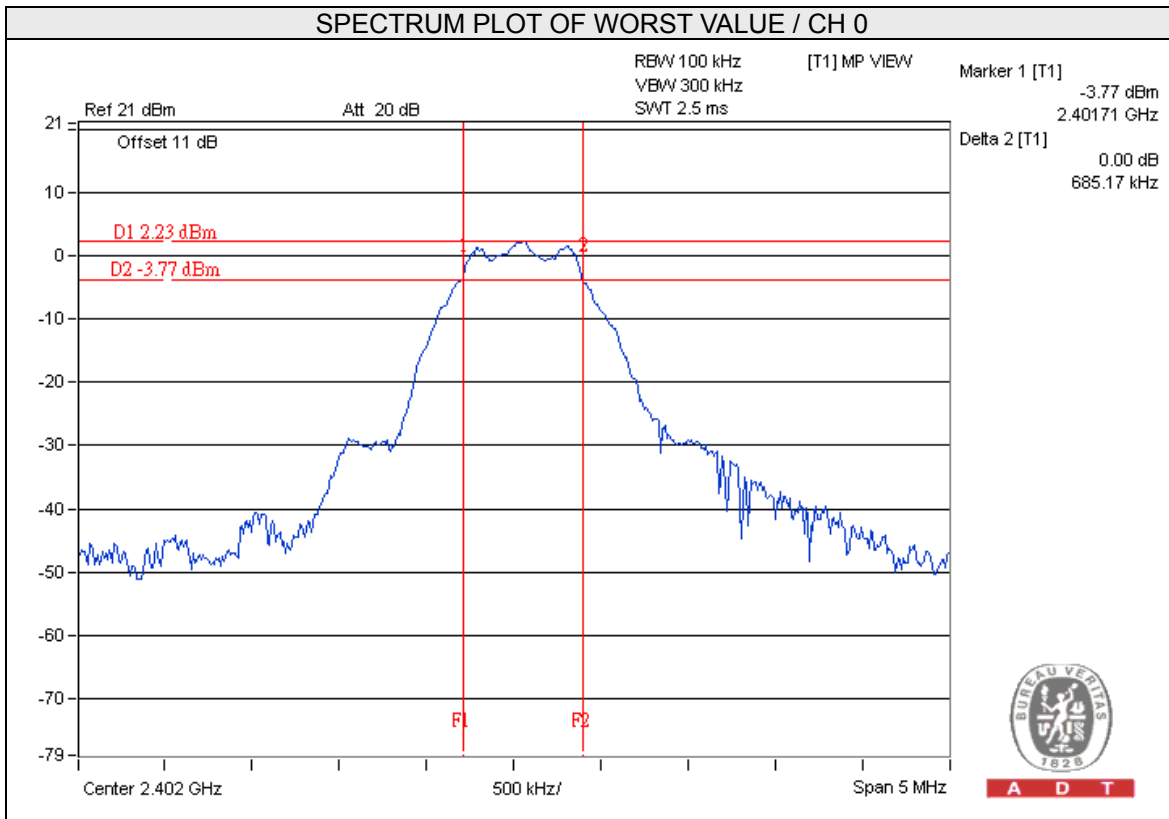

4.4 Conducted Output Power Measurement

4.4.1 Limits of Conducted Output Power Measurement

For systems using digital modulation in the 2400–2483.5 MHz bands: 1 Watt (30dBm)

4.4.2 Test Setup

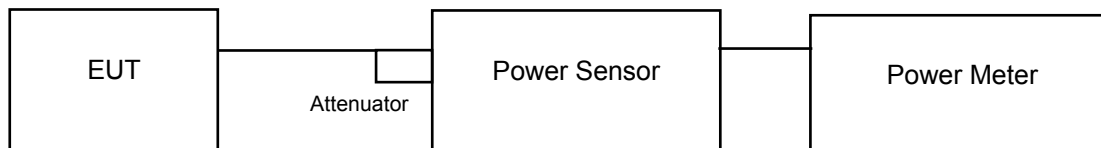

4.4.3 Test Instruments

Refer to section 4.1.2 to get information of above instrument.

4.4.4 Test Procedures

A peak / average power sensor was used on the output port of the EUT. A power meter was used to read the response of the peak / average power sensor. Record the power level.

4.4.5 Deviation from Test Standard

No deviation.

4.4.6 EUT Operating Conditions

Same as Item 4.3.6.

4.4.7 Test Results

For Peak Power

CHANNEL	FREQUENCY (MHz)	PEAK POWER (mW)	PEAK POWER (dBm)	LIMIT (dBm)	PASS/FAIL
0	2402	2.051	3.12	30	PASS
19	2440	2.023	3.06	30	PASS
39	2480	1.914	2.82	30	PASS

For Average Power

Channel	Frequency (MHz)	Average Power (mW)	Average Power (dBm)
0	2402	2.014	3.04
19	2440	1.991	2.99
39	2480	1.832	2.63

4.5 Power Spectral Density Measurement

4.5.1 Limits of Power Spectral Density Measurement

The Maximum of Power Spectral Density Measurement is 8dBm.

4.5.2 Test Setup

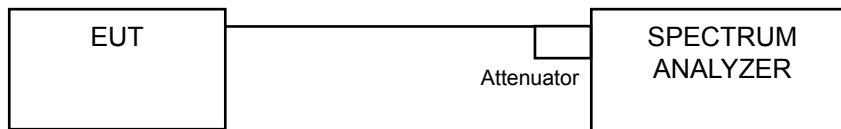

4.5.3 Test Instruments

Refer to section 4.1.2 to get information of above instrument.

4.5.4 Test Procedure

- a. Set analyzer center frequency to DTS channel center frequency.
- b. Set the span to 1.5 times the DTS bandwidth.
- c. Set the RBW to: $3 \text{ kHz} \leq \text{RBW} \leq 100 \text{ kHz}$.
- d. Set the VBW $\geq 3 \times \text{RBW}$.
- e. Detector = peak.
- f. Sweep time = auto couple.
- g. Trace mode = max hold.
- h. Allow trace to fully stabilize.
- i. Use the peak marker function to determine the maximum amplitude level within the RBW.

4.5.5 Deviation from Test Standard

No deviation.

4.5.6 EUT Operating Condition

Same as Item 4.3.6

4.5.7 Test Results

Channel	Freq. (MHz)	PSD (dBm/3kHz)	Limit (dBm/3kHz)	PASS /FAIL
0	2402	-10.07	8	PASS
19	2440	-9.65	8	PASS
39	2480	-9.83	8	PASS

SPECTRUM PLOT OF WORST VALUE / CH 19

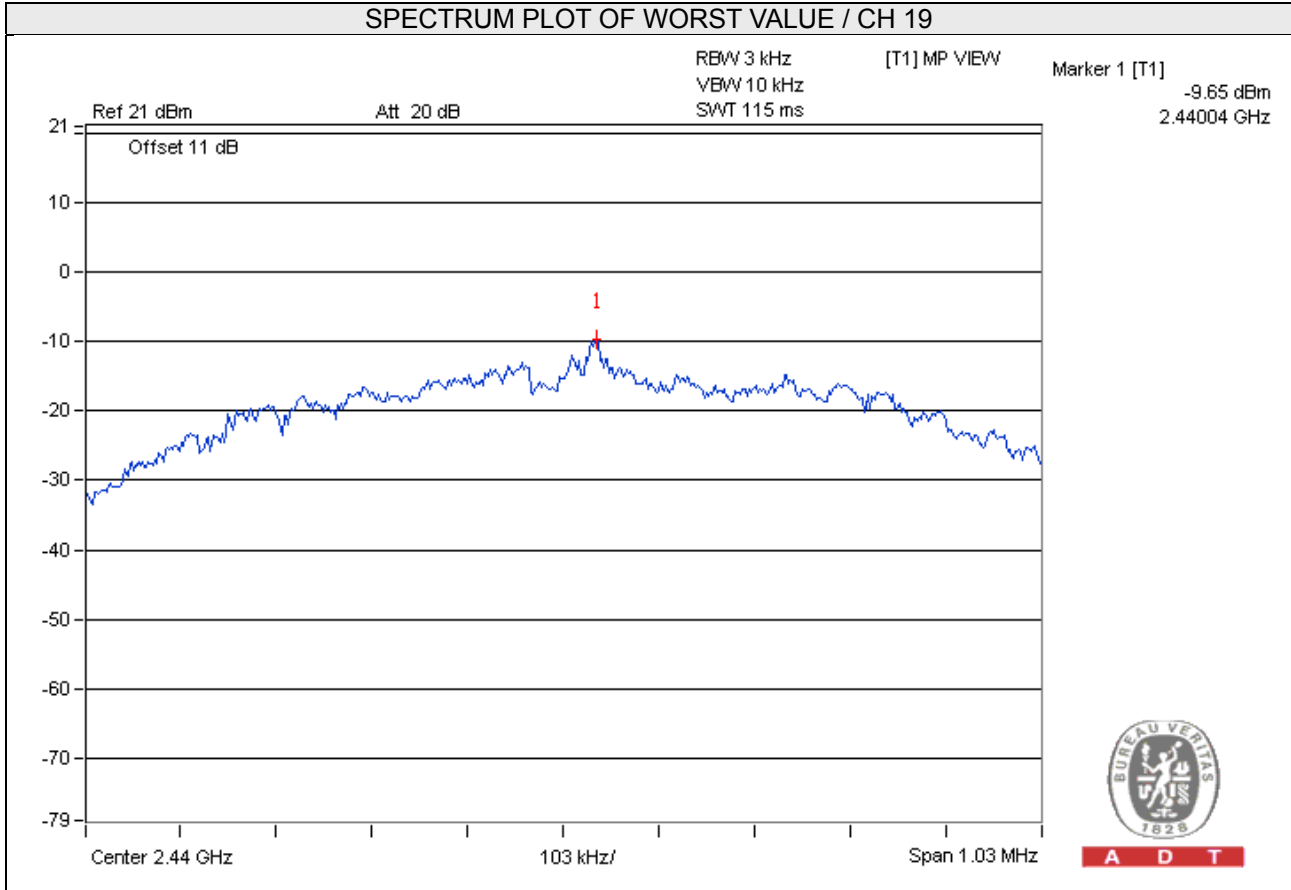

4.6 Conducted Out of Band Emission Measurement

4.6.1 Limits of Conducted Out of Band Emission Measurement

Below 20dB of the highest emission level of operating band (in 100kHz Resolution Bandwidth).

4.6.2 Test Setup

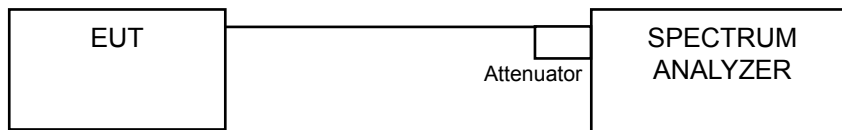

4.6.3 Test Instruments

Refer to section 4.1.2 to get information of above instrument.

4.6.4 Test Procedure

MEASUREMENT PROCEDURE REF

1. Set the RBW = 100 kHz.
2. Set the VBW ≥ 300 kHz.
3. Detector = peak.
4. Sweep time = auto couple.
5. Trace mode = max hold.
6. Allow trace to fully stabilize.
7. Use the peak marker function to determine the maximum power level in any 100 kHz band segment within the fundamental EBW.

MEASUREMENT PROCEDURE OOB

1. Set RBW = 100 kHz.
2. Set VBW ≥ 300 kHz.
3. Detector = peak.
4. Sweep = auto couple.
5. Trace Mode = max hold.
6. Allow trace to fully stabilize.
7. Use the peak marker function to determine the maximum amplitude level.

4.6.5 Deviation from Test Standard

No deviation.

4.6.6 EUT Operating Condition

Same as Item 4.3.6

4.6.7 Test Results

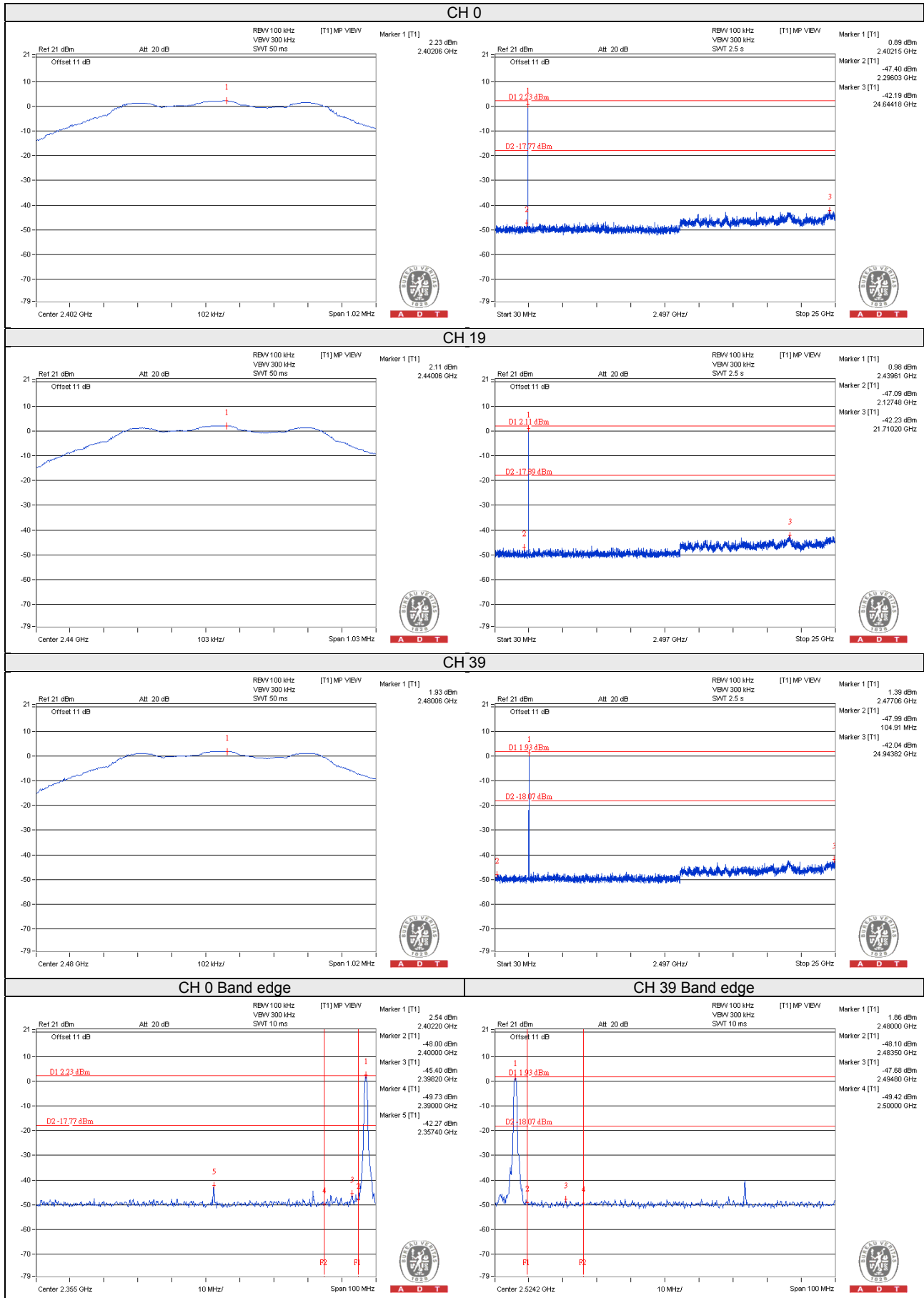

5 Pictures of Test Arrangements

Please refer to the attached file (Test Setup Photo).



Appendix – Information on the Testing Laboratories

We, Bureau Veritas Consumer Products Services (H.K.) Ltd., Taoyuan Branch, were founded in 1988 to provide our best service in EMC, Radio, Telecom and Safety consultation. Our laboratories are accredited and approved according to ISO/IEC 17025.

If you have any comments, please feel free to contact us at the following:

Linko EMC/RF Lab

Tel: 886-2-26052180

Fax: 886-2-26051924

Hsin Chu EMC/RF Lab/Telecom Lab

Tel: 886-3-5935343

Fax: 886-3-5935342

Hwa Ya EMC/RF/Safety

Tel: 886-3-3183232

Fax: 886-3-3270892

Email: service.adt@tw.bureauveritas.com**Web Site:** www.bureauveritas-adt.com

The address and road map of all our labs can be found in our web site also.

--- END ---