

**Product Name: WiFi/Bluetooth Chip Antenna – CW201**

**Part Number: H2U34C1H1B0100**

**Features:**

- Supporting WiFi/Bluetooth, covering 2400 to 2484 MHz
- Surface Mount
- Dimensions: 2.0 x 1.2 x 0.6 mm
- High performance, small size.
- RoHS & REACH & HF Compliant
- AEC-Q200 Compliant

**Applications:**

- ISM 2.4 GHz applications
- ZigBee/BLE applications
- Bluetooth earphone systems
- Hand-held devices when WiFi / Bluetooth functions are needed, e.g., Smart phones
- IEEE802.11 b/g/n

# WiFi/Bluetooth Chip Antenna

**MODEL: CW201**

Version: A

## I. Specifications:

Items	Specifications
<b>Frequencies (MHz)</b>	2400~2484
<b>Return loss (dB)</b>	<-10
<b>Efficiency (%)</b>	63 Max.
<b>Average Gain (dB)</b>	-2.0 Max.
<b>Peak Gain (dBi)</b>	2.1 Max.
<b>Test Condition</b>	40 x 20 mm <sup>2</sup> (Evaluation board)
<b>Impedance (Ω)</b>	50
<b>Polarization</b>	Linear Polarization

Mechanical Specifications	
<b>Dimensions (mm)</b>	2.0(L) x 1.2 (W) x 0.6 (H)
<b>Material</b>	Ceramic
<b>Termination</b>	Ag (environmental Pb free)
Environmental Conditions	
<b>Operation &amp; Storage Temperature (°C)</b>	-40 ~ +85
<b>Storage Temperature (°C) (Antenna with packing sealed)</b>	-5 ~ +40
<b>Relative Humidity</b>	10 ~ 70 %

© Unictron Technologies Corp.  
All specifications subject to change without notice.

## II. Layout Guide:

### Solder Land Pattern:

The solder land pattern (gold marking areas) is shown below. Recommendation on matching circuit will be provided according to customer's installation conditions.

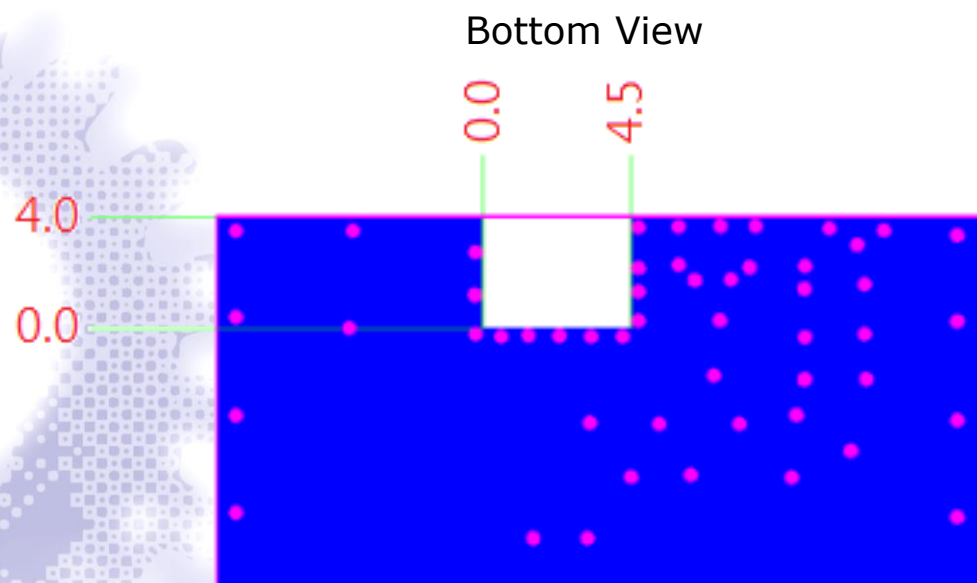
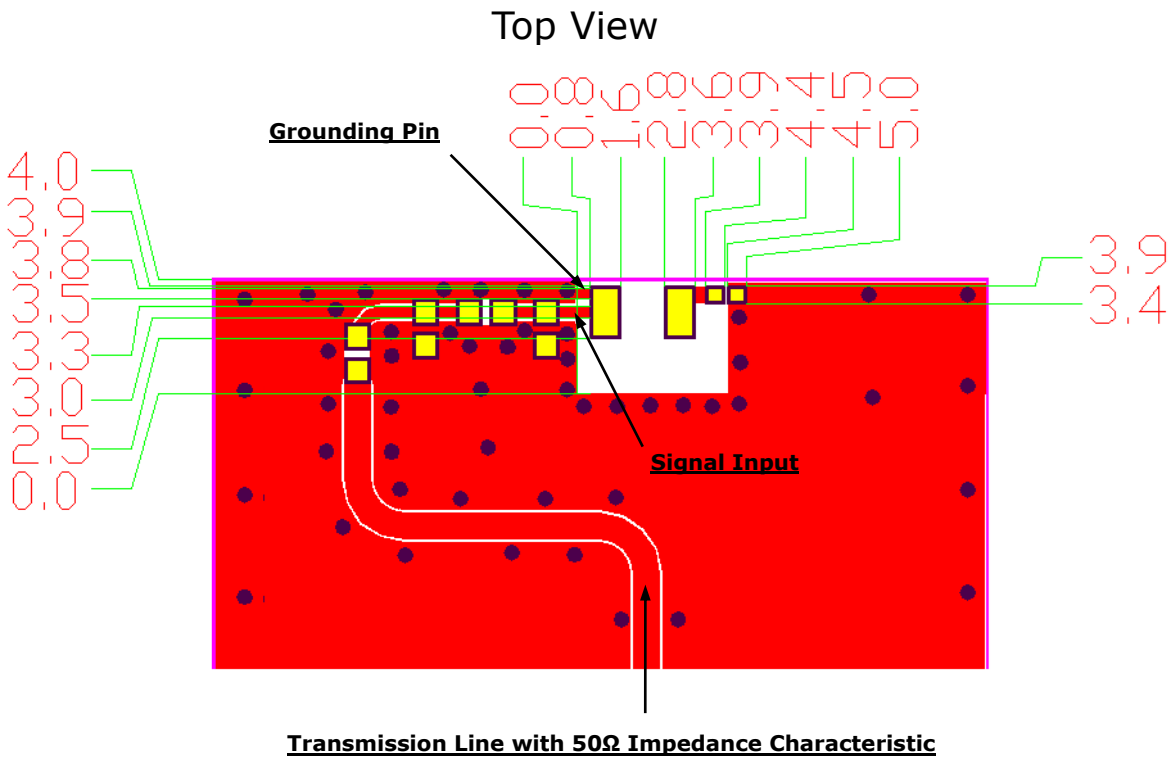

© Unictron Technologies Corp.  
All specifications subject to change without notice.

### III. Mechanical Dimensions:

#### a) Antenna Dimensions

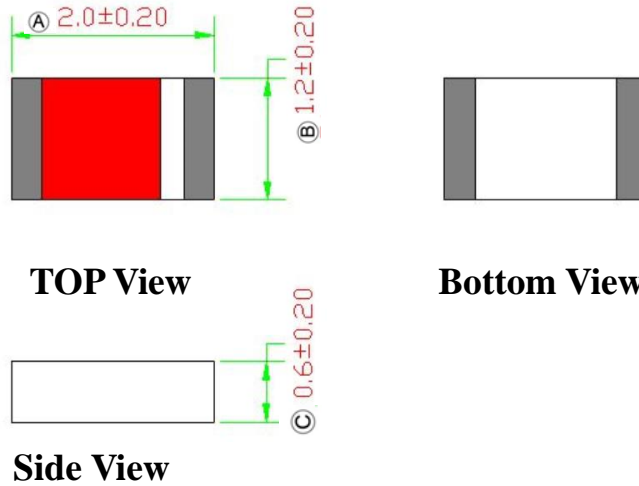

Unit: mm

#### b) PIN Definition

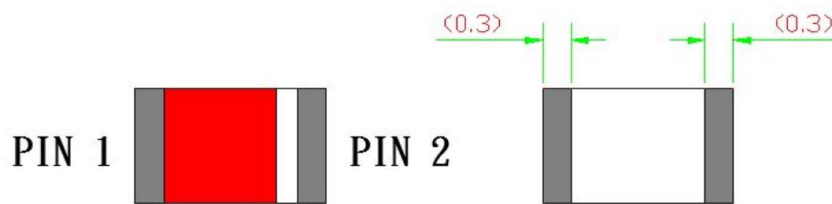

Unit: mm

PIN	1	2
Soldering Pad	Signal Input	Tuning/Signal Output

© Unictron Technologies Corp.  
 All specifications subject to change without notice.

c) Test Board with Antenna

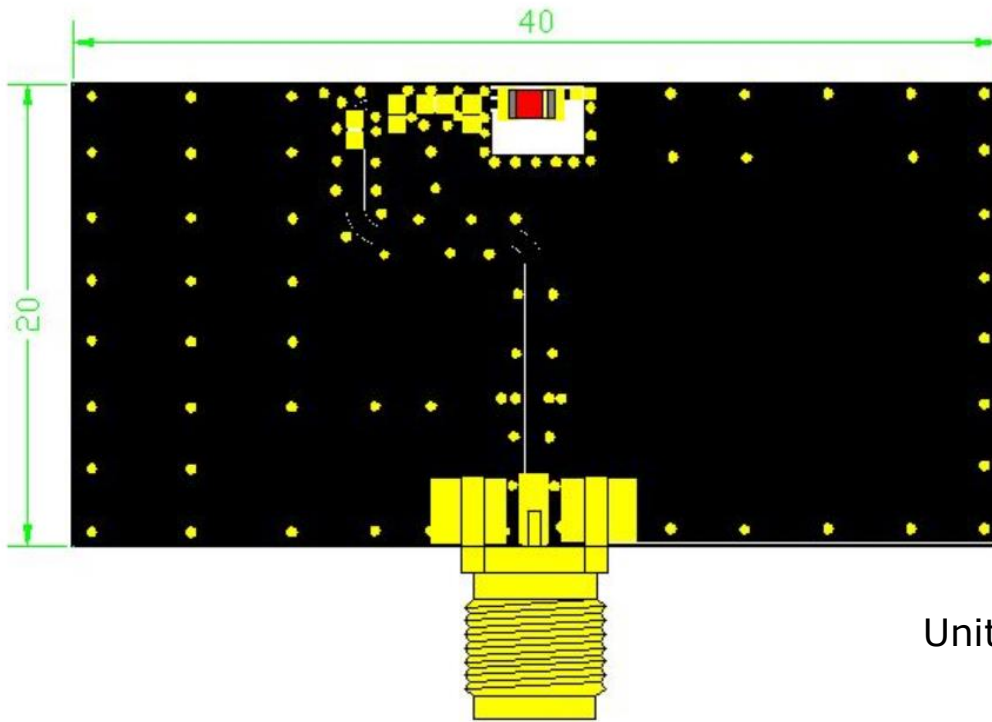

© Unictron Technologies Corp.  
All specifications subject to change without notice.

## IV. Properties:

**a) Return loss (dB)**

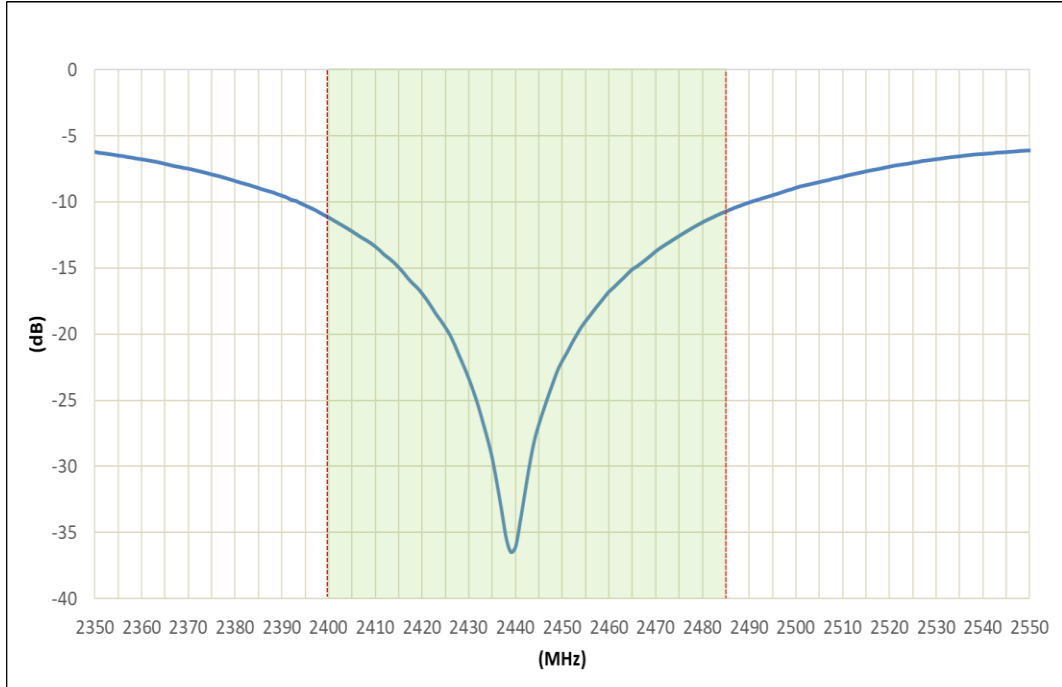

**b) Efficiency (%)**

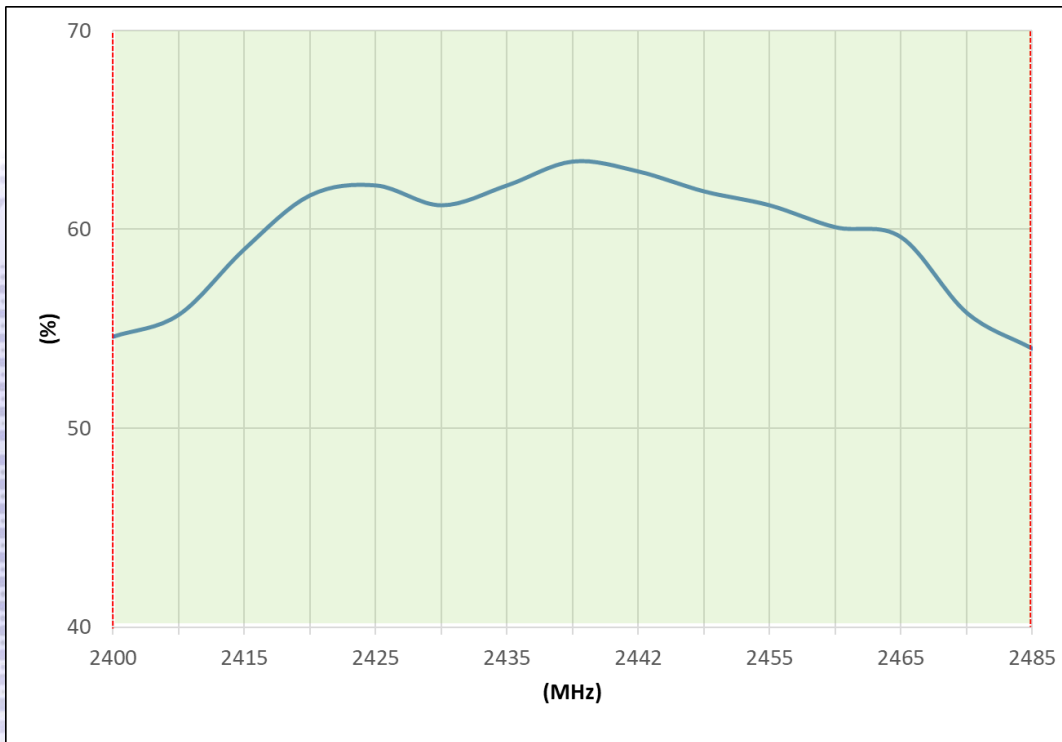

© Unictron Technologies Corp.  
All specifications subject to change without notice.

**c) Average Gain (dB)**

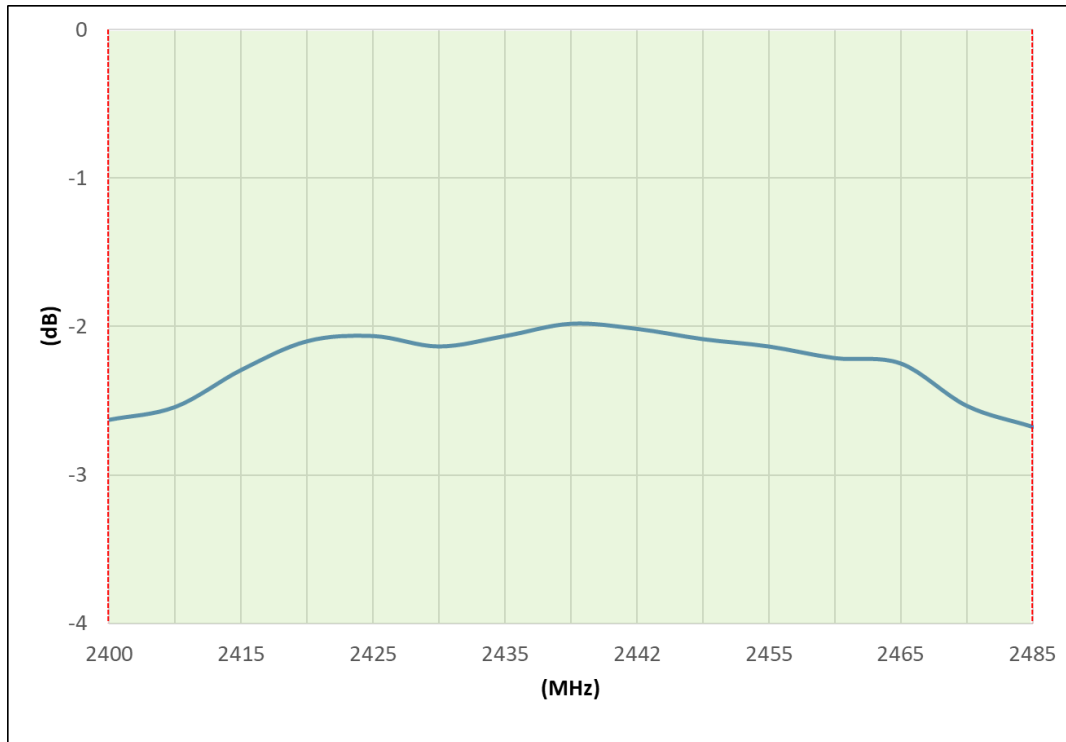

© Unictron Technologies Corp.  
All specifications subject to change without notice.

**d) Peak Gain (dBi)**

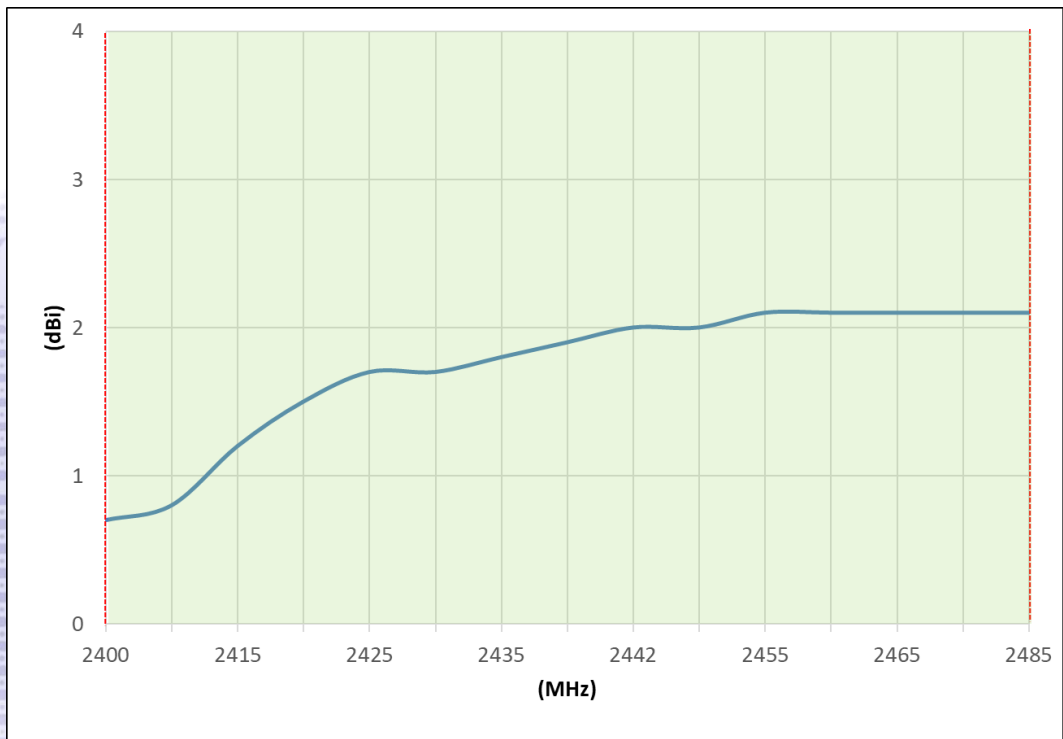

## V. Antenna Radiation Pattern Measurement:

The antenna radiation patterns are measured in Unictron's 3D Anechoic Chamber. The measurement setup is as show below.

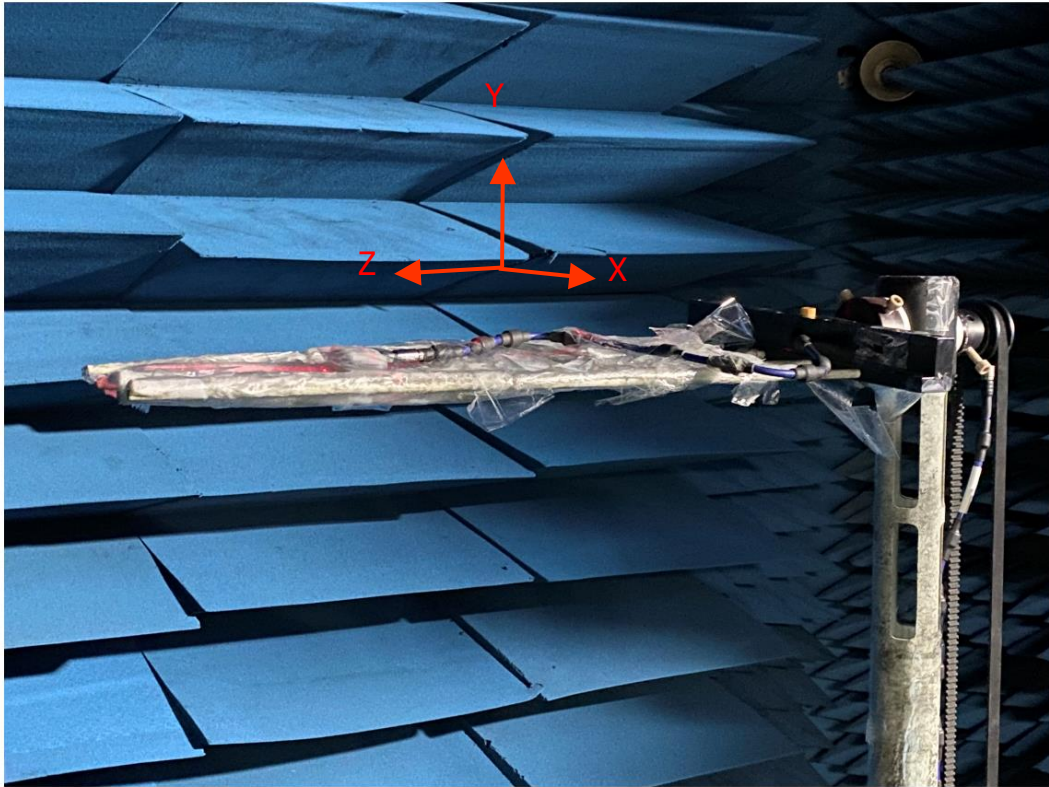

© Unictron Technologies Corp.  
All specifications subject to change without notice.



### 3D Radiation Gain Pattern

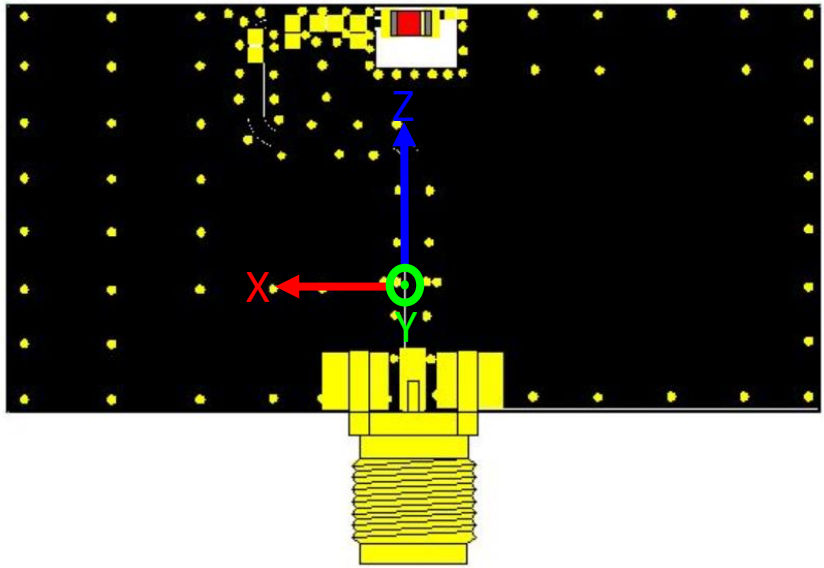

© Unictron Technologies Corp.  
All specifications subject to change without notice.

### 2450 MHz (unit: dBi)

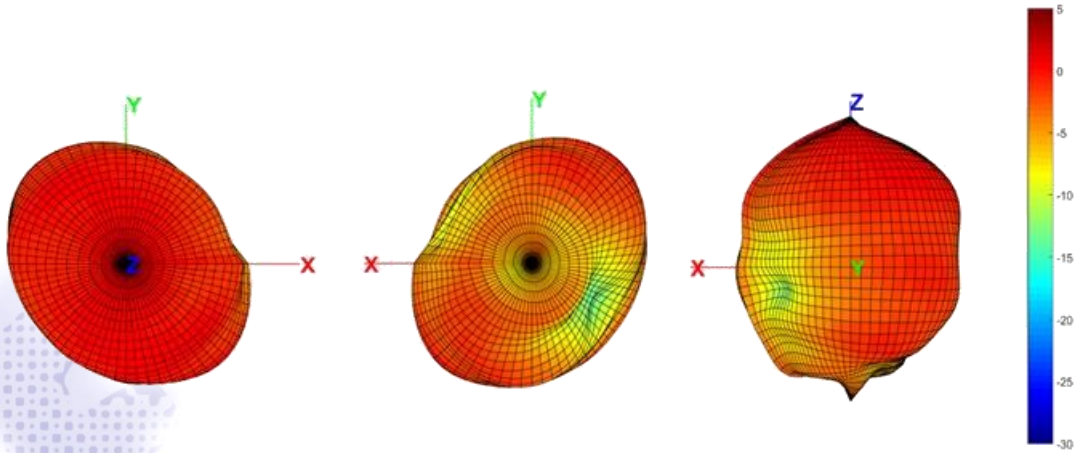

## VI. Frequency tuning:

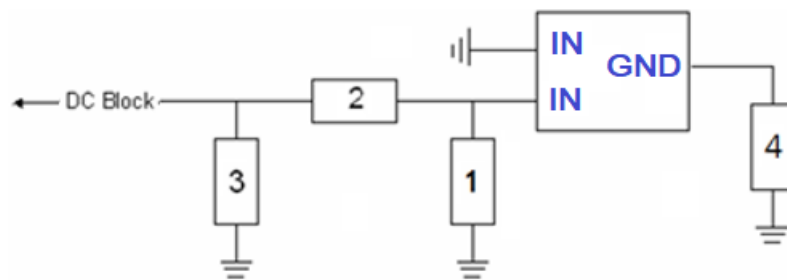
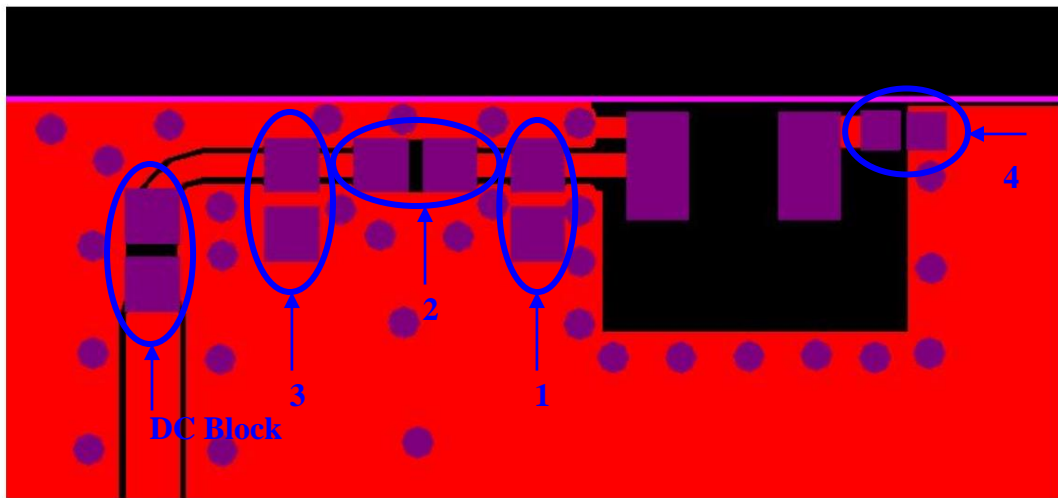

System Matching Circuit Component			
Location	Description	Vendor	Tolerance
1	N/C	-	-
2	5.0 pF (0402)	MURATA	±0.05 pF
3	0.8 pF (0402)	MURATA	±0.05 pF
4	2.7 pF (0201)	MURATA	±0.05 pF
DC Block	22 pF (0402)	MURATA	±5%

© Unictron Technologies Corp.  
All specifications subject to change without notice.

## VII. Soldering conditions:

### Typical Soldering Profile for Lead-free Process

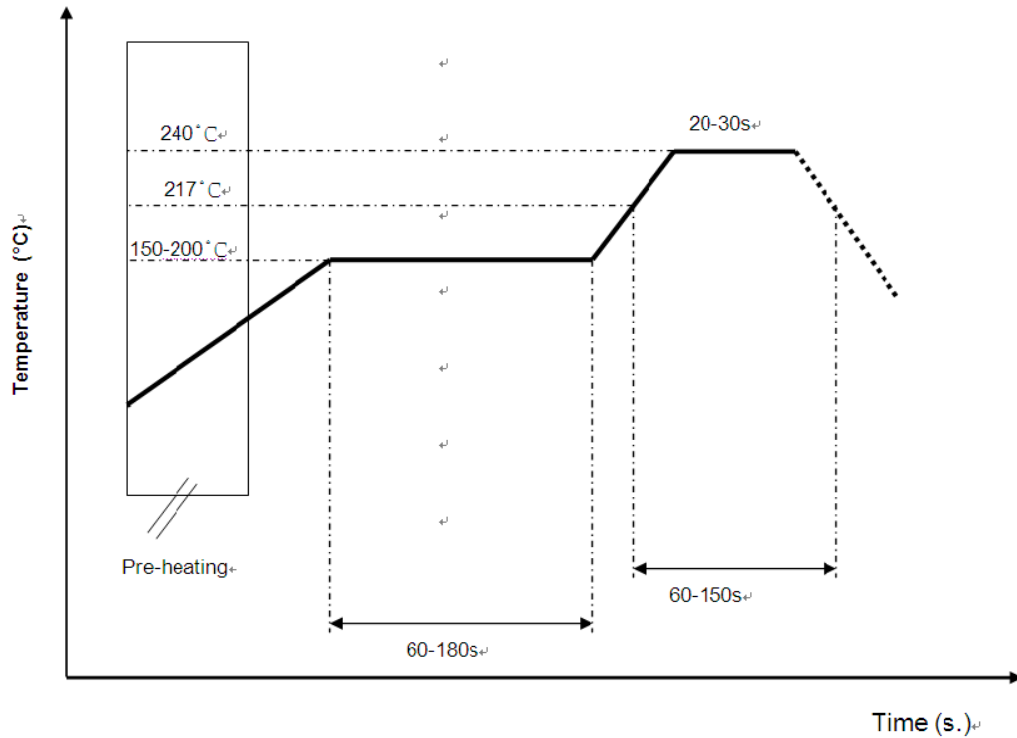

© Unictron Technologies Corp.  
All specifications subject to change without notice.

\*Recommended solder paste alloy: SAC305 (Sn96.5 /Ag3 /Cu0.5) Lead Free solder paste.

## VIII. Reminders for use of Unictron's ceramic chip antennas:

- a) This chip antenna is made of ceramic materials which is relatively more rigid and brittle compared to circuit board materials. Furthermore, the length of this antenna is quite long. Bending of circuit board at the locations where chip antenna is mounted may cause the cracking of solder joints or antenna itself.
- b) Punching/cutting of the break-off tab of PCB panel may cause severe bending of the circuit board which may result in cracking of solder joints or chip antenna itself. Therefore break-off tab shall be located away from the installation site of chip antenna.
- c) Be cautious when ultrasonic welding process needs to be used near the locations where chip antennas are installed. Strong ultrasonic vibration may cause the cracking of chip antenna solder joints.

## IX. Operating & Storage conditions:

### a) Operating

- (1) Maximum Input Power: 2 W
- (2) Operating Temperature: -40°C to 85°C
- (3) Relative Humidity: 10% to 70%

### b) Storage (sealed)

- (1) Storage Temperature: -5°C to 40°C
- (2) Relative Humidity: 20% to 70%
- (3) Shelf Life: 1 year

### c) Storage (unsealed)

Meet the criteria of J-STD-033 MSL2a

### d) Storage (After mounted on customer's PCB with SMT process)

- (1) Storage Temperature: -40°C to 85°C
- (2) Relative Humidity: 10% to 70%

## X. Notice

### (1) Installation Guide:

Please refer to Unictron's application note "General guidelines for the installation of Unictron's chip antennas" for further information.

### (2) All specifications are subject to change without notice.

## XI. Packing

- (1) Unit Weight:  $0.004 \pm 0.001$  (g) / pcs
- (2) Quantity/Reel: 5000 pcs/Reel
- (3) Plastic tape: Black Conductive Polystyrene.

a. Tape Drawing (unit: mm)

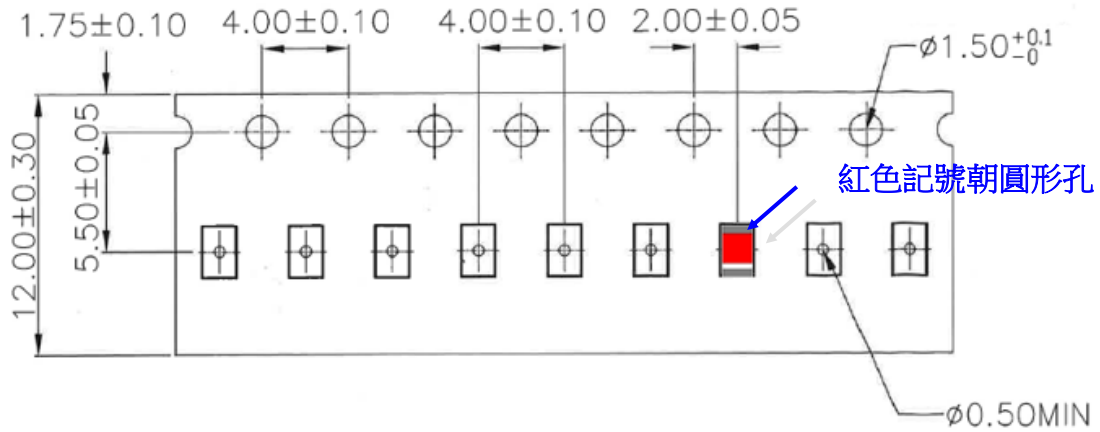

b. Reel Drawing (unit: mm)

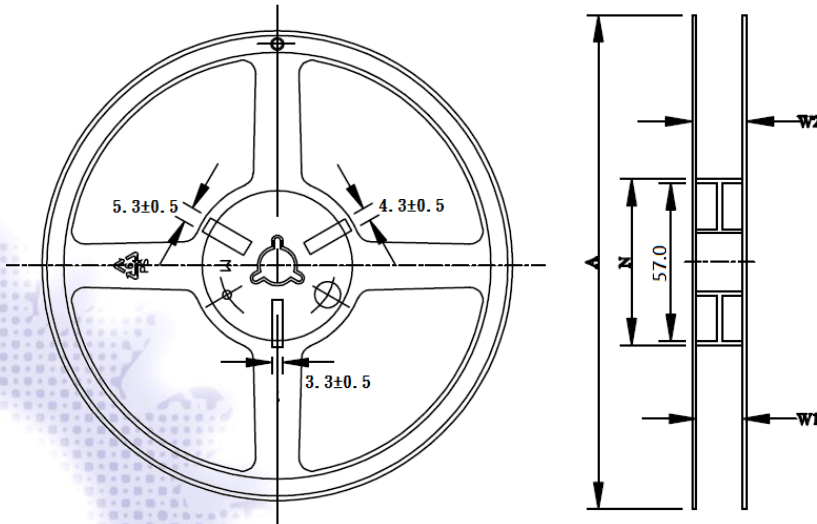

Feature	Specifications	Tolerances
A	178.0	$\pm 1.0$
B	2.7	$\pm 0.5$
C	13.3	$\pm 0.5$
N	60.0	$\pm 0.5$
W1	13.7	$\pm 0.5$
W2	16.1	$\pm 0.5$