



FCC TEST REPORT

REPORT NO.: RF920612R03

MODEL NO.: PUN1000W, PU100W, LD-WL11PS/U1,
Mini UWF, TEW-PS1U+

RECEIVED: July 17, 2003

TESTED: August 8~August 17, 2003

APPLICANT: Zero One Technology Co, Ltd

ADDRESS: 5F, No.5, Aly 22, Lane 513, Rei-Kuang Rd, Nei-Hu, Taipei, 114, Taiwan, R.O.C

ISSUED BY: Advance Data Technology Corporation

LAB LOCATION: 47 14th Lin, Chiapau Tsun, Linko, Taipei, Taiwan, R.O.C.

This test report consists of 51 pages in total. It may be duplicated completely for legal use with the approval of the applicant. It should not be reproduced except in full, without the written approval of our laboratory. The client should not use it to claim product endorsement by CNLA, NVLAP or any government agencies. The test results in the report only apply to the tested sample.



0528
ILAC MRA



Lab Code: 200102-0



Table of Contents

1	CERTIFICATION.....	5
2	SUMMARY OF TEST RESULTS.....	6
3	GENERAL INFORMATION.....	7
3.1	GENERAL DESCRIPTION OF EUT.....	7
3.2	DESCRIPTION OF TEST MODES.....	8
3.3	GENERAL DESCRIPTION OF APPLIED STANDARDS.....	8
3.4	DESCRIPTION OF SUPPORT UNITS.....	9
3.5	CONFIGURATION OF SYSTEM UNDER TEST.....	9
4	TEST TYPES AND RESULTS.....	10
4.1	CONDUCTED EMISSION MEASUREMENT.....	10
4.1.1	LIMITS OF CONDUCTED EMISSION MEASUREMENT.....	10
4.1.2	TEST INSTRUMENTS.....	10
4.1.3	TEST PROCEDURES.....	11
4.1.4	DEVIATION FROM TEST STANDARD.....	11
4.1.5	TEST SETUP.....	12
4.1.6	EUT OPERATING CONDITIONS.....	13
4.1.7	TEST RESULTS.....	14
4.2	RADIATED EMISSION MEASUREMENT.....	20
4.2.1	LIMITS OF RADIATED EMISSION MEASUREMENT.....	20
4.2.2	TEST INSTRUMENTS.....	21
4.2.3	TEST PROCEDURES.....	22
4.2.4	DEVIATION FROM TEST STANDARD.....	22
4.2.5	TEST SETUP.....	23
4.2.6	EUT OPERATING CONDITIONS.....	23
4.2.7	TEST RESULTS.....	24
4.3	6dB BANDWIDTH MEASUREMENT.....	29
4.3.1	LIMITS OF 6dB BANDWIDTH MEASUREMENT.....	29
4.3.2	TEST INSTRUMENTS.....	29



4.3.3	TEST PROCEDURE	30
4.3.4	DEVIATION FROM TEST STANDARD	30
4.3.5	TEST SETUP	30
4.3.6	EUT OPERATING CONDITIONS.....	30
4.3.7	TEST RESULTS.....	31
4.4	MAXIMUM PEAK OUTPUT POWER	35
4.4.1	LIMITS OF MAXIMUM PEAK OUTPUT POWER MEASUREMENT	35
4.4.2	TEST INSTRUMENTS	35
4.4.3	TEST PROCEDURES.....	36
4.4.4	DEVIATION FROM TEST STANDARD	36
4.4.5	TEST SETUP	36
4.4.6	EUT OPERATING CONDITIONS.....	36
4.4.7	TEST RESULTS.....	37
4.5	POWER SPECTRAL DENSITY MEASUREMENT.....	38
4.5.1	LIMITS OF POWER SPECTRAL DENSITY MEASUREMENT	38
4.5.2	TEST INSTRUMENTS	38
4.5.3	TEST PROCEDURE	39
4.5.4	DEVIATION FROM TEST STANDARD	39
4.5.5	TEST SETUP	39
4.5.6	EUT OPERATING CONDITIONS.....	39
4.5.7	TEST RESULTS.....	40
4.6	BAND EDGES MEASUREMENT	44
4.6.1	LIMITS OF BAND EDGES MEASUREMENT	44
4.6.2	TEST INSTRUMENTS	44
4.6.3	TEST PROCEDURE	44



4.6.4	DEVIATION FROM TEST STANDARD	44
4.6.5	EUT OPERATING CONDITION	45
4.6.6	TEST RESULTS.....	45
4.7	ANTENNA REQUIREMENT	48
4.7.1	STANDARD APPLICABLE	48
4.7.2	ANTENNA CONNECTED CONSTRUCTION.....	48
5	PHOTOGRAPHS OF THE TEST CONFIGURATION.....	49
6	INFORMATION ON THE TESTING LABORATORIES	51



1 CERTIFICATION

PRODUCT : USB Wireless Print Server
MODEL NO. : PUN1000W, PU100W, LD-WL11PS/U1,
Mini UWF, TEW-PS1U+
BRAND: ZOT, Elecom, PCI, Trendnet
APPLICANT : Zero One Technology Co, Ltd
TEST ITEM: Engineer Sample
STANDARDS : 47 CFR Part 15, Subpart C (Section 15.247),
ANSI C63.4-1992

We, **Advance Data Technology Corporation**, hereby certify that one sample of the designation has been tested in our facility from August 8, 2003 to August 17, 2003. The test record, data evaluation and Equipment Under Test (EUT) configurations represented herein are true and accurate accounts of the measurements of the sample's EMC characteristics under the conditions herein specified.

PREPARED BY:  , **DATE:** August 19, 2003
Stephanie Hung

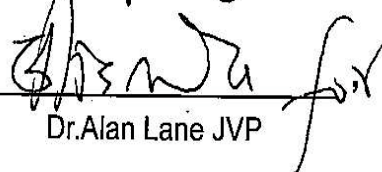
APPROVED BY:  **DATE:** August 19, 2003
Dr. Alan Lane JVP



2 SUMMARY OF TEST RESULTS

The EUT has been tested according to the following specifications:

APPLIED STANDARD: 47 CFR Part 15, Subpart C			
Standard Section	Test Type and Limit	Result	REMARK
15.207	AC Power Conducted Emission	PASS	Meet the requirement of limit Minimum passing margin is -5.78dB at 0.216MHz
15.247(a)(2)	Spectrum Bandwidth of a Direct Sequence Spread Spectrum System Limit: min. 500kHz	PASS	Meet the requirement of limit
15.247(b)	Maximum Peak Output Power Limit: max. 30dBm	PASS	Meet the requirement of limit
15.247(c)	Transmitter Radiated Emissions Limit: Table 15.209	PASS	Meet the requirement of limit Minimum passing margin is -2.10dB at 9848.00MHz
15.247(d)	Power Spectral Density Limit: max. 8dBm	PASS	Meet the requirement of limit
15.247(c)	Band Edge Measurement Limit: 20 dB less than the peak value of fundamental frequency	PASS	Meet the requirement of limit



3 GENERAL INFORMATION

3.1 GENERAL DESCRIPTION OF EUT

PRODUCT	USB Wireless Print Server
MODEL NO.	PUN1000W, PU100W, LD-WL11PS/U1, Mini UWF, TEW-PS1U+
POWER SUPPLY	3.3VDC from AC adapter
MODULATION TYPE	BPSK, QPSK, CCK
RADIO TECHNOLOGY	DSSS
TRANSFER RATE	1/2/5.5/11Mbps
FREQUENCY RANGE	2412MHz ~ 2462MHz
CHANNEL SPACING	5MHz
NUMBER OF CHANNEL	11
OUTPUT POWER	11.80dBm
ANTENNA TYPE	PIFA with -2dBi gain
DATA CABLE	NA
I/O PORTS	USB
ASSOCIATED DEVICES	NA

NOTE:

1. Model PUN1000W, PU100W, LD-WL11PS/U1, Mini UWF, TEW-PS1U+, are identical to each other except for their model number, product name and brand name due to marketing requirement.

BRAND	Model
ZOT	PU100W
Elecom	LD-WL11PS/U1
PCI	Mini UWF
Trendnet	TEW-PS11U+
ZOT	PUN1000W

2. The following AC adapter powers the EUT.

BRAND	UNIFIVE
MODEL	US300320
INPUT	AC100-240V 50-60Hz 0.3A
OUTPUT	DC3.3V 2A

3. For more detailed features description, please refer to the manufacturer's specifications or User's Manual.



3.2 DESCRIPTION OF TEST MODES

Eleven channels are provided to this EUT.

Channel	Frequency	Channel	Frequency
1	2412 MHz	7	2442 MHz
2	2417 MHz	8	2447 MHz
3	2422 MHz	9	2452 MHz
4	2427 MHz	10	2457 MHz
5	2432 MHz	11	2462 MHz
6	2437 MHz		

NOTE:

1. Below 1 GHz, the channel 1, 6, and 11 were pre-tested in chamber. The channel 11, worst case one, was chosen for final test.
2. Above 1 GHz, the channel 1, 6, and 11 were tested individually.
3. Data rate 11Mbps, the worst case, were chosen for final test.

3.3 GENERAL DESCRIPTION OF APPLIED STANDARDS

The EUT is a USB Wireless Print Server. According to the specifications of the manufacturer, it must comply with the requirements of the following standards:

FCC 47 CFR Part 15, Subpart C. (15.247)
ANSI C63.4 : 1992

All tests have been performed and recorded as per the above standards.

NOTE: The EUT is also considered as a kind of computer peripheral, because the connection to computer is necessary for typical use. It has been verified to comply with the requirements of FCC Part 15, Subpart B, Class B (DoC). The test report has been issued separately.

3.4 DESCRIPTION OF SUPPORT UNITS

The EUT has been tested as an independent unit together with other necessary accessories or support units. The following support units or accessories were used to form a representative test configuration during the tests.

NO.	PRODUCT	BRAND	MODEL NO.	SERIAL NO.	FCC ID
1	Notebook	Dell	PP01L	TW-09C748-12800-16M-5064	DoC
2	Wireless LAN Card	NA	DWL-650+	NA	NA
3	PRINTER	LEXMARK	Z33	NA	FCC DoC Approved

NO.	SIGNAL CABLE DESCRIPTION OF THE ABOVE SUPPORT UNITS
1	NA
2	NA
3	2.0 m foil shielded wire , terminated with USB connector via metallic frame, w/o core.

NOTE: All power cords of the above support units are non shielded (1.8m).

3.5 CONFIGURATION OF SYSTEM UNDER TEST

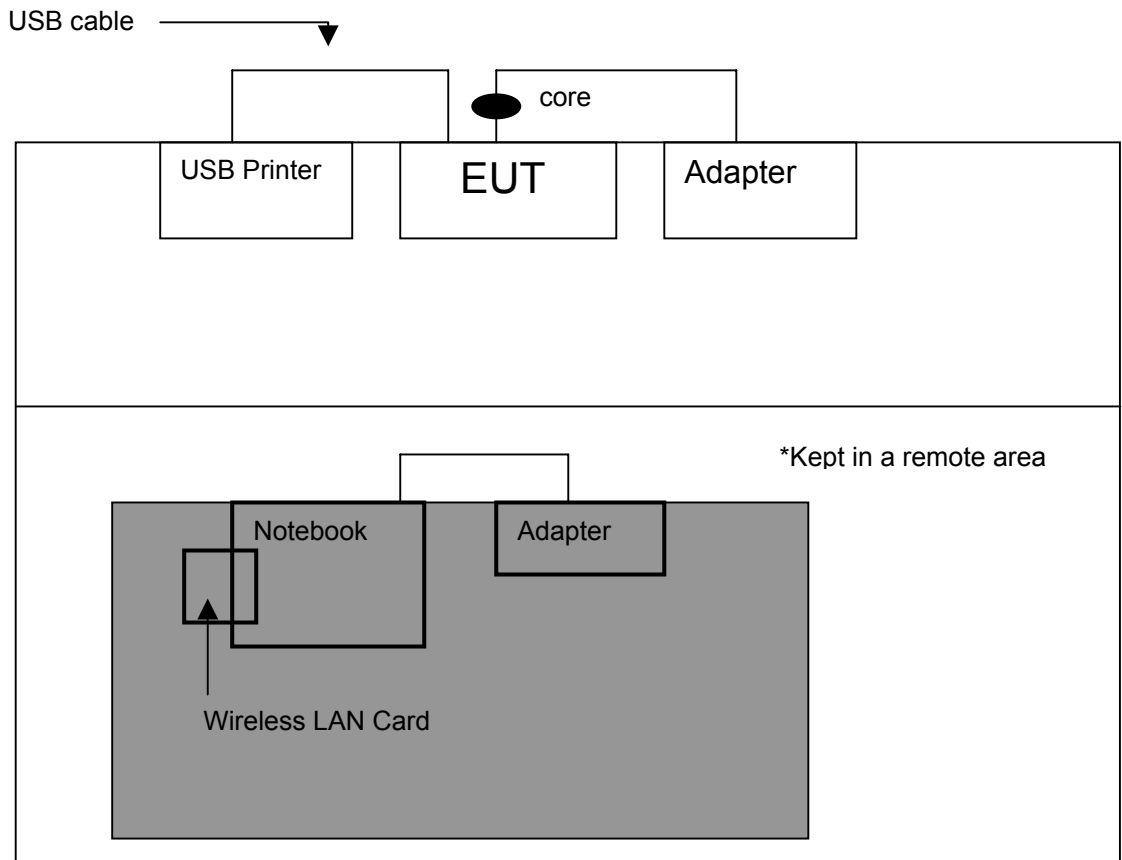



4 TEST TYPES AND RESULTS

4.1 CONDUCTED EMISSION MEASUREMENT

4.1.1 LIMITS OF CONDUCTED EMISSION MEASUREMENT

FREQUENCY OF EMISSION (MHz)	CONDUCTED LIMIT (dB μ V)	
	Quasi-peak	Average
0.15-0.5	66 to 56	56 to 46
0.5-5	56	46
5-30	60	50

NOTE:

1. The lower limit shall apply at the transition frequencies.
2. All emanations from a class B digital device or system, including any network of conductors and apparatus connected thereto, shall not exceed the level of field strengths specified above.
3. All emanations from a class A/B digital device or system, including any network of conductors and apparatus connected thereto, shall not exceed the level of field strengths specified above.

4.1.2 TEST INSTRUMENTS

DESCRIPTION & MANUFACTURER	MODEL NO.	SERIAL NO.	CALIBRATED UNTIL
ROHDE & SCHWARZ Test Receiver	ESCS 30	838251/021	Jan. 20, 2004
ROHDE & SCHWARZ Artificial Mains Network (for EUT)	ESH3-Z5	100218	Dec. 18, 2003
ROHDE & SCHWARZ Artificial Mains Network (for peripherals)	ESH3-Z5	100219	Dec. 18, 2003
ROHDE & SCHWARZ Artificial Mains Network (for peripherals)	ESH3-Z5	100220	Dec. 18, 2003
ROHDE & SCHWARZ 4-wire ISN	ENY41	837032/016	Nov. 29 2003
ROHDE & SCHWARZ 2-wire ISN	ENY22	837497/016	Nov. 29 2003
Software	Cond-V2M3	NA	NA
RF cable (JYEBAO)	5D-FB	Cable-C10.01	May. 01, 2004
SUHNER Terminator (For ROHDE & SCHWARZ LISN)	65BNC-5001	E1-010770	Mar. 24, 2004
SUHNER Terminator (For ROHDE & SCHWARZ LISN)	65BNC-5001	E1-010773	Apr. 06, 2004

- NOTE:
1. The calibration interval of the above test instruments is 12 months and the calibrations are traceable to NML/ROC and NIST/USA.
 2. “*”: These equipment are used for conducted telecom port test only (if tested).
 3. The test was performed in ADT Shielded Room No. 10.
 4. The VCCI Site Registration No. is C-1312.



4.1.3 TEST PROCEDURES

- a. The EUT was placed 0.4 meters from the conducting wall of the shielded room with EUT being connected to the power mains through a line impedance stabilization network (LISN). Other support units were connected to the power mains through another LISN. The two LISNs provide 50 ohm/ 50uH of coupling impedance for the measuring instrument.
- b. Both lines of the power mains connected to the EUT were checked for maximum conducted interference.
- c. The frequency range from 150 kHz to 30 MHz was searched. Emission levels over 10dB under the prescribed limits could not be reported

4.1.4 DEVIATION FROM TEST STANDARD

No deviation

4.1.5 TEST SETUP

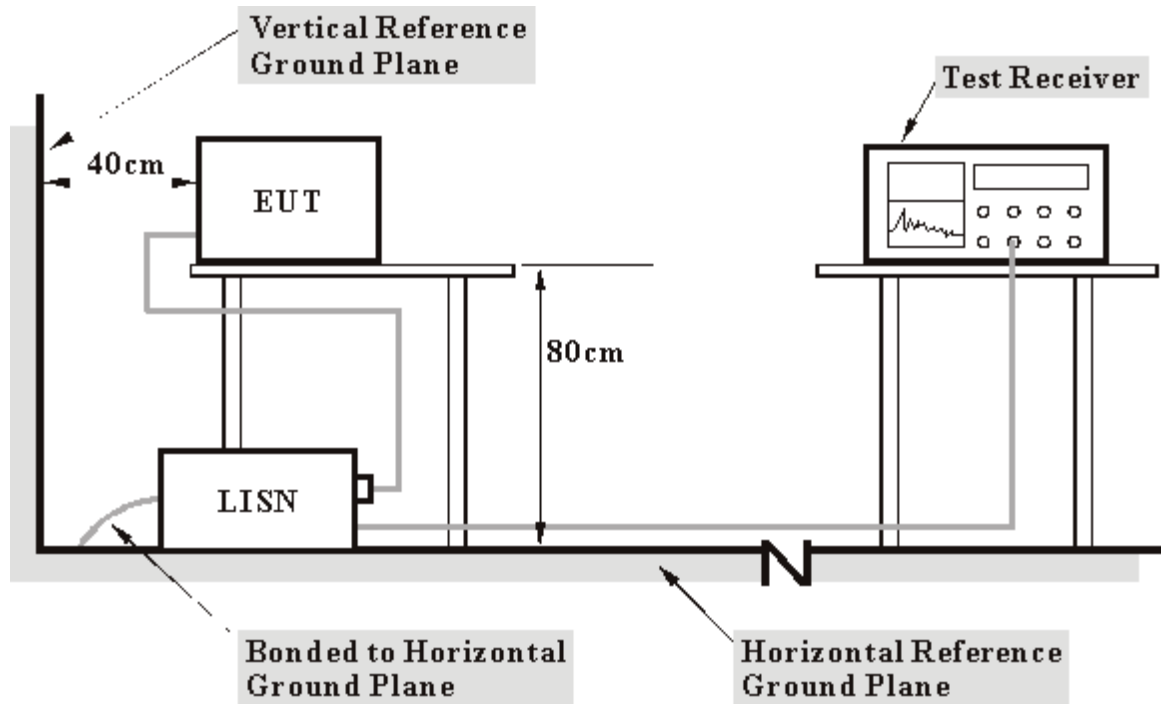

- Note:**
1. Support units were connected to second LISN.
 2. Both of LISNs (AMN) 80 cm from EUT and at the least 80 cm from other units and other metal planes support units.

For the actual test configuration, please refer to the related item – Photographs of the Test Configuration.



4.1.6 EUT OPERATING CONDITIONS

- a. Placed the EUT with printer on the testing table.
- b. Prepared another computer system to act as a communication partner and placed it outside of testing area.
- c. The communication partner run a test program to enable EUT under transmission/receiving condition continuously at specific channel frequency via Wireless .
- d. The EUT received messages from communication partner, then sent the messages to printer which print the messages on the paper.



4.1.7 TEST RESULTS

EUT	USB Wireless Print Server		
MODEL	PUN1000W, PU100W, LD-WL11PS/U1, Mini UWF, TEW-PS1U+		
MODE	Channel 1	6dB BANDWIDTH	9 kHz
INPUT POWER (SYSTEM)	120Vac, 60 Hz	PHASE	Line (L)
ENVIRONMENTAL CONDITIONS	30 deg. C, 60%RH, 991 hPa	TESTED BY: Steven Lu	

No	Freq. [MHz]	Corr. Factor (dB)	Reading Value		Emission Level		Limit		Margin	
			[dB (uV)]		[dB (uV)]		[dB (uV)]		(dB)	
			Q.P.	AV.	Q.P.	AV.	Q.P.	AV.	Q.P.	AV.
1	0.216	0.06	53.68	46.87	53.74	46.93	62.96	52.96	-9.22	-6.03
2	0.334	0.06	43.39	-	43.45	-	59.36	49.36	-15.91	-
3	1.316	0.17	39.45	-	39.62	-	56.00	46.00	-16.38	-
4	1.707	0.17	35.34	-	35.51	-	56.00	46.00	-20.49	-
5	4.008	0.22	39.56	-	39.78	-	56.00	46.00	-16.22	-
6	30.000	0.89	33.96	-	34.85	-	60.00	50.00	-25.15	-

- REMARKS:**
1. Q.P. and AV. are abbreviations of quasi-peak and average individually.
 2. "-": The Quasi-peak reading value also meets average limit and measurement with the average detector is unnecessary.
 3. The emission levels of other frequencies were very low against the limit.
 4. Margin value = Emission level - Limit value
 5. Correction factor = Insertion loss + Cable loss
 6. Emission Level = Correction Factor + Reading Value.

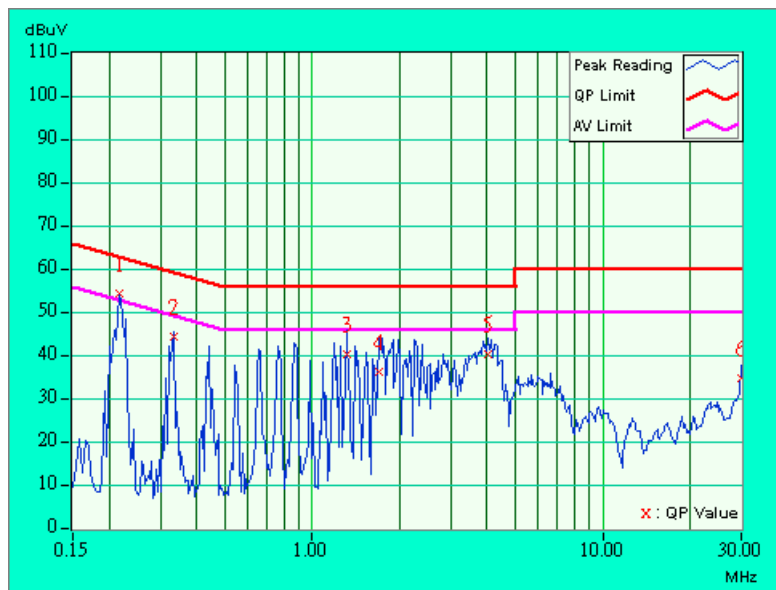



EUT	USB Wireless Print Server		
MODEL	PUN1000W, PU100W, LD-WL11PS/U1, Mini UWF, TEW-PS1U+		
MODE	Channel 1	6dB BANDWIDTH	9 kHz
INPUT POWER (SYSTEM)	120Vac, 60 Hz	PHASE	Neutral (N)
ENVIRONMENTAL CONDITIONS	30 deg. C, 60%RH, 991 hPa	TESTED BY: Steven Lu	

No	Freq. [MHz]	Corr. Factor (dB)	Reading Value		Emission Level		Limit		Margin	
			[dB (uV)]		[dB (uV)]		[dB (uV)]		(dB)	
			Q.P.	AV.	Q.P.	AV.	Q.P.	AV.	Q.P.	AV.
1	0.216	0.05	55.01	45.16	55.06	45.21	62.96	52.96	-7.90	-7.75
2	0.326	0.05	43.74	-	43.79	-	59.56	49.56	-15.77	-
3	0.775	0.12	40.41	-	40.53	-	56.00	46.00	-15.47	-
4	1.441	0.17	40.05	-	40.22	-	56.00	46.00	-15.78	-
5	4.309	0.22	36.54	-	36.76	-	56.00	46.00	-19.24	-
6	29.996	0.71	32.05	-	32.76	-	60.00	50.00	-27.24	-

- REMARKS:**
1. Q.P. and AV. are abbreviations of quasi-peak and average individually.
 2. "-": The Quasi-peak reading value also meets average limit and measurement with the average detector is unnecessary.
 3. The emission levels of other frequencies were very low against the limit.
 4. Margin value = Emission level - Limit value
 5. Correction factor = Insertion loss + Cable loss
 6. Emission Level = Correction Factor + Reading Value.

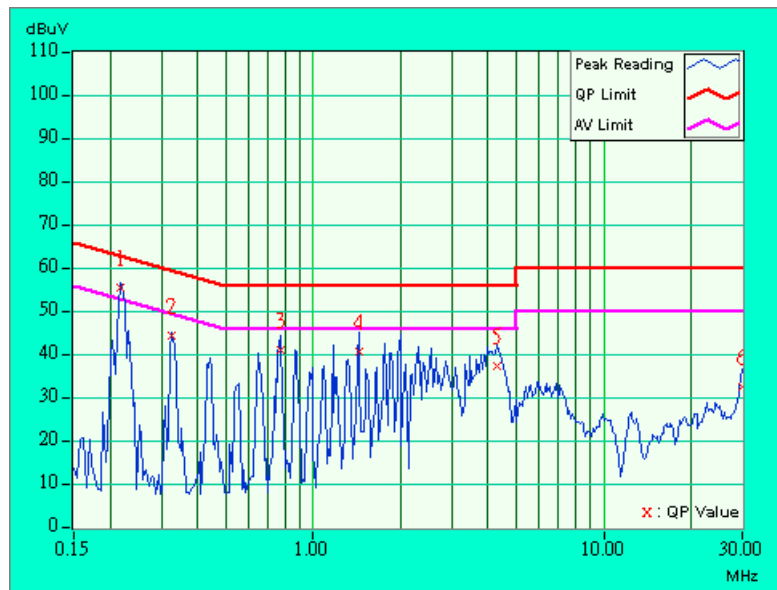



EUT	USB Wireless Print Server		
MODEL	PUN1000W, PU100W, LD-WL11PS/U1, Mini UWF, TEW-PS1U+		
MODE	Channel 6	6dB BANDWIDTH	9 kHz
INPUT POWER (SYSTEM)	120Vac, 60 Hz	PHASE	Line (L)
ENVIRONMENTAL CONDITIONS	30 deg. C, 60%RH, 991 hPa	TESTED BY: Steven Lu	

No	Freq. [MHz]	Corr. Factor (dB)	Reading Value		Emission Level		Limit		Margin	
			[dB (uV)]		[dB (uV)]		[dB (uV)]		(dB)	
			Q.P.	AV.	Q.P.	AV.	Q.P.	AV.	Q.P.	AV.
1	0.216	0.06	53.74	47.12	53.80	47.18	62.96	52.96	-9.16	-5.78
2	0.326	0.06	45.06	-	45.12	-	59.56	49.56	-14.44	-
3	0.767	0.12	39.85	-	39.97	-	56.00	46.00	-16.03	-
4	1.855	0.18	41.89	-	42.07	-	56.00	46.00	-13.93	-
5	3.922	0.22	39.33	-	39.55	-	56.00	46.00	-16.45	-
6	30.000	0.89	34.10	-	34.99	-	60.00	50.00	-25.01	-

- REMARKS:**
1. Q.P. and AV. are abbreviations of quasi-peak and average individually.
 2. "-": The Quasi-peak reading value also meets average limit and measurement with the average detector is unnecessary.
 3. The emission levels of other frequencies were very low against the limit.
 4. Margin value = Emission level - Limit value
 5. Correction factor = Insertion loss + Cable loss
 6. Emission Level = Correction Factor + Reading Value.

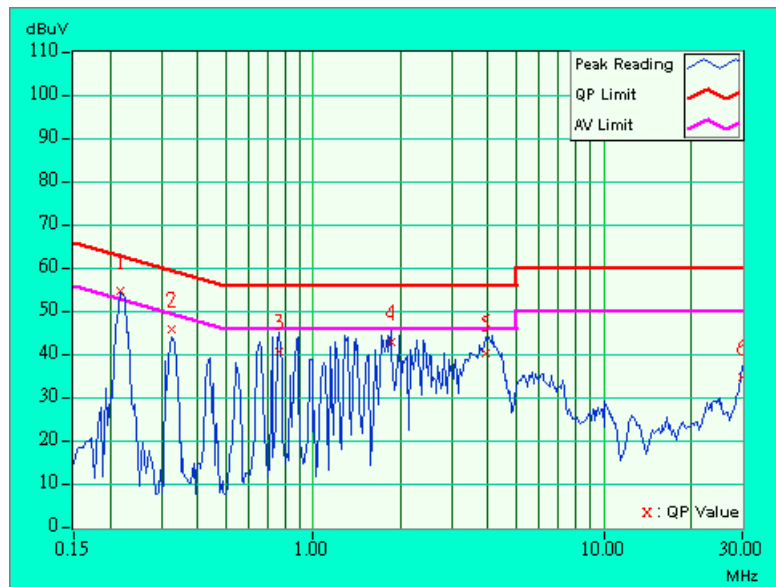



EUT	USB Wireless Print Server		
MODEL	PUN1000W, PU100W, LD-WL11PS/U1, Mini UWF, TEW-PS1U+		
MODE	Channel 6	6dB BANDWIDTH	9 kHz
INPUT POWER (SYSTEM)	120Vac, 60 Hz	PHASE	Neutral (N)
ENVIRONMENTAL CONDITIONS	30 deg. C, 60%RH, 991 hPa	TESTED BY: Steven Lu	

No	Freq. [MHz]	Corr. Factor (dB)	Reading Value		Emission Level		Limit		Margin	
			[dB (uV)]		[dB (uV)]		[dB (uV)]		(dB)	
			Q.P.	AV.	Q.P.	AV.	Q.P.	AV.	Q.P.	AV.
1	0.216	0.05	54.69	45.33	54.74	45.38	62.96	52.96	-8.22	-7.58
2	0.326	0.05	43.68	-	43.73	-	59.56	49.56	-15.83	-
3	0.666	0.10	38.71	-	38.81	-	56.00	46.00	-17.19	-
4	1.438	0.17	38.77	-	38.94	-	56.00	46.00	-17.06	-
5	4.160	0.21	35.42	-	35.63	-	56.00	46.00	-20.37	-
6	30.000	0.71	34.26	-	34.97	-	60.00	50.00	-25.03	-

- REMARKS:**
1. Q.P. and AV. are abbreviations of quasi-peak and average individually.
 2. "-": The Quasi-peak reading value also meets average limit and measurement with the average detector is unnecessary.
 3. The emission levels of other frequencies were very low against the limit.
 4. Margin value = Emission level - Limit value
 5. Correction factor = Insertion loss + Cable loss
 6. Emission Level = Correction Factor + Reading Value.

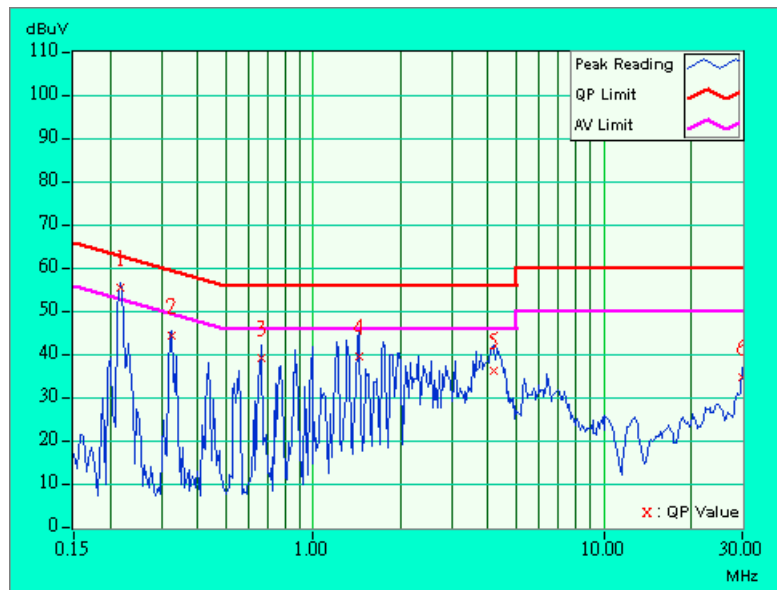



EUT	USB Wireless Print Server		
MODEL	PUN1000W, PU100W, LD-WL11PS/U1, Mini UWF, TEW-PS1U+		
MODE	Channel 11	6dB BANDWIDTH	9 kHz
INPUT POWER (SYSTEM)	120Vac, 60 Hz	PHASE	Line (L)
ENVIRONMENTAL CONDITIONS	30 deg. C, 60%RH, 991 hPa	TESTED BY: Steven Lu	

No	Freq. [MHz]	Corr. Factor (dB)	Reading Value		Emission Level		Limit		Margin	
			[dB (uV)]		[dB (uV)]		[dB (uV)]		(dB)	
			Q.P.	AV.	Q.P.	AV.	Q.P.	AV.	Q.P.	AV.
1	0.213	0.06	50.48	-	50.54	-	63.11	53.11	-12.57	-
2	0.330	0.06	45.19	-	45.25	-	59.46	49.46	-14.21	-
3	0.763	0.12	43.18	-	43.30	-	56.00	46.00	-12.70	-
4	1.809	0.18	34.64	-	34.82	-	56.00	46.00	-21.18	-
5	4.039	0.22	39.90	-	40.12	-	56.00	46.00	-15.88	-
6	30.000	0.89	34.02	-	34.91	-	60.00	50.00	-25.09	-

- REMARKS:**
1. Q.P. and AV. are abbreviations of quasi-peak and average individually.
 2. "-": The Quasi-peak reading value also meets average limit and measurement with the average detector is unnecessary.
 3. The emission levels of other frequencies were very low against the limit.
 4. Margin value = Emission level - Limit value
 5. Correction factor = Insertion loss + Cable loss
 6. Emission Level = Correction Factor + Reading Value.

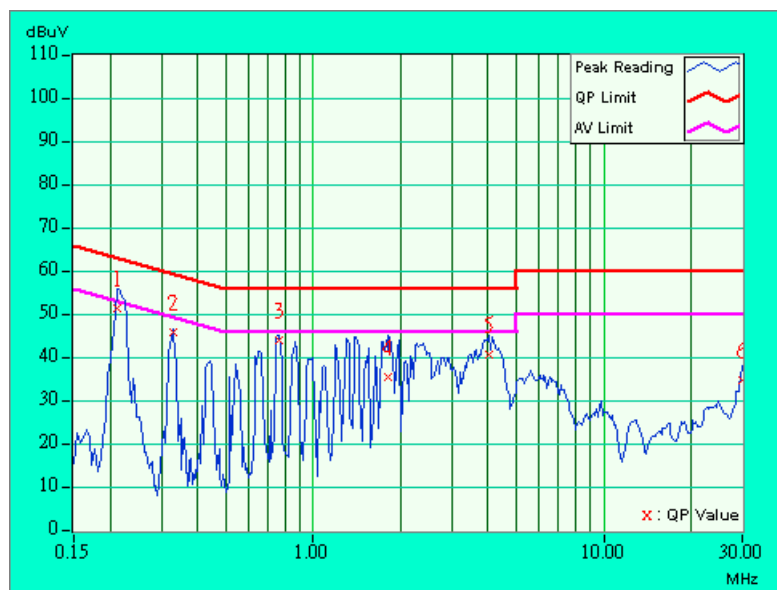



EUT	USB Wireless Print Server		
MODEL	PUN1000W, PU100W, LD-WL11PS/U1, Mini UWF, TEW-PS1U+		
MODE	Channel 11	6dB BANDWIDTH	9 kHz
INPUT POWER (SYSTEM)	120Vac, 60 Hz	PHASE	Neutral (N)
ENVIRONMENTAL CONDITIONS	30 deg. C, 60%RH, 991 hPa	TESTED BY: Steven Lu	

No	Freq. [MHz]	Corr. Factor (dB)	Reading Value		Emission Level		Limit		Margin	
			[dB (uV)]		[dB (uV)]		[dB (uV)]		(dB)	
			Q.P.	AV.	Q.P.	AV.	Q.P.	AV.	Q.P.	AV.
1	0.220	0.05	54.83	45.63	54.88	45.68	62.81	52.81	-7.93	-7.13
2	0.326	0.05	43.60	-	43.65	-	59.56	49.56	-15.91	-
3	0.869	0.14	36.70	-	36.84	-	56.00	46.00	-19.16	-
4	1.438	0.17	38.97	-	39.14	-	56.00	46.00	-16.86	-
5	4.324	0.22	36.37	-	36.59	-	56.00	46.00	-19.41	-
6	29.996	0.71	32.06	-	32.77	-	60.00	50.00	-27.23	-

- REMARKS:**
1. Q.P. and AV. are abbreviations of quasi-peak and average individually.
 2. "-": The Quasi-peak reading value also meets average limit and measurement with the average detector is unnecessary.
 3. The emission levels of other frequencies were very low against the limit.
 4. Margin value = Emission level - Limit value
 5. Correction factor = Insertion loss + Cable loss
 6. Emission Level = Correction Factor + Reading Value.

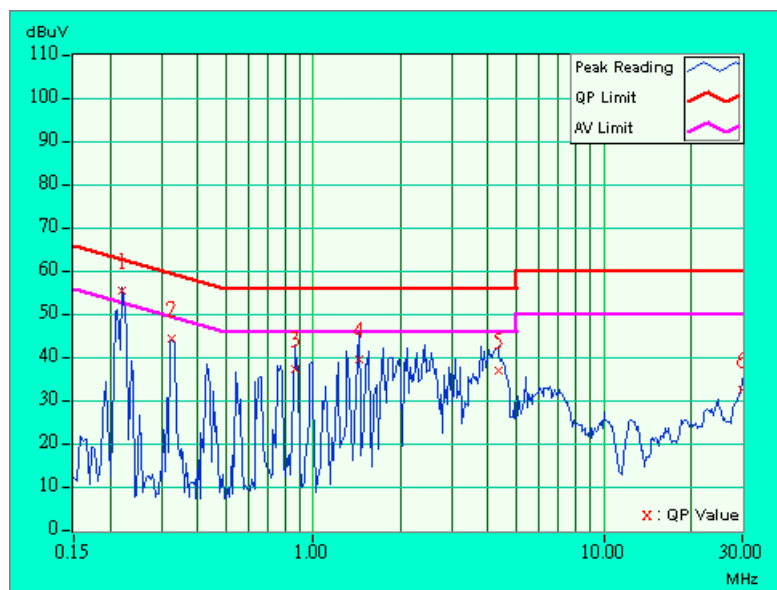



4.2 RADIATED EMISSION MEASUREMENT

4.2.1 LIMITS OF RADIATED EMISSION MEASUREMENT

Emissions radiated outside of the specified bands, shall be according to the general radiated limits in 15.209 as following:

Frequencies (MHz)	Field strength (microvolts/meter)	Measurement distance (meters)
0.009-0.490	2400/F(kHz)	300
0.490-1.705	24000/F(kHz)	30
1.705-30.0	30	30
30-88	100	3
88-216	150	3
216-960	200	3
Above 960	500	3

NOTE:

1. The lower limit shall apply at the transition frequencies.
2. Emission level (dBuV/m) = 20 log Emission level (uV/m).
3. As shown in 15.35(b), for frequencies above 1000MHz, the field strength limits are based on average detector, however, the peak field strength of any emission shall not exceed the maximum permitted average limits, specified above by more than 20dB under any condition of modulation.



4.2.2 TEST INSTRUMENTS

DESCRIPTION & MANUFACTURER	MODEL NO.	SERIAL NO.	CALIBRATED UNTIL
*HP Spectrum Analyzer	8590L	3520A00667	Aug. 26, 2003
CHASE Preamplifier	CPA9231A/4	3215	Nov. 06, 2003
* HP Preamplifier	8449B	3008A01201	Dec. 01, 2003
* HP Preamplifier	8449B	3008A01292	Aug. 06, 2004
* ROHDE & SCHWARZ TEST RECEIVER	ESVS10	846285/012	Sept. 16, 2003
* ROHDE & SCHWARZ TEST RECEIVER	ESMI	839013/007 839379/002	Feb. 13, 2004
SCHAFFNER Tunable Dipole Antenna	VHBA 9123	459	Nov. 22, 2003
SCHWARZBECK Tunable Dipole Antenna	UHA 9105	977	
* CHASE BILOG Antenna	CBL6112B	2751	March 21, 2004
* SCHWARZBECK Horn Antenna	BBHA9120-D1	D130	June 30, 2004
* EMCO Horn Antenna	3115	9312-4192	Mar. 23 2004
* CHANCE Turn Table & Tower Controller	ACS-I	NA	NA
* Software	ADT_Radiate d_V5.14	NA	NA
* ANRITSU RF Switches	MP59B	M51167	Aug. 21, 2003
* TIMES RF cable	LMR-600	CABLE-ST6-01	Aug. 21, 2003

- NOTE:**
1. The calibration interval of the above test instruments is 12 months. And the calibrations are traceable to NML/ROC and NIST/USA.
 2. "*" = These equipment are used for the final measurement.
 3. The horn antenna and HP preamplifier (model: 8449B) are used only for the measurement of emission frequency above 1GHz if tested.
 4. The test was performed in ADT Open Site No. 6.
 5. The VCCI Site Registration No. is R-728.



4.2.3 TEST PROCEDURES

- a. The EUT was placed on the top of a rotating table 0.8 meters above the ground at a 10 meter open area test site. The table was rotated 360 degrees to determine the position of the highest radiation.
- b. The EUT was set 3 meters away from the interference-receiving antenna, which was mounted on the top of a variable-height antenna tower.
- c. The antenna is a broadband antenna, and its height is varied from one meter to four meters above the ground to determine the maximum value of the field strength. Both horizontal and vertical polarizations of the antenna are set to make the measurement.
- d. For each suspected emission, the EUT was arranged to its worst case and then the antenna was tuned to heights from 1 meter to 4 meters and the rotatable table was turned from 0 degrees to 360 degrees to find the maximum reading.
- e. The test-receiver system was set to Peak Detect Function and Specified Bandwidth with Maximum Hold Mode.
- f. If the emission level of the EUT in peak mode was 10 dB lower than the limit specified, then testing could be stopped and the peak values of the EUT would be reported. Otherwise the emissions that did not have 10 dB margin would be re-tested one by one using peak, quasi-peak or average method as specified and then reported in a data sheet.

NOTE:

1. The resolution bandwidth and video bandwidth of test receiver/spectrum analyzer is 120kHz for Peak detection (PK) and Quasi-peak detection (QP) at frequency below 1GHz.
2. The resolution bandwidth and video bandwidth of test receiver/spectrum analyzer is 1 MHz for Peak detection at frequency above 1GHz.
3. The resolution bandwidth of test receiver/spectrum analyzer is 1 MHz and the video bandwidth is 300 Hz for Average detection (AV) at frequency above 1GHz.

4.2.4 DEVIATION FROM TEST STANDARD

No deviation

4.2.5 TEST SETUP

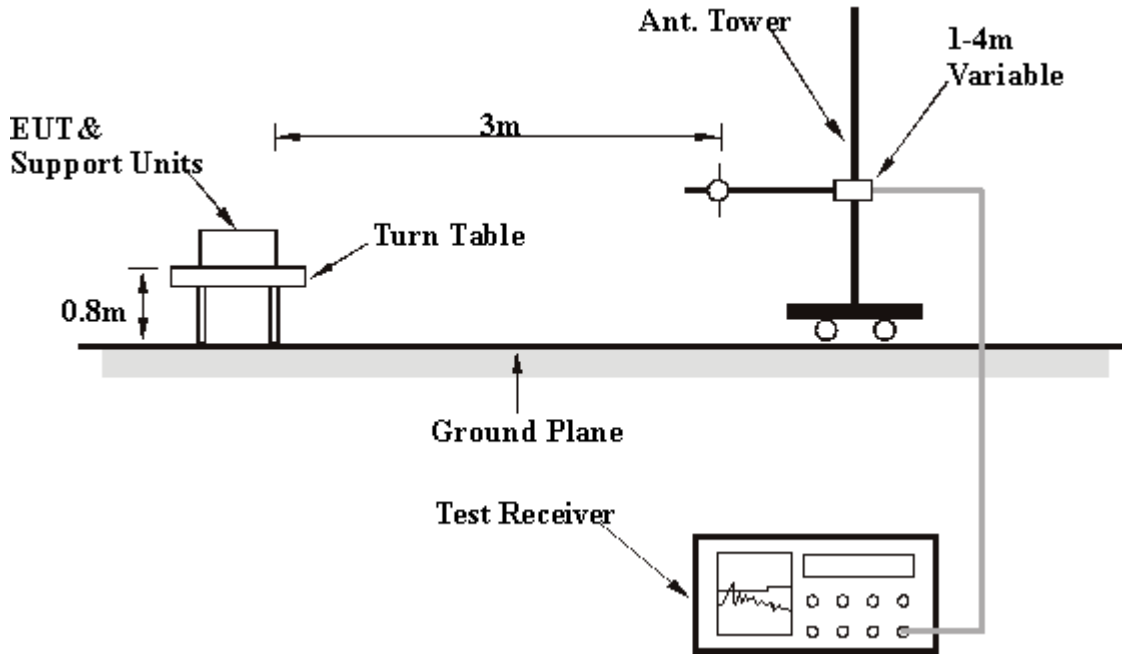

For the actual test configuration, please refer to the related item – Photographs of the Test Configuration.

4.2.6 EUT OPERATING CONDITIONS

Same as 4.1.6



4.2.7 TEST RESULTS

EUT	USB Wireless Print Server		
MODEL	PUN1000W, PU100W, LD-WL11PS/U1, Mini UWF, TEW-PS1U+		
CHANNEL	Channel 11	FREQUENCY RANGE	Below 1000 MHz
ENVIRONMENTAL CONDITIONS	27 deg. C, 55 % RH, 991 hPa	INPUT POWER (SYSTEM)	120Vac, 60 Hz
TESTED BY	Steven Lu	DETECTOR FUNCTION	Quasi-Peak

ANTENNA POLARITY & TEST DISTANCE: HORIZONTAL AT 3 M								
No.	Freq. (MHz)	Emission Level (dBuV/m)	Limit (dBuV/m)	Margin (dB)	Antenna Height (m)	Table Angle (Degree)	Raw Value (dBuV)	Correction Factor (dB/m)
1	250.94	34.4 QP	46.00	-11.60	1.25 H	184	21.00	13.40
2	284.36	38.4 QP	46.00	-7.60	1.00 H	172	23.60	14.70
3	400.76	34.8 QP	46.00	-11.20	1.00 H	334	17.10	17.70
4	451.41	32.7 QP	46.00	-13.30	1.00 H	154	13.40	19.30
5	550.57	31.9 QP	46.00	-14.10	1.50 H	232	10.80	21.10
6	650.80	40.0 QP	46.00	-6.00	1.25 H	100	16.80	23.30
7	701.46	37.2 QP	46.00	-8.80	1.25 H	100	13.20	24.00
8	751.03	39.0 QP	46.00	-7.00	1.00 H	208	13.70	25.40
9	800.61	36.5 QP	46.00	-9.50	1.75 H	220	10.80	25.60
10	851.27	33.3 QP	46.00	-12.70	1.00 H	214	7.10	26.20
11	900.84	36.9 QP	46.00	-9.10	1.00 H	82	9.80	27.10
12	951.50	40.8 QP	46.00	-5.20	1.50 H	208	13.10	27.70

REMARKS:

1. Emission level(dBuV/m)=Raw Value(dBuV) + Correction Factor(dB)
2. Correction Factor(dB/m) = Antenna Factor (dB/m) + Cable Factor (dB)
3. Margin value = Emission level - Limit value
4. The other emission levels were very low against the limit.



EUT	USB Wireless Print Server		
MODEL	PUN1000W, PU100W, LD-WL11PS/U1, Mini UWF, TEW-PS1U+		
CHANNEL	Channel 11	FREQUENCY RANGE	Below 1000 MHz
ENVIRONMENTAL CONDITIONS	27 deg. C, 55 % RH, 991 hPa	INPUT POWER (SYSTEM)	120Vac, 60 Hz
TESTED BY	Steven Lu	DETECTOR FUNCTION	Quasi-Peak

ANTENNA POLARITY & TEST DISTANCE: VERTICAL AT 3 M								
No.	Freq. (MHz)	Emission Level (dBuV/m)	Limit (dBuV/m)	Margin (dB)	Antenna Height (m)	Table Angle (Degree)	Raw Value (dBuV)	Correction Factor (dB/m)
1	59.10	34.7 QP	40.00	-5.30	1.00 V	202	21.50	13.20
2	100.06	35.8 QP	43.50	-7.70	1.25 V	244	25.50	10.30
3	117.30	35.4 QP	43.50	-8.10	1.00 V	274	23.30	12.00
4	167.96	33.1 QP	43.50	-10.40	1.00 V	88	19.50	13.60
5	400.76	32.1 QP	46.00	-13.90	1.00 V	70	14.40	17.70
6	550.57	36.1 QP	46.00	-9.90	1.00 V	196	15.00	21.10
7	583.98	35.2 QP	46.00	-10.80	1.00 V	190	13.00	22.10
8	650.80	37.6 QP	46.00	-8.40	1.25 V	148	14.30	23.30
9	701.46	36.8 QP	46.00	-9.20	1.00 V	190	12.80	24.00
10	751.03	38.9 QP	46.00	-7.10	1.00 V	154	13.50	25.40
11	800.61	39.0 QP	46.00	-7.00	1.00 V	154	13.30	25.60
12	851.27	35.0 QP	46.00	-11.00	1.00 V	160	8.80	26.20
13	900.84	41.2 QP	46.00	-4.80	1.00 V	208	14.00	27.10
14	950.42	43.1 QP	46.00	-2.90	1.00 V	220	15.40	27.70

REMARKS:

1. Emission level(dBuV/m)=Raw Value(dBuV) + Correction Factor(dB)
2. Correction Factor(dB/m) = Antenna Factor (dB/m) + Cable Factor (dB)
3. Margin value = Emission level - Limit value
4. The other emission levels were very low against the limit.



EUT	USB Wireless Print Server		
MODEL	PUN1000W, PU100W, LD-WL11PS/U1, Mini UWF, TEW-PS1U+		
CHANNEL	Channel 1	FREQUENCY RANGE	Above 1000 MHz
ENVIRONMENTAL CONDITIONS	27 deg. C, 55 % RH, 991 hPa	INPUT POWER (SYSTEM)	120Vac, 60 Hz
TESTED BY	Steven Lu	DETECTOR FUNCTION	Peak / Average

ANTENNA POLARITY & TEST DISTANCE: HORIZONTAL AT 3M								
No.	Freq. (MHz)	Emission Level (dBuV/m)	Limit (dBuV/m)	Margin (dB)	Antenna Height (m)	Table Angle (Degree)	Raw Value (dBuV)	Correction Factor (dB/m)
1	2375.41	52.1 PK	74.00	-21.90	1.19 H	183	20.60	31.50
1	2375.41	44.20 AV	54.00	-9.80	1.19 H	183	12.70	31.50
2	*2412.00	102.9 PK			1.19 H	183	71.30	31.60
2	*2412.00	95.6 AV			1.19 H	183	64.00	31.60
3	4824.80	54.1 PK	74.00	-19.90	1.64 H	210	15.70	38.40
3	4824.80	45.4 AV	54.00	-8.60	1.64 H	210	6.90	38.40
4	9648.00	60.6 PK	74.00	-13.40	1.32 H	154	16.30	44.20
4	9648.00	48.9 AV	54.00	-5.10	1.32 H	154	4.70	44.20

ANTENNA POLARITY & TEST DISTANCE: VERTICAL AT 3M								
No.	Freq. (MHz)	Emission Level (dBuV/m)	Limit (dBuV/m)	Margin (dB)	Antenna Height (m)	Table Angle (Degree)	Raw Value (dBuV)	Correction Factor (dB/m)
1	2375.41	50.80 PK	74.00	-23.20	1.00 V	255	19.30	31.50
1	2375.41	43.90 AV	54.00	-10.10	1.00 V	255	12.40	31.50
2	*2412.00	102.2 PK			1.00 V	255	70.70	31.60
2	*2412.00	95.3 AV			1.00 V	255	63.70	31.60
3	4824.00	56.3 PK	74.00	-17.70	1.03 V	193	17.90	38.40
3	4824.00	50.9 AV	54.00	-3.10	1.03 V	193	12.50	38.40
4	9648.06	61.3 PK	74.00	-12.70	1.00 V	189	17.10	44.20
4	9648.06	51.4 AV	54.00	-2.60	1.00 V	189	7.20	44.20

- REMARKS:**
1. Emission level(dBuV/m)=Raw Value(dBuV) + Correction Factor(dB)
 2. Correction Factor(dB/m) = Antenna Factor (dB/m) + Cable Factor (dB)
 3. Margin value = Emission level – Limit value.
 4. “ * “ : Fundamental frequency.
 5. The other emission levels were very low against the limit.



EUT	USB Wireless Print Server		
MODEL	PUN1000W, PU100W, LD-WL11PS/U1, Mini UWF, TEW-PS1U+		
CHANNEL	Channel 6	FREQUENCY RANGE	Above 1000 MHz
ENVIRONMENTAL CONDITIONS	27 deg. C, 55 % RH, 991 hPa	INPUT POWER (SYSTEM)	120Vac, 60 Hz
TESTED BY	Steven Lu	DETECTOR FUNCTION	Peak / Average

ANTENNA POLARITY & TEST DISTANCE: HORIZONTAL AT 3M								
No.	Freq. (MHz)	Emission Level (dBuV/m)	Limit (dBuV/m)	Margin (dB)	Antenna Height (m)	Table Angle (Degree)	Raw Value (dBuV)	Correction Factor (dB/m)
1	*2437.00	101.1 PK			1.15 H	183	69.50	31.60
1	*2437.00	94.1 AV			1.15 H	183	62.50	31.60
2	4874.00	54.8 PK	74.00	-19.20	1.02 H	181	16.40	38.50
2	4874.00	47.1 AV	54.00	-6.90	1.02 H	181	8.70	38.50
3	9748.00	61.7 PK	74.00	-12.30	1.02 H	200	17.10	44.60
3	9748.00	51.2 AV	54.00	-2.80	1.02 H	200	6.60	44.60

ANTENNA POLARITY & TEST DISTANCE: VERTICAL AT 3M								
No.	Freq. (MHz)	Emission Level (dBuV/m)	Limit (dBuV/m)	Margin (dB)	Antenna Height (m)	Table Angle (Degree)	Raw Value (dBuV)	Correction Factor (dB/m)
1	*2437.00	101.5 PK			1.22 V	172	69.90	31.60
1	*2437.00	93.9 AV			1.22 V	172	62.30	31.60
2	4873.97	56.3 PK	74.00	-17.70	1.18 V	144	17.90	38.50
2	4873.97	51.9 AV	54.00	-2.10	1.18 V	144	13.40	38.50
3	9748.00	61.5 PK	74.00	-12.50	1.33 V	200	17.00	44.60
3	9748.00	51.6 AV	54.00	-2.40	1.33 V	200	7.10	44.60

- REMARKS:**
1. Emission level(dBuV/m)=Raw Value(dBuV) + Correction Factor(dB)
 2. Correction Factor(dB/m) = Antenna Factor (dB/m) + Cable Factor (dB)
 3. Margin value = Emission level – Limit value.
 4. “ * “ : Fundamental frequency.
 5. The other emission levels were very low against the limit.



EUT	USB Wireless Print Server		
MODEL	PUN1000W, PU100W, LD-WL11PS/U1, Mini UWF, TEW-PS1U+		
CHANNEL	Channel 11	FREQUENCY RANGE	Above 1000 MHz
ENVIRONMENTAL CONDITIONS	27 deg. C, 55 % RH, 991 hPa	INPUT POWER (SYSTEM)	120Vac, 60 Hz
TESTED BY	Steven Lu	DETECTOR FUNCTION	Peak / Average

ANTENNA POLARITY & TEST DISTANCE: HORIZONTAL AT 3M

No.	Freq. (MHz)	Emission Level (dBuV/m)	Limit (dBuV/m)	Margin (dB)	Antenna Height (m)	Table Angle (Degree)	Raw Value (dBuV)	Correction Factor (dB/m)
1	*2462.00	102.8 PK			1.10 H	174	71.10	31.70
1	*2462.00	95.8 AV			1.10 H	174	64.10	31.70
2	4924.00	55.3 PK	74.00	-18.70	1.66 H	210	16.80	38.50
2	4924.00	45.4 AV	54.00	-8.60	1.66 H	210	6.90	38.50
3	9848.00	60.6 PK	74.00	-13.40	1.34 H	155	15.80	44.80
3	9848.00	48.9 AV	54.00	-5.10	1.34 H	155	4.10	44.80

ANTENNA POLARITY & TEST DISTANCE: VERTICAL AT 3M

No.	Freq. (MHz)	Emission Level (dBuV/m)	Limit (dBuV/m)	Margin (dB)	Antenna Height (m)	Table Angle (Degree)	Raw Value (dBuV)	Correction Factor (dB/m)
1	*2462.00	103.3 PK			1.14 V	247	71.60	31.70
1	*2462.00	96.1 AV			1.14 V	247	64.40	31.70
2	2499.30	50.0 PK	74.00	-24.00	1.14 V	247	18.20	31.80
2	2499.30	42.8 AV	54.00	-11.20	1.14 V	247	11.00	31.80
3	4924.00	56.5 PK	74.00	-17.50	1.05 V	178	18.00	38.50
3	4924.00	51.2 AV	54.00	-2.80	1.05 V	178	12.70	38.50
4	9848.00	61.7 PK	74.00	-12.30	1.04 V	200	16.90	44.80
4	9848.00	51.9 AV	54.00	-2.10	1.04 V	200	7.10	44.80

- REMARKS:**
1. Emission level(dBuV/m)=Raw Value(dBuV) + Correction Factor(dB)
 2. Correction Factor(dB/m) = Antenna Factor (dB/m) + Cable Factor (dB)
 3. Margin value = Emission level – Limit value.
 4. “ * “ : Fundamental frequency.
 5. The other emission levels were very low against the limit.



4.3 6dB BANDWIDTH MEASUREMENT

4.3.1 LIMITS OF 6dB BANDWIDTH MEASUREMENT

The minimum of 6dB Bandwidth Measurement is 0.5 MHz.

4.3.2 TEST INSTRUMENTS

Description & Manufacturer	Model No.	Serial No.	Calibrated Until
SPECTRUM ANALYZER	FSEK30	100049	August 12, 2004

NOTE:

1. The calibration interval of the above test instruments is 12 months and the calibrations are traceable to NML/ROC and NIST/USA.

4.3.3 TEST PROCEDURE

The transmitter output was connected to the spectrum analyzer through an attenuator. The bandwidth of the fundamental frequency was measured by spectrum analyzer with 100 kHz RBW and 100 kHz VBW. The 6 dB bandwidth is defined as the total spectrum the power of which is higher than peak power minus 6 dB.

4.3.4 DEVIATION FROM TEST STANDARD

No deviation

4.3.5 TEST SETUP

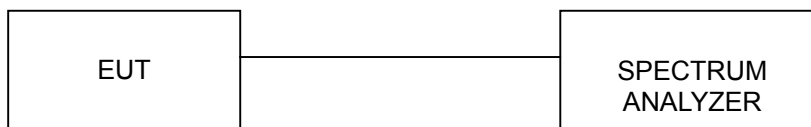

4.3.6 EUT OPERATING CONDITIONS

The software provided by client to enable the EUT under transmission condition continuously at lowest, middle and highest channel frequencies individually.



4.3.7 TEST RESULTS

EUT	USB Wireless Print Server		
MODEL	PUN1000W,PU100W,LD-WL11PS/U1,Mini UWF,TEW-PS1U+		
INPUT POWER (SYSTEM)	120Vac, 60 Hz	ENVIRONMENTAL CONDITIONS	24deg. C, 65H, 991 hPa
TESTED BY	Steven Lu		

CHANNEL	CHANNEL FREQUENCY (MHz)	6 dB BANDWIDTH (MHz)	MINIMUM LIMIT (MHz)	PASS/FAIL
1	2412	11.44	0.5	PASS
6	2437	11.04	0.5	PASS
11	2462	11.04	0.5	PASS



CH1

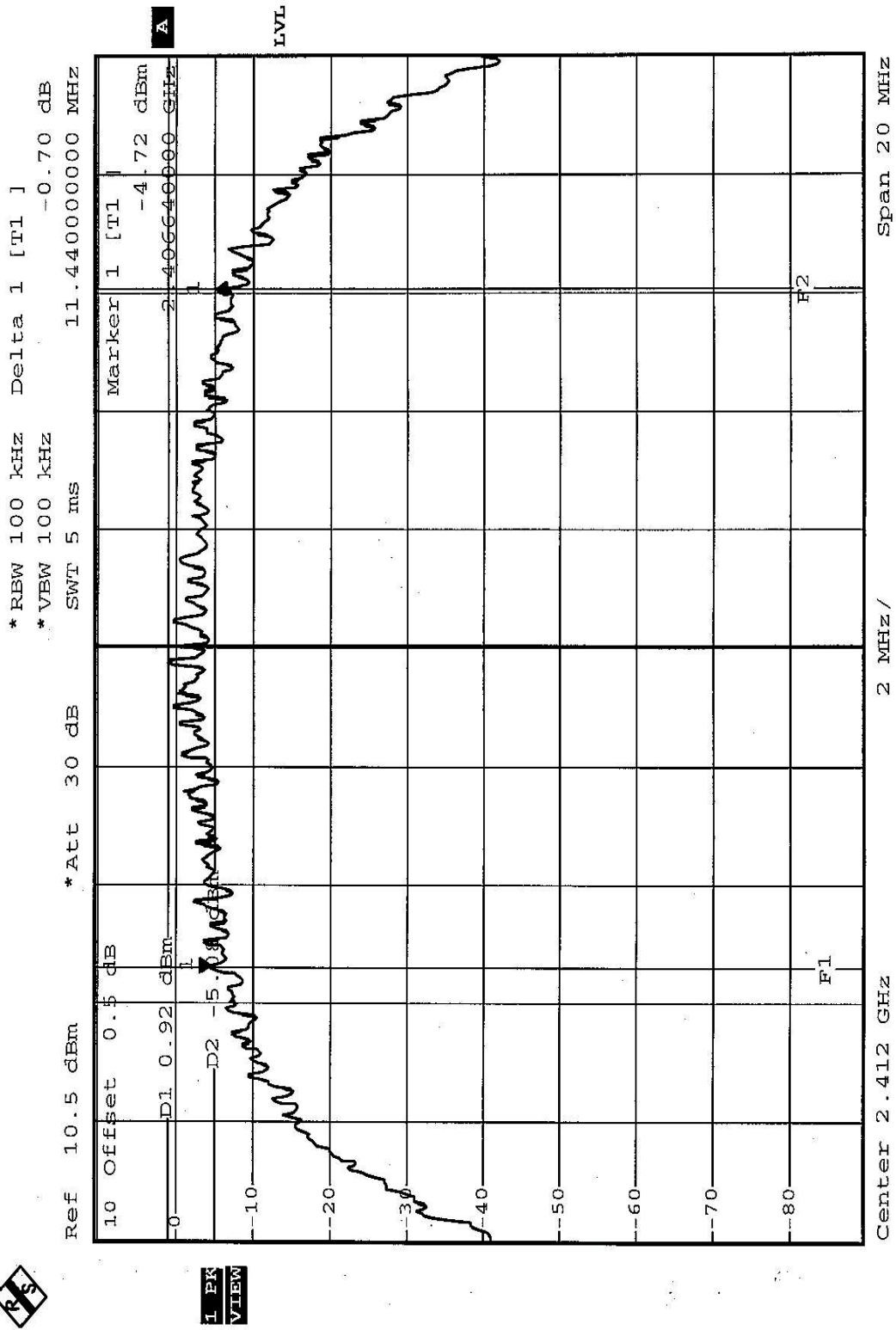



CH6

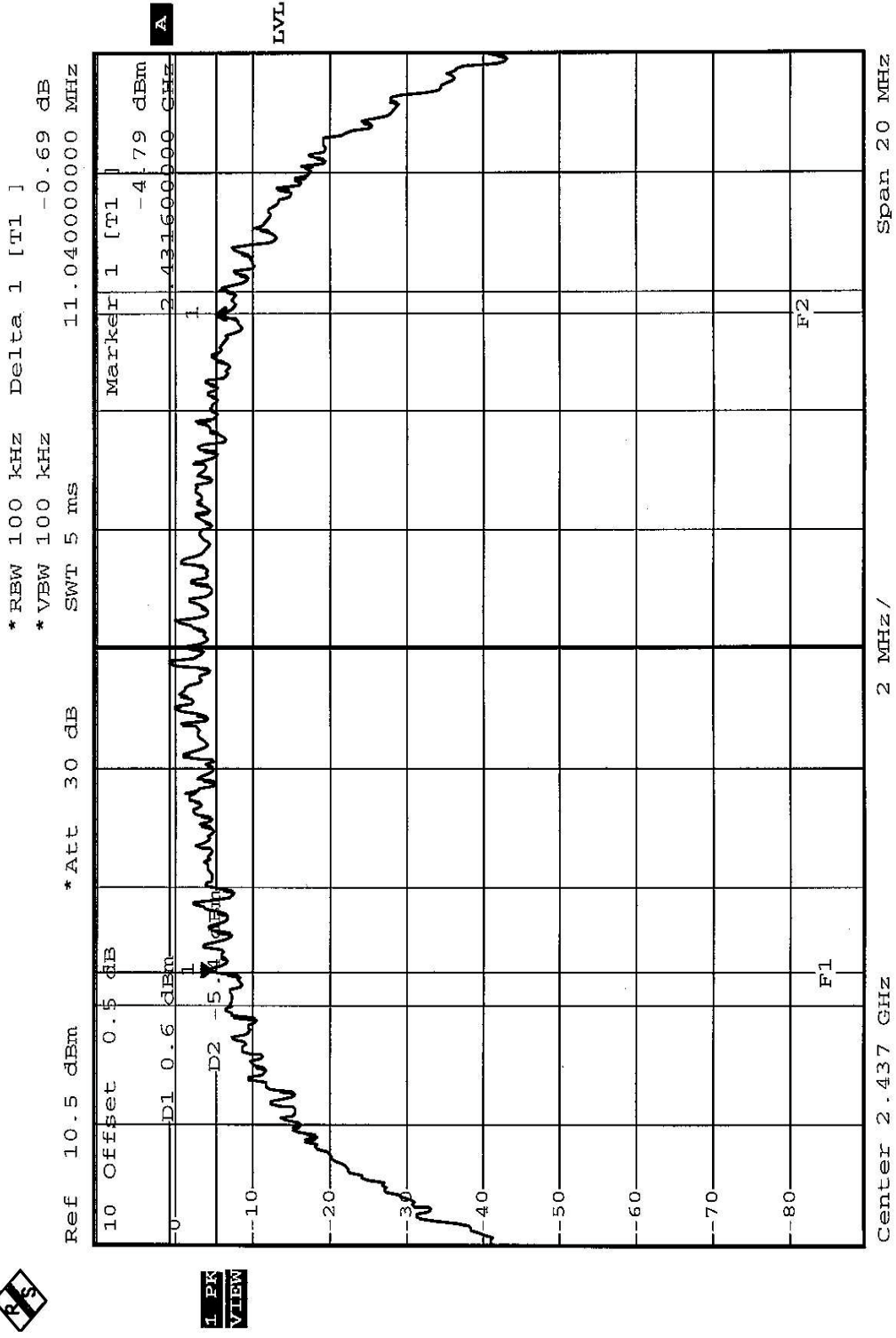



CH11

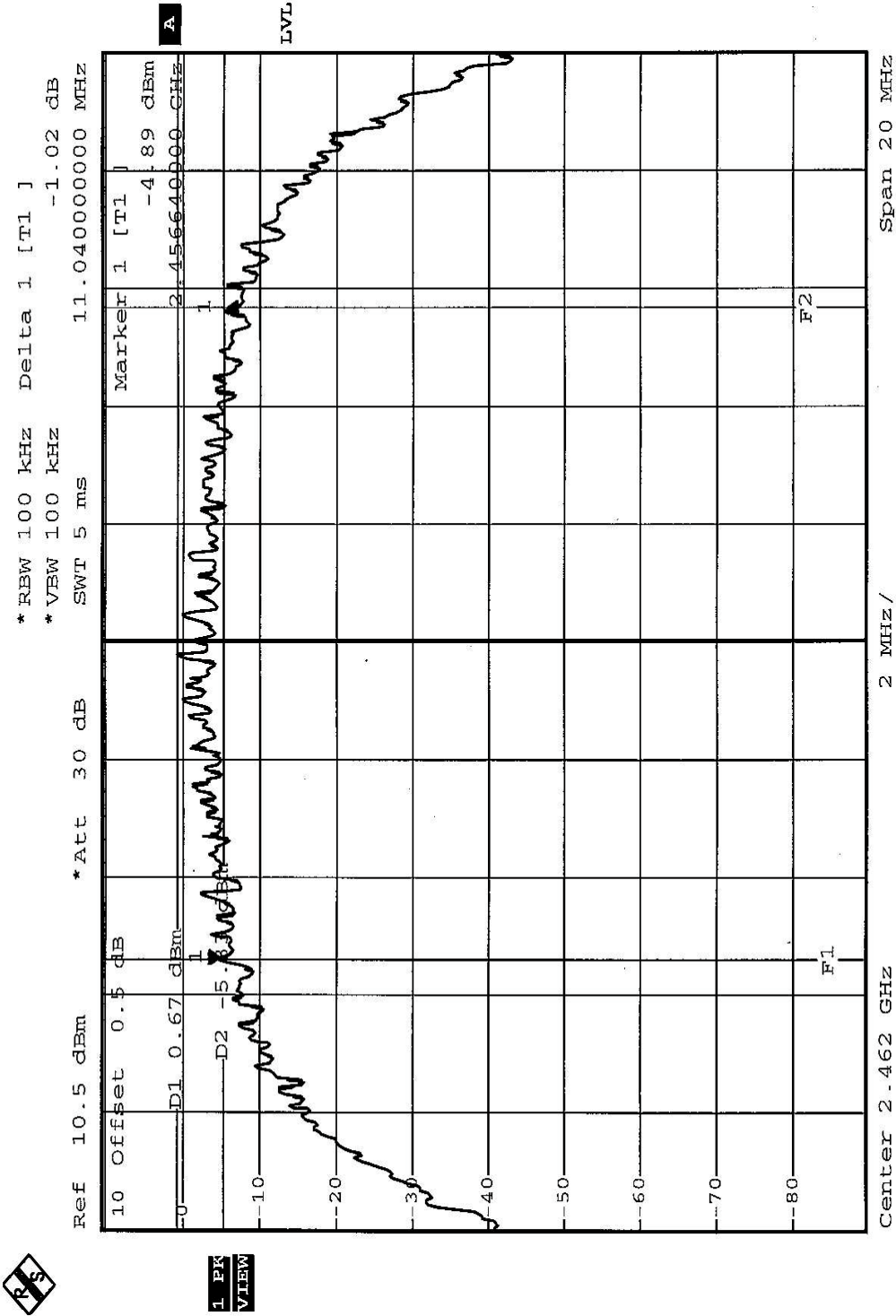



4.4 MAXIMUM PEAK OUTPUT POWER

4.4.1 LIMITS OF MAXIMUM PEAK OUTPUT POWER MEASUREMENT

The Maximum Peak Output Power Measurement is 30dBm.

4.4.2 TEST INSTRUMENTS

Description & Manufacturer	Model No.	Serial No.	Calibrated Until
R&S SPECTRUM ANALYZER	FSEK30	100049	August 12, 2004
R&S SIGNAL GENERATOR	SMP04	100011	May 28, 2004
TEKTRONIX OSCILLOSCOPE	TDS 220	B048470	Mar. 05, 2004
NARDA DETECTOR	4503A	FSCM99899	NA

NOTE:

The calibration interval of the above test instruments is 12 months and the calibrations are traceable to NML/ROC and NIST/USA.



4.4.3 TEST PROCEDURES

1. A detector was used on the output port of the EUT. An oscilloscope was used to read the response of the detector.
2. Replaced the EUT by the signal generator . The center frequency of the S.G was adjusted to the center frequency of the measured channel.
3. Adjusted the power to have the same reading on oscilloscope. Record the power level.

4.4.4 DEVIATION FROM TEST STANDARD

No deviation

4.4.5 TEST SETUP

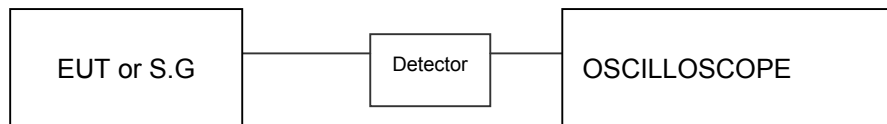

4.4.6 EUT OPERATING CONDITIONS

Same as Item 4.3.6



4.4.7 TEST RESULTS

EUT	USB Wireless Print Server		
MODEL	PUN1000W,PU100W,LD-WL11PS/U1,Mini UWF,TEW-PS1U+		
INPUT POWER (SYSTEM)	120Vac, 60 Hz	ENVIRONMENTAL CONDITIONS	29 deg. C, 52%RH, 991 hPa
TESTED BY	Steven Lu		

CHANNEL	CHANNEL FREQUENCY (MHz)	PEAK POWER OUTPUT (dBm)	PEAK POWER LIMIT (dBm)	PASS/FAIL
1	2412	11.2	30	PASS
6	2437	11.8	30	PASS
11	2462	11.7	30	PASS



4.5 POWER SPECTRAL DENSITY MEASUREMENT

4.5.1 LIMITS OF POWER SPECTRAL DENSITY MEASUREMENT

The Maximum of Power Spectral Density Measurement is 8dBm.

4.5.2 TEST INSTRUMENTS

Description & Manufacturer	Model No.	Serial No.	Calibrated Until
SPECTRUM ANALYZER	FSEK30	100049	August 12, 2004

NOTE:

1. The calibration interval of the above test instruments is 12 months and the calibrations are traceable to NML/ROC and NIST/USA.

4.5.3 TEST PROCEDURE

The transmitter output was connected to the spectrum analyzer through an attenuator, the bandwidth of the fundamental frequency was measured with the spectrum analyzer using 3 kHz RBW and 30 kHz VBW, set sweep time=span/3kHz. The power spectral density was measured and recorded. The sweep time is allowed to be longer than span/3KHz for a full response of the mixer in the spectrum analyzer.

4.5.4 DEVIATION FROM TEST STANDARD

No deviation

4.5.5 TEST SETUP

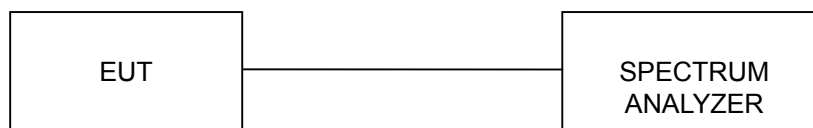

4.5.6 EUT OPERATING CONDITIONS

Same as 4.3.6



4.5.7 TEST RESULTS

EUT	USB Wireless Print Server		
MODEL	PUN1000W,PU100W,LD-WL11PS/U1,Mini UWF,TEW-PS1U+		
INPUT POWER (SYSTEM)	120Vac, 60 Hz	ENVIRONMENTAL CONDITIONS	29 deg. C, 52%RH, 991 hPa
TESTED BY	Steven Lu		

CHANNEL NUMBER	CHANNEL FREQUENCY (MHz)	RF POWER LEVEL IN 3 KHz BW (dBm)	MAXIMUM LIMIT (dBm)	PASS/FAIL
1	2412	-13.31	8	PASS
6	2437	-13.37	8	PASS
11	2462	-13.16	8	PASS



CH1

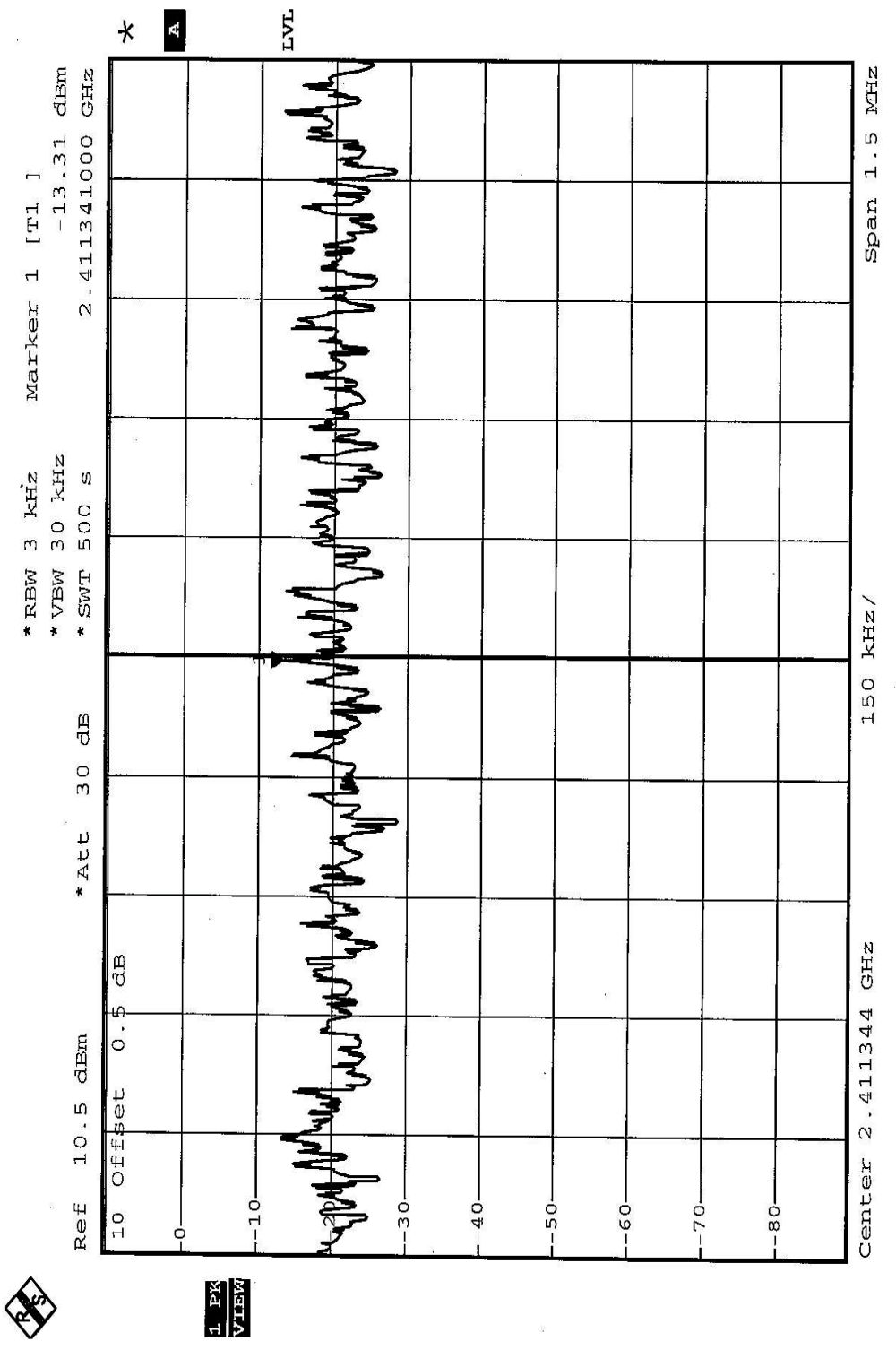



CH6

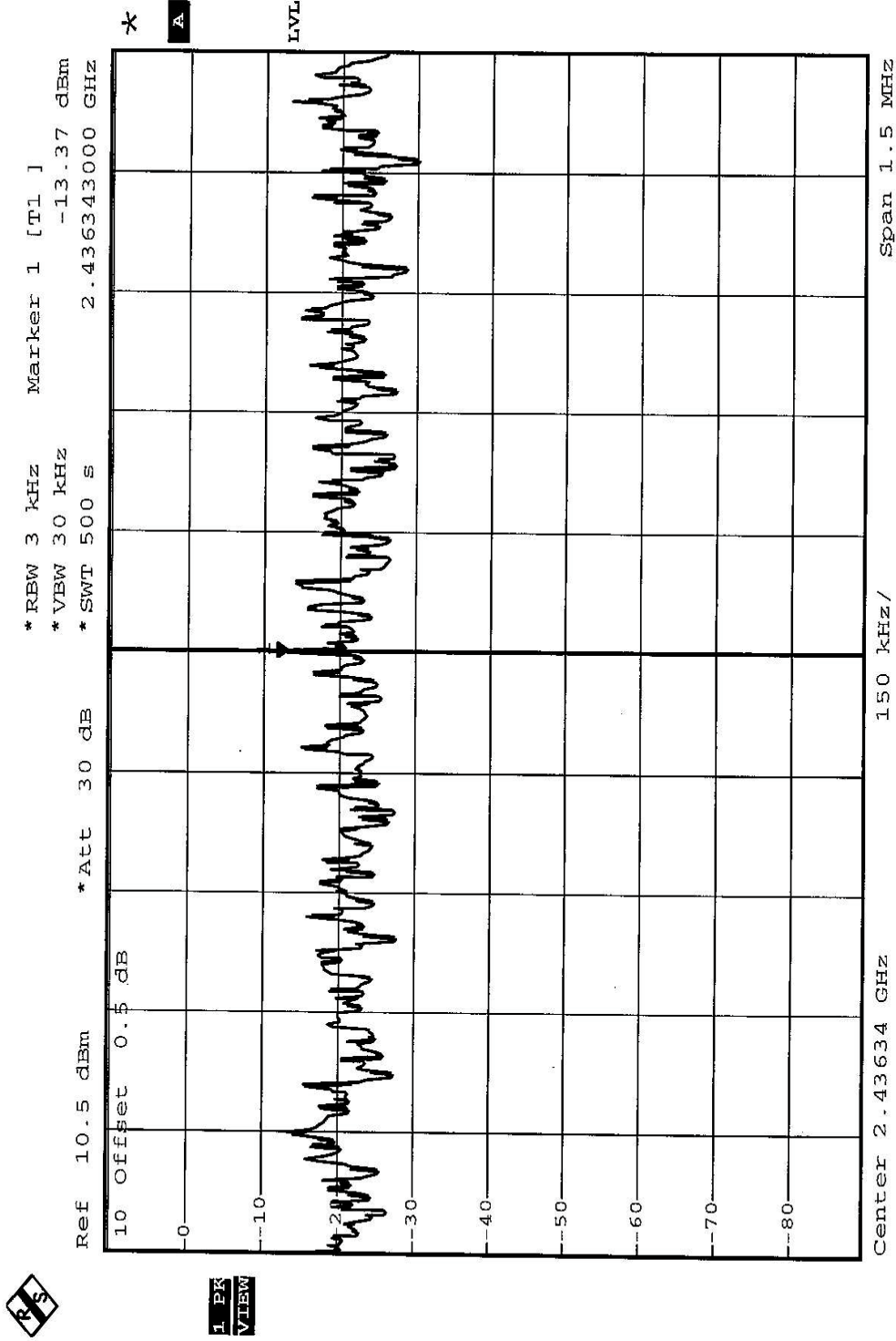

1 PK VIEW



CH11



1 PK VIEW

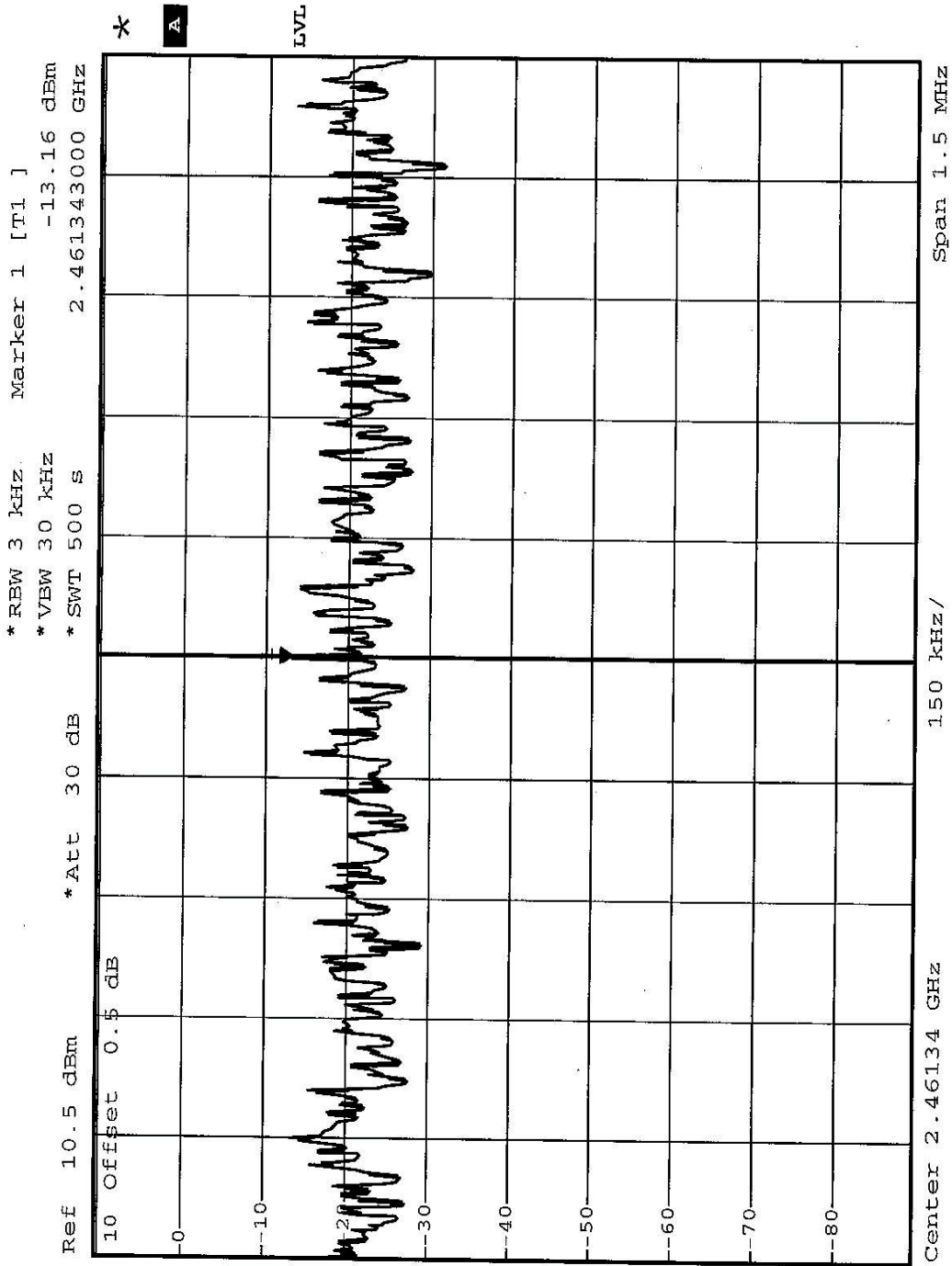



4.6 BAND EDGES MEASUREMENT

4.6.1 LIMITS OF BAND EDGES MEASUREMENT

Below -20dB of the highest emission level of operating band (in 100KHz Resolution Bandwidth).

4.6.2 TEST INSTRUMENTS

Description & Manufacturer	Model No.	Serial No.	Calibrated Until
SPECTRUM ANALYZER	FSEK30	100049	August 12, 2004

NOTE:

1. The calibration interval of the above test instruments is 12 months and the calibrations are traceable to NML/ROC and NIST/USA.

4.6.3 TEST PROCEDURE

The transmitter output was connected to the spectrum analyzer via a low lose cable. Set both RBW and VBW of spectrum analyzer to 100 kHz with suitable frequency span including 100 MHz bandwidth from band edge. The band edges was measured and recorded.

4.6.4 DEVIATION FROM TEST STANDARD

No deviation



4.6.5 EUT OPERATING CONDITION

Same as Item 4.3.6

4.6.6 TEST RESULTS

The spectrum plots are attached on the following 2 pages. D2 line indicates the highest level, D1 line indicates the 20dB offset below D2. It shows compliance with the requirement in part 15.247(C).

NOTE1: The band edge emission plot on the following 1-2 page shows 54.24dB / 55.58dB delta between carrier maximum power and local maximum emission in restrict band (2.3752GHz / 2.4988GHz). The emission of carrier strength list in the test result of channel 1 at the item 4.2.7 (page 26) is 95.6dBuV/m, so the maximum field strength in restrict band is $95.6 - 54.24 = 41.36$ dBuV/m which is under 54dBuV/m limit.

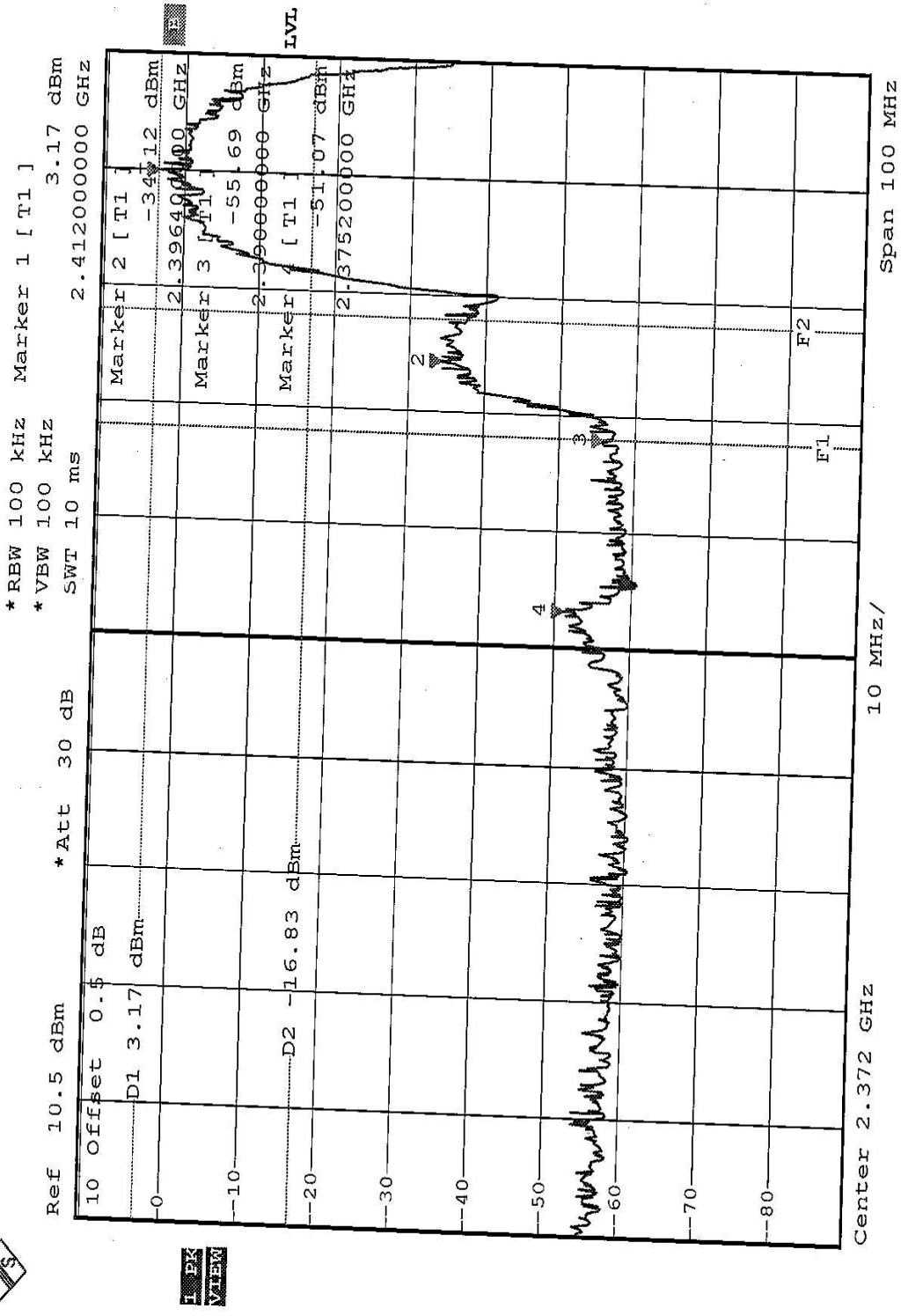

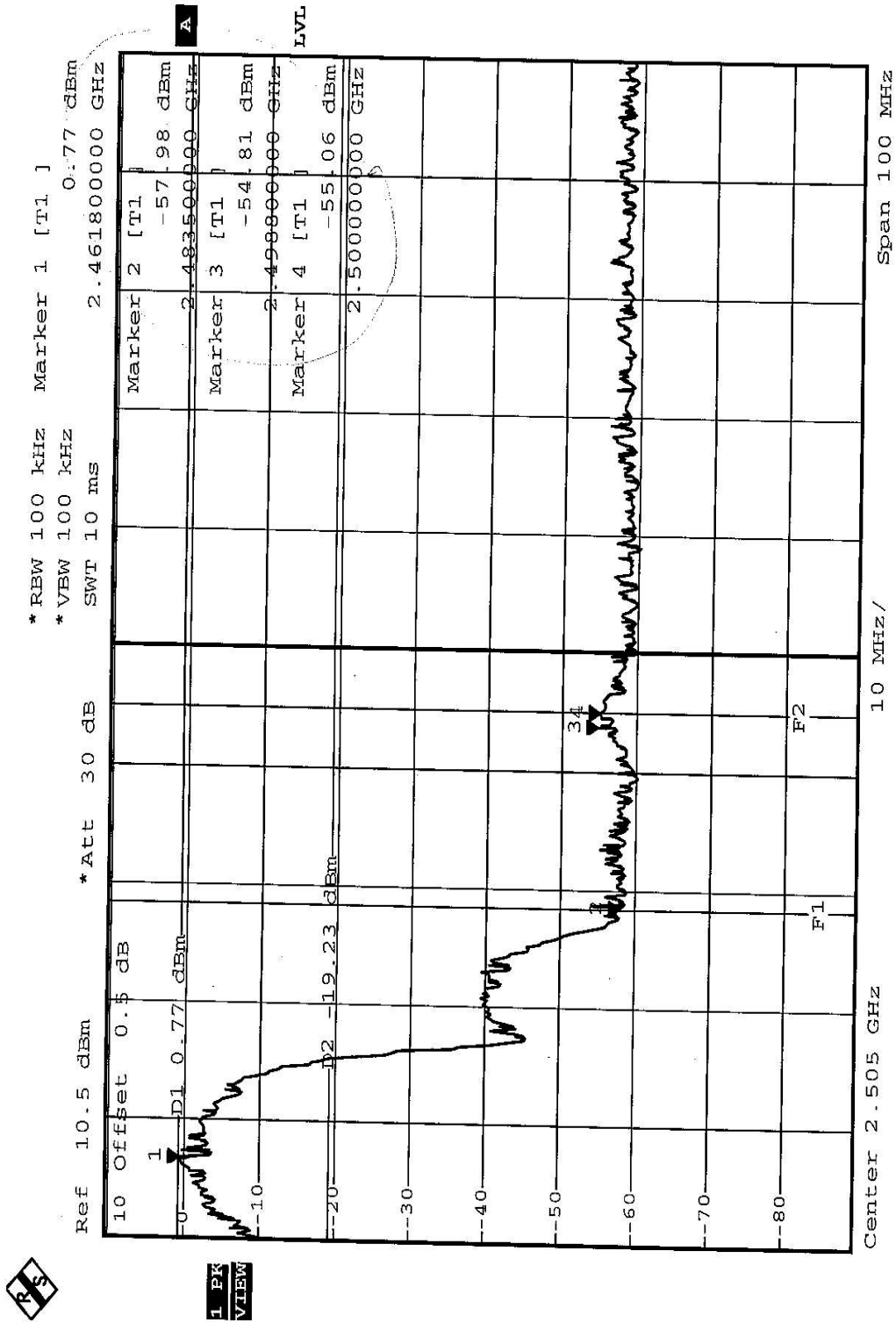



4.7 ANTENNA REQUIREMENT

4.7.1 STANDARD APPLICABLE

For intentional device, according to FCC 47 CFR Section 15.203, an intentional radiator shall be designed to ensure that no antenna other than that furnished by the responsible party shall be used with the device.

And according to FCC 47 CFR Section 15.247 (b), if transmitting antennas of directional gain greater than 6dBi are used, the power shall be reduced by the amount in dB that the directional gain of the antenna exceeds 6dBi.

4.7.2 ANTENNA CONNECTED CONSTRUCTION

The antenna used in this product is PIFA with UFL antenna connector. The maximum Gain of this antenna is -2dBi.

5 PHOTOGRAPHS OF THE TEST CONFIGURATION

CONDUCTED EMISSION TEST



RADIATED EMISSION TEST





6 INFORMATION ON THE TESTING LABORATORIES

We, ADT Corp., were founded in 1988 to provide our best service in EMC and Safety consultation. Our laboratories are accredited and approved by the following approval agencies according to ISO/IEC 17025, Guide 25 or EN 45001:

USA	FCC, NVLAP
Germany	TUV Rheinland
Japan	VCCI
New Zealand	MoC
Norway	NEMKO
R.O.C.	BSMI, DGT, CNLA

Copies of accreditation certificates of our laboratories obtained from approval agencies can be downloaded from our web site:

www.adt.com.tw/index.5/phtml.

If you have any comments, please feel free to contact us at the following:

Lin Kou EMC Lab:

Tel: 886-2-26052180

Fax: 886-2-26052943

Hsin Chu EMC Lab:

Tel: 886-35-935343

Fax: 886-35-935342

Lin Kou Safety Lab:

Tel: 886-2-26093195

Fax: 886-2-26093184

Lin Kou RF&Telecom Lab

Tel: 886-3-3270910

Fax: 886-3-3270892

Email: service@mail.adt.com.tw

Web Site: www.adt.com.tw

The address and road map of all our labs can be found in our web site also.